



RADIO TEST REPORT

Test Report No. : 10242191H

Applicant : Alps Electric Co., Ltd.
Type of Equipment : Switch Assy Immobilizer Antenna
Model No. : P74P0
Test regulation : FCC Part 15 Subpart C: 2014
FCC ID : CWTP74P0
Test Result : Complied

1. This test report shall not be reproduced in full or partial, without the written approval of UL Japan, Inc.
2. The results in this report apply only to the sample tested.
3. This sample tested is in compliance with above regulation.
4. The test results in this report are traceable to the national or international standards.
5. This test report must not be used by the customer to claim product certification, approval, or endorsement by NVLAP, NIST, or any agency of the Federal Government.

Date of test: April 7 and 8, 2014

Representative test engineer:



Keisuke Kawamura
Engineer
Consumer Technology Division

Approved by:



Masanori Nishiyama
Manager
Consumer Technology Division



NVLAP LAB CODE: 200572-0

This laboratory is accredited by the NVLAP LAB CODE 200572-0, U.S.A. The tests reported herein have been performed in accordance with its terms of accreditation.
*As for the range of Accreditation in NVLAP, you may refer to the WEB address,
<http://www.ul.com/japan/jpn/pages/services/emc/about/mark1/index.jsp#nvlap>

UL Japan, Inc.
Ise HQ EMC Lab.

4383-326 Asama-cho, Ise-shi, Mie-ken 516-0021 JAPAN
Telephone : +81 596 24 8999
Facsimile : +81 596 24 8124

13-EM-F0429

CONTENTS	PAGE
SECTION 1: Customer information	4
SECTION 2: Equipment under test (E.U.T.).....	4
SECTION 3: Test specification, procedures & results	5
SECTION 4: Operation of E.U.T. during testing	8
SECTION 5: Radiated emission (Fundamental and Spurious Emission)	9
APPENDIX 1: Data of EMI test.....	11
Radiated Emission below 30MHz (Fundamental and Spurious Emission)	11
Radiated Emission above 30MHz (Spurious Emission).....	12
-26dB Bandwidth and 99% Occupied Bandwidth	13
APPENDIX 2: Test instruments	14
APPENDIX 3: Photographs of test setup	15
Radiated Emission.....	15
Worst Case Position	16

UL Japan, Inc.

Ise HQ EMC Lab.

4383-326 Asama-cho, Ise-shi, Mie-ken 516-0021 JAPAN

Telephone : +81 596 24 8999

Facsimile : +81 596 24 8124

SECTION 1: Customer information

Company Name : Alps Electric Co., Ltd.
Address : 6-3-36, Nakazato, Furukawa, Osaki-city, Miyagi-pref, 989-6181, Japan
Telephone Number : +81-229-23-5111
Facsimile Number : +81-229-23-5129
Contact Person : Toru Kinoshita

SECTION 2: Equipment under test (E.U.T.)

2.1 Identification of E.U.T.

Type of Equipment : Switch Assy Immobilizer Antenna
Model No. : P74P0
Serial No. : Refer to Section 4, Clause 4.2
Receipt Date of Sample : April 3, 2014
Country of Mass-production : Japan
Condition of EUT : Engineering prototype
(Not for Sale: This sample is equivalent to mass-produced items.)
Modification of EUT : No Modification by the test lab

2.2 Product Description

Model No: P74P0 (referred to as the EUT in this report) is the Switch Assy Immobilizer Antenna.

General Specification

Clock frequency in the system : 8MHz

Radio Specification

Equipment Type : Transceiver
Frequency of operation : 125kHz
Type of modulation : ASK
Antenna Type : Loop Antenna
Method of Frequency Generation : Ceramic Resonator
Operating voltage (inner) : DC 12.0V
Operating Temperature : -40 to +85 deg. C

UL Japan, Inc.

Ise HQ EMC Lab.

4383-326 Asama-cho, Ise-shi, Mie-ken 516-0021 JAPAN

Telephone : +81 596 24 8999

Facsimile : +81 596 24 8124

SECTION 3: Test specification, procedures & results

3.1 Test Specification

Test Specification : FCC Part 15 Subpart C: 2014, final revised on March 6, 2014 and effective April 7, 2014

Title : FCC 47CFR Part15 Radio Frequency Device Subpart C Intentional Radiators
Section 15.207 Conducted Emission
Section 15.209 Radiated emission limits, general requirements

FCC 15.31 (e)

This test was performed with the New Battery (DC 12V) and the constant voltage was supplied to this EUT during the tests. Therefore, this EUT complies with the requirement.

FCC Part 15.203 Antenna requirement

It is impossible for end users to replace the antenna, because the antenna is mounted inside of the vehicle. Therefore, the equipment complies with the antenna requirement of Section 15.203.

3.2 Procedures and results

No.	Item	Test Procedure	Specification	Remarks	Deviation	Worst margin	Results
1	Conducted Emission	<FCC> ANSI C63.4:2003 7. AC powerline conducted emission measurements <IC> RSS-Gen 7.2.4	<FCC> Section 15.207 <IC> RSS-Gen 7.2.4	-	N/A *1)	N/A	N/A
2	Electric Field Strength of Fundamental Emission	<FCC> ANSI C63.4:2003 13. Measurement of intentional radiators <IC> RSS-Gen 4.8, 4.11	<FCC> Section 15.209 <IC> RSS-210 2.5.1 RSS-Gen 7.2.5	Radiated	N/A	20.2dB 0.12500MHz 0 deg. PK with Duty factor	Complied
3	Electric Field Strength of Spurious Emission	<FCC> ANSI C63.4:2003 13. Measurement of intentional radiators <IC> RSS-Gen 4.9, 4.11	<FCC> Section 15.209 <IC> RSS-210 2.5.1 RSS-Gen 7.2.5	Radiated	N/A	5.0dB 452.547MHz, Horizontal, QP	Complied
4	-26dB Bandwidth	<FCC> ANSI C63.4:2003 13. Measurement of intentional radiators <IC> -	<FCC> Reference data <IC> -	Radiated	N/A	N/A	N/A

Note: UL Japan, Inc.'s EMI Work Procedures No. 13-EM-W0420 and 13-EM-W0422.

*1) The test is not applicable since the EUT is not the device that is designed to be connected to the public utility (AC) power line.

UL Japan, Inc.

Ise HQ EMC Lab.

4383-326 Asama-cho, Ise-shi, Mie-ken 516-0021 JAPAN

Telephone : +81 596 24 8999

Facsimile : +81 596 24 8124

3.3 Addition to standard

Other than above, no addition, exclusion nor deviation has been made from the standard.

3.4 Uncertainty

EMI

The following uncertainties have been calculated to provide a confidence level of 95% using a coverage factor k=2.

Test room (semi-anechoic chamber)	Radiated emission						
	(3m*)(+dB)				(1m*)(+dB)		(0.5m*)(+dB)
	9kHz -30MHz	30MHz -300MHz	300MHz -1GHz	1GHz -10GHz	10GHz -18GHz	18GHz -26.5GHz	26.5GHz -40GHz
No.1	4.0dB	5.1dB	5.0dB	5.1dB	6.0dB	4.9dB	4.3dB
No.2	3.9dB	5.2dB	5.0dB	4.9dB	5.9dB	4.7dB	4.2dB
No.3	4.3dB	5.1dB	5.2dB	5.2dB	6.0dB	4.8dB	4.2dB
No.4	4.6dB	5.2dB	5.0dB	5.2dB	6.0dB	5.7dB	4.2dB

*3m/1m/0.5m = Measurement distance

Radiated emission test(3m)

The data listed in this test report has enough margin, more than the site margin.

UL Japan, Inc.

Ise HQ EMC Lab.

4383-326 Asama-cho, Ise-shi, Mie-ken 516-0021 JAPAN

Telephone : +81 596 24 8999

Facsimile : +81 596 24 8124

3.5 Test Location

UL Japan, Inc. Ise HQ EMC Lab. *NVLAP Lab. code: 200572-0

4383-326 Asama-cho, Ise-shi, Mie-ken 516-0021 JAPAN

Telephone : +81 596 24 8999

Facsimile : +81 596 24 8124

	FCC Registration Number	IC Registration Number	Width x Depth x Height (m)	Size of reference ground plane (m) / horizontal conducting plane	Other rooms
No.1 semi-anechoic chamber	313583	2973C-1	19.2 x 11.2 x 7.7m	7.0 x 6.0m	No.1 Power source room
No.2 semi-anechoic chamber	655103	2973C-2	7.5 x 5.8 x 5.2m	4.0 x 4.0m	-
No.3 semi-anechoic chamber	148738	2973C-3	12.0 x 8.5 x 5.9m	6.8 x 5.75m	No.3 Preparation room
No.3 shielded room	-	-	4.0 x 6.0 x 2.7m	N/A	-
No.4 semi-anechoic chamber	134570	2973C-4	12.0 x 8.5 x 5.9m	6.8 x 5.75m	No.4 Preparation room
No.4 shielded room	-	-	4.0 x 6.0 x 2.7m	N/A	-
No.5 semi-anechoic chamber	-	-	6.0 x 6.0 x 3.9m	6.0 x 6.0m	-
No.6 shielded room	-	-	4.0 x 4.5 x 2.7m	4.0 x 4.5 m	-
No.6 measurement room	-	-	4.75 x 5.4 x 3.0m	4.75 x 4.15 m	-
No.7 shielded room	-	-	4.7 x 7.5 x 2.7m	4.7 x 7.5m	-
No.8 measurement room	-	-	3.1 x 5.0 x 2.7m	N/A	-
No.9 measurement room	-	-	8.0 x 4.6 x 2.8m	2.4 x 2.4m	-
No.11 measurement room	-	-	6.2 x 4.7 x 3.0m	4.8 x 4.6m	-

* Size of vertical conducting plane (for Conducted Emission test) : 2.0 x 2.0m for No.1, No.2, No.3, and No.4 semi-anechoic chambers and No.3 and No.4 shielded rooms.

3.6 Data of EMI, Test instruments, and Test set up

Refer to APPENDIX.

UL Japan, Inc.

Ise HQ EMC Lab.

4383-326 Asama-cho, Ise-shi, Mie-ken 516-0021 JAPAN

Telephone : +81 596 24 8999

Facsimile : +81 596 24 8124

SECTION 4: Operation of E.U.T. during testing

4.1 Operating Modes

Test mode	Remarks
Transmitting mode (Tx)	125kHz

Justification : The system was configured in typical fashion (as a customer would normally use it) for testing.

4.2 Configuration and peripherals

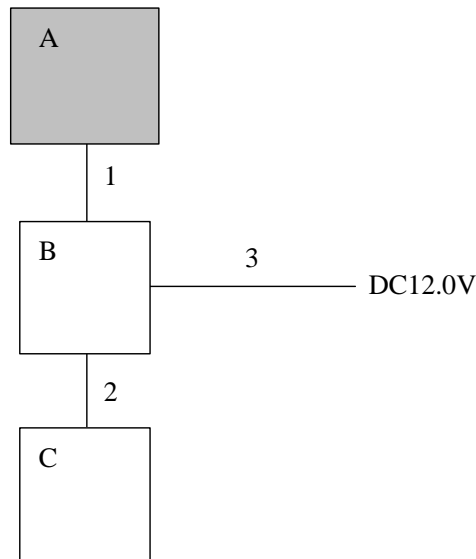

* Cabling and setup were taken into consideration and test data was taken under worse case conditions.

Description of EUT and Support equipment

No.	Item	Model number	Serial number	Manufacturer	Remarks
A	Switch Assy Immobilizer Antenna	P74P0	2014040201	Alps Electric Co., Ltd.	EUT
B	DC Jig Band	-	-	-	-
C	Jig Board	-	-	-	-

List of cables used

No.	Name	Length (m)	Shield		Remarks
			Cable	Connector	
1	Signal Cable	0.8	Unshielded	Unshielded	-
2	Signal Cable	0.3	Unshielded	Unshielded	-
3	DC Cable	2.0	Unshielded	Unshielded	-

UL Japan, Inc.

Ise HQ EMC Lab.

4383-326 Asama-cho, Ise-shi, Mie-ken 516-0021 JAPAN

Telephone : +81 596 24 8999

Facsimile : +81 596 24 8124

SECTION 5: Radiated emission (Fundamental and Spurious Emission)

Test Procedure

The Radiated Electric Field Strength intensity has been measured on No. 1 semi anechoic chamber with a ground plane and at a distance of 3m.

Frequency : From 9kHz to 30MHz at distance 3m

The EUT was rotated a full revolution in order to obtain the maximum value of the electric field intensity.

The measurements were performed for vertical polarization (antenna angle: 0deg., 45deg., 90deg., 135 deg., and 180 deg.) and horizontal polarization.

*Refer to Figure 1 about Direction of the Loop Antenna.

Frequency : From 30MHz to 1GHz at distance 3m

The measuring antenna height varied between 1 and 4m and EUT was rotated a full revolution in order to obtain the maximum value of the electric field intensity.

The measurements were performed for both vertical and horizontal antenna polarization.

Measurements were performed with a QP, PK, and AV detector.

The radiated emission measurements were made with the following detector function of the test receiver (below 1GHz).

	From 9kHz to 90kHz and From 110kHz to 150kHz	From 90kHz to 110kHz	From 150kHz to 490kHz	From 490kHz to 30MHz	From 30MHz to 1GHz
Detector Type	PK/AV	QP	PK/AV	QP	QP
IF Bandwidth	200Hz	200Hz	9kHz	9kHz	120kHz
Distance factor *1)	-80dB	-80dB	-80dB	-40dB	-

*1) -80dB = 40 x log (3m/300m)

-40dB = 40 x log (3m /30m)

- The carrier level was measured at each position of all three axes X, Y and Z, and the position that has the maximum noise was determined.

With the position, the noise levels of all the frequencies were measured.

Test data : APPENDIX 1

Test result : Pass

Date: April 7 and 8, 2014

Test engineer: Keisuke Kawamura

UL Japan, Inc.

Ise HQ EMC Lab.

4383-326 Asama-cho, Ise-shi, Mie-ken 516-0021 JAPAN

Telephone : +81 596 24 8999

Facsimile : +81 596 24 8124

Figure 1: Direction of the Loop Antenna

Side View (Vertical)

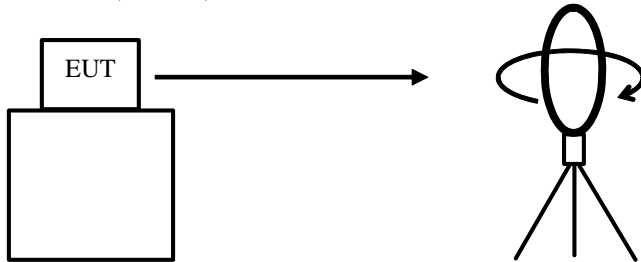

.....
Top View (Horizontal)

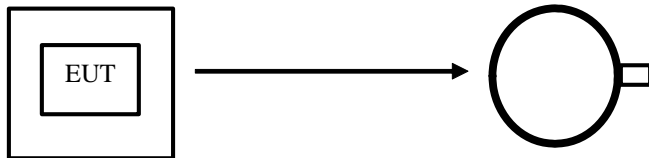

Antenna was not rotated.

.....
Top View (Vertical)

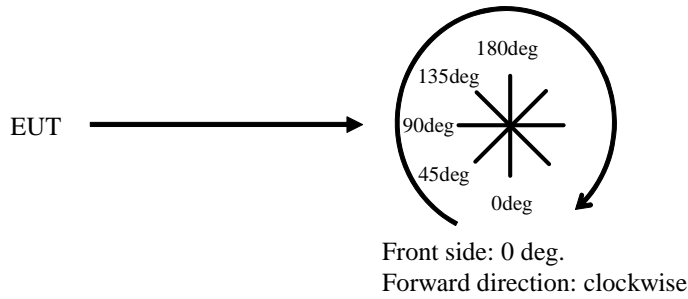

APPENDIX 1: Data of EMI test

Radiated Emission below 30MHz (Fundamental and Spurious Emission)

Test place Ise HQ EMC Lab. No.1 Measurement Room
Order No. 10242191H
Date 04/07/2014
Temperature/ Humidity 21 deg. C / 34% RH
Engineer Keisuke Kawamura
Mode Tx 125kHz

PK or QP

Ant Deg [deg] or Polarity [Hori/Vert]	Frequency [MHz]	Detector	Reading [dBuV]	Ant Factor [dB/m]	Loss [dB]	Gain [dB]	Duty Factor [dB]	Result [dBuV/m]	Limit [dBuV/m]	Margin [dB]	Remark
0	0.12500	PK	91.6	20.0	-74.0	32.2	-	5.4	45.6	40.2	Fundamental
0	0.25000	PK	53.2	19.9	-73.9	32.1	-	-32.9	39.6	72.5	
0	0.37500	PK	53.6	19.8	-73.9	32.1	-	-32.6	36.1	68.7	
0	0.50000	QP	34.2	19.8	-33.9	32.1	-	-12.0	33.6	45.6	
0	0.62500	QP	39.5	19.8	-33.8	32.1	-	-6.6	31.7	38.3	
0	0.75000	QP	31.8	19.8	-33.8	32.1	-	-14.3	30.1	44.4	
0	0.87500	QP	33.2	19.8	-33.8	32.1	-	-12.9	28.7	41.6	
0	1.00000	QP	31.2	19.8	-33.8	32.1	-	-14.9	27.6	42.5	
0	1.12500	QP	31.1	19.8	-33.8	32.1	-	-15.0	26.5	41.5	
0	1.25000	QP	30.8	19.8	-33.7	32.1	-	-15.2	25.6	40.8	

Result = Reading + Ant Factor + Loss (Cable+Attenuator+Filter+D.Factor) - Gain(Amplifier)

AV (PK with Duty factor)

Ant Deg [deg]	Frequency [MHz]	Detector	Reading [dBuV]	Ant Factor [dB/m]	Loss [dB]	Gain [dB]	Duty Factor [dB]	Result [dBuV/m]	Limit [dBuV/m]	Margin [dB]	Remark
0	0.12500	PK	91.6	20.0	-74.0	32.2	0.0	5.4	25.6	20.2	Fundamental
0	0.25000	PK	53.2	19.9	-73.9	32.1	0.0	-32.9	19.6	52.5	
0	0.37500	PK	53.6	19.8	-73.9	32.1	0.0	-32.6	16.1	48.7	

Result = Reading + Ant Factor + Loss (Cable+Attenuator+Filter+D.Factor) - Gain(Amplifier) + Duty factor *

* Since the peak emission result satisfied the average limit, duty factor was omitted.

Although Duty of this product was 100% or less, the result of AV (PK with Duty factor) was calculated by applying Duty 100% as worst.

Result of the fundamental emission at 3m without Distance factor

PK or QP

Ant Deg [deg]	Frequency [MHz]	Detector	Reading [dBuV]	Ant Factor [dB/m]	Loss [dB]	Gain [dB]	Duty Factor [dB]	Result [dBuV/m]	Limit [dBuV/m]	Margin [dB]	Remark
0	0.12500	PK	91.6	20.0	6.0	32.2	-	85.4	-	-	Fundamental

Result = Reading + Ant Factor + Loss (Cable+Attenuator+Filter) - Gain(Amplifier)

* All spurious emissions lower than this result.

* The pre amplifier used for carrier frequency measurement was not saturated.

UL Japan, Inc.

Ise HQ EMC Lab.

4383-326 Asama-cho, Ise-shi, Mie-ken 516-0021 JAPAN

Telephone : +81 596 24 8999

Facsimile : +81 596 24 8124

Radiated Emission above 30MHz (Spurious Emission)

DATA OF RADIATED EMISSION TEST

UL Japan, Inc. Ise HQ EMC Lab. No.1 Semi Anechoic Chamber
Date : 2014/04/07

Report No. : 10242191H
Temp./Humi. : 21deg. C / 34% RH
Engineer : Keisuke Kawamura

Mode / Remarks : Tx 125kHz Worst-Axis(Hori:X / Vert:X)

LIMIT : FCC15.209 3m, below 1GHz:QP, above 1GHz:PK
All other spurious emissions were less than 20dB for the limit.

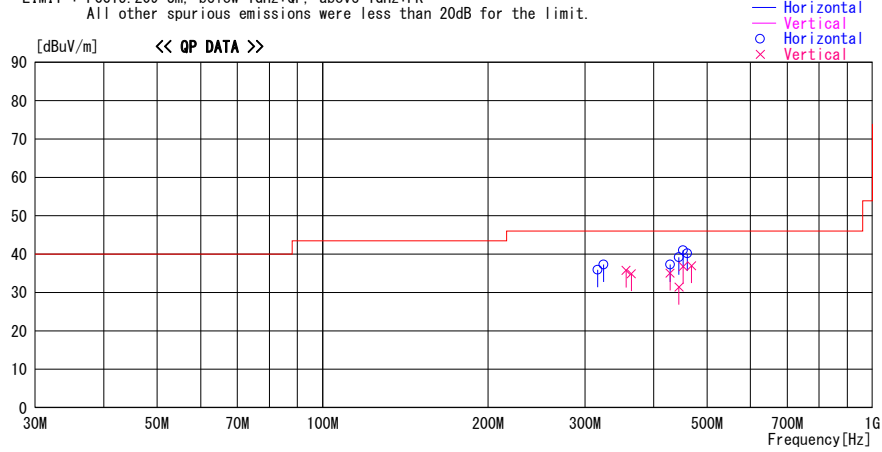

Frequency [MHz]	Reading [dBuV]	DET	Antenna		Level [dBuV/m]	Angle [Deg]	Height [cm]	Polar.	Limit [dBuV/m]	Margin [dB]	Comment
			Factor [dB/m]	Loss&Gain [dB]							
316.381	49.0	QP	14.8	-27.9	35.9	335	100	Hori.	46.0	10.1	
324.393	50.1	QP	15.1	-27.9	37.3	325	100	Hori.	46.0	8.7	
356.430	47.3	QP	16.0	-27.5	35.8	228	100	Vert.	46.0	10.2	
364.441	46.2	QP	16.2	-27.5	34.9	229	118	Vert.	46.0	11.1	
428.519	44.4	QP	17.5	-26.8	35.1	249	100	Vert.	46.0	10.9	
428.519	46.6	QP	17.5	-26.8	37.3	88	217	Hori.	46.0	8.7	
444.538	48.3	QP	17.6	-26.7	39.2	98	199	Hori.	46.0	6.8	
444.538	40.5	QP	17.6	-26.7	31.4	247	100	Vert.	46.0	14.6	
452.547	50.0	QP	17.7	-26.7	41.0	107	199	Hori.	46.0	5.0	
452.547	45.8	QP	17.7	-26.7	36.8	223	100	Vert.	46.0	9.2	
460.559	49.0	QP	17.8	-26.6	40.2	79	194	Hori.	46.0	5.8	
468.567	45.7	QP	17.8	-26.5	37.0	322	118	Vert.	46.0	9.0	

CHART:WITH FACTOR ANT TYPE: -30MHz:LOOP, 30-300MHz:BICONICAL, 300MHz-1000MHz:LOGPERIODIC, 1000MHz--:HORN
CALCULATION:RESULT = READING + ANT FACTOR + LOSS(CABLE+FILTER) - GAIN(AMP)

*The test result is rounded off to one or two decimal places, so some differences might be observed.

-26dB Bandwidth and 99% Occupied Bandwidth

Report No. 10242191H
 Test place Ise HQ EMC Lab.
 Semi Anechoic Chamber No.1
 Date 04/08/2014
 Temperature / Humidity 22 deg. C / 38 % RH
 Engineer Keisuke Kawamura
 Mode Tx 125 kHz

-26dB Bandwidth [kHz]	99% Occupied Bandwidth [kHz]
26.629	28.903

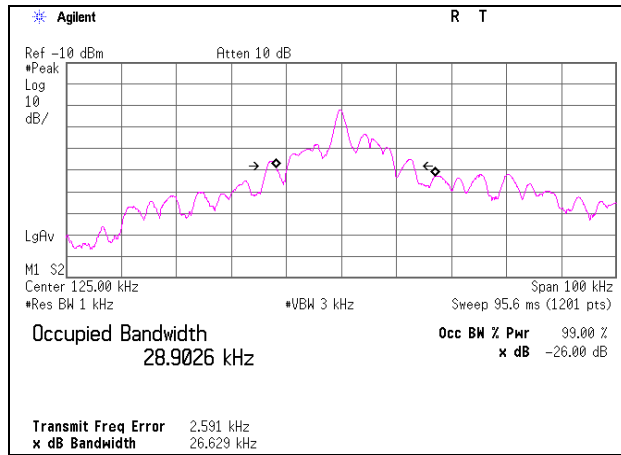

APPENDIX 2: Test instruments

EMI test equipment

Control No.	Instrument	Manufacturer	Model No	Serial No	Test Item	Calibration Date * Interval(month)
MAEC-01	Semi Anechoic Chamber(NSA)	TDK	Semi Anechoic Chamber 10m	DA-06881	RE	2013/08/01 * 12
MOS-27	Thermo-Hygrometer	CUSTOM	CTH-201	A08Q26	RE	2014/02/20 * 12
MJM-21	Measure	KOMELON	KMC-36	-	RE	-
COTS-MEMI	EMI measurement program	TSJ	TEPTO-DV	-	RE	-
MTR-09	EMI Test Receiver	Rohde & Schwarz	ESU26	100412	RE	2013/06/07 * 12
KBA-05	Biconical Antenna	Schwarzbeck	BBA9106	2513	RE	2013/11/24 * 12
KLA-04	Logperiodic Antenna	Schwarzbeck	USLP9143	361	RE	2013/11/24 * 12
MAT-08	Attenuator(6dB)	Weinschel Corp	2	BK7971	RE	2013/11/26 * 12
MCC-02	Coaxial Cable	Suhner/storm/Agilent/ TSJ	-	-	RE	2013/09/12 * 12
MPA-19	Pre Amplifier	MITEQ	MLA-10K01-B01-35	1237616	RE	2014/02/17 * 12
MLPA-01	Loop Antenna	Rohde & Schwarz	HFH2-Z2	100017	RE	2013/10/30 * 12
MCC-143	Coaxial Cable	UL Japan	-	-	RE	2013/07/22 * 12
MCC-03	Coaxial Cable	Fujikura/Suhner/TSJ	5D-2W(20m)/ 3D-2W(7.5m)/ RG400u(1.5m)/ RFM-E421(Switcher)	- /01068(Switcher)	RE	2013/09/12 * 12
MPA-14	Pre Amplifier	SONOMA INSTRUMENT	310	260833	RE	2014/03/14 * 12

The expiration date of the calibration is the end of the expired month.

All equipment is calibrated with valid calibrations. Each measurement data is traceable to the national or international standards.

As for some calibrations performed after the tested dates, those test equipment have been controlled by means of an unbroken chains of calibrations.

Test Item:

RE: Spurious emission

UL Japan, Inc.

Ise HQ EMC Lab.

4383-326 Asama-cho, Ise-shi, Mie-ken 516-0021 JAPAN

Telephone : +81 596 24 8999

Facsimile : +81 596 24 8124