

JVC

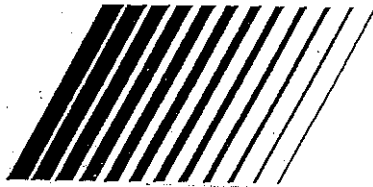

<Draft>

AUDIO/VIDEO CONTROL RECEIVER

RX-1028VBK

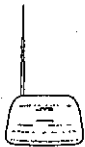

Command Center
CCJVCB00

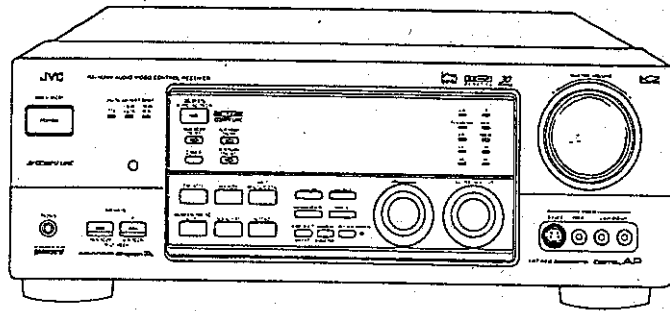
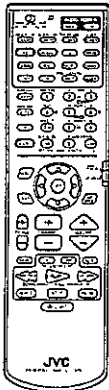

K2
INTERFACE

DIGITAL AP

ADVANCED SUPER-A

TEXT
COMPU LINK

AV COMPU LINK

COMPU LINK
Remote

3D
3D-PHONIC

DIGITAL
dts
SURROUND

DOLBY
DIGITAL

INSTRUCTIONS

For Customer Use:

Enter below the Model No. and Serial No. which are located either on the rear, bottom or side of the cabinet. Retain this information for future reference.

Model No. _____

Serial No. _____

LVT0180-001A

(J)

Warnings, Cautions and Others

CAUTION

RISK OF ELECTRIC SHOCK
DO NOT OPEN

CAUTION: TO REDUCE THE RISK OF ELECTRIC SHOCK, DO NOT REMOVE COVER (OR BACK). NO USER SERVICEABLE PARTS INSIDE. REFER SERVICING TO QUALIFIED SERVICE PERSONNEL.



The lightning flash with arrowhead symbol, within an equilateral triangle is intended to alert the user to the presence of uninsulated "dangerous voltage" within the product's enclosure that may be of sufficient magnitude to constitute a risk of electric shock to persons.



The exclamation point within an equilateral triangle is intended to alert the user to the presence of important operating and maintenance (servicing) instructions in the literature accompanying the appliance.

WARNING: TO REDUCE THE RISK OF FIRE OR ELECTRIC SHOCK, DO NOT EXPOSE THIS APPLIANCE TO RAIN OR MOISTURE.

CAUTION

To reduce the risk of electrical shocks, fire, etc.:

1. Do not remove screws, covers or cabinet.
2. Do not expose this appliance to rain or moisture.

Caution — POWER switch!

Disconnect the mains plug to shut the power off completely. The POWER switch in any position does not disconnect the mains line. The power can be remote controlled.

Caution — SPEAKER LOAD SELECTOR switch!

Match the position of SPEAKER LOAD SELECTOR switch on the back panel to the impedance of the speaker connected, to protect from overheating.

For the main unit:

This equipment has been tested and found to comply with the limits for a Class B digital device, pursuant to part 15 of the FCC Rules. These limits are designed to provide reasonable protection against harmful interference in a residential installation.

This equipment generates, uses and can radiate radio frequency energy and, if not installed and used in accordance with the instructions, may cause harmful interference to radio communications. However, there is no guarantee that interference will not occur in a particular installation. If this equipment does cause harmful interference to radio or television reception, which can be determined by turning the equipment off and on, the user is encouraged to try to correct the interference by one or more of the following measures:

- Reorient or relocate the receiving antenna.
- Increase the separation between the equipment and receiver.
- Connect the equipment into an outlet on a circuit different from that to which the receiver is connected.
- Consult the dealer or an experienced radio/TV technician for help.

For the remote control:

This device complies with Part 15 of the FCC Rules. Operation is subject to the following two conditions: (1) This device may not cause harmful interference, and (2) this device must accept any interference received, including interference that may cause undesired operation.

Changes or modifications not expressly approved by the manufacturer for compliance could void the user's authority to operate the equipment.

Caution: Proper Ventilation

To avoid risk of electric shock and fire and to protect from damage.

Locate the apparatus as follows:

- Front: No obstructions open spacing.
- Sides: No obstructions in 10 cm from the sides.
- Top: No obstructions in 10 cm from the top.
- Back: No obstructions in 15 cm from the back
- Bottom: No obstructions, place on the level surface.

In addition, maintain the best possible air circulation as illustrated.

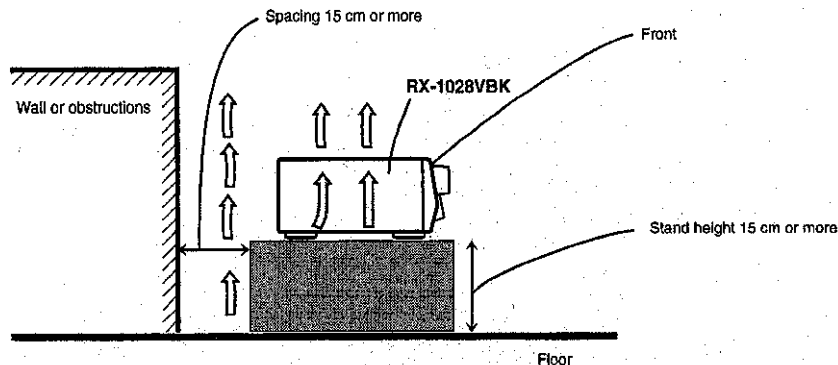



Table of Contents

Introduction	2	Receiving Radio Broadcasts	27
Features	2	Tuning in Stations Manually	27
Precautions	2	Using Preset Tuning	27
Parts Identification	3	Selecting the FM Reception Mode	28
Getting Started	4	Assigning Names to Preset Stations	28
Before Installation	4	Using the SEA Modes	29
Checking the Supplied Accessories	4	Selecting Your Favorite SEA Mode	29
Connecting the FM and AM Antennas	4	Creating Your Own SEA Mode	29
Connecting the Speakers	5	Using the DSP Modes	30
Connecting Audio/Video Components	6	Available DSP Modes According to the Speaker Configuration	32
Connecting the Power Cord	9	Adjusting the 3D-PHONIC Modes	33
Setting Up the Command Center	10	Adjusting the DAP Modes	33
Putting Batteries in the Remote Control	10	Adjusting the Surround Modes	34
Multi-room Operations	11	Activating the DSP Modes	37
Basic Operating Procedure for Main Room	13	Using the DVD MULTI Playback Mode	39
Basic Operating Procedure for Sub-Room	14	Activating the DVD MULTI Playback Mode	39
Main Room Basic Operations	15	Using the On-Screen Menus	41
Turning the Power On and Off (Standby)	15	Selecting the Main Room Source to Play	41
Canceling the Main Room Operations	15	Selecting Different Sources for Picture and Sound	41
Selecting the Main Room Source to Play	16	Activating the DSP Modes	41
Adjusting the Main Room Volume	17	Adjusting the Front Speaker Output Balance	42
Activating the Main Room Front Speakers	17	Listening at Low Volume (Loudness)	42
Muting the Main Room Sound	17	Attenuating the Input Signal	42
Listening at Low Volume (Loudness)	17	Adjusting the Subwoofer Output Level	42
Attenuating the Input Signal	17	Adjusting the DSP Modes	42
Adjusting the Subwoofer Output Level	18	Activating the DVD MULTI Playback Mode	43
Adjusting the Front Speaker Output Balance	18	Selecting Your Favorite SEA Mode	43
Using the Sleep Timer	18	Creating Your Own SEA Mode	44
Changing the Display Brightness	18	Setting the Basic Setting Items	44
Recording a Source	18	Operating the Tuner	44
Sub-Room Operations	19	Storing the Preset Stations	45
Turning the Power On and Off (Standby) and Selecting		Assigning Names to Preset Stations	45
the Sub-room Operations	19	COMPU LINK Remote Control System	46
Canceling the Sub-room Operations	20	TEXT COMPU LINK Remote Control System ..	48
Selecting the Sub-room Source to Play	20	Showing the Disc Information on the TV Screen	49
Adjusting the Sub-room Volume	21	Searching for a Disc (Only for the CD player)	50
Activating the Sub-room Front Speakers	21	Entering the Disc Information	51
Muting the Sub-room Sound	21	AV COMPU LINK Remote Control System ...	53
Operating the Playback Source for the Sub-room	21	Operating JVC's Audio/Video Components ...	56
Basic Settings	22	Operating Other Manufacturers' Video	
Changing the Source Name	22	Equipment	59
Setting the Subwoofer Information	22	Troubleshooting	65
Digital Input (DIGITAL IN) Terminal Setting	22	Specifications	67
Selecting the Analog or Digital Input Mode	23		
Showing the Text Information on the Display	24		
Setting the Front Speakers Either for the Main Room			
or Sub-room	24		
Setting the Speakers for the DSP Modes	24		
Storing the Basic Settings and Adjustments — One Touch			
Operation	26		

 Indicates the functions YOU CAN ALSO USE when the receiver is ready for the sub-room operations.

Introduction

We would like to thank you for purchasing one of our JVC products. Before operating this unit, read this manual carefully and thoroughly to obtain the best possible performance from your unit, and retain this manual for future reference.

Features

Main Functions

- **Dolby Digital Decoder Incorporated**
You can enjoy Dolby Digital, one of the most advanced home theater sound systems available. Dolby Digital, with five full-range channels and a subwoofer channel, lets you enjoy the most spectacular theater sound at home when you view movies on DVD.
- **Compatible with DTS Digital Surround**
The RX-1028VBK is compatible with DTS Digital Surround as well. DTS Digital Surround is the latest digital movie soundtrack format that delivers 5.1-channel audio like Dolby Digital. Using a low audio-data compression rate, it features natural, solid and clear sound.
- **Multi Room Operations**
You can connect two pairs of the front speakers to the RX-1028VBK, and use them to listen to different sources in the different rooms (Main room and Sub-room) at the same time.
- **Command Center and RF/IR Illuminated Multi-brand Remote Control**
The remote control sends out not only IR (infrared) but also RF (radio frequency) signals as coded commands to control the receiver. The Command Center and the remote control provided with this receiver allows you to control the receiver. The Command Center can receive the RF (Radio Frequency) signals sent from the remote control, then send them to the receiver after converting the signals to IR signals.
 - The remote control provided with this receiver can transmit control signals for many manufacturers' video components.
- **COMPU LINK Remote Control System**
The COMPU LINK remote control system allows you to operate other JVC audio components from this receiver.
- **TEXT COMPU LINK Remote Control System**
The TEXT COMPU LINK remote control system has been newly developed to deal with the disc information recorded in the CD Text and MDs. Using these information in the discs, you can operate the CD player or MD recorder through the receiver.
- **AV COMPU LINK Remote Control System**
The AV COMPU LINK remote control system allows you to operate other JVC video components from this receiver.

Main Technologies

- **K2 Interface**
K2 Interface eliminates jitter and ripples, achieving a drastic reduction in digital distortion. You can obtain a natural sound field from stereo and 5.1 channel sources.
- **Advanced Super-A**
Super-A is JVC's exclusive technology which combines the silky, distortion-free sound of a class-A amplifier and the robust efficiency of a class-B amplifier. Now this technology has been upgraded to Advanced Super-A. A newly added constant current circuit has replaced a device that used to distort load current waveforms. The result is an amplifier that is better able to control the speakers, bringing about a tremendous improvement in sound quality.

Precautions

Power sources

- When unplugging the receiver or the Command Center from the wall outlet, always pull the plug, not the AC power cord.
- Do not handle the AC power cord with wet hands.
- If you are not going to operate the receiver for an extended period of time, unplug the AC power cords of both the receiver and the Command Center from the wall outlets.

Multi-room operations

- Do not use the remote control outdoor or install the speakers outdoor.
- When operating the receiver from the place where you cannot see the receiver (for example, when controlling the receiver installed in the living room, from the kitchen), pay attention to the following not to surprise other people:
 - Be careful not to turn up the volume so high when controlling the receiver without listening to the playback sound.
 - Be careful not to surprise other people at a sudden sound coming out of the receiver when turning it on. (A sudden stop of the sound may also surprise other people.)
- If the receiver operates by itself or malfunctions, the following causes will be considered.
 - Interference to RF communication between the Command Center and the remote control from outside.
 - The remote control is used unintentionally. For example, a book is placed on the remote control, and therefore, depressing some buttons on the remote control.
- If your neighbor uses the same or similar RF remote control system, the Command Center may happen to receive the RF signals sent from such an RF remote control system, and operate the receiver unintentionally. If this happen, stop using the Command Center and the remote control, and consult your JVC dealer or the nearest JVC Service Center.

Others

- Should any metallic object or liquid fall into the unit, unplug the unit and consult your dealer before operating any further.
- Do not disassemble the unit since there are no user serviceable parts inside.

If anything goes wrong, unplug the AC power cord and consult your JVC dealer.

Parts Identification

Refer to the pages in parentheses for details.

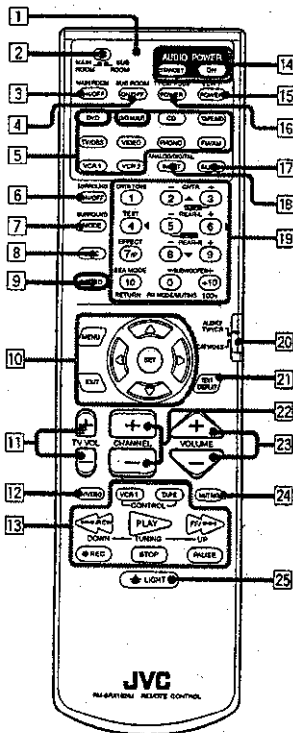
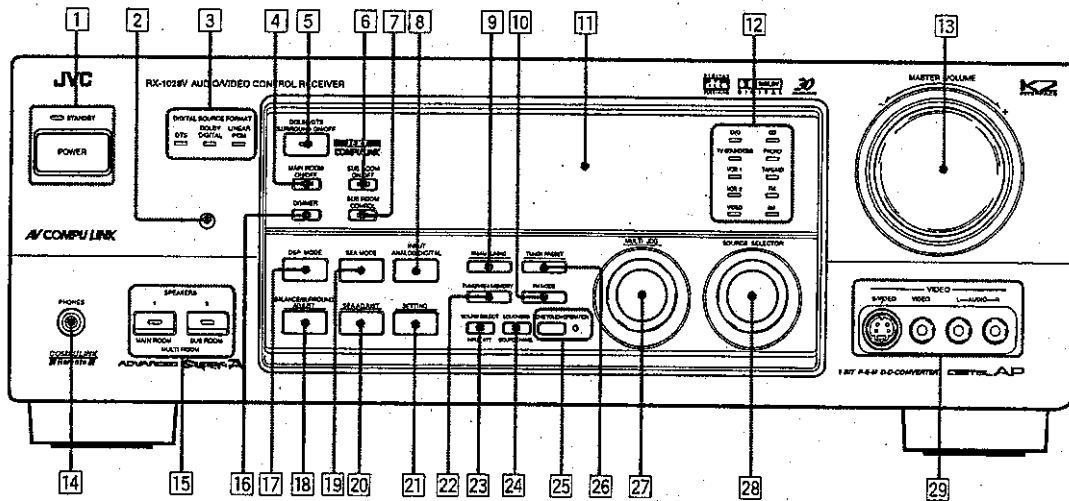

Remote Control

- 1 Remote operation lamp (10)
Lights when transmitting a control signal.
- 2 Main room/sub-room selector (15)
- 3 MAIN ROOM ON/OFF button (15)
- 4 SUB ROOM ON/OFF button (19)
- 5 Source selecting buttons (16, 20)
DVD, DVD MULTI, CD, TAPE/MD, TV/DBS, VIDEO, PHONO, FM/AM, VCR 1, VCR 2
- 6 SURROUND ON/OFF button (37)
- 7 SURROUND MODE button (32)
- 8 DISC button (57)
- 9 SOUND button (18, 29, 33)
- 10 On-screen operation buttons (41, 49)
MENU, SET, EXIT, Δ, ▽, ◀, ▶
- 11 TV VOL +/- buttons (58, 59)
- 12 TV/VIDEO button (58, 59)
- 13 Operating buttons for audio/video components (56 - 60)
- 14 AUDIO POWER buttons (15, 19)
STANDBY, ON
- 15 VCR 1 POWER button (58, 60)
- 16 TV/CATV/DBS POWER button (58 - 60)
- 17 SLEEP button (18)
- 18 ANALOG/DIGITAL INPUT button (23)
- 19 • 10 keys for selecting preset channels (58)
• 10 keys for adjusting sound (29, 33, 40)
• 10 keys for operating audio/video components (56 - 60)
- 20 Remote control mode selector (15, 56, 58)
- 21 TEXT DISPLAY button (49)
- 22 CHANNEL +/- button (58 - 60)
- 23 VOLUME +/- button (17, 21)
- 24 MUTING button (17, 21)
- 25 LIGHT button (10)

Front Panel

- 1 POWER button and STANDBY lamp (15, 19)
- 2 Remote sensor (10)
- 3 DIGITAL SOURCE FORMAT lamps (16)
DTS, DOLBY DIGITAL, LINEAR PCM
- 4 MAIN ROOM ON/OFF button and lamp (15)
- 5 DOLBY/DTS SURROUND ON/OFF button and lamp (35, 37)
- 6 SUB ROOM ON/OFF button and lamp (19)
- 7 SUB ROOM CONTROL button and lamp (19)
- 8 INPUT ANALOG/DIGITAL button (23)
- 9 FM/AM TUNING button (27) *
- 10 FM MODE button (28)
- 11 Display (16)
- 12 Source lamps (16)
- 13 MASTER VOLUME control (17, 21)
- 14 PHONES jack (17)
- 15 Front speaker buttons and lamps
• SPEAKERS 1, SPEAKERS 2 (17)
• MAIN ROOM, SUB ROOM (21)
- 16 DIMMER button (18)
- 17 DSP MODE button (32)
- 18 BALANCE/SURROUND ADJUST button (18, 33) *
- 19 SEA MODE button (29)
- 20 SEA ADJUST button (29) *
- 21 SETTING button (22 - 26) *
- 22 TUNER/SEA MEMORY button (27 - 29)
- 23 SOUND SELECT/INPUT ATT button (16, 17)
- 24 LOUDNESS/SOURCE NAME button (17, 22)
- 25 ONE TOUCH OPERATION button and lamp (26)
- 26 TUNER PRESET button (28) *
- 27 MULTI JOG control
What this control actually does depends on which function you are trying to adjust. Before using this control, select the function by pressing one of the buttons marked with *.
- 28 SOURCE SELECTOR control (16, 20)
- 29 VIDEO input jacks (8)

