

It will be indicate the mark by laser etching on outer case.

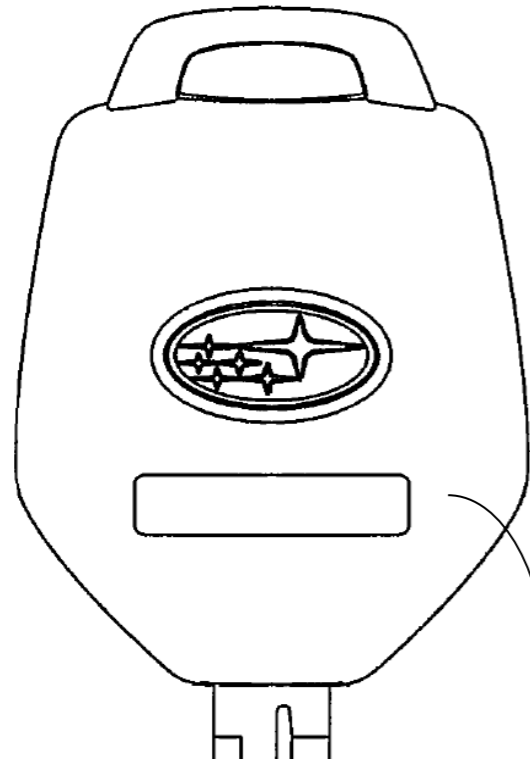

FCC ID : CWTB1G496
IC : 1788F-FB1G496
MODEL : TB1G496

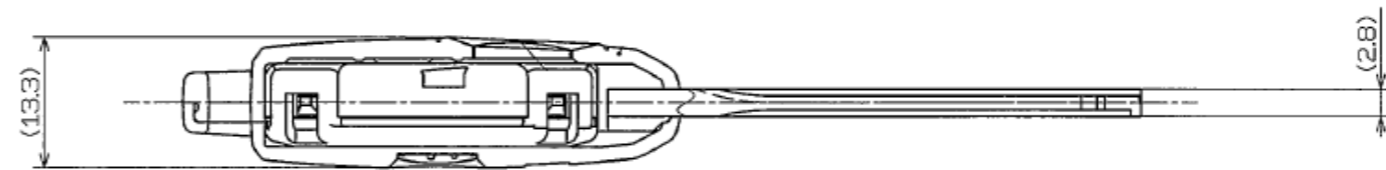
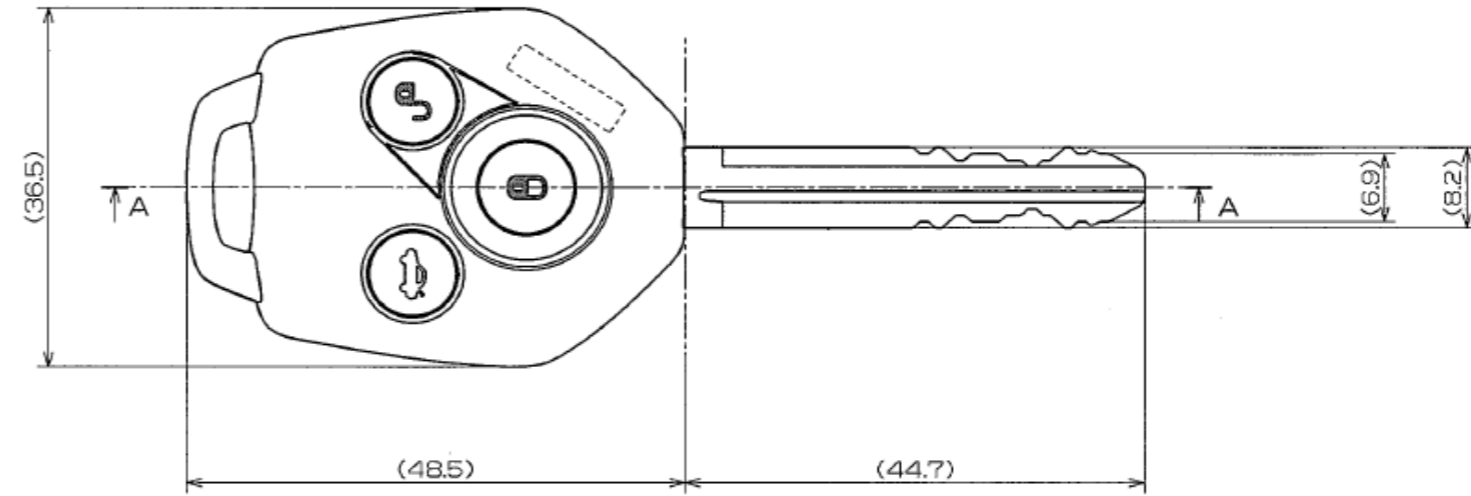

A-A