

SAR TEST REPORT

The following samples were submitted and identified on behalf of the client as:

| | |
|-----------------------------|---|
| Equipment Under Test | 7-inch Rugged Tablet |
| Brand Name | Pioneerpos |
| Model No. | DASH7E1 |
| Company Name | Pioneer POS Solution, Inc. |
| Company Address | 238 Benton Ct., City of Industry, CA 91789 |
| Standards | IEEE /ANSI C95.1 , C95.3, IEEE 1528 2003, KDB248227D01v02r01, KDB616217D04v01r01, KDB865664D01v01r03, KDB865664D02v01r01, KDB941225D01v03, KDB941225D05v02r03, KDB447498D01v05r02 |
| FCC ID | CPOD7E1-LTE |
| Date of Receipt | Apr. 01, 2015 |
| Date of Test(s) | Jun. 15, 2015 ~ Jun. 22, 2015 |
| Date of Issue | Aug. 04, 2015 |

In the configuration tested, the EUT complied with the standards specified above.

Remarks:

This report details the results of the testing carried out on one sample, the results contained in this test report do not relate to other samples of the same product. The manufacturer should ensure that all products in series production are in conformity with the product sample detailed in this report.

This report may only be reproduced and distributed in full. If the product in this report is used in any configuration other than that detailed in the report, the manufacturer must ensure the new system complies with all relevant standards. Any mention of SGS Taiwan Electronic & Communication Laboratory or testing done by SGS Taiwan Electronic & Communication Laboratory in connection with distribution or use of the product described in this report must be approved by SGS Taiwan Electronic & Communication Laboratory in writing.

Signed on behalf of SGS

Sr. Engineer

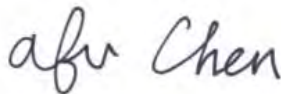

Afu Chen

Date: Aug. 04, 2015

Sr. Engineer

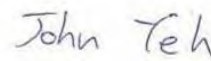

John Yeh

Date: Aug. 04, 2015

Unless otherwise stated the results shown in this test report refer only to the sample(s) tested and such sample(s) are retained for 90 days only.

除非另有說明，此報告結果僅對測試之樣品負責，同時此樣品僅保留90天。本報告未經本公司書面許可，不可部份複製。

This document is issued by the Company subject to its General Conditions of Service printed overleaf, available on request or accessible at www.sgs.com/terms_and_conditions.htm and, for electronic format documents, subject to Terms and Conditions for Electronic Documents at www.sgs.com/terms_e-document.htm. Attention is drawn to the limitation of liability, indemnification and jurisdiction issues defined therein. Any holder of this document is advised that information contained hereon reflects the Company's findings at the time of its intervention only and within the limits of Client's instructions, if any. The Company's sole responsibility is to its Client and this document does not exonerate parties to a transaction from exercising all their rights and obligations under the transaction documents. This document cannot be reproduced except in full, without prior written approval of the Company. Any unauthorized alteration, forgery or falsification of the content or appearance of this document is unlawful and offenders may be prosecuted to the fullest extent of the law.

Version

| Report Number | Revision | Date | Memo |
|---------------|----------|-----------|----------------------------------|
| EN/2015/40004 | 00 | 2015/7/20 | Initial creation of test report. |
| EN/2015/40004 | 01 | 2015/8/4 | 1 st modification |
| | | | |
| | | | |
| | | | |
| | | | |
| | | | |
| | | | |
| | | | |
| | | | |

This test report contains a reference to the previous version test report that it replaces.

Unless otherwise stated the results shown in this test report refer only to the sample(s) tested and such sample(s) are retained for 90 days only.

除非另有說明，此報告結果僅對測試之樣品負責，同時此樣品僅保留90天。本報告未經本公司書面許可，不可部份複製。

This document is issued by the Company subject to its General Conditions of Service printed overleaf, available on request or accessible at www.sgs.com/terms_and_conditions.htm and, for electronic format documents, subject to Terms and Conditions for Electronic Documents at www.sgs.com/terms_e-document.htm. Attention is drawn to the limitation of liability, indemnification and jurisdiction issues defined therein. Any holder of this document is advised that information contained hereon reflects the Company's findings at the time of its intervention only and within the limits of Client's instructions, if any. The Company's sole responsibility is to its Client and this document does not exonerate parties to a transaction from exercising all their rights and obligations under the transaction documents. This document cannot be reproduced except in full, without prior written approval of the Company. Any unauthorized alteration, forgery or falsification of the content or appearance of this document is unlawful and offenders may be prosecuted to the fullest extent of the law.

Contents

| | |
|---|-----|
| 1. General Information | 4 |
| 1.1 Testing Laboratory | 4 |
| 1.2 Details of Applicant | 4 |
| 1.3 Description of EUT | 5 |
| 1.4 Test Environment | 53 |
| 1.5 Operation Description..... | 53 |
| 1.6 The SAR Measurement System | 59 |
| 1.7 System Components | 61 |
| 1.8 SAR System Verification | 63 |
| 1.9 Tissue Simulant Fluid for the Frequency Band | 65 |
| 1.10 Evaluation Procedures | 68 |
| 1.11 Probe Calibration Procedures | 69 |
| 1.12 Test Standards and Limits..... | 72 |
| 2. Summary of Results | 74 |
| 3. Simultaneous Transmission Analysis..... | 94 |
| 3.1 Estimated SAR calculation..... | 95 |
| 3.2 SPLSR evaluation and analysis | 95 |
| 4. Instruments List | 182 |
| 5. Measurements | 183 |
| 6. SAR System Performance Verification..... | 213 |
| 7. DAE & Probe Calibration Certificate | 222 |
| 8. Uncertainty Budget..... | 238 |
| 9. Phantom Description | 239 |
| 10. System Validation from Original Equipment Supplier..... | 240 |

Unless otherwise stated the results shown in this test report refer only to the sample(s) tested and such sample(s) are retained for 90 days only.

除非另有說明，此報告結果僅對測試之樣品負責，同時此樣品僅保留90天。本報告未經本公司書面許可，不可部份複製。

This document is issued by the Company subject to its General Conditions of Service printed overleaf, available on request or accessible at www.sgs.com/terms_and_conditions.htm and, for electronic format documents, subject to Terms and Conditions for Electronic Documents at www.sgs.com/terms_e-document.htm. Attention is drawn to the limitation of liability, indemnification and jurisdiction issues defined therein. Any holder of this document is advised that information contained hereon reflects the Company's findings at the time of its intervention only and within the limits of Client's instructions, if any. The Company's sole responsibility is to its Client and this document does not exonerate parties to a transaction from exercising all their rights and obligations under the transaction documents. This document cannot be reproduced except in full, without prior written approval of the Company. Any unauthorized alteration, forgery or falsification of the content or appearance of this document is unlawful and offenders may be prosecuted to the fullest extent of the law.

1. General Information

1.1 Testing Laboratory

| | |
|--|---|
| SGS Taiwan Ltd. Electronics & Communication Laboratory | |
| No.134, Wu Kung Road, New Taipei Industrial Park, Wuku District, New Taipei City, Taiwan | |
| Tel | +886-2-2299-3279 |
| Fax | +886-2-2298-0488 |
| Internet | http://www.tw.sgs.com/ |

1.2 Details of Applicant

| | |
|-----------------|--|
| Company Name | Pioneer POS Solution, Inc. |
| Company Address | 238 Benton Ct., City of Industry, CA 91789 |

Unless otherwise stated the results shown in this test report refer only to the sample(s) tested and such sample(s) are retained for 90 days only.

除非另有說明，此報告結果僅對測試之樣品負責，同時此樣品僅保留90天。本報告未經本公司書面許可，不可部份複製。

This document is issued by the Company subject to its General Conditions of Service printed overleaf, available on request or accessible at www.sgs.com/terms_and_conditions.htm and, for electronic format documents, subject to Terms and Conditions for Electronic Documents at www.sgs.com/terms_e-document.htm. Attention is drawn to the limitation of liability, indemnification and jurisdiction issues defined therein. Any holder of this document is advised that information contained hereon reflects the Company's findings at the time of its intervention only and within the limits of Client's instructions, if any. The Company's sole responsibility is to its Client and this document does not exonerate parties to a transaction from exercising all their rights and obligations under the transaction documents. This document cannot be reproduced except in full, without prior written approval of the Company. Any unauthorized alteration, forgery or falsification of the content or appearance of this document is unlawful and offenders may be prosecuted to the fullest extent of the law.

1.3 Description of EUT

| | | |
|----------------------|---|---|
| Equipment Under Test | 7-inch Rugged Tablet | |
| Brand Name | Pioneerpos | |
| Model No. | DASH7E1 | |
| FCC ID | CPOD7E1-LTE | |
| Mode of Operation | <input checked="" type="checkbox"/> GPRS <input checked="" type="checkbox"/> EDGE <input checked="" type="checkbox"/> WCDMA <input checked="" type="checkbox"/> HSDPA <input checked="" type="checkbox"/> HSUPA <input checked="" type="checkbox"/> LTE <input checked="" type="checkbox"/> CDMA 1xRTT <input checked="" type="checkbox"/> CDMA 1x EVDO Rev.0/ Rev.A <input checked="" type="checkbox"/> WLAN802.11 a/b/g/n(20M/40M) <input checked="" type="checkbox"/> Bluetooth | |
| Duty Cycle | GPRS | 1/4.1 (1Dn2UP) 1/8.3 (1Dn1UP) |
| | EDGE | 1/2 (1Dn4UP) 1/2.76 (1Dn3UP) 1/4.1 (1Dn2UP) 1/8.3 (1Dn1UP) |
| | WCDMA | 1 |
| | LTE | 1 |
| | CDMA 1xRTT/ EVDO Rev.0/ Rev. A | 1 |
| | WLAN802.11 a/b/g/n(20M/40M) | 1 |
| | Bluetooth | 1 |

Unless otherwise stated the results shown in this test report refer only to the sample(s) tested and such sample(s) are retained for 90 days only.

除非另有說明，此報告結果僅對測試之樣品負責，同時此樣品僅保留90天。本報告未經本公司書面許可，不可部份複製。

This document is issued by the Company subject to its General Conditions of Service printed overleaf, available on request or accessible at www.sgs.com/terms_and_conditions.htm and, for electronic format documents, subject to Terms and Conditions for Electronic Documents at www.sgs.com/terms_e-document.htm. Attention is drawn to the limitation of liability, indemnification and jurisdiction issues defined therein. Any holder of this document is advised that information contained hereon reflects the Company's findings at the time of its intervention only and within the limits of Client's instructions, if any. The Company's sole responsibility is to its Client and this document does not exonerate parties to a transaction from exercising all their rights and obligations under the transaction documents. This document cannot be reproduced except in full, without prior written approval of the Company. Any unauthorized alteration, forgery or falsification of the content or appearance of this document is unlawful and offenders may be prosecuted to the fullest extent of the law.

| | | | | |
|--------------------------|-----------------------|---------|------|---------|
| TX Frequency Range (MHz) | GPRS850 | 824.2 | — | 848.8 |
| | GPRS1900 | 1850.2 | — | 1909.8 |
| | WCDMA Band II | 1852.4 | — | 1907.6 |
| | WCDMA Band IV | 1712.4 | — | 1752.6 |
| | WCDMA Band V | 826.4 | — | 846.6 |
| | LTE FDD Band II | 1850 | — | 1910 |
| | LTE FDD Band IV | 1710 | — | 1755 |
| | LTE FDD Band V | 824 | — | 849 |
| | LTE FDD Band XIII | 777 | — | 787 |
| | LTE FDD Band XVII | 704 | — | 716 |
| | LTE FDD Band XXV | 1850 | — | 1915 |
| | CDMA (BC0) | 824.7 | — | 848.31 |
| | CDMA (BC1) | 1851.25 | — | 1908.75 |
| | CDMA (BC10) | 817.9 | — | 823.1 |
| | WLAN802.11 b/g/n(20M) | 2412 | — | 2462 |
| | WLAN802.11 n(40M) | 2422 | — | 2452 |
| | WLAN802.11 a/n(20M) | 5180 | — | 5240 |
| | WLAN802.11 n(40M) | 5190 | — | 5230 |
| | WLAN802.11 a/n(20M) | 5260 | — | 5320 |
| | WLAN802.11 n(40M) | 5270 | — | 5310 |
| | WLAN802.11 a/n(20M) | 5500 | — | 5700 |
| | WLAN802.11 n(40M) | 5510 | — | 5670 |
| | WLAN802.11 a/n(20M) | 5745 | — | 5825 |
| WLAN802.11 n(40M) | 5710 | — | 5795 | |
| Bluetooth | 2402 | — | 2480 | |

Unless otherwise stated the results shown in this test report refer only to the sample(s) tested and such sample(s) are retained for 90 days only.

除非另有說明，此報告結果僅對測試之樣品負責，同時此樣品僅保留90天。本報告未經本公司書面許可，不可部份複製。

This document is issued by the Company subject to its General Conditions of Service printed overleaf, available on request or accessible at www.sgs.com/terms_and_conditions.htm and, for electronic format documents, subject to Terms and Conditions for Electronic Documents at www.sgs.com/terms_e-document.htm. Attention is drawn to the limitation of liability, indemnification and jurisdiction issues defined therein. Any holder of this document is advised that information contained hereon reflects the Company's findings at the time of its intervention only and within the limits of Client's instructions, if any. The Company's sole responsibility is to its Client and this document does not exonerate parties to a transaction from exercising all their rights and obligations under the transaction documents. This document cannot be reproduced except in full, without prior written approval of the Company. Any unauthorized alteration, forgery or falsification of the content or appearance of this document is unlawful and offenders may be prosecuted to the fullest extent of the law.

| | | | | |
|---------------------------|-----------------------|-------|-----|-------|
| Channel Number (ARFCN) | GPRS850 | 128 | — | 251 |
| | GPRS1900 | 512 | — | 810 |
| | WCDMA Band II | 9262 | — | 9538 |
| | WCDMA Band IV | 1312 | — | 1513 |
| | WCDMA Band V | 4132 | — | 4233 |
| | LTE FDD Band II | 18607 | — | 19193 |
| | LTE FDD Band IV | 19957 | — | 20393 |
| | LTE FDD Band V | 20407 | — | 20643 |
| | LTE FDD Band XIII | 23205 | — | 23255 |
| | LTE FDD Band XVII | 23755 | — | 23825 |
| | LTE FDD Band XXV | 26047 | — | 26683 |
| | CDMA (BC0) | 1013 | — | 777 |
| | CDMA (BC1) | 25 | — | 1175 |
| | CDMA (BC10) | 476 | — | 684 |
| | WLAN802.11 b/g/n(20M) | 1 | — | 11 |
| | WLAN802.11 n(40M) | 3 | — | 9 |
| | WLAN802.11 a/n(20M) | 36 | — | 48 |
| | WLAN802.11 n(40M) | 38 | — | 46 |
| | WLAN802.11 a/n(20M) | 52 | — | 64 |
| | WLAN802.11 n(40M) | 54 | — | 62 |
| | WLAN802.11 a/n(20M) | 100 | — | 140 |
| | WLAN802.11 n(40M) | 102 | — | 134 |
| | WLAN802.11 a/n(20M) | 149 | — | 165 |
| WLAN802.11 n(40M) | 142 | — | 159 | |
| Bluetooth | 0 | — | 78 | |

Unless otherwise stated the results shown in this test report refer only to the sample(s) tested and such sample(s) are retained for 90 days only.

除非另有說明，此報告結果僅對測試之樣品負責，同時此樣品僅保留90天。本報告未經本公司書面許可，不可部份複製。

This document is issued by the Company subject to its General Conditions of Service printed overleaf, available on request or accessible at www.sgs.com/terms_and_conditions.htm and, for electronic format documents, subject to Terms and Conditions for Electronic Documents at www.sgs.com/terms_e-document.htm. Attention is drawn to the limitation of liability, indemnification and jurisdiction issues defined therein. Any holder of this document is advised that information contained hereon reflects the Company's findings at the time of its intervention only and within the limits of Client's instructions, if any. The Company's sole responsibility is to its Client and this document does not exonerate parties to a transaction from exercising all their rights and obligations under the transaction documents. This document cannot be reproduced except in full, without prior written approval of the Company. Any unauthorized alteration, forgery or falsification of the content or appearance of this document is unlawful and offenders may be prosecuted to the fullest extent of the law.

| Max. SAR (1 g) (Unit: W/Kg) | | | | |
|-----------------------------|----------|----------|---------|-----------------|
| Band | Measured | Reported | Channel | Position |
| GPRS 850 | 0.991 | 0.991 | 251 | Left side |
| GRPS 1900 | 1.26 | 1.335 | 512 | Back side_Curve |
| WCDMA Band II | 1.160 | 1.160 | 9262 | Back side_Curve |
| WCDMA Band IV | 1.07 | 1.131 | 1513 | Back side_Curve |
| WCDMA Band V | 0.565 | 0.615 | 4183 | Left side |
| LTE FDD Band II | 0.983 | 1.090 | 19100 | Top side |
| LTE FDD Band IV | 1.150 | 1.193 | 20175 | Back side |
| LTE FDD Band V | 0.419 | 0.601 | 20600 | Left side |
| LTE FDD Band XIII | 0.583 | 0.837 | 23230 | Left side |
| LTE FDD Band XVII | 0.312 | 0.438 | 23780 | Left side |
| LTE FDD Band XXV | 1.140 | 1.159 | 26590 | Top side |
| CDMA (BC0) | 0.72 | 0.771 | 1013 | Left side |
| CDMA (BC1) | 1.00 | 1.009 | 1175 | Back side |
| CDMA (BC10) | 0.659 | 0.723 | 560 | Left side |

Unless otherwise stated the results shown in this test report refer only to the sample(s) tested and such sample(s) are retained for 90 days only.

除非另有說明，此報告結果僅對測試之樣品負責，同時此樣品僅保留90天。本報告未經本公司書面許可，不可部份複製。

This document is issued by the Company subject to its General Conditions of Service printed overleaf, available on request or accessible at www.sgs.com/terms_and_conditions.htm and, for electronic format documents, subject to Terms and Conditions for Electronic Documents at www.sgs.com/terms_e-document.htm. Attention is drawn to the limitation of liability, indemnification and jurisdiction issues defined therein. Any holder of this document is advised that information contained hereon reflects the Company's findings at the time of its intervention only and within the limits of Client's instructions, if any. The Company's sole responsibility is to its Client and this document does not exonerate parties to a transaction from exercising all their rights and obligations under the transaction documents. This document cannot be reproduced except in full, without prior written approval of the Company. Any unauthorized alteration, forgery or falsification of the content or appearance of this document is unlawful and offenders may be prosecuted to the fullest extent of the law.

| Max. SAR (1 g) (Unit: W/Kg) | | | | | |
|-----------------------------|------------------------|----------|----------|---------|------------|
| Antenna | Band | Measured | Reported | Channel | Position |
| Main | WLAN802.11 b | 0.825 | 1.010 | 11 | Right side |
| | WLAN802.11 a 5.2G | 0.383 | 0.441 | 40 | Right side |
| | WLAN802.11 n(40M) 5.2G | 0.303 | 0.372 | 46 | Right side |
| | WLAN802.11 n(20M) 5.3G | 0.261 | 0.303 | 60 | Right side |
| | WLAN802.11 n(40M) 5.3G | 0.27 | 0.319 | 54 | Right side |
| | WLAN802.11 n(20M) 5.6G | 0.276 | 0.327 | 104 | Right side |
| | WLAN802.11 n(20M) 5.6G | 0.313 | 0.372 | 120 | Right side |
| | WLAN802.11 n(20M) 5.6G | 0.324 | 0.401 | 140 | Right side |
| | WLAN802.11 n(40M) 5.8G | 0.349 | 0.513 | 159 | Right side |
| Aux | WLAN802.11 b | 0.83 | 0.842 | 6 | Top side |
| | WLAN802.11 a 5.2G | 0.792 | 0.928 | 36 | Top side |
| | WLAN802.11 n(40M) 5.2G | 0.775 | 0.810 | 46 | Top side |
| | WLAN802.11 n(20M) 5.3G | 0.69 | 0.855 | 60 | Top side |
| | WLAN802.11 n(40M) 5.3G | 0.793 | 0.919 | 54 | Top side |
| | WLAN802.11 n(20M) 5.6G | 0.654 | 0.821 | 120 | Top side |
| | WLAN802.11 n(40M) 5.8G | 0.586 | 0.877 | 159 | Top side |

Unless otherwise stated the results shown in this test report refer only to the sample(s) tested and such sample(s) are retained for 90 days only.

除非另有說明，此報告結果僅對測試之樣品負責，同時此樣品僅保留90天。本報告未經本公司書面許可，不可部份複製。

This document is issued by the Company subject to its General Conditions of Service printed overleaf, available on request or accessible at www.sgs.com/terms_and_conditions.htm and, for electronic format documents, subject to Terms and Conditions for Electronic Documents at www.sgs.com/terms_e-document.htm. Attention is drawn to the limitation of liability, indemnification and jurisdiction issues defined therein. Any holder of this document is advised that information contained hereon reflects the Company's findings at the time of its intervention only and within the limits of Client's instructions, if any. The Company's sole responsibility is to its Client and this document does not exonerate parties to a transaction from exercising all their rights and obligations under the transaction documents. This document cannot be reproduced except in full, without prior written approval of the Company. Any unauthorized alteration, forgery or falsification of the content or appearance of this document is unlawful and offenders may be prosecuted to the fullest extent of the law.

GPRS/EDGE conducted power table:

| Burst average power | | | | |
|--|-----------------|----------------|----------------|------------|
| Max. Rated Avg. Power + Max. Tolerance (dBm) | | 33 | 30.8 | |
| | | 1Dn1UP | 1Dn2UP | |
| EUT mode | Frequency (MHz) | CH | Avg. (dBm) | Avg. (dBm) |
| GPRS 850 | 824.2 | 128 | 31.70 | 30.78 |
| | 836.6 | 190 | 31.70 | 30.74 |
| | 848.8 | 251 | 32.10 | 30.80 |
| Source-based time average power | | | | |
| GPRS 850 | 824.2 | 128 | 22.67 | 24.76 |
| | 836.6 | 190 | 22.67 | 24.72 |
| | 848.8 | 251 | 23.07 | 24.78 |
| The division factor compared to the number of TX time slot | | | | |
| Division factor | | 1 TX time slot | 2 TX time slot | |
| | | -9.03 | -6.02 | |

| Burst average power | | | | | | |
|--|-----------------|----------------|----------------|----------------|----------------|------------|
| Max. Rated Avg. Power + Max. Tolerance (dBm) | | 28 | 28 | 28 | 28 | |
| | | 1Dn1UP | 1Dn2UP | 1Dn3UP | 1Dn4UP | |
| EUT mode | Frequency (MHz) | CH | Avg. (dBm) | Avg. (dBm) | Avg. (dBm) | Avg. (dBm) |
| EDGE 850 (MCS5) | 824.2 | 128 | 26.50 | 26.30 | 26.20 | 26.20 |
| | 836.6 | 190 | 26.50 | 26.30 | 26.20 | 26.20 |
| | 848.8 | 251 | 26.50 | 26.30 | 26.20 | 26.20 |
| Source-based time average power | | | | | | |
| EDGE 850 (MCS5) | 824.2 | 128 | 17.47 | 20.28 | 21.94 | 23.19 |
| | 836.6 | 190 | 17.47 | 20.28 | 21.94 | 23.19 |
| | 848.8 | 251 | 17.47 | 20.28 | 21.94 | 23.19 |
| The division factor compared to the number of TX time slot | | | | | | |
| Division factor | | 1 TX time slot | 2 TX time slot | 3 TX time slot | 4 TX time slot | |
| | | -9.03 | -6.02 | -4.26 | -3.01 | |

Unless otherwise stated the results shown in this test report refer only to the sample(s) tested and such sample(s) are retained for 90 days only.

除非另有說明，此報告結果僅對測試之樣品負責，同時此樣品僅保留90天。本報告未經本公司書面許可，不可部份複製。

This document is issued by the Company subject to its General Conditions of Service printed overleaf, available on request or accessible at www.sgs.com/terms_and_conditions.htm and, for electronic format documents, subject to Terms and Conditions for Electronic Documents at www.sgs.com/terms_e-document.htm. Attention is drawn to the limitation of liability, indemnification and jurisdiction issues defined therein. Any holder of this document is advised that information contained hereon reflects the Company's findings at the time of its intervention only and within the limits of Client's instructions, if any. The Company's sole responsibility is to its Client and this document does not exonerate parties to a transaction from exercising all their rights and obligations under the transaction documents. This document cannot be reproduced except in full, without prior written approval of the Company. Any unauthorized alteration, forgery or falsification of the content or appearance of this document is unlawful and offenders may be prosecuted to the fullest extent of the law.

| Burst average power | | | | |
|--|--------------------|-----|----------------|----------------|
| Max. Rated Avg. Power + Max. Tolerance (dBm) | | | 30 | 28.5 |
| | | | 1Dn1UP | 1Dn2UP |
| EUT mode | Frequency (MHz) | CH | Avg. (dBm) | Avg. (dBm) |
| GPRS 1900 | 1850.2 | 512 | 29.00 | 28.23 |
| | 1880 | 661 | 29.20 | 28.33 |
| | 1909.8 | 810 | 29.00 | 28.29 |
| Source-based time average power | | | | |
| GPRS 1900 | 1850.2 | 512 | 19.97 | 22.21 |
| | 1880 | 661 | 20.17 | 22.31 |
| | 1909.8 | 810 | 19.97 | 22.27 |
| The division factor compared to the number of TX time slot | | | | |
| Division factor | | | 1 TX time slot | 2 TX time slot |
| | | | -9.03 | -6.02 |

| Burst average power | | | | | | |
|--|--------------------|-----|----------------|----------------|----------------|----------------|
| Max. Rated Avg. Power + Max. Tolerance (dBm) | | | 27 | 27 | 27 | 27 |
| | | | 1Dn1UP | 1Dn2UP | 1Dn3UP | 1Dn4UP |
| EUT mode | Frequency (MHz) | CH | Avg. (dBm) | Avg. (dBm) | Avg. (dBm) | Avg. (dBm) |
| EDGE 1900 (MCS5) | 1850.2 | 512 | 25.30 | 25.10 | 25.00 | 25.00 |
| | 1880 | 661 | 25.30 | 25.10 | 25.00 | 25.00 |
| | 1909.8 | 810 | 25.20 | 25.10 | 25.00 | 25.00 |
| Source-based time average power | | | | | | |
| EDGE 1900 (MCS5) | 1850.2 | 512 | 16.27 | 19.08 | 20.74 | 21.99 |
| | 1880 | 661 | 16.27 | 19.08 | 20.74 | 21.99 |
| | 1909.8 | 810 | 16.17 | 19.08 | 20.74 | 21.99 |
| The division factor compared to the number of TX time slot | | | | | | |
| Division factor | | | 1 TX time slot | 2 TX time slot | 3 TX time slot | 4 TX time slot |
| | | | -9.03 | -6.02 | -4.26 | -3.01 |

Unless otherwise stated the results shown in this test report refer only to the sample(s) tested and such sample(s) are retained for 90 days only.

除非另有說明，此報告結果僅對測試之樣品負責，同時此樣品僅保留90天。本報告未經本公司書面許可，不可部份複製。

This document is issued by the Company subject to its General Conditions of Service printed overleaf, available on request or accessible at www.sgs.com/terms_and_conditions.htm and, for electronic format documents, subject to Terms and Conditions for Electronic Documents at www.sgs.com/terms_e-document.htm. Attention is drawn to the limitation of liability, indemnification and jurisdiction issues defined therein. Any holder of this document is advised that information contained hereon reflects the Company's findings at the time of its intervention only and within the limits of Client's instructions, if any. The Company's sole responsibility is to its Client and this document does not exonerate parties to a transaction from exercising all their rights and obligations under the transaction documents. This document cannot be reproduced except in full, without prior written approval of the Company. Any unauthorized alteration, forgery or falsification of the content or appearance of this document is unlawful and offenders may be prosecuted to the fullest extent of the law.

WCDMA Band II / Band IV / Band V - HSDPA / HSUPA conducted power table:

| Band | CH | Max. Rated Avg. Power + Max. Tolerance (dBm) | Rel99 AV(dBm) | HSDPA mode AV(dBm) | | | | HSUPA mode AV(dBm) | | | | | HSPA+ mode AV(dBm) | | | | |
|---------------------|------|--|---------------|--------------------|-------|-------|-------|--------------------|-------|-------|-------|-------|--------------------|-------|-------|-------|-------|
| | | | | SUB-1 | SUB-2 | SUB-3 | SUB-4 | SUB-1 | SUB-2 | SUB-3 | SUB-4 | SUB-5 | SUB-1 | SUB-2 | SUB-3 | SUB-4 | SUB-5 |
| WCDMA Band II Rel 7 | 9262 | 21.5 | 21.50 | 20.99 | 20.38 | 20.51 | 20.58 | 21.42 | 19.97 | 19.98 | 20.10 | 20.32 | 21.43 | 19.91 | 20.40 | 20.02 | 21.23 |
| | 9400 | 21.5 | 21.36 | 20.87 | 20.22 | 20.42 | 20.43 | 21.34 | 19.89 | 19.90 | 20.02 | 20.22 | 21.33 | 19.81 | 20.32 | 19.92 | 21.18 |
| | 9538 | 21.5 | 21.48 | 20.92 | 20.33 | 20.39 | 20.51 | 21.42 | 19.97 | 19.98 | 20.10 | 20.27 | 21.43 | 19.91 | 20.44 | 20.02 | 21.29 |
| WCDMA Band IV Rel 7 | 1312 | 22 | 21.77 | 21.28 | 20.65 | 20.8 | 20.87 | 21.69 | 20.24 | 20.25 | 20.37 | 20.91 | 21.70 | 20.18 | 20.67 | 20.29 | 21.50 |
| | 1412 | 22 | 21.75 | 21.31 | 20.61 | 20.86 | 20.87 | 21.73 | 20.28 | 20.29 | 20.41 | 20.98 | 21.72 | 20.20 | 20.71 | 20.31 | 21.57 |
| | 1513 | 22 | 21.76 | 21.26 | 20.61 | 20.73 | 20.85 | 21.70 | 20.25 | 20.26 | 20.38 | 20.93 | 21.71 | 20.19 | 20.72 | 20.30 | 21.57 |
| WCDMA Band V Rel 7 | 4132 | 23 | 22.55 | 22.00 | 21.48 | 21.54 | 21.59 | 22.51 | 20.57 | 20.55 | 20.62 | 21.27 | 22.52 | 20.55 | 21.50 | 20.58 | 22.33 |
| | 4183 | 23 | 22.63 | 22.12 | 21.52 | 21.64 | 21.68 | 22.56 | 20.64 | 20.62 | 20.7 | 21.61 | 22.55 | 20.57 | 21.55 | 20.63 | 22.32 |
| | 4233 | 23 | 22.49 | 22.03 | 21.36 | 21.54 | 21.6 | 22.41 | 20.45 | 20.49 | 20.53 | 21.39 | 22.40 | 20.37 | 21.39 | 20.43 | 22.22 |

HSDPA

| SUB-TEST | β_c | β_d | β_d (SF) | β_c/β_d | β_{HS} (Note 1, Note 2) | CM (dB) (Note 3) | MPR (dB) (Note 3) |
|----------|-----------|-----------|----------------|-------------------|-------------------------------|------------------|-------------------|
| 1 | 2/15 | 15/15 | 64 | 2/15 | 4/15 | 0.0 | 0.0 |
| 2 | 12/15 | 15/15 | 64 | 12/15 | 24/15 | 1.0 | 0.0 |
| 3 | 15/15 | 8/15 | 64 | 15/8 | 30/15 | 1.5 | 0.5 |
| 4 | 15/15 | 4/15 | 64 | 15/4 | 30/15 | 1.5 | 0.5 |

HSUPA

| SUB-TEST | β_c | β_d | β_d (SF) | β_c/β_d | β_{HS} (Note 1) | β_{ec} | β_{ed} (Note 5) (Note 6) | β_{ed} (SF) | β_{ed} (Codes) | CM (dB) (Note 2) | MPR (dB) (Note 2) | AG Index (Note 6) | E-TFCI |
|----------|-----------|-----------|----------------|-------------------|-----------------------|--------------|--|-------------------|----------------------|------------------|-------------------|-------------------|--------|
| 1 | 11/15 | 15/15 | 64 | 11/15 | 22/15 | 209/225 | 1309/225 | 4 | 1 | 1.0 | 0.0 | 20 | 75 |
| 2 | 6/15 | 15/15 | 64 | 6/15 | 12/15 | 12/15 | 94/75 | 4 | 1 | 3.0 | 2.0 | 12 | 67 |
| 3 | 15/15 | 9/15 | 64 | 15/9 | 30/15 | 30/15 | β_{ed1} : 47/15 β_{ed2} : 47/15 | 4 4 | 2 | 2.0 | 1.0 | 15 | 92 |
| 4 | 2/15 | 15/15 | 64 | 2/15 | 4/15 | 2/15 | 56/75 | 4 | 1 | 3.0 | 2.0 | 17 | 71 |
| 5 | 15/15 | 15/15 | 64 | 15/15 | 30/15 | 24/15 | 134/15 | 4 | 1 | 1.0 | 0.0 | 21 | 81 |

Unless otherwise stated the results shown in this test report refer only to the sample(s) tested and such sample(s) are retained for 90 days only.

除非另有說明，此報告結果僅對測試之樣品負責，同時此樣品僅保留90天。本報告未經本公司書面許可，不可部份複製。

This document is issued by the Company subject to its General Conditions of Service printed overleaf, available on request or accessible at www.sgs.com/terms_and_conditions.htm and, for electronic format documents, subject to Terms and Conditions for Electronic Documents at www.sgs.com/terms_e-document.htm. Attention is drawn to the limitation of liability, indemnification and jurisdiction issues defined therein. Any holder of this document is advised that information contained hereon reflects the Company's findings at the time of its intervention only and within the limits of Client's instructions, if any. The Company's sole responsibility is to its Client and this document does not exonerate parties to a transaction from exercising all their rights and obligations under the transaction documents. This document cannot be reproduced except in full, without prior written approval of the Company. Any unauthorized alteration, forgery or falsification of the content or appearance of this document is unlawful and offenders may be prosecuted to the fullest extent of the law.

LTE FDD Band II/ Band IV/ Band V/ Band XIII/ Band XVII / Band XXV power table:

| FDD Band 2 | | | | | | | | | |
|------------|------------|---------|-----------|-----------------|---------|-----------------------|-------------------------------------|--------------------------|-----|
| BW(Mhz) | Modulation | RB Size | RB Offset | Frequency (MHz) | Channel | Conducted power (dBm) | Target Power + Max. Tolerance (dBm) | MPR Allowed per 3GPP(dB) | |
| 20 | QPSK | 1 RB | 0 | 1860 | 18700 | 21.83 | 22 | 0 | |
| | | | | 1880 | 18900 | 21.76 | 22 | 0 | |
| | | | | 1900 | 19100 | 21.63 | 22 | 0 | |
| | | | 50 | 1860 | 18700 | 21.81 | 22 | 0 | |
| | | | | 1880 | 18900 | 21.60 | 22 | 0 | |
| | | | | 1900 | 19100 | 21.71 | 22 | 0 | |
| | | | 99 | 1860 | 18700 | 21.81 | 22 | 0 | |
| | | | | 1880 | 18900 | 21.75 | 22 | 0 | |
| | | | | 1900 | 19100 | 21.88 | 22 | 0 | |
| | | 50 RB | 0 | 1860 | 18700 | 21.69 | 22 | 0-1 | |
| | | | | 1880 | 18900 | 21.87 | 22 | 0-1 | |
| | | | | 1900 | 19100 | 21.53 | 22 | 0-1 | |
| | | | 25 | 1860 | 18700 | 21.81 | 22 | 0-1 | |
| | | | | 1880 | 18900 | 21.72 | 22 | 0-1 | |
| | | | | 1900 | 19100 | 21.52 | 22 | 0-1 | |
| | | | 50 | 1860 | 18700 | 21.86 | 22 | 0-1 | |
| | | | | 1880 | 18900 | 21.81 | 22 | 0-1 | |
| | | | | 1900 | 19100 | 21.55 | 22 | 0-1 | |
| | | | 100RB | 1860 | 18700 | 21.77 | 22 | 0-1 | |
| | | | | 1880 | 18900 | 21.74 | 22 | 0-1 | |
| | | | | 1900 | 19100 | 21.62 | 22 | 0-1 | |
| | | 16-QAM | 1 RB | 0 | 1860 | 18700 | 20.70 | 22 | 0-1 |
| | | | | | 1880 | 18900 | 20.66 | 22 | 0-1 |
| | | | | | 1900 | 19100 | 20.52 | 22 | 0-1 |
| | 50 | | | 1860 | 18700 | 20.65 | 22 | 0-1 | |
| | | | | 1880 | 18900 | 20.50 | 22 | 0-1 | |
| | | | | 1900 | 19100 | 20.63 | 22 | 0-1 | |
| | 99 | | | 1860 | 18700 | 20.69 | 22 | 0-1 | |
| | | | | 1880 | 18900 | 20.65 | 22 | 0-1 | |
| | | | | 1900 | 19100 | 20.71 | 22 | 0-1 | |
| | 50 RB | | | 0 | 1860 | 18700 | 20.75 | 22 | 0-2 |
| | | | | | 1880 | 18900 | 20.70 | 22 | 0-2 |
| | | | | | 1900 | 19100 | 20.53 | 22 | 0-2 |
| | | | 25 | 1860 | 18700 | 20.75 | 22 | 0-2 | |
| | | | | 1880 | 18900 | 20.68 | 22 | 0-2 | |
| | | | | 1900 | 19100 | 20.37 | 22 | 0-2 | |
| | | | 50 | 1860 | 18700 | 20.71 | 22 | 0-2 | |
| | | | | 1880 | 18900 | 20.79 | 22 | 0-2 | |
| | | | | 1900 | 19100 | 20.55 | 22 | 0-2 | |
| | | | 100RB | 1860 | 18700 | 20.61 | 22 | 0-2 | |
| | | | | 1880 | 18900 | 20.65 | 22 | 0-2 | |
| | | | | 1900 | 19100 | 20.51 | 22 | 0-2 | |

Unless otherwise stated the results shown in this test report refer only to the sample(s) tested and such sample(s) are retained for 90 days only.

除非另有說明，此報告結果僅對測試之樣品負責，同時此樣品僅保留90天。本報告未經本公司書面許可，不可部份複製。

This document is issued by the Company subject to its General Conditions of Service printed overleaf, available on request or accessible at www.sgs.com/terms_and_conditions.htm and, for electronic format documents, subject to Terms and Conditions for Electronic Documents at www.sgs.com/terms_e-document.htm. Attention is drawn to the limitation of liability, indemnification and jurisdiction issues defined therein. Any holder of this document is advised that information contained hereon reflects the Company's findings at the time of its intervention only and within the limits of Client's instructions, if any. The Company's sole responsibility is to its Client and this document does not exonerate parties to a transaction from exercising all their rights and obligations under the transaction documents. This document cannot be reproduced except in full, without prior written approval of the Company. Any unauthorized alteration, forgery or falsification of the content or appearance of this document is unlawful and offenders may be prosecuted to the fullest extent of the law.

| FDD Band 2 | | | | | | | | | |
|------------|------------|---------|-----------|-----------------|---------|-----------------------|-------------------------------------|--------------------------|-----|
| BW(Mhz) | Modulation | RB Size | RB Offset | Frequency (MHz) | Channel | Conducted power (dBm) | Target Power + Max. Tolerance (dBm) | MPR Allowed per 3GPP(dB) | |
| 15 | QPSK | 1 RB | 0 | 1857.5 | 18675 | 21.77 | 22 | 0 | |
| | | | | 1880 | 18900 | 21.61 | 22 | 0 | |
| | | | | 1902.5 | 19125 | 21.49 | 22 | 0 | |
| | | | 36 | 1857.5 | 18675 | 21.67 | 22 | 0 | |
| | | | | 1880 | 18900 | 21.45 | 22 | 0 | |
| | | | | 1902.5 | 19125 | 21.61 | 22 | 0 | |
| | | 74 | 1857.5 | 18675 | 21.61 | 22 | 0 | | |
| | | | 1880 | 18900 | 21.60 | 22 | 0 | | |
| | | | 1902.5 | 19125 | 21.75 | 22 | 0 | | |
| | | 36 RB | 0 | 1857.5 | 18675 | 21.61 | 22 | 0-1 | |
| | | | | 1880 | 18900 | 21.65 | 22 | 0-1 | |
| | | | | 1902.5 | 19125 | 21.48 | 22 | 0-1 | |
| | | | 18 | 1857.5 | 18675 | 21.62 | 22 | 0-1 | |
| | | | | 1880 | 18900 | 21.54 | 22 | 0-1 | |
| | | | | 1902.5 | 19125 | 21.49 | 22 | 0-1 | |
| | | | 37 | 1857.5 | 18675 | 21.68 | 22 | 0-1 | |
| | | | | 1880 | 18900 | 21.66 | 22 | 0-1 | |
| | | | | 1902.5 | 19125 | 21.48 | 22 | 0-1 | |
| | | | 75RB | 1857.5 | 18675 | 21.64 | 22 | 0-1 | |
| | | | | 1880 | 18900 | 21.57 | 22 | 0-1 | |
| | | | | 1902.5 | 19125 | 21.44 | 22 | 0-1 | |
| | | 16-QAM | 1 RB | 0 | 1857.5 | 18675 | 20.54 | 22 | 0-1 |
| | | | | | 1880 | 18900 | 20.52 | 22 | 0-1 |
| | | | | | 1902.5 | 19125 | 20.47 | 22 | 0-1 |
| | 36 | | | 1857.5 | 18675 | 20.56 | 22 | 0-1 | |
| | | | | 1880 | 18900 | 20.39 | 22 | 0-1 | |
| | | | | 1902.5 | 19125 | 20.44 | 22 | 0-1 | |
| | 74 | | | 1857.5 | 18675 | 20.57 | 22 | 0-1 | |
| | | | | 1880 | 18900 | 20.55 | 22 | 0-1 | |
| | | | | 1902.5 | 19125 | 20.61 | 22 | 0-1 | |
| | 36 RB | | | 0 | 1857.5 | 18675 | 20.45 | 22 | 0-2 |
| | | | | | 1880 | 18900 | 20.61 | 22 | 0-2 |
| | | | | | 1902.5 | 19125 | 20.24 | 22 | 0-2 |
| | | | 18 | 1857.5 | 18675 | 20.58 | 22 | 0-2 | |
| | | | | 1880 | 18900 | 20.45 | 22 | 0-2 | |
| | | | | 1902.5 | 19125 | 20.39 | 22 | 0-2 | |
| | | | 37 | 1857.5 | 18675 | 20.58 | 22 | 0-2 | |
| | | | | 1880 | 18900 | 20.51 | 22 | 0-2 | |
| | | | | 1902.5 | 19125 | 20.35 | 22 | 0-2 | |
| | 75RB | | 1857.5 | 18675 | 20.51 | 22 | 0-2 | | |
| | | | 1880 | 18900 | 20.49 | 22 | 0-2 | | |
| | | | 1902.5 | 19125 | 20.35 | 22 | 0-2 | | |

Unless otherwise stated the results shown in this test report refer only to the sample(s) tested and such sample(s) are retained for 90 days only.

除非另有說明，此報告結果僅對測試之樣品負責，同時此樣品僅保留90天。本報告未經本公司書面許可，不可部份複製。

This document is issued by the Company subject to its General Conditions of Service printed overleaf, available on request or accessible at www.sgs.com/terms_and_conditions.htm and, for electronic format documents, subject to Terms and Conditions for Electronic Documents at www.sgs.com/terms_e-document.htm. Attention is drawn to the limitation of liability, indemnification and jurisdiction issues defined therein. Any holder of this document is advised that information contained hereon reflects the Company's findings at the time of its intervention only and within the limits of Client's instructions, if any. The Company's sole responsibility is to its Client and this document does not exonerate parties to a transaction from exercising all their rights and obligations under the transaction documents. This document cannot be reproduced except in full, without prior written approval of the Company. Any unauthorized alteration, forgery or falsification of the content or appearance of this document is unlawful and offenders may be prosecuted to the fullest extent of the law.

| FDD Band 2 | | | | | | | | | |
|------------|------------|---------|-----------|-----------------|---------|-----------------------|-------------------------------------|--------------------------|-----|
| BW(Mhz) | Modulation | RB Size | RB Offset | Frequency (MHz) | Channel | Conducted power (dBm) | Target Power + Max. Tolerance (dBm) | MPR Allowed per 3GPP(dB) | |
| 10 | QPSK | 1 RB | 0 | 1855 | 18650 | 21.62 | 22 | 0 | |
| | | | | 1880 | 18900 | 21.60 | 22 | 0 | |
| | | | | 1905 | 19150 | 21.25 | 22 | 0 | |
| | | | 25 | 1855 | 18650 | 21.60 | 22 | 0 | |
| | | | | 1880 | 18900 | 21.49 | 22 | 0 | |
| | | | | 1905 | 19150 | 21.64 | 22 | 0 | |
| | | | 49 | 1855 | 18650 | 21.55 | 22 | 0 | |
| | | | | 1880 | 18900 | 21.37 | 22 | 0 | |
| | | | | 1905 | 19150 | 21.80 | 22 | 0 | |
| | | 25 RB | 0 | 1855 | 18650 | 21.58 | 22 | 0-1 | |
| | | | | 1880 | 18900 | 21.69 | 22 | 0-1 | |
| | | | | 1905 | 19150 | 21.42 | 22 | 0-1 | |
| | | | 12 | 1855 | 18650 | 21.61 | 22 | 0-1 | |
| | | | | 1880 | 18900 | 21.44 | 22 | 0-1 | |
| | | | | 1905 | 19150 | 21.48 | 22 | 0-1 | |
| | | | 25 | 1855 | 18650 | 21.64 | 22 | 0-1 | |
| | | | | 1880 | 18900 | 21.57 | 22 | 0-1 | |
| | | | | 1905 | 19150 | 21.52 | 22 | 0-1 | |
| | | 50RB | 1855 | 18650 | 21.61 | 22 | 0-1 | | |
| | | | 1880 | 18900 | 21.41 | 22 | 0-1 | | |
| | | | 1905 | 19150 | 21.55 | 22 | 0-1 | | |
| | | 16-QAM | 1 RB | 0 | 1855 | 18650 | 20.59 | 22 | 0-1 |
| | | | | | 1880 | 18900 | 20.48 | 22 | 0-1 |
| | | | | | 1905 | 19150 | 20.47 | 22 | 0-1 |
| | 25 | | | 1855 | 18650 | 20.59 | 22 | 0-1 | |
| | | | | 1880 | 18900 | 20.38 | 22 | 0-1 | |
| | | | | 1905 | 19150 | 20.60 | 22 | 0-1 | |
| | 49 | | | 1855 | 18650 | 20.67 | 22 | 0-1 | |
| | | | | 1880 | 18900 | 20.61 | 22 | 0-1 | |
| | | | | 1905 | 19150 | 20.42 | 22 | 0-1 | |
| | 25 RB | | | 0 | 1855 | 18650 | 20.35 | 22 | 0-2 |
| | | | | | 1880 | 18900 | 20.57 | 22 | 0-2 |
| | | | | | 1905 | 19150 | 20.14 | 22 | 0-2 |
| | | | 12 | 1855 | 18650 | 20.48 | 22 | 0-2 | |
| | | | | 1880 | 18900 | 20.48 | 22 | 0-2 | |
| | | | | 1905 | 19150 | 20.34 | 22 | 0-2 | |
| | | | 25 | 1855 | 18650 | 20.48 | 22 | 0-2 | |
| | | | | 1880 | 18900 | 20.46 | 22 | 0-2 | |
| | | | | 1905 | 19150 | 20.43 | 22 | 0-2 | |
| | 50RB | | 1855 | 18650 | 20.55 | 22 | 0-2 | | |
| | | | 1880 | 18900 | 20.47 | 22 | 0-2 | | |
| | | | 1905 | 19150 | 20.28 | 22 | 0-2 | | |

Unless otherwise stated the results shown in this test report refer only to the sample(s) tested and such sample(s) are retained for 90 days only.

除非另有說明，此報告結果僅對測試之樣品負責，同時此樣品僅保留90天。本報告未經本公司書面許可，不可部份複製。

This document is issued by the Company subject to its General Conditions of Service printed overleaf, available on request or accessible at www.sgs.com/terms_and_conditions.htm and, for electronic format documents, subject to Terms and Conditions for Electronic Documents at www.sgs.com/terms_e-document.htm. Attention is drawn to the limitation of liability, indemnification and jurisdiction issues defined therein. Any holder of this document is advised that information contained hereon reflects the Company's findings at the time of its intervention only and within the limits of Client's instructions, if any. The Company's sole responsibility is to its Client and this document does not exonerate parties to a transaction from exercising all their rights and obligations under the transaction documents. This document cannot be reproduced except in full, without prior written approval of the Company. Any unauthorized alteration, forgery or falsification of the content or appearance of this document is unlawful and offenders may be prosecuted to the fullest extent of the law.

| FDD Band 2 | | | | | | | | | |
|------------|------------|---------|-----------|-----------------|---------|-----------------------|-------------------------------------|--------------------------|-----|
| BW(Mhz) | Modulation | RB Size | RB Offset | Frequency (MHz) | Channel | Conducted power (dBm) | Target Power + Max. Tolerance (dBm) | MPR Allowed per 3GPP(dB) | |
| 5 | QPSK | 1 RB | 0 | 1852.5 | 18625 | 21.56 | 22 | 0 | |
| | | | | 1880 | 18900 | 21.68 | 22 | 0 | |
| | | | | 1907.5 | 19175 | 21.21 | 22 | 0 | |
| | | | 12 | 1852.5 | 18625 | 21.69 | 22 | 0 | |
| | | | | 1880 | 18900 | 21.49 | 22 | 0 | |
| | | | | 1907.5 | 19175 | 21.70 | 22 | 0 | |
| | | 24 | 1852.5 | 18625 | 21.52 | 22 | 0 | | |
| | | | 1880 | 18900 | 21.33 | 22 | 0 | | |
| | | | 1907.5 | 19175 | 21.88 | 22 | 0 | | |
| | | 12 RB | 0 | 1852.5 | 18625 | 21.63 | 22 | 0-1 | |
| | | | | 1880 | 18900 | 21.68 | 22 | 0-1 | |
| | | | | 1907.5 | 19175 | 21.44 | 22 | 0-1 | |
| | | | 6 | 1852.5 | 18625 | 21.60 | 22 | 0-1 | |
| | | | | 1880 | 18900 | 21.37 | 22 | 0-1 | |
| | | | | 1907.5 | 19175 | 21.46 | 22 | 0-1 | |
| | | | 13 | 1852.5 | 18625 | 21.59 | 22 | 0-1 | |
| | | | | 1880 | 18900 | 21.60 | 22 | 0-1 | |
| | | | | 1907.5 | 19175 | 21.46 | 22 | 0-1 | |
| | | 25RB | 1852.5 | 18625 | 21.62 | 22 | 0-1 | | |
| | | | 1880 | 18900 | 21.44 | 22 | 0-1 | | |
| | | | 1907.5 | 19175 | 21.52 | 22 | 0-1 | | |
| | | 16-QAM | 1 RB | 0 | 1852.5 | 18625 | 20.66 | 22 | 0-1 |
| | | | | | 1880 | 18900 | 20.38 | 22 | 0-1 |
| | | | | | 1907.5 | 19175 | 20.55 | 22 | 0-1 |
| | 12 | | | 1852.5 | 18625 | 20.63 | 22 | 0-1 | |
| | | | | 1880 | 18900 | 20.30 | 22 | 0-1 | |
| | | | | 1907.5 | 19175 | 20.59 | 22 | 0-1 | |
| | 24 | | | 1852.5 | 18625 | 20.72 | 22 | 0-1 | |
| | | | | 1880 | 18900 | 20.61 | 22 | 0-1 | |
| | | | | 1907.5 | 19175 | 20.46 | 22 | 0-1 | |
| | 12 RB | | | 0 | 1852.5 | 18625 | 20.45 | 22 | 0-2 |
| | | | | | 1880 | 18900 | 20.61 | 22 | 0-2 |
| | | | | | 1907.5 | 19175 | 20.23 | 22 | 0-2 |
| | | | 6 | 1852.5 | 18625 | 20.57 | 22 | 0-2 | |
| | | | | 1880 | 18900 | 20.58 | 22 | 0-2 | |
| | | | | 1907.5 | 19175 | 20.35 | 22 | 0-2 | |
| | | | 13 | 1852.5 | 18625 | 20.58 | 22 | 0-2 | |
| | | | | 1880 | 18900 | 20.53 | 22 | 0-2 | |
| | | | | 1907.5 | 19175 | 20.52 | 22 | 0-2 | |
| | 25RB | | 1852.5 | 18625 | 20.52 | 22 | 0-2 | | |
| | | | 1880 | 18900 | 20.45 | 22 | 0-2 | | |
| | | | 1907.5 | 19175 | 20.31 | 22 | 0-2 | | |

Unless otherwise stated the results shown in this test report refer only to the sample(s) tested and such sample(s) are retained for 90 days only.

除非另有說明，此報告結果僅對測試之樣品負責，同時此樣品僅保留90天。本報告未經本公司書面許可，不可部份複製。

This document is issued by the Company subject to its General Conditions of Service printed overleaf, available on request or accessible at www.sgs.com/terms_and_conditions.htm and, for electronic format documents, subject to Terms and Conditions for Electronic Documents at www.sgs.com/terms_e-document.htm. Attention is drawn to the limitation of liability, indemnification and jurisdiction issues defined therein. Any holder of this document is advised that information contained hereon reflects the Company's findings at the time of its intervention only and within the limits of Client's instructions, if any. The Company's sole responsibility is to its Client and this document does not exonerate parties to a transaction from exercising all their rights and obligations under the transaction documents. This document cannot be reproduced except in full, without prior written approval of the Company. Any unauthorized alteration, forgery or falsification of the content or appearance of this document is unlawful and offenders may be prosecuted to the fullest extent of the law.

| FDD Band 2 | | | | | | | | | |
|------------|------------|---------|-----------|-----------------|---------|-----------------------|-------------------------------------|--------------------------|-----|
| BW(Mhz) | Modulation | RB Size | RB Offset | Frequency (MHz) | Channel | Conducted power (dBm) | Target Power + Max. Tolerance (dBm) | MPR Allowed per 3GPP(dB) | |
| 3 | QPSK | 1 RB | 0 | 1851.5 | 18615 | 21.55 | 22 | 0 | |
| | | | | 1880 | 18900 | 21.61 | 22 | 0 | |
| | | | | 1908.5 | 19185 | 21.25 | 22 | 0 | |
| | | | 7 | 1851.5 | 18615 | 21.51 | 22 | 0 | |
| | | | | 1880 | 18900 | 21.48 | 22 | 0 | |
| | | | | 1908.5 | 19185 | 21.74 | 22 | 0 | |
| | | 14 | 1851.5 | 18615 | 21.65 | 22 | 0 | | |
| | | | 1880 | 18900 | 21.36 | 22 | 0 | | |
| | | | 1908.5 | 19185 | 21.87 | 22 | 0 | | |
| | | 8 RB | 0 | 1851.5 | 18615 | 21.56 | 22 | 0-1 | |
| | | | | 1880 | 18900 | 21.59 | 22 | 0-1 | |
| | | | | 1908.5 | 19185 | 21.51 | 22 | 0-1 | |
| | | | 4 | 1851.5 | 18615 | 21.52 | 22 | 0-1 | |
| | | | | 1880 | 18900 | 21.37 | 22 | 0-1 | |
| | | | | 1908.5 | 19185 | 21.44 | 22 | 0-1 | |
| | | | 7 | 1851.5 | 18615 | 21.70 | 22 | 0-1 | |
| | | | | 1880 | 18900 | 21.65 | 22 | 0-1 | |
| | | | | 1908.5 | 19185 | 21.58 | 22 | 0-1 | |
| | | 15RB | 1851.5 | 18615 | 21.59 | 22 | 0-1 | | |
| | | | 1880 | 18900 | 21.34 | 22 | 0-1 | | |
| | | | 1908.5 | 19185 | 21.54 | 22 | 0-1 | | |
| | | 16-QAM | 1 RB | 0 | 1851.5 | 18615 | 20.67 | 22 | 0-1 |
| | | | | | 1880 | 18900 | 20.48 | 22 | 0-1 |
| | | | | | 1908.5 | 19185 | 20.43 | 22 | 0-1 |
| | 7 | | | 1851.5 | 18615 | 20.69 | 22 | 0-1 | |
| | | | | 1880 | 18900 | 20.43 | 22 | 0-1 | |
| | | | | 1908.5 | 19185 | 20.50 | 22 | 0-1 | |
| | 14 | | | 1851.5 | 18615 | 20.76 | 22 | 0-1 | |
| | | | | 1880 | 18900 | 20.65 | 22 | 0-1 | |
| | | | | 1908.5 | 19185 | 20.44 | 22 | 0-1 | |
| | 8 RB | | | 0 | 1851.5 | 18615 | 20.43 | 22 | 0-2 |
| | | | | | 1880 | 18900 | 20.58 | 22 | 0-2 |
| | | | | | 1908.5 | 19185 | 20.19 | 22 | 0-2 |
| | | | 4 | 1851.5 | 18615 | 20.57 | 22 | 0-2 | |
| | | | | 1880 | 18900 | 20.45 | 22 | 0-2 | |
| | | | | 1908.5 | 19185 | 20.39 | 22 | 0-2 | |
| | | | 7 | 1851.5 | 18615 | 20.44 | 22 | 0-2 | |
| | | | | 1880 | 18900 | 20.49 | 22 | 0-2 | |
| | | | | 1908.5 | 19185 | 20.49 | 22 | 0-2 | |
| | 15RB | | 1851.5 | 18615 | 20.58 | 22 | 0-2 | | |
| | | | 1880 | 18900 | 20.42 | 22 | 0-2 | | |
| | | | 1908.5 | 19185 | 20.29 | 22 | 0-2 | | |

Unless otherwise stated the results shown in this test report refer only to the sample(s) tested and such sample(s) are retained for 90 days only.

除非另有說明，此報告結果僅對測試之樣品負責，同時此樣品僅保留90天。本報告未經本公司書面許可，不可部份複製。

This document is issued by the Company subject to its General Conditions of Service printed overleaf, available on request or accessible at www.sgs.com/terms_and_conditions.htm and, for electronic format documents, subject to Terms and Conditions for Electronic Documents at www.sgs.com/terms_e-document.htm. Attention is drawn to the limitation of liability, indemnification and jurisdiction issues defined therein. Any holder of this document is advised that information contained hereon reflects the Company's findings at the time of its intervention only and within the limits of Client's instructions, if any. The Company's sole responsibility is to its Client and this document does not exonerate parties to a transaction from exercising all their rights and obligations under the transaction documents. This document cannot be reproduced except in full, without prior written approval of the Company. Any unauthorized alteration, forgery or falsification of the content or appearance of this document is unlawful and offenders may be prosecuted to the fullest extent of the law.

| FDD Band 2 | | | | | | | | | |
|------------|------------|---------|-----------|-----------------|---------|-----------------------|-------------------------------------|--------------------------|-----|
| BW(Mhz) | Modulation | RB Size | RB Offset | Frequency (MHz) | Channel | Conducted power (dBm) | Target Power + Max. Tolerance (dBm) | MPR Allowed per 3GPP(dB) | |
| 1.4 | QPSK | 1 RB | 0 | 1850.7 | 18607 | 21.52 | 22 | 0 | |
| | | | | 1880 | 18900 | 21.53 | 22 | 0 | |
| | | | | 1909.3 | 19193 | 21.29 | 22 | 0 | |
| | | | 2 | 1850.7 | 18607 | 21.56 | 22 | 0 | |
| | | | | 1880 | 18900 | 21.57 | 22 | 0 | |
| | | | | 1909.3 | 19193 | 21.60 | 22 | 0 | |
| | | 5 | 1850.7 | 18607 | 21.47 | 22 | 0 | | |
| | | | 1880 | 18900 | 21.38 | 22 | 0 | | |
| | | | 1909.3 | 19193 | 21.90 | 22 | 0 | | |
| | | 3 RB | 0 | 1850.7 | 18607 | 21.67 | 22 | 0-1 | |
| | | | | 1880 | 18900 | 21.76 | 22 | 0-1 | |
| | | | | 1909.3 | 19193 | 21.35 | 22 | 0-1 | |
| | | | 2 | 1850.7 | 18607 | 21.60 | 22 | 0-1 | |
| | | | | 1880 | 18900 | 21.42 | 22 | 0-1 | |
| | | | | 1909.3 | 19193 | 21.48 | 22 | 0-1 | |
| | | | 3 | 1850.7 | 18607 | 21.73 | 22 | 0-1 | |
| | | | | 1880 | 18900 | 21.64 | 22 | 0-1 | |
| | | | | 1909.3 | 19193 | 21.46 | 22 | 0-1 | |
| | | 6RB | 1850.7 | 18607 | 21.65 | 22 | 0-1 | | |
| | | | 1880 | 18900 | 21.32 | 22 | 0-1 | | |
| | | | 1909.3 | 19193 | 21.59 | 22 | 0-1 | | |
| | | 16-QAM | 1 RB | 0 | 1850.7 | 18607 | 20.54 | 22 | 0-1 |
| | | | | | 1880 | 18900 | 20.52 | 22 | 0-1 |
| | | | | | 1909.3 | 19193 | 20.48 | 22 | 0-1 |
| | 2 | | | 1850.7 | 18607 | 20.57 | 22 | 0-1 | |
| | | | | 1880 | 18900 | 20.35 | 22 | 0-1 | |
| | | | | 1909.3 | 19193 | 20.52 | 22 | 0-1 | |
| | 5 | | 1850.7 | 18607 | 20.73 | 22 | 0-1 | | |
| | | | 1880 | 18900 | 20.69 | 22 | 0-1 | | |
| | | | 1909.3 | 19193 | 20.41 | 22 | 0-1 | | |
| | 3 RB | | 0 | 1850.7 | 18607 | 20.26 | 22 | 0-2 | |
| | | | | 1880 | 18900 | 20.57 | 22 | 0-2 | |
| | | | | 1909.3 | 19193 | 20.17 | 22 | 0-2 | |
| | | | 2 | 1850.7 | 18607 | 20.53 | 22 | 0-2 | |
| | | | | 1880 | 18900 | 20.45 | 22 | 0-2 | |
| | | | | 1909.3 | 19193 | 20.33 | 22 | 0-2 | |
| | | | 3 | 1850.7 | 18607 | 20.58 | 22 | 0-2 | |
| | | | | 1880 | 18900 | 20.40 | 22 | 0-2 | |
| | | | | 1909.3 | 19193 | 20.46 | 22 | 0-2 | |
| | 6RB | | 1850.7 | 18607 | 20.50 | 22 | 0-2 | | |
| | | | 1880 | 18900 | 20.43 | 22 | 0-2 | | |
| | | | 1909.3 | 19193 | 20.26 | 22 | 0-2 | | |

Unless otherwise stated the results shown in this test report refer only to the sample(s) tested and such sample(s) are retained for 90 days only.

除非另有說明，此報告結果僅對測試之樣品負責，同時此樣品僅保留90天。本報告未經本公司書面許可，不可部份複製。

This document is issued by the Company subject to its General Conditions of Service printed overleaf, available on request or accessible at www.sgs.com/terms_and_conditions.htm and, for electronic format documents, subject to Terms and Conditions for Electronic Documents at www.sgs.com/terms_e-document.htm. Attention is drawn to the limitation of liability, indemnification and jurisdiction issues defined therein. Any holder of this document is advised that information contained hereon reflects the Company's findings at the time of its intervention only and within the limits of Client's instructions, if any. The Company's sole responsibility is to its Client and this document does not exonerate parties to a transaction from exercising all their rights and obligations under the transaction documents. This document cannot be reproduced except in full, without prior written approval of the Company. Any unauthorized alteration, forgery or falsification of the content or appearance of this document is unlawful and offenders may be prosecuted to the fullest extent of the law.

| FDD Band 4 | | | | | | | | | | |
|------------|------------|---------|-----------|-----------------|---------|-----------------------|-------------------------------------|--------------------------|-----|-----|
| BW(Mhz) | Modulation | RB Size | RB Offset | Frequency (MHz) | Channel | Conducted power (dBm) | Target Power + Max. Tolerance (dBm) | MPR Allowed per 3GPP(dB) | | |
| 20 | QPSK | 1 RB | 0 | 1720 | 20050 | 21.81 | 22 | 0 | | |
| | | | | 1732.5 | 20175 | 21.84 | 22 | 0 | | |
| | | | | 1745 | 20300 | 21.85 | 22 | 0 | | |
| | | | 50 | 0 | 1720 | 20050 | 21.90 | 22 | 0 | |
| | | | | | 1732.5 | 20175 | 21.80 | 22 | 0 | |
| | | | | | 1745 | 20300 | 21.91 | 22 | 0 | |
| | | | 99 | 0 | 1720 | 20050 | 21.86 | 22 | 0 | |
| | | | | | 1732.5 | 20175 | 21.82 | 22 | 0 | |
| | | | | | 1745 | 20300 | 21.88 | 22 | 0 | |
| | | 50 RB | 0 | 0 | 1720 | 20050 | 21.65 | 22 | 0-1 | |
| | | | | | 1732.5 | 20175 | 21.75 | 22 | 0-1 | |
| | | | | | 1745 | 20300 | 21.78 | 22 | 0-1 | |
| | | | 25 | 0 | 1720 | 20050 | 21.66 | 22 | 0-1 | |
| | | | | | 1732.5 | 20175 | 21.79 | 22 | 0-1 | |
| | | | | | 1745 | 20300 | 21.85 | 22 | 0-1 | |
| | | | 50 | 0 | 1720 | 20050 | 21.75 | 22 | 0-1 | |
| | | | | | 1732.5 | 20175 | 21.78 | 22 | 0-1 | |
| | | | | | 1745 | 20300 | 21.78 | 22 | 0-1 | |
| | | 100RB | 0 | 1720 | 20050 | 21.70 | 22 | 0-1 | | |
| | | | | 1732.5 | 20175 | 21.81 | 22 | 0-1 | | |
| | | | | 1745 | 20300 | 21.74 | 22 | 0-1 | | |
| | | 16-QAM | 1 RB | 0 | 1720 | 20050 | 20.71 | 22 | 0-1 | |
| | | | | | 1732.5 | 20175 | 20.76 | 22 | 0-1 | |
| | | | | | 1745 | 20300 | 20.79 | 22 | 0-1 | |
| | 50 | | | 0 | 1720 | 20050 | 20.81 | 22 | 0-1 | |
| | | | | | 1732.5 | 20175 | 20.73 | 22 | 0-1 | |
| | | | | | 1745 | 20300 | 20.81 | 22 | 0-1 | |
| | 99 | | | 0 | 1720 | 20050 | 20.83 | 22 | 0-1 | |
| | | | | | 1732.5 | 20175 | 20.81 | 22 | 0-1 | |
| | | | | | 1745 | 20300 | 20.85 | 22 | 0-1 | |
| | 50 RB | | | 0 | 0 | 1720 | 20050 | 20.63 | 22 | 0-2 |
| | | | | | | 1732.5 | 20175 | 20.70 | 22 | 0-2 |
| | | | | | | 1745 | 20300 | 20.69 | 22 | 0-2 |
| | | | 25 | 0 | 1720 | 20050 | 20.61 | 22 | 0-2 | |
| | | | | | 1732.5 | 20175 | 20.70 | 22 | 0-2 | |
| | | | | | 1745 | 20300 | 20.83 | 22 | 0-2 | |
| | | | 50 | 0 | 1720 | 20050 | 20.69 | 22 | 0-2 | |
| | | | | | 1732.5 | 20175 | 20.70 | 22 | 0-2 | |
| | | | | | 1745 | 20300 | 20.72 | 22 | 0-2 | |
| | 100RB | | 0 | 1720 | 20050 | 20.66 | 22 | 0-2 | | |
| | | | | 1732.5 | 20175 | 20.78 | 22 | 0-2 | | |
| | | | | 1745 | 20300 | 20.64 | 22 | 0-2 | | |

Unless otherwise stated the results shown in this test report refer only to the sample(s) tested and such sample(s) are retained for 90 days only.

除非另有說明，此報告結果僅對測試之樣品負責，同時此樣品僅保留90天。本報告未經本公司書面許可，不可部份複製。

This document is issued by the Company subject to its General Conditions of Service printed overleaf, available on request or accessible at www.sgs.com/terms_and_conditions.htm and, for electronic format documents, subject to Terms and Conditions for Electronic Documents at www.sgs.com/terms_e-document.htm. Attention is drawn to the limitation of liability, indemnification and jurisdiction issues defined therein. Any holder of this document is advised that information contained hereon reflects the Company's findings at the time of its intervention only and within the limits of Client's instructions, if any. The Company's sole responsibility is to its Client and this document does not exonerate parties to a transaction from exercising all their rights and obligations under the transaction documents. This document cannot be reproduced except in full, without prior written approval of the Company. Any unauthorized alteration, forgery or falsification of the content or appearance of this document is unlawful and offenders may be prosecuted to the fullest extent of the law.

| FDD Band 4 | | | | | | | | | |
|------------|------------|---------|-----------|-----------------|---------|-----------------------|-------------------------------------|--------------------------|-----|
| BW(Mhz) | Modulation | RB Size | RB Offset | Frequency (MHz) | Channel | Conducted power (dBm) | Target Power + Max. Tolerance (dBm) | MPR Allowed per 3GPP(dB) | |
| 15 | QPSK | 1 RB | 0 | 1717.5 | 20025 | 21.77 | 22 | 0 | |
| | | | | 1732.5 | 20175 | 21.74 | 22 | 0 | |
| | | | | 1747.5 | 20325 | 21.85 | 22 | 0 | |
| | | | 36 | 1717.5 | 20025 | 21.85 | 22 | 0 | |
| | | | | 1732.5 | 20175 | 21.73 | 22 | 0 | |
| | | | | 1747.5 | 20325 | 21.80 | 22 | 0 | |
| | | | 74 | 1717.5 | 20025 | 21.76 | 22 | 0 | |
| | | | | 1732.5 | 20175 | 21.74 | 22 | 0 | |
| | | | | 1747.5 | 20325 | 21.87 | 22 | 0 | |
| | | | 36 RB | 0 | 1717.5 | 20025 | 21.57 | 22 | 0-1 |
| | | | | | 1732.5 | 20175 | 21.75 | 22 | 0-1 |
| | | | | | 1747.5 | 20325 | 21.72 | 22 | 0-1 |
| | | 18 | | 1717.5 | 20025 | 21.57 | 22 | 0-1 | |
| | | | | 1732.5 | 20175 | 21.75 | 22 | 0-1 | |
| | | | | 1747.5 | 20325 | 21.80 | 22 | 0-1 | |
| | | 37 | | 1717.5 | 20025 | 21.67 | 22 | 0-1 | |
| | | | | 1732.5 | 20175 | 21.69 | 22 | 0-1 | |
| | | | | 1747.5 | 20325 | 21.77 | 22 | 0-1 | |
| | | 75RB | | 1717.5 | 20025 | 21.64 | 22 | 0-1 | |
| | | | | 1732.5 | 20175 | 21.80 | 22 | 0-1 | |
| | | | | 1747.5 | 20325 | 21.72 | 22 | 0-1 | |
| | | 16-QAM | 1 RB | 0 | 1717.5 | 20025 | 20.68 | 22 | 0-1 |
| | | | | | 1732.5 | 20175 | 20.72 | 22 | 0-1 |
| | | | | | 1747.5 | 20325 | 20.75 | 22 | 0-1 |
| | 36 | | | 1717.5 | 20025 | 20.73 | 22 | 0-1 | |
| | | | | 1732.5 | 20175 | 20.70 | 22 | 0-1 | |
| | | | | 1747.5 | 20325 | 20.77 | 22 | 0-1 | |
| | 74 | | | 1717.5 | 20025 | 20.77 | 22 | 0-1 | |
| | | | | 1732.5 | 20175 | 20.76 | 22 | 0-1 | |
| | | | | 1747.5 | 20325 | 20.80 | 22 | 0-1 | |
| | 36 RB | | | 0 | 1717.5 | 20025 | 20.60 | 22 | 0-2 |
| | | | | | 1732.5 | 20175 | 20.62 | 22 | 0-2 |
| | | | | | 1747.5 | 20325 | 20.68 | 22 | 0-2 |
| | | | 18 | 1717.5 | 20025 | 20.58 | 22 | 0-2 | |
| | | | | 1732.5 | 20175 | 20.62 | 22 | 0-2 | |
| | | | | 1747.5 | 20325 | 20.82 | 22 | 0-2 | |
| | | | 37 | 1717.5 | 20025 | 20.60 | 22 | 0-2 | |
| | | | | 1732.5 | 20175 | 20.62 | 22 | 0-2 | |
| | | | | 1747.5 | 20325 | 20.65 | 22 | 0-2 | |
| | | | 75RB | 1717.5 | 20025 | 20.62 | 22 | 0-2 | |
| | | | | 1732.5 | 20175 | 20.73 | 22 | 0-2 | |
| | | | | 1747.5 | 20325 | 20.64 | 22 | 0-2 | |

Unless otherwise stated the results shown in this test report refer only to the sample(s) tested and such sample(s) are retained for 90 days only.

除非另有說明，此報告結果僅對測試之樣品負責，同時此樣品僅保留90天。本報告未經本公司書面許可，不可部份複製。

This document is issued by the Company subject to its General Conditions of Service printed overleaf, available on request or accessible at www.sgs.com/terms_and_conditions.htm and, for electronic format documents, subject to Terms and Conditions for Electronic Documents at www.sgs.com/terms_e-document.htm. Attention is drawn to the limitation of liability, indemnification and jurisdiction issues defined therein. Any holder of this document is advised that information contained hereon reflects the Company's findings at the time of its intervention only and within the limits of Client's instructions, if any. The Company's sole responsibility is to its Client and this document does not exonerate parties to a transaction from exercising all their rights and obligations under the transaction documents. This document cannot be reproduced except in full, without prior written approval of the Company. Any unauthorized alteration, forgery or falsification of the content or appearance of this document is unlawful and offenders may be prosecuted to the fullest extent of the law.

| FDD Band 4 | | | | | | | | | |
|------------|------------|---------|-----------|-----------------|---------|-----------------------|-------------------------------------|--------------------------|-----|
| BW(Mhz) | Modulation | RB Size | RB Offset | Frequency (MHz) | Channel | Conducted power (dBm) | Target Power + Max. Tolerance (dBm) | MPR Allowed per 3GPP(dB) | |
| 10 | QPSK | 1 RB | 0 | 1715 | 20000 | 21.75 | 22 | 0 | |
| | | | | 1732.5 | 20175 | 21.70 | 22 | 0 | |
| | | | | 1750 | 20350 | 21.75 | 22 | 0 | |
| | | | 25 | 1715 | 20000 | 21.78 | 22 | 0 | |
| | | | | 1732.5 | 20175 | 21.70 | 22 | 0 | |
| | | | | 1750 | 20350 | 21.78 | 22 | 0 | |
| | | | 49 | 1715 | 20000 | 21.68 | 22 | 0 | |
| | | | | 1732.5 | 20175 | 21.69 | 22 | 0 | |
| | | | | 1750 | 20350 | 21.81 | 22 | 0 | |
| | | 25 RB | 0 | 1715 | 20000 | 21.55 | 22 | 0-1 | |
| | | | | 1732.5 | 20175 | 21.72 | 22 | 0-1 | |
| | | | | 1750 | 20350 | 21.63 | 22 | 0-1 | |
| | | | 12 | 1715 | 20000 | 21.53 | 22 | 0-1 | |
| | | | | 1732.5 | 20175 | 21.71 | 22 | 0-1 | |
| | | | | 1750 | 20350 | 21.79 | 22 | 0-1 | |
| | | | 25 | 1715 | 20000 | 21.62 | 22 | 0-1 | |
| | | | | 1732.5 | 20175 | 21.67 | 22 | 0-1 | |
| | | | | 1750 | 20350 | 21.68 | 22 | 0-1 | |
| | | 50RB | 1715 | 20000 | 21.60 | 22 | 0-1 | | |
| | | | 1732.5 | 20175 | 21.71 | 22 | 0-1 | | |
| | | | 1750 | 20350 | 21.67 | 22 | 0-1 | | |
| | | 16-QAM | 1 RB | 0 | 1715 | 20000 | 20.60 | 22 | 0-1 |
| | | | | | 1732.5 | 20175 | 20.67 | 22 | 0-1 |
| | | | | | 1750 | 20350 | 20.69 | 22 | 0-1 |
| | 25 | | | 1715 | 20000 | 20.64 | 22 | 0-1 | |
| | | | | 1732.5 | 20175 | 20.68 | 22 | 0-1 | |
| | | | | 1750 | 20350 | 20.72 | 22 | 0-1 | |
| | 49 | | | 1715 | 20000 | 20.70 | 22 | 0-1 | |
| | | | | 1732.5 | 20175 | 20.72 | 22 | 0-1 | |
| | | | | 1750 | 20350 | 20.70 | 22 | 0-1 | |
| | 25 RB | | 0 | 1715 | 20000 | 20.53 | 22 | 0-2 | |
| | | | | 1732.5 | 20175 | 20.56 | 22 | 0-2 | |
| | | | | 1750 | 20350 | 20.63 | 22 | 0-2 | |
| | | | 12 | 1715 | 20000 | 20.56 | 22 | 0-2 | |
| | | | | 1732.5 | 20175 | 20.54 | 22 | 0-2 | |
| | | | | 1750 | 20350 | 20.74 | 22 | 0-2 | |
| | | | 25 | 1715 | 20000 | 20.56 | 22 | 0-2 | |
| | | | | 1732.5 | 20175 | 20.53 | 22 | 0-2 | |
| | | | | 1750 | 20350 | 20.59 | 22 | 0-2 | |
| | 50RB | | 1715 | 20000 | 20.62 | 22 | 0-2 | | |
| | | | 1732.5 | 20175 | 20.66 | 22 | 0-2 | | |
| | | | 1750 | 20350 | 20.54 | 22 | 0-2 | | |

Unless otherwise stated the results shown in this test report refer only to the sample(s) tested and such sample(s) are retained for 90 days only.

除非另有說明，此報告結果僅對測試之樣品負責，同時此樣品僅保留90天。本報告未經本公司書面許可，不可部份複製。

This document is issued by the Company subject to its General Conditions of Service printed overleaf, available on request or accessible at www.sgs.com/terms_and_conditions.htm and, for electronic format documents, subject to Terms and Conditions for Electronic Documents at www.sgs.com/terms_e-document.htm. Attention is drawn to the limitation of liability, indemnification and jurisdiction issues defined therein. Any holder of this document is advised that information contained hereon reflects the Company's findings at the time of its intervention only and within the limits of Client's instructions, if any. The Company's sole responsibility is to its Client and this document does not exonerate parties to a transaction from exercising all their rights and obligations under the transaction documents. This document cannot be reproduced except in full, without prior written approval of the Company. Any unauthorized alteration, forgery or falsification of the content or appearance of this document is unlawful and offenders may be prosecuted to the fullest extent of the law.

| FDD Band 4 | | | | | | | | | |
|------------|------------|---------|-----------|-----------------|---------|-----------------------|-------------------------------------|--------------------------|-----|
| BW(Mhz) | Modulation | RB Size | RB Offset | Frequency (MHz) | Channel | Conducted power (dBm) | Target Power + Max. Tolerance (dBm) | MPR Allowed per 3GPP(dB) | |
| 5 | QPSK | 1 RB | 0 | 1712.5 | 19975 | 21.68 | 22 | 0 | |
| | | | | 1732.5 | 20175 | 21.66 | 22 | 0 | |
| | | | | 1752.5 | 20375 | 21.68 | 22 | 0 | |
| | | | 12 | 1712.5 | 19975 | 21.70 | 22 | 0 | |
| | | | | 1732.5 | 20175 | 21.67 | 22 | 0 | |
| | | | | 1752.5 | 20375 | 21.68 | 22 | 0 | |
| | | 24 | 1712.5 | 19975 | 21.65 | 22 | 0 | | |
| | | | 1732.5 | 20175 | 21.65 | 22 | 0 | | |
| | | | 1752.5 | 20375 | 21.81 | 22 | 0 | | |
| | | 12 RB | 0 | 1712.5 | 19975 | 21.48 | 22 | 0-1 | |
| | | | | 1732.5 | 20175 | 21.70 | 22 | 0-1 | |
| | | | | 1752.5 | 20375 | 21.59 | 22 | 0-1 | |
| | | | 6 | 1712.5 | 19975 | 21.51 | 22 | 0-1 | |
| | | | | 1732.5 | 20175 | 21.63 | 22 | 0-1 | |
| | | | | 1752.5 | 20375 | 21.70 | 22 | 0-1 | |
| | | | 13 | 1712.5 | 19975 | 21.58 | 22 | 0-1 | |
| | | | | 1732.5 | 20175 | 21.64 | 22 | 0-1 | |
| | | | | 1752.5 | 20375 | 21.60 | 22 | 0-1 | |
| | | 25RB | 1712.5 | 19975 | 21.58 | 22 | 0-1 | | |
| | | | 1732.5 | 20175 | 21.71 | 22 | 0-1 | | |
| | | | 1752.5 | 20375 | 21.64 | 22 | 0-1 | | |
| | | 16-QAM | 1 RB | 0 | 1712.5 | 19975 | 20.56 | 22 | 0-1 |
| | | | | | 1732.5 | 20175 | 20.62 | 22 | 0-1 |
| | | | | | 1752.5 | 20375 | 20.62 | 22 | 0-1 |
| | 12 | | | 1712.5 | 19975 | 20.55 | 22 | 0-1 | |
| | | | | 1732.5 | 20175 | 20.67 | 22 | 0-1 | |
| | | | | 1752.5 | 20375 | 20.62 | 22 | 0-1 | |
| | 24 | | 1712.5 | 19975 | 20.67 | 22 | 0-1 | | |
| | | | 1732.5 | 20175 | 20.71 | 22 | 0-1 | | |
| | | | 1752.5 | 20375 | 20.69 | 22 | 0-1 | | |
| | 12 RB | | 0 | 1712.5 | 19975 | 20.50 | 22 | 0-2 | |
| | | | | 1732.5 | 20175 | 20.52 | 22 | 0-2 | |
| | | | | 1752.5 | 20375 | 20.58 | 22 | 0-2 | |
| | | | 6 | 1712.5 | 19975 | 20.55 | 22 | 0-2 | |
| | | | | 1732.5 | 20175 | 20.49 | 22 | 0-2 | |
| | | | | 1752.5 | 20375 | 20.71 | 22 | 0-2 | |
| | | | 13 | 1712.5 | 19975 | 20.54 | 22 | 0-2 | |
| | | | | 1732.5 | 20175 | 20.43 | 22 | 0-2 | |
| | | | | 1752.5 | 20375 | 20.58 | 22 | 0-2 | |
| | 25RB | | 1712.5 | 19975 | 20.60 | 22 | 0-2 | | |
| | | | 1732.5 | 20175 | 20.63 | 22 | 0-2 | | |
| | | | 1752.5 | 20375 | 20.53 | 22 | 0-2 | | |

Unless otherwise stated the results shown in this test report refer only to the sample(s) tested and such sample(s) are retained for 90 days only.

除非另有說明，此報告結果僅對測試之樣品負責，同時此樣品僅保留90天。本報告未經本公司書面許可，不可部份複製。

This document is issued by the Company subject to its General Conditions of Service printed overleaf, available on request or accessible at www.sgs.com/terms_and_conditions.htm and, for electronic format documents, subject to Terms and Conditions for Electronic Documents at www.sgs.com/terms_e-document.htm. Attention is drawn to the limitation of liability, indemnification and jurisdiction issues defined therein. Any holder of this document is advised that information contained hereon reflects the Company's findings at the time of its intervention only and within the limits of Client's instructions, if any. The Company's sole responsibility is to its Client and this document does not exonerate parties to a transaction from exercising all their rights and obligations under the transaction documents. This document cannot be reproduced except in full, without prior written approval of the Company. Any unauthorized alteration, forgery or falsification of the content or appearance of this document is unlawful and offenders may be prosecuted to the fullest extent of the law.

| FDD Band 4 | | | | | | | | | |
|------------|------------|---------|-----------|-----------------|---------|-----------------------|-------------------------------------|--------------------------|-----|
| BW(Mhz) | Modulation | RB Size | RB Offset | Frequency (MHz) | Channel | Conducted power (dBm) | Target Power + Max. Tolerance (dBm) | MPR Allowed per 3GPP(dB) | |
| 3 | QPSK | 1 RB | 0 | 1711.5 | 19965 | 21.62 | 22 | 0 | |
| | | | | 1732.5 | 20175 | 21.65 | 22 | 0 | |
| | | | | 1753.5 | 20385 | 21.59 | 22 | 0 | |
| | | | 7 | 1711.5 | 19965 | 21.63 | 22 | 0 | |
| | | | | 1732.5 | 20175 | 21.61 | 22 | 0 | |
| | | | | 1753.5 | 20385 | 21.68 | 22 | 0 | |
| | | 14 | 1711.5 | 19965 | 21.59 | 22 | 0 | | |
| | | | 1732.5 | 20175 | 21.56 | 22 | 0 | | |
| | | | 1753.5 | 20385 | 21.77 | 22 | 0 | | |
| | | 8 RB | 0 | 1711.5 | 19965 | 21.42 | 22 | 0-1 | |
| | | | | 1732.5 | 20175 | 21.69 | 22 | 0-1 | |
| | | | | 1753.5 | 20385 | 21.50 | 22 | 0-1 | |
| | | | 4 | 1711.5 | 19965 | 21.43 | 22 | 0-1 | |
| | | | | 1732.5 | 20175 | 21.55 | 22 | 0-1 | |
| | | | | 1753.5 | 20385 | 21.62 | 22 | 0-1 | |
| | | | 7 | 1711.5 | 19965 | 21.50 | 22 | 0-1 | |
| | | | | 1732.5 | 20175 | 21.62 | 22 | 0-1 | |
| | | | | 1753.5 | 20385 | 21.57 | 22 | 0-1 | |
| | | 15RB | 1711.5 | 19965 | 21.56 | 22 | 0-1 | | |
| | | | 1732.5 | 20175 | 21.61 | 22 | 0-1 | | |
| | | | 1753.5 | 20385 | 21.55 | 22 | 0-1 | | |
| | | 16-QAM | 1 RB | 0 | 1711.5 | 19965 | 20.53 | 22 | 0-1 |
| | | | | | 1732.5 | 20175 | 20.54 | 22 | 0-1 |
| | | | | | 1753.5 | 20385 | 20.61 | 22 | 0-1 |
| | 7 | | | 1711.5 | 19965 | 20.52 | 22 | 0-1 | |
| | | | | 1732.5 | 20175 | 20.65 | 22 | 0-1 | |
| | | | | 1753.5 | 20385 | 20.56 | 22 | 0-1 | |
| | 14 | | 1711.5 | 19965 | 20.62 | 22 | 0-1 | | |
| | | | 1732.5 | 20175 | 20.66 | 22 | 0-1 | | |
| | | | 1753.5 | 20385 | 20.60 | 22 | 0-1 | | |
| | 8 RB | | 0 | 1711.5 | 19965 | 20.46 | 22 | 0-2 | |
| | | | | 1732.5 | 20175 | 20.49 | 22 | 0-2 | |
| | | | | 1753.5 | 20385 | 20.52 | 22 | 0-2 | |
| | | | 4 | 1711.5 | 19965 | 20.52 | 22 | 0-2 | |
| | | | | 1732.5 | 20175 | 20.43 | 22 | 0-2 | |
| | | | | 1753.5 | 20385 | 20.67 | 22 | 0-2 | |
| | | | 7 | 1711.5 | 19965 | 20.46 | 22 | 0-2 | |
| | | | | 1732.5 | 20175 | 20.36 | 22 | 0-2 | |
| | | | | 1753.5 | 20385 | 20.56 | 22 | 0-2 | |
| | 15RB | | 1711.5 | 19965 | 20.51 | 22 | 0-2 | | |
| | | | 1732.5 | 20175 | 20.57 | 22 | 0-2 | | |
| | | | 1753.5 | 20385 | 20.51 | 22 | 0-2 | | |

Unless otherwise stated the results shown in this test report refer only to the sample(s) tested and such sample(s) are retained for 90 days only.

除非另有說明，此報告結果僅對測試之樣品負責，同時此樣品僅保留90天。本報告未經本公司書面許可，不可部份複製。

This document is issued by the Company subject to its General Conditions of Service printed overleaf, available on request or accessible at www.sgs.com/terms_and_conditions.htm and, for electronic format documents, subject to Terms and Conditions for Electronic Documents at www.sgs.com/terms_e-document.htm. Attention is drawn to the limitation of liability, indemnification and jurisdiction issues defined therein. Any holder of this document is advised that information contained hereon reflects the Company's findings at the time of its intervention only and within the limits of Client's instructions, if any. The Company's sole responsibility is to its Client and this document does not exonerate parties to a transaction from exercising all their rights and obligations under the transaction documents. This document cannot be reproduced except in full, without prior written approval of the Company. Any unauthorized alteration, forgery or falsification of the content or appearance of this document is unlawful and offenders may be prosecuted to the fullest extent of the law.

| FDD Band 4 | | | | | | | | | |
|------------|------------|---------|-----------|-----------------|---------|-----------------------|-------------------------------------|--------------------------|-----|
| BW(Mhz) | Modulation | RB Size | RB Offset | Frequency (MHz) | Channel | Conducted power (dBm) | Target Power + Max. Tolerance (dBm) | MPR Allowed per 3GPP(dB) | |
| 1.4 | QPSK | 1 RB | 0 | 1710.7 | 19957 | 21.60 | 22 | 0 | |
| | | | | 1732.5 | 20175 | 21.61 | 22 | 0 | |
| | | | | 1754.3 | 20393 | 21.64 | 22 | 0 | |
| | | | 2 | 1710.7 | 19957 | 21.68 | 22 | 0 | |
| | | | | 1732.5 | 20175 | 21.66 | 22 | 0 | |
| | | | | 1754.3 | 20393 | 21.61 | 22 | 0 | |
| | | 5 | 1710.7 | 19957 | 21.57 | 22 | 0 | | |
| | | | 1732.5 | 20175 | 21.64 | 22 | 0 | | |
| | | | 1754.3 | 20393 | 21.71 | 22 | 0 | | |
| | | 3 RB | 0 | 1710.7 | 19957 | 21.47 | 22 | 0-1 | |
| | | | | 1732.5 | 20175 | 21.61 | 22 | 0-1 | |
| | | | | 1754.3 | 20393 | 21.55 | 22 | 0-1 | |
| | | | 2 | 1710.7 | 19957 | 21.49 | 22 | 0-1 | |
| | | | | 1732.5 | 20175 | 21.58 | 22 | 0-1 | |
| | | | | 1754.3 | 20393 | 21.63 | 22 | 0-1 | |
| | | | 3 | 1710.7 | 19957 | 21.52 | 22 | 0-1 | |
| | | | | 1732.5 | 20175 | 21.60 | 22 | 0-1 | |
| | | | | 1754.3 | 20393 | 21.53 | 22 | 0-1 | |
| | | 6RB | 1710.7 | 19957 | 21.56 | 22 | 0-1 | | |
| | | | 1732.5 | 20175 | 21.67 | 22 | 0-1 | | |
| | | | 1754.3 | 20393 | 21.55 | 22 | 0-1 | | |
| | | 16-QAM | 1 RB | 0 | 1710.7 | 19957 | 20.50 | 22 | 0-1 |
| | | | | | 1732.5 | 20175 | 20.58 | 22 | 0-1 |
| | | | | | 1754.3 | 20393 | 20.54 | 22 | 0-1 |
| | 2 | | | 1710.7 | 19957 | 20.54 | 22 | 0-1 | |
| | | | | 1732.5 | 20175 | 20.66 | 22 | 0-1 | |
| | | | | 1754.3 | 20393 | 20.60 | 22 | 0-1 | |
| | 5 | | | 1710.7 | 19957 | 20.67 | 22 | 0-1 | |
| | | | | 1732.5 | 20175 | 20.67 | 22 | 0-1 | |
| | | | | 1754.3 | 20393 | 20.65 | 22 | 0-1 | |
| | 3 RB | | | 0 | 1710.7 | 19957 | 20.41 | 22 | 0-2 |
| | | | | | 1732.5 | 20175 | 20.44 | 22 | 0-2 |
| | | | | | 1754.3 | 20393 | 20.49 | 22 | 0-2 |
| | | | 2 | 1710.7 | 19957 | 20.47 | 22 | 0-2 | |
| | | | | 1732.5 | 20175 | 20.41 | 22 | 0-2 | |
| | | | | 1754.3 | 20393 | 20.63 | 22 | 0-2 | |
| | | | 3 | 1710.7 | 19957 | 20.52 | 22 | 0-2 | |
| | | | | 1732.5 | 20175 | 20.34 | 22 | 0-2 | |
| | | | | 1754.3 | 20393 | 20.49 | 22 | 0-2 | |
| | 6RB | | 1710.7 | 19957 | 20.52 | 22 | 0-2 | | |
| | | | 1732.5 | 20175 | 20.61 | 22 | 0-2 | | |
| | | | 1754.3 | 20393 | 20.44 | 22 | 0-2 | | |

Unless otherwise stated the results shown in this test report refer only to the sample(s) tested and such sample(s) are retained for 90 days only.

除非另有說明，此報告結果僅對測試之樣品負責，同時此樣品僅保留90天。本報告未經本公司書面許可，不可部份複製。

This document is issued by the Company subject to its General Conditions of Service printed overleaf, available on request or accessible at www.sgs.com/terms_and_conditions.htm and, for electronic format documents, subject to Terms and Conditions for Electronic Documents at www.sgs.com/terms_e-document.htm. Attention is drawn to the limitation of liability, indemnification and jurisdiction issues defined therein. Any holder of this document is advised that information contained hereon reflects the Company's findings at the time of its intervention only and within the limits of Client's instructions, if any. The Company's sole responsibility is to its Client and this document does not exonerate parties to a transaction from exercising all their rights and obligations under the transaction documents. This document cannot be reproduced except in full, without prior written approval of the Company. Any unauthorized alteration, forgery or falsification of the content or appearance of this document is unlawful and offenders may be prosecuted to the fullest extent of the law.

| FDD Band 5 | | | | | | | | | | | | |
|------------|------------|---------|-----------|-----------------|---------|-----------------------|-------------------------------------|--------------------------|-------|-------|-----|-----|
| BW(MHz) | Modulation | RB Size | RB Offset | Frequency (MHz) | Channel | Conducted power (dBm) | Target Power + Max. Tolerance (dBm) | MPR Allowed per 3GPP(dB) | | | | |
| 10 | QPSK | 1 RB | 0 | 829 | 20450 | 22.44 | 23 | 0 | | | | |
| | | | | 836.5 | 20525 | 22.21 | 23 | 0 | | | | |
| | | | | 844 | 20600 | 22.38 | 23 | 0 | | | | |
| | | | 25 | 829 | 20450 | 22.39 | 23 | 0 | | | | |
| | | | | | 836.5 | 20525 | 22.36 | 23 | 0 | | | |
| | | | | | 844 | 20600 | 22.47 | 23 | 0 | | | |
| | | | | 49 | 829 | 20450 | 22.39 | 23 | 0 | | | |
| | | | | | | 836.5 | 20525 | 22.39 | 23 | 0 | | |
| | | | | | | 844 | 20600 | 22.55 | 23 | 0 | | |
| | | 25 RB | 0 | 829 | 20450 | 21.22 | 23 | 0-1 | | | | |
| | | | | | 836.5 | 20525 | 21.39 | 23 | 0-1 | | | |
| | | | | | 844 | 20600 | 21.43 | 23 | 0-1 | | | |
| | | | | 12 | 829 | 20450 | 21.3 | 23 | 0-1 | | | |
| | | | | | | 836.5 | 20525 | 21.44 | 23 | 0-1 | | |
| | | | | | | 844 | 20600 | 21.51 | 23 | 0-1 | | |
| | | | 25 | 829 | 20450 | 21.34 | 23 | 0-1 | | | | |
| | | | | | 836.5 | 20525 | 21.42 | 23 | 0-1 | | | |
| | | | | | 844 | 20600 | 21.48 | 23 | 0-1 | | | |
| | | | | 50RB | 829 | 20450 | 21.39 | 23 | 0-1 | | | |
| | | | | | | 836.5 | 20525 | 21.35 | 23 | 0-1 | | |
| | | | | | | 844 | 20600 | 21.43 | 23 | 0-1 | | |
| | | | 16-QAM | | 1 RB | 0 | 829 | 20450 | 20.94 | 22 | 0-1 | |
| | | | | | | | | 836.5 | 20525 | 21.64 | 22 | 0-1 |
| | | | | | | | | 844 | 20600 | 21.29 | 22 | 0-1 |
| | | | | 25 | | | 829 | 20450 | 21.00 | 22 | 0-1 | |
| | | | | | | | | 836.5 | 20525 | 21.67 | 22 | 0-1 |
| | | | | | | | | 844 | 20600 | 21.61 | 22 | 0-1 |
| | 49 | 829 | | 20450 | | 20.97 | 22 | 0-1 | | | | |
| | | | | 836.5 | | 20525 | 21.71 | 22 | 0-1 | | | |
| | | | | 844 | | 20600 | 21.84 | 22 | 0-1 | | | |
| | | 25 RB | | 0 | | 829 | 20450 | 20.21 | 22 | 0-2 | | |
| | | | | | | | 836.5 | 20525 | 20.37 | 22 | 0-2 | |
| | | | | | | | 844 | 20600 | 20.42 | 22 | 0-2 | |
| | 12 | | | | | 829 | 20450 | 20.2 | 22 | 0-2 | | |
| | | | | | | | 836.5 | 20525 | 20.31 | 22 | 0-2 | |
| | | | | | | | 844 | 20600 | 20.29 | 22 | 0-2 | |
| | 25 | | | 829 | | 20450 | 20.24 | 22 | 0-2 | | | |
| | | | | | | 836.5 | 20525 | 20.45 | 22 | 0-2 | | |
| | | | | | | 844 | 20600 | 20.42 | 22 | 0-2 | | |
| | 50RB | 829 | | 20450 | 20.09 | 22 | 0-2 | | | | | |
| | | | | 836.5 | 20525 | 20.36 | 22 | 0-2 | | | | |
| | | | | 844 | 20600 | 20.28 | 22 | 0-2 | | | | |

Unless otherwise stated the results shown in this test report refer only to the sample(s) tested and such sample(s) are retained for 90 days only.

除非另有說明，此報告結果僅對測試之樣品負責，同時此樣品僅保留90天。本報告未經本公司書面許可，不可部份複製。

This document is issued by the Company subject to its General Conditions of Service printed overleaf, available on request or accessible at www.sgs.com/terms_and_conditions.htm and, for electronic format documents, subject to Terms and Conditions for Electronic Documents at www.sgs.com/terms_e-document.htm. Attention is drawn to the limitation of liability, indemnification and jurisdiction issues defined therein. Any holder of this document is advised that information contained hereon reflects the Company's findings at the time of its intervention only and within the limits of Client's instructions, if any. The Company's sole responsibility is to its Client and this document does not exonerate parties to a transaction from exercising all their rights and obligations under the transaction documents. This document cannot be reproduced except in full, without prior written approval of the Company. Any unauthorized alteration, forgery or falsification of the content or appearance of this document is unlawful and offenders may be prosecuted to the fullest extent of the law.

| FDD Band 5 | | | | | | | | | |
|------------|------------|---------|-----------|-----------------|---------|-----------------------|-------------------------------------|--------------------------|-----|
| BW(MHz) | Modulation | RB Size | RB Offset | Frequency (MHz) | Channel | Conducted power (dBm) | Target Power + Max. Tolerance (dBm) | MPR Allowed per 3GPP(dB) | |
| 5 | QPSK | 1 RB | 0 | 826.5 | 20425 | 22.32 | 23 | 0 | |
| | | | | 836.5 | 20525 | 22.34 | 23 | 0 | |
| | | | | 846.5 | 20625 | 22.32 | 23 | 0 | |
| | | | 12 | 826.5 | 20425 | 22.13 | 23 | 0 | |
| | | | | 836.5 | 20525 | 22.35 | 23 | 0 | |
| | | | | 846.5 | 20625 | 22.50 | 23 | 0 | |
| | | | 24 | 826.5 | 20425 | 22.35 | 23 | 0 | |
| | | | | 836.5 | 20525 | 22.33 | 23 | 0 | |
| | | | | 846.5 | 20625 | 22.32 | 23 | 0 | |
| | | 12 RB | 0 | 826.5 | 20425 | 21.26 | 23 | 0-1 | |
| | | | | 836.5 | 20525 | 21.47 | 23 | 0-1 | |
| | | | | 846.5 | 20625 | 21.39 | 23 | 0-1 | |
| | | | 6 | 826.5 | 20425 | 21.32 | 23 | 0-1 | |
| | | | | 836.5 | 20525 | 21.51 | 23 | 0-1 | |
| | | | | 846.5 | 20625 | 21.63 | 23 | 0-1 | |
| | | | 13 | 826.5 | 20425 | 21.24 | 23 | 0-1 | |
| | | | | 836.5 | 20525 | 21.44 | 23 | 0-1 | |
| | | | | 846.5 | 20625 | 21.47 | 23 | 0-1 | |
| | | | 25RB | | 826.5 | 20425 | 21.27 | 23 | 0-1 |
| | | | 25RB | | 836.5 | 20525 | 21.35 | 23 | 0-1 |
| | | | 25RB | | 846.5 | 20625 | 21.38 | 23 | 0-1 |
| | | 16-QAM | 1 RB | 0 | 826.5 | 20425 | 21.1 | 22 | 0-1 |
| | | | | | 836.5 | 20525 | 21.63 | 22 | 0-1 |
| | | | | | 846.5 | 20625 | 21.47 | 22 | 0-1 |
| | | | | 12 | 826.5 | 20425 | 21.13 | 22 | 0-1 |
| | | | | | 836.5 | 20525 | 21.6 | 22 | 0-1 |
| | | | | | 846.5 | 20625 | 21.07 | 22 | 0-1 |
| | 24 | | | 826.5 | 20425 | 21.51 | 22 | 0-1 | |
| | | | | 836.5 | 20525 | 21.23 | 22 | 0-1 | |
| | | | | 846.5 | 20625 | 21.57 | 22 | 0-1 | |
| | 12 RB | | | 0 | 826.5 | 20425 | 20.32 | 22 | 0-2 |
| | | | | | 836.5 | 20525 | 20.46 | 22 | 0-2 |
| | | | | | 846.5 | 20625 | 20.6 | 22 | 0-2 |
| | | | 6 | 826.5 | 20425 | 20.24 | 22 | 0-2 | |
| | | | | 836.5 | 20525 | 20.49 | 22 | 0-2 | |
| | | | | 846.5 | 20625 | 20.65 | 22 | 0-2 | |
| | | | 13 | 826.5 | 20425 | 20.4 | 22 | 0-2 | |
| | | | | 836.5 | 20525 | 20.39 | 22 | 0-2 | |
| | | | | 846.5 | 20625 | 20.43 | 22 | 0-2 | |
| | | | 25RB | | 826.5 | 20425 | 20.25 | 22 | 0-2 |
| | | | 25RB | | 836.5 | 20525 | 20.37 | 22 | 0-2 |
| | | | 25RB | | 846.5 | 20625 | 20.34 | 22 | 0-2 |

Unless otherwise stated the results shown in this test report refer only to the sample(s) tested and such sample(s) are retained for 90 days only.

除非另有說明，此報告結果僅對測試之樣品負責，同時此樣品僅保留90天。本報告未經本公司書面許可，不可部份複製。

This document is issued by the Company subject to its General Conditions of Service printed overleaf, available on request or accessible at www.sgs.com/terms_and_conditions.htm and, for electronic format documents, subject to Terms and Conditions for Electronic Documents at www.sgs.com/terms_e-document.htm. Attention is drawn to the limitation of liability, indemnification and jurisdiction issues defined therein. Any holder of this document is advised that information contained hereon reflects the Company's findings at the time of its intervention only and within the limits of Client's instructions, if any. The Company's sole responsibility is to its Client and this document does not exonerate parties to a transaction from exercising all their rights and obligations under the transaction documents. This document cannot be reproduced except in full, without prior written approval of the Company. Any unauthorized alteration, forgery or falsification of the content or appearance of this document is unlawful and offenders may be prosecuted to the fullest extent of the law.

| FDD Band 5 | | | | | | | | | |
|------------|------------|---------|-----------|-----------------|---------|-----------------------|-------------------------------------|--------------------------|-----|
| BW(Mhz) | Modulation | RB Size | RB Offset | Frequency (MHz) | Channel | Conducted power (dBm) | Target Power + Max. Tolerance (dBm) | MPR Allowed per 3GPP(dB) | |
| 3 | QPSK | 1 RB | 0 | 825.5 | 20415 | 22.08 | 23 | 0 | |
| | | | | 836.5 | 20525 | 22.3 | 23 | 0 | |
| | | | | 847.5 | 20635 | 22.33 | 23 | 0 | |
| | | | 7 | 825.5 | 20415 | 22.21 | 23 | 0 | |
| | | | | 836.5 | 20525 | 22.42 | 23 | 0 | |
| | | | | 847.5 | 20635 | 22.4 | 23 | 0 | |
| | | | 14 | 825.5 | 20415 | 22.27 | 23 | 0 | |
| | | | | 836.5 | 20525 | 22.45 | 23 | 0 | |
| | | | | 847.5 | 20635 | 22.3 | 23 | 0 | |
| | | 8 RB | 0 | 825.5 | 20415 | 21.35 | 23 | 0-1 | |
| | | | | 836.5 | 20525 | 21.43 | 23 | 0-1 | |
| | | | | 847.5 | 20635 | 21.46 | 23 | 0-1 | |
| | | | 4 | 825.5 | 20415 | 21.33 | 23 | 0-1 | |
| | | | | 836.5 | 20525 | 21.44 | 23 | 0-1 | |
| | | | | 847.5 | 20635 | 21.44 | 23 | 0-1 | |
| | | | 7 | 825.5 | 20415 | 21.28 | 23 | 0-1 | |
| | | | | 836.5 | 20525 | 21.42 | 23 | 0-1 | |
| | | | | 847.5 | 20635 | 21.42 | 23 | 0-1 | |
| | | 15RB | 825.5 | 20415 | 21.34 | 23 | 0-1 | | |
| | | | 836.5 | 20525 | 21.44 | 23 | 0-1 | | |
| | | | 847.5 | 20635 | 21.46 | 23 | 0-1 | | |
| | | 16-QAM | 1 RB | 0 | 825.5 | 20415 | 20.91 | 22 | 0-1 |
| | | | | | 836.5 | 20525 | 21.01 | 22 | 0-1 |
| | | | | | 847.5 | 20635 | 21.21 | 22 | 0-1 |
| | 7 | | | 825.5 | 20415 | 21.46 | 22 | 0-1 | |
| | | | | 836.5 | 20525 | 21.58 | 22 | 0-1 | |
| | | | | 847.5 | 20635 | 21.69 | 22 | 0-1 | |
| | 14 | | | 825.5 | 20415 | 21.23 | 22 | 0-1 | |
| | | | | 836.5 | 20525 | 21.59 | 22 | 0-1 | |
| | | | | 847.5 | 20635 | 21.29 | 22 | 0-1 | |
| | 8 RB | | | 0 | 825.5 | 20415 | 20.07 | 22 | 0-2 |
| | | | | | 836.5 | 20525 | 20.22 | 22 | 0-2 |
| | | | | | 847.5 | 20635 | 20.37 | 22 | 0-2 |
| | | | 4 | 825.5 | 20415 | 20.32 | 22 | 0-2 | |
| | | | | 836.5 | 20525 | 20.51 | 22 | 0-2 | |
| | | | | 847.5 | 20635 | 20.4 | 22 | 0-2 | |
| | | | 7 | 825.5 | 20415 | 20.21 | 22 | 0-2 | |
| | | | | 836.5 | 20525 | 20.31 | 22 | 0-2 | |
| | | | | 847.5 | 20635 | 20.4 | 22 | 0-2 | |
| | 15RB | | 825.5 | 20415 | 20.22 | 22 | 0-2 | | |
| | | | 836.5 | 20525 | 20.4 | 22 | 0-2 | | |
| | | | 847.5 | 20635 | 20.37 | 22 | 0-2 | | |

Unless otherwise stated the results shown in this test report refer only to the sample(s) tested and such sample(s) are retained for 90 days only.

除非另有說明，此報告結果僅對測試之樣品負責，同時此樣品僅保留90天。本報告未經本公司書面許可，不可部份複製。

This document is issued by the Company subject to its General Conditions of Service printed overleaf, available on request or accessible at www.sgs.com/terms_and_conditions.htm and, for electronic format documents, subject to Terms and Conditions for Electronic Documents at www.sgs.com/terms_e-document.htm. Attention is drawn to the limitation of liability, indemnification and jurisdiction issues defined therein. Any holder of this document is advised that information contained hereon reflects the Company's findings at the time of its intervention only and within the limits of Client's instructions, if any. The Company's sole responsibility is to its Client and this document does not exonerate parties to a transaction from exercising all their rights and obligations under the transaction documents. This document cannot be reproduced except in full, without prior written approval of the Company. Any unauthorized alteration, forgery or falsification of the content or appearance of this document is unlawful and offenders may be prosecuted to the fullest extent of the law.

| FDD Band 5 | | | | | | | | | |
|------------|------------|---------|-----------|-----------------|---------|-----------------------|-------------------------------------|--------------------------|-----|
| BW(Mhz) | Modulation | RB Size | RB Offset | Frequency (MHz) | Channel | Conducted power (dBm) | Target Power + Max. Tolerance (dBm) | MPR Allowed per 3GPP(dB) | |
| 1.4 | QPSK | 1 RB | 0 | 824.7 | 20407 | 22.17 | 23 | 0 | |
| | | | | 836.5 | 20525 | 22.39 | 23 | 0 | |
| | | | | 848.3 | 20643 | 22.14 | 23 | 0 | |
| | | | 2 | 824.7 | 20407 | 22.44 | 23 | 0 | |
| | | | | 836.5 | 20525 | 22.37 | 23 | 0 | |
| | | | | 848.3 | 20643 | 22.38 | 23 | 0 | |
| | | 5 | 824.7 | 20407 | 22.21 | 23 | 0 | | |
| | | | 836.5 | 20525 | 22.36 | 23 | 0 | | |
| | | | 848.3 | 20643 | 22.36 | 23 | 0 | | |
| | | 3 RB | 0 | 824.7 | 20407 | 22.46 | 23 | 0-1 | |
| | | | | 836.5 | 20525 | 22.59 | 23 | 0-1 | |
| | | | | 848.3 | 20643 | 22.45 | 23 | 0-1 | |
| | | | 2 | 824.7 | 20407 | 22.25 | 23 | 0-1 | |
| | | | | 836.5 | 20525 | 22.4 | 23 | 0-1 | |
| | | | | 848.3 | 20643 | 22.37 | 23 | 0-1 | |
| | | | 3 | 824.7 | 20407 | 22.18 | 23 | 0-1 | |
| | | | | 836.5 | 20525 | 22.32 | 23 | 0-1 | |
| | | | | 848.3 | 20643 | 22.4 | 23 | 0-1 | |
| | | 6RB | 824.7 | 20407 | 21.44 | 23 | 0-1 | | |
| | | | 836.5 | 20525 | 21.41 | 23 | 0-1 | | |
| | | | 848.3 | 20643 | 21.45 | 23 | 0-1 | | |
| | | 16-QAM | 1 RB | 0 | 824.7 | 20407 | 21.15 | 22 | 0-1 |
| | | | | | 836.5 | 20525 | 21.48 | 22 | 0-1 |
| | | | | | 848.3 | 20643 | 21.57 | 22 | 0-1 |
| | 2 | | | 824.7 | 20407 | 21.25 | 22 | 0-1 | |
| | | | | 836.5 | 20525 | 21.37 | 22 | 0-1 | |
| | | | | 848.3 | 20643 | 21.45 | 22 | 0-1 | |
| | 5 | | | 824.7 | 20407 | 21.27 | 22 | 0-1 | |
| | | | | 836.5 | 20525 | 21.34 | 22 | 0-1 | |
| | | | | 848.3 | 20643 | 21.67 | 22 | 0-1 | |
| | 3 RB | | | 0 | 824.7 | 20407 | 21.36 | 22 | 0-2 |
| | | | | | 836.5 | 20525 | 21.53 | 22 | 0-2 |
| | | | | | 848.3 | 20643 | 21.58 | 22 | 0-2 |
| | | | 2 | 824.7 | 20407 | 21.27 | 22 | 0-2 | |
| | | | | 836.5 | 20525 | 21.55 | 22 | 0-2 | |
| | | | | 848.3 | 20643 | 21.51 | 22 | 0-2 | |
| | | | 3 | 824.7 | 20407 | 21.5 | 22 | 0-2 | |
| | | | | 836.5 | 20525 | 21.55 | 22 | 0-2 | |
| | | | | 848.3 | 20643 | 21.55 | 22 | 0-2 | |
| | 6RB | | 824.7 | 20407 | 20.44 | 22 | 0-2 | | |
| | | | 836.5 | 20525 | 20.55 | 22 | 0-2 | | |
| | | | 848.3 | 20643 | 20.48 | 22 | 0-2 | | |

Unless otherwise stated the results shown in this test report refer only to the sample(s) tested and such sample(s) are retained for 90 days only.

除非另有說明，此報告結果僅對測試之樣品負責，同時此樣品僅保留90天。本報告未經本公司書面許可，不可部份複製。

This document is issued by the Company subject to its General Conditions of Service printed overleaf, available on request or accessible at www.sgs.com/terms_and_conditions.htm and, for electronic format documents, subject to Terms and Conditions for Electronic Documents at www.sgs.com/terms_e-document.htm. Attention is drawn to the limitation of liability, indemnification and jurisdiction issues defined therein. Any holder of this document is advised that information contained hereon reflects the Company's findings at the time of its intervention only and within the limits of Client's instructions, if any. The Company's sole responsibility is to its Client and this document does not exonerate parties to a transaction from exercising all their rights and obligations under the transaction documents. This document cannot be reproduced except in full, without prior written approval of the Company. Any unauthorized alteration, forgery or falsification of the content or appearance of this document is unlawful and offenders may be prosecuted to the fullest extent of the law.

| FDD Band 13 | | | | | | | | | |
|-------------|------------|---------|-----------|-----------------|---------|-----------------------|-------------------------------------|--------------------------|-----|
| BW(Mhz) | Modulation | RB Size | RB Offset | Frequency (MHz) | Channel | Conducted power (dBm) | Target Power + Max. Tolerance (dBm) | MPR Allowed per 3GPP(dB) | |
| 10 | QPSK | 1 RB | 0 | 782 | 23230 | 22.23 | 23 | 0 | |
| | | | 25 | 782 | 23230 | 22.66 | 23 | 0 | |
| | | | 49 | 782 | 23230 | 22.18 | 23 | 0 | |
| | | 25 RB | 0 | 782 | 23230 | 21.41 | 23 | 0-1 | |
| | | | 12 | 782 | 23230 | 21.76 | 23 | 0-1 | |
| | | | 25 | 782 | 23230 | 21.69 | 23 | 0-1 | |
| | | 50RB | 782 | 23230 | 21.43 | 23 | 0-1 | | |
| | | 16-QAM | 1 RB | 0 | 782 | 23230 | 21.37 | 22 | 0-1 |
| | | | | 25 | 782 | 23230 | 21.5 | 22 | 0-1 |
| | 49 | | | 782 | 23230 | 21.3 | 22 | 0-1 | |
| | 25 RB | | 0 | 782 | 23230 | 20.31 | 22 | 0-2 | |
| | | | 12 | 782 | 23230 | 20.76 | 22 | 0-2 | |
| | | | 25 | 782 | 23230 | 20.63 | 22 | 0-2 | |
| | 50RB | 782 | 23230 | 20.43 | 22 | 0-2 | | | |

Unless otherwise stated the results shown in this test report refer only to the sample(s) tested and such sample(s) are retained for 90 days only.

除非另有說明，此報告結果僅對測試之樣品負責，同時此樣品僅保留90天。本報告未經本公司書面許可，不可部份複製。

This document is issued by the Company subject to its General Conditions of Service printed overleaf, available on request or accessible at www.sgs.com/terms_and_conditions.htm and, for electronic format documents, subject to Terms and Conditions for Electronic Documents at www.sgs.com/terms_e-document.htm. Attention is drawn to the limitation of liability, indemnification and jurisdiction issues defined therein. Any holder of this document is advised that information contained hereon reflects the Company's findings at the time of its intervention only and within the limits of Client's instructions, if any. The Company's sole responsibility is to its Client and this document does not exonerate parties to a transaction from exercising all their rights and obligations under the transaction documents. This document cannot be reproduced except in full, without prior written approval of the Company. Any unauthorized alteration, forgery or falsification of the content or appearance of this document is unlawful and offenders may be prosecuted to the fullest extent of the law.

| FDD Band 13 | | | | | | | | | |
|-------------|------------|---------|-----------|-----------------|---------|-----------------------|-------------------------------------|--------------------------|-----|
| BW(MHz) | Modulation | RB Size | RB Offset | Frequency (MHz) | Channel | Conducted power (dBm) | Target Power + Max. Tolerance (dBm) | MPR Allowed per 3GPP(dB) | |
| 5 | QPSK | 1 RB | 0 | 779.5 | 23205 | 22.26 | 23 | 0 | |
| | | | | 782 | 23230 | 22.56 | 23 | 0 | |
| | | | | 784.5 | 23255 | 22.61 | 23 | 0 | |
| | | | 12 | 779.5 | 23205 | 22.33 | 23 | 0 | |
| | | | | 782 | 23230 | 22.55 | 23 | 0 | |
| | | | | 784.5 | 23255 | 22.36 | 23 | 0 | |
| | | | 24 | 779.5 | 23205 | 22.53 | 23 | 0 | |
| | | | | 782 | 23230 | 22.42 | 23 | 0 | |
| | | | | 784.5 | 23255 | 22.21 | 23 | 0 | |
| | | 12 RB | 0 | 779.5 | 23205 | 21.43 | 23 | 0-1 | |
| | | | | 782 | 23230 | 21.47 | 23 | 0-1 | |
| | | | | 784.5 | 23255 | 21.68 | 23 | 0-1 | |
| | | | 6 | 779.5 | 23205 | 21.42 | 23 | 0-1 | |
| | | | | 782 | 23230 | 21.58 | 23 | 0-1 | |
| | | | | 784.5 | 23255 | 21.47 | 23 | 0-1 | |
| | | | 13 | 779.5 | 23205 | 21.56 | 23 | 0-1 | |
| | | | | 782 | 23230 | 21.61 | 23 | 0-1 | |
| | | | | 784.5 | 23255 | 21.27 | 23 | 0-1 | |
| | | 25RB | 779.5 | 23205 | 21.4 | 23 | 0-1 | | |
| | | | 782 | 23230 | 21.61 | 23 | 0-1 | | |
| | | | 784.5 | 23255 | 21.49 | 23 | 0-1 | | |
| | | 16-QAM | 1 RB | 0 | 779.5 | 23205 | 21.12 | 22 | 0-1 |
| | | | | | 782 | 23230 | 21.5 | 22 | 0-1 |
| | | | | | 784.5 | 23255 | 21.91 | 22 | 0-1 |
| | 12 | | | 779.5 | 23205 | 21.31 | 22 | 0-1 | |
| | | | | 782 | 23230 | 21.55 | 22 | 0-1 | |
| | | | | 784.5 | 23255 | 21.37 | 22 | 0-1 | |
| | 24 | | | 779.5 | 23205 | 21.77 | 22 | 0-1 | |
| | | | | 782 | 23230 | 21.22 | 22 | 0-1 | |
| | | | | 784.5 | 23255 | 21.01 | 22 | 0-1 | |
| | 12 RB | | 0 | 779.5 | 23205 | 20.41 | 22 | 0-2 | |
| | | | | 782 | 23230 | 20.51 | 22 | 0-2 | |
| | | | | 784.5 | 23255 | 20.69 | 22 | 0-2 | |
| | | | 6 | 779.5 | 23205 | 20.35 | 22 | 0-2 | |
| | | | | 782 | 23230 | 20.62 | 22 | 0-2 | |
| | | | | 784.5 | 23255 | 20.56 | 22 | 0-2 | |
| | | | 13 | 779.5 | 23205 | 20.52 | 22 | 0-2 | |
| | | | | 782 | 23230 | 20.54 | 22 | 0-2 | |
| | | | | 784.5 | 23255 | 20.25 | 22 | 0-2 | |
| | 25RB | | 779.5 | 23205 | 20.39 | 22 | 0-2 | | |
| | | | 782 | 23230 | 20.53 | 22 | 0-2 | | |
| | | | 784.5 | 23255 | 20.54 | 22 | 0-2 | | |

Unless otherwise stated the results shown in this test report refer only to the sample(s) tested and such sample(s) are retained for 90 days only.

除非另有說明，此報告結果僅對測試之樣品負責，同時此樣品僅保留90天。本報告未經本公司書面許可，不可部份複製。

This document is issued by the Company subject to its General Conditions of Service printed overleaf, available on request or accessible at www.sgs.com/terms_and_conditions.htm and, for electronic format documents, subject to Terms and Conditions for Electronic Documents at www.sgs.com/terms_e-document.htm. Attention is drawn to the limitation of liability, indemnification and jurisdiction issues defined therein. Any holder of this document is advised that information contained hereon reflects the Company's findings at the time of its intervention only and within the limits of Client's instructions, if any. The Company's sole responsibility is to its Client and this document does not exonerate parties to a transaction from exercising all their rights and obligations under the transaction documents. This document cannot be reproduced except in full, without prior written approval of the Company. Any unauthorized alteration, forgery or falsification of the content or appearance of this document is unlawful and offenders may be prosecuted to the fullest extent of the law.

| FDD Band 17 | | | | | | | | | |
|-------------|------------|---------|-----------|-----------------|---------|-----------------------|-------------------------------------|--------------------------|-----|
| BW(Mhz) | Modulation | RB Size | RB Offset | Frequency (MHz) | Channel | Conducted power (dBm) | Target Power + Max. Tolerance (dBm) | MPR Allowed per 3GPP(dB) | |
| 10 | QPSK | 1 RB | 0 | 709 | 23780 | 22.31 | 23 | 0 | |
| | | | | 710 | 23790 | 22.3 | 23 | 0 | |
| | | | | 711 | 23800 | 22.57 | 23 | 0 | |
| | | | 25 | 709 | 23780 | 22.77 | 23 | 0 | |
| | | | | 710 | 23790 | 22.55 | 23 | 0 | |
| | | | | 711 | 23800 | 22.87 | 23 | 0 | |
| | | | 49 | 709 | 23780 | 22.22 | 23 | 0 | |
| | | | | 710 | 23790 | 22.46 | 23 | 0 | |
| | | | | 711 | 23800 | 22.19 | 23 | 0 | |
| | | 25 RB | 0 | 709 | 23780 | 21.61 | 23 | 0-1 | |
| | | | | 710 | 23790 | 21.62 | 23 | 0-1 | |
| | | | | 711 | 23800 | 21.67 | 23 | 0-1 | |
| | | | 12 | 709 | 23780 | 21.6 | 23 | 0-1 | |
| | | | | 710 | 23790 | 21.66 | 23 | 0-1 | |
| | | | | 711 | 23800 | 21.52 | 23 | 0-1 | |
| | | | 25 | 709 | 23780 | 21.57 | 23 | 0-1 | |
| | | | | 710 | 23790 | 21.36 | 23 | 0-1 | |
| | | | | 711 | 23800 | 21.55 | 23 | 0-1 | |
| | | | 50RB | 709 | 23780 | 21.53 | 23 | 0-1 | |
| | | | | 710 | 23790 | 21.43 | 23 | 0-1 | |
| | | | | 711 | 23800 | 21.43 | 23 | 0-1 | |
| | | 16-QAM | 1 RB | 0 | 709 | 23780 | 21.35 | 22 | 0-1 |
| | | | | | 710 | 23790 | 21.79 | 22 | 0-1 |
| | | | | | 711 | 23800 | 21.53 | 22 | 0-1 |
| | | | | 25 | 709 | 23780 | 21.69 | 22 | 0-1 |
| | | | | | 710 | 23790 | 21.83 | 22 | 0-1 |
| | | | | | 711 | 23800 | 21.63 | 22 | 0-1 |
| | 49 | | | 709 | 23780 | 21.32 | 22 | 0-1 | |
| | | | | 710 | 23790 | 20.93 | 22 | 0-1 | |
| | | | | 711 | 23800 | 21.32 | 22 | 0-1 | |
| | 25 RB | | 0 | 709 | 23780 | 20.67 | 22 | 0-2 | |
| | | | | 710 | 23790 | 20.59 | 22 | 0-2 | |
| | | | | 711 | 23800 | 20.66 | 22 | 0-2 | |
| | | | 12 | 709 | 23780 | 20.59 | 22 | 0-2 | |
| | | | | 710 | 23790 | 20.7 | 22 | 0-2 | |
| | | | | 711 | 23800 | 20.47 | 22 | 0-2 | |
| | | | 25 | 709 | 23780 | 20.64 | 22 | 0-2 | |
| | | | | 710 | 23790 | 20.26 | 22 | 0-2 | |
| | | | | 711 | 23800 | 20.5 | 22 | 0-2 | |
| | | | 50RB | 709 | 23780 | 20.51 | 22 | 0-2 | |
| | | | | 710 | 23790 | 20.44 | 22 | 0-2 | |
| | | | | 711 | 23800 | 20.37 | 22 | 0-2 | |

Unless otherwise stated the results shown in this test report refer only to the sample(s) tested and such sample(s) are retained for 90 days only.

除非另有說明，此報告結果僅對測試之樣品負責，同時此樣品僅保留90天。本報告未經本公司書面許可，不可部份複製。

This document is issued by the Company subject to its General Conditions of Service printed overleaf, available on request or accessible at www.sgs.com/terms_and_conditions.htm and, for electronic format documents, subject to Terms and Conditions for Electronic Documents at www.sgs.com/terms_e-document.htm. Attention is drawn to the limitation of liability, indemnification and jurisdiction issues defined therein. Any holder of this document is advised that information contained hereon reflects the Company's findings at the time of its intervention only and within the limits of Client's instructions, if any. The Company's sole responsibility is to its Client and this document does not exonerate parties to a transaction from exercising all their rights and obligations under the transaction documents. This document cannot be reproduced except in full, without prior written approval of the Company. Any unauthorized alteration, forgery or falsification of the content or appearance of this document is unlawful and offenders may be prosecuted to the fullest extent of the law.

| FDD Band 17 | | | | | | | | | |
|-------------|------------|---------|-----------|-----------------|---------|-----------------------|-------------------------------------|--------------------------|-----|
| BW(Mhz) | Modulation | RB Size | RB Offset | Frequency (MHz) | Channel | Conducted power (dBm) | Target Power + Max. Tolerance (dBm) | MPR Allowed per 3GPP(dB) | |
| 5 | QPSK | 1 RB | 0 | 706.5 | 23755 | 22.04 | 23 | 0 | |
| | | | | 710 | 23790 | 22.63 | 23 | 0 | |
| | | | | 713.5 | 23825 | 22.54 | 23 | 0 | |
| | | | 12 | 706.5 | 23755 | 22.51 | 23 | 0 | |
| | | | | 710 | 23790 | 22.88 | 23 | 0 | |
| | | | | 713.5 | 23825 | 22.34 | 23 | 0 | |
| | | | 24 | 706.5 | 23755 | 22.9 | 23 | 0 | |
| | | | | 710 | 23790 | 22.38 | 23 | 0 | |
| | | | | 713.5 | 23825 | 22.1 | 23 | 0 | |
| | | 12 RB | 0 | 706.5 | 23755 | 21.39 | 23 | 0-1 | |
| | | | | 710 | 23790 | 21.71 | 23 | 0-1 | |
| | | | | 713.5 | 23825 | 21.51 | 23 | 0-1 | |
| | | | 6 | 706.5 | 23755 | 21.54 | 23 | 0-1 | |
| | | | | 710 | 23790 | 21.79 | 23 | 0-1 | |
| | | | | 713.5 | 23825 | 21.51 | 23 | 0-1 | |
| | | | 13 | 706.5 | 23755 | 21.73 | 23 | 0-1 | |
| | | | | 710 | 23790 | 21.66 | 23 | 0-1 | |
| | | | | 713.5 | 23825 | 21.28 | 23 | 0-1 | |
| | | 25RB | 706.5 | 23755 | 21.5 | 23 | 0-1 | | |
| | | | 710 | 23790 | 21.47 | 23 | 0-1 | | |
| | | | 713.5 | 23825 | 21.36 | 23 | 0-1 | | |
| | | 16-QAM | 1 RB | 0 | 706.5 | 23755 | 21.35 | 22 | 0-1 |
| | | | | | 710 | 23790 | 21.52 | 22 | 0-1 |
| | | | | | 713.5 | 23825 | 21.59 | 22 | 0-1 |
| | | | | 12 | 706.5 | 23755 | 21.64 | 22 | 0-1 |
| | | | | | 710 | 23790 | 21.21 | 22 | 0-1 |
| | | | | | 713.5 | 23825 | 21.11 | 22 | 0-1 |
| | 24 | | | 706.5 | 23755 | 21.5 | 22 | 0-1 | |
| | | | | 710 | 23790 | 21.36 | 22 | 0-1 | |
| | | | | 713.5 | 23825 | 21.09 | 22 | 0-1 | |
| | 12 RB | | | 0 | 706.5 | 23755 | 20.41 | 22 | 0-2 |
| | | | | | 710 | 23790 | 20.75 | 22 | 0-2 |
| | | | | | 713.5 | 23825 | 20.47 | 22 | 0-2 |
| | | | 6 | 706.5 | 23755 | 20.52 | 22 | 0-2 | |
| | | | | 710 | 23790 | 20.55 | 22 | 0-2 | |
| | | | | 713.5 | 23825 | 20.5 | 22 | 0-2 | |
| | | | 13 | 706.5 | 23755 | 20.72 | 22 | 0-2 | |
| | | | | 710 | 23790 | 20.72 | 22 | 0-2 | |
| | | | | 713.5 | 23825 | 20.2 | 22 | 0-2 | |
| | | | 25RB | 706.5 | 23755 | 20.53 | 22 | 0-2 | |
| | | | | 710 | 23790 | 20.77 | 22 | 0-2 | |
| | | | | 713.5 | 23825 | 20.37 | 22 | 0-2 | |

Unless otherwise stated the results shown in this test report refer only to the sample(s) tested and such sample(s) are retained for 90 days only.

除非另有說明，此報告結果僅對測試之樣品負責，同時此樣品僅保留90天。本報告未經本公司書面許可，不可部份複製。

This document is issued by the Company subject to its General Conditions of Service printed overleaf, available on request or accessible at www.sgs.com/terms_and_conditions.htm and, for electronic format documents, subject to Terms and Conditions for Electronic Documents at www.sgs.com/terms_e-document.htm. Attention is drawn to the limitation of liability, indemnification and jurisdiction issues defined therein. Any holder of this document is advised that information contained hereon reflects the Company's findings at the time of its intervention only and within the limits of Client's instructions, if any. The Company's sole responsibility is to its Client and this document does not exonerate parties to a transaction from exercising all their rights and obligations under the transaction documents. This document cannot be reproduced except in full, without prior written approval of the Company. Any unauthorized alteration, forgery or falsification of the content or appearance of this document is unlawful and offenders may be prosecuted to the fullest extent of the law.

| FDD Band 25 | | | | | | | | | |
|-------------|------------|---------|-----------|-----------------|---------|-----------------------|-------------------------------------|--------------------------|-----|
| BW(Mhz) | Modulation | RB Size | RB Offset | Frequency (MHz) | Channel | Conducted power (dBm) | Target Power + Max. Tolerance (dBm) | MPR Allowed per 3GPP(dB) | |
| 20 | QPSK | 1 RB | 0 | 1860 | 26140 | 21.92 | 22 | 0 | |
| | | | | 1882.5 | 26365 | 21.72 | 22 | 0 | |
| | | | | 1905 | 26590 | 21.68 | 22 | 0 | |
| | | | 50 | 0 | 1860 | 26140 | 21.90 | 22 | 0 |
| | | | | | 1882.5 | 26365 | 21.70 | 22 | 0 |
| | | | | | 1905 | 26590 | 21.66 | 22 | 0 |
| | | | 99 | 0 | 1860 | 26140 | 21.81 | 22 | 0 |
| | | | | | 1882.5 | 26365 | 21.69 | 22 | 0 |
| | | | | | 1905 | 26590 | 21.70 | 22 | 0 |
| | | 50 RB | 0 | 0 | 1860 | 26140 | 21.88 | 22 | 0-1 |
| | | | | | 1882.5 | 26365 | 21.74 | 22 | 0-1 |
| | | | | | 1905 | 26590 | 21.62 | 22 | 0-1 |
| | | | 25 | 0 | 1860 | 26140 | 21.68 | 22 | 0-1 |
| | | | | | 1882.5 | 26365 | 21.76 | 22 | 0-1 |
| | | | | | 1905 | 26590 | 21.72 | 22 | 0-1 |
| | | | 50 | 0 | 1860 | 26140 | 21.91 | 22 | 0-1 |
| | | | | | 1882.5 | 26365 | 21.73 | 22 | 0-1 |
| | | | | | 1905 | 26590 | 21.93 | 22 | 0-1 |
| | | 100RB | 0 | 1860 | 26140 | 21.71 | 22 | 0-1 | |
| | | | | 1882.5 | 26365 | 21.70 | 22 | 0-1 | |
| | | | | 1905 | 26590 | 21.73 | 22 | 0-1 | |
| | | 16-QAM | 1 RB | 0 | 1860 | 26140 | 20.88 | 22 | 0-1 |
| | | | | | 1882.5 | 26365 | 20.63 | 22 | 0-1 |
| | | | | | 1905 | 26590 | 20.67 | 22 | 0-1 |
| | 50 | | | 0 | 1860 | 26140 | 20.81 | 22 | 0-1 |
| | | | | | 1882.5 | 26365 | 20.64 | 22 | 0-1 |
| | | | | | 1905 | 26590 | 20.62 | 22 | 0-1 |
| | 99 | | | 0 | 1860 | 26140 | 20.78 | 22 | 0-1 |
| | | | | | 1882.5 | 26365 | 20.66 | 22 | 0-1 |
| | | | | | 1905 | 26590 | 20.64 | 22 | 0-1 |
| | 50 RB | | 0 | 0 | 1860 | 26140 | 20.83 | 22 | 0-2 |
| | | | | | 1882.5 | 26365 | 20.68 | 22 | 0-2 |
| | | | | | 1905 | 26590 | 20.53 | 22 | 0-2 |
| | | | 25 | 0 | 1860 | 26140 | 20.59 | 22 | 0-2 |
| | | | | | 1882.5 | 26365 | 20.74 | 22 | 0-2 |
| | | | | | 1905 | 26590 | 20.69 | 22 | 0-2 |
| | | | 50 | 0 | 1860 | 26140 | 20.90 | 22 | 0-2 |
| | | | | | 1882.5 | 26365 | 20.64 | 22 | 0-2 |
| | | | | | 1905 | 26590 | 20.84 | 22 | 0-2 |
| | 100RB | | 0 | 1860 | 26140 | 20.70 | 22 | 0-2 | |
| | | | | 1882.5 | 26365 | 20.66 | 22 | 0-2 | |
| | | | | 1905 | 26590 | 20.72 | 22 | 0-2 | |

Unless otherwise stated the results shown in this test report refer only to the sample(s) tested and such sample(s) are retained for 90 days only.

除非另有說明，此報告結果僅對測試之樣品負責，同時此樣品僅保留90天。本報告未經本公司書面許可，不可部份複製。

This document is issued by the Company subject to its General Conditions of Service printed overleaf, available on request or accessible at www.sgs.com/terms_and_conditions.htm and, for electronic format documents, subject to Terms and Conditions for Electronic Documents at www.sgs.com/terms_e-document.htm. Attention is drawn to the limitation of liability, indemnification and jurisdiction issues defined therein. Any holder of this document is advised that information contained hereon reflects the Company's findings at the time of its intervention only and within the limits of Client's instructions, if any. The Company's sole responsibility is to its Client and this document does not exonerate parties to a transaction from exercising all their rights and obligations under the transaction documents. This document cannot be reproduced except in full, without prior written approval of the Company. Any unauthorized alteration, forgery or falsification of the content or appearance of this document is unlawful and offenders may be prosecuted to the fullest extent of the law.

| FDD Band 25 | | | | | | | | | |
|-------------|------------|---------|-----------|-----------------|---------|-----------------------|-------------------------------------|--------------------------|-----|
| BW(Mhz) | Modulation | RB Size | RB Offset | Frequency (MHz) | Channel | Conducted power (dBm) | Target Power + Max. Tolerance (dBm) | MPR Allowed per 3GPP(dB) | |
| 15 | QPSK | 1 RB | 0 | 1857.5 | 26115 | 21.88 | 22 | 0 | |
| | | | | 1882.5 | 26365 | 21.70 | 22 | 0 | |
| | | | | 1907.5 | 26615 | 21.62 | 22 | 0 | |
| | | | 36 | 1857.5 | 26115 | 21.82 | 22 | 0 | |
| | | | | 1882.5 | 26365 | 21.65 | 22 | 0 | |
| | | | | 1907.5 | 26615 | 21.62 | 22 | 0 | |
| | | 74 | 1857.5 | 26115 | 21.79 | 22 | 0 | | |
| | | | 1882.5 | 26365 | 21.63 | 22 | 0 | | |
| | | | 1907.5 | 26615 | 21.63 | 22 | 0 | | |
| | | 36 RB | 0 | 1857.5 | 26115 | 21.79 | 22 | 0-1 | |
| | | | | 1882.5 | 26365 | 21.65 | 22 | 0-1 | |
| | | | | 1907.5 | 26615 | 21.57 | 22 | 0-1 | |
| | | | 18 | 1857.5 | 26115 | 21.65 | 22 | 0-1 | |
| | | | | 1882.5 | 26365 | 21.70 | 22 | 0-1 | |
| | | | | 1907.5 | 26615 | 21.68 | 22 | 0-1 | |
| | | | 37 | 1857.5 | 26115 | 21.83 | 22 | 0-1 | |
| | | | | 1882.5 | 26365 | 21.68 | 22 | 0-1 | |
| | | | | 1907.5 | 26615 | 21.84 | 22 | 0-1 | |
| | | | 75RB | 1857.5 | 26115 | 21.64 | 22 | 0-1 | |
| | | | | 1882.5 | 26365 | 21.66 | 22 | 0-1 | |
| | | | | 1907.5 | 26615 | 21.68 | 22 | 0-1 | |
| | | 16-QAM | 1 RB | 0 | 1857.5 | 26115 | 20.80 | 22 | 0-1 |
| | | | | | 1882.5 | 26365 | 20.55 | 22 | 0-1 |
| | | | | | 1907.5 | 26615 | 20.62 | 22 | 0-1 |
| | 36 | | | 1857.5 | 26115 | 20.78 | 22 | 0-1 | |
| | | | | 1882.5 | 26365 | 20.57 | 22 | 0-1 | |
| | | | | 1907.5 | 26615 | 20.55 | 22 | 0-1 | |
| | 74 | | | 1857.5 | 26115 | 20.74 | 22 | 0-1 | |
| | | | | 1882.5 | 26365 | 20.63 | 22 | 0-1 | |
| | | | | 1907.5 | 26615 | 20.61 | 22 | 0-1 | |
| | 36 RB | | | 0 | 1857.5 | 26115 | 20.77 | 22 | 0-2 |
| | | | | | 1882.5 | 26365 | 20.63 | 22 | 0-2 |
| | | | | | 1907.5 | 26615 | 20.43 | 22 | 0-2 |
| | | | 18 | 1857.5 | 26115 | 20.58 | 22 | 0-2 | |
| | | | | 1882.5 | 26365 | 20.65 | 22 | 0-2 | |
| | | | | 1907.5 | 26615 | 20.64 | 22 | 0-2 | |
| | | | 37 | 1857.5 | 26115 | 20.86 | 22 | 0-2 | |
| | | | | 1882.5 | 26365 | 20.63 | 22 | 0-2 | |
| | | | | 1907.5 | 26615 | 20.76 | 22 | 0-2 | |
| | 75RB | | 1857.5 | 26115 | 20.66 | 22 | 0-2 | | |
| | | | 1882.5 | 26365 | 20.60 | 22 | 0-2 | | |
| | | | 1907.5 | 26615 | 20.65 | 22 | 0-2 | | |

Unless otherwise stated the results shown in this test report refer only to the sample(s) tested and such sample(s) are retained for 90 days only.

除非另有說明，此報告結果僅對測試之樣品負責，同時此樣品僅保留90天。本報告未經本公司書面許可，不可部份複製。

This document is issued by the Company subject to its General Conditions of Service printed overleaf, available on request or accessible at www.sgs.com/terms_and_conditions.htm and, for electronic format documents, subject to Terms and Conditions for Electronic Documents at www.sgs.com/terms_e-document.htm. Attention is drawn to the limitation of liability, indemnification and jurisdiction issues defined therein. Any holder of this document is advised that information contained hereon reflects the Company's findings at the time of its intervention only and within the limits of Client's instructions, if any. The Company's sole responsibility is to its Client and this document does not exonerate parties to a transaction from exercising all their rights and obligations under the transaction documents. This document cannot be reproduced except in full, without prior written approval of the Company. Any unauthorized alteration, forgery or falsification of the content or appearance of this document is unlawful and offenders may be prosecuted to the fullest extent of the law.

| FDD Band 25 | | | | | | | | | |
|-------------|------------|---------|-----------|-----------------|---------|-----------------------|-------------------------------------|--------------------------|-----|
| BW(Mhz) | Modulation | RB Size | RB Offset | Frequency (MHz) | Channel | Conducted power (dBm) | Target Power + Max. Tolerance (dBm) | MPR Allowed per 3GPP(dB) | |
| 10 | QPSK | 1 RB | 0 | 1855 | 26090 | 21.88 | 22 | 0 | |
| | | | | 1882.5 | 26365 | 21.66 | 22 | 0 | |
| | | | | 1910 | 26640 | 21.55 | 22 | 0 | |
| | | | 25 | 1855 | 26090 | 21.81 | 22 | 0 | |
| | | | | 1882.5 | 26365 | 21.55 | 22 | 0 | |
| | | | | 1910 | 26640 | 21.60 | 22 | 0 | |
| | | | 49 | 1855 | 26090 | 21.78 | 22 | 0 | |
| | | | | 1882.5 | 26365 | 21.55 | 22 | 0 | |
| | | | | 1910 | 26640 | 21.55 | 22 | 0 | |
| | | 25 RB | 0 | 1855 | 26090 | 21.69 | 22 | 0-1 | |
| | | | | 1882.5 | 26365 | 21.56 | 22 | 0-1 | |
| | | | | 1910 | 26640 | 21.54 | 22 | 0-1 | |
| | | | 12 | 1855 | 26090 | 21.62 | 22 | 0-1 | |
| | | | | 1882.5 | 26365 | 21.69 | 22 | 0-1 | |
| | | | | 1910 | 26640 | 21.59 | 22 | 0-1 | |
| | | | 25 | 1855 | 26090 | 21.80 | 22 | 0-1 | |
| | | | | 1882.5 | 26365 | 21.60 | 22 | 0-1 | |
| | | | | 1910 | 26640 | 21.79 | 22 | 0-1 | |
| | | | 50RB | 1855 | 26090 | 21.58 | 22 | 0-1 | |
| | | | | 1882.5 | 26365 | 21.63 | 22 | 0-1 | |
| | | | | 1910 | 26640 | 21.68 | 22 | 0-1 | |
| | | 16-QAM | 1 RB | 0 | 1855 | 26090 | 20.70 | 22 | 0-1 |
| | | | | | 1882.5 | 26365 | 20.52 | 22 | 0-1 |
| | | | | | 1910 | 26640 | 20.54 | 22 | 0-1 |
| | 25 | | | 1855 | 26090 | 20.74 | 22 | 0-1 | |
| | | | | 1882.5 | 26365 | 20.49 | 22 | 0-1 | |
| | | | | 1910 | 26640 | 20.54 | 22 | 0-1 | |
| | 49 | | | 1855 | 26090 | 20.68 | 22 | 0-1 | |
| | | | | 1882.5 | 26365 | 20.53 | 22 | 0-1 | |
| | | | | 1910 | 26640 | 20.54 | 22 | 0-1 | |
| | 25 RB | | | 0 | 1855 | 26090 | 20.77 | 22 | 0-2 |
| | | | | | 1882.5 | 26365 | 20.58 | 22 | 0-2 |
| | | | | | 1910 | 26640 | 20.41 | 22 | 0-2 |
| | | | 12 | 1855 | 26090 | 20.51 | 22 | 0-2 | |
| | | | | 1882.5 | 26365 | 20.60 | 22 | 0-2 | |
| | | | | 1910 | 26640 | 20.60 | 22 | 0-2 | |
| | | | 25 | 1855 | 26090 | 20.80 | 22 | 0-2 | |
| | | | | 1882.5 | 26365 | 20.62 | 22 | 0-2 | |
| | | | | 1910 | 26640 | 20.74 | 22 | 0-2 | |
| | 50RB | | 1855 | 26090 | 20.66 | 22 | 0-2 | | |
| | | | 1882.5 | 26365 | 20.50 | 22 | 0-2 | | |
| | | | 1910 | 26640 | 20.59 | 22 | 0-2 | | |

Unless otherwise stated the results shown in this test report refer only to the sample(s) tested and such sample(s) are retained for 90 days only.

除非另有說明，此報告結果僅對測試之樣品負責，同時此樣品僅保留90天。本報告未經本公司書面許可，不可部份複製。

This document is issued by the Company subject to its General Conditions of Service printed overleaf, available on request or accessible at www.sgs.com/terms_and_conditions.htm and, for electronic format documents, subject to Terms and Conditions for Electronic Documents at www.sgs.com/terms_e-document.htm. Attention is drawn to the limitation of liability, indemnification and jurisdiction issues defined therein. Any holder of this document is advised that information contained hereon reflects the Company's findings at the time of its intervention only and within the limits of Client's instructions, if any. The Company's sole responsibility is to its Client and this document does not exonerate parties to a transaction from exercising all their rights and obligations under the transaction documents. This document cannot be reproduced except in full, without prior written approval of the Company. Any unauthorized alteration, forgery or falsification of the content or appearance of this document is unlawful and offenders may be prosecuted to the fullest extent of the law.

| FDD Band 25 | | | | | | | | | |
|-------------|------------|---------|-----------|-----------------|---------|-----------------------|-------------------------------------|--------------------------|-----|
| BW(Mhz) | Modulation | RB Size | RB Offset | Frequency (MHz) | Channel | Conducted power (dBm) | Target Power + Max. Tolerance (dBm) | MPR Allowed per 3GPP(dB) | |
| 5 | QPSK | 1 RB | 0 | 1852.5 | 26065 | 21.81 | 22 | 0 | |
| | | | | 1882.5 | 26365 | 21.58 | 22 | 0 | |
| | | | | 1912.5 | 26665 | 21.50 | 22 | 0 | |
| | | | 12 | 1852.5 | 26065 | 21.77 | 22 | 0 | |
| | | | | 1882.5 | 26365 | 21.53 | 22 | 0 | |
| | | | | 1912.5 | 26665 | 21.51 | 22 | 0 | |
| | | | 24 | 1852.5 | 26065 | 21.71 | 22 | 0 | |
| | | | | 1882.5 | 26365 | 21.46 | 22 | 0 | |
| | | | | 1912.5 | 26665 | 21.46 | 22 | 0 | |
| | | 12 RB | 0 | 1852.5 | 26065 | 21.63 | 22 | 0-1 | |
| | | | | 1882.5 | 26365 | 21.53 | 22 | 0-1 | |
| | | | | 1912.5 | 26665 | 21.52 | 22 | 0-1 | |
| | | | 6 | 1852.5 | 26065 | 21.60 | 22 | 0-1 | |
| | | | | 1882.5 | 26365 | 21.61 | 22 | 0-1 | |
| | | | | 1912.5 | 26665 | 21.53 | 22 | 0-1 | |
| | | | 13 | 1852.5 | 26065 | 21.76 | 22 | 0-1 | |
| | | | | 1882.5 | 26365 | 21.57 | 22 | 0-1 | |
| | | | | 1912.5 | 26665 | 21.70 | 22 | 0-1 | |
| | | 25RB | 1852.5 | 26065 | 21.50 | 22 | 0-1 | | |
| | | | 1882.5 | 26365 | 21.58 | 22 | 0-1 | | |
| | | | 1912.5 | 26665 | 21.63 | 22 | 0-1 | | |
| | | 16-QAM | 1 RB | 0 | 1852.5 | 26065 | 20.66 | 22 | 0-1 |
| | | | | | 1882.5 | 26365 | 20.46 | 22 | 0-1 |
| | | | | | 1912.5 | 26665 | 20.46 | 22 | 0-1 |
| | | | | 12 | 1852.5 | 26065 | 20.72 | 22 | 0-1 |
| | | | | | 1882.5 | 26365 | 20.45 | 22 | 0-1 |
| | | | | | 1912.5 | 26665 | 20.47 | 22 | 0-1 |
| | 24 | | | 1852.5 | 26065 | 20.63 | 22 | 0-1 | |
| | | | | 1882.5 | 26365 | 20.45 | 22 | 0-1 | |
| | | | | 1912.5 | 26665 | 20.47 | 22 | 0-1 | |
| | 12 RB | | | 0 | 1852.5 | 26065 | 20.68 | 22 | 0-2 |
| | | | | | 1882.5 | 26365 | 20.50 | 22 | 0-2 |
| | | | | | 1912.5 | 26665 | 20.32 | 22 | 0-2 |
| | | | 6 | 1852.5 | 26065 | 20.45 | 22 | 0-2 | |
| | | | | 1882.5 | 26365 | 20.59 | 22 | 0-2 | |
| | | | | 1912.5 | 26665 | 20.51 | 22 | 0-2 | |
| | | | 13 | 1852.5 | 26065 | 20.71 | 22 | 0-2 | |
| | | | | 1882.5 | 26365 | 20.57 | 22 | 0-2 | |
| | | | | 1912.5 | 26665 | 20.66 | 22 | 0-2 | |
| | | | 25RB | 1852.5 | 26065 | 20.65 | 22 | 0-2 | |
| | | | | 1882.5 | 26365 | 20.48 | 22 | 0-2 | |
| | | | | 1912.5 | 26665 | 20.49 | 22 | 0-2 | |

Unless otherwise stated the results shown in this test report refer only to the sample(s) tested and such sample(s) are retained for 90 days only.

除非另有說明，此報告結果僅對測試之樣品負責，同時此樣品僅保留90天。本報告未經本公司書面許可，不可部份複製。

This document is issued by the Company subject to its General Conditions of Service printed overleaf, available on request or accessible at www.sgs.com/terms_and_conditions.htm and, for electronic format documents, subject to Terms and Conditions for Electronic Documents at www.sgs.com/terms_e-document.htm. Attention is drawn to the limitation of liability, indemnification and jurisdiction issues defined therein. Any holder of this document is advised that information contained hereon reflects the Company's findings at the time of its intervention only and within the limits of Client's instructions, if any. The Company's sole responsibility is to its Client and this document does not exonerate parties to a transaction from exercising all their rights and obligations under the transaction documents. This document cannot be reproduced except in full, without prior written approval of the Company. Any unauthorized alteration, forgery or falsification of the content or appearance of this document is unlawful and offenders may be prosecuted to the fullest extent of the law.

| FDD Band 25 | | | | | | | | | |
|-------------|------------|---------|-----------|-----------------|---------|-----------------------|-------------------------------------|--------------------------|-----|
| BW(Mhz) | Modulation | RB Size | RB Offset | Frequency (MHz) | Channel | Conducted power (dBm) | Target Power + Max. Tolerance (dBm) | MPR Allowed per 3GPP(dB) | |
| 3 | QPSK | 1 RB | 0 | 1851.5 | 26055 | 21.80 | 22 | 0 | |
| | | | | 1882.5 | 26365 | 21.48 | 22 | 0 | |
| | | | | 1913.5 | 26675 | 21.48 | 22 | 0 | |
| | | | 7 | 1851.5 | 26055 | 21.75 | 22 | 0 | |
| | | | | 1882.5 | 26365 | 21.47 | 22 | 0 | |
| | | | | 1913.5 | 26675 | 21.47 | 22 | 0 | |
| | | 14 | 1851.5 | 26055 | 21.63 | 22 | 0 | | |
| | | | 1882.5 | 26365 | 21.46 | 22 | 0 | | |
| | | | 1913.5 | 26675 | 21.46 | 22 | 0 | | |
| | | 8 RB | 0 | 1851.5 | 26055 | 21.61 | 22 | 0-1 | |
| | | | | 1882.5 | 26365 | 21.47 | 22 | 0-1 | |
| | | | | 1913.5 | 26675 | 21.46 | 22 | 0-1 | |
| | | | 4 | 1851.5 | 26055 | 21.60 | 22 | 0-1 | |
| | | | | 1882.5 | 26365 | 21.55 | 22 | 0-1 | |
| | | | | 1913.5 | 26675 | 21.48 | 22 | 0-1 | |
| | | | 7 | 1851.5 | 26055 | 21.71 | 22 | 0-1 | |
| | | | | 1882.5 | 26365 | 21.49 | 22 | 0-1 | |
| | | | | 1913.5 | 26675 | 21.65 | 22 | 0-1 | |
| | | 15RB | 1851.5 | 26055 | 21.45 | 22 | 0-1 | | |
| | | | 1882.5 | 26365 | 21.53 | 22 | 0-1 | | |
| | | | 1913.5 | 26675 | 21.56 | 22 | 0-1 | | |
| | | 16-QAM | 1 RB | 0 | 1851.5 | 26055 | 20.59 | 22 | 0-1 |
| | | | | | 1882.5 | 26365 | 20.39 | 22 | 0-1 |
| | | | | | 1913.5 | 26675 | 20.44 | 22 | 0-1 |
| | 7 | | | 1851.5 | 26055 | 20.66 | 22 | 0-1 | |
| | | | | 1882.5 | 26365 | 20.43 | 22 | 0-1 | |
| | | | | 1913.5 | 26675 | 20.41 | 22 | 0-1 | |
| | 14 | | | 1851.5 | 26055 | 20.62 | 22 | 0-1 | |
| | | | | 1882.5 | 26365 | 20.42 | 22 | 0-1 | |
| | | | | 1913.5 | 26675 | 20.43 | 22 | 0-1 | |
| | 8 RB | | | 0 | 1851.5 | 26055 | 20.59 | 22 | 0-2 |
| | | | | | 1882.5 | 26365 | 20.45 | 22 | 0-2 |
| | | | | | 1913.5 | 26675 | 20.26 | 22 | 0-2 |
| | | | 4 | 1851.5 | 26055 | 20.37 | 22 | 0-2 | |
| | | | | 1882.5 | 26365 | 20.57 | 22 | 0-2 | |
| | | | | 1913.5 | 26675 | 20.49 | 22 | 0-2 | |
| | | | 7 | 1851.5 | 26055 | 20.62 | 22 | 0-2 | |
| | | | | 1882.5 | 26365 | 20.51 | 22 | 0-2 | |
| | | | | 1913.5 | 26675 | 20.61 | 22 | 0-2 | |
| | 15RB | | 1851.5 | 26055 | 20.62 | 22 | 0-2 | | |
| | | | 1882.5 | 26365 | 20.42 | 22 | 0-2 | | |
| | | | 1913.5 | 26675 | 20.42 | 22 | 0-2 | | |

Unless otherwise stated the results shown in this test report refer only to the sample(s) tested and such sample(s) are retained for 90 days only.

除非另有說明，此報告結果僅對測試之樣品負責，同時此樣品僅保留90天。本報告未經本公司書面許可，不可部份複製。

This document is issued by the Company subject to its General Conditions of Service printed overleaf, available on request or accessible at www.sgs.com/terms_and_conditions.htm and, for electronic format documents, subject to Terms and Conditions for Electronic Documents at www.sgs.com/terms_e-document.htm. Attention is drawn to the limitation of liability, indemnification and jurisdiction issues defined therein. Any holder of this document is advised that information contained hereon reflects the Company's findings at the time of its intervention only and within the limits of Client's instructions, if any. The Company's sole responsibility is to its Client and this document does not exonerate parties to a transaction from exercising all their rights and obligations under the transaction documents. This document cannot be reproduced except in full, without prior written approval of the Company. Any unauthorized alteration, forgery or falsification of the content or appearance of this document is unlawful and offenders may be prosecuted to the fullest extent of the law.

| FDD Band 25 | | | | | | | | | | |
|-------------|------------|---------|-----------|-----------------|---------|-----------------------|-------------------------------------|--------------------------|-----|-----|
| BW(MHz) | Modulation | RB Size | RB Offset | Frequency (MHz) | Channel | Conducted power (dBm) | Target Power + Max. Tolerance (dBm) | MPR Allowed per 3GPP(dB) | | |
| 1.4 | QPSK | 1 RB | 0 | 1850.7 | 26047 | 21.75 | 22 | 0 | | |
| | | | | 1882.5 | 26365 | 21.44 | 22 | 0 | | |
| | | | | 1914.3 | 26683 | 21.48 | 22 | 0 | | |
| | | | 2 | 1850.7 | 26047 | 21.66 | 22 | 0 | | |
| | | | | 1882.5 | 26365 | 21.44 | 22 | 0 | | |
| | | | | 1914.3 | 26683 | 21.46 | 22 | 0 | | |
| | | 5 | 1850.7 | 26047 | 21.58 | 22 | 0 | | | |
| | | | 1882.5 | 26365 | 21.36 | 22 | 0 | | | |
| | | | 1914.3 | 26683 | 21.43 | 22 | 0 | | | |
| | | 3 RB | 0 | 1850.7 | 26047 | 21.57 | 22 | 22 | 0-1 | |
| | | | | 1882.5 | 26365 | 21.46 | 22 | 22 | 0-1 | |
| | | | | 1914.3 | 26683 | 21.43 | 22 | 22 | 0-1 | |
| | | | 2 | 1850.7 | 26047 | 21.58 | 22 | 22 | 0-1 | |
| | | | | 1882.5 | 26365 | 21.54 | 22 | 22 | 0-1 | |
| | | | | 1914.3 | 26683 | 21.46 | 22 | 22 | 0-1 | |
| | | | 3 | 1850.7 | 26047 | 21.70 | 22 | 22 | 0-1 | |
| | | | | 1882.5 | 26365 | 21.42 | 22 | 22 | 0-1 | |
| | | | | 1914.3 | 26683 | 21.63 | 22 | 22 | 0-1 | |
| | | 6RB | 1850.7 | 26047 | 21.39 | 22 | 22 | 0-1 | | |
| | | | 1882.5 | 26365 | 21.51 | 22 | 22 | 0-1 | | |
| | | | 1914.3 | 26683 | 21.48 | 22 | 22 | 0-1 | | |
| | | 16-QAM | 1 RB | 0 | 1850.7 | 26047 | 20.51 | 22 | 22 | 0-1 |
| | | | | | 1882.5 | 26365 | 20.34 | 22 | 22 | 0-1 |
| | | | | | 1914.3 | 26683 | 20.36 | 22 | 22 | 0-1 |
| | 2 | | | 1850.7 | 26047 | 20.63 | 22 | 22 | 0-1 | |
| | | | | 1882.5 | 26365 | 20.36 | 22 | 22 | 0-1 | |
| | | | | 1914.3 | 26683 | 20.38 | 22 | 22 | 0-1 | |
| | 5 | | | 1850.7 | 26047 | 20.60 | 22 | 22 | 0-1 | |
| | | | | 1882.5 | 26365 | 20.36 | 22 | 22 | 0-1 | |
| | | | | 1914.3 | 26683 | 20.41 | 22 | 22 | 0-1 | |
| | 3 RB | | | 0 | 1850.7 | 26047 | 20.55 | 22 | 22 | 0-2 |
| | | | | | 1882.5 | 26365 | 20.44 | 22 | 22 | 0-2 |
| | | | | | 1914.3 | 26683 | 20.23 | 22 | 22 | 0-2 |
| | | | 2 | 1850.7 | 26047 | 20.27 | 22 | 22 | 0-2 | |
| | | | | 1882.5 | 26365 | 20.51 | 22 | 22 | 0-2 | |
| | | | | 1914.3 | 26683 | 20.41 | 22 | 22 | 0-2 | |
| | | | 3 | 1850.7 | 26047 | 20.61 | 22 | 22 | 0-2 | |
| | | | | 1882.5 | 26365 | 20.44 | 22 | 22 | 0-2 | |
| | | | | 1914.3 | 26683 | 20.56 | 22 | 22 | 0-2 | |
| | | | 6RB | 1850.7 | 26047 | 20.59 | 22 | 22 | 0-2 | |
| | | | | 1882.5 | 26365 | 20.39 | 22 | 22 | 0-2 | |
| | | | | 1914.3 | 26683 | 20.41 | 22 | 22 | 0-2 | |

Unless otherwise stated the results shown in this test report refer only to the sample(s) tested and such sample(s) are retained for 90 days only.

除非另有說明，此報告結果僅對測試之樣品負責，同時此樣品僅保留90天。本報告未經本公司書面許可，不可部份複製。

This document is issued by the Company subject to its General Conditions of Service printed overleaf, available on request or accessible at www.sgs.com/terms_and_conditions.htm and, for electronic format documents, subject to Terms and Conditions for Electronic Documents at www.sgs.com/terms_e-document.htm. Attention is drawn to the limitation of liability, indemnification and jurisdiction issues defined therein. Any holder of this document is advised that information contained hereon reflects the Company's findings at the time of its intervention only and within the limits of Client's instructions, if any. The Company's sole responsibility is to its Client and this document does not exonerate parties to a transaction from exercising all their rights and obligations under the transaction documents. This document cannot be reproduced except in full, without prior written approval of the Company. Any unauthorized alteration, forgery or falsification of the content or appearance of this document is unlawful and offenders may be prosecuted to the fullest extent of the law.

CDMA conducted power table:

| Band | Channel | Frequency (MHz) | Target Power + Max. Tolerance (dBm) | 1xRTT | | | | EVDO | |
|-------------|---------|-----------------|-------------------------------------|-------|-------|-----------|-----------|---------------------------|-----------------------------|
| | | | | SO55 | SO55 | TDSO/SO32 | TDSO/SO32 | 1x EvDO Rev. 0, FTAP/RTAP | 1x EvDO Rev. A, FETAP/RETAP |
| | | | | RC1 | RC3 | FCH+SCH | FCH | Subtype 0/1 | Subtype 2 |
| CDMA (BC0) | 1013 | 824.7 | 23.00 | 22.67 | 22.64 | 22.58 | 22.58 | 22.70 | 22.60 |
| | 384 | 836.52 | 23.00 | 22.76 | 22.72 | 22.67 | 22.73 | 22.90 | 22.70 |
| | 777 | 848.31 | 23.00 | 22.50 | 22.45 | 22.28 | 22.29 | 22.60 | 22.50 |
| CDMA (BC1) | 25 | 1851.25 | 22.00 | 21.94 | 21.93 | 21.91 | 21.93 | 21.97 | 21.94 |
| | 600 | 1880 | 22.00 | 21.74 | 21.72 | 21.70 | 21.70 | 21.78 | 21.77 |
| | 1175 | 1908.75 | 22.00 | 21.92 | 21.87 | 21.84 | 21.84 | 21.96 | 21.95 |
| CDMA (BC10) | 476 | 817.9 | 23.00 | 22.57 | 22.55 | 22.48 | 22.51 | 22.60 | 22.50 |
| | 560 | 820 | 23.00 | 22.57 | 22.57 | 22.50 | 22.52 | 22.60 | 22.50 |
| | 684 | 823.1 | 23.00 | 22.61 | 22.63 | 22.57 | 22.59 | 22.70 | 22.60 |

Unless otherwise stated the results shown in this test report refer only to the sample(s) tested and such sample(s) are retained for 90 days only.

除非另有說明，此報告結果僅對測試之樣品負責，同時此樣品僅保留90天。本報告未經本公司書面許可，不可部份複製。

This document is issued by the Company subject to its General Conditions of Service printed overleaf, available on request or accessible at www.sgs.com/terms_and_conditions.htm and, for electronic format documents, subject to Terms and Conditions for Electronic Documents at www.sgs.com/terms_e-document.htm. Attention is drawn to the limitation of liability, indemnification and jurisdiction issues defined therein. Any holder of this document is advised that information contained hereon reflects the Company's findings at the time of its intervention only and within the limits of Client's instructions, if any. The Company's sole responsibility is to its Client and this document does not exonerate parties to a transaction from exercising all their rights and obligations under the transaction documents. This document cannot be reproduced except in full, without prior written approval of the Company. Any unauthorized alteration, forgery or falsification of the content or appearance of this document is unlawful and offenders may be prosecuted to the fullest extent of the law.

#. WLAN802.11 a/b/g/n(20M/40M) conducted power table:

| Band | Antenna | SISO | | MIMO |
|---------------------|---------|---------|---------|----------|
| | | Chain 0 | Chain 1 | Chain0+1 |
| WLAN802.11b | | V | V | — |
| WLAN802.11g | | V | V | — |
| WLAN802.11n(20M) | | V | V | V |
| WLAN802.11n(40M) | | V | V | V |
| WLAN802.11a | | V | V | — |
| WLAN802.11n(20M) 5G | | V | V | V |
| WLAN802.11n(40M) 5G | | V | V | V |

Main Antenna (CH0)

| 802.11 b | | Max. Rated Avg. Power + Max. Tolerance (dBm) | Average Power Output (dBm) |
|----------|-----------------|--|----------------------------|
| CH | Frequency (MHz) | | Data Rate (Mbps) |
| | | | 1 |
| 1 | 2412 | 13.5 | 13.50 |
| 6 | 2437 | 13.5 | 13.00 |
| 11 | 2462 | 13.5 | 12.62 |

| 802.11 g | | Max. Rated Avg. Power + Max. Tolerance (dBm) | Average Power Output (dBm) |
|----------|-----------------|--|----------------------------|
| CH | Frequency (MHz) | | Data Rate (Mbps) |
| | | | 6 |
| 1 | 2412 | 6.77 | 6.04 |
| 6 | 2437 | 13 | 12.60 |
| 11 | 2462 | 6 | 5.83 |

Unless otherwise stated the results shown in this test report refer only to the sample(s) tested and such sample(s) are retained for 90 days only.

除非另有說明，此報告結果僅對測試之樣品負責，同時此樣品僅保留90天。本報告未經本公司書面許可，不可部份複製。

This document is issued by the Company subject to its General Conditions of Service printed overleaf, available on request or accessible at www.sgs.com/terms_and_conditions.htm and, for electronic format documents, subject to Terms and Conditions for Electronic Documents at www.sgs.com/terms_e-document.htm. Attention is drawn to the limitation of liability, indemnification and jurisdiction issues defined therein. Any holder of this document is advised that information contained hereon reflects the Company's findings at the time of its intervention only and within the limits of Client's instructions, if any. The Company's sole responsibility is to its Client and this document does not exonerate parties to a transaction from exercising all their rights and obligations under the transaction documents. This document cannot be reproduced except in full, without prior written approval of the Company. Any unauthorized alteration, forgery or falsification of the content or appearance of this document is unlawful and offenders may be prosecuted to the fullest extent of the law.

Main Antenna (CHO)

| 802.11 n(20M) | | Max. Rated Avg. Power + Max. Tolerance (dBm) | Average Power Output (dBm) |
|---------------|--------------------|--|----------------------------|
| CH | Frequency (MHz) | | Data Rate (Mbps) |
| | | | 6.5 |
| 1 | 2412 | 10 | 9.49 |
| 6 | 2437 | 10 | 9.30 |
| 11 | 2462 | 10 | 8.71 |

| 802.11 n(40M) | | Max. Rated Avg. Power + Max. Tolerance (dBm) | Average Power Output (dBm) |
|---------------|--------------------|--|----------------------------|
| CH | Frequency (MHz) | | Data Rate (Mbps) |
| | | | 13.5 |
| 3 | 2422 | 8 | 7.50 |
| 6 | 2437 | 9.5 | 8.65 |
| 9 | 2452 | 8 | 7.52 |

Unless otherwise stated the results shown in this test report refer only to the sample(s) tested and such sample(s) are retained for 90 days only.

除非另有說明，此報告結果僅對測試之樣品負責，同時此樣品僅保留90天。本報告未經本公司書面許可，不可部份複製。

This document is issued by the Company subject to its General Conditions of Service printed overleaf, available on request or accessible at www.sgs.com/terms_and_conditions.htm and, for electronic format documents, subject to Terms and Conditions for Electronic Documents at www.sgs.com/terms_e-document.htm. Attention is drawn to the limitation of liability, indemnification and jurisdiction issues defined therein. Any holder of this document is advised that information contained hereon reflects the Company's findings at the time of its intervention only and within the limits of Client's instructions, if any. The Company's sole responsibility is to its Client and this document does not exonerate parties to a transaction from exercising all their rights and obligations under the transaction documents. This document cannot be reproduced except in full, without prior written approval of the Company. Any unauthorized alteration, forgery or falsification of the content or appearance of this document is unlawful and offenders may be prosecuted to the fullest extent of the law.

Main Antenna (CHO)

| 802.11 a | | Max. Rated Avg. Power + Max. Tolerance (dBm) | Average Power Output(dBm) |
|------------------|--------------------|--|---------------------------|
| 5.2/5.3/5.6/5.8G | | | Data Rate (Mbps) |
| CH | Frequency (MHz) | | 6 |
| 36 | 5180 | 10.5 | 9.48 |
| 40 | 5200 | 10.5 | 9.89 |
| 44 | 5220 | 10.5 | 9.81 |
| 48 | 5240 | 10.5 | 9.78 |
| 52 | 5260 | 10.5 | 9.91 |
| 56 | 5280 | 10.5 | 9.94 |
| 60 | 5300 | 10.5 | 9.89 |
| 64 | 5320 | 9 | 8.54 |
| 100 | 5500 | 6 | 5.99 |
| 104 | 5520 | 10.5 | 9.23 |
| 108 | 5540 | 10.5 | 9.82 |
| 112 | 5560 | 10.5 | 9.76 |
| 116 | 5580 | 10.5 | 9.79 |
| 120 | 5600 | 10.5 | 9.72 |
| 124 | 5620 | 10.5 | 9.85 |
| 128 | 5640 | 10.5 | 9.93 |
| 132 | 5660 | 10.5 | 9.86 |
| 136 | 5680 | 10.5 | 9.85 |
| 140 | 5700 | 8 | 7.43 |
| 149 | 5745 | 10.5 | 9.39 |
| 153 | 5765 | 10.5 | 9.52 |
| 157 | 5785 | 10.5 | 9.69 |
| 161 | 5805 | 10.5 | 9.77 |
| 165 | 5825 | 10.5 | 9.87 |

Unless otherwise stated the results shown in this test report refer only to the sample(s) tested and such sample(s) are retained for 90 days only.

除非另有說明，此報告結果僅對測試之樣品負責，同時此樣品僅保留90天。本報告未經本公司書面許可，不可部份複製。

This document is issued by the Company subject to its General Conditions of Service printed overleaf, available on request or accessible at www.sgs.com/terms_and_conditions.htm and, for electronic format documents, subject to Terms and Conditions for Electronic Documents at www.sgs.com/terms_e-document.htm. Attention is drawn to the limitation of liability, indemnification and jurisdiction issues defined therein. Any holder of this document is advised that information contained hereon reflects the Company's findings at the time of its intervention only and within the limits of Client's instructions, if any. The Company's sole responsibility is to its Client and this document does not exonerate parties to a transaction from exercising all their rights and obligations under the transaction documents. This document cannot be reproduced except in full, without prior written approval of the Company. Any unauthorized alteration, forgery or falsification of the content or appearance of this document is unlawful and offenders may be prosecuted to the fullest extent of the law.

Main Antenna (CHO)

| 802.11 n(20M) | | Max. Rated Avg. Power + Max. Tolerance (dBm) | Average Power Output(dBm) |
|------------------|--------------------|--|---------------------------|
| 5.2/5.3/5.6/5.8G | | | Data Rate (Mbps) |
| CH | Frequency (MHz) | | 6.5 |
| 36 | 5180 | 10.5 | 9.98 |
| 40 | 5200 | 10.5 | 9.85 |
| 44 | 5220 | 10.5 | 9.72 |
| 48 | 5240 | 10.5 | 9.65 |
| 52 | 5260 | 10.5 | 9.71 |
| 56 | 5280 | 10.5 | 9.79 |
| 60 | 5300 | 10.5 | 9.85 |
| 64 | 5320 | 10.5 | 9.48 |
| 100 | 5500 | 9.0 | 8.22 |
| 104 | 5520 | 10.5 | 9.77 |
| 108 | 5540 | 10.5 | 9.82 |
| 112 | 5560 | 10.5 | 9.74 |
| 116 | 5580 | 10.5 | 9.73 |
| 120 | 5600 | 10.5 | 9.75 |
| 124 | 5620 | 10.5 | 9.69 |
| 128 | 5640 | 10.5 | 9.85 |
| 132 | 5660 | 10.5 | 9.79 |
| 136 | 5680 | 10.5 | 9.63 |
| 140 | 5700 | 10.5 | 9.57 |
| 149 | 5745 | 10.5 | 9.30 |
| 153 | 5765 | 10.5 | 9.38 |
| 157 | 5785 | 10.5 | 9.47 |
| 161 | 5805 | 10.5 | 9.61 |
| 165 | 5825 | 10.5 | 9.65 |

Unless otherwise stated the results shown in this test report refer only to the sample(s) tested and such sample(s) are retained for 90 days only.

除非另有說明，此報告結果僅對測試之樣品負責，同時此樣品僅保留90天。本報告未經本公司書面許可，不可部份複製。

This document is issued by the Company subject to its General Conditions of Service printed overleaf, available on request or accessible at www.sgs.com/terms_and_conditions.htm and, for electronic format documents, subject to Terms and Conditions for Electronic Documents at www.sgs.com/terms_e-document.htm. Attention is drawn to the limitation of liability, indemnification and jurisdiction issues defined therein. Any holder of this document is advised that information contained hereon reflects the Company's findings at the time of its intervention only and within the limits of Client's instructions, if any. The Company's sole responsibility is to its Client and this document does not exonerate parties to a transaction from exercising all their rights and obligations under the transaction documents. This document cannot be reproduced except in full, without prior written approval of the Company. Any unauthorized alteration, forgery or falsification of the content or appearance of this document is unlawful and offenders may be prosecuted to the fullest extent of the law.

Main Antenna (CHO)

| 802.11 n(40M) | | Max. Rated Avg. Power + Max. Tolerance (dBm) | Average Power Output(dBm) |
|------------------|--------------------|--|---------------------------|
| 5.2/5.3/5.6/5.8G | | | Data Rate (Mbps) |
| CH | Frequency (MHz) | | 13.5 |
| 38 | 5190 | 9.0 | 8.23 |
| 46 | 5230 | 10.5 | 9.61 |
| 54 | 5270 | 10.5 | 9.77 |
| 62 | 5310 | 9.0 | 7.23 |
| 102 | 5510 | 7.0 | 5.75 |
| 110 | 5550 | 10.0 | 9.58 |
| 118 | 5590 | 10.0 | 9.62 |
| 126 | 5630 | 10.0 | 9.71 |
| 134 | 5670 | 10.0 | 9.64 |
| 151 | 5755 | 11.0 | 9.21 |
| 159 | 5795 | 11.0 | 9.33 |

Unless otherwise stated the results shown in this test report refer only to the sample(s) tested and such sample(s) are retained for 90 days only.

除非另有說明，此報告結果僅對測試之樣品負責，同時此樣品僅保留90天。本報告未經本公司書面許可，不可部份複製。

This document is issued by the Company subject to its General Conditions of Service printed overleaf, available on request or accessible at www.sgs.com/terms_and_conditions.htm and, for electronic format documents, subject to Terms and Conditions for Electronic Documents at www.sgs.com/terms_e-document.htm. Attention is drawn to the limitation of liability, indemnification and jurisdiction issues defined therein. Any holder of this document is advised that information contained hereon reflects the Company's findings at the time of its intervention only and within the limits of Client's instructions, if any. The Company's sole responsibility is to its Client and this document does not exonerate parties to a transaction from exercising all their rights and obligations under the transaction documents. This document cannot be reproduced except in full, without prior written approval of the Company. Any unauthorized alteration, forgery or falsification of the content or appearance of this document is unlawful and offenders may be prosecuted to the fullest extent of the law.

Aux Antenna (CH1)

| 802.11 b | | Max. Rated Avg. Power + Max. Tolerance (dBm) | Average Power Output (dBm) |
|----------|--------------------|--|----------------------------|
| CH | Frequency (MHz) | | Data Rate (Mbps) |
| | | | 1 |
| 1 | 2412 | 11 | 10.73 |
| 6 | 2437 | 11.2 | 11.14 |
| 11 | 2462 | 12 | 11.59 |

| 802.11 g | | Max. Rated Avg. Power + Max. Tolerance (dBm) | Average Power Output (dBm) |
|----------|--------------------|--|----------------------------|
| CH | Frequency (MHz) | | Data Rate (Mbps) |
| | | | 6 |
| 1 | 2412 | 6 | 5.79 |
| 6 | 2437 | 11 | 10.97 |
| 11 | 2462 | 5 | 4.94 |

| 802.11 n(20M) | | Max. Rated Avg. Power + Max. Tolerance (dBm) | Average Power Output (dBm) |
|---------------|--------------------|--|----------------------------|
| CH | Frequency (MHz) | | Data Rate (Mbps) |
| | | | 6.5 |
| 1 | 2412 | 10 | 9.35 |
| 6 | 2437 | 10 | 9.49 |
| 11 | 2462 | 10 | 9.41 |

| 802.11 n(40M) | | Max. Rated Avg. Power + Max. Tolerance (dBm) | Average Power Output (dBm) |
|---------------|--------------------|--|----------------------------|
| CH | Frequency (MHz) | | Data Rate (Mbps) |
| | | | 13.5 |
| 3 | 2422 | 8 | 7.19 |
| 6 | 2437 | 9.5 | 8.63 |
| 9 | 2452 | 8 | 7.81 |

Unless otherwise stated the results shown in this test report refer only to the sample(s) tested and such sample(s) are retained for 90 days only.

除非另有說明，此報告結果僅對測試之樣品負責，同時此樣品僅保留90天。本報告未經本公司書面許可，不可部份複製。

This document is issued by the Company subject to its General Conditions of Service printed overleaf, available on request or accessible at www.sgs.com/terms_and_conditions.htm and, for electronic format documents, subject to Terms and Conditions for Electronic Documents at www.sgs.com/terms_e-document.htm. Attention is drawn to the limitation of liability, indemnification and jurisdiction issues defined therein. Any holder of this document is advised that information contained hereon reflects the Company's findings at the time of its intervention only and within the limits of Client's instructions, if any. The Company's sole responsibility is to its Client and this document does not exonerate parties to a transaction from exercising all their rights and obligations under the transaction documents. This document cannot be reproduced except in full, without prior written approval of the Company. Any unauthorized alteration, forgery or falsification of the content or appearance of this document is unlawful and offenders may be prosecuted to the fullest extent of the law.

Aux Antenna (CH1)

| 802.11 a | | Max. Rated Avg. Power + Max. Tolerance (dBm) | Average Power Output(dBm) |
|------------------|--------------------|--|---------------------------|
| 5.2/5.3/5.6/5.8G | | | Data Rate (Mbps) |
| CH | Frequency (MHz) | | 6 |
| 36 | 5180 | 10 | 9.31 |
| 40 | 5200 | 10 | 9.37 |
| 44 | 5220 | 10 | 9.22 |
| 48 | 5240 | 10 | 9.19 |
| 52 | 5260 | 10 | 9.16 |
| 56 | 5280 | 10 | 9.12 |
| 60 | 5300 | 10 | 9.60 |
| 64 | 5320 | 9 | 8.99 |
| 100 | 5500 | 6 | 5.97 |
| 104 | 5520 | 10.5 | 9.39 |
| 108 | 5540 | 10.5 | 9.45 |
| 112 | 5560 | 10.5 | 9.41 |
| 116 | 5580 | 10.5 | 9.39 |
| 120 | 5600 | 10.5 | 9.51 |
| 124 | 5620 | 10.5 | 9.37 |
| 128 | 5640 | 10.5 | 9.44 |
| 132 | 5660 | 10.5 | 9.39 |
| 136 | 5680 | 10.5 | 9.31 |
| 140 | 5700 | 8 | 7.62 |
| 149 | 5745 | 10 | 9.32 |
| 153 | 5765 | 10 | 9.44 |
| 157 | 5785 | 10 | 9.47 |
| 161 | 5805 | 10 | 9.52 |
| 165 | 5825 | 10 | 9.50 |

Unless otherwise stated the results shown in this test report refer only to the sample(s) tested and such sample(s) are retained for 90 days only.

除非另有說明，此報告結果僅對測試之樣品負責，同時此樣品僅保留90天。本報告未經本公司書面許可，不可部份複製。

This document is issued by the Company subject to its General Conditions of Service printed overleaf, available on request or accessible at www.sgs.com/terms_and_conditions.htm and, for electronic format documents, subject to Terms and Conditions for Electronic Documents at www.sgs.com/terms_e-document.htm. Attention is drawn to the limitation of liability, indemnification and jurisdiction issues defined therein. Any holder of this document is advised that information contained hereon reflects the Company's findings at the time of its intervention only and within the limits of Client's instructions, if any. The Company's sole responsibility is to its Client and this document does not exonerate parties to a transaction from exercising all their rights and obligations under the transaction documents. This document cannot be reproduced except in full, without prior written approval of the Company. Any unauthorized alteration, forgery or falsification of the content or appearance of this document is unlawful and offenders may be prosecuted to the fullest extent of the law.

Aux Antenna (CH1)

| 802.11 n(20M) | | Max. Rated Avg. Power + Max. Tolerance (dBm) | Average Power Output(dBm) |
|------------------|--------------------|--|---------------------------|
| 5.2/5.3/5.6/5.8G | | | Data Rate (Mbps) |
| CH | Frequency (MHz) | | 6.5 |
| 36 | 5180 | 10.0 | 9.31 |
| 40 | 5200 | 10.0 | 9.36 |
| 44 | 5220 | 10.0 | 9.27 |
| 48 | 5240 | 10.0 | 9.19 |
| 52 | 5260 | 10.5 | 9.13 |
| 56 | 5280 | 10.5 | 9.11 |
| 60 | 5300 | 10.5 | 9.57 |
| 64 | 5320 | 10.5 | 9.49 |
| 100 | 5500 | 9.0 | 8.44 |
| 104 | 5520 | 10.5 | 9.39 |
| 108 | 5540 | 10.5 | 9.41 |
| 112 | 5560 | 10.5 | 9.35 |
| 116 | 5580 | 10.5 | 9.47 |
| 120 | 5600 | 10.5 | 9.51 |
| 124 | 5620 | 10.5 | 9.48 |
| 128 | 5640 | 10.5 | 9.44 |
| 132 | 5660 | 10.5 | 9.33 |
| 136 | 5680 | 10.5 | 9.27 |
| 140 | 5700 | 10.5 | 9.26 |
| 149 | 5745 | 10.5 | 9.25 |
| 153 | 5765 | 10.5 | 9.42 |
| 157 | 5785 | 10.5 | 9.51 |
| 161 | 5805 | 10.5 | 9.49 |
| 165 | 5825 | 10.5 | 9.54 |

Unless otherwise stated the results shown in this test report refer only to the sample(s) tested and such sample(s) are retained for 90 days only.

除非另有說明，此報告結果僅對測試之樣品負責，同時此樣品僅保留90天。本報告未經本公司書面許可，不可部份複製。

This document is issued by the Company subject to its General Conditions of Service printed overleaf, available on request or accessible at www.sgs.com/terms_and_conditions.htm and, for electronic format documents, subject to Terms and Conditions for Electronic Documents at www.sgs.com/terms_e-document.htm. Attention is drawn to the limitation of liability, indemnification and jurisdiction issues defined therein. Any holder of this document is advised that information contained hereon reflects the Company's findings at the time of its intervention only and within the limits of Client's instructions, if any. The Company's sole responsibility is to its Client and this document does not exonerate parties to a transaction from exercising all their rights and obligations under the transaction documents. This document cannot be reproduced except in full, without prior written approval of the Company. Any unauthorized alteration, forgery or falsification of the content or appearance of this document is unlawful and offenders may be prosecuted to the fullest extent of the law.

Aux Antenna (CH1)

| 802.11 n(40M) | | Max. Rated Avg. Power + Max. Tolerance (dBm) | Average Power Output(dBm) |
|------------------|--------------------|--|---------------------------|
| 5.2/5.3/5.6/5.8G | | | Data Rate (Mbps) |
| CH | Frequency (MHz) | | 13.5 |
| 38 | 5190 | 9.00 | 8.57 |
| 46 | 5230 | 10.00 | 9.81 |
| 54 | 5270 | 10.50 | 9.86 |
| 62 | 5310 | 9.00 | 7.52 |
| 102 | 5510 | 7.00 | 5.75 |
| 110 | 5550 | 10.00 | 9.66 |
| 118 | 5590 | 10.00 | 9.23 |
| 126 | 5630 | 10.00 | 9.62 |
| 134 | 5670 | 10.00 | 9.04 |
| 151 | 5755 | 11.00 | 9.18 |
| 159 | 5795 | 11.00 | 9.25 |

Unless otherwise stated the results shown in this test report refer only to the sample(s) tested and such sample(s) are retained for 90 days only.

除非另有說明，此報告結果僅對測試之樣品負責，同時此樣品僅保留90天。本報告未經本公司書面許可，不可部份複製。

This document is issued by the Company subject to its General Conditions of Service printed overleaf, available on request or accessible at www.sgs.com/terms_and_conditions.htm and, for electronic format documents, subject to Terms and Conditions for Electronic Documents at www.sgs.com/terms_e-document.htm. Attention is drawn to the limitation of liability, indemnification and jurisdiction issues defined therein. Any holder of this document is advised that information contained hereon reflects the Company's findings at the time of its intervention only and within the limits of Client's instructions, if any. The Company's sole responsibility is to its Client and this document does not exonerate parties to a transaction from exercising all their rights and obligations under the transaction documents. This document cannot be reproduced except in full, without prior written approval of the Company. Any unauthorized alteration, forgery or falsification of the content or appearance of this document is unlawful and offenders may be prosecuted to the fullest extent of the law.

MIMO (CH0 + CH1)

| 802.11 n(20M) | | Max. Rated Avg. Power + Max. Tolerance (dBm) | Average Power Output (dBm) | | |
|---------------|--------------------|--|----------------------------|------|-----------|
| CH | Frequency (MHz) | | Data Rate (Mbps) | | |
| | | | CH0 | CH1 | CH0 + CH1 |
| 1 | 2412 | 10 | 7.09 | 5.81 | 9.51 |
| 6 | 2437 | 10 | 7.45 | 5.25 | 9.50 |
| 11 | 2462 | 10 | 7.66 | 4.81 | 9.48 |

| 802.11 n(40M) | | Max. Rated Avg. Power + Max. Tolerance (dBm) | Average Power Output (dBm) | | |
|---------------|--------------------|--|----------------------------|------|-----------|
| CH | Frequency (MHz) | | Data Rate (Mbps) | | |
| | | | CH0 | CH1 | CH0 + CH1 |
| 3 | 2422 | 8 | 5.29 | 3.59 | 7.53 |
| 6 | 2437 | 9.5 | 7.11 | 4.83 | 9.13 |
| 9 | 2452 | 8 | 6.15 | 2.88 | 7.83 |

Unless otherwise stated the results shown in this test report refer only to the sample(s) tested and such sample(s) are retained for 90 days only.

除非另有說明，此報告結果僅對測試之樣品負責，同時此樣品僅保留90天。本報告未經本公司書面許可，不可部份複製。

This document is issued by the Company subject to its General Conditions of Service printed overleaf, available on request or accessible at www.sgs.com/terms_and_conditions.htm and, for electronic format documents, subject to Terms and Conditions for Electronic Documents at www.sgs.com/terms_e-document.htm. Attention is drawn to the limitation of liability, indemnification and jurisdiction issues defined therein. Any holder of this document is advised that information contained hereon reflects the Company's findings at the time of its intervention only and within the limits of Client's instructions, if any. The Company's sole responsibility is to its Client and this document does not exonerate parties to a transaction from exercising all their rights and obligations under the transaction documents. This document cannot be reproduced except in full, without prior written approval of the Company. Any unauthorized alteration, forgery or falsification of the content or appearance of this document is unlawful and offenders may be prosecuted to the fullest extent of the law.

MIMO (CH0 + CH1)

| 802.11 n(20M) | | Max. Rated Avg. Power + Max. Tolerance (dBm) | Average Power Output (dBm) | | |
|------------------|-----------------|--|----------------------------|------|-----------|
| 5.2/5.3/5.6/5.8G | | | Data Rate (Mbps) | | |
| CH | Frequency (MHz) | | CH0 | CH1 | CH0 + CH1 |
| 36 | 5180 | 10.5 | 7.60 | 7.08 | 10.36 |
| 40 | 5200 | 10.5 | 7.51 | 6.77 | 10.17 |
| 44 | 5220 | 10.5 | 7.45 | 6.55 | 10.03 |
| 48 | 5240 | 10.5 | 7.33 | 6.41 | 9.90 |
| 52 | 5260 | 10.5 | 7.27 | 6.18 | 9.77 |
| 56 | 5280 | 10.5 | 7.88 | 7.05 | 10.50 |
| 60 | 5300 | 10.5 | 7.67 | 6.89 | 10.31 |
| 64 | 5320 | 10.5 | 6.90 | 6.04 | 9.50 |
| 100 | 5500 | 9.0 | 5.73 | 5.17 | 8.47 |
| 104 | 5520 | 10.5 | 7.46 | 7.06 | 10.27 |
| 108 | 5540 | 10.5 | 7.39 | 6.88 | 10.15 |
| 112 | 5560 | 10.5 | 7.33 | 6.78 | 10.07 |
| 116 | 5580 | 10.5 | 7.29 | 6.73 | 10.03 |
| 120 | 5600 | 10.5 | 7.21 | 6.80 | 10.02 |
| 124 | 5620 | 10.5 | 7.33 | 6.83 | 10.10 |
| 128 | 5640 | 10.5 | 7.39 | 6.81 | 10.12 |
| 132 | 5660 | 10.5 | 7.44 | 6.88 | 10.18 |
| 136 | 5680 | 10.5 | 7.42 | 6.99 | 10.22 |
| 140 | 5700 | 10.5 | 7.75 | 7.22 | 10.50 |
| 149 | 5745 | 10.5 | 7.26 | 6.50 | 9.91 |
| 153 | 5765 | 10.5 | 7.39 | 6.56 | 10.01 |
| 157 | 5785 | 10.5 | 7.21 | 6.69 | 9.97 |
| 161 | 5805 | 10.5 | 7.55 | 6.68 | 10.15 |
| 165 | 5825 | 10.5 | 7.36 | 6.90 | 10.15 |

Unless otherwise stated the results shown in this test report refer only to the sample(s) tested and such sample(s) are retained for 90 days only.

除非另有說明，此報告結果僅對測試之樣品負責，同時此樣品僅保留90天。本報告未經本公司書面許可，不可部份複製。

This document is issued by the Company subject to its General Conditions of Service printed overleaf, available on request or accessible at www.sgs.com/terms_and_conditions.htm and, for electronic format documents, subject to Terms and Conditions for Electronic Documents at www.sgs.com/terms_e-document.htm. Attention is drawn to the limitation of liability, indemnification and jurisdiction issues defined therein. Any holder of this document is advised that information contained hereon reflects the Company's findings at the time of its intervention only and within the limits of Client's instructions, if any. The Company's sole responsibility is to its Client and this document does not exonerate parties to a transaction from exercising all their rights and obligations under the transaction documents. This document cannot be reproduced except in full, without prior written approval of the Company. Any unauthorized alteration, forgery or falsification of the content or appearance of this document is unlawful and offenders may be prosecuted to the fullest extent of the law.

MIMO (CH0 + CH1)

| 802.11 n(40M) | | Max. Rated Avg. Power + Max. Tolerance (dBm) | Average Power Output (dBm) | | |
|------------------|-----------------|--|----------------------------|------|-----------|
| 5.2/5.3/5.6/5.8G | | | Data Rate (Mbps) | | |
| CH | Frequency (MHz) | | CH0 | CH1 | CH0 + CH1 |
| 38 | 5190 | 9.0 | 6.33 | 5.63 | 9.00 |
| 46 | 5230 | 10.5 | 7.87 | 6.97 | 10.45 |
| 54 | 5270 | 10.5 | 7.73 | 6.77 | 10.29 |
| 62 | 5310 | 9.0 | 5.59 | 4.49 | 8.09 |
| 102 | 5510 | 7.0 | 3.93 | 3.50 | 6.73 |
| 110 | 5550 | 10.0 | 6.93 | 6.55 | 9.75 |
| 118 | 5590 | 10.0 | 6.81 | 6.55 | 9.69 |
| 126 | 5630 | 10.0 | 7.06 | 6.42 | 9.76 |
| 134 | 5670 | 10.0 | 7.13 | 6.63 | 9.90 |
| 151 | 5755 | 11.0 | 7.66 | 7.11 | 10.40 |
| 159 | 5795 | 11.0 | 7.80 | 7.18 | 10.51 |

Unless otherwise stated the results shown in this test report refer only to the sample(s) tested and such sample(s) are retained for 90 days only.

除非另有說明，此報告結果僅對測試之樣品負責，同時此樣品僅保留90天。本報告未經本公司書面許可，不可部份複製。

This document is issued by the Company subject to its General Conditions of Service printed overleaf, available on request or accessible at www.sgs.com/terms_and_conditions.htm and, for electronic format documents, subject to Terms and Conditions for Electronic Documents at www.sgs.com/terms_e-document.htm. Attention is drawn to the limitation of liability, indemnification and jurisdiction issues defined therein. Any holder of this document is advised that information contained hereon reflects the Company's findings at the time of its intervention only and within the limits of Client's instructions, if any. The Company's sole responsibility is to its Client and this document does not exonerate parties to a transaction from exercising all their rights and obligations under the transaction documents. This document cannot be reproduced except in full, without prior written approval of the Company. Any unauthorized alteration, forgery or falsification of the content or appearance of this document is unlawful and offenders may be prosecuted to the fullest extent of the law.

#. Bluetooth conducted power table:

| Frequency (MHz) | Data Rate | Avg. | |
|-----------------|-----------|-------|-------|
| | | dBm | mW |
| 2402 | 1 | 3.51 | 2.244 |
| 2441 | 1 | 2.48 | 1.770 |
| 2480 | 1 | 1.98 | 1.578 |
| 2402 | 2 | -1.85 | 0.653 |
| 2441 | 2 | -3.23 | 0.475 |
| 2480 | 2 | -4.34 | 0.368 |
| 2402 | 3 | -3.11 | 0.489 |
| 2441 | 3 | -4.95 | 0.320 |
| 2480 | 3 | -5.65 | 0.272 |

| Frequency (MHz) | Avg. (dBm) |
|-----------------|------------|
| | BT4.0 |
| 2402 | 1.48 |
| 2442 | 0.41 |
| 2480 | 0.17 |

Unless otherwise stated the results shown in this test report refer only to the sample(s) tested and such sample(s) are retained for 90 days only.

除非另有說明，此報告結果僅對測試之樣品負責，同時此樣品僅保留90天。本報告未經本公司書面許可，不可部份複製。

This document is issued by the Company subject to its General Conditions of Service printed overleaf, available on request or accessible at www.sgs.com/terms_and_conditions.htm and, for electronic format documents, subject to Terms and Conditions for Electronic Documents at www.sgs.com/terms_e-document.htm. Attention is drawn to the limitation of liability, indemnification and jurisdiction issues defined therein. Any holder of this document is advised that information contained hereon reflects the Company's findings at the time of its intervention only and within the limits of Client's instructions, if any. The Company's sole responsibility is to its Client and this document does not exonerate parties to a transaction from exercising all their rights and obligations under the transaction documents. This document cannot be reproduced except in full, without prior written approval of the Company. Any unauthorized alteration, forgery or falsification of the content or appearance of this document is unlawful and offenders may be prosecuted to the fullest extent of the law.

1.4 Test Environment

Ambient Temperature: $22 \pm 2^\circ \text{C}$
Tissue Simulating Liquid: $22 \pm 2^\circ \text{C}$

1.5 Operation Description

1. WWAN (GPRS/EDGE/WCDMA/HSDPA/HSPA/CDMA 1xRTT/CDMA EVDO rev.0 & rev.A/LTE):

The EUT is controlled by using Radio Communication Tester(R&S CMU200 and Anritsu MT8820C), and the communication between the EUT and the tester is established by air link. **The EUT was tested in the following configurations confirmed via KDB inquiry. (tracking number: 781437)**

Configurations: Back/back_curve/top/bottom/left/right side_0mm.

(Testing the left_curve side is not required since the reported SAR is $< 1.2 \text{ W/kg}$ based on KDB inquiry 781437.)

2. WLAN (802.11 a/b/g/n):

Use chipset specific software to control the EUT, and makes it transmit in maximum power. **The EUT was tested in the following configurations confirmed via KDB inquiry. (tracking number: 781437)**

Configurations: Back/back_curve/top/bottom/left/right side_0mm.

(Testing the right_curve side is not required since the reported SAR is $< 1.2 \text{ W/kg}$ based on KDB inquiry 781437.)

Unless otherwise stated the results shown in this test report refer only to the sample(s) tested and such sample(s) are retained for 90 days only.

除非另有說明，此報告結果僅對測試之樣品負責，同時此樣品僅保留90天。本報告未經本公司書面許可，不可部份複製。

This document is issued by the Company subject to its General Conditions of Service printed overleaf, available on request or accessible at www.sgs.com/terms_and_conditions.htm and, for electronic format documents, subject to Terms and Conditions for Electronic Documents at www.sgs.com/terms_e-document.htm. Attention is drawn to the limitation of liability, indemnification and jurisdiction issues defined therein. Any holder of this document is advised that information contained hereon reflects the Company's findings at the time of its intervention only and within the limits of Client's instructions, if any. The Company's sole responsibility is to its Client and this document does not exonerate parties to a transaction from exercising all their rights and obligations under the transaction documents. This document cannot be reproduced except in full, without prior written approval of the Company. Any unauthorized alteration, forgery or falsification of the content or appearance of this document is unlawful and offenders may be prosecuted to the fullest extent of the law.

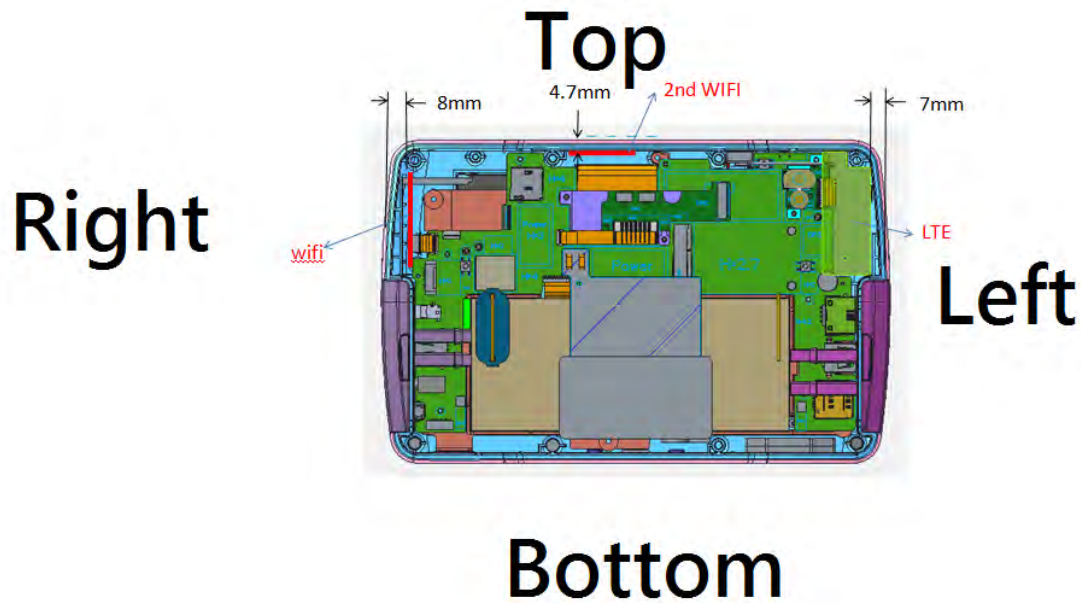

Antenna position plot(back view)

Unless otherwise stated the results shown in this test report refer only to the sample(s) tested and such sample(s) are retained for 90 days only.

除非另有說明，此報告結果僅對測試之樣品負責，同時此樣品僅保留90天。本報告未經本公司書面許可，不可部份複製。

This document is issued by the Company subject to its General Conditions of Service printed overleaf, available on request or accessible at www.sgs.com/terms_and_conditions.htm and, for electronic format documents, subject to Terms and Conditions for Electronic Documents at www.sgs.com/terms_e-document.htm. Attention is drawn to the limitation of liability, indemnification and jurisdiction issues defined therein. Any holder of this document is advised that information contained hereon reflects the Company's findings at the time of its intervention only and within the limits of Client's instructions, if any. The Company's sole responsibility is to its Client and this document does not exonerate parties to a transaction from exercising all their rights and obligations under the transaction documents. This document cannot be reproduced except in full, without prior written approval of the Company. Any unauthorized alteration, forgery or falsification of the content or appearance of this document is unlawful and offenders may be prosecuted to the fullest extent of the law.

Note:

1. SAR test for GPRS was performed on the maximum sourced-based time-averaged power.
2. SAR measurement is not required for HSDPA/HSPA/HSPA+ since its maximum output power is less than ¼ dB higher than RMC without HSDPA/HSPA/HSPA+.
3. Body SAR was measured using Subtype 0/1 Physical Layer configurations for Rev. 0. The 3G SAR test reduction procedure is applied to Rev. A, Subtype 2 Physical layer configuration, with Rev. 0 as the primary mode.
4. For this Ev-Do data device that also support 1x RTT data operations, the 3G SAR test reduction procedure is applied to 1x RTT RC3 and RC1 with Ev-Do Rev. 0, Rev. A as the respective primary modes. (Since SAR is not required for Ev-Do Rev. A, only Rev. 0 need consideration as the primary mode.)
5. LTE modes test according to **FCC KDB 941225 D05v02r03**.
 - a. Per Section 5.2.1, the largest channel bandwidth and measure SAR for QPSK with 1 RB allocation.
 - Using the RB offset and required test channel combination with the highest maximum output power for RB offsets at the upper edge, middle and lower edge of each required test channel.
 - When the reported SAR is ≤ 0.8 W/kg, testing of the remaining RB offset configurations and required test channels is not required for 1 RB allocation; otherwise, SAR is required for the remaining required test channels and only for the RB offset configuration with the highest output power for that channel.
 - When the reported SAR of a required test channel is > 1.45 W/kg, SAR is required for all three RB offset configurations for that required test channel.
 - b. Per Section 5.2.2, the largest channel bandwidth and measure SAR for QPSK with 50% RB allocation
 - The procedures required for 1 RB allocation in 5.2.1 are applied to measure the SAR for QPSK with 50% RB allocation.
 - c. Per Section 5.2.3, the largest channel bandwidth and measure SAR for QPSK with 100% RB allocation
 - For QPSK with 100% RB allocation, SAR is not required when the highest maximum output power for 100 % RB allocation is less than the highest maximum output power in 50% and 1 RB allocations and the highest reported SAR for 1 RB and 50% RB allocation in 5.2.1 and 5.2.2 are ≤ 0.8 W/kg.
 - Otherwise, SAR is measured for the highest output power channel and if the reported SAR is > 1.45 W/kg, the remaining required test channels must also be tested.
 - d. Per Section 5.2.4, Higher order modulations

Unless otherwise stated the results shown in this test report refer only to the sample(s) tested and such sample(s) are retained for 90 days only.

除非另有說明，此報告結果僅對測試之樣品負責，同時此樣品僅保留90天。本報告未經本公司書面許可，不可部份複製。

This document is issued by the Company subject to its General Conditions of Service printed overleaf, available on request or accessible at www.sgs.com/terms_and_conditions.htm and, for electronic format documents, subject to Terms and Conditions for Electronic Documents at www.sgs.com/terms_e-document.htm. Attention is drawn to the limitation of liability, indemnification and jurisdiction issues defined therein. Any holder of this document is advised that information contained hereon reflects the Company's findings at the time of its intervention only and within the limits of Client's instructions, if any. The Company's sole responsibility is to its Client and this document does not exonerate parties to a transaction from exercising all their rights and obligations under the transaction documents. This document cannot be reproduced except in full, without prior written approval of the Company. Any unauthorized alteration, forgery or falsification of the content or appearance of this document is unlawful and offenders may be prosecuted to the fullest extent of the law.

- For each modulation besides QPSK; e.g., 16-QAM, 64-QAM, apply the QPSK procedures in sections 5.2.1, 5.2.2 and 5.2.3 to determine the QAM configurations that may need SAR measurement. For each configuration identified as required for testing, SAR is required only when the highest maximum output power for the configuration in the higher order modulation is $> \frac{1}{2}$ dB higher than the same configuration in QPSK or when the reported SAR for the QPSK configuration is > 1.45 W/kg.
- e. Per Section 5.3, other channel bandwidth standalone SAR test requirements
 - For the other channel bandwidths used by the device in a frequency band, apply all the procedures required for the largest channel bandwidth in section 5.2 to determine the channels and RB configurations that need SAR testing and only measure SAR when the highest maximum output power of a configuration requiring testing in the smaller channel bandwidth is $> \frac{1}{2}$ dB higher than the equivalent channel configurations in the largest channel bandwidth configuration or the reported SAR of a configuration for the largest channel bandwidth is > 1.45 W/kg.
 - The equivalent channel configuration for the RB allocation, RB offset and modulation etc. is determined for the smaller channel bandwidth according to the same number of RB allocated in the largest channel bandwidth.

802.11b DSSS SAR Test Requirements:

6. SAR is measured for 2.4 GHz 802.11b DSSS mode using the highest measured maximum output power channel, when the reported SAR of the highest measured maximum output power channel for the exposure configuration is ≤ 0.8 W/kg, no further SAR testing is required for 802.11b DSSS in that exposure configuration.
7. When the reported SAR is > 0.8 W/kg, SAR is required for that exposure configuration using the next highest measured output power channel. When any reported SAR is > 1.2 W/kg, SAR is required for the third channel; i.e., all channels require testing.

802.11g/n OFDM SAR Test Exclusion Requirements:

8. SAR is not required for 802.11g/n since the highest reported SAR for DSSS is adjusted by the ratio of OFDM to DSSS specified maximum output power and the adjusted SAR is ≤ 1.2 W/kg.

Unless otherwise stated the results shown in this test report refer only to the sample(s) tested and such sample(s) are retained for 90 days only.

除非另有說明，此報告結果僅對測試之樣品負責，同時此樣品僅保留90天。本報告未經本公司書面許可，不可部份複製。

This document is issued by the Company subject to its General Conditions of Service printed overleaf, available on request or accessible at www.sgs.com/terms_and_conditions.htm and, for electronic format documents, subject to Terms and Conditions for Electronic Documents at www.sgs.com/terms_e-document.htm. Attention is drawn to the limitation of liability, indemnification and jurisdiction issues defined therein. Any holder of this document is advised that information contained hereon reflects the Company's findings at the time of its intervention only and within the limits of Client's instructions, if any. The Company's sole responsibility is to its Client and this document does not exonerate parties to a transaction from exercising all their rights and obligations under the transaction documents. This document cannot be reproduced except in full, without prior written approval of the Company. Any unauthorized alteration, forgery or falsification of the content or appearance of this document is unlawful and offenders may be prosecuted to the fullest extent of the law.

Initial Test Configuration:

9. An initial test configuration is determined for OFDM transmission modes according to the channel bandwidth, modulation and data rate combination(s) with the highest maximum output power specified for production units in each standalone and aggregated frequency band.
10. SAR is measured using the highest measured maximum output power channel. When the reported SAR of the initial test configuration is > 0.8 W/kg, SAR measurement is required for the subsequent next highest measured output power channel(s) in the initial test configuration until the reported SAR is ≤ 1.2 W/kg or all required channels are tested.
11. For WLAN Main & Aux antennas, 5.2G a/n(40), 5.3G n(20)/n(40), 5.6G n(20), 5.8G n(40) are chosen to be the initial test configurations.
12. For WLAN Main & Aux antennas, since the highest reported SAR for the initial test configuration is adjusted by the ratio of the subsequent test configuration to initial test configuration specified maximum output power and the adjusted SAR is < 1.2 W/kg, SAR is not required for that subsequent test configuration.
13. BT and WLAN Main use the same antenna path and Bluetooth can't transmit simultaneously with WLAN Main.
14. Based on KDB447498D01, BT SAR measurement for back/top/right/left/bottom sides can be excluded.

(1) SAR test exclusion thresholds for 100 MHz to 6 GHz at test separation distances ≤ 50 mm are determined by:

$$\frac{\text{Max. tune up power(mW)}}{\text{Min. test separation distance(mm)}} \times \sqrt{f(\text{GHz})} \leq 3$$

When the minimum test separation distance is < 5mm, 5mm is applied to determine SAR test exclusion.

(2) For test separation distances > 50 mm, and the frequency at 100 MHz to 1500MHz, the SAR test exclusion threshold is determined according to the following, and as illustrated in Appendix B of KDB447498 D01.

$$[(\text{Threshold at 50mm in step1}) + (\text{test separation distance}-50\text{mm}) \times \left(\frac{f(\text{MHz})}{150}\right)] (\text{mW}),$$

(3) For test separation distances > 50 mm, and the frequency at >1500MHz to 6GHz, the SAR test exclusion threshold is determined according to the following, and as illustrated in Appendix B of KDB447498 D01.

Unless otherwise stated the results shown in this test report refer only to the sample(s) tested and such sample(s) are retained for 90 days only.

除非另有說明，此報告結果僅對測試之樣品負責，同時此樣品僅保留90天。本報告未經本公司書面許可，不可部份複製。

This document is issued by the Company subject to its General Conditions of Service printed overleaf, available on request or accessible at www.sgs.com/terms_and_conditions.htm and, for electronic format documents, subject to Terms and Conditions for Electronic Documents at www.sgs.com/terms_e-document.htm. Attention is drawn to the limitation of liability, indemnification and jurisdiction issues defined therein. Any holder of this document is advised that information contained hereon reflects the Company's findings at the time of its intervention only and within the limits of Client's instructions, if any. The Company's sole responsibility is to its Client and this document does not exonerate parties to a transaction from exercising all their rights and obligations under the transaction documents. This document cannot be reproduced except in full, without prior written approval of the Company. Any unauthorized alteration, forgery or falsification of the content or appearance of this document is unlawful and offenders may be prosecuted to the fullest extent of the law.

| Mode | Maximum power(dBm) | Maximum power(mW) | Top side | | | Right side | | | Left side | | |
|------|--------------------|-------------------|----------------------|---------------------|----------------------|----------------------|---------------------|----------------------|----------------------|------------|----------------------|
| | | | Ant. to surface (mm) | Exclusion threshold | Require SAR testing? | Ant. to surface (mm) | Exclusion threshold | Require SAR testing? | Ant. to surface (mm) | over 200mm | Require SAR testing? |
| BT | 3.51 | 2.244 | 15.9 | 0.222 | NO | less than 5 | 0.707 | NO | 214.2 | yes | NO |
| Mode | Maximum power(dBm) | Maximum power(mW) | Back / back_curve | | | Bottom side | | | | | |
| | | | Ant. to surface (mm) | Exclusion threshold | Require SAR testing? | Ant. to surface (mm) | Exclusion threshold | Require SAR testing? | | | |
| BT | 3.51 | 2.244 | less than 5 | 0.707 | NO | 82.6 | 326.07 | NO | | | |

- 15.** For 2.4/5.2/5.3/5.6/5.8GHz WLAN Main and Aux antennas, the maximum output power of each antenna during simultaneous transmission (for 802.11n) is much less than that used in standalone transmission (802.11a/b/n), so it is more conservative to use the sum of 1-g SAR provision to exclude the SAR measurement for 802.11n MIMO.
- 16.** According to KDB447498 D01, testing of other required channels is not required when the reported 1-g SAR for the highest output channel is ≤ 0.8 W/kg, when the transmission band is ≤ 100 MHz.
- 17.** According to KDB865664 D01, SAR measurement variability must be assessed for each frequency band. When the original highest measured SAR is ≥ 0.8 W/kg, repeated that measurement once. Perform a second repeated measurement only if the ratio of largest to smallest SAR for the original and first repeated measurements is > 1.20 or when the original or repeated measurement is ≥ 1.45 W/kg (~ 10% from the 1-g SAR limit).

Unless otherwise stated the results shown in this test report refer only to the sample(s) tested and such sample(s) are retained for 90 days only.

除非另有說明，此報告結果僅對測試之樣品負責，同時此樣品僅保留90天。本報告未經本公司書面許可，不可部份複製。

This document is issued by the Company subject to its General Conditions of Service printed overleaf, available on request or accessible at www.sgs.com/terms_and_conditions.htm and, for electronic format documents, subject to Terms and Conditions for Electronic Documents at www.sgs.com/terms_e-document.htm. Attention is drawn to the limitation of liability, indemnification and jurisdiction issues defined therein. Any holder of this document is advised that information contained hereon reflects the Company's findings at the time of its intervention only and within the limits of Client's instructions, if any. The Company's sole responsibility is to its Client and this document does not exonerate parties to a transaction from exercising all their rights and obligations under the transaction documents. This document cannot be reproduced except in full, without prior written approval of the Company. Any unauthorized alteration, forgery or falsification of the content or appearance of this document is unlawful and offenders may be prosecuted to the fullest extent of the law.

1.6 The SAR Measurement System

A block diagram of the SAR measurement System is given in Fig. a. This SAR Measurement System uses a Computer-controlled 3-D stepper motor system (SPEAG DASY 5 professional system). The model EX3DV4 field probe is used to determine the internal electric fields. The SAR can be obtained from the equation $SAR = \sigma (|E_i|^2) / \rho$ where σ and ρ are the conductivity and mass density of the tissue-simulant.

The DASY 5 system for performing compliance tests consists of the following items:

- A standard high precision 6-axis robot (Staubli RX family) with controller, teach pendant and software. An arm extension is for accommodating the data acquisition electronics (DAE).
- A dosimetric probe, i.e., an isotropic E-field probe optimized and calibrated for usage in tissue simulating liquid. The probe is equipped with an optical surface detector system.
- A data acquisition electronics (DAE) which performs the signal amplification, signal multiplexing, AD-conversion, offset measurements, mechanical surface detection, collision detection, etc. The unit is battery powered with standard or rechargeable batteries. The signal is optically transmitted to the EOC.

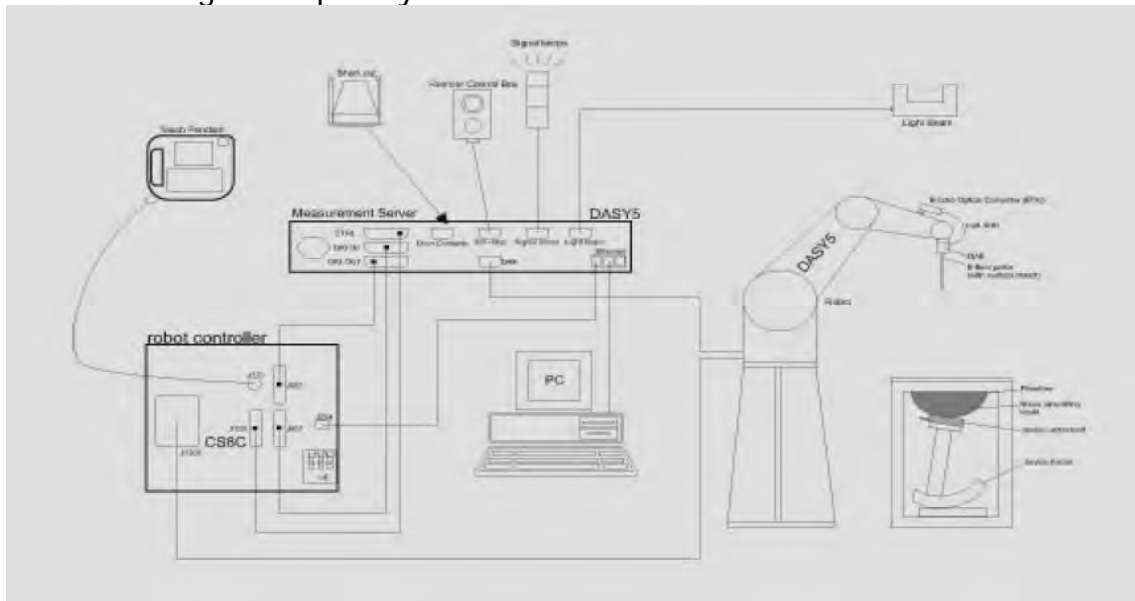

Fig. a The block diagram of SAR system

Unless otherwise stated the results shown in this test report refer only to the sample(s) tested and such sample(s) are retained for 90 days only.
除非另有說明，此報告結果僅對測試之樣品負責，同時此樣品僅保留90天。本報告未經本公司書面許可，不可部份複製。

This document is issued by the Company subject to its General Conditions of Service printed overleaf, available on request or accessible at www.sgs.com/terms_and_conditions.htm and, for electronic format documents, subject to Terms and Conditions for Electronic Documents at www.sgs.com/terms_e-document.htm. Attention is drawn to the limitation of liability, indemnification and jurisdiction issues defined therein. Any holder of this document is advised that information contained hereon reflects the Company's findings at the time of its intervention only and within the limits of Client's instructions, if any. The Company's sole responsibility is to its Client and this document does not exonerate parties to a transaction from exercising all their rights and obligations under the transaction documents. This document cannot be reproduced except in full, without prior written approval of the Company. Any unauthorized alteration, forgery or falsification of the content or appearance of this document is unlawful and offenders may be prosecuted to the fullest extent of the law.

- The Electro-optical converter (EOC) performs the conversion between optical and electrical of the signals for the digital communication to the DAE and for the analog signal from the optical surface detection. The EOC is connected to the measurement server.
 - The function of the measurement server is to perform the time critical tasks such as signal filtering, control of the robot operation and fast movement interrupts.
 - A probe alignment unit which improves the (absolute) accuracy of the probe positioning.
 - A computer operating Windows 7.
 - DASY 5 software.
 - Remote control with teach pendant and additional circuitry for robot safety such as warning lamps, etc.
 - The SAM twin phantom enabling testing left-hand and right-hand usage.
 - The device holder for handheld mobile phones.
 - Tissue simulating liquid mixed according to the given recipes.
- Validation dipole kits allowing to validate the proper functioning of the system.

Unless otherwise stated the results shown in this test report refer only to the sample(s) tested and such sample(s) are retained for 90 days only.

除非另有說明，此報告結果僅對測試之樣品負責，同時此樣品僅保留90天。本報告未經本公司書面許可，不可部份複製。

This document is issued by the Company subject to its General Conditions of Service printed overleaf, available on request or accessible at www.sgs.com/terms_and_conditions.htm and, for electronic format documents, subject to Terms and Conditions for Electronic Documents at www.sgs.com/terms_e-document.htm. Attention is drawn to the limitation of liability, indemnification and jurisdiction issues defined therein. Any holder of this document is advised that information contained hereon reflects the Company's findings at the time of its intervention only and within the limits of Client's instructions, if any. The Company's sole responsibility is to its Client and this document does not exonerate parties to a transaction from exercising all their rights and obligations under the transaction documents. This document cannot be reproduced except in full, without prior written approval of the Company. Any unauthorized alteration, forgery or falsification of the content or appearance of this document is unlawful and offenders may be prosecuted to the fullest extent of the law.

1.7 System Components

EX3DV4 E-Field Probe

| | | |
|---------------|--|---|
| Construction | Symmetrical design with triangular core Built-in shielding against static charges PEEK enclosure material (resistant to organic solvents, e.g., DGBE) |  |
| Calibration | Basic Broad Band Calibration in air Conversion Factors (CF) for HSL 750/835/ 1750/1900/2450/5200/5300/5600/5800 MHz Additional CF for other liquids and frequencies upon request | |
| Frequency | 10 MHz to > 6 GHz | |
| Directivity | ± 0.3 dB in HSL (rotation around probe axis) ± 0.5 dB in tissue material (rotation normal to probe axis) | |
| Dynamic Range | 10 µW/g to > 100 mW/g Linearity: ± 0.2 dB (noise: typically < 1 µW/g) | |
| Dimensions | Tip diameter: 2.5 mm | |
| Application | High precision dosimetric measurements in any exposure scenario (e.g., very strong gradient fields). Only probe which enables compliance testing for frequencies up to 6 GHz with precision of better 30%. | |

Unless otherwise stated the results shown in this test report refer only to the sample(s) tested and such sample(s) are retained for 90 days only.

除非另有說明，此報告結果僅對測試之樣品負責，同時此樣品僅保留90天。本報告未經本公司書面許可，不可部份複製。

This document is issued by the Company subject to its General Conditions of Service printed overleaf, available on request or accessible at www.sgs.com/terms_and_conditions.htm and, for electronic format documents, subject to Terms and Conditions for Electronic Documents at www.sgs.com/terms_e-document.htm. Attention is drawn to the limitation of liability, indemnification and jurisdiction issues defined therein. Any holder of this document is advised that information contained hereon reflects the Company's findings at the time of its intervention only and within the limits of Client's instructions, if any. The Company's sole responsibility is to its Client and this document does not exonerate parties to a transaction from exercising all their rights and obligations under the transaction documents. This document cannot be reproduced except in full, without prior written approval of the Company. Any unauthorized alteration, forgery or falsification of the content or appearance of this document is unlawful and offenders may be prosecuted to the fullest extent of the law.

SAM PHANTOM V4.0C

| | | |
|-----------------|--|---|
| Construction | <p>The shell corresponds to the specifications of the Specific Anthropomorphic Mannequin (SAM) phantom defined in IEEE 1528 and IEC 62209.</p> <p>It enables the dosimetric evaluation of left and right hand phone usage as well as body mounted usage at the flat phantom region. A cover prevents evaporation of the liquid. Reference markings on the phantom allow the complete setup of all predefined phantom positions and measurement grids by manually teaching three points with the robot.</p> | |
| Shell Thickness | 2 ± 0.2 mm |  |
| Filling Volume | Approx. 25 liters | |
| Dimensions | Height: 850 mm; Length: 1000 mm; Width: 500 mm | |

DEVICE HOLDER

| | | |
|--------------|---|---|
| Construction | <p>The device holder (Supporter) for Notebook is made by POM (polyoxymethylene resin) , which is non-metal and non-conductive.</p> <p>The height can be adjusted to fit varies kind of notebooks.</p> |  <p style="text-align: center;">Device Holder</p> |
|--------------|---|---|

Unless otherwise stated the results shown in this test report refer only to the sample(s) tested and such sample(s) are retained for 90 days only.

除非另有說明，此報告結果僅對測試之樣品負責，同時此樣品僅保留90天。本報告未經本公司書面許可，不可部份複製。

This document is issued by the Company subject to its General Conditions of Service printed overleaf, available on request or accessible at www.sgs.com/terms_and_conditions.htm and, for electronic format documents, subject to Terms and Conditions for Electronic Documents at www.sgs.com/terms_e-document.htm. Attention is drawn to the limitation of liability, indemnification and jurisdiction issues defined therein. Any holder of this document is advised that information contained hereon reflects the Company's findings at the time of its intervention only and within the limits of Client's instructions, if any. The Company's sole responsibility is to its Client and this document does not exonerate parties to a transaction from exercising all their rights and obligations under the transaction documents. This document cannot be reproduced except in full, without prior written approval of the Company. Any unauthorized alteration, forgery or falsification of the content or appearance of this document is unlawful and offenders may be prosecuted to the fullest extent of the law.

1.8 SAR System Verification

The microwave circuit arrangement for system verification is sketched in Fig. b. The daily system accuracy verification occurs within the flat section of the SAM phantom. A SAR measurement was performed to see if the measured SAR was within $\pm 10\%$ from the target SAR values. These tests were done at 750/835/1750/1900/2450/5200/5300/5600/5800MHz. The tests were conducted on the same days as the measurement of the DUT. The obtained results from the system accuracy verification are displayed in the table 1 (SAR values are normalized to 1W forward power delivered to the dipole). During the tests, the ambient temperature of the laboratory was 21.7°C , the relative humidity was 62% and the liquid depth above the ear reference points was $\geq 15\text{ cm} \pm 5\text{ mm}$ (frequency $\leq 3\text{ GHz}$) or $\geq 10\text{ cm} \pm 5\text{ mm}$ (frequency $> 3\text{ GHz}$) in all the cases. It is seen that the system is operating within its specification, as the results are within acceptable tolerance of the reference values.

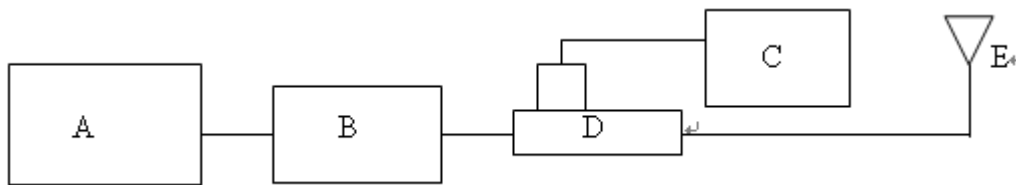

Fig. b The block diagram of system verification

- A. Signal generator
- B. Amplifier
- C. Power meter
- D. Dual directional coupling
- E. Reference dipole antenna



Photograph of the dipole Antenna

Unless otherwise stated the results shown in this test report refer only to the sample(s) tested and such sample(s) are retained for 90 days only.
除非另有說明，此報告結果僅對測試之樣品負責，同時此樣品僅保留90天。本報告未經本公司書面許可，不可部份複製。

This document is issued by the Company subject to its General Conditions of Service printed overleaf, available on request or accessible at www.sgs.com/terms_and_conditions.htm and, for electronic format documents, subject to Terms and Conditions for Electronic Documents at www.sgs.com/terms_e-document.htm. Attention is drawn to the limitation of liability, indemnification and jurisdiction issues defined therein. Any holder of this document is advised that information contained hereon reflects the Company's findings at the time of its intervention only and within the limits of Client's instructions, if any. The Company's sole responsibility is to its Client and this document does not exonerate parties to a transaction from exercising all their rights and obligations under the transaction documents. This document cannot be reproduced except in full, without prior written approval of the Company. Any unauthorized alteration, forgery or falsification of the content or appearance of this document is unlawful and offenders may be prosecuted to the fullest extent of the law.

| Validation Kit | S/N | Frequency (MHz) | | 1W Target SAR-1g (mW/g) | Measured SAR-1g (mW/g) | Measured SAR-1g normalized to 1W (mW/g) | Deviation (%) | Measured Date |
|----------------|-------|-----------------|------|-------------------------|------------------------|---|---------------|---------------|
| D750V2 | 1015 | 750 | Body | 8.75 | 2.18 | 8.72 | -0.34% | Jun. 15, 2015 |
| D835V2 | 4d063 | 835 | Body | 9.35 | 2.42 | 9.68 | 3.53% | Jun. 16, 2015 |
| D1750V2 | 1008 | 1750 | Body | 37.5 | 9.43 | 37.72 | 0.59% | Jun. 17, 2015 |
| D1900V2 | 5d027 | 1900 | Body | 39.3 | 9.87 | 39.48 | 0.46% | Jun. 18, 2015 |
| D2450V2 | 727 | 2450 | Body | 51 | 13.8 | 55.2 | 8.24% | Jun. 19, 2015 |
| D5GHzV2 | 1023 | 5200 | Body | 73.5 | 7.08 | 70.8 | -3.67% | Jun. 20, 2015 |
| | | 5300 | Body | 74.6 | 7.49 | 74.9 | 0.40% | Jun. 21, 2015 |
| | | 5600 | Body | 77.9 | 7.81 | 78.1 | 0.26% | Jun. 22, 2015 |
| | | 5800 | Body | 75.6 | 7.51 | 75.1 | -0.66% | Jun. 22, 2015 |

Table 1. Results of system validation

Unless otherwise stated the results shown in this test report refer only to the sample(s) tested and such sample(s) are retained for 90 days only.

除非另有說明，此報告結果僅對測試之樣品負責，同時此樣品僅保留90天。本報告未經本公司書面許可，不可部份複製。

This document is issued by the Company subject to its General Conditions of Service printed overleaf, available on request or accessible at www.sgs.com/terms_and_conditions.htm and, for electronic format documents, subject to Terms and Conditions for Electronic Documents at www.sgs.com/terms_e-document.htm. Attention is drawn to the limitation of liability, indemnification and jurisdiction issues defined therein. Any holder of this document is advised that information contained hereon reflects the Company's findings at the time of its intervention only and within the limits of Client's instructions, if any. The Company's sole responsibility is to its Client and this document does not exonerate parties to a transaction from exercising all their rights and obligations under the transaction documents. This document cannot be reproduced except in full, without prior written approval of the Company. Any unauthorized alteration, forgery or falsification of the content or appearance of this document is unlawful and offenders may be prosecuted to the fullest extent of the law.

1.9 Tissue Simulant Fluid for the Frequency Band

The dielectric properties for this body-simulant fluid were measured by using the Agilent Model 85070E Dielectric Probe (rates frequency band 200 MHz to 20 GHz) in conjunction with Network Analyzer (30 KHz-6000 MHz).

All dielectric parameters of tissue simulates were measured within 24 hours of SAR measurements. The depth of the tissue simulant in the flat section of the phantom was $\geq 15 \text{ cm} \pm 5 \text{ mm}$ (Frequency $\leq 3\text{G}$) or $\geq 10 \text{ cm} \pm 5 \text{ mm}$ (Frequency $> 3\text{G}$) during all tests. (Fig. 2)

| Tissue Type | Measured Frequency (MHz) | Target Dielectric Constant, ϵ_r | Target Conductivity, σ (S/m) | Measured Dielectric Constant, ϵ_r | Measured Conductivity, σ (S/m) | % dev ϵ_r | % dev σ | Measurement Date |
|-------------|--------------------------|--|-------------------------------------|--|---------------------------------------|--------------------|----------------|------------------|
| Body | 711 | 55.683 | 0.960 | 53.797 | 0.974 | 3.39% | -1.42% | June,15 2015 |
| | 750 | 55.531 | 0.963 | 53.393 | 0.981 | 3.85% | -1.83% | |
| | 782 | 55.406 | 0.966 | 53.042 | 1.005 | 4.27% | -4.05% | |
| | 818 | 55.267 | 0.969 | 56.831 | 0.994 | -2.83% | -2.62% | June,16 2015 |
| | 820 | 55.258 | 0.969 | 56.806 | 0.995 | -2.80% | -2.70% | |
| | 823.1 | 55.246 | 0.969 | 56.773 | 0.999 | -2.76% | -3.09% | |
| | 824.2 | 55.242 | 0.969 | 56.743 | 0.999 | -2.72% | -3.08% | |
| | 825 | 55.240 | 0.969 | 56.719 | 1 | -2.68% | -3.18% | |
| | 826.4 | 55.234 | 0.969 | 56.7 | 1 | -2.66% | -3.16% | |
| | 835 | 55.200 | 0.970 | 56.648 | 1.01 | -2.62% | -4.12% | |
| | 836.52 | 55.195 | 0.972 | 56.669 | 1.014 | -2.67% | -4.33% | |
| | 836.6 | 55.195 | 0.972 | 56.669 | 1.014 | -2.67% | -4.32% | |
| | 844 | 55.172 | 0.981 | 56.606 | 1.02 | -2.60% | -3.97% | |
| | 848.31 | 55.159 | 0.986 | 56.511 | 1.025 | -2.45% | -3.92% | |
| | 849 | 55.158 | 0.987 | 56.515 | 1.026 | -2.46% | -3.95% | |
| | 1712.4 | 53.531 | 1.465 | 52.882 | 1.409 | 1.21% | 3.80% | June,17 2015 |
| | 1720 | 53.511 | 1.469 | 52.85 | 1.414 | 1.23% | 3.78% | |
| | 1732.4 | 53.478 | 1.477 | 52.833 | 1.425 | 1.21% | 3.54% | |
| | 1732.5 | 53.478 | 1.477 | 52.831 | 1.425 | 1.21% | 3.54% | |
| | 1732.6 | 53.477 | 1.477 | 52.831 | 1.425 | 1.21% | 3.55% | |
| | 1745 | 53.445 | 1.485 | 52.822 | 1.437 | 1.17% | 3.25% | |
| 1750 | 53.432 | 1.488 | 52.821 | 1.442 | 1.14% | 3.12% | | |
| 1752.6 | 53.425 | 1.490 | 52.808 | 1.446 | 1.15% | 2.96% | | |

Unless otherwise stated the results shown in this test report refer only to the sample(s) tested and such sample(s) are retained for 90 days only.

除非另有說明，此報告結果僅對測試之樣品負責，同時此樣品僅保留90天。本報告未經本公司書面許可，不可部份複製。

This document is issued by the Company subject to its General Conditions of Service printed overleaf, available on request or accessible at www.sgs.com/terms_and_conditions.htm and, for electronic format documents, subject to Terms and Conditions for Electronic Documents at www.sgs.com/terms_e-document.htm. Attention is drawn to the limitation of liability, indemnification and jurisdiction issues defined therein. Any holder of this document is advised that information contained hereon reflects the Company's findings at the time of its intervention only and within the limits of Client's instructions, if any. The Company's sole responsibility is to its Client and this document does not exonerate parties to a transaction from exercising all their rights and obligations under the transaction documents. This document cannot be reproduced except in full, without prior written approval of the Company. Any unauthorized alteration, forgery or falsification of the content or appearance of this document is unlawful and offenders may be prosecuted to the fullest extent of the law.

| Tissue Type | Measured Frequency (MHz) | Target Dielectric Constant, ϵ_r | Target Conductivity, σ (S/m) | Measured Dielectric Constant, ϵ_r | Measured Conductivity, σ (S/m) | % dev ϵ_r | % dev σ | Measurement Date |
|-------------|--------------------------|--|-------------------------------------|--|---------------------------------------|--------------------|----------------|------------------|
| Body | 1850.2 | 53.300 | 1.520 | 53.753 | 1.45 | -0.85% | 4.61% | June,18 2015 |
| | 1851.25 | 53.300 | 1.520 | 53.749 | 1.453 | -0.84% | 4.41% | |
| | 1852.4 | 53.300 | 1.520 | 53.75 | 1.454 | -0.84% | 4.34% | |
| | 1860 | 53.300 | 1.520 | 53.718 | 1.459 | -0.78% | 4.01% | |
| | 1880 | 53.300 | 1.520 | 53.657 | 1.481 | -0.67% | 2.57% | |
| | 1882.5 | 53.300 | 1.520 | 53.678 | 1.482 | -0.71% | 2.50% | |
| | 1900 | 53.300 | 1.520 | 53.595 | 1.501 | -0.55% | 1.25% | |
| | 1905 | 53.300 | 1.520 | 53.572 | 1.508 | -0.51% | 0.79% | |
| | 1907.6 | 53.300 | 1.520 | 53.58 | 1.511 | -0.53% | 0.59% | |
| | 1908.75 | 53.300 | 1.520 | 53.621 | 1.513 | -0.60% | 0.46% | |
| | 1910 | 53.300 | 1.520 | 53.584 | 1.513 | -0.53% | 0.46% | June,19 2015 |
| | 2412 | 52.751 | 1.914 | 51.436 | 1.992 | 2.49% | -4.09% | |
| | 2437 | 52.717 | 1.938 | 51.353 | 2.019 | 2.59% | -4.20% | |
| | 2450 | 52.700 | 1.950 | 51.276 | 2.037 | 2.70% | -4.46% | |
| | 2462 | 52.685 | 1.967 | 51.248 | 2.051 | 2.73% | -4.27% | June,20 2015 |
| | 5180 | 49.041 | 5.276 | 48.079 | 5.424 | 1.96% | -2.81% | |
| | 5190 | 49.028 | 5.288 | 48.005 | 5.443 | 2.09% | -2.94% | |
| | 5200 | 49.014 | 5.299 | 47.93 | 5.462 | 2.21% | -3.07% | |
| | 5220 | 48.987 | 5.323 | 47.853 | 5.492 | 2.32% | -3.18% | |
| | 5230 | 48.974 | 5.334 | 47.832 | 5.507 | 2.33% | -3.24% | |
| | 5240 | 48.960 | 5.346 | 47.811 | 5.522 | 2.35% | -3.29% | June,21 2015 |
| | 5260 | 48.933 | 5.369 | 47.733 | 5.552 | 2.45% | -3.40% | |
| | 5270 | 48.919 | 5.381 | 47.696 | 5.567 | 2.50% | -3.46% | |
| | 5300 | 48.879 | 5.416 | 47.56 | 5.609 | 2.70% | -3.56% | |
| | 5310 | 48.865 | 5.428 | 47.554 | 5.618 | 2.68% | -3.51% | June,22 2015 |
| | 5320 | 48.851 | 5.439 | 47.523 | 5.627 | 2.72% | -3.45% | |
| | 5520 | 48.580 | 5.673 | 46.795 | 5.91 | 3.67% | -4.18% | |
| | 5600 | 48.471 | 5.766 | 46.575 | 6.004 | 3.91% | -4.12% | |
| | 5700 | 48.336 | 5.883 | 46.301 | 6.037 | 4.21% | -2.61% | |
| | 5755 | 48.261 | 5.947 | 46.129 | 6.195 | 4.42% | -4.16% | |
| 5795 | 48.207 | 5.994 | 46.024 | 6.208 | 4.53% | -3.57% | June,22 2015 | |
| 5800 | 48.200 | 6.000 | 46.008 | 6.21 | 4.55% | -3.50% | | |

Table 2. Dielectric Parameters of Tissue Simulant Fluid

Unless otherwise stated the results shown in this test report refer only to the sample(s) tested and such sample(s) are retained for 90 days only.

除非另有說明，此報告結果僅對測試之樣品負責，同時此樣品僅保留90天。本報告未經本公司書面許可，不可部份複製。

This document is issued by the Company subject to its General Conditions of Service printed overleaf, available on request or accessible at www.sgs.com/terms_and_conditions.htm and, for electronic format documents, subject to Terms and Conditions for Electronic Documents at www.sgs.com/terms_e-document.htm. Attention is drawn to the limitation of liability, indemnification and jurisdiction issues defined therein. Any holder of this document is advised that information contained hereon reflects the Company's findings at the time of its intervention only and within the limits of Client's instructions, if any. The Company's sole responsibility is to its Client and this document does not exonerate parties to a transaction from exercising all their rights and obligations under the transaction documents. This document cannot be reproduced except in full, without prior written approval of the Company. Any unauthorized alteration, forgery or falsification of the content or appearance of this document is unlawful and offenders may be prosecuted to the fullest extent of the law.

The composition of the body tissue simulating liquid:

| Frequency (MHz) | Mode | Ingredient | | | | | | Total amount |
|-----------------|------|------------|----------|---------|---------------|-----------|-------|--------------|
| | | DGMBE | Water | Salt | Preventol D-7 | Cellulose | Sugar | |
| 750 | Body | — | 631.68 g | 11.72 g | 1.2 g | — | 600 g | 1.0L(Kg) |
| 850 | Body | — | 631.68 g | 11.72 g | 1.2 g | — | 600 g | 1.0L(Kg) |
| 1750 | Body | 300.67 g | 716.56 g | 4.0 g | — | — | — | 1.0L(Kg) |
| 1900 | Body | 300.67 g | 716.56 g | 4.0 g | — | — | — | 1.0L(Kg) |
| 2450 | Body | 301.7ml | 698.3ml | — | — | — | — | 1.0L(Kg) |

Simulating Liquids for 5 GHz, Manufactured by SPEAG:

| Ingredients | Water | Esters, Emulsifiers, Inhibitors | Sodium and Salt |
|---------------|-------|---------------------------------|-----------------|
| (% by weight) | 60-80 | 20-40 | 0-1.5 |

Table 3. Recipes for Tissue Simulating Liquid

Unless otherwise stated the results shown in this test report refer only to the sample(s) tested and such sample(s) are retained for 90 days only.

除非另有說明，此報告結果僅對測試之樣品負責，同時此樣品僅保留90天。本報告未經本公司書面許可，不可部份複製。

This document is issued by the Company subject to its General Conditions of Service printed overleaf, available on request or accessible at www.sgs.com/terms_and_conditions.htm and, for electronic format documents, subject to Terms and Conditions for Electronic Documents at www.sgs.com/terms_e-document.htm. Attention is drawn to the limitation of liability, indemnification and jurisdiction issues defined therein. Any holder of this document is advised that information contained hereon reflects the Company's findings at the time of its intervention only and within the limits of Client's instructions, if any. The Company's sole responsibility is to its Client and this document does not exonerate parties to a transaction from exercising all their rights and obligations under the transaction documents. This document cannot be reproduced except in full, without prior written approval of the Company. Any unauthorized alteration, forgery or falsification of the content or appearance of this document is unlawful and offenders may be prosecuted to the fullest extent of the law.

1.10 Evaluation Procedures

The entire evaluation of the spatial peak values is performed within the Post-processing engine (SEMCAD). The system always gives the maximum values for the 1 g and 10 g cubes. The algorithm to find the cube with highest averaged SAR is divided into the following stages:

1. The extraction of the measured data (grid and values) from the Zoom Scan.
2. The calculation of the SAR value at every measurement point based on all stored data (A/D values and measurement parameters)
3. The generation of a high-resolution mesh within the measured volume
4. The interpolation of all measured values from the measurement grid to the high-resolution grid
5. The extrapolation of the entire 3-D field distribution to the phantom surface over the distance from sensor to surface
6. The calculation of the averaged SAR within masses of 1g and 10g.

The probe is calibrated at the center of the dipole sensors that is located 1 to 2.7mm away from the probe tip. During measurements, the probe stops shortly above the phantom surface, depending on the probe and the surface detecting system. Both distances are included as parameters in the probe configuration file. The software always knows exactly how far away the measured point is from the surface. As the probe cannot directly measure at the surface, the values between the deepest measured point and the surface must be extrapolated. The angle between the probe axis and the surface normal line is less than 30 degree.

In the Area Scan, the gradient of the interpolation function is evaluated to find all the extreme of the SAR distribution. The uncertainty on the locations of the extreme is less than 1/20 of the grid size. Only local maximum within -2 dB of the global maximum are searched and passed for the Cube Scan measurement. In the Cube Scan, the interpolation function is used to extrapolate the Peak SAR from the lowest measurement points to the inner phantom surface (the extrapolation distance). The uncertainty increases with the extrapolation distance. To keep the uncertainty within 1% for the 1 g and 10 g cubes, the extrapolation distance should not be larger than 5mm.

The maximum search is automatically performed after each area scan measurement. It is based on splines in two or three dimensions. The procedure can find the maximum for most SAR distributions even with relatively large grid spacing. After the area scanning measurement, the probe is automatically moved to a position at the interpolated maximum. The following scan can directly use this position for reference, e.g., for a finer resolution grid or the cube evaluations. The 1g and 10g peak evaluations are only available for the predefined cube 7x7x7 scans. The routines are verified and optimized for the grid dimensions used in these cube measurements.

Unless otherwise stated the results shown in this test report refer only to the sample(s) tested and such sample(s) are retained for 90 days only.

除非另有說明，此報告結果僅對測試之樣品負責，同時此樣品僅保留90天。本報告未經本公司書面許可，不可部份複製。

This document is issued by the Company subject to its General Conditions of Service printed overleaf, available on request or accessible at www.sgs.com/terms_and_conditions.htm and, for electronic format documents, subject to Terms and Conditions for Electronic Documents at www.sgs.com/terms_e-document.htm. Attention is drawn to the limitation of liability, indemnification and jurisdiction issues defined therein. Any holder of this document is advised that information contained hereon reflects the Company's findings at the time of its intervention only and within the limits of Client's instructions, if any. The Company's sole responsibility is to its Client and this document does not exonerate parties to a transaction from exercising all their rights and obligations under the transaction documents. This document cannot be reproduced except in full, without prior written approval of the Company. Any unauthorized alteration, forgery or falsification of the content or appearance of this document is unlawful and offenders may be prosecuted to the fullest extent of the law.

The measured volume of 30x30x30mm contains about 30g of tissue.

The first procedure is an extrapolation (incl. Boundary correction) to get the points between the lowest measured plane and the surface. The next step uses 3D interpolation to get all points within the measured volume. In the last step, a 1g cube is placed numerically into the volume and its averaged SAR is calculated. This cube is moved around until the highest averaged SAR is found. If the highest SAR is found at the edge of the measured volume, the system will issue a warning: higher SAR values might be found outside of the measured volume. In that case the cube measurement can be repeated, using the new interpolated maximum as the center.

1.11 Probe Calibration Procedures

For the calibration of E-field probes in lossy liquids, an electric field with an accurately known field strength must be produced within the measured liquid. For standardization purposes it would be desirable if all measurements which are necessary to assess the correct field strength would be traceable to standardized measurement procedures. In the following two different calibration techniques are summarized:

1.11.1 Transfer Calibration with Temperature Probes

In lossy liquids the specific absorption rate (SAR) is related both to the electric field (E) and the temperature gradient ($\delta T / \delta t$) in the liquid.

$$SAR = \frac{\sigma}{\rho} |E|^2 = c \frac{\delta T}{\delta t}$$

whereby σ is the conductivity, ρ the density and c the heat capacity of the liquid.

Hence, the electric field in lossy liquid can be measured indirectly by measuring the temperature gradient in the liquid. Non-disturbing temperature probes (optical probes or thermistor probes with resistive lines) with high spatial resolution (<1-2 mm) and fast reaction time (<1 s) are available and can be easily calibrated with high precision [1]. The setup and the exciting source have no influence on the calibration; only the relative positioning uncertainties of the standard temperature probe and the E-field probe to be calibrated must be considered. However, several problems limit the available accuracy of probe calibrations with temperature probes:

- The temperature gradient is not directly measurable but must be evaluated from temperature measurements at different time steps. Special precaution is necessary to avoid measurement errors caused by temperature gradients due to energy equalizing effects or convection currents in the liquid. Such effects cannot be completely avoided, as the measured field itself destroys the thermal equilibrium in the liquid. With a careful setup these errors can be kept small.

Unless otherwise stated the results shown in this test report refer only to the sample(s) tested and such sample(s) are retained for 90 days only.

除非另有說明，此報告結果僅對測試之樣品負責，同時此樣品僅保留90天。本報告未經本公司書面許可，不可部份複製。

This document is issued by the Company subject to its General Conditions of Service printed overleaf, available on request or accessible at www.sgs.com/terms_and_conditions.htm and, for electronic format documents, subject to Terms and Conditions for Electronic Documents at www.sgs.com/terms_e-document.htm. Attention is drawn to the limitation of liability, indemnification and jurisdiction issues defined therein. Any holder of this document is advised that information contained hereon reflects the Company's findings at the time of its intervention only and within the limits of Client's instructions, if any. The Company's sole responsibility is to its Client and this document does not exonerate parties to a transaction from exercising all their rights and obligations under the transaction documents. This document cannot be reproduced except in full, without prior written approval of the Company. Any unauthorized alteration, forgery or falsification of the content or appearance of this document is unlawful and offenders may be prosecuted to the fullest extent of the law.

- The measured volume around the temperature probe is not well defined. It is difficult to calculate the energy transfer from a surrounding gradient temperature field into the probe. These effects must be considered, since temperature probes are calibrated in liquid with homogeneous temperatures. There is no traceable standard for temperature rise measurements.
- The calibration depends on the assessment of the specific density, the heat capacity and the conductivity of the medium. While the specific density and heat capacity can be measured accurately with standardized procedures ($\sim 2\%$ for c ; much better for ρ), there is no standard for the measurement of the conductivity. Depending on the method and liquid, the error can well exceed $\pm 5\%$.
- Temperature rise measurements are not very sensitive and therefore are often performed at a higher power level than the E-field measurements. The nonlinearities in the system (e.g., power measurements, different components, etc.) must be considered.

Considering these problems, the possible accuracy of the calibration of E-field probes with temperature gradient measurements in a carefully designed setup is about $\pm 10\%$ (RSS) [2]. Recently, a setup which is a combination of the waveguide techniques and the thermal measurements was presented in [3]. The estimated uncertainty of the setup is $\pm 5\%$ (RSS) when the same liquid is used for the calibration and for actual measurements and $\pm 7-9\%$ (RSS) when not, which is in good agreement with the estimates given in [2].

1.11.2 Calibration with Analytical Fields

In this method a technical setup is used in which the field can be calculated analytically from measurements of other physical magnitudes (e.g., input power). This corresponds to the standard field method for probe calibration in air; however, there is no standard defined for fields in lossy liquids.

When using calculated fields in lossy liquids for probe calibration, several points must be considered in the assessment of the uncertainty:

- The setup must enable accurate determination of the incident power.
- The accuracy of the calculated field strength will depend on the assessment of the dielectric parameters of the liquid.
- Due to the small wavelength in liquids with high permittivity, even small setups might be above the resonant cutoff frequencies. The field distribution in the setup must be carefully checked for conformity with the theoretical field distribution.

Unless otherwise stated the results shown in this test report refer only to the sample(s) tested and such sample(s) are retained for 90 days only.

除非另有說明，此報告結果僅對測試之樣品負責，同時此樣品僅保留90天。本報告未經本公司書面許可，不可部份複製。

This document is issued by the Company subject to its General Conditions of Service printed overleaf, available on request or accessible at www.sgs.com/terms_and_conditions.htm and, for electronic format documents, subject to Terms and Conditions for Electronic Documents at www.sgs.com/terms_e-document.htm. Attention is drawn to the limitation of liability, indemnification and jurisdiction issues defined therein. Any holder of this document is advised that information contained hereon reflects the Company's findings at the time of its intervention only and within the limits of Client's instructions, if any. The Company's sole responsibility is to its Client and this document does not exonerate parties to a transaction from exercising all their rights and obligations under the transaction documents. This document cannot be reproduced except in full, without prior written approval of the Company. Any unauthorized alteration, forgery or falsification of the content or appearance of this document is unlawful and offenders may be prosecuted to the fullest extent of the law.

References

- [1] N. Kuster, Q. Balzano, and J.C. Lin, Eds., *Mobile Communications Safety*, Chapman & Hall, London, 1997.
- [2] K. Meier, M. Burkhardt, T. Schmid, and N. Kuster, "Broadband calibration of E-field probes in lossy media", *IEEE Transactions on Microwave Theory and Techniques*, vol. 44, no. 10, pp. 1954-1962, Oct. 1996.
- [3] K. Jokela, P. Hyysalo, and L. Puranen, "Calibration of specific absorption rate (SAR) probes in waveguide at 900 MHz", *IEEE Transactions on Instrumentation and Measurements*, vol. 47, no. 2, pp. 432-438, Apr. 1998.

Unless otherwise stated the results shown in this test report refer only to the sample(s) tested and such sample(s) are retained for 90 days only.

除非另有說明，此報告結果僅對測試之樣品負責，同時此樣品僅保留90天。本報告未經本公司書面許可，不可部份複製。

This document is issued by the Company subject to its General Conditions of Service printed overleaf, available on request or accessible at www.sgs.com/terms_and_conditions.htm and, for electronic format documents, subject to Terms and Conditions for Electronic Documents at www.sgs.com/terms_e-document.htm. Attention is drawn to the limitation of liability, indemnification and jurisdiction issues defined therein. Any holder of this document is advised that information contained hereon reflects the Company's findings at the time of its intervention only and within the limits of Client's instructions, if any. The Company's sole responsibility is to its Client and this document does not exonerate parties to a transaction from exercising all their rights and obligations under the transaction documents. This document cannot be reproduced except in full, without prior written approval of the Company. Any unauthorized alteration, forgery or falsification of the content or appearance of this document is unlawful and offenders may be prosecuted to the fullest extent of the law.

SGS Taiwan Ltd.

No.134, Wu Kung Road, New Taipei Industrial Park, Wuku District, New Taipei City, Taiwan 24803/新北市五股區新北產業園區五工路 134 號

台灣檢驗科技股份有限公司

t (886-2) 2299-3279

f (886-2) 2298-0488

www.tw.sgs.com

Member of SGS Group

1.12 Test Standards and Limits

According to FCC 47CFR §2.1093(d) The limits to be used for evaluation are based generally on criteria published by the American National Standards Institute (ANSI) for localized specific absorption rate ("SAR") in Section 4.2 of "IEEE Standard for Safety Levels with Respect to Human Exposure to Radio Frequency Electromagnetic Fields, 3 kHz to 300 GHz," ANSI/IEEE C95.1, By the Institute of Electrical and Electronics Engineers, Inc., New York, New York 10017. These criteria for SAR evaluation are similar to those recommended by the National Council on Radiation Protection and Measurements (NCRP) in "Biological Effects and Exposure Criteria for Radio frequency Electromagnetic Fields," NCRP Report No. 86, Section 17.4.5. Copyright NCRP, 1986, Bethesda, Maryland 20814. SAR is a measure of the rate of energy absorption due to exposure to an RF transmitting source. SAR values have been related to threshold levels for potential biological hazards. The criteria to be used are specified in paragraphs (d)(1) and (d)(2) of this section and shall apply for portable devices transmitting in the frequency range from 100 kHz to 6 GHz. Portable devices that transmit at frequencies above 6 GHz are to be evaluated in terms of the MPE limits specified in § 1.1310 of this chapter. Measurements and calculations to demonstrate compliance with MPE field strength or power density limits for devices operating above 6 GHz should be made at a minimum distance of 5 cm from the radiating source.

- (1) Limits for Occupational/Controlled exposure: 0.4 W/kg as averaged over the whole-body and spatial peak SAR not exceeding 8 W/kg as averaged over any 1 gram of tissue (defined as a tissue volume in the shape of a cube). Exceptions are the hands, wrists, feet and ankles where the spatial peak SAR shall not exceed 20 W/kg, as averaged over an 10 grams of tissue (defined as a tissue volume in the shape of a cube).
- (2) Occupational/Controlled limits apply when persons are exposed as a consequence of their employment provided these persons are fully aware of and exercise control over their exposure. Awareness of exposure can be accomplished by use of warning labels or by specific training or education through appropriate means, such as an RF safety program in a work environment.
- (3) Limits for General Population/Uncontrolled exposure: 0.08 W/kg as averaged over the whole-body and spatial peak SAR not exceeding 1.6 W/kg as averaged over any 1 gram of tissue (defined as a tissue volume in the shape of a cube). Exceptions are the hands, wrists, feet and ankles where the spatial peak SAR shall not exceed 4 W/kg, as averaged over any 10 grams of tissue (defined as a tissue volume in the shape of a cube). General Population/Uncontrolled limits apply when the general public may be exposed, or when persons that are exposed as a consequence of their employment may not be fully aware of the potential for exposure or do not exercise control over their exposure. Warning labels placed on consumer devices such as cellular telephones will not be sufficient reason to allow these devices to be evaluated subject to limits for occupational/controlled exposure in paragraph (d)(1)

Unless otherwise stated the results shown in this test report refer only to the sample(s) tested and such sample(s) are retained for 90 days only.

除非另有說明，此報告結果僅對測試之樣品負責，同時此樣品僅保留90天。本報告未經本公司書面許可，不可部份複製。

This document is issued by the Company subject to its General Conditions of Service printed overleaf, available on request or accessible at www.sgs.com/terms_and_conditions.htm and, for electronic format documents, subject to Terms and Conditions for Electronic Documents at www.sgs.com/terms_e-document.htm. Attention is drawn to the limitation of liability, indemnification and jurisdiction issues defined therein. Any holder of this document is advised that information contained hereon reflects the Company's findings at the time of its intervention only and within the limits of Client's instructions, if any. The Company's sole responsibility is to its Client and this document does not exonerate parties to a transaction from exercising all their rights and obligations under the transaction documents. This document cannot be reproduced except in full, without prior written approval of the Company. Any unauthorized alteration, forgery or falsification of the content or appearance of this document is unlawful and offenders may be prosecuted to the fullest extent of the law.

of this section. (Table 4.)

| Human Exposure | Uncontrolled Environment General Population | Controlled Environment Occupational |
|--|--|--|
| Spatial Peak SAR (Brain) | 1.60 m W/g | 8.00 m W/g |
| Spatial Average SAR (Whole Body) | 0.08 m W/g | 0.40 m W/g |
| Spatial Peak SAR (Hands/Feet/Ankle/Wrist) | 4.00 m W/g | 20.00 m W/g |

Table 4. RF exposure limits

Notes:

1. Uncontrolled environments are defined as locations where there is potential exposure of individuals who have no knowledge or control of their potential exposure.
2. Controlled environments are defined as locations where there is potential exposure of individuals who have knowledge of their potential exposure and can exercise control over their exposure.

Unless otherwise stated the results shown in this test report refer only to the sample(s) tested and such sample(s) are retained for 90 days only.

除非另有說明，此報告結果僅對測試之樣品負責，同時此樣品僅保留90天。本報告未經本公司書面許可，不可部份複製。

This document is issued by the Company subject to its General Conditions of Service printed overleaf, available on request or accessible at www.sgs.com/terms_and_conditions.htm and, for electronic format documents, subject to Terms and Conditions for Electronic Documents at www.sgs.com/terms_e-document.htm. Attention is drawn to the limitation of liability, indemnification and jurisdiction issues defined therein. Any holder of this document is advised that information contained hereon reflects the Company's findings at the time of its intervention only and within the limits of Client's instructions, if any. The Company's sole responsibility is to its Client and this document does not exonerate parties to a transaction from exercising all their rights and obligations under the transaction documents. This document cannot be reproduced except in full, without prior written approval of the Company. Any unauthorized alteration, forgery or falsification of the content or appearance of this document is unlawful and offenders may be prosecuted to the fullest extent of the law.

2. Summary of Results

GPRS 850 MHz

| Mode | Position | Distance (mm) | CH | Freq. (MHz) | Max. Rated Avg. Power + Max. Tolerance | Measured Avg. Power (dBm) | Scaling | Averaged SAR over 1g (W/kg) | | Plot page |
|------------------|-----------------|---------------|-----|-------------|--|---------------------------|---------|-----------------------------|----------|-----------|
| | | | | | | | | Measured | Reported | |
| GPRS 850 (1D2UP) | Back side | 0mm | 128 | 824.2 | 30.8 | 30.78 | 0.46% | 0.63 | 0.633 | - |
| | Back side | 0mm | 190 | 836.6 | 30.8 | 30.74 | 1.39% | 0.731 | 0.741 | - |
| | Back side | 0mm | 251 | 848.8 | 30.8 | 30.80 | 0.00% | 0.827 | 0.827 | - |
| | Back side_Curve | 0mm | 251 | 848.8 | 30.8 | 30.80 | 0.00% | 0.72 | 0.720 | - |
| | Top side | 0mm | 251 | 848.8 | 30.8 | 30.80 | 0.00% | 0.762 | 0.762 | - |
| | Bottom | 0mm | 251 | 848.8 | 30.8 | 30.80 | 0.00% | 0.0128 | 0.013 | - |
| | Left side | 0mm | 128 | 824.2 | 30.8 | 30.78 | 0.46% | 0.942 | 0.946 | - |
| | Left side | 0mm | 190 | 836.6 | 30.8 | 30.74 | 1.39% | 0.945 | 0.958 | - |
| | Left side | 0mm | 251 | 848.8 | 30.8 | 30.80 | 0.00% | 0.991 | 0.991 | 183 |
| | Left side* | 0mm | 251 | 848.8 | 30.8 | 30.80 | 0.00% | 0.988 | 0.988 | - |
| | Right side | 0mm | 251 | 848.8 | 30.8 | 30.80 | 0.00% | 0.002 | 0.002 | - |

* - repeated at the highest SAR measurement according to the KDB 865664 D01

Unless otherwise stated the results shown in this test report refer only to the sample(s) tested and such sample(s) are retained for 90 days only.

除非另有說明，此報告結果僅對測試之樣品負責，同時此樣品僅保留90天。本報告未經本公司書面許可，不可部份複製。

This document is issued by the Company subject to its General Conditions of Service printed overleaf, available on request or accessible at www.sgs.com/terms_and_conditions.htm and, for electronic format documents, subject to Terms and Conditions for Electronic Documents at www.sgs.com/terms_e-document.htm. Attention is drawn to the limitation of liability, indemnification and jurisdiction issues defined therein. Any holder of this document is advised that information contained hereon reflects the Company's findings at the time of its intervention only and within the limits of Client's instructions, if any. The Company's sole responsibility is to its Client and this document does not exonerate parties to a transaction from exercising all their rights and obligations under the transaction documents. This document cannot be reproduced except in full, without prior written approval of the Company. Any unauthorized alteration, forgery or falsification of the content or appearance of this document is unlawful and offenders may be prosecuted to the fullest extent of the law.

GPRS 1900 MHZ

| Mode | Position | Distance (mm) | CH | Freq. (MHz) | Max. Rated Avg. Power + Max. Tolerance | Measured Avg. Power (dBm) | Scaling | Averaged SAR over 1g (W/kg) | | Plot page |
|--------------------|-----------------|---------------|-----|-------------|--|---------------------------|---------|-----------------------------|----------|-----------|
| | | | | | | | | Measured | Reported | |
| GPRS 1900 (1Dn2UP) | Back side | 0mm | 512 | 1850.2 | 28.5 | 28.25 | 5.93% | 1.13 | 1.197 | - |
| | Back side | 0mm | 661 | 1880 | 28.5 | 28.33 | 3.99% | 1.12 | 1.165 | - |
| | Back side | 0mm | 810 | 1909.8 | 28.5 | 28.29 | 4.95% | 1.11 | 1.165 | - |
| | Back side_Curve | 0mm | 512 | 1850.2 | 28.5 | 28.25 | 5.93% | 1.26 | 1.335 | 184 |
| | Back side_Curve | 0mm | 661 | 1880 | 28.5 | 28.33 | 3.99% | 1.14 | 1.186 | - |
| | Back side_Curve | 0mm | 810 | 1909.8 | 28.5 | 28.29 | 4.95% | 1.14 | 1.196 | - |
| | Back side * | 0mm | 512 | 1850.2 | 28.5 | 28.25 | 5.93% | 1.24 | 1.313 | - |
| | Top side | 0mm | 512 | 1850.2 | 28.5 | 28.25 | 5.93% | 0.985 | 1.043 | - |
| | Top side | 0mm | 661 | 1880 | 28.5 | 28.33 | 3.99% | 1.09 | 1.134 | - |
| | Top side | 0mm | 810 | 1909.8 | 28.5 | 28.29 | 4.95% | 1.09 | 1.144 | - |
| | Bottom | 0mm | 661 | 1880 | 28.5 | 28.33 | 3.99% | 0.0145 | 0.015 | - |
| | Left side | 0mm | 661 | 1880 | 28.5 | 28.33 | 3.99% | 0.287 | 0.298 | - |
| | Right side | 0mm | 661 | 1880 | 28.5 | 28.33 | 3.99% | 0.0012 | 0.001 | - |

* - repeated at the highest SAR measurement according to the KDB 865664 D01

Unless otherwise stated the results shown in this test report refer only to the sample(s) tested and such sample(s) are retained for 90 days only.

除非另有說明，此報告結果僅對測試之樣品負責，同時此樣品僅保留90天。本報告未經本公司書面許可，不可部份複製。

This document is issued by the Company subject to its General Conditions of Service printed overleaf, available on request or accessible at www.sgs.com/terms_and_conditions.htm and, for electronic format documents, subject to Terms and Conditions for Electronic Documents at www.sgs.com/terms_e-document.htm. Attention is drawn to the limitation of liability, indemnification and jurisdiction issues defined therein. Any holder of this document is advised that information contained hereon reflects the Company's findings at the time of its intervention only and within the limits of Client's instructions, if any. The Company's sole responsibility is to its Client and this document does not exonerate parties to a transaction from exercising all their rights and obligations under the transaction documents. This document cannot be reproduced except in full, without prior written approval of the Company. Any unauthorized alteration, forgery or falsification of the content or appearance of this document is unlawful and offenders may be prosecuted to the fullest extent of the law.

WCDMA Band II

| Mode | Position | Distance (mm) | CH | Freq. (MHz) | Max. Rated Avg. Power + Max. Tolerance | Measured Avg. Power (dBm) | Scaling | Averaged SAR over 1g (W/kg) | | Plot page |
|--------------|-----------------|---------------|------|-------------|--|---------------------------|---------|-----------------------------|----------|-----------|
| | | | | | | | | Measured | Reported | |
| WCDMA Band 2 | Back side | 0mm | 9262 | 1852.4 | 21.5 | 21.50 | 0.00% | 0.903 | 0.903 | - |
| | Back side | 0mm | 9400 | 1880 | 21.5 | 21.36 | 3.28% | 0.931 | 0.962 | - |
| | Back side | 0mm | 9538 | 1909.8 | 21.5 | 21.48 | 0.46% | 0.876 | 0.880 | - |
| | Back side_Curve | 0mm | 9262 | 1852.4 | 21.5 | 21.50 | 0.00% | 1.160 | 1.160 | 185 |
| | Back side_Curve | 0mm | 9400 | 1880 | 21.5 | 21.36 | 3.28% | 1.04 | 1.074 | - |
| | Back side_Curve | 0mm | 9538 | 1909.8 | 21.5 | 21.48 | 0.46% | 0.956 | 0.960 | - |
| | Back side_Curve | 0mm | 9262 | 1852.4 | 21.5 | 21.50 | 0.00% | 1.02 | 1.020 | - |
| | Top side | 0mm | 9262 | 1852.4 | 21.5 | 21.50 | 0.00% | 0.974 | 0.974 | - |
| | Top side | 0mm | 9400 | 1880 | 21.5 | 21.36 | 3.28% | 1.00 | 1.033 | - |
| | Top side | 0mm | 9538 | 1909.8 | 21.5 | 21.48 | 0.46% | 1.00 | 1.005 | - |
| | Bottom | 0mm | 9262 | 1852.4 | 21.5 | 21.50 | 0.00% | 0.0162 | 0.016 | - |
| | Left side | 0mm | 9262 | 1852.4 | 21.5 | 21.50 | 0.00% | 0.299 | 0.299 | - |
| | Right side | 0mm | 9262 | 1852.4 | 21.5 | 21.50 | 0.00% | 0.0019 | 0.002 | - |

* - repeated at the highest SAR measurement according to the KDB 865664 D01

Unless otherwise stated the results shown in this test report refer only to the sample(s) tested and such sample(s) are retained for 90 days only.

除非另有說明，此報告結果僅對測試之樣品負責，同時此樣品僅保留90天。本報告未經本公司書面許可，不可部份複製。

This document is issued by the Company subject to its General Conditions of Service printed overleaf, available on request or accessible at www.sgs.com/terms_and_conditions.htm and, for electronic format documents, subject to Terms and Conditions for Electronic Documents at www.sgs.com/terms_e-document.htm. Attention is drawn to the limitation of liability, indemnification and jurisdiction issues defined therein. Any holder of this document is advised that information contained hereon reflects the Company's findings at the time of its intervention only and within the limits of Client's instructions, if any. The Company's sole responsibility is to its Client and this document does not exonerate parties to a transaction from exercising all their rights and obligations under the transaction documents. This document cannot be reproduced except in full, without prior written approval of the Company. Any unauthorized alteration, forgery or falsification of the content or appearance of this document is unlawful and offenders may be prosecuted to the fullest extent of the law.

WCDMA Band IV

| Mode | Position | Distance (mm) | CH | Freq. (MHz) | Max. Rated Avg. Power + Max. Tolerance (dBm) | Measured Avg. Power (dBm) | Scaling | Averaged SAR over 1g (W/kg) | | Plot page |
|--------------|------------------|---------------|------|-------------|--|---------------------------|---------|-----------------------------|----------|-----------|
| | | | | | | | | Measured | Reported | |
| WCDMA Band 4 | Back side | 0mm | 1312 | 1712.4 | 22 | 21.77 | 5.44% | 0.947 | 0.999 | - |
| | Back side | 0mm | 1412 | 1732.6 | 22 | 21.75 | 5.93% | 0.93 | 0.985 | - |
| | Back side | 0mm | 1513 | 1752.6 | 22 | 21.76 | 5.68% | 0.926 | 0.979 | - |
| | Back side_Curve | 0mm | 1312 | 1712.4 | 22 | 21.77 | 5.44% | 1.05 | 1.107 | - |
| | Back side_Curve | 0mm | 1412 | 1732.6 | 22 | 21.75 | 5.93% | 1.03 | 1.091 | - |
| | Back side_Curve | 0mm | 1513 | 1752.6 | 22 | 21.76 | 5.68% | 1.07 | 1.131 | 186 |
| | Back side_Curve* | 0mm | 1513 | 1752.6 | 22 | 21.76 | 5.68% | 1.05 | 1.110 | - |
| | Top side | 0mm | 1312 | 1712.4 | 22 | 21.77 | 5.44% | 0.981 | 1.034 | - |
| | Top side | 0mm | 1412 | 1732.6 | 22 | 21.75 | 5.93% | 0.972 | 1.030 | - |
| | Top side | 0mm | 1513 | 1752.6 | 22 | 21.76 | 5.68% | 0.993 | 1.049 | - |
| | Bottom | 0mm | 1312 | 1712.4 | 22 | 21.77 | 5.44% | 0.0235 | 0.025 | - |
| | Left side | 0mm | 1312 | 1712.4 | 22 | 21.77 | 5.44% | 0.532 | 0.561 | - |
| | Right side | 0mm | 1312 | 1712.4 | 22 | 21.77 | 5.44% | 0.0042 | 0.004 | - |

* - repeated at the highest SAR measurement according to the KDB 865664 D01

Unless otherwise stated the results shown in this test report refer only to the sample(s) tested and such sample(s) are retained for 90 days only.

除非另有說明，此報告結果僅對測試之樣品負責，同時此樣品僅保留90天。本報告未經本公司書面許可，不可部份複製。

This document is issued by the Company subject to its General Conditions of Service printed overleaf, available on request or accessible at www.sgs.com/terms_and_conditions.htm and, for electronic format documents, subject to Terms and Conditions for Electronic Documents at www.sgs.com/terms_e-document.htm. Attention is drawn to the limitation of liability, indemnification and jurisdiction issues defined therein. Any holder of this document is advised that information contained hereon reflects the Company's findings at the time of its intervention only and within the limits of Client's instructions, if any. The Company's sole responsibility is to its Client and this document does not exonerate parties to a transaction from exercising all their rights and obligations under the transaction documents. This document cannot be reproduced except in full, without prior written approval of the Company. Any unauthorized alteration, forgery or falsification of the content or appearance of this document is unlawful and offenders may be prosecuted to the fullest extent of the law.

WCDMA Band V

| Mode | Position | Distance (mm) | CH | Freq. (MHz) | Max. Rated Avg. Power + Max. Tolerance (dBm) | Measured Avg. Power (dBm) | Scaling | Averaged SAR over 1g (W/kg) | | Plot page |
|--------------|------------|---------------|------|-------------|--|---------------------------|---------|-----------------------------|----------|-----------|
| | | | | | | | | Measured | Reported | |
| WCDMA Band 5 | Back side | 0mm | 4183 | 836.6 | 23 | 22.63 | 8.89% | 0.374 | 0.407 | - |
| | Back | 0mm | 4183 | 836.6 | 23 | 22.63 | 8.89% | 0.369 | 0.402 | - |
| | Top side | 0mm | 4183 | 836.6 | 23 | 22.63 | 8.89% | 0.359 | 0.391 | - |
| | Bottom | 0mm | 4183 | 836.6 | 23 | 22.63 | 8.89% | 0.0321 | 0.035 | - |
| | Left side | 0mm | 4183 | 836.6 | 23 | 22.63 | 8.89% | 0.565 | 0.615 | 187 |
| | Right side | 0mm | 4183 | 836.6 | 23 | 22.63 | 8.89% | 0.0028 | 0.003 | - |

Unless otherwise stated the results shown in this test report refer only to the sample(s) tested and such sample(s) are retained for 90 days only.

除非另有說明，此報告結果僅對測試之樣品負責，同時此樣品僅保留90天。本報告未經本公司書面許可，不可部份複製。

This document is issued by the Company subject to its General Conditions of Service printed overleaf, available on request or accessible at www.sgs.com/terms_and_conditions.htm and, for electronic format documents, subject to Terms and Conditions for Electronic Documents at www.sgs.com/terms_e-document.htm. Attention is drawn to the limitation of liability, indemnification and jurisdiction issues defined therein. Any holder of this document is advised that information contained hereon reflects the Company's findings at the time of its intervention only and within the limits of Client's instructions, if any. The Company's sole responsibility is to its Client and this document does not exonerate parties to a transaction from exercising all their rights and obligations under the transaction documents. This document cannot be reproduced except in full, without prior written approval of the Company. Any unauthorized alteration, forgery or falsification of the content or appearance of this document is unlawful and offenders may be prosecuted to the fullest extent of the law.

LTE FDD Band II

| Mode | Bandwidth (MHz) | Modulation | RB Size | RB start | Position | Distance (mm) | CH | Freq. (MHz) | Max. Rated Avg. Power + Max. Tolerance (dBm) | Measured Avg. Power (dBm) | Scaling | Averaged SAR over 1g (W/kg) | | Plot page |
|------------|-----------------|------------|---------|----------|-----------------|---------------|-------|-------------|--|---------------------------|---------|-----------------------------|----------|-----------|
| | | | | | | | | | | | | Measured | Reported | |
| LTE Band 2 | 20MHz | QPSK | 1 RB | 0 | Back side | 0mm | 18700 | 1860 | 22 | 21.83 | 3.99% | 0.822 | 0.855 | - |
| | | | | | Back side_Curve | 0mm | 18700 | 1860 | 22 | 21.83 | 3.99% | 0.743 | 0.773 | - |
| | | | | | Top side | 0mm | 18700 | 1860 | 22 | 21.83 | 3.99% | 0.921 | 0.958 | - |
| | | | | 0 | Back side | 0mm | 18900 | 1880 | 22 | 21.76 | 5.68% | 0.790 | 0.835 | - |
| | | | | | Back side_Curve | 0mm | 18900 | 1880 | 22 | 21.76 | 5.68% | 0.682 | 0.721 | - |
| | | | | | Top side | 0mm | 18900 | 1880 | 22 | 21.76 | 5.68% | 0.931 | 0.984 | - |
| | | | | 99 | Back side | 0mm | 19100 | 1900 | 22 | 21.88 | 2.80% | 0.778 | 0.800 | - |
| | | | | | Back side_Curve | 0mm | 19100 | 1900 | 22 | 21.88 | 2.80% | 0.963 | 0.990 | - |
| | | | | | Top side | 0mm | 19100 | 1900 | 22 | 21.88 | 2.80% | 0.861 | 0.885 | - |
| | | | | | Bottom side | 0mm | 19100 | 1900 | 22 | 21.88 | 2.80% | 0.025 | 0.026 | - |
| | | | | | Left side | 0mm | 19100 | 1900 | 22 | 21.88 | 2.80% | 0.188 | 0.193 | - |
| | | | | | Right side | 0mm | 19100 | 1900 | 22 | 21.88 | 2.80% | 0.011 | 0.011 | - |
| | | | 50 RB | 0 | Back side | 0mm | 18900 | 1880 | 22 | 21.87 | 3.04% | 0.905 | 0.932 | - |
| | | | | | Back side_Curve | 0mm | 18900 | 1880 | 22 | 21.87 | 3.04% | 0.761 | 0.784 | - |
| | | | | | Top side | 0mm | 18900 | 1880 | 22 | 21.87 | 3.04% | 1.000 | 1.030 | - |
| | | | | | Bottom side | 0mm | 18900 | 1880 | 22 | 21.87 | 3.04% | 0.031 | 0.032 | - |
| | | | | | Left side_Curve | 0mm | 18900 | 1880 | 22 | 21.87 | 3.04% | 0.339 | 0.349 | - |
| | | | | 50 | Right side | 0mm | 18900 | 1880 | 22 | 21.87 | 3.04% | 0.014 | 0.014 | - |
| | | | | | Back side | 0mm | 18700 | 1860 | 22 | 21.86 | 3.28% | 0.860 | 0.888 | - |
| | | | | | Back side_Curve | 0mm | 18700 | 1860 | 22 | 21.86 | 3.28% | 0.947 | 0.978 | - |
| | | | | 50 | Top side | 0mm | 18700 | 1860 | 22 | 21.86 | 3.28% | 0.947 | 0.978 | - |
| | | | | | Back side | 0mm | 19100 | 1900 | 22 | 21.55 | 10.92% | 0.845 | 0.937 | - |
| | | | | | Back side_Curve | 0mm | 19100 | 1900 | 22 | 21.55 | 10.92% | 0.925 | 1.026 | - |
| | | | | | | | | | Top side | 0mm | 19100 | 1900 | 22 | 21.55 |

Unless otherwise stated the results shown in this test report refer only to the sample(s) tested and such sample(s) are retained for 90 days only.

除非另有說明，此報告結果僅對測試之樣品負責，同時此樣品僅保留90天。本報告未經本公司書面許可，不可部份複製。

This document is issued by the Company subject to its General Conditions of Service printed overleaf, available on request or accessible at www.sgs.com/terms_and_conditions.htm and, for electronic format documents, subject to Terms and Conditions for Electronic Documents at www.sgs.com/terms_e-document.htm. Attention is drawn to the limitation of liability, indemnification and jurisdiction issues defined therein. Any holder of this document is advised that information contained hereon reflects the Company's findings at the time of its intervention only and within the limits of Client's instructions, if any. The Company's sole responsibility is to its Client and this document does not exonerate parties to a transaction from exercising all their rights and obligations under the transaction documents. This document cannot be reproduced except in full, without prior written approval of the Company. Any unauthorized alteration, forgery or falsification of the content or appearance of this document is unlawful and offenders may be prosecuted to the fullest extent of the law.

| Mode | Bandwidth (MHz) | Modulation | RB Size | RB start | Position | Distance (mm) | CH | Freq. (MHz) | Max. Rated Avg. Power + Max. Tolerance (dBm) | Measured Avg. Power (dBm) | Scaling | Averaged SAR over 1g (W/kg) | | Plot page |
|------------|-----------------|------------|---------|----------|------------------|---------------|-------|-------------|--|---------------------------|---------|-----------------------------|----------|-----------|
| | | | | | | | | | | | | Measured | Reported | |
| LTE Band 2 | 20MHz | QPSK | 100 RB | 0 | Back side | 0mm | 18700 | 1860 | 22 | 21.77 | 5.44% | 0.933 | 0.984 | - |
| | | | | | Back side_Curve | 0mm | 18700 | 1860 | 22 | 21.77 | 5.44% | 1.030 | 1.086 | 188 |
| | | | | | Back side_Curve* | 0mm | 18700 | 1860 | 22 | 21.77 | 5.44% | 0.998 | 1.052 | - |
| | | | | | Top side | 0mm | 18700 | 1860 | 22 | 21.77 | 5.44% | 0.864 | 0.911 | - |
| | | | | | Bottom side | 0mm | 18700 | 1860 | 22 | 21.77 | 5.44% | 0.039 | 0.041 | - |
| | | | | | Left side | 0mm | 18700 | 1860 | 22 | 21.77 | 5.44% | 0.221 | 0.233 | - |
| | | | | | Right side | 0mm | 18700 | 1860 | 22 | 21.77 | 5.44% | 0.026 | 0.027 | - |
| | | | | | Back side | 0mm | 18900 | 1900 | 22 | 21.74 | 6.17% | 1.000 | 1.062 | - |
| | | | | | Back side_Curve | 0mm | 18900 | 1900 | 22 | 21.74 | 6.17% | 0.929 | 0.986 | - |
| | | | | | Top side | 0mm | 18900 | 1900 | 22 | 21.74 | 6.17% | 0.997 | 1.059 | - |
| | | | | | Back side | 0mm | 19100 | 1900 | 22 | 21.62 | 9.14% | 0.948 | 1.035 | - |
| | | | | | Back side_Curve | 0mm | 19100 | 1900 | 22 | 21.62 | 9.14% | 0.892 | 0.974 | - |
| | | | | | Top side | 0mm | 19100 | 1900 | 22 | 21.62 | 9.14% | 0.998 | 1.089 | - |

* - repeated at the highest SAR measurement according to the FCC KDB865664D01v01r03

Unless otherwise stated the results shown in this test report refer only to the sample(s) tested and such sample(s) are retained for 90 days only.

除非另有說明，此報告結果僅對測試之樣品負責，同時此樣品僅保留90天。本報告未經本公司書面許可，不可部份複製。

This document is issued by the Company subject to its General Conditions of Service printed overleaf, available on request or accessible at www.sgs.com/terms_and_conditions.htm and, for electronic format documents, subject to Terms and Conditions for Electronic Documents at www.sgs.com/terms_e-document.htm. Attention is drawn to the limitation of liability, indemnification and jurisdiction issues defined therein. Any holder of this document is advised that information contained hereon reflects the Company's findings at the time of its intervention only and within the limits of Client's instructions, if any. The Company's sole responsibility is to its Client and this document does not exonerate parties to a transaction from exercising all their rights and obligations under the transaction documents. This document cannot be reproduced except in full, without prior written approval of the Company. Any unauthorized alteration, forgery or falsification of the content or appearance of this document is unlawful and offenders may be prosecuted to the fullest extent of the law.

LTE FDD Band IV

| Mode | Bandwidth (MHz) | Modulation | RB Size | RB start | Position | Distance (mm) | CH | Freq. (MHz) | Max. Rated Avg. Power + Max. Tolerance (dBm) | Measured Avg. Power (dBm) | Scaling | Averaged SAR over 1g (W/kg) | | Plot page | |
|------------|-----------------|------------|---------|----------|-----------------|-----------------|-------|-------------|--|---------------------------|---------|-----------------------------|----------|-----------|---|
| | | | | | | | | | | | | Measured | Reported | | |
| LTE Band 4 | 20MHz | QPSK | 1 RB | 0 | Back side | 0mm | 20175 | 1732.5 | 22 | 21.84 | 3.75% | 1.150 | 1.193 | 189 | |
| | | | | | Back side* | 0mm | 20175 | 1732.5 | 22 | 21.84 | 3.75% | 1.090 | 1.131 | - | |
| | | | | | Back side_Curve | 0mm | 20175 | 1732.5 | 22 | 21.84 | 3.75% | 1.070 | 1.110 | - | |
| | | | | | Top side | 0mm | 20175 | 1732.5 | 22 | 21.84 | 3.75% | 1.030 | 1.069 | - | |
| | | | | | 50 | Back side | 0mm | 20050 | 1720 | 22 | 21.90 | 2.33% | 0.862 | 0.882 | - |
| | | | | | | Back side_Curve | 0mm | 20050 | 1720 | 22 | 21.90 | 2.33% | 1.050 | 1.074 | - |
| | | | | | | Top side | 0mm | 20050 | 1720 | 22 | 21.90 | 2.33% | 1.020 | 1.044 | - |
| | | | | | 50 | Back side | 0mm | 20300 | 1745 | 22 | 21.91 | 2.09% | 0.899 | 0.918 | - |
| | | | | | | Back side_Curve | 0mm | 20300 | 1745 | 22 | 21.91 | 2.09% | 1.130 | 1.154 | - |
| | | | | | | Top side | 0mm | 20300 | 1745 | 22 | 21.91 | 2.09% | 0.967 | 0.987 | - |
| | | | | | | Bottom side | 0mm | 20300 | 1745 | 22 | 21.91 | 2.09% | 0.034 | 0.035 | - |
| | | | | | | Left side | 0mm | 20300 | 1745 | 22 | 21.91 | 2.09% | 0.460 | 0.470 | - |
| | | | | | Right side | 0mm | 20300 | 1745 | 22 | 21.91 | 2.09% | 0.0065 | 0.007 | - | |

* - repeated at the highest SAR measurement according to the FCC KDB865664D01v01r03

Unless otherwise stated the results shown in this test report refer only to the sample(s) tested and such sample(s) are retained for 90 days only.

除非另有說明，此報告結果僅對測試之樣品負責，同時此樣品僅保留90天。本報告未經本公司書面許可，不可部份複製。

This document is issued by the Company subject to its General Conditions of Service printed overleaf, available on request or accessible at www.sgs.com/terms_and_conditions.htm and, for electronic format documents, subject to Terms and Conditions for Electronic Documents at www.sgs.com/terms_e-document.htm. Attention is drawn to the limitation of liability, indemnification and jurisdiction issues defined therein. Any holder of this document is advised that information contained hereon reflects the Company's findings at the time of its intervention only and within the limits of Client's instructions, if any. The Company's sole responsibility is to its Client and this document does not exonerate parties to a transaction from exercising all their rights and obligations under the transaction documents. This document cannot be reproduced except in full, without prior written approval of the Company. Any unauthorized alteration, forgery or falsification of the content or appearance of this document is unlawful and offenders may be prosecuted to the fullest extent of the law.

| Mode | Bandwidth (MHz) | Modulation | RB Size | RB start | Position | Distance (mm) | CH | Freq. (MHz) | Max. Rated Avg. Power + Max. Tolerance (dBm) | Measured Avg. Power (dBm) | Scaling | Averaged SAR over 1g (W/kg) | | Plot page |
|------------|-----------------|------------|---------|----------|-----------------|---------------|-------|-------------|--|---------------------------|---------|-----------------------------|----------|-----------|
| | | | | | | | | | | | | Measured | Reported | |
| LTE Band 4 | 20MHz | QPSK | 50 RB | 25 | Back side | 0mm | 20175 | 1732.5 | 22 | 21.79 | 4.95% | 0.905 | 0.950 | - |
| | | | | | Back side_Curve | 0mm | 20175 | 1732.5 | 22 | 21.79 | 4.95% | 0.999 | 1.048 | - |
| | | | | | Top side | 0mm | 20175 | 1732.5 | 22 | 21.79 | 4.95% | 0.888 | 0.932 | - |
| | | | | 50 | Back side | 0mm | 20300 | 1745 | 22 | 21.85 | 3.51% | 0.912 | 0.944 | - |
| | | | | | Back side_Curve | 0mm | 20300 | 1745 | 22 | 21.85 | 3.51% | 1.030 | 1.066 | - |
| | | | | | Top side | 0mm | 20300 | 1745 | 22 | 21.85 | 3.51% | 0.915 | 0.947 | - |
| | | | | | Bottom side | 0mm | 20300 | 1745 | 22 | 21.85 | 3.51% | 0.029 | 0.030 | - |
| | | | | | Left side | 0mm | 20300 | 1745 | 22 | 21.85 | 3.51% | 0.432 | 0.447 | - |
| | | | | | Right side | 0mm | 20300 | 1745 | 22 | 21.85 | 3.51% | 0.0051 | 0.005 | - |
| | | | | 50 | Back side | 0mm | 20050 | 1720 | 22 | 21.75 | 5.93% | 0.891 | 0.944 | - |
| | | | | | Back side_Curve | 0mm | 20050 | 1720 | 22 | 21.75 | 5.93% | 0.982 | 1.040 | - |
| | | | | | Top side | 0mm | 20050 | 1720 | 22 | 21.75 | 5.93% | 0.878 | 0.930 | - |
| | | | 100 RB | 0 | Back side | 0mm | 20050 | 1720 | 22 | 21.70 | 7.15% | 0.938 | 1.005 | - |
| | | | | | Back side_Curve | 0mm | 20050 | 1720 | 22 | 21.70 | 7.15% | 0.856 | 0.917 | - |
| | | | | | Top side | 0mm | 20050 | 1720 | 22 | 21.70 | 7.15% | 0.984 | 1.054 | - |
| | | | | | Back side | 0mm | 20175 | 1732.5 | 22 | 21.81 | 4.47% | 1.060 | 1.107 | - |
| | | | | | Back side_Curve | 0mm | 20175 | 1732.5 | 22 | 21.81 | 4.47% | 0.852 | 0.890 | - |
| | | | | | Top side | 0mm | 20175 | 1732.5 | 22 | 21.81 | 4.47% | 0.953 | 0.996 | - |
| | | | | | Bottom side | 0mm | 20175 | 1732.5 | 22 | 21.81 | 4.47% | 0.042 | 0.044 | - |
| | | | | | Left side | 0mm | 20175 | 1732.5 | 22 | 21.81 | 4.47% | 0.520 | 0.543 | - |
| | | | | | Right side | 0mm | 20175 | 1732.5 | 22 | 21.81 | 4.47% | 0.0045 | 0.005 | - |
| | | | | | Back side | 0mm | 20300 | 1745 | 22 | 21.74 | 6.17% | 0.944 | 1.002 | - |
| | | | | | Back side_Curve | 0mm | 20300 | 1745 | 22 | 21.74 | 6.17% | 0.847 | 0.899 | - |
| | | | | | Top side | 0mm | 20300 | 1745 | 22 | 21.74 | 6.17% | 0.960 | 1.019 | - |

Unless otherwise stated the results shown in this test report refer only to the sample(s) tested and such sample(s) are retained for 90 days only.

除非另有說明，此報告結果僅對測試之樣品負責，同時此樣品僅保留90天。本報告未經本公司書面許可，不可部份複製。

This document is issued by the Company subject to its General Conditions of Service printed overleaf, available on request or accessible at www.sgs.com/terms_and_conditions.htm and, for electronic format documents, subject to Terms and Conditions for Electronic Documents at www.sgs.com/terms_e-document.htm. Attention is drawn to the limitation of liability, indemnification and jurisdiction issues defined therein. Any holder of this document is advised that information contained hereon reflects the Company's findings at the time of its intervention only and within the limits of Client's instructions, if any. The Company's sole responsibility is to its Client and this document does not exonerate parties to a transaction from exercising all their rights and obligations under the transaction documents. This document cannot be reproduced except in full, without prior written approval of the Company. Any unauthorized alteration, forgery or falsification of the content or appearance of this document is unlawful and offenders may be prosecuted to the fullest extent of the law.

LTE FDD Band V

| Mode | Bandwidth (MHz) | Modulation | RB Size | RB start | Position | Distance (mm) | CH | Freq. (MHz) | Max. Rated Avg. Power + Max. Tolerance (dBm) | Measured Avg. Power (dBm) | Scaling | Averaged SAR over 1g (W/kg) | | Plot page |
|------------|-----------------|------------|---------|----------|-----------------|---------------|-------|-------------|--|---------------------------|---------|-----------------------------|----------|-----------|
| | | | | | | | | | | | | Measured | Reported | |
| LTE Band 5 | 10MHz | QPSK | 1 RB | 49 | Back side | 0mm | 20600 | 844 | 23 | 22.55 | 10.92% | 0.326 | 0.362 | - |
| | | | | | Back side_Curve | 0mm | 20600 | 844 | 23 | 22.55 | 10.92% | 0.335 | 0.372 | - |
| | | | | | Top side | 0mm | 20600 | 844 | 23 | 22.55 | 10.92% | 0.423 | 0.469 | - |
| | | | | | Bottom side | 0mm | 20600 | 844 | 23 | 22.55 | 10.92% | 0.068 | 0.075 | - |
| | | | | | Left side | 0mm | 20600 | 844 | 23 | 22.55 | 10.92% | 0.432 | 0.479 | 190 |
| | | | | | Right side | 0mm | 20600 | 844 | 23 | 22.55 | 10.92% | 0.0054 | 0.006 | - |
| | | | 25 RB | 12 | Back side | 0mm | 20600 | 844 | 23 | 21.51 | 40.93% | 0.347 | 0.489 | - |
| | | | | | Back side_Curve | 0mm | 20600 | 844 | 23 | 21.51 | 40.93% | 0.411 | 0.579 | - |
| | | | | | Top side | 0mm | 20600 | 844 | 23 | 21.51 | 40.93% | 0.342 | 0.482 | - |
| | | | | | Bottom side | 0mm | 20600 | 844 | 23 | 21.51 | 40.93% | 0.054 | 0.076 | - |
| | | | | | Left side | 0mm | 20600 | 844 | 23 | 21.51 | 40.93% | 0.371 | 0.523 | - |
| | | | | | Right side | 0mm | 20600 | 844 | 23 | 21.51 | 40.93% | 0.0068 | 0.010 | - |
| | | | 50 RB | 0 | Back side | 0mm | 20600 | 844 | 23 | 21.43 | 43.55% | 0.342 | 0.491 | - |
| | | | | | Back side_Curve | 0mm | 20600 | 844 | 23 | 21.43 | 43.55% | 0.404 | 0.580 | - |
| | | | | | Top side | 0mm | 20600 | 844 | 23 | 21.43 | 43.55% | 0.401 | 0.576 | - |
| | | | | | Bottom side | 0mm | 20600 | 844 | 23 | 21.43 | 43.55% | 0.038 | 0.055 | - |
| | | | | | Left side | 0mm | 20600 | 844 | 23 | 21.43 | 43.55% | 0.419 | 0.601 | - |
| | | | | | Right side | 0mm | 20600 | 844 | 23 | 21.43 | 43.55% | 0.0095 | 0.014 | - |

Unless otherwise stated the results shown in this test report refer only to the sample(s) tested and such sample(s) are retained for 90 days only.

除非另有說明，此報告結果僅對測試之樣品負責，同時此樣品僅保留90天。本報告未經本公司書面許可，不可部份複製。

This document is issued by the Company subject to its General Conditions of Service printed overleaf, available on request or accessible at www.sgs.com/terms_and_conditions.htm and, for electronic format documents, subject to Terms and Conditions for Electronic Documents at www.sgs.com/terms_e-document.htm. Attention is drawn to the limitation of liability, indemnification and jurisdiction issues defined therein. Any holder of this document is advised that information contained hereon reflects the Company's findings at the time of its intervention only and within the limits of Client's instructions, if any. The Company's sole responsibility is to its Client and this document does not exonerate parties to a transaction from exercising all their rights and obligations under the transaction documents. This document cannot be reproduced except in full, without prior written approval of the Company. Any unauthorized alteration, forgery or falsification of the content or appearance of this document is unlawful and offenders may be prosecuted to the fullest extent of the law.

LTE FDD Band XIII

| Mode | Bandwidth (MHz) | Modulation | RB Size | RB start | Position | Distance (mm) | CH | Freq. (MHz) | Max. Rated Avg. Power + Max. Tolerance (dBm) | Measured Avg. Power (dBm) | Scaling | Averaged SAR over 1g (W/kg) | | Plot page |
|-------------|-----------------|------------|------------|----------|-----------------|---------------|-------|-------------|--|---------------------------|---------|-----------------------------|----------|-----------|
| | | | | | | | | | | | | Measured | Reported | |
| LTE Band 13 | 10MHz | QPSK | 1 RB | 25 | Back side | 0mm | 23200 | 782 | 23 | 22.66 | 8.14% | 0.433 | 0.468 | - |
| | | | | | Back side_Curve | 0mm | 23200 | 782 | 23 | 22.66 | 8.14% | 0.449 | 0.486 | - |
| | | | | | Top side | 0mm | 23200 | 782 | 23 | 22.66 | 8.14% | 0.508 | 0.549 | - |
| | | | | | Bottom side | 0mm | 23200 | 782 | 23 | 22.66 | 8.14% | 0.048 | 0.052 | - |
| | | | | | Left side | 0mm | 23200 | 782 | 23 | 22.66 | 8.14% | 0.594 | 0.642 | 191 |
| | | | | | Right side | 0mm | 23200 | 782 | 23 | 22.66 | 8.14% | 0.0052 | 0.006 | - |
| | | | 25 RB | 12 | Back side | 0mm | 23200 | 782 | 23 | 21.76 | 33.05% | 0.317 | 0.422 | - |
| | | | | | Back side_Curve | 0mm | 23200 | 782 | 23 | 21.76 | 33.05% | 0.341 | 0.454 | - |
| | | | | | Top side | 0mm | 23200 | 782 | 23 | 21.76 | 33.05% | 0.309 | 0.411 | - |
| | | | | | Bottom side | 0mm | 23200 | 782 | 23 | 21.76 | 33.05% | 0.026 | 0.035 | - |
| | | | | | Left side | 0mm | 23200 | 782 | 23 | 21.76 | 33.05% | 0.496 | 0.660 | - |
| | | | 50 RB | 0 | Right side | 0mm | 23200 | 782 | 23 | 21.76 | 33.05% | 0.0078 | 0.010 | - |
| | | | | | Back side | 0mm | 23200 | 782 | 23 | 21.43 | 43.55% | 0.293 | 0.421 | - |
| | | | | | Back side_Curve | 0mm | 23200 | 782 | 23 | 21.43 | 43.55% | 0.309 | 0.444 | - |
| | | | | | Top side | 0mm | 23200 | 782 | 23 | 21.43 | 43.55% | 0.308 | 0.442 | - |
| | | | | | Bottom side | 0mm | 23200 | 782 | 23 | 21.43 | 43.55% | 0.065 | 0.093 | - |
| | | | Left side | 0mm | 23200 | 782 | 23 | 21.43 | 43.55% | 0.583 | 0.837 | - | | |
| | | | Right side | 0mm | 23200 | 782 | 23 | 21.43 | 43.55% | 0.0064 | 0.009 | - | | |

Unless otherwise stated the results shown in this test report refer only to the sample(s) tested and such sample(s) are retained for 90 days only.

除非另有說明，此報告結果僅對測試之樣品負責，同時此樣品僅保留90天。本報告未經本公司書面許可，不可部份複製。

This document is issued by the Company subject to its General Conditions of Service printed overleaf, available on request or accessible at www.sgs.com/terms_and_conditions.htm and, for electronic format documents, subject to Terms and Conditions for Electronic Documents at www.sgs.com/terms_e-document.htm. Attention is drawn to the limitation of liability, indemnification and jurisdiction issues defined therein. Any holder of this document is advised that information contained hereon reflects the Company's findings at the time of its intervention only and within the limits of Client's instructions, if any. The Company's sole responsibility is to its Client and this document does not exonerate parties to a transaction from exercising all their rights and obligations under the transaction documents. This document cannot be reproduced except in full, without prior written approval of the Company. Any unauthorized alteration, forgery or falsification of the content or appearance of this document is unlawful and offenders may be prosecuted to the fullest extent of the law.

LTE FDD Band XVII

| Mode | Bandwidth (MHz) | Modulation | RB Size | RB start | Position | Distance (mm) | CH | Freq. (MHz) | Max. Rated Avg. Power + Max. Tolerance (dBm) | Measured Avg. Power (dBm) | Scaling | Averaged SAR over 1g (W/kg) | | Plot page |
|-------------|-----------------|------------|---------|----------|-----------------|---------------|-------|-------------|--|---------------------------|---------|-----------------------------|----------|-----------|
| | | | | | | | | | | | | Measured | Reported | |
| LTE Band 17 | 10MHz | QPSK | 1 RB | 25 | Back side | 0mm | 23800 | 711 | 23 | 22.87 | 3.04% | 0.190 | 0.196 | - |
| | | | | | Back side_Curve | 0mm | 23800 | 711 | 23 | 22.87 | 3.04% | 0.172 | 0.177 | - |
| | | | | | Top side | 0mm | 23800 | 711 | 23 | 22.87 | 3.04% | 0.162 | 0.167 | - |
| | | | | | Bottom side | 0mm | 23800 | 711 | 23 | 22.87 | 3.04% | 0.008 | 0.008 | - |
| | | | | | Left side | 0mm | 23800 | 711 | 23 | 22.87 | 3.04% | 0.397 | 0.409 | 192 |
| | | | | | Right side | 0mm | 23800 | 711 | 23 | 22.87 | 3.04% | 0.0018 | 0.002 | - |
| | | | 25 RB | 0 | Back side | 0mm | 23800 | 711 | 23 | 21.67 | 35.83% | 0.194 | 0.264 | - |
| | | | | | Back side_Curve | 0mm | 23800 | 711 | 23 | 21.67 | 35.83% | 0.218 | 0.296 | - |
| | | | | | Top side | 0mm | 23800 | 711 | 23 | 21.67 | 35.83% | 0.164 | 0.223 | - |
| | | | | | Bottom side | 0mm | 23800 | 711 | 23 | 21.67 | 35.83% | 0.005 | 0.006 | - |
| | | | | | Left side | 0mm | 23800 | 711 | 23 | 21.67 | 35.83% | 0.320 | 0.435 | - |
| | | | 50 RB | 0 | Right side | 0mm | 23800 | 711 | 23 | 21.67 | 35.83% | 0.0025 | 0.003 | - |
| | | | | | Back side | 0mm | 23780 | 709 | 23 | 21.53 | 40.28% | 0.170 | 0.238 | - |
| | | | | | Back side_Curve | 0mm | 23780 | 709 | 23 | 21.53 | 40.28% | 0.198 | 0.278 | - |
| | | | | | Top side | 0mm | 23780 | 709 | 23 | 21.53 | 40.28% | 0.137 | 0.192 | - |
| | | | | | Bottom side | 0mm | 23780 | 709 | 23 | 21.53 | 40.28% | 0.006 | 0.009 | - |
| | | | | | Left side | 0mm | 23780 | 709 | 23 | 21.53 | 40.28% | 0.312 | 0.438 | - |
| | | | | | | | | 0mm | 23780 | 709 | 23 | 21.53 | 40.28% | 0.0036 |

Unless otherwise stated the results shown in this test report refer only to the sample(s) tested and such sample(s) are retained for 90 days only.

除非另有說明，此報告結果僅對測試之樣品負責，同時此樣品僅保留90天。本報告未經本公司書面許可，不可部份複製。

This document is issued by the Company subject to its General Conditions of Service printed overleaf, available on request or accessible at www.sgs.com/terms_and_conditions.htm and, for electronic format documents, subject to Terms and Conditions for Electronic Documents at www.sgs.com/terms_e-document.htm. Attention is drawn to the limitation of liability, indemnification and jurisdiction issues defined therein. Any holder of this document is advised that information contained hereon reflects the Company's findings at the time of its intervention only and within the limits of Client's instructions, if any. The Company's sole responsibility is to its Client and this document does not exonerate parties to a transaction from exercising all their rights and obligations under the transaction documents. This document cannot be reproduced except in full, without prior written approval of the Company. Any unauthorized alteration, forgery or falsification of the content or appearance of this document is unlawful and offenders may be prosecuted to the fullest extent of the law.

LTE FDD Band XXV

| Mode | Bandwidth (MHz) | Modulation | RB Size | RB start | Position | Distance (mm) | CH | Freq. (MHz) | Max. Rated Avg. Power + Max. Tolerance (dBm) | Measured Avg. Power (dBm) | Scaling | Averaged SAR over 1g (W/kg) | | Plot page |
|-------------|-----------------|------------|---------|----------|-----------------|---------------|-------|-------------|--|---------------------------|---------|-----------------------------|----------|-----------|
| | | | | | | | | | | | | Measured | Reported | |
| LTE Band 25 | 20MHz | QPSK | 1 RB | 0 | Back side | 0mm | 26140 | 1860 | 22 | 21.92 | 1.86% | 1.130 | 1.151 | - |
| | | | | | Back side_Curve | 0mm | 26140 | 1860 | 22 | 21.92 | 1.86% | 0.918 | 0.935 | - |
| | | | | | Top side | 0mm | 26140 | 1860 | 22 | 21.92 | 1.86% | 1.070 | 1.090 | - |
| | | | | | Bottom side | 0mm | 26140 | 1860 | 22 | 21.92 | 1.86% | 0.015 | 0.015 | - |
| | | | | | Left side | 0mm | 26140 | 1860 | 22 | 21.92 | 1.86% | 0.368 | 0.375 | - |
| | | | | | Right side | 0mm | 26140 | 1860 | 22 | 21.92 | 1.86% | 0.0072 | 0.007 | - |
| | | | | 50 | Back side | 0mm | 26365 | 1882.5 | 22 | 21.72 | 6.66% | 0.968 | 1.032 | - |
| | | | | | Back side_Curve | 0mm | 26365 | 1882.5 | 22 | 21.72 | 6.66% | 0.912 | 0.973 | - |
| | | | | | Top side | 0mm | 26365 | 1882.5 | 22 | 21.72 | 6.66% | 1.060 | 1.131 | - |
| | | | | 99 | Back side | 0mm | 26590 | 1905 | 22 | 21.70 | 7.15% | 1.030 | 1.104 | - |
| | | | | | Back side_Curve | 0mm | 26590 | 1905 | 22 | 21.70 | 7.15% | 0.914 | 0.979 | - |
| | | | | | Top side | 0mm | 26590 | 1905 | 22 | 21.70 | 7.15% | 1.060 | 1.136 | - |

Unless otherwise stated the results shown in this test report refer only to the sample(s) tested and such sample(s) are retained for 90 days only.

除非另有說明，此報告結果僅對測試之樣品負責，同時此樣品僅保留90天。本報告未經本公司書面許可，不可部份複製。

This document is issued by the Company subject to its General Conditions of Service printed overleaf, available on request or accessible at www.sgs.com/terms_and_conditions.htm and, for electronic format documents, subject to Terms and Conditions for Electronic Documents at www.sgs.com/terms_e-document.htm. Attention is drawn to the limitation of liability, indemnification and jurisdiction issues defined therein. Any holder of this document is advised that information contained hereon reflects the Company's findings at the time of its intervention only and within the limits of Client's instructions, if any. The Company's sole responsibility is to its Client and this document does not exonerate parties to a transaction from exercising all their rights and obligations under the transaction documents. This document cannot be reproduced except in full, without prior written approval of the Company. Any unauthorized alteration, forgery or falsification of the content or appearance of this document is unlawful and offenders may be prosecuted to the fullest extent of the law.

| Mode | Bandwidth (MHz) | Modulation | RB Size | RB start | Position | Distance (mm) | CH | Freq. (MHz) | Max. Rated Avg. Power + Max. Tolerance (dBm) | Measured Avg. Power (dBm) | Scaling | Averaged SAR over 1g (W/kg) | | Plot page |
|-------------|-----------------|------------|---------|----------|-----------------|---------------|-------|-------------|--|---------------------------|---------|-----------------------------|----------|-----------|
| | | | | | | | | | | | | Measured | Reported | |
| LTE Band 25 | 20MHz | QPSK | 50 RB | 25 | Back side | 0mm | 26365 | 1882.5 | 22 | 21.76 | 5.68% | 0.826 | 0.873 | - |
| | | | | | Back side_Curve | 0mm | 26365 | 1882.5 | 22 | 21.76 | 5.68% | 0.888 | 0.938 | - |
| | | | | | Top side | 0mm | 26365 | 1882.5 | 22 | 21.76 | 5.68% | 1.060 | 1.120 | - |
| | | | | 50 | Back side | 0mm | 26140 | 1860 | 22 | 21.91 | 2.09% | 0.838 | 0.856 | - |
| | | | | | Back side_Curve | 0mm | 26140 | 1860 | 22 | 21.91 | 2.09% | 0.893 | 0.912 | - |
| | | | | | Top side | 0mm | 26140 | 1860 | 22 | 21.91 | 2.09% | 1.040 | 1.062 | - |
| | | | | 50 | Back side | 0mm | 26590 | 1905 | 22 | 21.93 | 1.62% | 0.888 | 0.902 | - |
| | | | | | Back side_Curve | 0mm | 26590 | 1905 | 22 | 21.93 | 1.62% | 0.903 | 0.918 | - |
| | | | | | Top side | 0mm | 26590 | 1905 | 22 | 21.93 | 1.62% | 1.140 | 1.159 | 193 |
| | | | | | Top side* | 0mm | 26590 | 1905 | 22 | 21.93 | 1.62% | 0.997 | 1.013 | - |
| | | | | | Bottom side | 0mm | 26590 | 1905 | 22 | 21.93 | 1.62% | 0.026 | 0.026 | - |
| | | | | | Left side | 0mm | 26590 | 1905 | 22 | 21.93 | 1.62% | 0.269 | 0.273 | - |
| | | | 100 RB | 0 | Right side | 0mm | 26590 | 1905 | 22 | 21.93 | 1.62% | 0.0045 | 0.005 | - |
| | | | | | Back side | 0mm | 26140 | 1860 | 22 | 21.71 | 6.91% | 0.904 | 0.966 | - |
| | | | | | Back side_Curve | 0mm | 26140 | 1860 | 22 | 21.71 | 6.91% | 0.857 | 0.916 | - |
| | | | | | Top side | 0mm | 26140 | 1860 | 22 | 21.71 | 6.91% | 1.010 | 1.080 | - |
| | | | | | Back side | 0mm | 26365 | 1882.5 | 22 | 21.70 | 7.15% | 0.878 | 0.941 | - |
| | | | | | Back side_Curve | 0mm | 26365 | 1882.5 | 22 | 21.70 | 7.15% | 0.830 | 0.889 | - |
| | | | | | Top side | 0mm | 26365 | 1882.5 | 22 | 21.70 | 7.15% | 0.990 | 1.061 | - |
| | | | | | Back side | 0mm | 26590 | 1905 | 22 | 21.73 | 6.41% | 0.985 | 1.048 | - |
| | | | | | Back side_Curve | 0mm | 26590 | 1905 | 22 | 21.73 | 6.41% | 0.860 | 0.915 | - |
| | | | | | Top side | 0mm | 26590 | 1905 | 22 | 21.73 | 6.41% | 0.975 | 1.038 | - |
| | | | | | Bottom side | 0mm | 26590 | 1905 | 22 | 21.73 | 6.41% | 0.021 | 0.022 | - |
| | | | | | Left side | 0mm | 26590 | 1905 | 22 | 21.73 | 6.41% | 0.242 | 0.258 | - |
| | | | | | Right side | 0mm | 26590 | 1905 | 22 | 21.73 | 6.41% | 0.0056 | 0.006 | - |

* - repeated at the highest SAR measurement according to the FCC KDB865664D01v01r03

Unless otherwise stated the results shown in this test report refer only to the sample(s) tested and such sample(s) are retained for 90 days only.

除非另有說明，此報告結果僅對測試之樣品負責，同時此樣品僅保留90天。本報告未經本公司書面許可，不可部份複製。

This document is issued by the Company subject to its General Conditions of Service printed overleaf, available on request or accessible at www.sgs.com/terms_and_conditions.htm and, for electronic format documents, subject to Terms and Conditions for Electronic Documents at www.sgs.com/terms_e-document.htm. Attention is drawn to the limitation of liability, indemnification and jurisdiction issues defined therein. Any holder of this document is advised that information contained hereon reflects the Company's findings at the time of its intervention only and within the limits of Client's instructions, if any. The Company's sole responsibility is to its Client and this document does not exonerate parties to a transaction from exercising all their rights and obligations under the transaction documents. This document cannot be reproduced except in full, without prior written approval of the Company. Any unauthorized alteration, forgery or falsification of the content or appearance of this document is unlawful and offenders may be prosecuted to the fullest extent of the law.

CDMA / EVDO (BC0)

| Mode | Service | Position | Distance (mm) | CH | Freq. (MHz) | Max. Rated Avg. Power + Max. Tolerance (dBm) | Measured Avg. Power (dBm) | Scaling | Averaged SAR over 1g (W/kg) | | Plot page | |
|-----------|---------|--------------------|-----------------|-----|-------------|--|---------------------------|---------|-----------------------------|----------|-----------|-----|
| | | | | | | | | | Measured | Reported | | |
| CDMA BC 0 | EVDO | Rev. 0 Subtype 0/1 | Back side | 0mm | 384 | 836.52 | 23 | 22.9 | 2.33% | 0.528 | 0.540 | - |
| | | | Back side_Curve | 0mm | 384 | 836.52 | 23 | 22.9 | 2.33% | 0.604 | 0.618 | - |
| | | | Top side | 0mm | 384 | 836.52 | 23 | 22.9 | 2.33% | 0.643 | 0.658 | - |
| | | | Bottom | 0mm | 384 | 836.52 | 23 | 22.9 | 2.33% | 0.068 | 0.070 | - |
| | | | Left side | 0mm | 1013 | 824.7 | 23 | 22.7 | 7.15% | 0.72 | 0.771 | - |
| | | | Left side | 0mm | 384 | 836.52 | 23 | 22.9 | 2.33% | 0.73 | 0.747 | 194 |
| | | | Left side | 0mm | 777 | 848.31 | 23 | 22.6 | 9.65% | 0.687 | 0.753 | - |
| | | | Right side | 0mm | 384 | 836.52 | 23 | 22.9 | 2.33% | 0.0065 | 0.007 | - |

Unless otherwise stated the results shown in this test report refer only to the sample(s) tested and such sample(s) are retained for 90 days only.

除非另有說明，此報告結果僅對測試之樣品負責，同時此樣品僅保留90天。本報告未經本公司書面許可，不可部份複製。

This document is issued by the Company subject to its General Conditions of Service printed overleaf, available on request or accessible at www.sgs.com/terms_and_conditions.htm and, for electronic format documents, subject to Terms and Conditions for Electronic Documents at www.sgs.com/terms_e-document.htm. Attention is drawn to the limitation of liability, indemnification and jurisdiction issues defined therein. Any holder of this document is advised that information contained hereon reflects the Company's findings at the time of its intervention only and within the limits of Client's instructions, if any. The Company's sole responsibility is to its Client and this document does not exonerate parties to a transaction from exercising all their rights and obligations under the transaction documents. This document cannot be reproduced except in full, without prior written approval of the Company. Any unauthorized alteration, forgery or falsification of the content or appearance of this document is unlawful and offenders may be prosecuted to the fullest extent of the law.

CDMA / EVDO (BC1)

| Mode | Service | Position | Distance (mm) | CH | Freq. (MHz) | Max. Rated Avg. Power + Max. Tolerance (dBm) | Measured Avg. Power (dBm) | Scaling | Averaged SAR over 1g (W/kg) | | Plot page | |
|-----------|---------|--------------------|-----------------|-----|-------------|--|---------------------------|---------|-----------------------------|----------|-----------|-----|
| | | | | | | | | | Measured | Reported | | |
| CDMA BC 1 | EVDO | Rev. 0 Subtype 0/1 | Back side | 0mm | 25 | 1851.25 | 22 | 21.97 | 0.69% | 0.957 | 0.964 | - |
| | | | Back side | 0mm | 600 | 1880 | 22 | 21.78 | 5.20% | 0.942 | 0.991 | - |
| | | | Back side | 0mm | 1175 | 1908.75 | 22 | 21.96 | 0.93% | 1.000 | 1.009 | 195 |
| | | | Back side* | 0mm | 1175 | 1908.75 | 22 | 21.96 | 0.93% | 0.887 | 0.895 | - |
| | | | Back side_Curve | 0mm | 25 | 1851.25 | 22 | 21.97 | 0.69% | 0.966 | 0.973 | - |
| | | | Back side_Curve | 0mm | 600 | 1880 | 22 | 21.78 | 5.20% | 0.886 | 0.932 | - |
| | | | Back side_Curve | 0mm | 1175 | 1908.75 | 22 | 21.96 | 0.93% | 0.915 | 0.923 | - |
| | | | Top side | 0mm | 25 | 1851.25 | 22 | 21.97 | 0.69% | 0.783 | 0.788 | - |
| | | | Top side | 0mm | 600 | 1880 | 22 | 21.78 | 5.20% | 0.834 | 0.877 | - |
| | | | Top side | 0mm | 1175 | 1908.75 | 22 | 21.96 | 0.93% | 0.895 | 0.903 | - |
| | | | Botoom side | 0mm | 25 | 1851.25 | 22 | 21.97 | 0.69% | 0.025 | 0.025 | - |
| | | | Left side | 0mm | 25 | 1851.25 | 22 | 21.97 | 0.69% | 0.339 | 0.341 | - |
| | | | Right side | 0mm | 25 | 1851.25 | 22 | 21.97 | 0.69% | 0.0041 | 0.004 | - |

* - repeated at the highest SAR measurement according to the FCC KDB 865664

Unless otherwise stated the results shown in this test report refer only to the sample(s) tested and such sample(s) are retained for 90 days only.

除非另有說明，此報告結果僅對測試之樣品負責，同時此樣品僅保留90天。本報告未經本公司書面許可，不可部份複製。

This document is issued by the Company subject to its General Conditions of Service printed overleaf, available on request or accessible at www.sgs.com/terms_and_conditions.htm and, for electronic format documents, subject to Terms and Conditions for Electronic Documents at www.sgs.com/terms_e-document.htm. Attention is drawn to the limitation of liability, indemnification and jurisdiction issues defined therein. Any holder of this document is advised that information contained hereon reflects the Company's findings at the time of its intervention only and within the limits of Client's instructions, if any. The Company's sole responsibility is to its Client and this document does not exonerate parties to a transaction from exercising all their rights and obligations under the transaction documents. This document cannot be reproduced except in full, without prior written approval of the Company. Any unauthorized alteration, forgery or falsification of the content or appearance of this document is unlawful and offenders may be prosecuted to the fullest extent of the law.

CDMA / EVDO (BC10)

| Mode | Service | Position | Distance (mm) | CH | Freq. (MHz) | Max. Rated Avg. Power + Max. Tolerance (dBm) | Measured Avg. Power (dBm) | Scaling | Averaged SAR over 1g (W/kg) | | Plot page | |
|------------|---------|--------------------|-----------------|-----|-------------|--|---------------------------|---------|-----------------------------|----------|-----------|-----|
| | | | | | | | | | Measured | Reported | | |
| CDMA BC 10 | EVDO | Rev. 0 Subtype 0/1 | Back side | 0mm | 684 | 823.1 | 23 | 22.7 | 7.15% | 0.513 | 0.550 | - |
| | | | Back side_Curve | 0mm | 684 | 823.1 | 23 | 22.7 | 7.15% | 0.593 | 0.635 | - |
| | | | Top side | 0mm | 684 | 823.1 | 23 | 22.7 | 7.15% | 0.545 | 0.584 | - |
| | | | Bottom | 0mm | 684 | 823.1 | 23 | 22.7 | 7.15% | 0.054 | 0.058 | - |
| | | | Left side | 0mm | 476 | 817.9 | 23 | 22.6 | 9.65% | 0.65 | 0.713 | - |
| | | | Left side | 0mm | 560 | 820 | 23 | 22.6 | 9.65% | 0.659 | 0.723 | - |
| | | | Left side | 0mm | 684 | 823.1 | 23 | 22.7 | 7.15% | 0.668 | 0.716 | 196 |
| Right side | 0mm | 684 | 823.1 | 23 | 22.7 | 7.15% | 0.0035 | 0.004 | - | | | |

Unless otherwise stated the results shown in this test report refer only to the sample(s) tested and such sample(s) are retained for 90 days only.

除非另有說明，此報告結果僅對測試之樣品負責，同時此樣品僅保留90天。本報告未經本公司書面許可，不可部份複製。

This document is issued by the Company subject to its General Conditions of Service printed overleaf, available on request or accessible at www.sgs.com/terms_and_conditions.htm and, for electronic format documents, subject to Terms and Conditions for Electronic Documents at www.sgs.com/terms_e-document.htm. Attention is drawn to the limitation of liability, indemnification and jurisdiction issues defined therein. Any holder of this document is advised that information contained hereon reflects the Company's findings at the time of its intervention only and within the limits of Client's instructions, if any. The Company's sole responsibility is to its Client and this document does not exonerate parties to a transaction from exercising all their rights and obligations under the transaction documents. This document cannot be reproduced except in full, without prior written approval of the Company. Any unauthorized alteration, forgery or falsification of the content or appearance of this document is unlawful and offenders may be prosecuted to the fullest extent of the law.

WLAN802.11 Main Antenna

| Antenna | Mode | Position | Distance (mm) | CH | Freq. (MHz) | Max. Rated Avg. Power + Max. Tolerance (dBm) | Measured Avg. Power (dBm) | Scaling | Averaged SAR over 1g (W/kg) | | Plot page |
|---------|------------------------|-----------------|---------------|------|-------------|--|---------------------------|---------|-----------------------------|----------|-----------|
| | | | | | | | | | Measured | Reported | |
| Main | WLAN802.11 b | Back side | 0 | 1 | 2412 | 13.5 | 13.50 | 0.00% | 0.261 | 0.261 | - |
| | | Back side_Curve | 0 | 1 | 2412 | 13.5 | 13.50 | 0.00% | 0.356 | 0.356 | - |
| | | Top side | 0 | 1 | 2412 | 13.5 | 13.50 | 0.00% | 0.0527 | 0.053 | - |
| | | Bottom side | 0 | 1 | 2412 | 13.5 | 13.50 | 0.00% | 0.00556 | 0.006 | - |
| | | Left side | 0 | 1 | 2412 | 13.5 | 13.50 | 0.00% | 0.00616 | 0.006 | - |
| | | Right side | 0 | 1 | 2412 | 13.5 | 13.50 | 0.00% | 0.915 | 0.915 | 197 |
| | | Right side* | 0 | 1 | 2412 | 13.5 | 13.50 | 0.00% | 0.903 | 0.903 | - |
| | | Right side | 0 | 6 | 2437 | 13.5 | 13.00 | 12.20% | 0.876 | 0.983 | - |
| | Right side | 0 | 11 | 2462 | 13.5 | 12.62 | 22.46% | 0.825 | 1.010 | - | |
| | WLAN802.11 a 5.2G | Back side | 0 | 40 | 5200 | 10.5 | 9.89 | 15.08% | 0.0501 | 0.058 | - |
| | | Back side_Curve | 0 | 40 | 5200 | 10.5 | 9.89 | 15.08% | 0.0522 | 0.060 | - |
| | | Top side | 0 | 40 | 5200 | 10.5 | 9.89 | 15.08% | 0.0727 | 0.084 | - |
| | | Bottom side | 0 | 40 | 5200 | 10.5 | 9.89 | 15.08% | 0.00112 | 0.001 | - |
| | | Left side | 0 | 40 | 5200 | 10.5 | 9.89 | 15.08% | 0.00011 | 0.000 | - |
| | | Right side | 0 | 40 | 5200 | 10.5 | 9.89 | 15.08% | 0.383 | 0.441 | 198 |
| | WLAN802.11 n(40M) 5.2G | Back side | 0 | 46 | 5230 | 10.5 | 9.61 | 22.74% | 0.0431 | 0.053 | - |
| | | Back side_Curve | 0 | 46 | 5230 | 10.5 | 9.61 | 22.74% | 0.0493 | 0.061 | - |
| | | Top side | 0 | 46 | 5230 | 10.5 | 9.61 | 22.74% | 0.0723 | 0.089 | - |
| | | Bottom side | 0 | 46 | 5230 | 10.5 | 9.61 | 22.74% | 0.00245 | 0.003 | - |
| | | Left side | 0 | 46 | 5230 | 10.5 | 9.61 | 22.74% | 0.0016 | 0.002 | - |
| | | Right side | 0 | 46 | 5230 | 10.5 | 9.61 | 22.74% | 0.303 | 0.372 | 199 |
| | WLAN802.11 n(20M) 5.3G | Back side | 0 | 60 | 5300 | 10.5 | 9.85 | 16.14% | 0.0457 | 0.053 | - |
| | | Back side_Curve | 0 | 60 | 5300 | 10.5 | 9.85 | 16.14% | 0.0498 | 0.058 | - |
| | | Top side | 0 | 60 | 5300 | 10.5 | 9.85 | 16.14% | 0.0628 | 0.073 | - |
| | | Bottom side | 0 | 60 | 5300 | 10.5 | 9.85 | 16.14% | 0.0019 | 0.002 | - |
| | | Left side | 0 | 60 | 5300 | 10.5 | 9.85 | 16.14% | 0.00012 | 0.000 | - |
| | | Right side | 0 | 60 | 5300 | 10.5 | 9.85 | 16.14% | 0.261 | 0.303 | 200 |

Unless otherwise stated the results shown in this test report refer only to the sample(s) tested and such sample(s) are retained for 90 days only.

除非另有說明，此報告結果僅對測試之樣品負責，同時此樣品僅保留90天。本報告未經本公司書面許可，不可部份複製。

This document is issued by the Company subject to its General Conditions of Service printed overleaf, available on request or accessible at www.sgs.com/terms_and_conditions.htm and, for electronic format documents, subject to Terms and Conditions for Electronic Documents at www.sgs.com/terms_e-document.htm. Attention is drawn to the limitation of liability, indemnification and jurisdiction issues defined therein. Any holder of this document is advised that information contained hereon reflects the Company's findings at the time of its intervention only and within the limits of Client's instructions, if any. The Company's sole responsibility is to its Client and this document does not exonerate parties to a transaction from exercising all their rights and obligations under the transaction documents. This document cannot be reproduced except in full, without prior written approval of the Company. Any unauthorized alteration, forgery or falsification of the content or appearance of this document is unlawful and offenders may be prosecuted to the fullest extent of the law.

| Antenna | Mode | Position | Distance (mm) | CH | Freq. (MHz) | Max. Rated Avg. Power + Max. Tolerance (dBm) | Measured Avg. Power (dBm) | Scaling | Averaged SAR over 1g (W/kg) | | Plot page |
|------------------------|------------------------|-----------------|---------------|------|-------------|--|---------------------------|---------|-----------------------------|----------|-----------|
| | | | | | | | | | Measured | Reported | |
| Main | WLAN802.11 n(40M) 5.3G | Back side | 0 | 54 | 5270 | 10.5 | 9.77 | 18.30% | 0.0524 | 0.062 | - |
| | | Back side_Curve | 0 | 54 | 5270 | 10.5 | 9.77 | 18.30% | 0.0525 | 0.062 | - |
| | | Top side | 0 | 54 | 5270 | 10.5 | 9.77 | 18.30% | 0.0568 | 0.067 | - |
| | | Bottom side | 0 | 54 | 5270 | 10.5 | 9.77 | 18.30% | 0.0018 | 0.002 | - |
| | | Left side | 0 | 54 | 5270 | 10.5 | 9.77 | 18.30% | 0.00042 | 0.000 | - |
| | | Right side | 0 | 54 | 5270 | 10.5 | 9.77 | 18.30% | 0.27 | 0.319 | 201 |
| | WLAN802.11 n(20M) 5.6G | Back side | 0 | 104 | 5520 | 10.5 | 9.77 | 18.30% | 0.0481 | 0.057 | - |
| | | Back side_Curve | 0 | 104 | 5520 | 10.5 | 9.77 | 18.30% | 0.0525 | 0.062 | - |
| | | Top side | 0 | 104 | 5520 | 10.5 | 9.77 | 18.30% | 0.0568 | 0.067 | - |
| | | Bottom side | 0 | 104 | 5520 | 10.5 | 9.77 | 18.30% | 0.0018 | 0.002 | - |
| | | Left side | 0 | 104 | 5520 | 10.5 | 9.77 | 18.30% | 0.00042 | 0.000 | - |
| | | Right side | 0 | 104 | 5520 | 10.5 | 9.77 | 18.30% | 0.276 | 0.327 | 202 |
| | WLAN802.11 n(20M) 5.6G | Back side | 0 | 120 | 5600 | 10.5 | 9.75 | 18.85% | 0.0612 | 0.073 | - |
| | | Back side_Curve | 0 | 120 | 5600 | 10.5 | 9.75 | 18.85% | 0.0655 | 0.078 | - |
| | | Top side | 0 | 120 | 5600 | 10.5 | 9.75 | 18.85% | 0.0712 | 0.085 | - |
| | | Bottom side | 0 | 120 | 5600 | 10.5 | 9.75 | 18.85% | 0.0011 | 0.001 | - |
| | | Left side | 0 | 120 | 5600 | 10.5 | 9.75 | 18.85% | 0.00034 | 0.000 | - |
| | | Right side | 0 | 120 | 5600 | 10.5 | 9.75 | 18.85% | 0.313 | 0.372 | 203 |
| | WLAN802.11 n(20M) 5.6G | Back side | 0 | 140 | 5700 | 10.5 | 9.57 | 23.88% | 0.0587 | 0.073 | - |
| | | Back side_Curve | 0 | 140 | 5700 | 10.5 | 9.57 | 23.88% | 0.0612 | 0.076 | - |
| | | Top side | 0 | 140 | 5700 | 10.5 | 9.57 | 23.88% | 0.0585 | 0.072 | - |
| | | Bottom side | 0 | 140 | 5700 | 10.5 | 9.57 | 23.88% | 0.0015 | 0.002 | - |
| | | Left side | 0 | 140 | 5700 | 10.5 | 9.57 | 23.88% | 0.00038 | 0.000 | - |
| | | Right side | 0 | 140 | 5700 | 10.5 | 9.57 | 23.88% | 0.324 | 0.401 | 204 |
| WLAN802.11 n(40M) 5.8G | Back side | 0 | 159 | 5795 | 11 | 9.33 | 46.89% | 0.0478 | 0.070 | - | |
| | Back side_Curve | 0 | 159 | 5795 | 11 | 9.33 | 46.89% | 0.0502 | 0.074 | - | |
| | Top side | 0 | 159 | 5795 | 11 | 9.33 | 46.89% | 0.0492 | 0.072 | - | |
| | Bottom side | 0 | 159 | 5795 | 11 | 9.33 | 46.89% | 0.0017 | 0.002 | - | |
| | Left side | 0 | 159 | 5795 | 11 | 9.33 | 46.89% | 0.00012 | 0.000 | - | |
| | Right side | 0 | 159 | 5795 | 11 | 9.33 | 46.89% | 0.349 | 0.513 | 205 | |

* - repeated at the highest SAR measurement according to the KDB 865664 D01

Unless otherwise stated the results shown in this test report refer only to the sample(s) tested and such sample(s) are retained for 90 days only.

除非另有說明，此報告結果僅對測試之樣品負責，同時此樣品僅保留90天。本報告未經本公司書面許可，不可部份複製。

This document is issued by the Company subject to its General Conditions of Service printed overleaf, available on request or accessible at www.sgs.com/terms_and_conditions.htm and, for electronic format documents, subject to Terms and Conditions for Electronic Documents at www.sgs.com/terms_e-document.htm. Attention is drawn to the limitation of liability, indemnification and jurisdiction issues defined therein. Any holder of this document is advised that information contained hereon reflects the Company's findings at the time of its intervention only and within the limits of Client's instructions, if any. The Company's sole responsibility is to its Client and this document does not exonerate parties to a transaction from exercising all their rights and obligations under the transaction documents. This document cannot be reproduced except in full, without prior written approval of the Company. Any unauthorized alteration, forgery or falsification of the content or appearance of this document is unlawful and offenders may be prosecuted to the fullest extent of the law.

WLAN802.11 Aux Antenna

| Antenna | Mode | Position | Distance (mm) | CH | Freq. (MHz) | Max. Rated Avg. Power + Max. Tolerance (dBm) | Measured Avg. Power (dBm) | Scaling | Averaged SAR over 1g (W/kg) | | Plot page |
|---------|------------------------|-------------|---------------|-----|-------------|--|---------------------------|---------|-----------------------------|----------|-----------|
| | | | | | | | | | Measured | Reported | |
| Aux | WLAN802.11 b | Back side | 0 | 11 | 2462 | 11.2 | 11.14 | 1.39% | 0.0909 | 0.092 | - |
| | | Top side | 0 | 1 | 2412 | 11 | 10.73 | 6.41% | 0.712 | 0.758 | - |
| | | Top side | 0 | 6 | 2437 | 11.2 | 11.14 | 1.39% | 0.83 | 0.842 | 206 |
| | | Top side | 0 | 11 | 2462 | 12 | 11.59 | 9.90% | 0.744 | 0.818 | - |
| | | Bottom side | 0 | 11 | 2462 | 11.2 | 11.14 | 1.39% | 0.00596 | 0.006 | - |
| | | Left side | 0 | 11 | 2462 | 11.2 | 11.14 | 1.39% | 0.00234 | 0.002 | - |
| | WLAN802.11 a 5.2G | Right side | 0 | 11 | 2462 | 11.2 | 11.14 | 1.39% | 0.00545 | 0.006 | - |
| | | Back side | 0 | 40 | 5200 | 10 | 9.37 | 15.61% | 0.169 | 0.195 | - |
| | | Top side | 0 | 36 | 5180 | 10 | 9.31 | 17.22% | 0.792 | 0.928 | 207 |
| | | Top side | 0 | 40 | 5200 | 10 | 9.37 | 15.61% | 0.775 | 0.896 | - |
| | | Top side | 0 | 44 | 5220 | 10 | 9.22 | 19.67% | 0.702 | 0.840 | - |
| | | Top side | 0 | 48 | 5240 | 10 | 9.19 | 20.50% | 0.721 | 0.869 | - |
| | WLAN802.11 n(40M) 5.2G | Bottom side | 0 | 40 | 5200 | 10 | 9.37 | 15.61% | 0.0012 | 0.001 | - |
| | | Left side | 0 | 40 | 5200 | 10 | 9.37 | 15.61% | 0.0022 | 0.003 | - |
| | | Right side | 0 | 40 | 5200 | 10 | 9.37 | 15.61% | 0.0102 | 0.012 | - |
| | | Back side | 0 | 46 | 5230 | 10 | 9.81 | 4.47% | 0.193 | 0.202 | - |
| | | Top side | 0 | 38 | 5190 | 9 | 8.57 | 10.41% | 0.329 | 0.363 | - |
| | | Top side | 0 | 46 | 5230 | 10 | 9.81 | 4.47% | 0.775 | 0.810 | 208 |
| | WLAN802.11 n(20M) 5.3G | Bottom side | 0 | 46 | 5230 | 10 | 9.81 | 4.47% | 0.000965 | 0.001 | - |
| | | Left side | 0 | 46 | 5230 | 10 | 9.81 | 4.47% | 0.00335 | 0.003 | - |
| | | Right side | 0 | 46 | 5230 | 10 | 9.81 | 4.47% | 0.0122 | 0.013 | - |
| | | Back side | 0 | 60 | 5300 | 10.5 | 9.57 | 23.88% | 0.157 | 0.194 | - |
| | | Top side | 0 | 52 | 5260 | 10.5 | 9.13 | 37.09% | 0.57 | 0.781 | - |
| | | Top side | 0 | 60 | 5300 | 10.5 | 9.57 | 23.88% | 0.69 | 0.855 | 209 |
| | WLAN802.11 n(40M) 5.3G | Top side | 0 | 64 | 5320 | 10.5 | 9.49 | 26.18% | 0.642 | 0.810 | - |
| | | Bottom side | 0 | 60 | 5300 | 10.5 | 9.57 | 23.88% | 0.0023 | 0.003 | - |
| | | Left side | 0 | 60 | 5300 | 10.5 | 9.57 | 23.88% | 0.00426 | 0.005 | - |
| | | Right side | 0 | 60 | 5300 | 10.5 | 9.57 | 23.88% | 0.0152 | 0.019 | - |
| | | Back side | 0 | 54 | 5270 | 10.5 | 9.86 | 15.88% | 0.162 | 0.188 | - |
| | | Top side | 0 | 54 | 5270 | 10.5 | 9.86 | 15.88% | 0.793 | 0.919 | 210 |
| | WLAN802.11 n(20M) 5.6G | Top side | 0 | 62 | 5310 | 9 | 7.52 | 40.60% | 0.397 | 0.558 | - |
| | | Bottom side | 0 | 54 | 5270 | 10.5 | 9.86 | 15.88% | 0.0058 | 0.007 | - |
| | | Left side | 0 | 54 | 5270 | 10.5 | 9.86 | 15.88% | 0.00264 | 0.003 | - |
| | | Right side | 0 | 54 | 5270 | 10.5 | 9.86 | 15.88% | 0.0117 | 0.014 | - |
| | | Back side | 0 | 120 | 5600 | 10.5 | 9.51 | 25.60% | 0.148 | 0.186 | - |
| | | Top side | 0 | 104 | 5520 | 10.5 | 9.39 | 29.12% | 0.434 | 0.560 | - |
| | WLAN802.11 n(40M) 5.8G | Top side | 0 | 120 | 5600 | 10.5 | 9.51 | 25.60% | 0.654 | 0.821 | 211 |
| | | Top side | 0 | 140 | 5700 | 10.5 | 9.26 | 33.05% | 0.408 | 0.543 | - |
| | | Bottom side | 0 | 120 | 5600 | 10.5 | 9.51 | 25.60% | 0.0049 | 0.006 | - |
| | | Left side | 0 | 120 | 5600 | 10.5 | 9.51 | 25.60% | 0.00375 | 0.005 | - |
| | | Right side | 0 | 120 | 5600 | 10.5 | 9.51 | 25.60% | 0.0231 | 0.029 | - |
| | | Back side | 0 | 159 | 5795 | 11 | 9.25 | 49.62% | 0.142 | 0.212 | - |
| | WLAN802.11 n(40M) 5.8G | Top side | 0 | 151 | 5755 | 11 | 9.18 | 52.05% | 0.408 | 0.620 | - |
| | | Top side | 0 | 159 | 5795 | 11 | 9.25 | 49.62% | 0.586 | 0.877 | 212 |
| | | Bottom side | 0 | 159 | 5795 | 11 | 9.25 | 49.62% | 0.0028 | 0.004 | - |
| | | Left side | 0 | 159 | 5795 | 11 | 9.25 | 49.62% | 0.00428 | 0.006 | - |
| | | Right side | 0 | 159 | 5795 | 11 | 9.25 | 49.62% | 0.0159 | 0.024 | - |

Unless otherwise stated the results shown in this test report refer only to the sample(s) tested and such sample(s) are retained for 90 days only.

除非另有說明，此報告結果僅對測試之樣品負責，同時此樣品僅保留90天。本報告未經本公司書面許可，不可部份複製。

This document is issued by the Company subject to its General Conditions of Service printed overleaf, available on request or accessible at www.sgs.com/terms_and_conditions.htm and, for electronic format documents, subject to Terms and Conditions for Electronic Documents at www.sgs.com/terms_e-document.htm. Attention is drawn to the limitation of liability, indemnification and jurisdiction issues defined therein. Any holder of this document is advised that information contained hereon reflects the Company's findings at the time of its intervention only and within the limits of Client's instructions, if any. The Company's sole responsibility is to its Client and this document does not exonerate parties to a transaction from exercising all their rights and obligations under the transaction documents. This document cannot be reproduced except in full, without prior written approval of the Company. Any unauthorized alteration, forgery or falsification of the content or appearance of this document is unlawful and offenders may be prosecuted to the fullest extent of the law.

3. Simultaneous Transmission Analysis

Simultaneous Transmission Scenarios:

| Simultaneous Transmit Configurations | Body |
|---|------|
| GPRS850/1900 + 2.4/5GHz WLAN Main | Yes |
| GPRS850/1900 + 2.4/5GHz WLAN Aux | Yes |
| GPRS850/1900 + 2.4/5GHz WLAN MIMO | Yes |
| WCDMA B2/4/5 + 2.4/5GHz WLAN Main | Yes |
| WCDMA B2/4/5 + 2.4/5GHz WLAN Aux | Yes |
| WCDMA B2/4/5 + 2.4/5GHz WLAN MIMO | Yes |
| LTE B2/4/5/13/17/25 + 2.4/5GHz WLAN Main | Yes |
| LTE B2/4/5/13/17/25 + 2.4/5GHz WLAN Aux | Yes |
| LTE B2/4/5/13/17/25 + 2.4/5GHz WLAN MIMO | Yes |
| CDMA BC0/BC1/10 + 2.4/5GHz WLAN Main | Yes |
| CDMA BC0/BC1/10 + 2.4/5GHz WLAN Aux | Yes |
| CDMA BC0/BC1/10 + 2.4/5GHz WLAN MIMO | Yes |
| GPRS850/1900 + 2.4/5GHz WLAN Aux + BT | Yes |
| WCDMA B2/4/5 + 2.4/5GHz WLAN Aux + BT | Yes |
| LTE B2/4/5/13/17/25 + 2.4/5GHz WLAN Aux + BT | Yes |
| CDMA BC0/BC1/BC10 + 2.4/5GHz WLAN Aux + BT | Yes |

Note:

1. WWAN and WLAN may transmit simultaneously.
2. Bluetooth and WLAN Main share the same antenna path, and BT can't transmit with WLAN Main simultaneously.
3. For 2.4/5GHz WLAN Main and Aux antennas, the maximum output power of each antenna during simultaneous transmission (for 802.11n) is much less than that used in standalone transmission (for 802.11a/b/g/n), so it is more conservative to use the sum of 1-g SAR provision in KDB447498D01 to exclude the SAR measurement for 802.11n MIMO.
4. There are so many combination for simultaneous transmission, we choose the worst cases(all transmitters transmit simultaneously at maximum power) to do the simultaneous transmission analysis to capture the worst cases.
5. Based on KDB447498D01, when standalone BT test exclusion applies, BT SAR is estimated; the peak location is assumed to be at the feed-point or geometric center of the antenna.
For peak SAR location separation distance, we choose the separation distances between WWAN/WLAN Aux antennas and BT antenna to be the worst cases.
Ps. For top side, the separation distance between WWAN and BT antennas is 185.8mm.
For top side, the separation distance between WLAN Aux and BT antennas is 79mm.

Unless otherwise stated the results shown in this test report refer only to the sample(s) tested and such sample(s) are retained for 90 days only.

除非另有說明，此報告結果僅對測試之樣品負責，同時此樣品僅保留90天。本報告未經本公司書面許可，不可部份複製。

This document is issued by the Company subject to its General Conditions of Service printed overleaf, available on request or accessible at www.sgs.com/terms_and_conditions.htm and, for electronic format documents, subject to Terms and Conditions for Electronic Documents at www.sgs.com/terms_e-document.htm. Attention is drawn to the limitation of liability, indemnification and jurisdiction issues defined therein. Any holder of this document is advised that information contained hereon reflects the Company's findings at the time of its intervention only and within the limits of Client's instructions, if any. The Company's sole responsibility is to its Client and this document does not exonerate parties to a transaction from exercising all their rights and obligations under the transaction documents. This document cannot be reproduced except in full, without prior written approval of the Company. Any unauthorized alteration, forgery or falsification of the content or appearance of this document is unlawful and offenders may be prosecuted to the fullest extent of the law.

3.1 Estimated SAR calculation

According to KDB447498 D01v05 – When standalone SAR test exclusion applies to an antenna that transmits simultaneously with other antennas, the standalone SAR must be estimated according to following to determine simultaneous transmission SAR test exclusion:

$$\text{Estimated SAR} = \frac{\text{Max. tune up power(mW)}}{\text{Min. test separation distance(mm)}} \times \frac{\sqrt{f(\text{GHz})}}{7.5}$$

If the minimum test separation distance is < 5mm, a distance of 5mm is used for estimated SAR calculation. When the test separation distance is >50mm, the 0.4W/kg is used for SAR-1g.

| Mode / Band | frequency (GHz) | Maximum power(dBm) | Test position | test separation distance(mm) | Estimated SAR(W/kg) |
|-------------|-----------------|--------------------|---------------------------|------------------------------|---------------------|
| BT / 2.4G | 2.48 | 3.51 | top | 15.9 | 0.03 |
| BT / 2.4G | 2.48 | 3.51 | left / bottom | larger than 50mm | 0.4 |
| BT / 2.4G | 2.48 | 3.51 | right / back / back_curve | less than 5mm | 0.094 |

3.2 SPLSR evaluation and analysis

Per KDB447498D01, when the sum of SAR is larger than the limit, SAR test exclusion is determined by the SAR sum to peak location separation ratio(SPLSR).

The simultaneous transmitting antennas in each operating mode and exposure condition combination must be considered one pair at a time to determine the SAR to peak location separation ratio to qualify for test exclusion.

The ratio is determined by $(\text{SAR1} + \text{SAR2})^{1.5}/R_i$, rounded to two decimal digits, and must be ≤ 0.04 for all antenna pairs in the configuration to qualify for 1-g SAR test exclusion.

SAR1 and SAR2 are the highest reported or estimated SAR for each antenna in the pair, and R_i is the separation distance between the peak SAR locations for the antenna pair in mm.

When standalone test exclusion applies, SAR is estimated; the peak location is assumed to be at the feed-point or geometric center of the antenna.

Unless otherwise stated the results shown in this test report refer only to the sample(s) tested and such sample(s) are retained for 90 days only.

除非另有說明，此報告結果僅對測試之樣品負責，同時此樣品僅保留90天。本報告未經本公司書面許可，不可部份複製。

This document is issued by the Company subject to its General Conditions of Service printed overleaf, available on request or accessible at www.sgs.com/terms_and_conditions.htm and, for electronic format documents, subject to Terms and Conditions for Electronic Documents at www.sgs.com/terms_e-document.htm. Attention is drawn to the limitation of liability, indemnification and jurisdiction issues defined therein. Any holder of this document is advised that information contained hereon reflects the Company's findings at the time of its intervention only and within the limits of Client's instructions, if any. The Company's sole responsibility is to its Client and this document does not exonerate parties to a transaction from exercising all their rights and obligations under the transaction documents. This document cannot be reproduced except in full, without prior written approval of the Company. Any unauthorized alteration, forgery or falsification of the content or appearance of this document is unlawful and offenders may be prosecuted to the fullest extent of the law.

GPRS 850 + 2.4GHz WLAN MIMO

| No. | Conditions | Position | Distance (mm) | Max. WWAN | Max. WLAN Main | Max. WLAN Aux | SAR Sum | SPLSR |
|-----|------------|------------------------|---------------|-----------|----------------|---------------|--------------|--------------------------------|
| 1 | 850 | Back side | 0 | 0.866 | 0.261 | 0.111 | 1.238 | Σ SAR<1.6, Not required |
| | | Back side_Curve(Left) | 0 | 0.754 | - | - | - | Σ SAR<1.6, Not required |
| | | Back side_Curve(Right) | 0 | - | 0.356 | - | - | Σ SAR<1.6, Not required |
| | | Top side | 0 | 0.762 | 0.0527 | 0.842 | 1.657 | Analyzed as below |
| | | Bottom side | 0 | 0.013 | 0.006 | 0.007 | 0.026 | Σ SAR<1.6, Not required |
| | | Left side | 0 | 1.038 | 0.006 | 0.003 | 1.047 | Σ SAR<1.6, Not required |
| | | Right side | 0 | 0.002 | 1.01 | 0.007 | 1.019 | Σ SAR<1.6, Not required |

WWAN & WLAN Main

| Conditions | Position | SAR Value (W/kg) | Coordinates (cm) | | | Σ SAR (W/kg) | Peak Location Separation Distance (mm) | SPLSR | Simultaneous Transmission SAR Test |
|------------|----------|------------------|------------------|-------|-------|---------------------|--|-------|------------------------------------|
| | | | x | y | z | | | | |
| GPRS 850 | Top side | 0.762 | -0.84 | -4.83 | -0.70 | 0.8147 | 115.4 | 0.006 | SPLSR<0.04, Not required |
| WLAN Main | | 0.0527 | -0.70 | 6.24 | 2.55 | | | | |

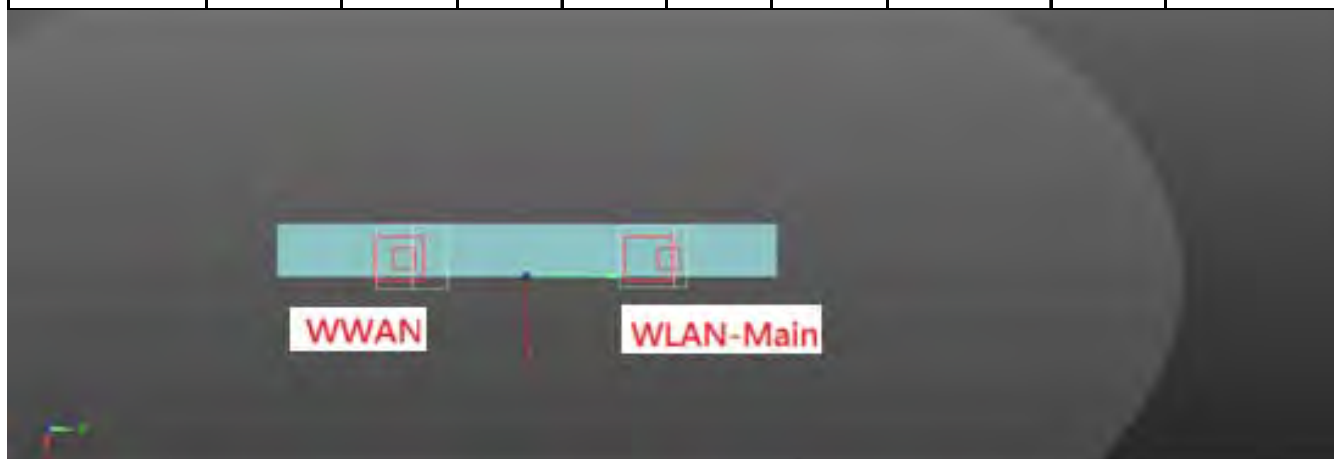

Unless otherwise stated the results shown in this test report refer only to the sample(s) tested and such sample(s) are retained for 90 days only.

除非另有說明，此報告結果僅對測試之樣品負責，同時此樣品僅保留90天。本報告未經本公司書面許可，不可部份複製。

This document is issued by the Company subject to its General Conditions of Service printed overleaf, available on request or accessible at www.sgs.com/terms_and_conditions.htm and, for electronic format documents, subject to Terms and Conditions for Electronic Documents at www.sgs.com/terms_e-document.htm. Attention is drawn to the limitation of liability, indemnification and jurisdiction issues defined therein. Any holder of this document is advised that information contained hereon reflects the Company's findings at the time of its intervention only and within the limits of Client's instructions, if any. The Company's sole responsibility is to its Client and this document does not exonerate parties to a transaction from exercising all their rights and obligations under the transaction documents. This document cannot be reproduced except in full, without prior written approval of the Company. Any unauthorized alteration, forgery or falsification of the content or appearance of this document is unlawful and offenders may be prosecuted to the fullest extent of the law.

WWAN & WLAN Aux

| Conditions | Position | SAR Value (W/kg) | Coordinates (cm) | | | ΣSAR (W/kg) | Peak Location Separation Distance (mm) | SPLSR | Simultaneous Transmission SAR Test |
|------------|----------|------------------|------------------|-------|-------|-------------|--|-------|------------------------------------|
| | | | x | y | z | | | | |
| GPRS 850 | Top side | 0.762 | -0.84 | -4.83 | -0.70 | 1.604 | 52.4 | 0.039 | SPLSR<0.04, Not required |
| WLAN Aux | | 0.842 | -0.74 | 0.58 | -0.73 | | | | |

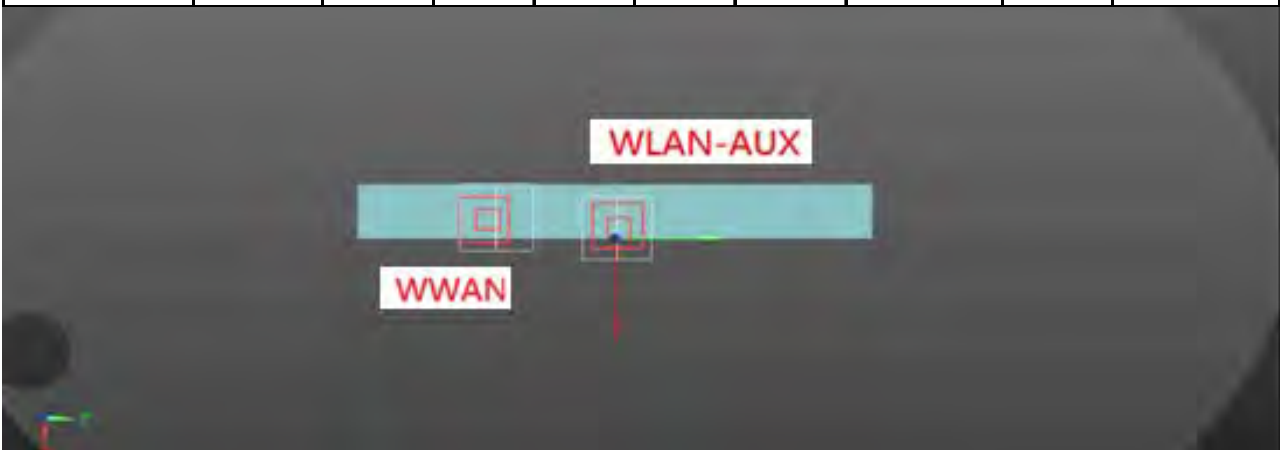

WLAN Main & WLAN Aux

| Conditions | Position | SAR Value (W/kg) | Coordinates (cm) | | | ΣSAR (W/kg) | Peak Location Separation Distance (mm) | SPLSR | Simultaneous Transmission SAR Test |
|------------|----------|------------------|------------------|------|-------|-------------|--|-------|------------------------------------|
| | | | x | y | z | | | | |
| WLAN Main | Top side | 0.0527 | -0.70 | 6.24 | 2.55 | 0.8947 | 67.1 | 0.013 | SPLSR<0.04, Not required |
| WLAN Aux | | 0.842 | -0.74 | 0.58 | -0.73 | | | | |

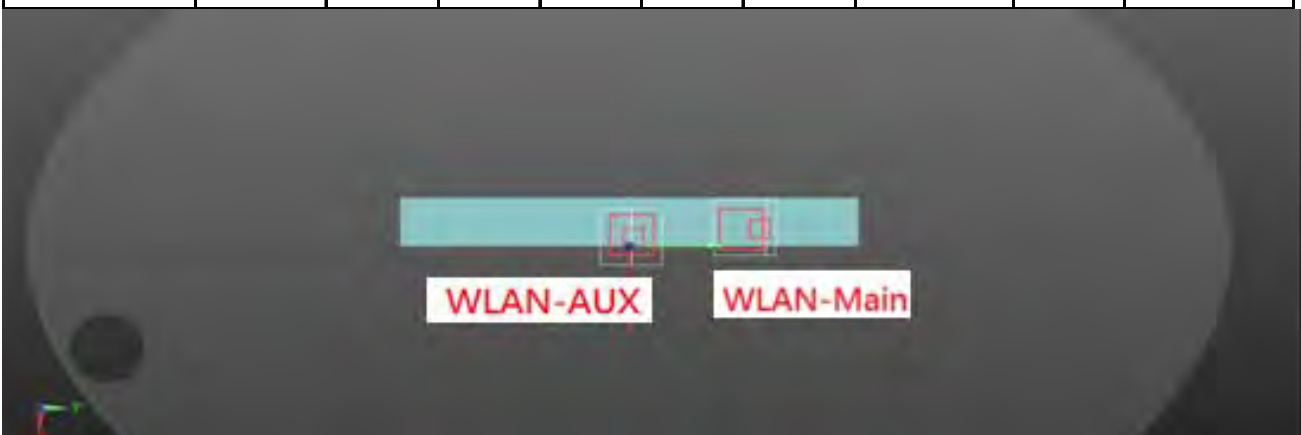

Unless otherwise stated the results shown in this test report refer only to the sample(s) tested and such sample(s) are retained for 90 days only.

除非另有說明，此報告結果僅對測試之樣品負責，同時此樣品僅保留90天。本報告未經本公司書面許可，不可部份複製。

This document is issued by the Company subject to its General Conditions of Service printed overleaf, available on request or accessible at www.sgs.com/terms_and_conditions.htm and, for electronic format documents, subject to Terms and Conditions for Electronic Documents at www.sgs.com/terms_e-document.htm. Attention is drawn to the limitation of liability, indemnification and jurisdiction issues defined therein. Any holder of this document is advised that information contained hereon reflects the Company's findings at the time of its intervention only and within the limits of Client's instructions, if any. The Company's sole responsibility is to its Client and this document does not exonerate parties to a transaction from exercising all their rights and obligations under the transaction documents. This document cannot be reproduced except in full, without prior written approval of the Company. Any unauthorized alteration, forgery or falsification of the content or appearance of this document is unlawful and offenders may be prosecuted to the fullest extent of the law.

GPRS 1900 + 2.4GHz WLAN MIMO

| No. | Conditions | Position | Distance (mm) | Max. WWAN | Max. WLAN Main | Max. WLAN Aux | SAR Sum | SPLSR |
|-----|------------|------------------------|---------------|-----------|----------------|---------------|---------------|------------------------|
| 2 | 1900 | Back side | 0 | 1.197 | 0.261 | 0.111 | 1.569 | ΣSAR<1.6, Not required |
| | | Back side_Curve(Left) | 0 | 1.335 | - | - | - | ΣSAR<1.6, Not required |
| | | Back side_Curve(Right) | 0 | - | 0.356 | - | - | ΣSAR<1.6, Not required |
| | | Top side | 0 | 1.144 | 0.0527 | 0.842 | 2.0387 | Analyzed as below |
| | | Bottom side | 0 | 0.0145 | 0.006 | 0.007 | 0.0275 | ΣSAR<1.6, Not required |
| | | Left side | 0 | 0.287 | 0.006 | 0.003 | 0.296 | ΣSAR<1.6, Not required |
| | | Right side | 0 | 0.0012 | 1.01 | 0.007 | 1.0182 | ΣSAR<1.6, Not required |

WWAN & WLAN Main

| Conditions | Position | SAR Value (W/kg) | Coordinates (cm) | | | ΣSAR (W/kg) | Peak Location Separation Distance (mm) | SPLSR | Simultaneous Transmission SAR Test |
|------------|----------|------------------|------------------|-------|------|-------------|--|-------|------------------------------------|
| | | | x | y | z | | | | |
| GPRS 1900 | Top side | 1.144 | -0.54 | -8.59 | 0.45 | 1.1967 | 149.8 | 0.009 | SPLSR<0.04, Not required |
| WLAN Main | | 0.0527 | -0.70 | 6.24 | 2.55 | | | | |

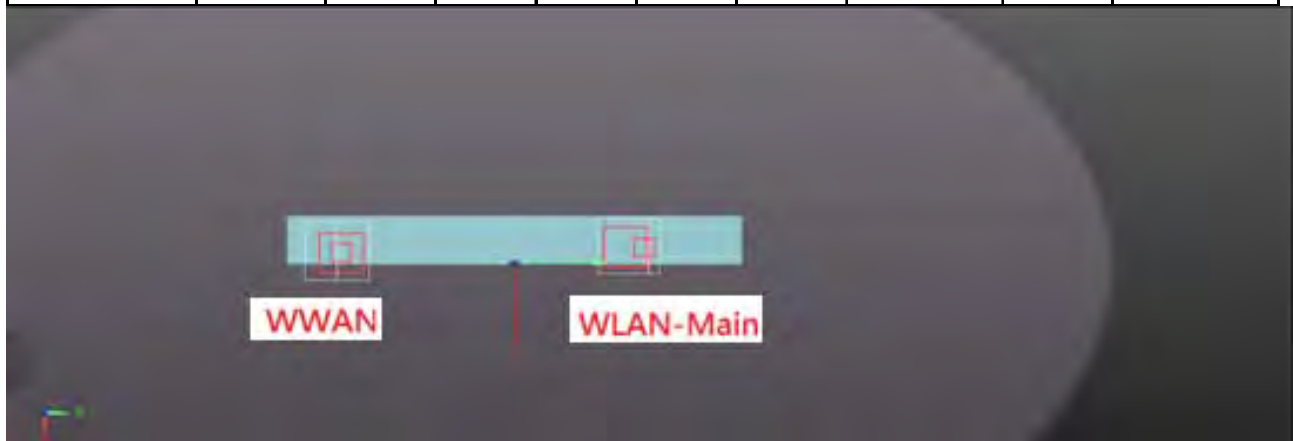

Unless otherwise stated the results shown in this test report refer only to the sample(s) tested and such sample(s) are retained for 90 days only.

除非另有說明，此報告結果僅對測試之樣品負責，同時此樣品僅保留90天。本報告未經本公司書面許可，不可部份複製。

This document is issued by the Company subject to its General Conditions of Service printed overleaf, available on request or accessible at www.sgs.com/terms_and_conditions.htm and, for electronic format documents, subject to Terms and Conditions for Electronic Documents at www.sgs.com/terms_e-document.htm. Attention is drawn to the limitation of liability, indemnification and jurisdiction issues defined therein. Any holder of this document is advised that information contained hereon reflects the Company's findings at the time of its intervention only and within the limits of Client's instructions, if any. The Company's sole responsibility is to its Client and this document does not exonerate parties to a transaction from exercising all their rights and obligations under the transaction documents. This document cannot be reproduced except in full, without prior written approval of the Company. Any unauthorized alteration, forgery or falsification of the content or appearance of this document is unlawful and offenders may be prosecuted to the fullest extent of the law.

WWAN & WLAN Aux

| Conditions | Position | SAR Value (W/kg) | Coordinates (cm) | | | ΣSAR (W/kg) | Peak Location Separation Distance (mm) | SPLSR | Simultaneous Transmission SAR Test |
|------------|----------|------------------|------------------|-------|-------|-------------|--|-------|------------------------------------|
| | | | x | y | z | | | | |
| GPRS 1900 | Top side | 1.144 | -0.54 | -8.59 | 0.45 | 1.986 | 90.7 | 0.031 | SPLSR<0.04, Not required |
| WLAN Aux | | 0.842 | -0.74 | 0.58 | -0.73 | | | | |

WLAN Main & WLAN Aux

| Conditions | Position | SAR Value (W/kg) | Coordinates (cm) | | | ΣSAR (W/kg) | Peak Location Separation Distance (mm) | SPLSR | Simultaneous Transmission SAR Test |
|------------|----------|------------------|------------------|------|-------|-------------|--|-------|------------------------------------|
| | | | x | y | z | | | | |
| WLAN Main | Top side | 0.0527 | -0.70 | 6.24 | 2.55 | 0.8947 | 67.1 | 0.013 | SPLSR<0.04, Not required |
| WLAN Aux | | 0.842 | -0.74 | 0.58 | -0.73 | | | | |

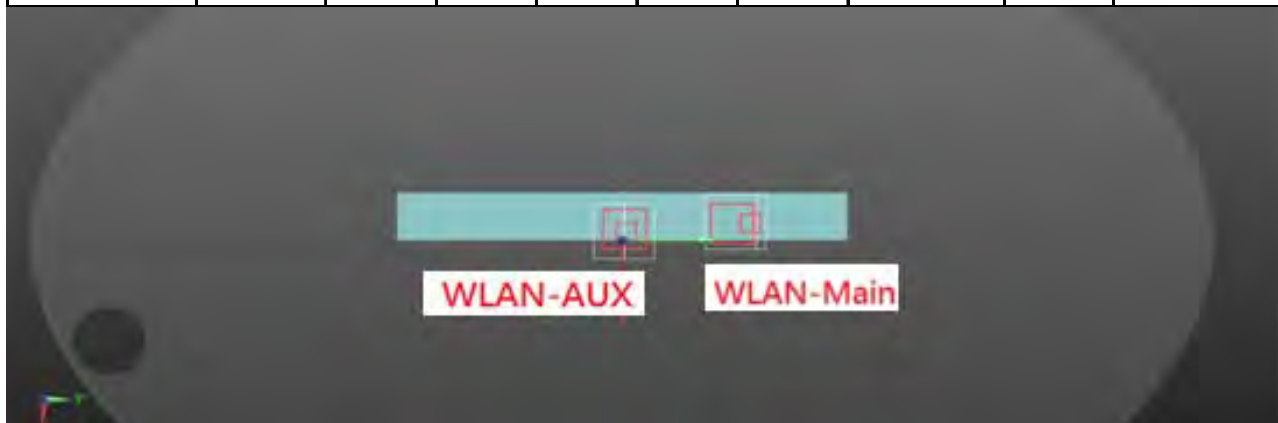

Unless otherwise stated the results shown in this test report refer only to the sample(s) tested and such sample(s) are retained for 90 days only.

除非另有說明，此報告結果僅對測試之樣品負責，同時此樣品僅保留90天。本報告未經本公司書面許可，不可部份複製。

This document is issued by the Company subject to its General Conditions of Service printed overleaf, available on request or accessible at www.sgs.com/terms_and_conditions.htm and, for electronic format documents, subject to Terms and Conditions for Electronic Documents at www.sgs.com/terms_e-document.htm. Attention is drawn to the limitation of liability, indemnification and jurisdiction issues defined therein. Any holder of this document is advised that information contained hereon reflects the Company's findings at the time of its intervention only and within the limits of Client's instructions, if any. The Company's sole responsibility is to its Client and this document does not exonerate parties to a transaction from exercising all their rights and obligations under the transaction documents. This document cannot be reproduced except in full, without prior written approval of the Company. Any unauthorized alteration, forgery or falsification of the content or appearance of this document is unlawful and offenders may be prosecuted to the fullest extent of the law.

WCDMA Band II + 2.4GHz WLAN MIMO

| No. | Conditions | Position | Distance (mm) | Max. WWAN | Max. WLAN Main | Max. WLAN Aux | SAR Sum | SPLSR |
|-----|--------------|------------------------|---------------|-----------|----------------|---------------|---------------|--------------------------------|
| 3 | WCDMA Band 2 | Back side | 0 | 0.962 | 0.261 | 0.111 | 1.334 | Σ SAR<1.6, Not required |
| | | Back side_Curve(Left) | 0 | 1.16 | - | - | - | Σ SAR<1.6, Not required |
| | | Back side_Curve(Right) | 0 | - | 0.356 | - | - | Σ SAR<1.6, Not required |
| | | Top side | 0 | 1.033 | 0.0527 | 0.842 | 1.9277 | Analyzed as below |
| | | Bottom side | 0 | 0.016 | 0.006 | 0.007 | 0.029 | Σ SAR<1.6, Not required |
| | | Left side | 0 | 0.299 | 0.006 | 0.003 | 0.308 | Σ SAR<1.6, Not required |
| | | Right side | 0 | 0.002 | 1.01 | 0.007 | 1.019 | Σ SAR<1.6, Not required |

WWAN & WLAN Main

| Conditions | Position | SAR Value (W/kg) | Coordinates (cm) | | | Σ SAR (W/kg) | Peak Location Separation Distance (mm) | SPLSR | Simultaneous Transmission SAR Test |
|------------|----------|------------------|------------------|-------|------|---------------------|--|-------|------------------------------------|
| | | | x | y | z | | | | |
| WCDMA B2 | Top side | 1.033 | -1.00 | -8.00 | 0.45 | 1.0857 | 144 | 0.008 | SPLSR<0.04, Not required |
| WLAN Main | | 0.0527 | -0.70 | 6.24 | 2.55 | | | | |

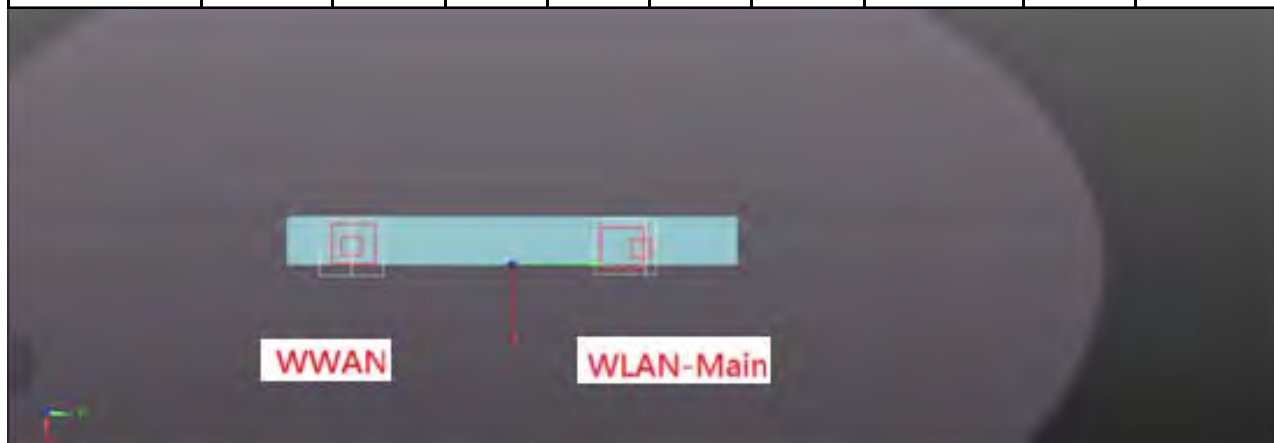

Unless otherwise stated the results shown in this test report refer only to the sample(s) tested and such sample(s) are retained for 90 days only.

除非另有說明，此報告結果僅對測試之樣品負責，同時此樣品僅保留90天。本報告未經本公司書面許可，不可部份複製。

This document is issued by the Company subject to its General Conditions of Service printed overleaf, available on request or accessible at www.sgs.com/terms_and_conditions.htm and, for electronic format documents, subject to Terms and Conditions for Electronic Documents at www.sgs.com/terms_e-document.htm. Attention is drawn to the limitation of liability, indemnification and jurisdiction issues defined therein. Any holder of this document is advised that information contained hereon reflects the Company's findings at the time of its intervention only and within the limits of Client's instructions, if any. The Company's sole responsibility is to its Client and this document does not exonerate parties to a transaction from exercising all their rights and obligations under the transaction documents. This document cannot be reproduced except in full, without prior written approval of the Company. Any unauthorized alteration, forgery or falsification of the content or appearance of this document is unlawful and offenders may be prosecuted to the fullest extent of the law.

WWAN & WLAN Aux

| Conditions | Position | SAR Value (W/kg) | Coordinates (cm) | | | ΣSAR (W/kg) | Peak Location Separation Distance (mm) | SPLSR | Simultaneous Transmission SAR Test |
|------------|----------|------------------|------------------|-------|-------|-------------|--|-------|------------------------------------|
| | | | x | y | z | | | | |
| WCDMA B2 | Top side | 1.033 | -1.00 | -8.00 | 0.45 | 1.875 | 85 | 0.030 | SPLSR<0.04, Not required |
| WLAN Aux | | 0.842 | -0.74 | 0.58 | -0.73 | | | | |

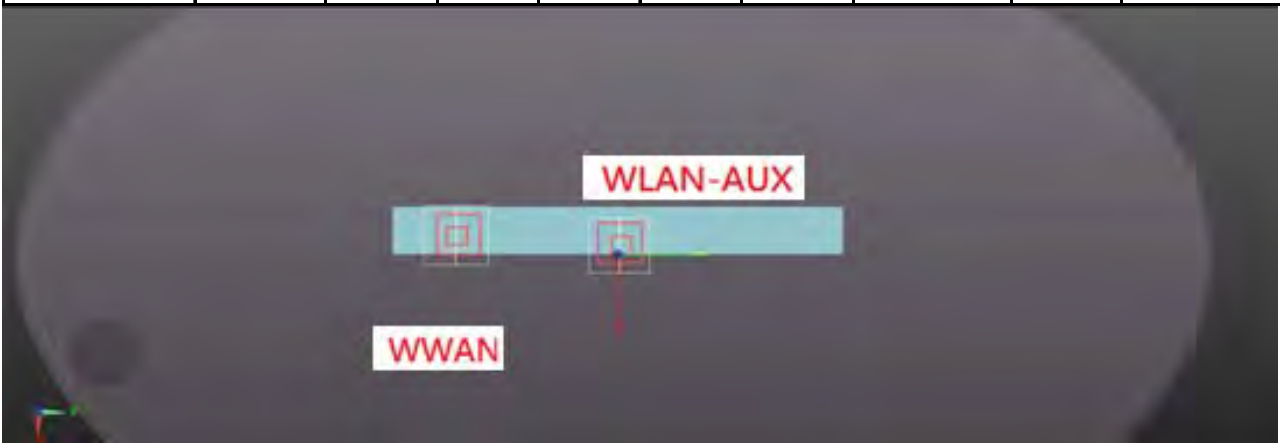

WLAN Main & WLAN Aux

| Conditions | Position | SAR Value (W/kg) | Coordinates (cm) | | | ΣSAR (W/kg) | Peak Location Separation Distance (mm) | SPLSR | Simultaneous Transmission SAR Test |
|------------|----------|------------------|------------------|------|-------|-------------|--|-------|------------------------------------|
| | | | x | y | z | | | | |
| WLAN Main | Top side | 0.0527 | -0.70 | 6.24 | 2.55 | 0.8947 | 67.1 | 0.013 | SPLSR<0.04, Not required |
| WLAN Aux | | 0.842 | -0.74 | 0.58 | -0.73 | | | | |

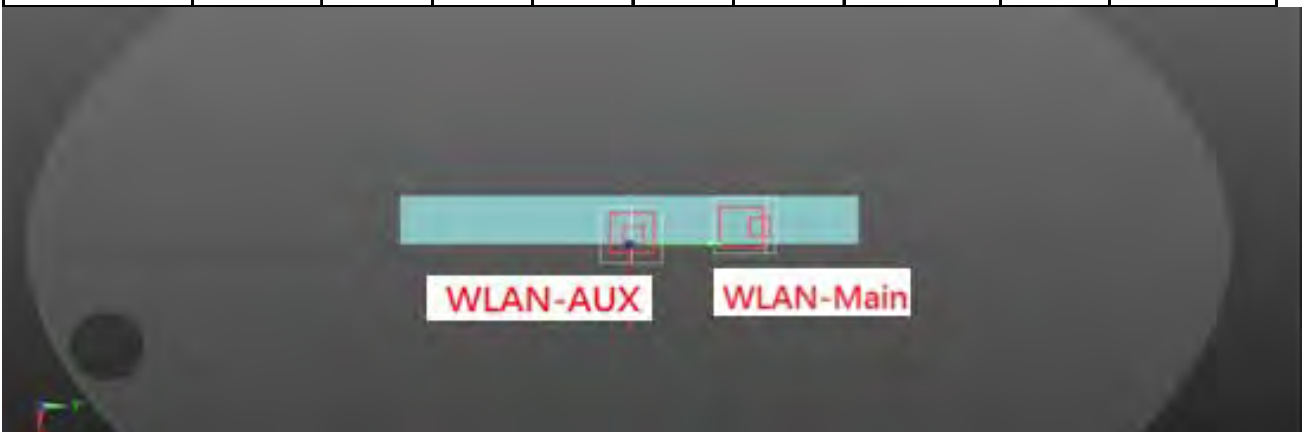

Unless otherwise stated the results shown in this test report refer only to the sample(s) tested and such sample(s) are retained for 90 days only.

除非另有說明，此報告結果僅對測試之樣品負責，同時此樣品僅保留90天。本報告未經本公司書面許可，不可部份複製。

This document is issued by the Company subject to its General Conditions of Service printed overleaf, available on request or accessible at www.sgs.com/terms_and_conditions.htm and, for electronic format documents, subject to Terms and Conditions for Electronic Documents at www.sgs.com/terms_e-document.htm. Attention is drawn to the limitation of liability, indemnification and jurisdiction issues defined therein. Any holder of this document is advised that information contained hereon reflects the Company's findings at the time of its intervention only and within the limits of Client's instructions, if any. The Company's sole responsibility is to its Client and this document does not exonerate parties to a transaction from exercising all their rights and obligations under the transaction documents. This document cannot be reproduced except in full, without prior written approval of the Company. Any unauthorized alteration, forgery or falsification of the content or appearance of this document is unlawful and offenders may be prosecuted to the fullest extent of the law.

WCDMA Band IV + 2.4GHz WLAN MIMO

| No. | Conditions | Position | Distance (mm) | Max. WWAN | Max. WLAN Main | Max. WLAN Aux | SAR Sum | SPLSR |
|-----|--------------|------------------------|---------------|-----------|----------------|---------------|---------------|--------------------------------|
| 4 | WCDMA Band 4 | Back side | 0 | 0.999 | 0.261 | 0.111 | 1.371 | Σ SAR<1.6, Not required |
| | | Back side_Curve(Left) | 0 | 1.131 | - | - | - | Σ SAR<1.6, Not required |
| | | Back side_Curve(Right) | 0 | - | 0.356 | - | - | Σ SAR<1.6, Not required |
| | | Top side | 0 | 1.049 | 0.0527 | 0.842 | 1.9437 | Analyzed as below |
| | | Bottom side | 0 | 0.0235 | 0.006 | 0.007 | 0.0365 | Σ SAR<1.6, Not required |
| | | Left side | 0 | 0.532 | 0.006 | 0.003 | 0.541 | Σ SAR<1.6, Not required |
| | | Right side | 0 | 0.0042 | 1.01 | 0.007 | 1.0212 | Σ SAR<1.6, Not required |

WWAN & WLAN Main

| Conditions | Position | SAR Value (W/kg) | Coordinates (cm) | | | Σ SAR (W/kg) | Peak Location Separation Distance (mm) | SPLSR | Simultaneous Transmission SAR Test |
|------------|----------|------------------|------------------|-------|-------|---------------------|--|-------|------------------------------------|
| | | | x | y | z | | | | |
| WCDMA B4 | Top side | 1.049 | -0.84 | -8.59 | -0.50 | 1.1017 | 151.4 | 0.008 | SPLSR<0.04, Not required |
| WLAN Main | | 0.0527 | -0.70 | 6.24 | 2.55 | | | | |

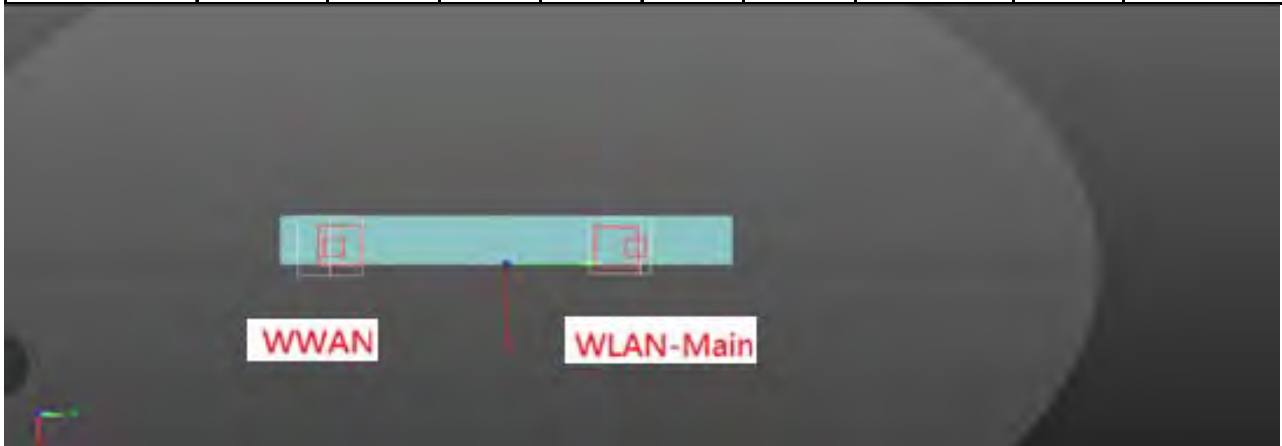

Unless otherwise stated the results shown in this test report refer only to the sample(s) tested and such sample(s) are retained for 90 days only.

除非另有說明，此報告結果僅對測試之樣品負責，同時此樣品僅保留90天。本報告未經本公司書面許可，不可部份複製。

This document is issued by the Company subject to its General Conditions of Service printed overleaf, available on request or accessible at www.sgs.com/terms_and_conditions.htm and, for electronic format documents, subject to Terms and Conditions for Electronic Documents at www.sgs.com/terms_e-document.htm. Attention is drawn to the limitation of liability, indemnification and jurisdiction issues defined therein. Any holder of this document is advised that information contained hereon reflects the Company's findings at the time of its intervention only and within the limits of Client's instructions, if any. The Company's sole responsibility is to its Client and this document does not exonerate parties to a transaction from exercising all their rights and obligations under the transaction documents. This document cannot be reproduced except in full, without prior written approval of the Company. Any unauthorized alteration, forgery or falsification of the content or appearance of this document is unlawful and offenders may be prosecuted to the fullest extent of the law.

WWAN & WLAN Aux

| Conditions | Position | SAR Value (W/kg) | Coordinates (cm) | | | ΣSAR (W/kg) | Peak Location Separation Distance (mm) | SPLSR | Simultaneous Transmission SAR Test |
|------------|----------|------------------|------------------|-------|-------|-------------|--|-------|------------------------------------|
| | | | x | y | z | | | | |
| WCDMA B4 | Top side | 1.049 | -0.84 | -8.59 | -0.50 | 1.891 | 90 | 0.029 | SPLSR<0.04, Not required |
| WLAN Aux | | 0.842 | -0.74 | 0.58 | -0.73 | | | | |

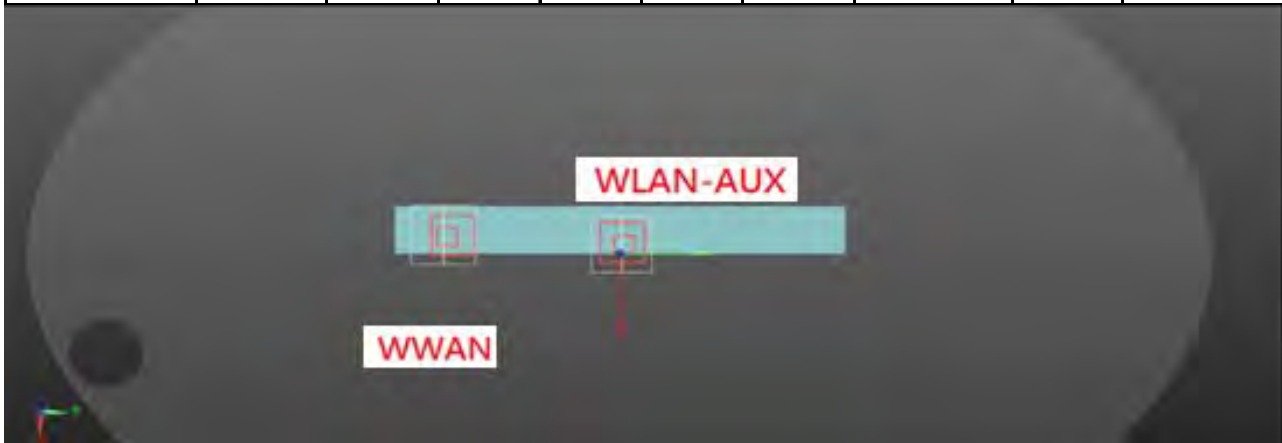

WLAN Main & WLAN Aux

| Conditions | Position | SAR Value (W/kg) | Coordinates (cm) | | | ΣSAR (W/kg) | Peak Location Separation Distance (mm) | SPLSR | Simultaneous Transmission SAR Test |
|------------|----------|------------------|------------------|------|-------|-------------|--|-------|------------------------------------|
| | | | x | y | z | | | | |
| WLAN Main | Top side | 0.0527 | -0.70 | 6.24 | 2.55 | 0.8947 | 67.1 | 0.013 | SPLSR<0.04, Not required |
| WLAN Aux | | 0.842 | -0.74 | 0.58 | -0.73 | | | | |

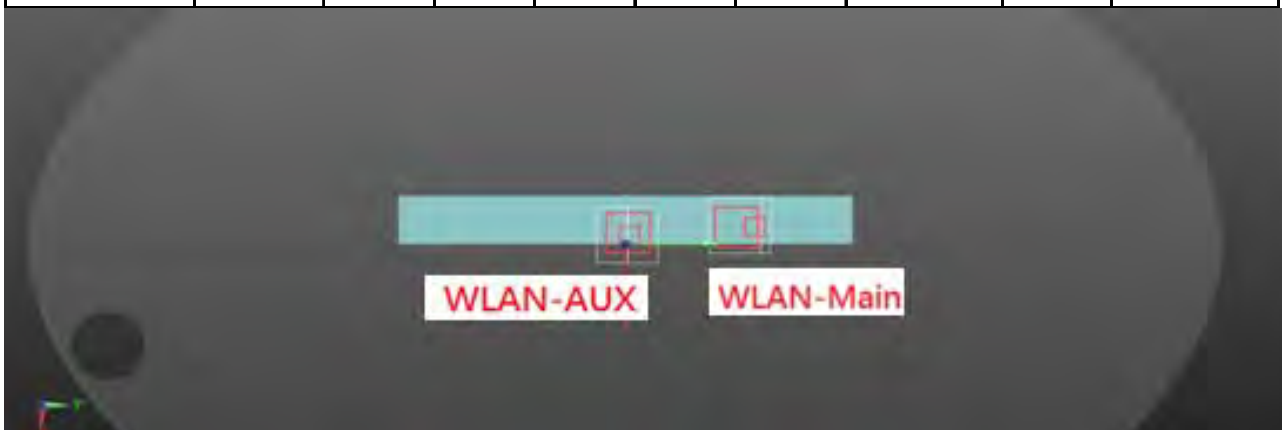

Unless otherwise stated the results shown in this test report refer only to the sample(s) tested and such sample(s) are retained for 90 days only.

除非另有說明，此報告結果僅對測試之樣品負責，同時此樣品僅保留90天。本報告未經本公司書面許可，不可部份複製。

This document is issued by the Company subject to its General Conditions of Service printed overleaf, available on request or accessible at www.sgs.com/terms_and_conditions.htm and, for electronic format documents, subject to Terms and Conditions for Electronic Documents at www.sgs.com/terms_e-document.htm. Attention is drawn to the limitation of liability, indemnification and jurisdiction issues defined therein. Any holder of this document is advised that information contained hereon reflects the Company's findings at the time of its intervention only and within the limits of Client's instructions, if any. The Company's sole responsibility is to its Client and this document does not exonerate parties to a transaction from exercising all their rights and obligations under the transaction documents. This document cannot be reproduced except in full, without prior written approval of the Company. Any unauthorized alteration, forgery or falsification of the content or appearance of this document is unlawful and offenders may be prosecuted to the fullest extent of the law.

WCDMA Band V + 2.4GHz WLAN MIMO

| No. | Conditions | Position | Distance (mm) | Max. WWAN | Max. WLAN Main | Max. WLAN Aux | SAR Sum | SPLSR |
|-----|--------------|------------------------|---------------|-----------|----------------|---------------|---------|--------------------------------|
| 5 | WCDMA Band 5 | Back side | 0 | 0.407 | 0.261 | 0.111 | 0.779 | Σ SAR<1.6, Not required |
| | | Back side_Curve(Left) | 0 | 0.402 | - | - | - | Σ SAR<1.6, Not required |
| | | Back side_Curve(Right) | 0 | - | 0.356 | - | - | Σ SAR<1.6, Not required |
| | | Top side | 0 | 0.391 | 0.0527 | 0.842 | 1.2857 | Σ SAR<1.6, Not required |
| | | Bottom side | 0 | 0.035 | 0.006 | 0.007 | 0.048 | Σ SAR<1.6, Not required |
| | | Left side | 0 | 0.615 | 0.006 | 0.003 | 0.624 | Σ SAR<1.6, Not required |
| | | Right side | 0 | 0.003 | 1.01 | 0.007 | 1.02 | Σ SAR<1.6, Not required |

Unless otherwise stated the results shown in this test report refer only to the sample(s) tested and such sample(s) are retained for 90 days only.

除非另有說明，此報告結果僅對測試之樣品負責，同時此樣品僅保留90天。本報告未經本公司書面許可，不可部份複製。

This document is issued by the Company subject to its General Conditions of Service printed overleaf, available on request or accessible at www.sgs.com/terms_and_conditions.htm and, for electronic format documents, subject to Terms and Conditions for Electronic Documents at www.sgs.com/terms_e-document.htm. Attention is drawn to the limitation of liability, indemnification and jurisdiction issues defined therein. Any holder of this document is advised that information contained hereon reflects the Company's findings at the time of its intervention only and within the limits of Client's instructions, if any. The Company's sole responsibility is to its Client and this document does not exonerate parties to a transaction from exercising all their rights and obligations under the transaction documents. This document cannot be reproduced except in full, without prior written approval of the Company. Any unauthorized alteration, forgery or falsification of the content or appearance of this document is unlawful and offenders may be prosecuted to the fullest extent of the law.

LTE FDD Band II + 2.4GHz WLAN MIMO

| No. | Conditions | Position | Distance (mm) | Max. WWAN | Max. WLAN Main | Max. WLAN Aux | SAR Sum | SPLSR |
|-----|------------|------------------------|---------------|-----------|----------------|---------------|---------------|--------------------------------|
| 6 | LTE Band 2 | Back side | 0 | 1.062 | 0.261 | 0.111 | 1.434 | Σ SAR<1.6, Not required |
| | | Back side_Curve(Left) | 0 | 1.086 | - | - | - | Σ SAR<1.6, Not required |
| | | Back side_Curve(Right) | 0 | - | 0.356 | - | - | Σ SAR<1.6, Not required |
| | | Top side | 0 | 1.09 | 0.0527 | 0.842 | 1.9847 | Analyzed as below |
| | | Bottom side | 0 | 0.041 | 0.006 | 0.007 | 0.054 | Σ SAR<1.6, Not required |
| | | Left side | 0 | 0.281 | 0.006 | 0.003 | 0.29 | Σ SAR<1.6, Not required |
| | | Right side | 0 | 0.027 | 1.01 | 0.007 | 1.044 | Σ SAR<1.6, Not required |

WWAN & WLAN Main

| Conditions | Position | SAR Value (W/kg) | Coordinates (cm) | | | Σ SAR (W/kg) | Peak Location Separation Distance (mm) | SPLSR | Simultaneous Transmission SAR Test |
|------------|----------|------------------|------------------|-------|------|---------------------|--|-------|------------------------------------|
| | | | x | y | z | | | | |
| LTE Band 2 | Top side | 1.09 | -1.30 | -8.16 | 0.45 | 1.1427 | 145.6 | 0.008 | SPLSR<0.04, Not required |
| WLAN Main | | 0.0527 | -0.70 | 6.24 | 2.55 | | | | |

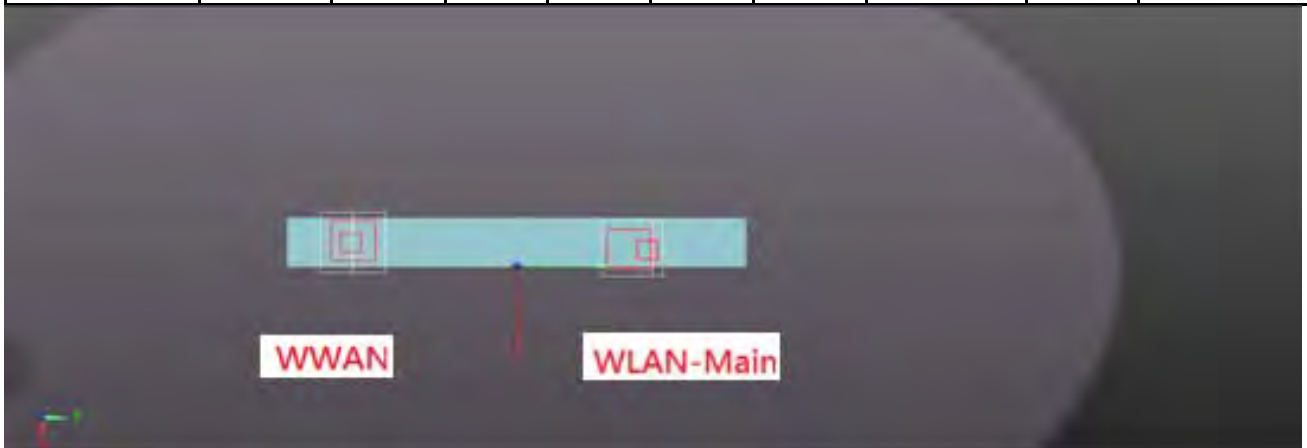

Unless otherwise stated the results shown in this test report refer only to the sample(s) tested and such sample(s) are retained for 90 days only.

除非另有說明，此報告結果僅對測試之樣品負責，同時此樣品僅保留90天。本報告未經本公司書面許可，不可部份複製。

This document is issued by the Company subject to its General Conditions of Service printed overleaf, available on request or accessible at www.sgs.com/terms_and_conditions.htm and, for electronic format documents, subject to Terms and Conditions for Electronic Documents at www.sgs.com/terms_e-document.htm. Attention is drawn to the limitation of liability, indemnification and jurisdiction issues defined therein. Any holder of this document is advised that information contained hereon reflects the Company's findings at the time of its intervention only and within the limits of Client's instructions, if any. The Company's sole responsibility is to its Client and this document does not exonerate parties to a transaction from exercising all their rights and obligations under the transaction documents. This document cannot be reproduced except in full, without prior written approval of the Company. Any unauthorized alteration, forgery or falsification of the content or appearance of this document is unlawful and offenders may be prosecuted to the fullest extent of the law.

WWAN & WLAN Aux

| Conditions | Position | SAR Value (W/kg) | Coordinates (cm) | | | Σ SAR (W/kg) | Peak Location Separation Distance (mm) | SPLSR | Simultaneous Transmission SAR Test |
|------------|----------|------------------|------------------|-------|-------|---------------------|--|-------|------------------------------------|
| | | | x | y | z | | | | |
| LTE Band 2 | Top side | 1.09 | -1.30 | -8.16 | 0.45 | 1.932 | 86.7 | 0.031 | SPLSR<0.04, Not required |
| WLAN Aux | | 0.842 | -0.74 | 0.58 | -0.73 | | | | |

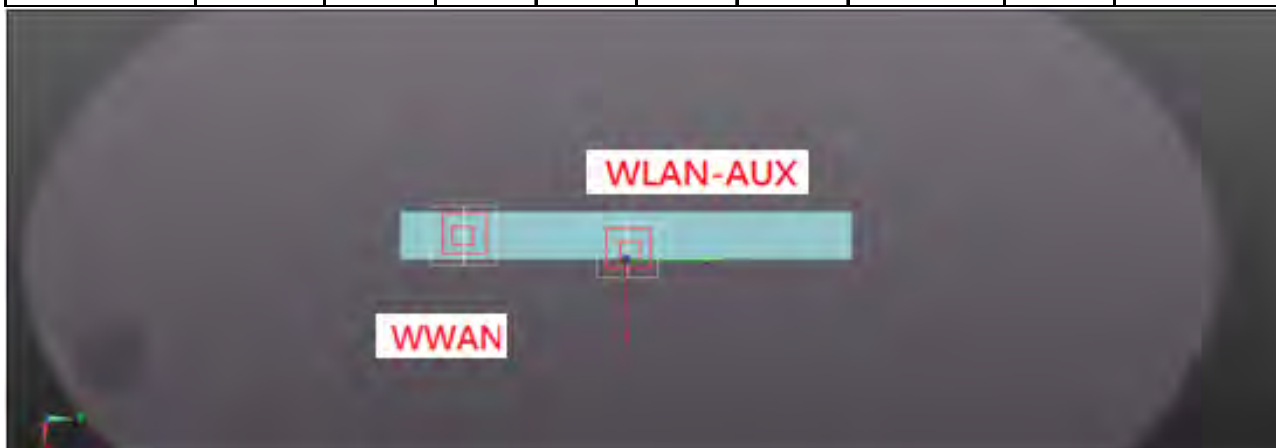

WLAN Main & WLAN Aux

| Conditions | Position | SAR Value (W/kg) | Coordinates (cm) | | | Σ SAR (W/kg) | Peak Location Separation Distance (mm) | SPLSR | Simultaneous Transmission SAR Test |
|------------|----------|------------------|------------------|------|-------|---------------------|--|-------|------------------------------------|
| | | | x | y | z | | | | |
| WLAN Main | Top side | 0.0527 | -0.70 | 6.24 | 2.55 | 0.8947 | 67.1 | 0.013 | SPLSR<0.04, Not required |
| WLAN Aux | | 0.842 | -0.74 | 0.58 | -0.73 | | | | |

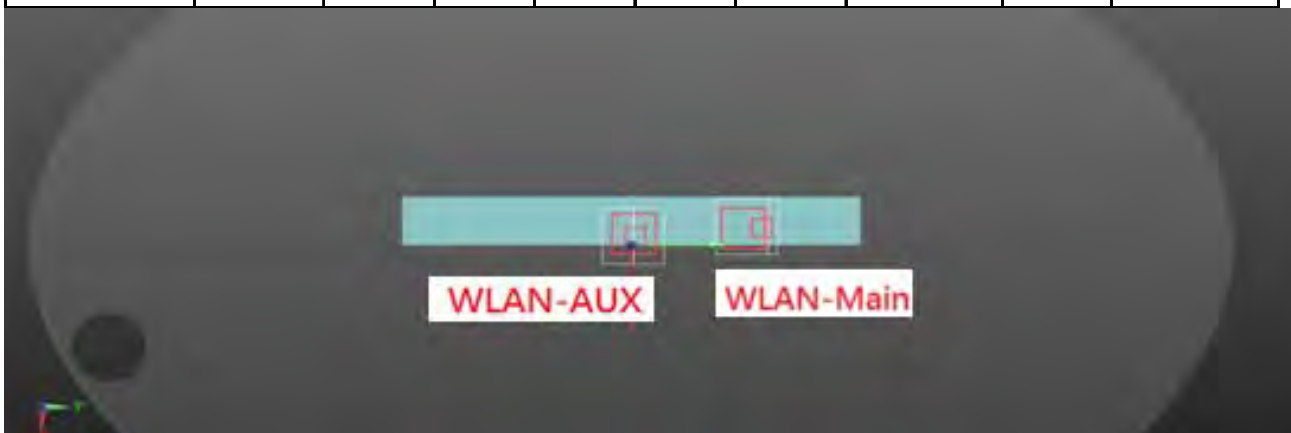

Unless otherwise stated the results shown in this test report refer only to the sample(s) tested and such sample(s) are retained for 90 days only.

除非另有說明，此報告結果僅對測試之樣品負責，同時此樣品僅保留90天。本報告未經本公司書面許可，不可部份複製。

This document is issued by the Company subject to its General Conditions of Service printed overleaf, available on request or accessible at www.sgs.com/terms_and_conditions.htm and, for electronic format documents, subject to Terms and Conditions for Electronic Documents at www.sgs.com/terms_e-document.htm. Attention is drawn to the limitation of liability, indemnification and jurisdiction issues defined therein. Any holder of this document is advised that information contained hereon reflects the Company's findings at the time of its intervention only and within the limits of Client's instructions, if any. The Company's sole responsibility is to its Client and this document does not exonerate parties to a transaction from exercising all their rights and obligations under the transaction documents. This document cannot be reproduced except in full, without prior written approval of the Company. Any unauthorized alteration, forgery or falsification of the content or appearance of this document is unlawful and offenders may be prosecuted to the fullest extent of the law.

LTE FDD Band IV + 2.4GHz WLAN MIMO

| No. | Conditions | Position | Distance (mm) | Max. WWAN | Max. WLAN Main | Max. WLAN Aux | SAR Sum | SPLSR |
|-----|------------|------------------------|---------------|-----------|----------------|---------------|---------------|------------------------|
| 7 | LTE Band 4 | Back side | 0 | 1.193 | 0.261 | 0.111 | 1.565 | ΣSAR<1.6, Not required |
| | | Back side_Curve(Left) | 0 | 1.154 | - | - | - | ΣSAR<1.6, Not required |
| | | Back side_Curve(Right) | 0 | - | 0.356 | - | - | ΣSAR<1.6, Not required |
| | | Top side | 0 | 1.069 | 0.0527 | 0.842 | 1.9637 | Analyzed as below |
| | | Bottom side | 0 | 0.044 | 0.006 | 0.007 | 0.057 | ΣSAR<1.6, Not required |
| | | Left side | 0 | 0.543 | 0.006 | 0.003 | 0.552 | ΣSAR<1.6, Not required |
| | | Right side | 0 | 0.007 | 1.01 | 0.007 | 1.024 | ΣSAR<1.6, Not required |

WWAN & WLAN Main

| Conditions | Position | SAR Value (W/kg) | Coordinates (cm) | | | ΣSAR (W/kg) | Peak Location Separation Distance (mm) | SPLSR | Simultaneous Transmission SAR Test |
|------------|----------|------------------|------------------|-------|-------|-------------|--|-------|------------------------------------|
| | | | x | y | z | | | | |
| LTE Band 4 | Top side | 1.069 | -1.35 | -8.34 | -0.48 | 1.1217 | 149 | 0.008 | SPLSR<0.04, Not required |
| WLAN Main | | 0.0527 | -0.70 | 6.24 | 2.55 | | | | |

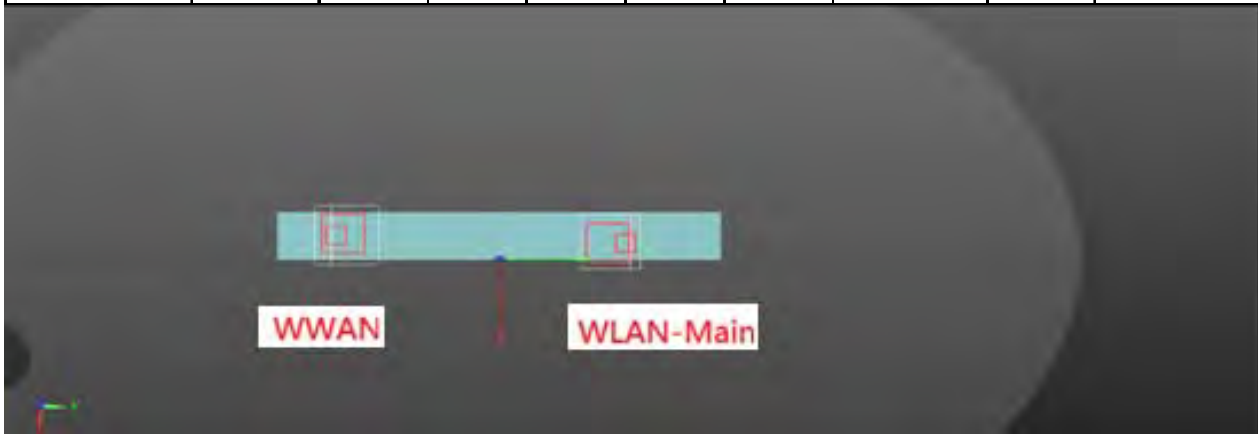

Unless otherwise stated the results shown in this test report refer only to the sample(s) tested and such sample(s) are retained for 90 days only.

除非另有說明，此報告結果僅對測試之樣品負責，同時此樣品僅保留90天。本報告未經本公司書面許可，不可部份複製。

This document is issued by the Company subject to its General Conditions of Service printed overleaf, available on request or accessible at www.sgs.com/terms_and_conditions.htm and, for electronic format documents, subject to Terms and Conditions for Electronic Documents at www.sgs.com/terms_e-document.htm. Attention is drawn to the limitation of liability, indemnification and jurisdiction issues defined therein. Any holder of this document is advised that information contained hereon reflects the Company's findings at the time of its intervention only and within the limits of Client's instructions, if any. The Company's sole responsibility is to its Client and this document does not exonerate parties to a transaction from exercising all their rights and obligations under the transaction documents. This document cannot be reproduced except in full, without prior written approval of the Company. Any unauthorized alteration, forgery or falsification of the content or appearance of this document is unlawful and offenders may be prosecuted to the fullest extent of the law.

WWAN & WLAN Aux

| Conditions | Position | SAR Value (W/kg) | Coordinates (cm) | | | ΣSAR (W/kg) | Peak Location Separation Distance (mm) | SPLSR | Simultaneous Transmission SAR Test |
|------------|----------|------------------|------------------|-------|-------|-------------|--|-------|------------------------------------|
| | | | x | y | z | | | | |
| LTE Band 4 | Top side | 1.069 | -1.35 | -8.34 | -0.48 | 1.911 | 87.8 | 0.030 | SPLSR<0.04, Not required |
| WLAN Aux | | 0.842 | -0.74 | 0.58 | -0.73 | | | | |

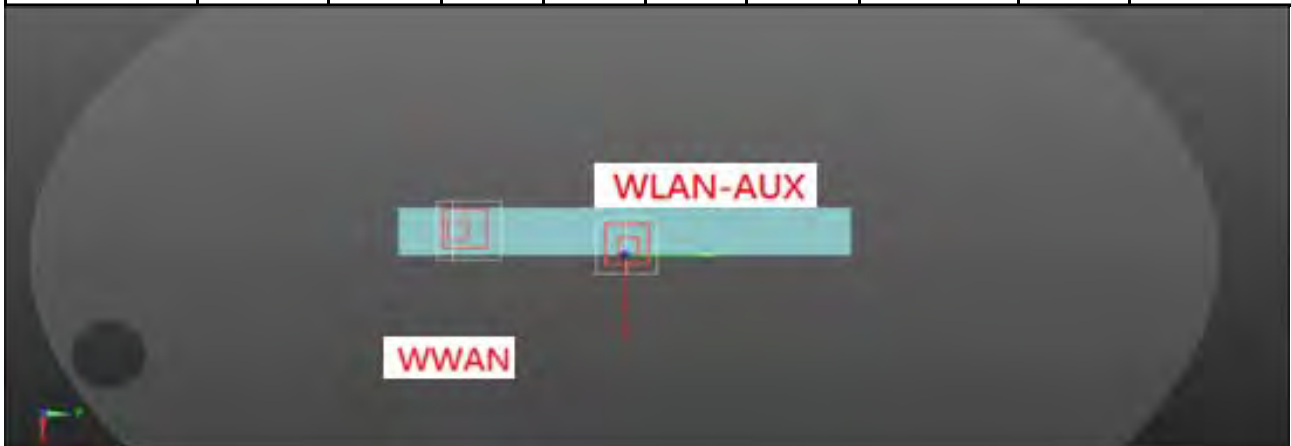
WLAN Main & WLAN Aux

| Conditions | Position | SAR Value (W/kg) | Coordinates (cm) | | | ΣSAR (W/kg) | Peak Location Separation Distance (mm) | SPLSR | Simultaneous Transmission SAR Test |
|------------|----------|------------------|------------------|------|-------|-------------|--|-------|------------------------------------|
| | | | x | y | z | | | | |
| WLAN Main | Top side | 0.0527 | -0.70 | 6.24 | 2.55 | 0.8947 | 67.1 | 0.013 | SPLSR<0.04, Not required |
| WLAN Aux | | 0.842 | -0.74 | 0.58 | -0.73 | | | | |

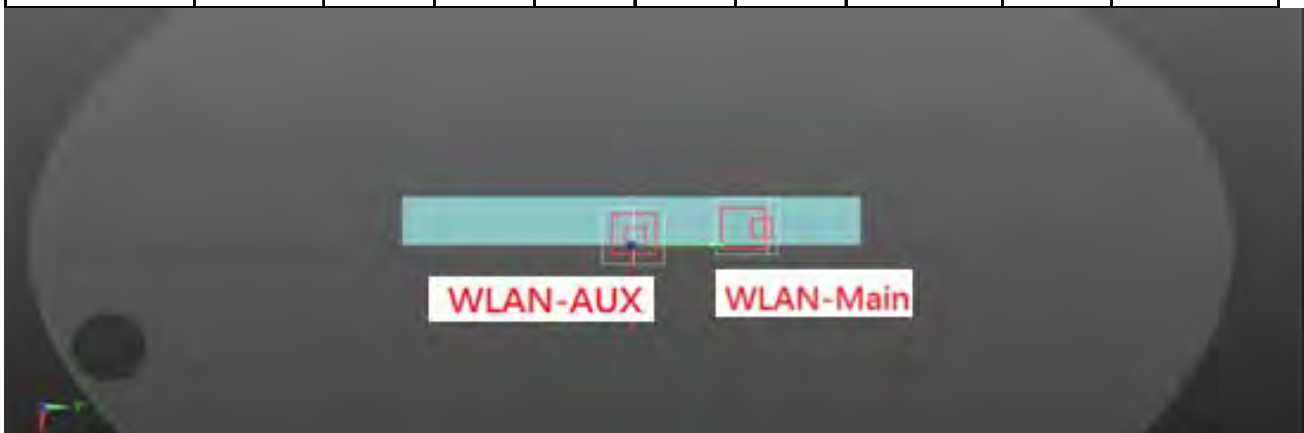

Unless otherwise stated the results shown in this test report refer only to the sample(s) tested and such sample(s) are retained for 90 days only.

除非另有說明，此報告結果僅對測試之樣品負責，同時此樣品僅保留90天。本報告未經本公司書面許可，不可部份複製。

This document is issued by the Company subject to its General Conditions of Service printed overleaf, available on request or accessible at www.sgs.com/terms_and_conditions.htm and, for electronic format documents, subject to Terms and Conditions for Electronic Documents at www.sgs.com/terms_e-document.htm. Attention is drawn to the limitation of liability, indemnification and jurisdiction issues defined therein. Any holder of this document is advised that information contained hereon reflects the Company's findings at the time of its intervention only and within the limits of Client's instructions, if any. The Company's sole responsibility is to its Client and this document does not exonerate parties to a transaction from exercising all their rights and obligations under the transaction documents. This document cannot be reproduced except in full, without prior written approval of the Company. Any unauthorized alteration, forgery or falsification of the content or appearance of this document is unlawful and offenders may be prosecuted to the fullest extent of the law.

LTE FDD Band V + 2.4GHz WLAN MIMO

| No. | Conditions | Position | Distance (mm) | Max. WWAN | Max. WLAN Main | Max. WLAN Aux | SAR Sum | SPLSR |
|-----|------------|------------------------|---------------|-----------|----------------|---------------|---------|--------------------------------|
| 8 | LTE Band 5 | Back side | 0 | 0.491 | 0.261 | 0.111 | 0.863 | Σ SAR<1.6, Not required |
| | | Back side_Curve(Left) | 0 | 0.58 | - | - | - | Σ SAR<1.6, Not required |
| | | Back side_Curve(Right) | 0 | - | 0.356 | - | - | Σ SAR<1.6, Not required |
| | | Top side | 0 | 0.576 | 0.0527 | 0.842 | 1.4707 | Σ SAR<1.6, Not required |
| | | Bottom side | 0 | 0.076 | 0.006 | 0.007 | 0.089 | Σ SAR<1.6, Not required |
| | | Left side | 0 | 0.601 | 0.006 | 0.003 | 0.61 | Σ SAR<1.6, Not required |
| | | Right side | 0 | 0.014 | 1.01 | 0.007 | 1.031 | Σ SAR<1.6, Not required |

LTE FDD Band XIII + 2.4GHz WLAN MIMO

| No. | Conditions | Position | Distance (mm) | Max. WWAN | Max. WLAN Main | Max. WLAN Aux | SAR Sum | SPLSR |
|-----|-------------|------------------------|---------------|-----------|----------------|---------------|---------|--------------------------------|
| 9 | LTE Band 13 | Back side | 0 | 0.468 | 0.261 | 0.111 | 0.84 | Σ SAR<1.6, Not required |
| | | Back side_Curve(Left) | 0 | 0.486 | - | - | - | Σ SAR<1.6, Not required |
| | | Back side_Curve(Right) | 0 | - | 0.356 | - | - | Σ SAR<1.6, Not required |
| | | Top side | 0 | 0.549 | 0.0527 | 0.842 | 1.4437 | Σ SAR<1.6, Not required |
| | | Bottom side | 0 | 0.093 | 0.006 | 0.007 | 0.106 | Σ SAR<1.6, Not required |
| | | Left side | 0 | 0.837 | 0.006 | 0.003 | 0.846 | Σ SAR<1.6, Not required |
| | | Right side | 0 | 0.01 | 1.01 | 0.007 | 1.027 | Σ SAR<1.6, Not required |

Unless otherwise stated the results shown in this test report refer only to the sample(s) tested and such sample(s) are retained for 90 days only.

除非另有說明，此報告結果僅對測試之樣品負責，同時此樣品僅保留90天。本報告未經本公司書面許可，不可部份複製。

This document is issued by the Company subject to its General Conditions of Service printed overleaf, available on request or accessible at www.sgs.com/terms_and_conditions.htm and, for electronic format documents, subject to Terms and Conditions for Electronic Documents at www.sgs.com/terms_e-document.htm. Attention is drawn to the limitation of liability, indemnification and jurisdiction issues defined therein. Any holder of this document is advised that information contained hereon reflects the Company's findings at the time of its intervention only and within the limits of Client's instructions, if any. The Company's sole responsibility is to its Client and this document does not exonerate parties to a transaction from exercising all their rights and obligations under the transaction documents. This document cannot be reproduced except in full, without prior written approval of the Company. Any unauthorized alteration, forgery or falsification of the content or appearance of this document is unlawful and offenders may be prosecuted to the fullest extent of the law.

LTE FDD Band XVII + 2.4GHz WLAN MIMO

| No. | Conditions | Position | Distance (mm) | Max. WWAN | Max. WLAN Main | Max. WLAN Aux | SAR Sum | SPLSR |
|-----|-------------|------------------------|---------------|-----------|----------------|---------------|---------|--------------------------------|
| 10 | LTE Band 17 | Back side | 0 | 0.264 | 0.261 | 0.111 | 0.636 | Σ SAR<1.6, Not required |
| | | Back side_Curve(Left) | 0 | 0.296 | - | - | - | Σ SAR<1.6, Not required |
| | | Back side_Curve(Right) | 0 | - | 0.356 | - | - | Σ SAR<1.6, Not required |
| | | Top side | 0 | 0.223 | 0.0527 | 0.842 | 1.1177 | Σ SAR<1.6, Not required |
| | | Bottom side | 0 | 0.009 | 0.006 | 0.007 | 0.022 | Σ SAR<1.6, Not required |
| | | Left side | 0 | 0.438 | 0.006 | 0.003 | 0.447 | Σ SAR<1.6, Not required |
| | | Right side | 0 | 0.005 | 1.01 | 0.007 | 1.022 | Σ SAR<1.6, Not required |

Unless otherwise stated the results shown in this test report refer only to the sample(s) tested and such sample(s) are retained for 90 days only.

除非另有說明，此報告結果僅對測試之樣品負責，同時此樣品僅保留90天。本報告未經本公司書面許可，不可部份複製。

This document is issued by the Company subject to its General Conditions of Service printed overleaf, available on request or accessible at www.sgs.com/terms_and_conditions.htm and, for electronic format documents, subject to Terms and Conditions for Electronic Documents at www.sgs.com/terms_e-document.htm. Attention is drawn to the limitation of liability, indemnification and jurisdiction issues defined therein. Any holder of this document is advised that information contained hereon reflects the Company's findings at the time of its intervention only and within the limits of Client's instructions, if any. The Company's sole responsibility is to its Client and this document does not exonerate parties to a transaction from exercising all their rights and obligations under the transaction documents. This document cannot be reproduced except in full, without prior written approval of the Company. Any unauthorized alteration, forgery or falsification of the content or appearance of this document is unlawful and offenders may be prosecuted to the fullest extent of the law.

LTE FDD Band XXV + 2.4GHz WLAN MIMO

| No. | Conditions | Position | Distance (mm) | Max. WWAN | Max. WLAN Main | Max. WLAN Aux | SAR Sum | SPLSR |
|-----|-------------|------------------------|---------------|-----------|----------------|---------------|---------------|--------------------------------|
| 11 | LTE Band 25 | Back side | 0 | 1.151 | 0.261 | 0.111 | 1.523 | Σ SAR<1.6, Not required |
| | | Back side_Curve(Left) | 0 | 0.979 | - | - | - | Σ SAR<1.6, Not required |
| | | Back side_Curve(Right) | 0 | - | 0.356 | - | - | Σ SAR<1.6, Not required |
| | | Top side | 0 | 1.159 | 0.0527 | 0.842 | 2.0537 | Analyzed as below |
| | | Bottom side | 0 | 0.026 | 0.006 | 0.007 | 0.039 | Σ SAR<1.6, Not required |
| | | Left side | 0 | 0.375 | 0.006 | 0.003 | 0.384 | Σ SAR<1.6, Not required |
| | | Right side | 0 | 0.007 | 1.01 | 0.007 | 1.024 | Σ SAR<1.6, Not required |

WWAN & WLAN Main

| Conditions | Position | SAR Value (W/kg) | Coordinates (cm) | | | Σ SAR (W/kg) | Peak Location Separation Distance (mm) | SPLSR | Simultaneous Transmission SAR Test |
|-------------|----------|------------------|------------------|-------|------|---------------------|--|-------|------------------------------------|
| | | | x | y | z | | | | |
| LTE Band 25 | Top side | 1.159 | -1.14 | -8.47 | 0.51 | 1.2117 | 148.6 | 0.009 | SPLSR<0.04, Not required |
| WLAN Main | | 0.0527 | -0.70 | 6.24 | 2.55 | | | | |

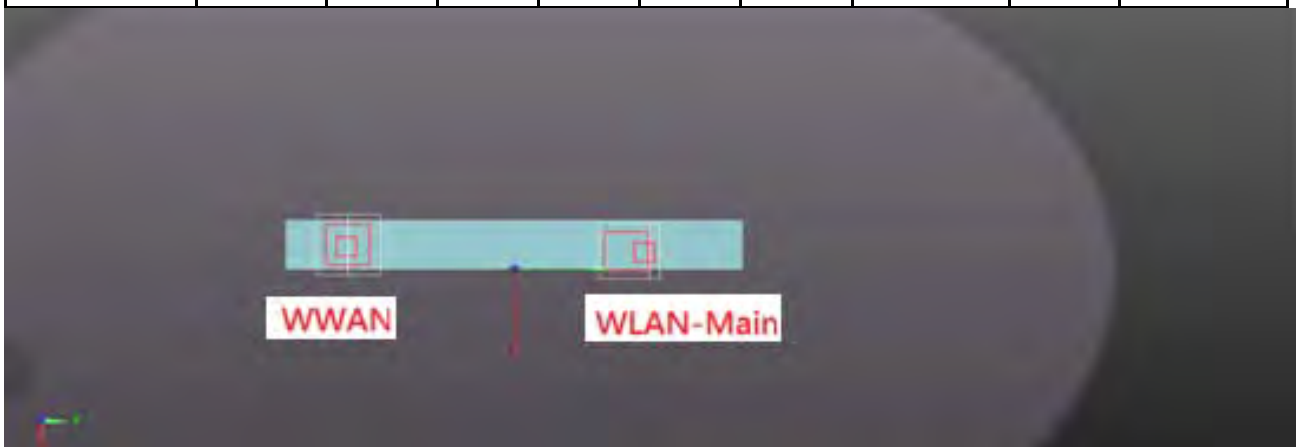

Unless otherwise stated the results shown in this test report refer only to the sample(s) tested and such sample(s) are retained for 90 days only.

除非另有說明，此報告結果僅對測試之樣品負責，同時此樣品僅保留90天。本報告未經本公司書面許可，不可部份複製。

This document is issued by the Company subject to its General Conditions of Service printed overleaf, available on request or accessible at www.sgs.com/terms_and_conditions.htm and, for electronic format documents, subject to Terms and Conditions for Electronic Documents at www.sgs.com/terms_e-document.htm. Attention is drawn to the limitation of liability, indemnification and jurisdiction issues defined therein. Any holder of this document is advised that information contained hereon reflects the Company's findings at the time of its intervention only and within the limits of Client's instructions, if any. The Company's sole responsibility is to its Client and this document does not exonerate parties to a transaction from exercising all their rights and obligations under the transaction documents. This document cannot be reproduced except in full, without prior written approval of the Company. Any unauthorized alteration, forgery or falsification of the content or appearance of this document is unlawful and offenders may be prosecuted to the fullest extent of the law.

WWAN & WLAN Aux

| Conditions | Position | SAR Value (W/kg) | Coordinates (cm) | | | ΣSAR (W/kg) | Peak Location Separation Distance (mm) | SPLSR | Simultaneous Transmission SAR Test |
|-------------|----------|------------------|------------------|-------|-------|-------------|--|-------|------------------------------------|
| | | | x | y | z | | | | |
| LTE Band 25 | Top side | 1.159 | -1.14 | -8.47 | 0.51 | 2.001 | 89.8 | 0.032 | SPLSR<0.04, Not required |
| WLAN Aux | | 0.842 | -0.74 | 0.58 | -0.73 | | | | |



WLAN Main & WLAN Aux

| Conditions | Position | SAR Value (W/kg) | Coordinates (cm) | | | ΣSAR (W/kg) | Peak Location Separation Distance (mm) | SPLSR | Simultaneous Transmission SAR Test |
|------------|----------|------------------|------------------|------|-------|-------------|--|-------|------------------------------------|
| | | | x | y | z | | | | |
| WLAN Main | Top side | 0.0527 | -0.70 | 6.24 | 2.55 | 0.8947 | 67.1 | 0.013 | SPLSR<0.04, Not required |
| WLAN Aux | | 0.842 | -0.74 | 0.58 | -0.73 | | | | |

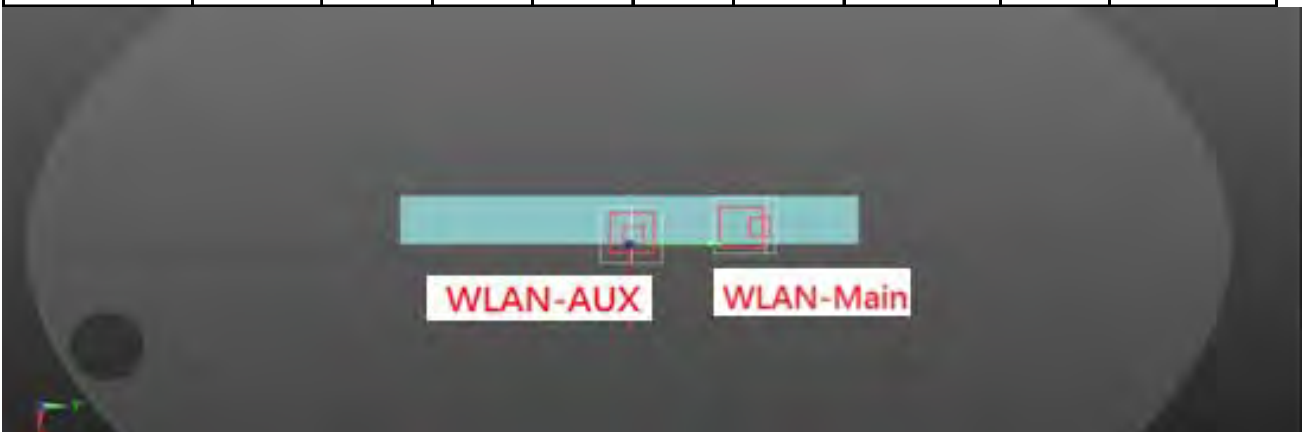

Unless otherwise stated the results shown in this test report refer only to the sample(s) tested and such sample(s) are retained for 90 days only.

除非另有說明，此報告結果僅對測試之樣品負責，同時此樣品僅保留90天。本報告未經本公司書面許可，不可部份複製。

This document is issued by the Company subject to its General Conditions of Service printed overleaf, available on request or accessible at www.sgs.com/terms_and_conditions.htm and, for electronic format documents, subject to Terms and Conditions for Electronic Documents at www.sgs.com/terms_e-document.htm. Attention is drawn to the limitation of liability, indemnification and jurisdiction issues defined therein. Any holder of this document is advised that information contained hereon reflects the Company's findings at the time of its intervention only and within the limits of Client's instructions, if any. The Company's sole responsibility is to its Client and this document does not exonerate parties to a transaction from exercising all their rights and obligations under the transaction documents. This document cannot be reproduced except in full, without prior written approval of the Company. Any unauthorized alteration, forgery or falsification of the content or appearance of this document is unlawful and offenders may be prosecuted to the fullest extent of the law.

CDMA / EVDO BC0 + 2.4GHz WLAN MIMO

| No. | Conditions | Position | Distance (mm) | Max. WWAN | Max. WLAN Main | Max. WLAN Aux | SAR Sum | SPLSR |
|-----|------------|------------------------|---------------|-----------|----------------|---------------|---------|--------------------------------|
| 12 | EVDO BC 0 | Back side | 0 | 0.54 | 0.261 | 0.111 | 0.912 | Σ SAR<1.6, Not required |
| | | Back side_Curve(Left) | 0 | 0.618 | - | - | - | Σ SAR<1.6, Not required |
| | | Back side_Curve(Right) | 0 | - | 0.356 | - | - | Σ SAR<1.6, Not required |
| | | Top side | 0 | 0.658 | 0.0527 | 0.842 | 1.5527 | Σ SAR<1.6, Not required |
| | | Bottom side | 0 | 0.07 | 0.006 | 0.007 | 0.083 | Σ SAR<1.6, Not required |
| | | Left side | 0 | 0.771 | 0.006 | 0.003 | 0.78 | Σ SAR<1.6, Not required |
| | | Right side | 0 | 0.007 | 1.01 | 0.007 | 1.024 | Σ SAR<1.6, Not required |

Unless otherwise stated the results shown in this test report refer only to the sample(s) tested and such sample(s) are retained for 90 days only.

除非另有說明，此報告結果僅對測試之樣品負責，同時此樣品僅保留90天。本報告未經本公司書面許可，不可部份複製。

This document is issued by the Company subject to its General Conditions of Service printed overleaf, available on request or accessible at www.sgs.com/terms_and_conditions.htm and, for electronic format documents, subject to Terms and Conditions for Electronic Documents at www.sgs.com/terms_e-document.htm. Attention is drawn to the limitation of liability, indemnification and jurisdiction issues defined therein. Any holder of this document is advised that information contained hereon reflects the Company's findings at the time of its intervention only and within the limits of Client's instructions, if any. The Company's sole responsibility is to its Client and this document does not exonerate parties to a transaction from exercising all their rights and obligations under the transaction documents. This document cannot be reproduced except in full, without prior written approval of the Company. Any unauthorized alteration, forgery or falsification of the content or appearance of this document is unlawful and offenders may be prosecuted to the fullest extent of the law.

CDMA / EVDO BC1 + 2.4GHz WLAN MIMO

| No. | Conditions | Position | Distance (mm) | Max. WWAN | Max. WLAN Main | Max. WLAN Aux | SAR Sum | SPLSR |
|-----|------------|------------------------|---------------|-----------|----------------|---------------|---------------|--------------------------------|
| 13 | EVDO BC 1 | Back side | 0 | 1.008 | 0.261 | 0.111 | 1.38 | Σ SAR<1.6, Not required |
| | | Back side_Curve(Left) | 0 | 0.973 | - | - | - | Σ SAR<1.6, Not required |
| | | Back side_Curve(Right) | 0 | - | 0.356 | - | - | Σ SAR<1.6, Not required |
| | | Top side | 0 | 0.903 | 0.0527 | 0.842 | 1.7977 | Analyzed as below |
| | | Bottom side | 0 | 0.025 | 0.006 | 0.007 | 0.038 | Σ SAR<1.6, Not required |
| | | Left side | 0 | 0.341 | 0.006 | 0.003 | 0.35 | Σ SAR<1.6, Not required |
| | | Right side | 0 | 0.004 | 1.01 | 0.007 | 1.021 | Σ SAR<1.6, Not required |

WWAN & WLAN Main

| Conditions | Position | SAR Value (W/kg) | Coordinates (cm) | | | Σ SAR (W/kg) | Peak Location Separation Distance (mm) | SPLSR | Simultaneous Transmission SAR Test |
|------------|----------|------------------|------------------|-------|-------|---------------------|--|-------|------------------------------------|
| | | | x | y | z | | | | |
| EVDO BC 1 | Top side | 0.903 | -0.99 | -8.56 | -0.46 | 1.745 | 89.7 | 0.026 | SPLSR<0.04, Not required |
| WLAN Aux | | 0.842 | -0.74 | 0.58 | -0.73 | | | | |

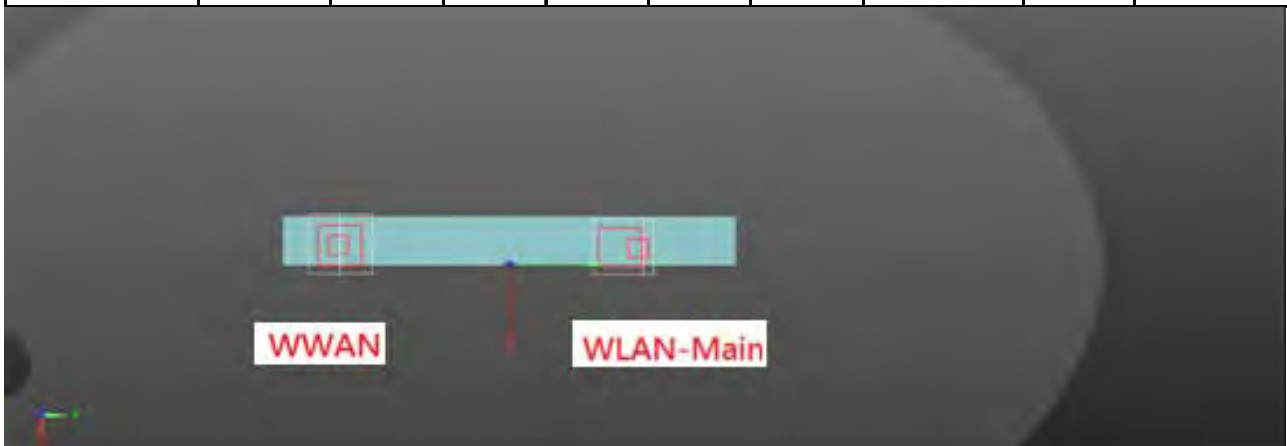

Unless otherwise stated the results shown in this test report refer only to the sample(s) tested and such sample(s) are retained for 90 days only.

除非另有說明，此報告結果僅對測試之樣品負責，同時此樣品僅保留90天。本報告未經本公司書面許可，不可部份複製。

This document is issued by the Company subject to its General Conditions of Service printed overleaf, available on request or accessible at www.sgs.com/terms_and_conditions.htm and, for electronic format documents, subject to Terms and Conditions for Electronic Documents at www.sgs.com/terms_e-document.htm. Attention is drawn to the limitation of liability, indemnification and jurisdiction issues defined therein. Any holder of this document is advised that information contained hereon reflects the Company's findings at the time of its intervention only and within the limits of Client's instructions, if any. The Company's sole responsibility is to its Client and this document does not exonerate parties to a transaction from exercising all their rights and obligations under the transaction documents. This document cannot be reproduced except in full, without prior written approval of the Company. Any unauthorized alteration, forgery or falsification of the content or appearance of this document is unlawful and offenders may be prosecuted to the fullest extent of the law.

WWAN & WLAN Aux

| Conditions | Position | SAR Value (W/kg) | Coordinates (cm) | | | ΣSAR (W/kg) | Peak Location Separation Distance (mm) | SPLSR | Simultaneous Transmission SAR Test |
|------------|----------|------------------|------------------|-------|-------|-------------|--|-------|------------------------------------|
| | | | x | y | z | | | | |
| EVDO BC 1 | Top side | 0.903 | -0.99 | -8.56 | -0.46 | 0.9557 | 151.1 | 0.006 | SPLSR<0.04, Not required |
| WLAN Main | | 0.0527 | -0.70 | 6.24 | 2.55 | | | | |

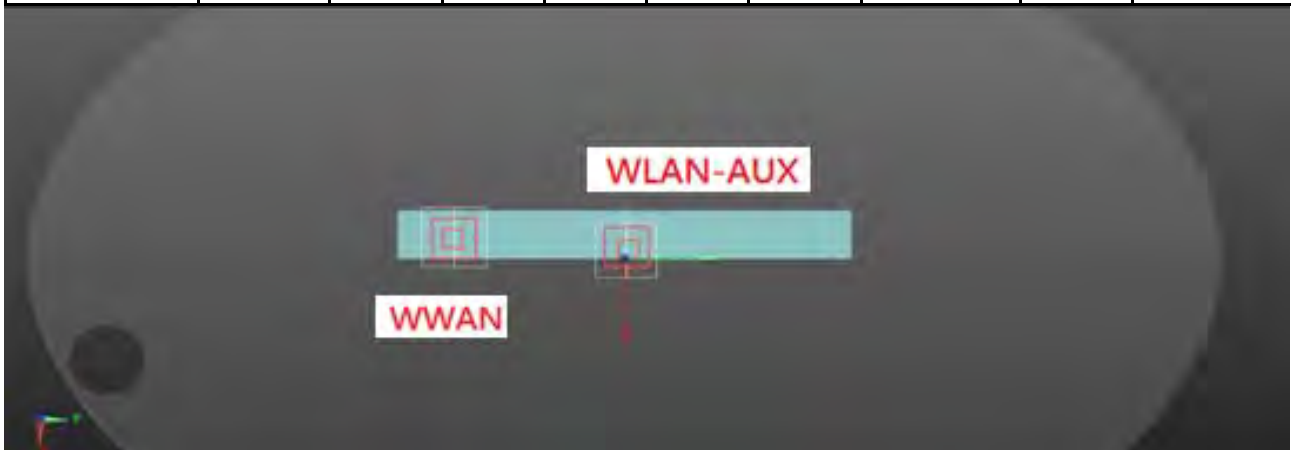

WLAN Main & WLAN Aux

| Conditions | Position | SAR Value (W/kg) | Coordinates (cm) | | | ΣSAR (W/kg) | Peak Location Separation Distance (mm) | SPLSR | Simultaneous Transmission SAR Test |
|------------|----------|------------------|------------------|------|-------|-------------|--|-------|------------------------------------|
| | | | x | y | z | | | | |
| WLAN Main | Top side | 0.0527 | -0.70 | 6.24 | 2.55 | 0.8947 | 67.1 | 0.013 | SPLSR<0.04, Not required |
| WLAN Aux | | 0.842 | -0.74 | 0.58 | -0.73 | | | | |

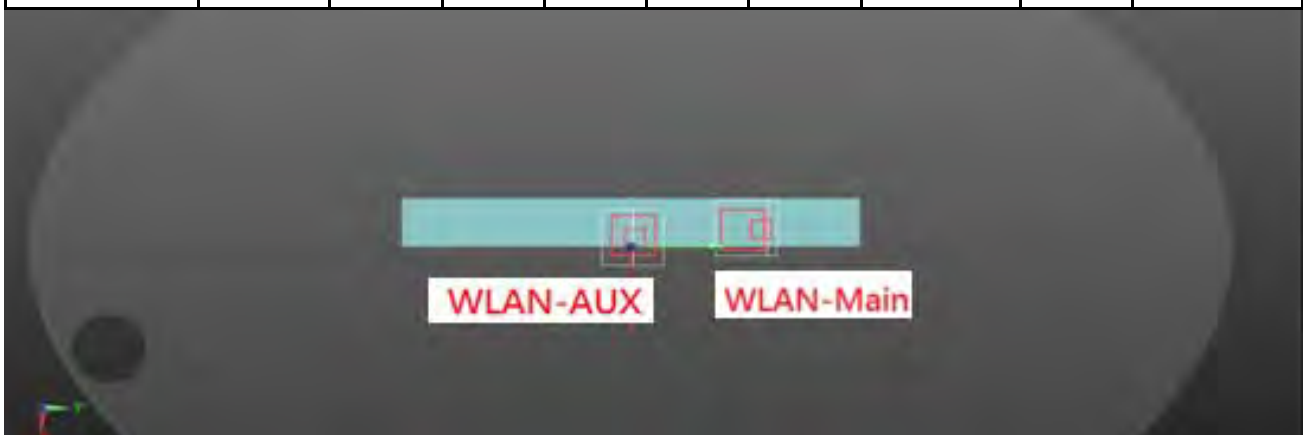

Unless otherwise stated the results shown in this test report refer only to the sample(s) tested and such sample(s) are retained for 90 days only.

除非另有說明，此報告結果僅對測試之樣品負責，同時此樣品僅保留90天。本報告未經本公司書面許可，不可部份複製。

This document is issued by the Company subject to its General Conditions of Service printed overleaf, available on request or accessible at www.sgs.com/terms_and_conditions.htm and, for electronic format documents, subject to Terms and Conditions for Electronic Documents at www.sgs.com/terms_e-document.htm. Attention is drawn to the limitation of liability, indemnification and jurisdiction issues defined therein. Any holder of this document is advised that information contained hereon reflects the Company's findings at the time of its intervention only and within the limits of Client's instructions, if any. The Company's sole responsibility is to its Client and this document does not exonerate parties to a transaction from exercising all their rights and obligations under the transaction documents. This document cannot be reproduced except in full, without prior written approval of the Company. Any unauthorized alteration, forgery or falsification of the content or appearance of this document is unlawful and offenders may be prosecuted to the fullest extent of the law.

CDMA / EVDO BC10 + 2.4GHz WLAN MIMO

| No. | Conditions | Position | Distance (mm) | Max. WWAN | Max. WLAN Main | Max. WLAN Aux | SAR Sum | SPLSR |
|-----|------------|------------------------|---------------|-----------|----------------|---------------|---------|--------------------------------|
| 14 | EVDO BC 10 | Back side | 0 | 0.55 | 0.261 | 0.111 | 0.922 | Σ SAR<1.6, Not required |
| | | Back side_Curve(Left) | 0 | 0.635 | - | - | - | Σ SAR<1.6, Not required |
| | | Back side_Curve(Right) | 0 | - | 0.356 | - | - | Σ SAR<1.6, Not required |
| | | Top side | 0 | 0.582 | 0.0527 | 0.842 | 1.4767 | Σ SAR<1.6, Not required |
| | | Bottom side | 0 | 0.058 | 0.006 | 0.007 | 0.071 | Σ SAR<1.6, Not required |
| | | Left side | 0 | 0.723 | 0.006 | 0.003 | 0.732 | Σ SAR<1.6, Not required |
| | | Right side | 0 | 0.004 | 1.01 | 0.007 | 1.021 | Σ SAR<1.6, Not required |

Unless otherwise stated the results shown in this test report refer only to the sample(s) tested and such sample(s) are retained for 90 days only.

除非另有說明，此報告結果僅對測試之樣品負責，同時此樣品僅保留90天。本報告未經本公司書面許可，不可部份複製。

This document is issued by the Company subject to its General Conditions of Service printed overleaf, available on request or accessible at www.sgs.com/terms_and_conditions.htm and, for electronic format documents, subject to Terms and Conditions for Electronic Documents at www.sgs.com/terms_e-document.htm. Attention is drawn to the limitation of liability, indemnification and jurisdiction issues defined therein. Any holder of this document is advised that information contained hereon reflects the Company's findings at the time of its intervention only and within the limits of Client's instructions, if any. The Company's sole responsibility is to its Client and this document does not exonerate parties to a transaction from exercising all their rights and obligations under the transaction documents. This document cannot be reproduced except in full, without prior written approval of the Company. Any unauthorized alteration, forgery or falsification of the content or appearance of this document is unlawful and offenders may be prosecuted to the fullest extent of the law.

GPRS 850 + 5GHz WLAN MIMO

| No. | Conditions | Position | Distance (mm) | Max. WWAN | Max. WLAN Main | Max. WLAN Aux | SAR Sum | SPLSR |
|-----|------------|------------------------|---------------|-----------|----------------|---------------|--------------|--------------------------------|
| 15 | 850 | Back side | 0 | 0.866 | 0.073 | 0.212 | 1.151 | Σ SAR<1.6, Not required |
| | | Back side_Curve(Left) | 0 | 0.754 | - | - | - | Σ SAR<1.6, Not required |
| | | Back side_Curve(Right) | 0 | - | 0.078 | - | - | Σ SAR<1.6, Not required |
| | | Top side | 0 | 0.762 | 0.089 | 0.928 | 1.779 | Analyzed as below |
| | | Bottom side | 0 | 0.013 | 0.003 | 0.007 | 0.023 | Σ SAR<1.6, Not required |
| | | Left side | 0 | 1.038 | 0.002 | 0.006 | 1.046 | Σ SAR<1.6, Not required |
| | | Right side | 0 | 0.002 | 0.513 | 0.029 | 0.544 | Σ SAR<1.6, Not required |

WWAN & WLAN Main

| Conditions | Position | SAR Value (W/kg) | Coordinates (cm) | | | Σ SAR (W/kg) | Peak Location Separation Distance (mm) | SPLSR | Simultaneous Transmission SAR Test |
|------------|----------|------------------|------------------|-------|-------|---------------------|--|-------|------------------------------------|
| | | | x | y | z | | | | |
| GPRS 850 | Top side | 0.762 | -0.84 | -4.83 | -0.70 | 0.851 | 138.9 | 0.006 | SPLSR<0.04, Not required |
| WLAN Main | | 0.089 | -2.10 | 8.72 | 2.08 | | | | |

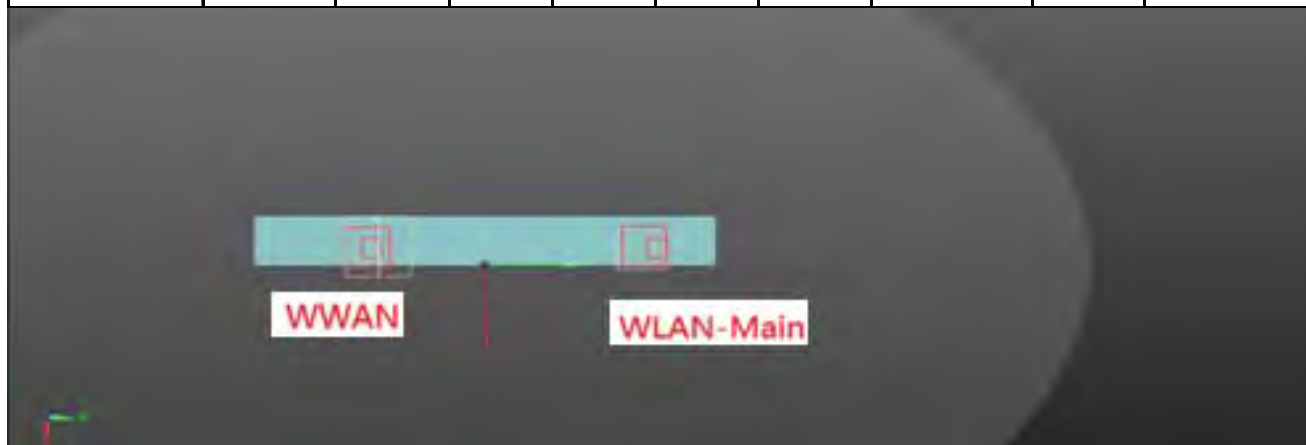

Unless otherwise stated the results shown in this test report refer only to the sample(s) tested and such sample(s) are retained for 90 days only.

除非另有說明，此報告結果僅對測試之樣品負責，同時此樣品僅保留90天。本報告未經本公司書面許可，不可部份複製。

This document is issued by the Company subject to its General Conditions of Service printed overleaf, available on request or accessible at www.sgs.com/terms_and_conditions.htm and, for electronic format documents, subject to Terms and Conditions for Electronic Documents at www.sgs.com/terms_e-document.htm. Attention is drawn to the limitation of liability, indemnification and jurisdiction issues defined therein. Any holder of this document is advised that information contained hereon reflects the Company's findings at the time of its intervention only and within the limits of Client's instructions, if any. The Company's sole responsibility is to its Client and this document does not exonerate parties to a transaction from exercising all their rights and obligations under the transaction documents. This document cannot be reproduced except in full, without prior written approval of the Company. Any unauthorized alteration, forgery or falsification of the content or appearance of this document is unlawful and offenders may be prosecuted to the fullest extent of the law.

WWAN & WLAN Aux

| Conditions | Position | SAR Value (W/kg) | Coordinates (cm) | | | ΣSAR (W/kg) | Peak Location Separation Distance (mm) | SPLSR | Simultaneous Transmission SAR Test |
|------------|----------|------------------|------------------|-------|-------|-------------|--|-------|------------------------------------|
| | | | x | y | z | | | | |
| GPRS 850 | Top side | 0.762 | -0.84 | -4.83 | -0.70 | 1.69 | 58 | 0.038 | SPLSR<0.04, Not required |
| WLAN Aux | | 0.928 | -1.08 | 0.96 | -0.76 | | | | |

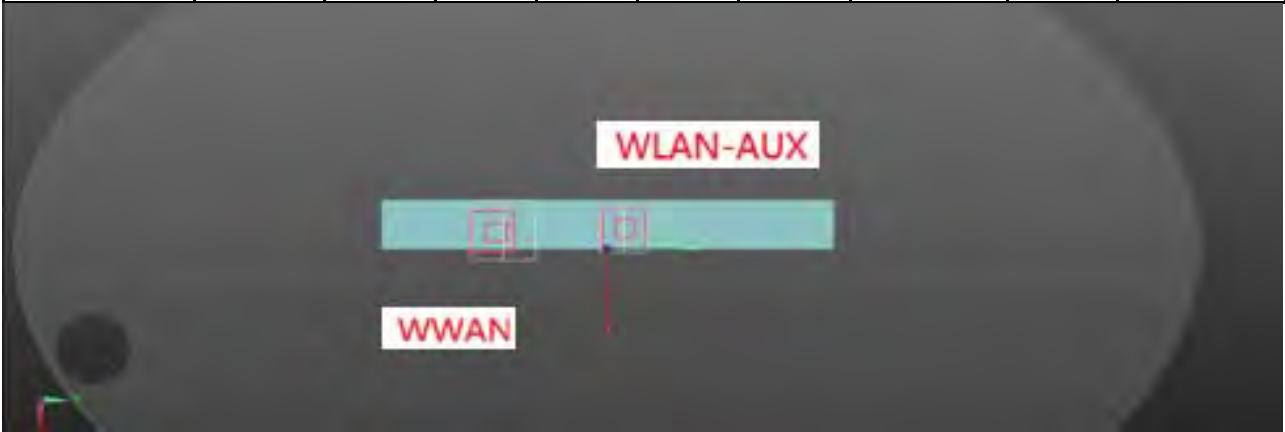
WLAN Main & WLAN Aux

| Conditions | Position | SAR Value (W/kg) | Coordinates (cm) | | | ΣSAR (W/kg) | Peak Location Separation Distance (mm) | SPLSR | Simultaneous Transmission SAR Test |
|------------|----------|------------------|------------------|------|-------|-------------|--|-------|------------------------------------|
| | | | x | y | z | | | | |
| WLAN Main | Top side | 0.089 | -2.10 | 8.72 | 2.08 | 1.017 | 83.2 | 0.012 | SPLSR<0.04, Not required |
| WLAN Aux | | 0.928 | -1.08 | 0.96 | -0.76 | | | | |

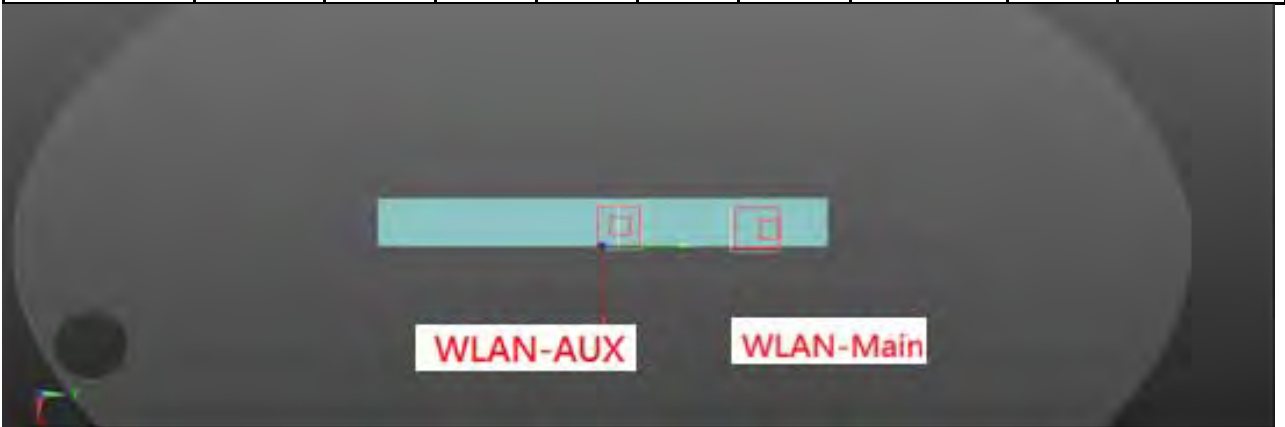

Unless otherwise stated the results shown in this test report refer only to the sample(s) tested and such sample(s) are retained for 90 days only.

除非另有說明，此報告結果僅對測試之樣品負責，同時此樣品僅保留90天。本報告未經本公司書面許可，不可部份複製。

This document is issued by the Company subject to its General Conditions of Service printed overleaf, available on request or accessible at www.sgs.com/terms_and_conditions.htm and, for electronic format documents, subject to Terms and Conditions for Electronic Documents at www.sgs.com/terms_e-document.htm. Attention is drawn to the limitation of liability, indemnification and jurisdiction issues defined therein. Any holder of this document is advised that information contained hereon reflects the Company's findings at the time of its intervention only and within the limits of Client's instructions, if any. The Company's sole responsibility is to its Client and this document does not exonerate parties to a transaction from exercising all their rights and obligations under the transaction documents. This document cannot be reproduced except in full, without prior written approval of the Company. Any unauthorized alteration, forgery or falsification of the content or appearance of this document is unlawful and offenders may be prosecuted to the fullest extent of the law.

GPRS 1900 + 5GHz WLAN MIMO

| No. | Conditions | Position | Distance (mm) | Max. WWAN | Max. WLAN Main | Max. WLAN Aux | SAR Sum | SPLSR |
|-----|------------|------------------------|---------------|-----------|----------------|---------------|--------------|--------------------------------|
| 16 | 1900 | Back side | 0 | 1.197 | 0.073 | 0.212 | 1.482 | Σ SAR<1.6, Not required |
| | | Back side_Curve(Left) | 0 | 1.335 | - | - | - | Σ SAR<1.6, Not required |
| | | Back side_Curve(Right) | 0 | - | 0.078 | - | - | Σ SAR<1.6, Not required |
| | | Top side | 0 | 1.144 | 0.089 | 0.928 | 2.161 | Analyzed as below |
| | | Bottom side | 0 | 0.0145 | 0.003 | 0.007 | 0.0245 | Σ SAR<1.6, Not required |
| | | Left side | 0 | 0.287 | 0.002 | 0.006 | 0.295 | Σ SAR<1.6, Not required |
| | | Right side | 0 | 0.0012 | 0.513 | 0.029 | 0.5432 | Σ SAR<1.6, Not required |

WWAN & WLAN Main

| Conditions | Position | SAR Value (W/kg) | Coordinates (cm) | | | Σ SAR (W/kg) | Peak Location Separation Distance (mm) | SPLSR | Simultaneous Transmission SAR Test |
|------------|----------|------------------|------------------|-------|------|---------------------|--|-------|------------------------------------|
| | | | x | y | z | | | | |
| GPRS 1900 | Top side | 1.144 | -0.54 | -8.59 | 0.45 | 1.233 | 174.6 | 0.008 | SPLSR<0.04, Not required |
| WLAN Main | | 0.089 | -2.10 | 8.72 | 2.08 | | | | |

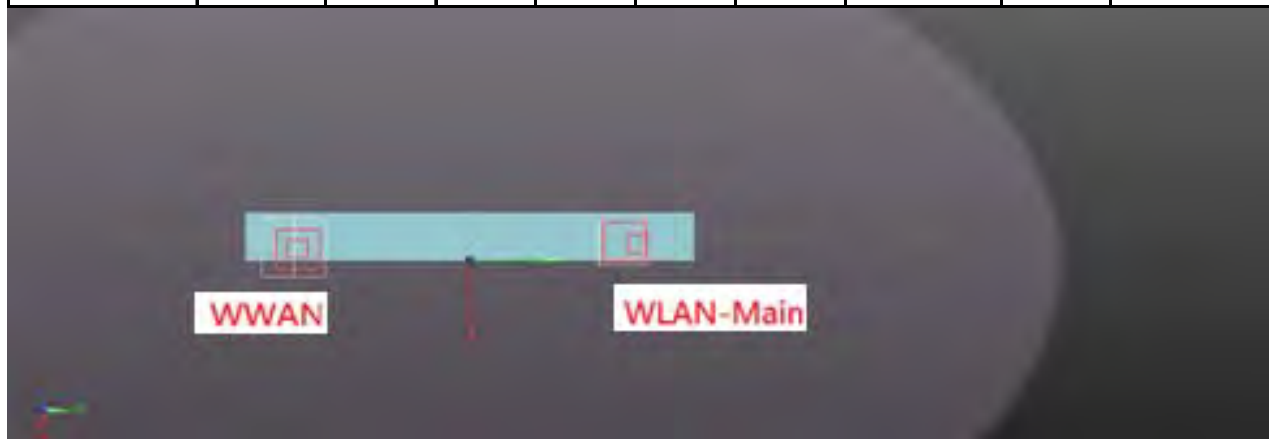

Unless otherwise stated the results shown in this test report refer only to the sample(s) tested and such sample(s) are retained for 90 days only.

除非另有說明，此報告結果僅對測試之樣品負責，同時此樣品僅保留90天。本報告未經本公司書面許可，不可部份複製。

This document is issued by the Company subject to its General Conditions of Service printed overleaf, available on request or accessible at www.sgs.com/terms_and_conditions.htm and, for electronic format documents, subject to Terms and Conditions for Electronic Documents at www.sgs.com/terms_e-document.htm. Attention is drawn to the limitation of liability, indemnification and jurisdiction issues defined therein. Any holder of this document is advised that information contained hereon reflects the Company's findings at the time of its intervention only and within the limits of Client's instructions, if any. The Company's sole responsibility is to its Client and this document does not exonerate parties to a transaction from exercising all their rights and obligations under the transaction documents. This document cannot be reproduced except in full, without prior written approval of the Company. Any unauthorized alteration, forgery or falsification of the content or appearance of this document is unlawful and offenders may be prosecuted to the fullest extent of the law.

WWAN & WLAN Aux

| Conditions | Position | SAR Value (W/kg) | Coordinates (cm) | | | ΣSAR (W/kg) | Peak Location Separation Distance (mm) | SPLSR | Simultaneous Transmission SAR Test |
|------------|----------|------------------|------------------|-------|-------|-------------|--|-------|------------------------------------|
| | | | x | y | z | | | | |
| GPRS 1900 | Top side | 1.144 | -0.54 | -8.59 | 0.45 | 2.072 | 96.4 | 0.031 | SPLSR<0.04, Not required |
| WLAN Aux | | 0.928 | -1.08 | 0.96 | -0.76 | | | | |

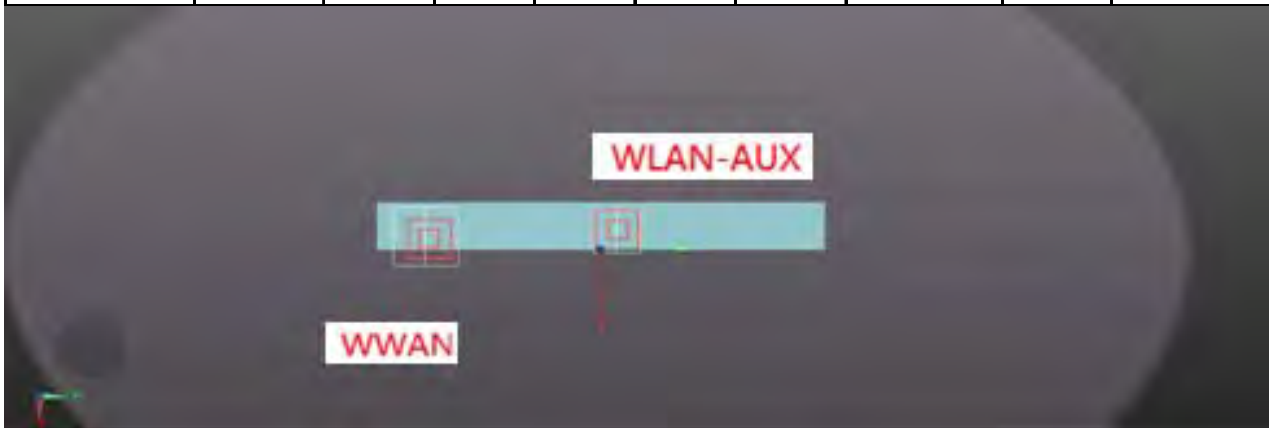

WLAN Main & WLAN Aux

| Conditions | Position | SAR Value (W/kg) | Coordinates (cm) | | | ΣSAR (W/kg) | Peak Location Separation Distance (mm) | SPLSR | Simultaneous Transmission SAR Test |
|------------|----------|------------------|------------------|------|-------|-------------|--|-------|------------------------------------|
| | | | x | y | z | | | | |
| WLAN Main | Top side | 0.089 | -2.10 | 8.72 | 2.08 | 1.017 | 83.2 | 0.012 | SPLSR<0.04, Not required |
| WLAN Aux | | 0.928 | -1.08 | 0.96 | -0.76 | | | | |

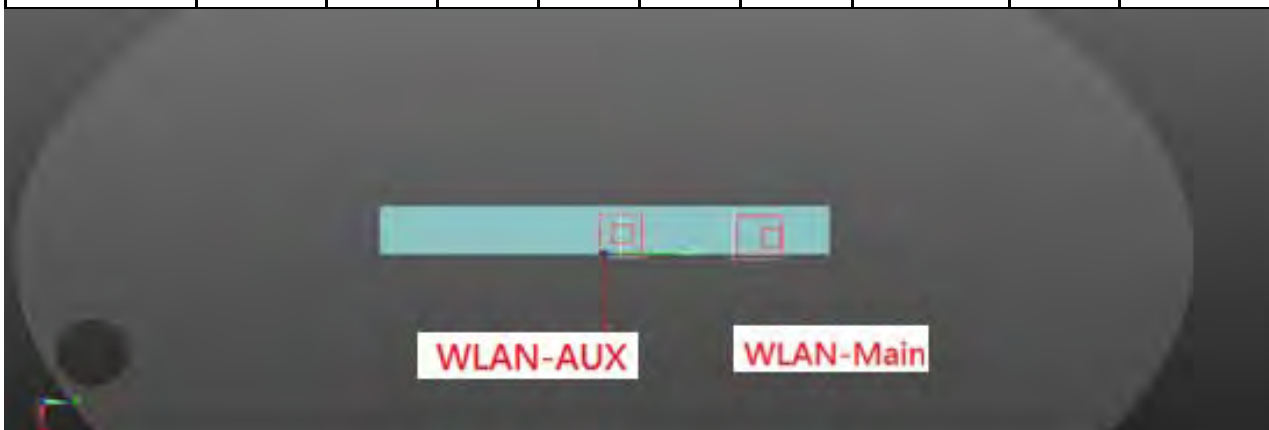

Unless otherwise stated the results shown in this test report refer only to the sample(s) tested and such sample(s) are retained for 90 days only.

除非另有說明，此報告結果僅對測試之樣品負責，同時此樣品僅保留90天。本報告未經本公司書面許可，不可部份複製。

This document is issued by the Company subject to its General Conditions of Service printed overleaf, available on request or accessible at www.sgs.com/terms_and_conditions.htm and, for electronic format documents, subject to Terms and Conditions for Electronic Documents at www.sgs.com/terms_e-document.htm. Attention is drawn to the limitation of liability, indemnification and jurisdiction issues defined therein. Any holder of this document is advised that information contained hereon reflects the Company's findings at the time of its intervention only and within the limits of Client's instructions, if any. The Company's sole responsibility is to its Client and this document does not exonerate parties to a transaction from exercising all their rights and obligations under the transaction documents. This document cannot be reproduced except in full, without prior written approval of the Company. Any unauthorized alteration, forgery or falsification of the content or appearance of this document is unlawful and offenders may be prosecuted to the fullest extent of the law.

WCDMA Band II + 5GHz WLAN MIMO

| No. | Conditions | Position | Distance (mm) | Max. WWAN | Max. WLAN Main | Max. WLAN Aux | SAR Sum | SPLSR |
|-----|--------------|------------------------|---------------|-----------|----------------|---------------|-------------|--------------------------------|
| 17 | WCDMA Band 2 | Back side | 0 | 0.962 | 0.073 | 0.212 | 1.247 | Σ SAR<1.6, Not required |
| | | Back side_Curve(Left) | 0 | 1.16 | - | - | - | Σ SAR<1.6, Not required |
| | | Back side_Curve(Right) | 0 | - | 0.078 | - | - | Σ SAR<1.6, Not required |
| | | Top side | 0 | 1.033 | 0.089 | 0.928 | 2.05 | Analyzed as below |
| | | Bottom side | 0 | 0.016 | 0.003 | 0.007 | 0.026 | Σ SAR<1.6, Not required |
| | | Left side | 0 | 0.299 | 0.002 | 0.006 | 0.307 | Σ SAR<1.6, Not required |
| | | Right side | 0 | 0.002 | 0.513 | 0.029 | 0.544 | Σ SAR<1.6, Not required |

WWAN & WLAN Main

| Conditions | Position | SAR Value (W/kg) | Coordinates (cm) | | | Σ SAR (W/kg) | Peak Location Separation Distance (mm) | SPLSR | Simultaneous Transmission SAR Test |
|------------|----------|------------------|------------------|-------|------|---------------------|--|-------|------------------------------------|
| | | | x | y | z | | | | |
| WCDMA B2 | Top side | 1.033 | -1.00 | -8.00 | 0.45 | 1.122 | 168.3 | 0.007 | SPLSR<0.04, Not required |
| WLAN Main | | 0.089 | -2.10 | 8.72 | 2.08 | | | | |

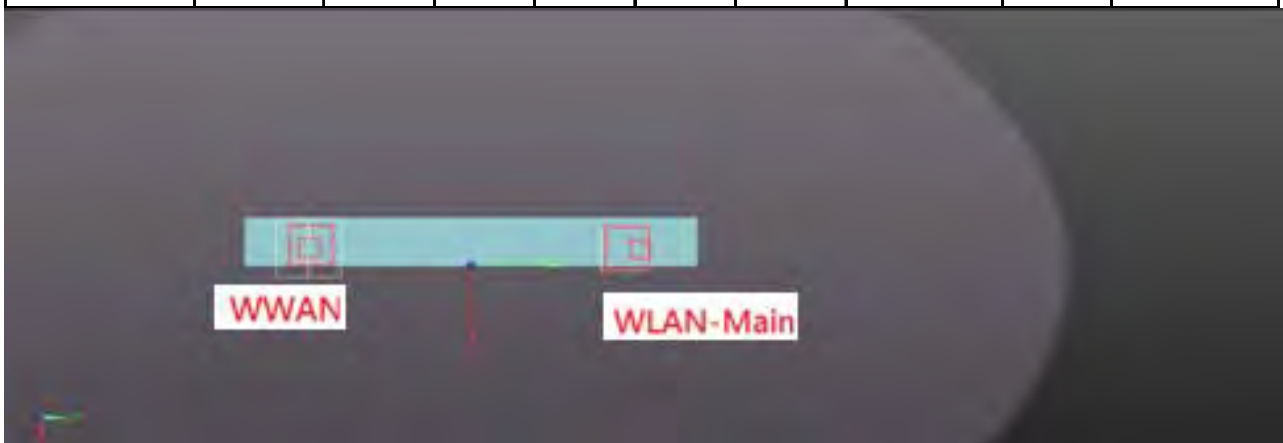

Unless otherwise stated the results shown in this test report refer only to the sample(s) tested and such sample(s) are retained for 90 days only.

除非另有說明，此報告結果僅對測試之樣品負責，同時此樣品僅保留90天。本報告未經本公司書面許可，不可部份複製。

This document is issued by the Company subject to its General Conditions of Service printed overleaf, available on request or accessible at www.sgs.com/terms_and_conditions.htm and, for electronic format documents, subject to Terms and Conditions for Electronic Documents at www.sgs.com/terms_e-document.htm. Attention is drawn to the limitation of liability, indemnification and jurisdiction issues defined therein. Any holder of this document is advised that information contained hereon reflects the Company's findings at the time of its intervention only and within the limits of Client's instructions, if any. The Company's sole responsibility is to its Client and this document does not exonerate parties to a transaction from exercising all their rights and obligations under the transaction documents. This document cannot be reproduced except in full, without prior written approval of the Company. Any unauthorized alteration, forgery or falsification of the content or appearance of this document is unlawful and offenders may be prosecuted to the fullest extent of the law.

WWAN & WLAN Aux

| Conditions | Position | SAR Value (W/kg) | Coordinates (cm) | | | ΣSAR (W/kg) | Peak Location Separation Distance (mm) | SPLSR | Simultaneous Transmission SAR Test |
|------------|----------|------------------|------------------|-------|-------|-------------|--|-------|------------------------------------|
| | | | x | y | z | | | | |
| WCDMA B2 | Top side | 1.033 | -1.00 | -8.00 | 0.45 | 1.961 | 90.4 | 0.030 | SPLSR<0.04, Not required |
| WLAN Aux | | 0.928 | -1.08 | 0.96 | -0.76 | | | | |

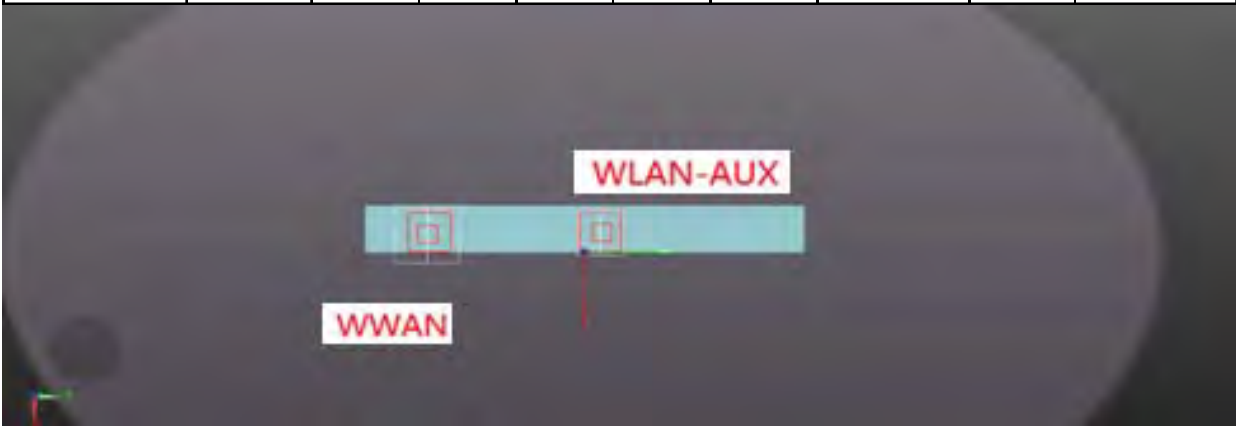

WLAN Main & WLAN Aux

| Conditions | Position | SAR Value (W/kg) | Coordinates (cm) | | | ΣSAR (W/kg) | Peak Location Separation Distance (mm) | SPLSR | Simultaneous Transmission SAR Test |
|------------|----------|------------------|------------------|------|-------|-------------|--|-------|------------------------------------|
| | | | x | y | z | | | | |
| WLAN Main | Top side | 0.089 | -2.10 | 8.72 | 2.08 | 1.017 | 83.2 | 0.012 | SPLSR<0.04, Not required |
| WLAN Aux | | 0.928 | -1.08 | 0.96 | -0.76 | | | | |

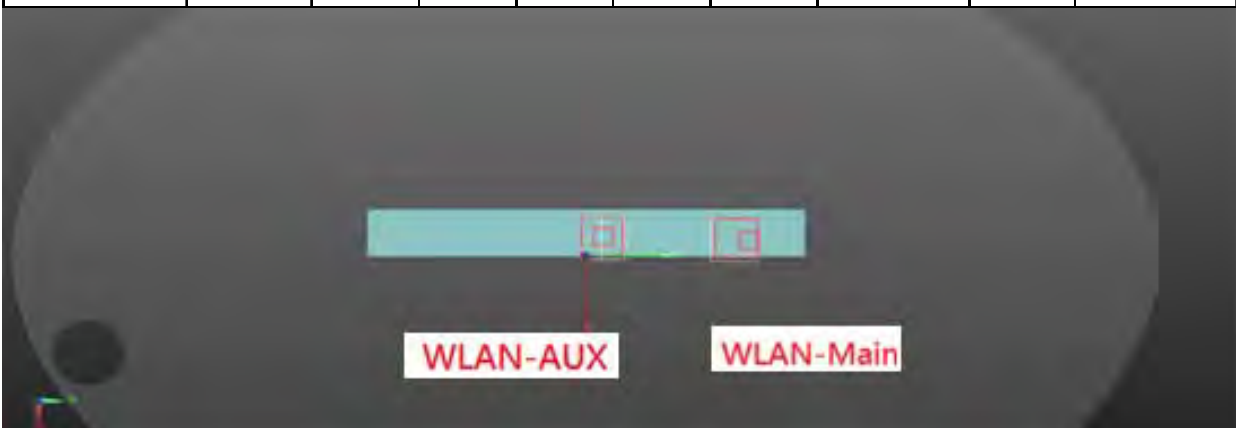

Unless otherwise stated the results shown in this test report refer only to the sample(s) tested and such sample(s) are retained for 90 days only.

除非另有說明，此報告結果僅對測試之樣品負責，同時此樣品僅保留90天。本報告未經本公司書面許可，不可部份複製。

This document is issued by the Company subject to its General Conditions of Service printed overleaf, available on request or accessible at www.sgs.com/terms_and_conditions.htm and, for electronic format documents, subject to Terms and Conditions for Electronic Documents at www.sgs.com/terms_e-document.htm. Attention is drawn to the limitation of liability, indemnification and jurisdiction issues defined therein. Any holder of this document is advised that information contained hereon reflects the Company's findings at the time of its intervention only and within the limits of Client's instructions, if any. The Company's sole responsibility is to its Client and this document does not exonerate parties to a transaction from exercising all their rights and obligations under the transaction documents. This document cannot be reproduced except in full, without prior written approval of the Company. Any unauthorized alteration, forgery or falsification of the content or appearance of this document is unlawful and offenders may be prosecuted to the fullest extent of the law.

WCDMA Band IV + 5GHz WLAN MIMO

| No. | Conditions | Position | Distance (mm) | Max. WWAN | Max. WLAN Main | Max. WLAN Aux | SAR Sum | SPLSR |
|-----|--------------|------------------------|---------------|-----------|----------------|---------------|--------------|--------------------------------|
| 18 | WCDMA Band 4 | Back side | 0 | 0.999 | 0.073 | 0.212 | 1.284 | Σ SAR<1.6, Not required |
| | | Back side_Curve(Left) | 0 | 1.131 | - | - | - | Σ SAR<1.6, Not required |
| | | Back side_Curve(Right) | 0 | - | 0.078 | - | - | Σ SAR<1.6, Not required |
| | | Top side | 0 | 1.049 | 0.089 | 0.928 | 2.066 | Analyzed as below |
| | | Bottom side | 0 | 0.0235 | 0.003 | 0.007 | 0.0335 | Σ SAR<1.6, Not required |
| | | Left side | 0 | 0.532 | 0.002 | 0.006 | 0.54 | Σ SAR<1.6, Not required |
| | | Right side | 0 | 0.0042 | 0.513 | 0.029 | 0.5462 | Σ SAR<1.6, Not required |

WWAN & WLAN Main

| Conditions | Position | SAR Value (W/kg) | Coordinates (cm) | | | Σ SAR (W/kg) | Peak Location Separation Distance (mm) | SPLSR | Simultaneous Transmission SAR Test |
|------------|----------|------------------|------------------|-------|-------|---------------------|--|-------|------------------------------------|
| | | | x | y | z | | | | |
| WCDMA B4 | Top side | 1.049 | -0.84 | -8.59 | -0.50 | 1.138 | 175.5 | 0.007 | SPLSR<0.04, Not required |
| WLAN Main | | 0.089 | -2.10 | 8.72 | 2.08 | | | | |

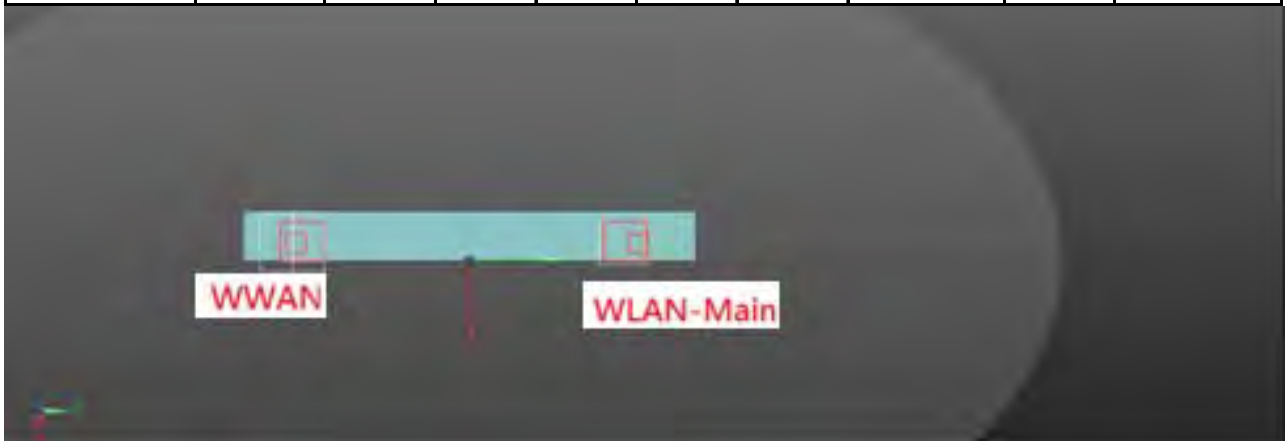

Unless otherwise stated the results shown in this test report refer only to the sample(s) tested and such sample(s) are retained for 90 days only.

除非另有說明，此報告結果僅對測試之樣品負責，同時此樣品僅保留90天。本報告未經本公司書面許可，不可部份複製。

This document is issued by the Company subject to its General Conditions of Service printed overleaf, available on request or accessible at www.sgs.com/terms_and_conditions.htm and, for electronic format documents, subject to Terms and Conditions for Electronic Documents at www.sgs.com/terms_e-document.htm. Attention is drawn to the limitation of liability, indemnification and jurisdiction issues defined therein. Any holder of this document is advised that information contained hereon reflects the Company's findings at the time of its intervention only and within the limits of Client's instructions, if any. The Company's sole responsibility is to its Client and this document does not exonerate parties to a transaction from exercising all their rights and obligations under the transaction documents. This document cannot be reproduced except in full, without prior written approval of the Company. Any unauthorized alteration, forgery or falsification of the content or appearance of this document is unlawful and offenders may be prosecuted to the fullest extent of the law.

WWAN & WLAN Aux

| Conditions | Position | SAR Value (W/kg) | Coordinates (cm) | | | Σ SAR (W/kg) | Peak Location Separation Distance (mm) | SPLSR | Simultaneous Transmission SAR Test |
|------------|----------|------------------|------------------|-------|-------|---------------------|--|-------|------------------------------------|
| | | | x | y | z | | | | |
| WCDMA B4 | Top side | 1.049 | -0.84 | -8.59 | -0.50 | 1.977 | 95.6 | 0.029 | SPLSR<0.04, Not required |
| WLAN Aux | | 0.928 | -1.08 | 0.96 | -0.76 | | | | |

WLAN Main & WLAN Aux

| Conditions | Position | SAR Value (W/kg) | Coordinates (cm) | | | Σ SAR (W/kg) | Peak Location Separation Distance (mm) | SPLSR | Simultaneous Transmission SAR Test |
|------------|----------|------------------|------------------|------|-------|---------------------|--|-------|------------------------------------|
| | | | x | y | z | | | | |
| WLAN Main | Top side | 0.089 | -2.10 | 8.72 | 2.08 | 1.017 | 83.2 | 0.012 | SPLSR<0.04, Not required |
| WLAN Aux | | 0.928 | -1.08 | 0.96 | -0.76 | | | | |

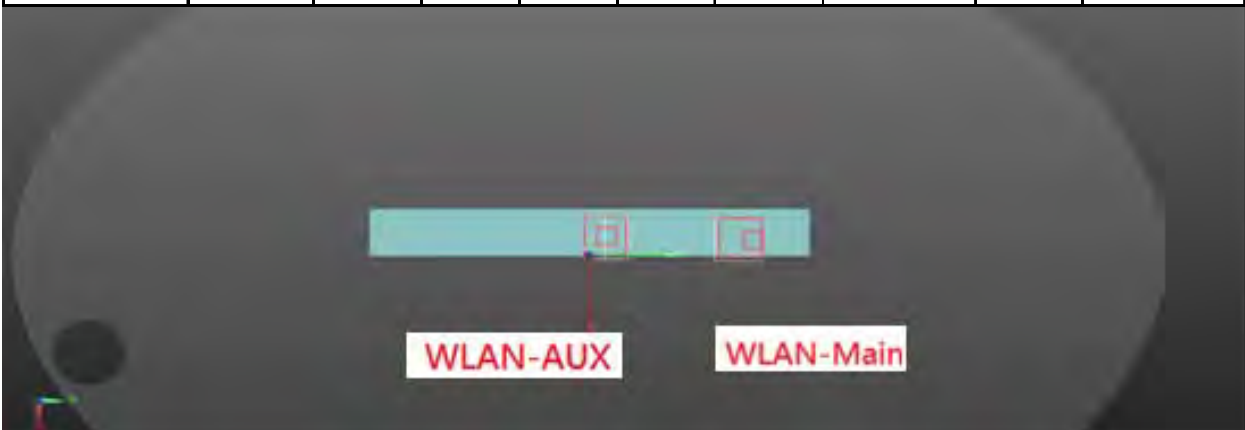

Unless otherwise stated the results shown in this test report refer only to the sample(s) tested and such sample(s) are retained for 90 days only.

除非另有說明，此報告結果僅對測試之樣品負責，同時此樣品僅保留90天。本報告未經本公司書面許可，不可部份複製。

This document is issued by the Company subject to its General Conditions of Service printed overleaf, available on request or accessible at www.sgs.com/terms_and_conditions.htm and, for electronic format documents, subject to Terms and Conditions for Electronic Documents at www.sgs.com/terms_e-document.htm. Attention is drawn to the limitation of liability, indemnification and jurisdiction issues defined therein. Any holder of this document is advised that information contained hereon reflects the Company's findings at the time of its intervention only and within the limits of Client's instructions, if any. The Company's sole responsibility is to its Client and this document does not exonerate parties to a transaction from exercising all their rights and obligations under the transaction documents. This document cannot be reproduced except in full, without prior written approval of the Company. Any unauthorized alteration, forgery or falsification of the content or appearance of this document is unlawful and offenders may be prosecuted to the fullest extent of the law.

WCDMA Band V + 5GHz WLAN MIMO

| No. | Conditions | Position | Distance (mm) | Max. WWAN | Max. WLAN Main | Max. WLAN Aux | SAR Sum | SPLSR |
|-----|--------------|------------------------|---------------|-----------|----------------|---------------|---------|--------------------------------|
| 19 | WCDMA Band 5 | Back side | 0 | 0.407 | 0.073 | 0.212 | 0.692 | Σ SAR<1.6, Not required |
| | | Back side_Curve(Left) | 0 | 0.402 | - | - | - | Σ SAR<1.6, Not required |
| | | Back side_Curve(Right) | 0 | - | 0.078 | - | - | Σ SAR<1.6, Not required |
| | | Top side | 0 | 0.391 | 0.089 | 0.928 | 1.408 | Σ SAR<1.6, Not required |
| | | Bottom side | 0 | 0.035 | 0.003 | 0.007 | 0.045 | Σ SAR<1.6, Not required |
| | | Left side | 0 | 0.615 | 0.002 | 0.006 | 0.623 | Σ SAR<1.6, Not required |
| | | Right side | 0 | 0.003 | 0.513 | 0.029 | 0.545 | Σ SAR<1.6, Not required |

Unless otherwise stated the results shown in this test report refer only to the sample(s) tested and such sample(s) are retained for 90 days only.

除非另有說明，此報告結果僅對測試之樣品負責，同時此樣品僅保留90天。本報告未經本公司書面許可，不可部份複製。

This document is issued by the Company subject to its General Conditions of Service printed overleaf, available on request or accessible at www.sgs.com/terms_and_conditions.htm and, for electronic format documents, subject to Terms and Conditions for Electronic Documents at www.sgs.com/terms_e-document.htm. Attention is drawn to the limitation of liability, indemnification and jurisdiction issues defined therein. Any holder of this document is advised that information contained hereon reflects the Company's findings at the time of its intervention only and within the limits of Client's instructions, if any. The Company's sole responsibility is to its Client and this document does not exonerate parties to a transaction from exercising all their rights and obligations under the transaction documents. This document cannot be reproduced except in full, without prior written approval of the Company. Any unauthorized alteration, forgery or falsification of the content or appearance of this document is unlawful and offenders may be prosecuted to the fullest extent of the law.

LTE FDD Band II + 5GHz WLAN MIMO

| No. | Conditions | Position | Distance (mm) | Max. WWAN | Max. WLAN Main | Max. WLAN Aux | SAR Sum | SPLSR |
|-----|------------|------------------------|---------------|-----------|----------------|---------------|--------------|--------------------------------|
| 20 | LTE Band 2 | Back side | 0 | 1.062 | 0.073 | 0.212 | 1.347 | Σ SAR<1.6, Not required |
| | | Back side_Curve(Left) | 0 | 1.086 | - | - | - | Σ SAR<1.6, Not required |
| | | Back side_Curve(Right) | 0 | - | 0.078 | - | - | Σ SAR<1.6, Not required |
| | | Top side | 0 | 1.09 | 0.089 | 0.928 | 2.107 | Analyzed as below |
| | | Bottom side | 0 | 0.041 | 0.003 | 0.007 | 0.051 | Σ SAR<1.6, Not required |
| | | Left side | 0 | 0.281 | 0.002 | 0.006 | 0.289 | Σ SAR<1.6, Not required |
| | | Right side | 0 | 0.027 | 0.513 | 0.029 | 0.569 | Σ SAR<1.6, Not required |

WWAN & WLAN Main

| Conditions | Position | SAR Value (W/kg) | Coordinates (cm) | | | Σ SAR (W/kg) | Peak Location Separation Distance (mm) | SPLSR | Simultaneous Transmission SAR Test |
|------------|----------|------------------|------------------|-------|------|---------------------|--|-------|------------------------------------|
| | | | x | y | z | | | | |
| LTE Band 2 | Top side | 1.09 | -1.30 | -8.16 | 0.45 | 1.179 | 169.8 | 0.008 | SPLSR<0.04, Not required |
| WLAN Main | | 0.089 | -2.10 | 8.72 | 2.08 | | | | |

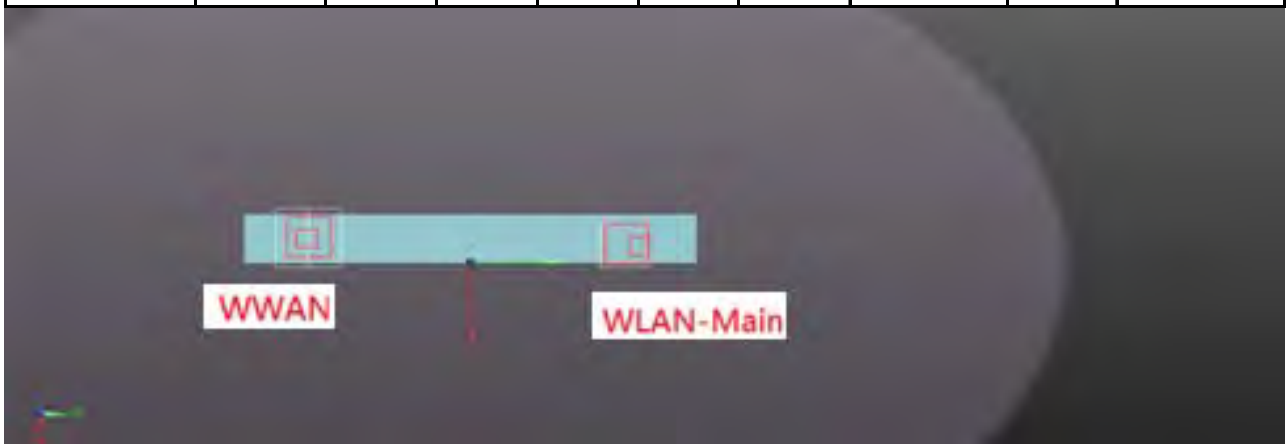

Unless otherwise stated the results shown in this test report refer only to the sample(s) tested and such sample(s) are retained for 90 days only.
除非另有說明，此報告結果僅對測試之樣品負責，同時此樣品僅保留90天。本報告未經本公司書面許可，不可部份複製。

This document is issued by the Company subject to its General Conditions of Service printed overleaf, available on request or accessible at www.sgs.com/terms_and_conditions.htm and, for electronic format documents, subject to Terms and Conditions for Electronic Documents at www.sgs.com/terms_e-document.htm. Attention is drawn to the limitation of liability, indemnification and jurisdiction issues defined therein. Any holder of this document is advised that information contained hereon reflects the Company's findings at the time of its intervention only and within the limits of Client's instructions, if any. The Company's sole responsibility is to its Client and this document does not exonerate parties to a transaction from exercising all their rights and obligations under the transaction documents. This document cannot be reproduced except in full, without prior written approval of the Company. Any unauthorized alteration, forgery or falsification of the content or appearance of this document is unlawful and offenders may be prosecuted to the fullest extent of the law.

WWAN & WLAN Aux

| Conditions | Position | SAR Value (W/kg) | Coordinates (cm) | | | ΣSAR (W/kg) | Peak Location Separation Distance (mm) | SPLSR | Simultaneous Transmission SAR Test |
|------------|----------|------------------|------------------|-------|-------|-------------|--|-------|------------------------------------|
| | | | x | y | z | | | | |
| LTE Band 2 | Top side | 1.09 | -1.30 | -8.16 | 0.45 | 2.018 | 92 | 0.031 | SPLSR<0.04, Not required |
| WLAN Aux | | 0.928 | -1.08 | 0.96 | -0.76 | | | | |

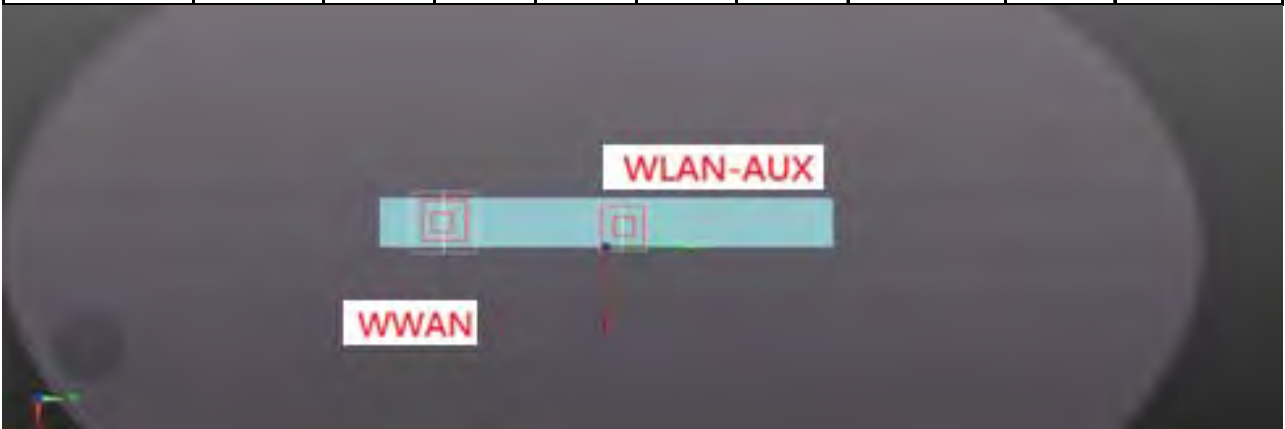

WLAN Main & WLAN Aux

| Conditions | Position | SAR Value (W/kg) | Coordinates (cm) | | | ΣSAR (W/kg) | Peak Location Separation Distance (mm) | SPLSR | Simultaneous Transmission SAR Test |
|------------|----------|------------------|------------------|------|-------|-------------|--|-------|------------------------------------|
| | | | x | y | z | | | | |
| WLAN Main | Top side | 0.089 | -2.10 | 8.72 | 2.08 | 1.017 | 83.2 | 0.012 | SPLSR<0.04, Not required |
| WLAN Aux | | 0.928 | -1.08 | 0.96 | -0.76 | | | | |

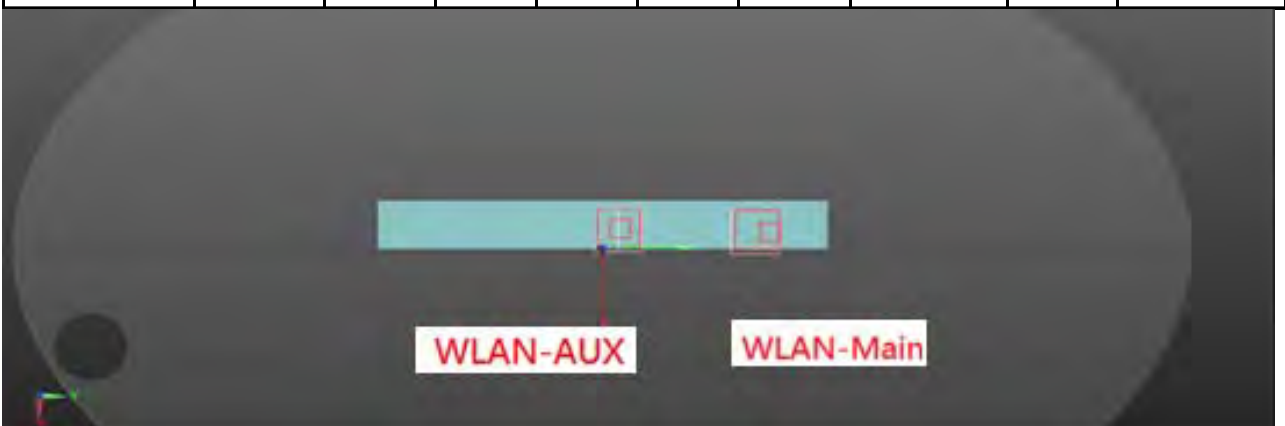

Unless otherwise stated the results shown in this test report refer only to the sample(s) tested and such sample(s) are retained for 90 days only.

除非另有說明，此報告結果僅對測試之樣品負責，同時此樣品僅保留90天。本報告未經本公司書面許可，不可部份複製。

This document is issued by the Company subject to its General Conditions of Service printed overleaf, available on request or accessible at www.sgs.com/terms_and_conditions.htm and, for electronic format documents, subject to Terms and Conditions for Electronic Documents at www.sgs.com/terms_e-document.htm. Attention is drawn to the limitation of liability, indemnification and jurisdiction issues defined therein. Any holder of this document is advised that information contained hereon reflects the Company's findings at the time of its intervention only and within the limits of Client's instructions, if any. The Company's sole responsibility is to its Client and this document does not exonerate parties to a transaction from exercising all their rights and obligations under the transaction documents. This document cannot be reproduced except in full, without prior written approval of the Company. Any unauthorized alteration, forgery or falsification of the content or appearance of this document is unlawful and offenders may be prosecuted to the fullest extent of the law.

LTE FDD Band IV + 5GHz WLAN MIMO

| No. | Conditions | Position | Distance (mm) | Max. WWAN | Max. WLAN Main | Max. WLAN Aux | SAR Sum | SPLSR |
|-----|------------|------------------------|---------------|-----------|----------------|---------------|--------------|--------------------------------|
| 21 | LTE Band 4 | Back side | 0 | 1.193 | 0.073 | 0.212 | 1.478 | Σ SAR<1.6, Not required |
| | | Back side_Curve(Left) | 0 | 1.154 | - | - | - | Σ SAR<1.6, Not required |
| | | Back side_Curve(Right) | 0 | - | 0.078 | - | - | Σ SAR<1.6, Not required |
| | | Top side | 0 | 1.069 | 0.089 | 0.928 | 2.086 | Analyzed as below |
| | | Bottom side | 0 | 0.044 | 0.003 | 0.007 | 0.054 | Σ SAR<1.6, Not required |
| | | Left side | 0 | 0.543 | 0.002 | 0.006 | 0.551 | Σ SAR<1.6, Not required |
| | | Right side | 0 | 0.007 | 0.513 | 0.029 | 0.549 | Σ SAR<1.6, Not required |

WWAN & WLAN Main

| Conditions | Position | SAR Value (W/kg) | Coordinates (cm) | | | Σ SAR (W/kg) | Peak Location Separation Distance (mm) | SPLSR | Simultaneous Transmission SAR Test |
|------------|----------|------------------|------------------|-------|-------|---------------------|--|-------|------------------------------------|
| | | | x | y | z | | | | |
| LTE Band 4 | Top side | 1.069 | -1.35 | -8.34 | -0.48 | 1.158 | 172.7 | 0.007 | SPLSR<0.04, Not required |
| WLAN Main | | 0.089 | -2.10 | 8.72 | 2.08 | | | | |

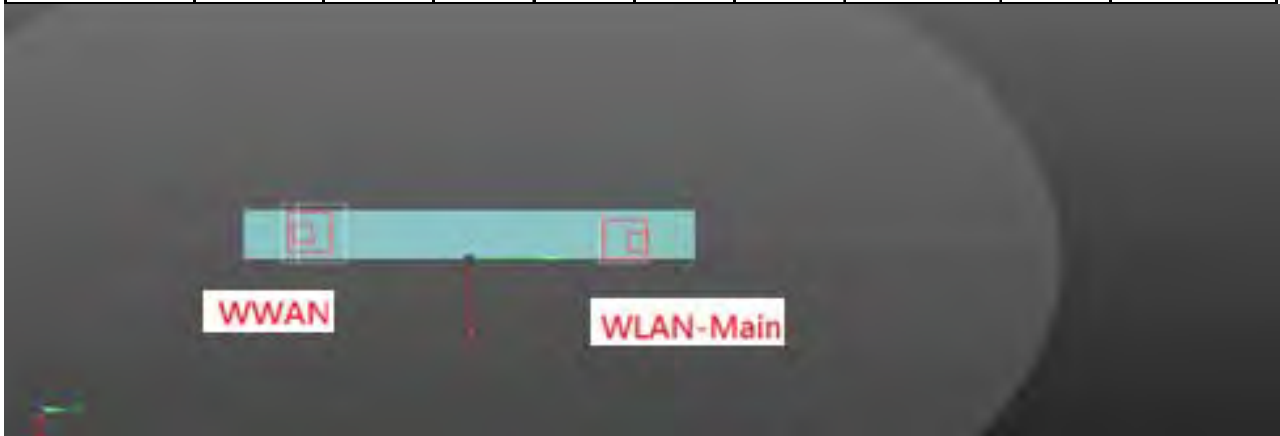

Unless otherwise stated the results shown in this test report refer only to the sample(s) tested and such sample(s) are retained for 90 days only.

除非另有說明，此報告結果僅對測試之樣品負責，同時此樣品僅保留90天。本報告未經本公司書面許可，不可部份複製。

This document is issued by the Company subject to its General Conditions of Service printed overleaf, available on request or accessible at www.sgs.com/terms_and_conditions.htm and, for electronic format documents, subject to Terms and Conditions for Electronic Documents at www.sgs.com/terms_e-document.htm. Attention is drawn to the limitation of liability, indemnification and jurisdiction issues defined therein. Any holder of this document is advised that information contained hereon reflects the Company's findings at the time of its intervention only and within the limits of Client's instructions, if any. The Company's sole responsibility is to its Client and this document does not exonerate parties to a transaction from exercising all their rights and obligations under the transaction documents. This document cannot be reproduced except in full, without prior written approval of the Company. Any unauthorized alteration, forgery or falsification of the content or appearance of this document is unlawful and offenders may be prosecuted to the fullest extent of the law.

WWAN & WLAN Aux

| Conditions | Position | SAR Value (W/kg) | Coordinates (cm) | | | ΣSAR (W/kg) | Peak Location Separation Distance (mm) | SPLSR | Simultaneous Transmission SAR Test |
|------------|----------|------------------|------------------|-------|-------|-------------|--|-------|------------------------------------|
| | | | x | y | z | | | | |
| LTE Band 4 | Top side | 1.069 | -1.35 | -8.34 | -0.48 | 1.997 | 93.1 | 0.030 | SPLSR<0.04, Not required |
| WLAN Aux | | 0.928 | -1.08 | 0.96 | -0.76 | | | | |

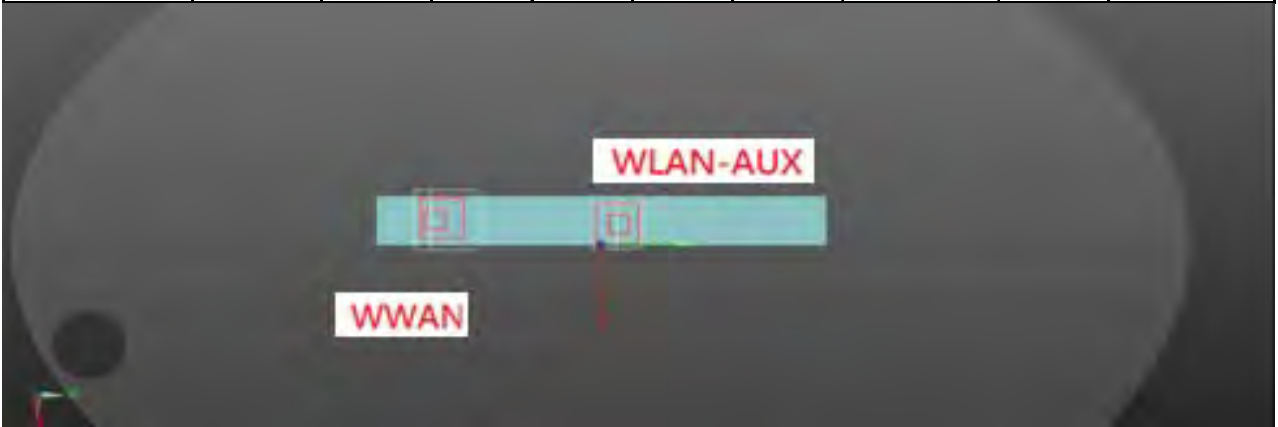
WLAN Main & WLAN Aux

| Conditions | Position | SAR Value (W/kg) | Coordinates (cm) | | | ΣSAR (W/kg) | Peak Location Separation Distance (mm) | SPLSR | Simultaneous Transmission SAR Test |
|------------|----------|------------------|------------------|------|-------|-------------|--|-------|------------------------------------|
| | | | x | y | z | | | | |
| WLAN Main | Top side | 0.089 | -2.10 | 8.72 | 2.08 | 1.017 | 83.2 | 0.012 | SPLSR<0.04, Not required |
| WLAN Aux | | 0.928 | -1.08 | 0.96 | -0.76 | | | | |

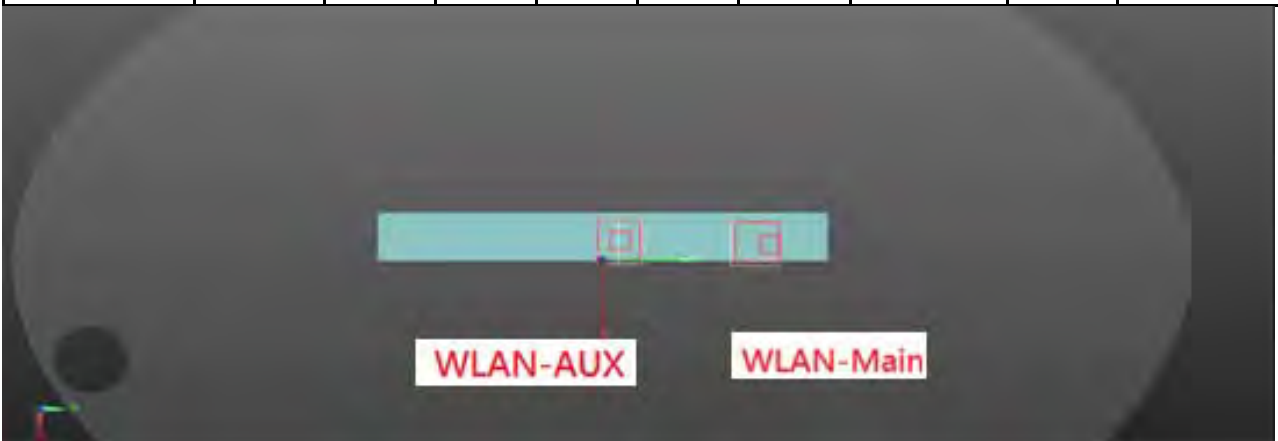

Unless otherwise stated the results shown in this test report refer only to the sample(s) tested and such sample(s) are retained for 90 days only.

除非另有說明，此報告結果僅對測試之樣品負責，同時此樣品僅保留90天。本報告未經本公司書面許可，不可部份複製。

This document is issued by the Company subject to its General Conditions of Service printed overleaf, available on request or accessible at www.sgs.com/terms_and_conditions.htm and, for electronic format documents, subject to Terms and Conditions for Electronic Documents at www.sgs.com/terms_e-document.htm. Attention is drawn to the limitation of liability, indemnification and jurisdiction issues defined therein. Any holder of this document is advised that information contained hereon reflects the Company's findings at the time of its intervention only and within the limits of Client's instructions, if any. The Company's sole responsibility is to its Client and this document does not exonerate parties to a transaction from exercising all their rights and obligations under the transaction documents. This document cannot be reproduced except in full, without prior written approval of the Company. Any unauthorized alteration, forgery or falsification of the content or appearance of this document is unlawful and offenders may be prosecuted to the fullest extent of the law.

LTE FDD Band V + 5GHz WLAN MIMO

| No. | Conditions | Position | Distance (mm) | Max. WWAN | Max. WLAN Main | Max. WLAN Aux | SAR Sum | SPLSR |
|-----|------------|------------------------|---------------|-----------|----------------|---------------|---------|--------------------------------|
| 22 | LTE Band 5 | Back side | 0 | 0.491 | 0.073 | 0.212 | 0.776 | Σ SAR<1.6, Not required |
| | | Back side_Curve(Left) | 0 | 0.58 | - | - | - | Σ SAR<1.6, Not required |
| | | Back side_Curve(Right) | 0 | - | 0.078 | - | - | Σ SAR<1.6, Not required |
| | | Top side | 0 | 0.576 | 0.089 | 0.928 | 1.593 | Σ SAR<1.6, Not required |
| | | Bottom side | 0 | 0.076 | 0.003 | 0.007 | 0.086 | Σ SAR<1.6, Not required |
| | | Left side | 0 | 0.601 | 0.002 | 0.006 | 0.609 | Σ SAR<1.6, Not required |
| | | Right side | 0 | 0.014 | 0.513 | 0.029 | 0.556 | Σ SAR<1.6, Not required |

LTE FDD Band XIII + 5GHz WLAN MIMO

| No. | Conditions | Position | Distance (mm) | Max. WWAN | Max. WLAN Main | Max. WLAN Aux | SAR Sum | SPLSR |
|-----|-------------|------------------------|---------------|-----------|----------------|---------------|---------|--------------------------------|
| 23 | LTE Band 13 | Back side | 0 | 0.468 | 0.073 | 0.212 | 0.753 | Σ SAR<1.6, Not required |
| | | Back side_Curve(Left) | 0 | 0.486 | - | - | - | Σ SAR<1.6, Not required |
| | | Back side_Curve(Right) | 0 | - | 0.078 | - | - | Σ SAR<1.6, Not required |
| | | Top side | 0 | 0.549 | 0.089 | 0.928 | 1.566 | Σ SAR<1.6, Not required |
| | | Bottom side | 0 | 0.093 | 0.003 | 0.007 | 0.103 | Σ SAR<1.6, Not required |
| | | Left side | 0 | 0.837 | 0.002 | 0.006 | 0.845 | Σ SAR<1.6, Not required |
| | | Right side | 0 | 0.01 | 0.513 | 0.029 | 0.552 | Σ SAR<1.6, Not required |

Unless otherwise stated the results shown in this test report refer only to the sample(s) tested and such sample(s) are retained for 90 days only.

除非另有說明，此報告結果僅對測試之樣品負責，同時此樣品僅保留90天。本報告未經本公司書面許可，不可部份複製。

This document is issued by the Company subject to its General Conditions of Service printed overleaf, available on request or accessible at www.sgs.com/terms_and_conditions.htm and, for electronic format documents, subject to Terms and Conditions for Electronic Documents at www.sgs.com/terms_e-document.htm. Attention is drawn to the limitation of liability, indemnification and jurisdiction issues defined therein. Any holder of this document is advised that information contained hereon reflects the Company's findings at the time of its intervention only and within the limits of Client's instructions, if any. The Company's sole responsibility is to its Client and this document does not exonerate parties to a transaction from exercising all their rights and obligations under the transaction documents. This document cannot be reproduced except in full, without prior written approval of the Company. Any unauthorized alteration, forgery or falsification of the content or appearance of this document is unlawful and offenders may be prosecuted to the fullest extent of the law.

LTE FDD Band XVII + 5GHz WLAN MIMO

| No. | Conditions | Position | Distance (mm) | Max. WWAN | Max. WLAN Main | Max. WLAN Aux | SAR Sum | SPLSR |
|-----|-------------|------------------------|---------------|-----------|----------------|---------------|---------|--------------------------------|
| 24 | LTE Band 17 | Back side | 0 | 0.264 | 0.073 | 0.212 | 0.549 | Σ SAR<1.6, Not required |
| | | Back side_Curve(Left) | 0 | 0.296 | - | - | - | Σ SAR<1.6, Not required |
| | | Back side_Curve(Right) | 0 | - | 0.078 | - | - | Σ SAR<1.6, Not required |
| | | Top side | 0 | 0.223 | 0.089 | 0.928 | 1.24 | Σ SAR<1.6, Not required |
| | | Bottom side | 0 | 0.009 | 0.003 | 0.007 | 0.019 | Σ SAR<1.6, Not required |
| | | Left side | 0 | 0.438 | 0.002 | 0.006 | 0.446 | Σ SAR<1.6, Not required |
| | | Right side | 0 | 0.005 | 0.513 | 0.029 | 0.547 | Σ SAR<1.6, Not required |

Unless otherwise stated the results shown in this test report refer only to the sample(s) tested and such sample(s) are retained for 90 days only.

除非另有說明，此報告結果僅對測試之樣品負責，同時此樣品僅保留90天。本報告未經本公司書面許可，不可部份複製。

This document is issued by the Company subject to its General Conditions of Service printed overleaf, available on request or accessible at www.sgs.com/terms_and_conditions.htm and, for electronic format documents, subject to Terms and Conditions for Electronic Documents at www.sgs.com/terms_e-document.htm. Attention is drawn to the limitation of liability, indemnification and jurisdiction issues defined therein. Any holder of this document is advised that information contained hereon reflects the Company's findings at the time of its intervention only and within the limits of Client's instructions, if any. The Company's sole responsibility is to its Client and this document does not exonerate parties to a transaction from exercising all their rights and obligations under the transaction documents. This document cannot be reproduced except in full, without prior written approval of the Company. Any unauthorized alteration, forgery or falsification of the content or appearance of this document is unlawful and offenders may be prosecuted to the fullest extent of the law.

LTE FDD Band XXV + 5GHz WLAN MIMO

| No. | Conditions | Position | Distance (mm) | Max. WWAN | Max. WLAN Main | Max. WLAN Aux | SAR Sum | SPLSR |
|-----|-------------|------------------------|---------------|-----------|----------------|---------------|--------------|--------------------------------|
| 25 | LTE Band 25 | Back side | 0 | 1.151 | 0.073 | 0.212 | 1.436 | Σ SAR<1.6, Not required |
| | | Back side_Curve(LLeft) | 0 | 0.979 | - | - | - | Σ SAR<1.6, Not required |
| | | Back side_Curve(Right) | 0 | - | 0.078 | - | - | Σ SAR<1.6, Not required |
| | | Top side | 0 | 1.136 | 0.089 | 0.928 | 2.153 | Analyzed as below |
| | | Bottom side | 0 | 0.026 | 0.003 | 0.007 | 0.036 | Σ SAR<1.6, Not required |
| | | Left side | 0 | 0.375 | 0.002 | 0.006 | 0.383 | Σ SAR<1.6, Not required |
| | | Right side | 0 | 0.007 | 0.513 | 0.029 | 0.549 | Σ SAR<1.6, Not required |

WWAN & WLAN Main

| Conditions | Position | SAR Value (W/kg) | Coordinates (cm) | | | Σ SAR (W/kg) | Peak Location Separation Distance (mm) | SPLSR | Simultaneous Transmission SAR Test |
|-------------|----------|------------------|------------------|-------|------|---------------------|--|-------|------------------------------------|
| | | | x | y | z | | | | |
| LTE Band 25 | Top side | 1.159 | -1.14 | -8.47 | 0.51 | 1.248 | 172.9 | 0.008 | SPLSR<0.04, Not required |
| WLAN Main | | 0.089 | -2.10 | 8.72 | 2.08 | | | | |

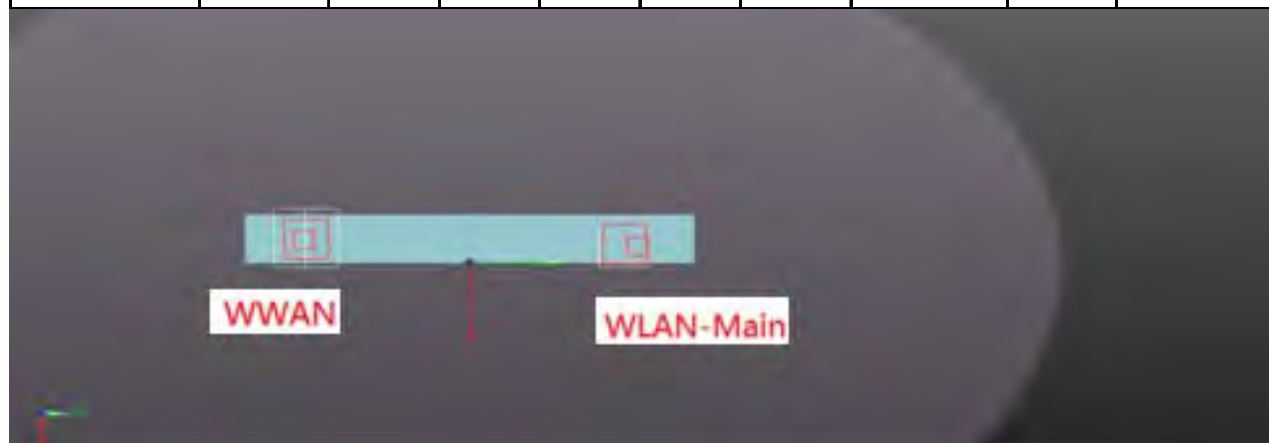

Unless otherwise stated the results shown in this test report refer only to the sample(s) tested and such sample(s) are retained for 90 days only.

除非另有說明，此報告結果僅對測試之樣品負責，同時此樣品僅保留90天。本報告未經本公司書面許可，不可部份複製。

This document is issued by the Company subject to its General Conditions of Service printed overleaf, available on request or accessible at www.sgs.com/terms_and_conditions.htm and, for electronic format documents, subject to Terms and Conditions for Electronic Documents at www.sgs.com/terms_e-document.htm. Attention is drawn to the limitation of liability, indemnification and jurisdiction issues defined therein. Any holder of this document is advised that information contained hereon reflects the Company's findings at the time of its intervention only and within the limits of Client's instructions, if any. The Company's sole responsibility is to its Client and this document does not exonerate parties to a transaction from exercising all their rights and obligations under the transaction documents. This document cannot be reproduced except in full, without prior written approval of the Company. Any unauthorized alteration, forgery or falsification of the content or appearance of this document is unlawful and offenders may be prosecuted to the fullest extent of the law.

WWAN & WLAN Aux

| Conditions | Position | SAR Value (W/kg) | Coordinates (cm) | | | ΣSAR (W/kg) | Peak Location Separation Distance (mm) | SPLSR | Simultaneous Transmission SAR Test |
|-------------|----------|------------------|------------------|-------|-------|-------------|--|-------|------------------------------------|
| | | | x | y | z | | | | |
| LTE Band 25 | Top side | 1.159 | -1.14 | -8.47 | 0.51 | 2.087 | 95.1 | 0.032 | SPLSR<0.04, Not required |
| WLAN Aux | | 0.928 | -1.08 | 0.96 | -0.76 | | | | |

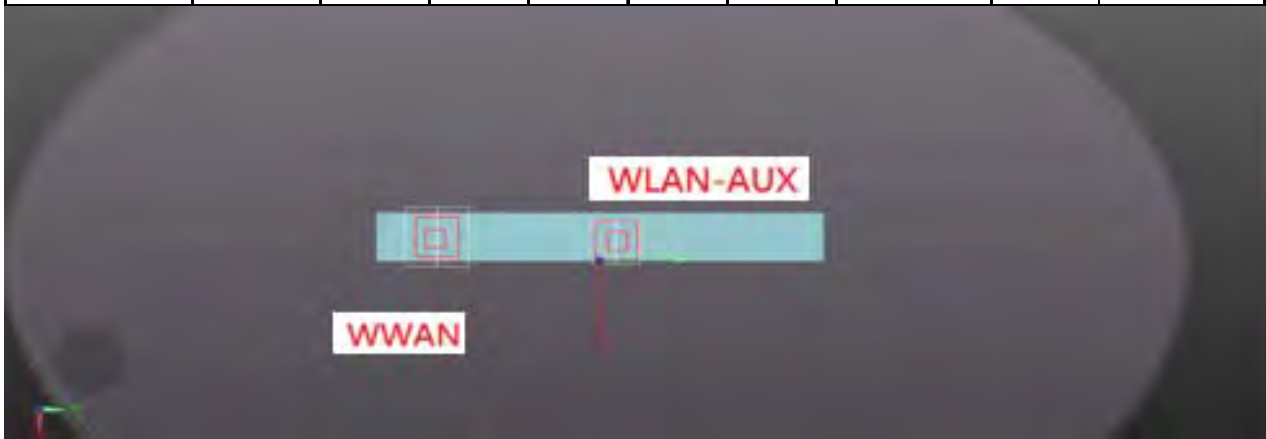

WLAN Main & WLAN Aux

| Conditions | Position | SAR Value (W/kg) | Coordinates (cm) | | | ΣSAR (W/kg) | Peak Location Separation Distance (mm) | SPLSR | Simultaneous Transmission SAR Test |
|------------|----------|------------------|------------------|------|-------|-------------|--|-------|------------------------------------|
| | | | x | y | z | | | | |
| WLAN Main | Top side | 0.089 | -2.10 | 8.72 | 2.08 | 1.017 | 83.2 | 0.012 | SPLSR<0.04, Not required |
| WLAN Aux | | 0.928 | -1.08 | 0.96 | -0.76 | | | | |

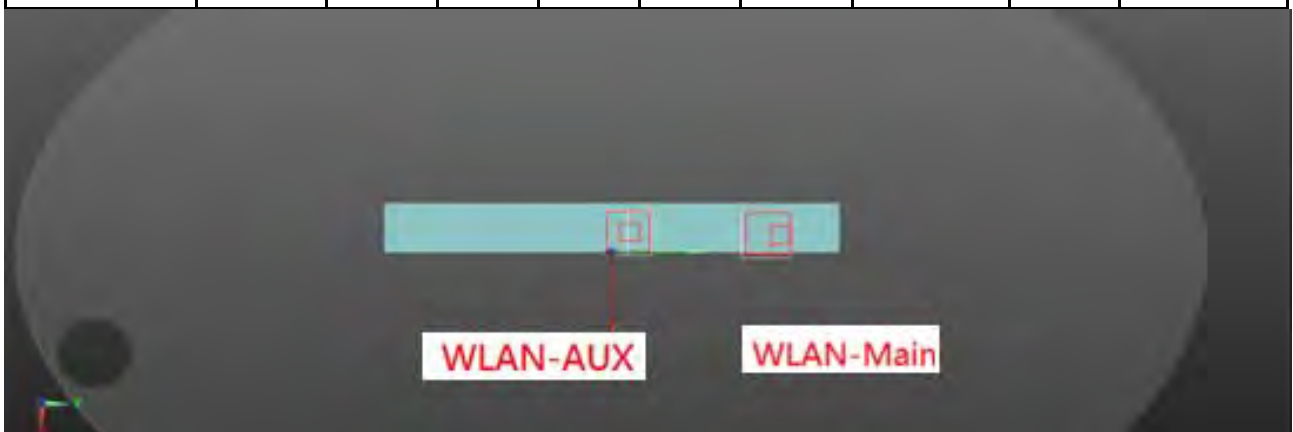

Unless otherwise stated the results shown in this test report refer only to the sample(s) tested and such sample(s) are retained for 90 days only.

除非另有說明，此報告結果僅對測試之樣品負責，同時此樣品僅保留90天。本報告未經本公司書面許可，不可部份複製。

This document is issued by the Company subject to its General Conditions of Service printed overleaf, available on request or accessible at www.sgs.com/terms_and_conditions.htm and, for electronic format documents, subject to Terms and Conditions for Electronic Documents at www.sgs.com/terms_e-document.htm. Attention is drawn to the limitation of liability, indemnification and jurisdiction issues defined therein. Any holder of this document is advised that information contained hereon reflects the Company's findings at the time of its intervention only and within the limits of Client's instructions, if any. The Company's sole responsibility is to its Client and this document does not exonerate parties to a transaction from exercising all their rights and obligations under the transaction documents. This document cannot be reproduced except in full, without prior written approval of the Company. Any unauthorized alteration, forgery or falsification of the content or appearance of this document is unlawful and offenders may be prosecuted to the fullest extent of the law.

CDMA / EVDO BC0 + 5GHz WLAN MIMO

| No. | Conditions | Position | Distance (mm) | Max. WWAN | Max. WLAN Main | Max. WLAN Aux | SAR Sum | SPLSR |
|-----|------------|------------------------|---------------|-----------|----------------|---------------|--------------|------------------------|
| 26 | EVDO BC 0 | Back side | 0 | 0.54 | 0.073 | 0.212 | 0.825 | ΣSAR<1.6, Not required |
| | | Back side_Curve(Left) | 0 | 0.618 | - | - | - | ΣSAR<1.6, Not required |
| | | Back side_Curve(Right) | 0 | - | 0.078 | - | - | ΣSAR<1.6, Not required |
| | | Top side | 0 | 0.658 | 0.089 | 0.928 | 1.675 | Analyzed as below |
| | | Bottom side | 0 | 0.07 | 0.003 | 0.007 | 0.08 | ΣSAR<1.6, Not required |
| | | Left side | 0 | 0.771 | 0.002 | 0.006 | 0.779 | ΣSAR<1.6, Not required |
| | | Right side | 0 | 0.007 | 0.513 | 0.029 | 0.549 | ΣSAR<1.6, Not required |

WWAN & WLAN Main

| Conditions | Position | SAR Value (W/kg) | Coordinates (cm) | | | ΣSAR (W/kg) | Peak Location Separation Distance (mm) | SPLSR | Simultaneous Transmission SAR Test |
|------------|----------|------------------|------------------|-------|-------|-------------|--|-------|------------------------------------|
| | | | x | y | z | | | | |
| EVDO BC 0 | Top side | 0.658 | -1.15 | -5.29 | -0.68 | 0.747 | 143.1 | 0.005 | SPLSR<0.04, Not required |
| WLAN Main | | 0.089 | -2.10 | 8.72 | 2.08 | | | | |

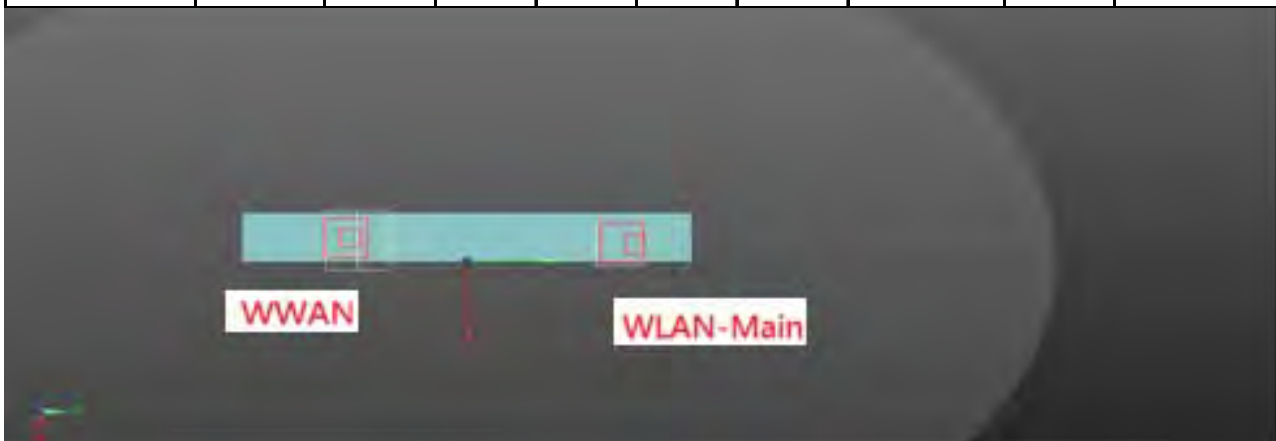

Unless otherwise stated the results shown in this test report refer only to the sample(s) tested and such sample(s) are retained for 90 days only.

除非另有說明，此報告結果僅對測試之樣品負責，同時此樣品僅保留90天。本報告未經本公司書面許可，不可部份複製。

This document is issued by the Company subject to its General Conditions of Service printed overleaf, available on request or accessible at www.sgs.com/terms_and_conditions.htm and, for electronic format documents, subject to Terms and Conditions for Electronic Documents at www.sgs.com/terms_e-document.htm. Attention is drawn to the limitation of liability, indemnification and jurisdiction issues defined therein. Any holder of this document is advised that information contained hereon reflects the Company's findings at the time of its intervention only and within the limits of Client's instructions, if any. The Company's sole responsibility is to its Client and this document does not exonerate parties to a transaction from exercising all their rights and obligations under the transaction documents. This document cannot be reproduced except in full, without prior written approval of the Company. Any unauthorized alteration, forgery or falsification of the content or appearance of this document is unlawful and offenders may be prosecuted to the fullest extent of the law.

WWAN & WLAN Aux

| Conditions | Position | SAR Value (W/kg) | Coordinates (cm) | | | ΣSAR (W/kg) | Peak Location Separation Distance (mm) | SPLSR | Simultaneous Transmission SAR Test |
|------------|----------|------------------|------------------|-------|-------|-------------|--|-------|------------------------------------|
| | | | x | y | z | | | | |
| EVDO BC 0 | Top side | 0.658 | -1.15 | -5.29 | -0.68 | 1.586 | 62.5 | 0.032 | SPLSR<0.04, Not required |
| WLAN Aux | | 0.928 | -1.08 | 0.96 | -0.76 | | | | |

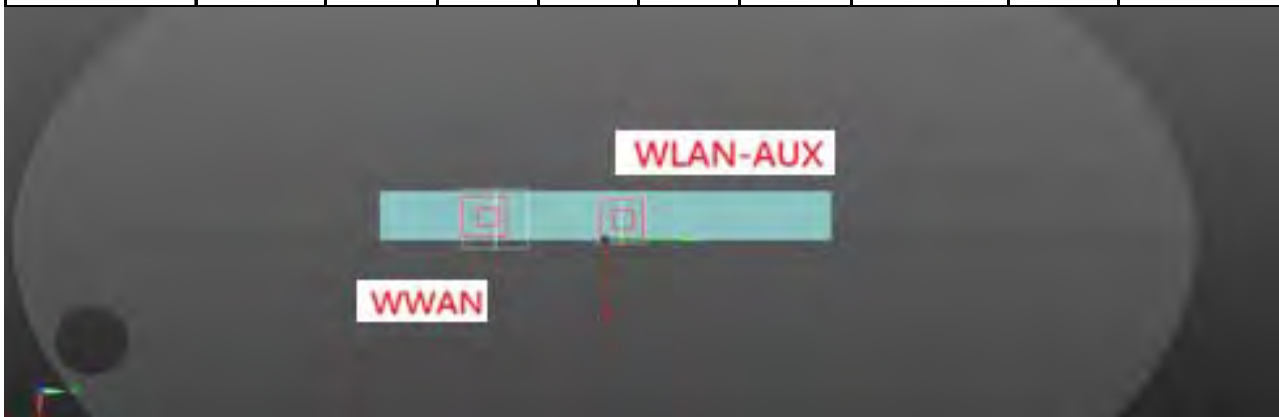

WLAN Main & WLAN Aux

| Conditions | Position | SAR Value (W/kg) | Coordinates (cm) | | | ΣSAR (W/kg) | Peak Location Separation Distance (mm) | SPLSR | Simultaneous Transmission SAR Test |
|------------|----------|------------------|------------------|------|-------|-------------|--|-------|------------------------------------|
| | | | x | y | z | | | | |
| WLAN Main | Top side | 0.089 | -2.10 | 8.72 | 2.08 | 1.017 | 83.2 | 0.012 | SPLSR<0.04, Not required |
| WLAN Aux | | 0.928 | -1.08 | 0.96 | -0.76 | | | | |

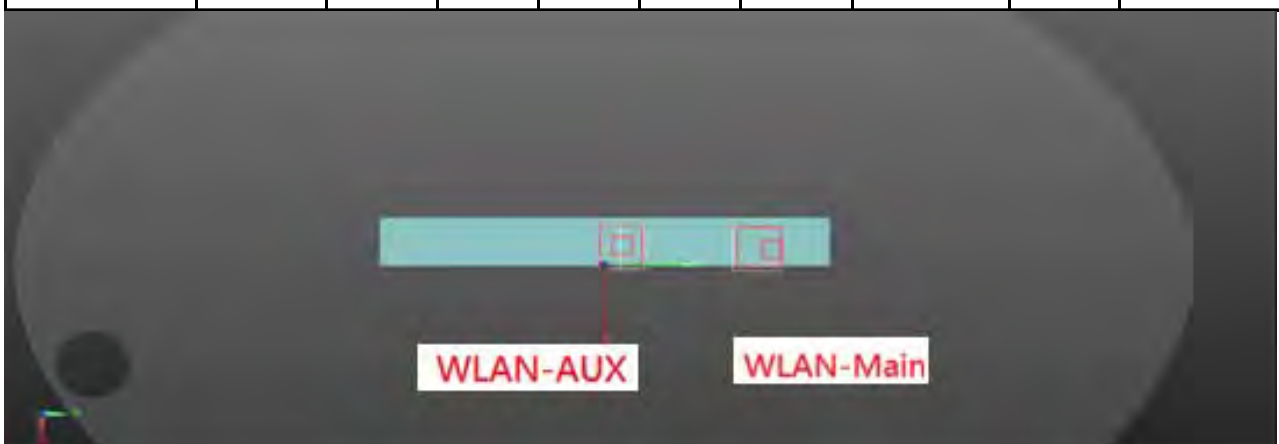

Unless otherwise stated the results shown in this test report refer only to the sample(s) tested and such sample(s) are retained for 90 days only.

除非另有說明，此報告結果僅對測試之樣品負責，同時此樣品僅保留90天。本報告未經本公司書面許可，不可部份複製。

This document is issued by the Company subject to its General Conditions of Service printed overleaf, available on request or accessible at www.sgs.com/terms_and_conditions.htm and, for electronic format documents, subject to Terms and Conditions for Electronic Documents at www.sgs.com/terms_e-document.htm. Attention is drawn to the limitation of liability, indemnification and jurisdiction issues defined therein. Any holder of this document is advised that information contained hereon reflects the Company's findings at the time of its intervention only and within the limits of Client's instructions, if any. The Company's sole responsibility is to its Client and this document does not exonerate parties to a transaction from exercising all their rights and obligations under the transaction documents. This document cannot be reproduced except in full, without prior written approval of the Company. Any unauthorized alteration, forgery or falsification of the content or appearance of this document is unlawful and offenders may be prosecuted to the fullest extent of the law.

CDMA / EVDO BC1 + 5GHz WLAN MIMO

| No. | Conditions | Position | Distance (mm) | Max. WWAN | Max. WLAN Main | Max. WLAN Aux | SAR Sum | SPLSR |
|-----|------------|------------------------|---------------|-----------|----------------|---------------|-------------|------------------------|
| 27 | EVDO BC 1 | Back side | 0 | 1.008 | 0.073 | 0.212 | 1.293 | ΣSAR<1.6, Not required |
| | | Back side_Curve(Left) | 0 | 0.973 | - | - | - | ΣSAR<1.6, Not required |
| | | Back side_Curve(Right) | 0 | - | 0.078 | - | - | ΣSAR<1.6, Not required |
| | | Top side | 0 | 0.903 | 0.089 | 0.928 | 1.92 | Analyzed as below |
| | | Bottom side | 0 | 0.025 | 0.003 | 0.007 | 0.035 | ΣSAR<1.6, Not required |
| | | Left side | 0 | 0.341 | 0.002 | 0.006 | 0.349 | ΣSAR<1.6, Not required |
| | | Right side | 0 | 0.004 | 0.513 | 0.029 | 0.546 | ΣSAR<1.6, Not required |

WWAN & WLAN Main

| Conditions | Position | SAR Value (W/kg) | Coordinates (cm) | | | ΣSAR (W/kg) | Peak Location Separation Distance (mm) | SPLSR | Simultaneous Transmission SAR Test |
|------------|----------|------------------|------------------|-------|-------|-------------|--|-------|------------------------------------|
| | | | x | y | z | | | | |
| EVDO BC 1 | Top side | 0.903 | -0.99 | -8.56 | -0.46 | 0.992 | 175 | 0.006 | SPLSR<0.04, Not required |
| WLAN Main | | 0.089 | -2.10 | 8.72 | 2.08 | | | | |

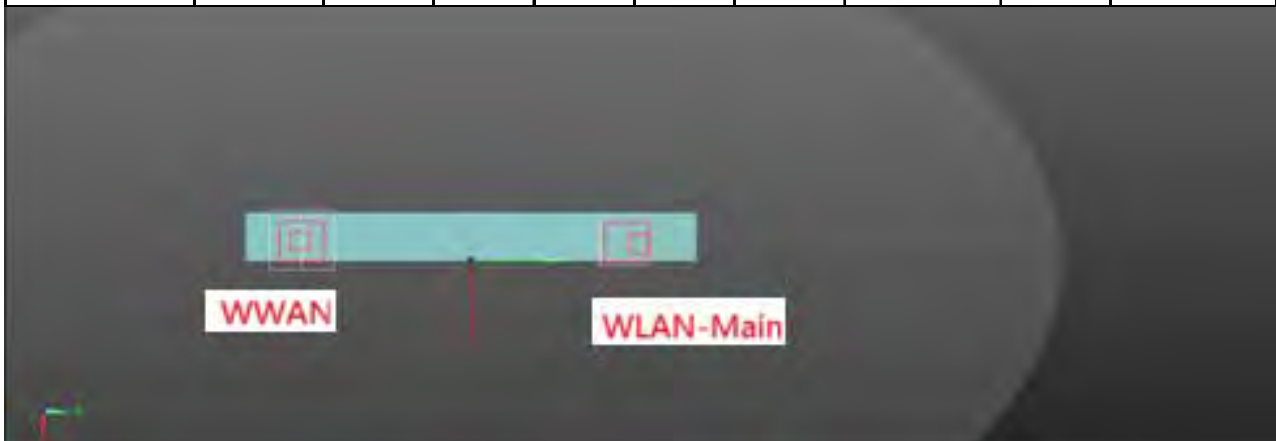

Unless otherwise stated the results shown in this test report refer only to the sample(s) tested and such sample(s) are retained for 90 days only.

除非另有說明，此報告結果僅對測試之樣品負責，同時此樣品僅保留90天。本報告未經本公司書面許可，不可部份複製。

This document is issued by the Company subject to its General Conditions of Service printed overleaf, available on request or accessible at www.sgs.com/terms_and_conditions.htm and, for electronic format documents, subject to Terms and Conditions for Electronic Documents at www.sgs.com/terms_e-document.htm. Attention is drawn to the limitation of liability, indemnification and jurisdiction issues defined therein. Any holder of this document is advised that information contained hereon reflects the Company's findings at the time of its intervention only and within the limits of Client's instructions, if any. The Company's sole responsibility is to its Client and this document does not exonerate parties to a transaction from exercising all their rights and obligations under the transaction documents. This document cannot be reproduced except in full, without prior written approval of the Company. Any unauthorized alteration, forgery or falsification of the content or appearance of this document is unlawful and offenders may be prosecuted to the fullest extent of the law.

WWAN & WLAN Aux

| Conditions | Position | SAR Value (W/kg) | Coordinates (cm) | | | ΣSAR (W/kg) | Peak Location Separation Distance (mm) | SPLSR | Simultaneous Transmission SAR Test |
|------------|----------|------------------|------------------|-------|-------|-------------|--|-------|------------------------------------|
| | | | x | y | z | | | | |
| EVDO BC 1 | Top side | 0.903 | -0.99 | -8.56 | -0.46 | 1.831 | 95.2 | 0.026 | SPLSR<0.04, Not required |
| WLAN Aux | | 0.928 | -1.08 | 0.96 | -0.76 | | | | |

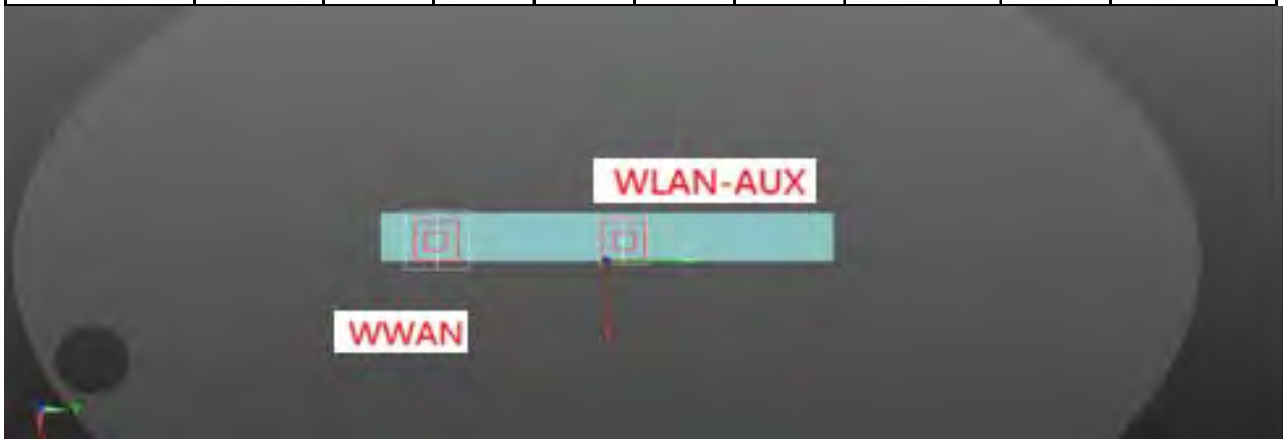
WLAN Main & WLAN Aux

| Conditions | Position | SAR Value (W/kg) | Coordinates (cm) | | | ΣSAR (W/kg) | Peak Location Separation Distance (mm) | SPLSR | Simultaneous Transmission SAR Test |
|------------|----------|------------------|------------------|------|-------|-------------|--|-------|------------------------------------|
| | | | x | y | z | | | | |
| WLAN Main | Top side | 0.089 | -2.10 | 8.72 | 2.08 | 1.017 | 83.2 | 0.012 | SPLSR<0.04, Not required |
| WLAN Aux | | 0.928 | -1.08 | 0.96 | -0.76 | | | | |

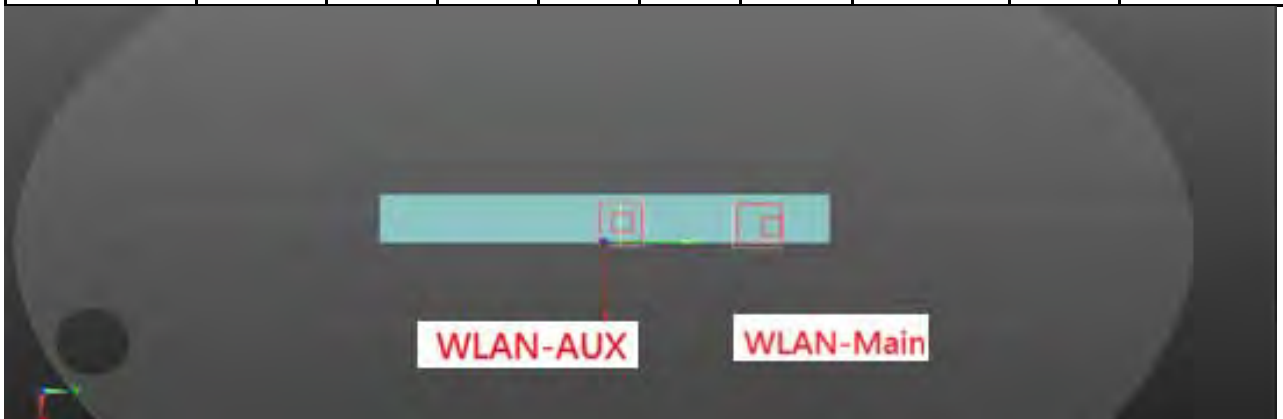

Unless otherwise stated the results shown in this test report refer only to the sample(s) tested and such sample(s) are retained for 90 days only.

除非另有說明，此報告結果僅對測試之樣品負責，同時此樣品僅保留90天。本報告未經本公司書面許可，不可部份複製。

This document is issued by the Company subject to its General Conditions of Service printed overleaf, available on request or accessible at www.sgs.com/terms_and_conditions.htm and, for electronic format documents, subject to Terms and Conditions for Electronic Documents at www.sgs.com/terms_e-document.htm. Attention is drawn to the limitation of liability, indemnification and jurisdiction issues defined therein. Any holder of this document is advised that information contained hereon reflects the Company's findings at the time of its intervention only and within the limits of Client's instructions, if any. The Company's sole responsibility is to its Client and this document does not exonerate parties to a transaction from exercising all their rights and obligations under the transaction documents. This document cannot be reproduced except in full, without prior written approval of the Company. Any unauthorized alteration, forgery or falsification of the content or appearance of this document is unlawful and offenders may be prosecuted to the fullest extent of the law.

CDMA / EVDO BC10 + 5GHz WLAN MIMO

| No. | Conditions | Position | Distance (mm) | Max. WWAN | Max. WLAN Main | Max. WLAN Aux | SAR Sum | SPLSR |
|-----|------------|------------------------|---------------|-----------|----------------|---------------|---------|--------------------------------|
| 28 | EVDO BC 10 | Back side | 0 | 0.55 | 0.073 | 0.212 | 0.835 | Σ SAR<1.6, Not required |
| | | Back side_Curve(Left) | 0 | 0.635 | - | - | - | Σ SAR<1.6, Not required |
| | | Back side_Curve(Right) | 0 | - | 0.078 | - | - | Σ SAR<1.6, Not required |
| | | Top side | 0 | 0.582 | 0.089 | 0.928 | 1.599 | Σ SAR<1.6, Not required |
| | | Bottom side | 0 | 0.058 | 0.003 | 0.007 | 0.068 | Σ SAR<1.6, Not required |
| | | Left side | 0 | 0.723 | 0.002 | 0.006 | 0.731 | Σ SAR<1.6, Not required |
| | | Right side | 0 | 0.004 | 0.513 | 0.029 | 0.546 | Σ SAR<1.6, Not required |

Unless otherwise stated the results shown in this test report refer only to the sample(s) tested and such sample(s) are retained for 90 days only.

除非另有說明，此報告結果僅對測試之樣品負責，同時此樣品僅保留90天。本報告未經本公司書面許可，不可部份複製。

This document is issued by the Company subject to its General Conditions of Service printed overleaf, available on request or accessible at www.sgs.com/terms_and_conditions.htm and, for electronic format documents, subject to Terms and Conditions for Electronic Documents at www.sgs.com/terms_e-document.htm. Attention is drawn to the limitation of liability, indemnification and jurisdiction issues defined therein. Any holder of this document is advised that information contained hereon reflects the Company's findings at the time of its intervention only and within the limits of Client's instructions, if any. The Company's sole responsibility is to its Client and this document does not exonerate parties to a transaction from exercising all their rights and obligations under the transaction documents. This document cannot be reproduced except in full, without prior written approval of the Company. Any unauthorized alteration, forgery or falsification of the content or appearance of this document is unlawful and offenders may be prosecuted to the fullest extent of the law.

GPRS 850 + BT + 2.4GHz WLAN Aux

| No. | Conditions | Position | Distance (mm) | Max. WWAN | BT | Max. WLAN Aux | SAR Sum | SPLSR |
|-----|------------|------------------------|---------------|-----------|-------|---------------|--------------|--------------------------------|
| 29 | 850 | Back side | 0 | 0.866 | 0.094 | 0.111 | 1.071 | Σ SAR<1.6, Not required |
| | | Back side_Curve(Left) | 0 | 0.754 | - | - | - | Σ SAR<1.6, Not required |
| | | Back side_Curve(Right) | 0 | - | 0.094 | - | - | Σ SAR<1.6, Not required |
| | | Top side | 0 | 0.762 | 0.03 | 0.842 | 1.634 | Analyzed as below |
| | | Bottom side | 0 | 0.013 | 0.4 | 0.007 | 0.42 | Σ SAR<1.6, Not required |
| | | Left side | 0 | 1.038 | 0.4 | 0.003 | 1.441 | Σ SAR<1.6, Not required |
| | | Right side | 0 | 0.002 | 0.094 | 0.007 | 0.103 | Σ SAR<1.6, Not required |

WWAN & BT

| Conditions | Position | SAR Value (W/kg) | Σ SAR (W/kg) | Peak Location Separation Distance (mm) | SPLSR | Simultaneous Transmission SAR Test |
|------------|----------|------------------|---------------------|--|-------|------------------------------------|
| GPRS 850 | Top side | 0.762 | 0.792 | 185.8 | 0.004 | SPLSR<0.04, Not required |
| BT | | 0.03 | | | | |

BT & WLAN Aux

| Conditions | Position | SAR Value (W/kg) | Σ SAR (W/kg) | Peak Location Separation Distance (mm) | SPLSR | Simultaneous Transmission SAR Test |
|------------|----------|------------------|---------------------|--|-------|------------------------------------|
| BT | Top side | 0.03 | 0.872 | 79 | 0.010 | SPLSR<0.04, Not required |
| WLAN Aux | | 0.842 | | | | |

Unless otherwise stated the results shown in this test report refer only to the sample(s) tested and such sample(s) are retained for 90 days only.

除非另有說明，此報告結果僅對測試之樣品負責，同時此樣品僅保留90天。本報告未經本公司書面許可，不可部份複製。

This document is issued by the Company subject to its General Conditions of Service printed overleaf, available on request or accessible at www.sgs.com/terms_and_conditions.htm and, for electronic format documents, subject to Terms and Conditions for Electronic Documents at www.sgs.com/terms_e-document.htm. Attention is drawn to the limitation of liability, indemnification and jurisdiction issues defined therein. Any holder of this document is advised that information contained hereon reflects the Company's findings at the time of its intervention only and within the limits of Client's instructions, if any. The Company's sole responsibility is to its Client and this document does not exonerate parties to a transaction from exercising all their rights and obligations under the transaction documents. This document cannot be reproduced except in full, without prior written approval of the Company. Any unauthorized alteration, forgery or falsification of the content or appearance of this document is unlawful and offenders may be prosecuted to the fullest extent of the law.

WWAN & WLAN Aux

| Conditions | Position | SAR Value (W/kg) | Coordinates (cm) | | | Σ SAR (W/kg) | Peak Location Separation Distance (mm) | SPLSR | Simultaneous Transmission SAR Test |
|------------|----------|------------------|------------------|-------|-------|---------------------|--|-------|------------------------------------|
| | | | x | y | z | | | | |
| GPRS 850 | Top side | 0.762 | -0.84 | -4.83 | -0.70 | 1.604 | 52.4 | 0.039 | SPLSR<0.04, Not required |
| WLAN Aux | | 0.842 | -0.74 | 0.58 | -0.73 | | | | |

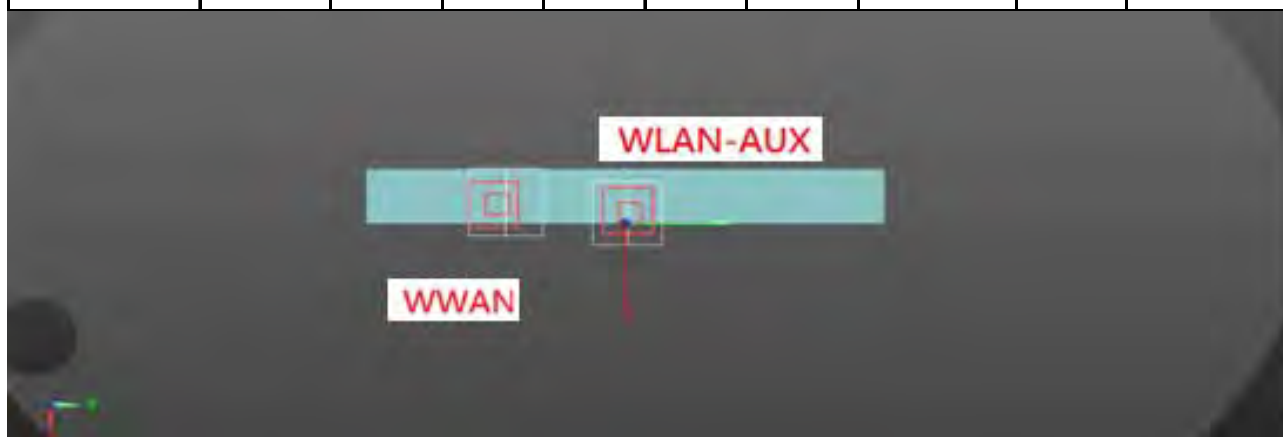

Unless otherwise stated the results shown in this test report refer only to the sample(s) tested and such sample(s) are retained for 90 days only.

除非另有說明，此報告結果僅對測試之樣品負責，同時此樣品僅保留90天。本報告未經本公司書面許可，不可部份複製。

This document is issued by the Company subject to its General Conditions of Service printed overleaf, available on request or accessible at www.sgs.com/terms_and_conditions.htm and, for electronic format documents, subject to Terms and Conditions for Electronic Documents at www.sgs.com/terms_e-document.htm. Attention is drawn to the limitation of liability, indemnification and jurisdiction issues defined therein. Any holder of this document is advised that information contained hereon reflects the Company's findings at the time of its intervention only and within the limits of Client's instructions, if any. The Company's sole responsibility is to its Client and this document does not exonerate parties to a transaction from exercising all their rights and obligations under the transaction documents. This document cannot be reproduced except in full, without prior written approval of the Company. Any unauthorized alteration, forgery or falsification of the content or appearance of this document is unlawful and offenders may be prosecuted to the fullest extent of the law.

GPRS 1900 + BT+ 2.4GHz WLAN Aux

| No. | Conditions | Position | Distance (mm) | Max. WWAN | BT | Max. WLAN Aux | SAR Sum | SPLSR |
|-----|------------|------------------------|---------------|-----------|-------|---------------|--------------|--------------------------------|
| 30 | 1900 | Back side | 0 | 1.197 | 0.094 | 0.111 | 1.402 | Σ SAR<1.6, Not required |
| | | Back side_Curve(Left) | 0 | 1.335 | - | - | - | Σ SAR<1.6, Not required |
| | | Back side_Curve(Right) | 0 | - | 0.094 | - | - | Σ SAR<1.6, Not required |
| | | Top side | 0 | 1.144 | 0.03 | 0.842 | 2.016 | Analyzed as below |
| | | Bottom side | 0 | 0.0145 | 0.4 | 0.007 | 0.4215 | Σ SAR<1.6, Not required |
| | | Left side | 0 | 0.287 | 0.4 | 0.003 | 0.69 | Σ SAR<1.6, Not required |
| | | Right side | 0 | 0.0012 | 0.094 | 0.007 | 0.1022 | Σ SAR<1.6, Not required |

WWAN & BT

| Conditions | Position | SAR Value (W/kg) | Σ SAR (W/kg) | Peak Location Separation Distance (mm) | SPLSR | Simultaneous Transmission SAR Test |
|------------|----------|------------------|---------------------|--|-------|------------------------------------|
| GPRS 1900 | Top side | 1.144 | 1.174 | 185.8 | 0.007 | SPLSR<0.04, Not required |
| BT | | 0.03 | | | | |

BT & WLAN Aux

| Conditions | Position | SAR Value (W/kg) | Σ SAR (W/kg) | Peak Location Separation Distance (mm) | SPLSR | Simultaneous Transmission SAR Test |
|------------|----------|------------------|---------------------|--|-------|------------------------------------|
| BT | Top side | 0.03 | 0.872 | 79 | 0.010 | SPLSR<0.04, Not required |
| WLAN Aux | | 0.842 | | | | |

Unless otherwise stated the results shown in this test report refer only to the sample(s) tested and such sample(s) are retained for 90 days only.

除非另有說明，此報告結果僅對測試之樣品負責，同時此樣品僅保留90天。本報告未經本公司書面許可，不可部份複製。

This document is issued by the Company subject to its General Conditions of Service printed overleaf, available on request or accessible at www.sgs.com/terms_and_conditions.htm and, for electronic format documents, subject to Terms and Conditions for Electronic Documents at www.sgs.com/terms_e-document.htm. Attention is drawn to the limitation of liability, indemnification and jurisdiction issues defined therein. Any holder of this document is advised that information contained hereon reflects the Company's findings at the time of its intervention only and within the limits of Client's instructions, if any. The Company's sole responsibility is to its Client and this document does not exonerate parties to a transaction from exercising all their rights and obligations under the transaction documents. This document cannot be reproduced except in full, without prior written approval of the Company. Any unauthorized alteration, forgery or falsification of the content or appearance of this document is unlawful and offenders may be prosecuted to the fullest extent of the law.

WWAN & WLAN Aux

| Conditions | Position | SAR Value (W/kg) | Coordinates (cm) | | | Σ SAR (W/kg) | Peak Location Separation Distance (mm) | SPLSR | Simultaneous Transmission SAR Test |
|------------|----------|------------------|------------------|-------|-------|---------------------|--|-------|------------------------------------|
| | | | x | y | z | | | | |
| GPRS 1900 | Top side | 1.144 | -0.54 | -8.59 | 0.45 | 1.986 | 90.7 | 0.031 | SPLSR<0.04, Not required |
| WLAN Aux | | 0.842 | -0.74 | 0.58 | -0.73 | | | | |

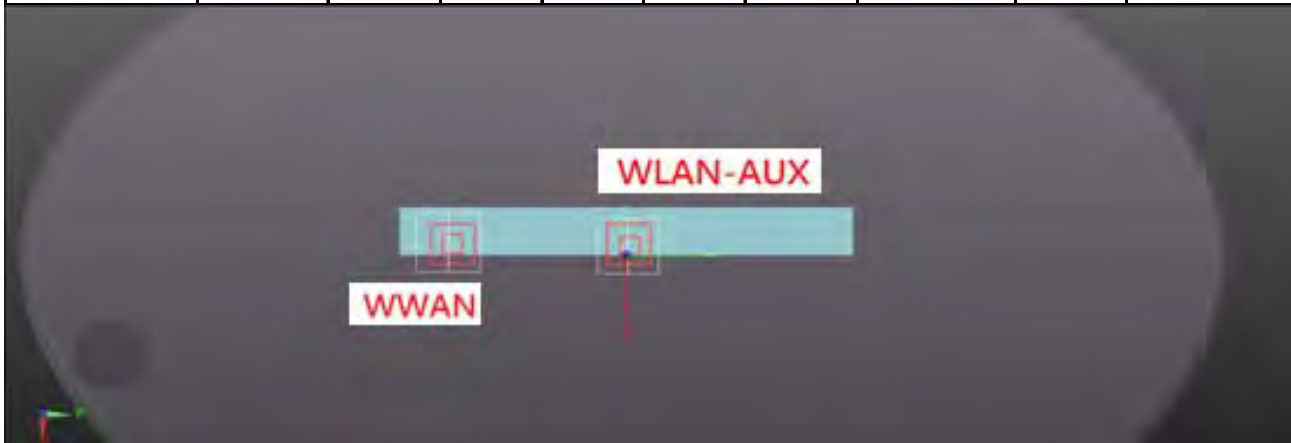

Unless otherwise stated the results shown in this test report refer only to the sample(s) tested and such sample(s) are retained for 90 days only.

除非另有說明，此報告結果僅對測試之樣品負責，同時此樣品僅保留90天。本報告未經本公司書面許可，不可部份複製。

This document is issued by the Company subject to its General Conditions of Service printed overleaf, available on request or accessible at www.sgs.com/terms_and_conditions.htm and, for electronic format documents, subject to Terms and Conditions for Electronic Documents at www.sgs.com/terms_e-document.htm. Attention is drawn to the limitation of liability, indemnification and jurisdiction issues defined therein. Any holder of this document is advised that information contained hereon reflects the Company's findings at the time of its intervention only and within the limits of Client's instructions, if any. The Company's sole responsibility is to its Client and this document does not exonerate parties to a transaction from exercising all their rights and obligations under the transaction documents. This document cannot be reproduced except in full, without prior written approval of the Company. Any unauthorized alteration, forgery or falsification of the content or appearance of this document is unlawful and offenders may be prosecuted to the fullest extent of the law.

WCDMA Band II + BT+ 2.4GHz WLAN Aux

| No. | Conditions | Position | Distance (mm) | Max. WWAN | BT | Max. WLAN Aux | SAR Sum | SPLSR |
|-----|--------------|------------------------|---------------|-----------|-------|---------------|--------------|------------------------|
| 31 | WCDMA Band 2 | Back side | 0 | 0.962 | 0.094 | 0.111 | 1.167 | ΣSAR<1.6, Not required |
| | | Back side_Curve(Left) | 0 | 1.16 | - | - | - | ΣSAR<1.6, Not required |
| | | Back side_Curve(Right) | 0 | - | 0.094 | - | - | ΣSAR<1.6, Not required |
| | | Top side | 0 | 1.033 | 0.03 | 0.842 | 1.905 | Analyzed as below |
| | | Bottom side | 0 | 0.016 | 0.4 | 0.007 | 0.423 | ΣSAR<1.6, Not required |
| | | Left side | 0 | 0.299 | 0.4 | 0.003 | 0.702 | ΣSAR<1.6, Not required |
| | | Right side | 0 | 0.002 | 0.094 | 0.007 | 0.103 | ΣSAR<1.6, Not required |

WWAN & BT

| Conditions | Position | SAR Value (W/kg) | ΣSAR (W/kg) | Peak Location Separation Distance (mm) | SPLSR | Simultaneous Transmission SAR Test |
|------------|----------|------------------|-------------|--|-------|------------------------------------|
| WCDMA B2 | Top side | 1.033 | 1.063 | 185.8 | 0.006 | SPLSR<0.04, Not required |
| BT | | 0.03 | | | | |

BT & WLAN Aux

| Conditions | Position | SAR Value (W/kg) | ΣSAR (W/kg) | Peak Location Separation Distance (mm) | SPLSR | Simultaneous Transmission SAR Test |
|------------|----------|------------------|-------------|--|-------|------------------------------------|
| BT | Top side | 0.03 | 0.872 | 79 | 0.010 | SPLSR<0.04, Not required |
| WLAN Aux | | 0.842 | | | | |

Unless otherwise stated the results shown in this test report refer only to the sample(s) tested and such sample(s) are retained for 90 days only.

除非另有說明，此報告結果僅對測試之樣品負責，同時此樣品僅保留90天。本報告未經本公司書面許可，不可部份複製。

This document is issued by the Company subject to its General Conditions of Service printed overleaf, available on request or accessible at www.sgs.com/terms_and_conditions.htm and, for electronic format documents, subject to Terms and Conditions for Electronic Documents at www.sgs.com/terms_e-document.htm. Attention is drawn to the limitation of liability, indemnification and jurisdiction issues defined therein. Any holder of this document is advised that information contained hereon reflects the Company's findings at the time of its intervention only and within the limits of Client's instructions, if any. The Company's sole responsibility is to its Client and this document does not exonerate parties to a transaction from exercising all their rights and obligations under the transaction documents. This document cannot be reproduced except in full, without prior written approval of the Company. Any unauthorized alteration, forgery or falsification of the content or appearance of this document is unlawful and offenders may be prosecuted to the fullest extent of the law.

WWAN & WLAN Aux

| Conditions | Position | SAR Value (W/kg) | Coordinates (cm) | | | Σ SAR (W/kg) | Peak Location Separation Distance (mm) | SPLSR | Simultaneous Transmission SAR Test |
|------------|----------|------------------|------------------|-------|-------|---------------------|--|-------|------------------------------------|
| | | | x | y | z | | | | |
| WCDMA B2 | Top side | 1.033 | -1.00 | -8.00 | 0.45 | 1.875 | 85 | 0.030 | SPLSR<0.04, Not required |
| WLAN Aux | | 0.842 | -0.74 | 0.58 | -0.73 | | | | |

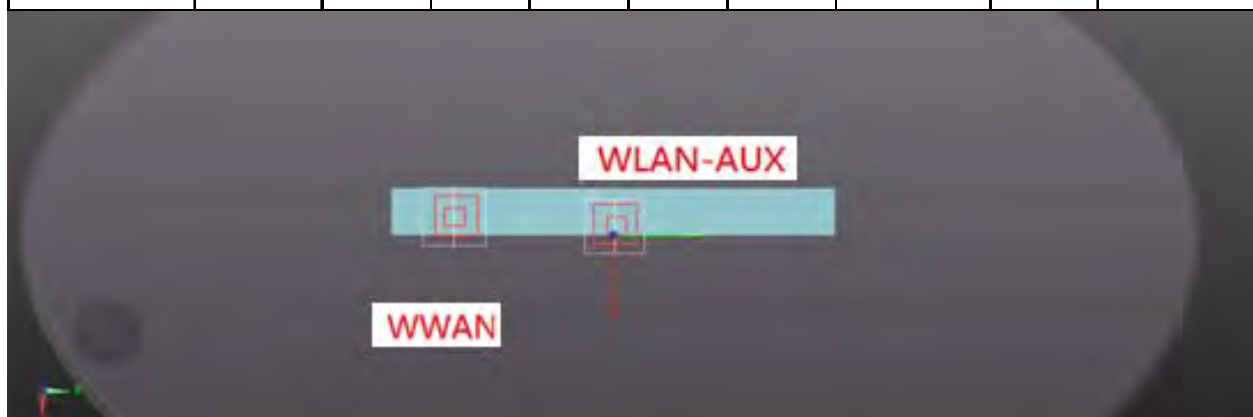

Unless otherwise stated the results shown in this test report refer only to the sample(s) tested and such sample(s) are retained for 90 days only.

除非另有說明，此報告結果僅對測試之樣品負責，同時此樣品僅保留90天。本報告未經本公司書面許可，不可部份複製。

This document is issued by the Company subject to its General Conditions of Service printed overleaf, available on request or accessible at www.sgs.com/terms_and_conditions.htm and, for electronic format documents, subject to Terms and Conditions for Electronic Documents at www.sgs.com/terms_e-document.htm. Attention is drawn to the limitation of liability, indemnification and jurisdiction issues defined therein. Any holder of this document is advised that information contained hereon reflects the Company's findings at the time of its intervention only and within the limits of Client's instructions, if any. The Company's sole responsibility is to its Client and this document does not exonerate parties to a transaction from exercising all their rights and obligations under the transaction documents. This document cannot be reproduced except in full, without prior written approval of the Company. Any unauthorized alteration, forgery or falsification of the content or appearance of this document is unlawful and offenders may be prosecuted to the fullest extent of the law.

WCDMA Band IV + BT+ 2.4GHz WLAN Aux

| No. | Conditions | Position | Distance (mm) | Max. WWAN | BT | Max. WLAN Aux | SAR Sum | SPLSR |
|-----|--------------|------------------------|---------------|-----------|-------|---------------|--------------|--------------------------------|
| 32 | WCDMA Band 4 | Back side | 0 | 0.999 | 0.094 | 0.111 | 1.204 | Σ SAR<1.6, Not required |
| | | Back side_Curve(Left) | 0 | 1.131 | - | - | - | Σ SAR<1.6, Not required |
| | | Back side_Curve(Right) | 0 | - | 0.094 | - | - | Σ SAR<1.6, Not required |
| | | Top side | 0 | 1.049 | 0.03 | 0.842 | 1.921 | Analyzed as below |
| | | Bottom side | 0 | 0.0235 | 0.4 | 0.007 | 0.4305 | Σ SAR<1.6, Not required |
| | | Left side | 0 | 0.532 | 0.4 | 0.003 | 0.935 | Σ SAR<1.6, Not required |
| | | Right side | 0 | 0.0042 | 0.094 | 0.007 | 0.1052 | Σ SAR<1.6, Not required |

WWAN & BT

| Conditions | Position | SAR Value (W/kg) | Σ SAR (W/kg) | Peak Location Separation Distance (mm) | SPLSR | Simultaneous Transmission SAR Test |
|------------|----------|------------------|---------------------|--|-------|------------------------------------|
| WCDMA B4 | Top side | 1.049 | 1.079 | 185.8 | 0.006 | SPLSR<0.04, Not required |
| BT | | 0.03 | | | | |

BT & WLAN Aux

| Conditions | Position | SAR Value (W/kg) | Σ SAR (W/kg) | Peak Location Separation Distance (mm) | SPLSR | Simultaneous Transmission SAR Test |
|------------|----------|------------------|---------------------|--|-------|------------------------------------|
| BT | Top side | 0.03 | 0.872 | 79 | 0.010 | SPLSR<0.04, Not required |
| WLAN Aux | | 0.842 | | | | |

Unless otherwise stated the results shown in this test report refer only to the sample(s) tested and such sample(s) are retained for 90 days only.

除非另有說明，此報告結果僅對測試之樣品負責，同時此樣品僅保留90天。本報告未經本公司書面許可，不可部份複製。

This document is issued by the Company subject to its General Conditions of Service printed overleaf, available on request or accessible at www.sgs.com/terms_and_conditions.htm and, for electronic format documents, subject to Terms and Conditions for Electronic Documents at www.sgs.com/terms_e-document.htm. Attention is drawn to the limitation of liability, indemnification and jurisdiction issues defined therein. Any holder of this document is advised that information contained hereon reflects the Company's findings at the time of its intervention only and within the limits of Client's instructions, if any. The Company's sole responsibility is to its Client and this document does not exonerate parties to a transaction from exercising all their rights and obligations under the transaction documents. This document cannot be reproduced except in full, without prior written approval of the Company. Any unauthorized alteration, forgery or falsification of the content or appearance of this document is unlawful and offenders may be prosecuted to the fullest extent of the law.

WWAN & WLAN Aux

| Conditions | Position | SAR Value (W/kg) | Coordinates (cm) | | | Σ SAR (W/kg) | Peak Location Separation Distance (mm) | SPLSR | Simultaneous Transmission SAR Test |
|------------|----------|------------------|------------------|-------|-------|---------------------|--|-------|------------------------------------|
| | | | x | y | z | | | | |
| WCDMA B4 | Top side | 1.049 | -0.84 | -8.59 | -0.50 | 1.891 | 90 | 0.029 | SPLSR<0.04, Not required |
| WLAN Aux | | 0.842 | -0.74 | 0.58 | -0.73 | | | | |

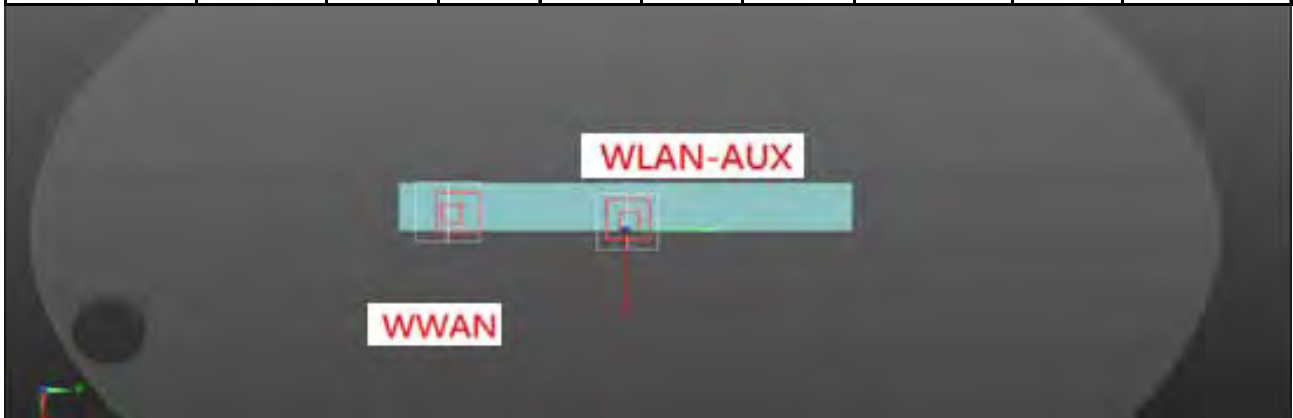

Unless otherwise stated the results shown in this test report refer only to the sample(s) tested and such sample(s) are retained for 90 days only.

除非另有說明，此報告結果僅對測試之樣品負責，同時此樣品僅保留90天。本報告未經本公司書面許可，不可部份複製。

This document is issued by the Company subject to its General Conditions of Service printed overleaf, available on request or accessible at www.sgs.com/terms_and_conditions.htm and, for electronic format documents, subject to Terms and Conditions for Electronic Documents at www.sgs.com/terms_e-document.htm. Attention is drawn to the limitation of liability, indemnification and jurisdiction issues defined therein. Any holder of this document is advised that information contained hereon reflects the Company's findings at the time of its intervention only and within the limits of Client's instructions, if any. The Company's sole responsibility is to its Client and this document does not exonerate parties to a transaction from exercising all their rights and obligations under the transaction documents. This document cannot be reproduced except in full, without prior written approval of the Company. Any unauthorized alteration, forgery or falsification of the content or appearance of this document is unlawful and offenders may be prosecuted to the fullest extent of the law.

WCDMA Band V + BT+ 2.4GHz WLAN Aux

| No. | Conditions | Position | Distance (mm) | Max. WWAN | BT | Max. WLAN Aux | SAR Sum | SPLSR |
|-----|--------------|------------------------|---------------|-----------|-------|---------------|---------|--------------------------------|
| 33 | WCDMA Band 5 | Back side | 0 | 0.407 | 0.094 | 0.111 | 0.612 | Σ SAR<1.6, Not required |
| | | Back side_Curve(Left) | 0 | 0.402 | - | - | - | Σ SAR<1.6, Not required |
| | | Back side_Curve(Right) | 0 | - | 0.094 | - | - | Σ SAR<1.6, Not required |
| | | Top side | 0 | 0.391 | 0.03 | 0.842 | 1.263 | Σ SAR<1.6, Not required |
| | | Bottom side | 0 | 0.035 | 0.4 | 0.007 | 0.442 | Σ SAR<1.6, Not required |
| | | Left side | 0 | 0.615 | 0.4 | 0.003 | 1.018 | Σ SAR<1.6, Not required |
| | | Right side | 0 | 0.003 | 0.094 | 0.007 | 0.104 | Σ SAR<1.6, Not required |

Unless otherwise stated the results shown in this test report refer only to the sample(s) tested and such sample(s) are retained for 90 days only.

除非另有說明，此報告結果僅對測試之樣品負責，同時此樣品僅保留90天。本報告未經本公司書面許可，不可部份複製。

This document is issued by the Company subject to its General Conditions of Service printed overleaf, available on request or accessible at www.sgs.com/terms_and_conditions.htm and, for electronic format documents, subject to Terms and Conditions for Electronic Documents at www.sgs.com/terms_e-document.htm. Attention is drawn to the limitation of liability, indemnification and jurisdiction issues defined therein. Any holder of this document is advised that information contained hereon reflects the Company's findings at the time of its intervention only and within the limits of Client's instructions, if any. The Company's sole responsibility is to its Client and this document does not exonerate parties to a transaction from exercising all their rights and obligations under the transaction documents. This document cannot be reproduced except in full, without prior written approval of the Company. Any unauthorized alteration, forgery or falsification of the content or appearance of this document is unlawful and offenders may be prosecuted to the fullest extent of the law.

LTE FDD Band II + BT+ 2.4GHz WLAN Aux

| No. | Conditions | Position | Distance (mm) | Max. WWAN | BT | Max. WLAN Aux | SAR Sum | SPLSR |
|-----|------------|------------------------|---------------|-----------|-------|---------------|--------------|--------------------------------|
| 34 | LTE Band 2 | Back side | 0 | 1.062 | 0.094 | 0.111 | 1.267 | Σ SAR<1.6, Not required |
| | | Back side_Curve(Left) | 0 | 1.086 | - | - | - | Σ SAR<1.6, Not required |
| | | Back side_Curve(Right) | 0 | - | 0.094 | - | - | Σ SAR<1.6, Not required |
| | | Top side | 0 | 1.09 | 0.03 | 0.842 | 1.962 | Analyzed as below |
| | | Bottom side | 0 | 0.041 | 0.4 | 0.007 | 0.448 | Σ SAR<1.6, Not required |
| | | Left side | 0 | 0.281 | 0.4 | 0.003 | 0.684 | Σ SAR<1.6, Not required |
| | | Right side | 0 | 0.027 | 0.094 | 0.007 | 0.128 | Σ SAR<1.6, Not required |

WWAN & BT

| Conditions | Position | SAR Value (W/kg) | Σ SAR (W/kg) | Peak Location Separation Distance (mm) | SPLSR | Simultaneous Transmission SAR Test |
|------------|----------|------------------|---------------------|--|-------|------------------------------------|
| LTE Band 2 | Top side | 1.09 | 1.12 | 185.8 | 0.006 | SPLSR<0.04, Not required |
| BT | | 0.03 | | | | |

BT & WLAN Aux

| Conditions | Position | SAR Value (W/kg) | Σ SAR (W/kg) | Peak Location Separation Distance (mm) | SPLSR | Simultaneous Transmission SAR Test |
|------------|----------|------------------|---------------------|--|-------|------------------------------------|
| BT | Top side | 0.03 | 0.872 | 79 | 0.010 | SPLSR<0.04, Not required |
| WLAN Aux | | 0.842 | | | | |

Unless otherwise stated the results shown in this test report refer only to the sample(s) tested and such sample(s) are retained for 90 days only.

除非另有說明，此報告結果僅對測試之樣品負責，同時此樣品僅保留90天。本報告未經本公司書面許可，不可部份複製。

This document is issued by the Company subject to its General Conditions of Service printed overleaf, available on request or accessible at www.sgs.com/terms_and_conditions.htm and, for electronic format documents, subject to Terms and Conditions for Electronic Documents at www.sgs.com/terms_e-document.htm. Attention is drawn to the limitation of liability, indemnification and jurisdiction issues defined therein. Any holder of this document is advised that information contained hereon reflects the Company's findings at the time of its intervention only and within the limits of Client's instructions, if any. The Company's sole responsibility is to its Client and this document does not exonerate parties to a transaction from exercising all their rights and obligations under the transaction documents. This document cannot be reproduced except in full, without prior written approval of the Company. Any unauthorized alteration, forgery or falsification of the content or appearance of this document is unlawful and offenders may be prosecuted to the fullest extent of the law.

WWAN & WLAN Aux

| Conditions | Position | SAR Value (W/kg) | Coordinates (cm) | | | ΣSAR (W/kg) | Peak Location Separation Distance (mm) | SPLSR | Simultaneous Transmission SAR Test |
|------------|----------|------------------|------------------|-------|-------|-------------|--|-------|------------------------------------|
| | | | x | y | z | | | | |
| LTE Band 2 | Top side | 1.09 | -1.30 | -8.16 | 0.45 | 1.932 | 86.7 | 0.031 | SPLSR<0.04, Not required |
| WLAN Aux | | 0.842 | -0.74 | 0.58 | -0.73 | | | | |



Unless otherwise stated the results shown in this test report refer only to the sample(s) tested and such sample(s) are retained for 90 days only.

除非另有說明，此報告結果僅對測試之樣品負責，同時此樣品僅保留90天。本報告未經本公司書面許可，不可部份複製。

This document is issued by the Company subject to its General Conditions of Service printed overleaf, available on request or accessible at www.sgs.com/terms_and_conditions.htm and, for electronic format documents, subject to Terms and Conditions for Electronic Documents at www.sgs.com/terms_e-document.htm. Attention is drawn to the limitation of liability, indemnification and jurisdiction issues defined therein. Any holder of this document is advised that information contained hereon reflects the Company's findings at the time of its intervention only and within the limits of Client's instructions, if any. The Company's sole responsibility is to its Client and this document does not exonerate parties to a transaction from exercising all their rights and obligations under the transaction documents. This document cannot be reproduced except in full, without prior written approval of the Company. Any unauthorized alteration, forgery or falsification of the content or appearance of this document is unlawful and offenders may be prosecuted to the fullest extent of the law.

LTE FDD Band IV + BT + 2.4GHz WLAN Aux

| No. | Conditions | Position | Distance (mm) | Max. WWAN | BT | Max. WLAN Aux | SAR Sum | SPLSR |
|-----|------------|------------------------|---------------|-----------|-------|---------------|--------------|--------------------------------|
| 35 | LTE Band 4 | Back side | 0 | 1.193 | 0.094 | 0.111 | 1.398 | Σ SAR<1.6, Not required |
| | | Back side_Curve(Left) | 0 | 1.154 | - | - | - | Σ SAR<1.6, Not required |
| | | Back side_Curve(Right) | 0 | - | 0.094 | - | - | Σ SAR<1.6, Not required |
| | | Top side | 0 | 1.069 | 0.03 | 0.842 | 1.941 | Analyzed as below |
| | | Bottom side | 0 | 0.044 | 0.4 | 0.007 | 0.451 | Σ SAR<1.6, Not required |
| | | Left side | 0 | 0.543 | 0.4 | 0.003 | 0.946 | Σ SAR<1.6, Not required |
| | | Right side | 0 | 0.007 | 0.094 | 0.007 | 0.108 | Σ SAR<1.6, Not required |

WWAN & BT

| Conditions | Position | SAR Value (W/kg) | Σ SAR (W/kg) | Peak Location Separation Distance (mm) | SPLSR | Simultaneous Transmission SAR Test |
|------------|----------|------------------|---------------------|--|-------|------------------------------------|
| LTE Band 4 | Top side | 1.069 | 1.099 | 185.8 | 0.006 | SPLSR<0.04, Not required |
| BT | | 0.03 | | | | |

BT & WLAN Aux

| Conditions | Position | SAR Value (W/kg) | Σ SAR (W/kg) | Peak Location Separation Distance (mm) | SPLSR | Simultaneous Transmission SAR Test |
|------------|----------|------------------|---------------------|--|-------|------------------------------------|
| BT | Top side | 0.03 | 0.872 | 79 | 0.010 | SPLSR<0.04, Not required |
| WLAN Aux | | 0.842 | | | | |

Unless otherwise stated the results shown in this test report refer only to the sample(s) tested and such sample(s) are retained for 90 days only.

除非另有說明，此報告結果僅對測試之樣品負責，同時此樣品僅保留90天。本報告未經本公司書面許可，不可部份複製。

This document is issued by the Company subject to its General Conditions of Service printed overleaf, available on request or accessible at www.sgs.com/terms_and_conditions.htm and, for electronic format documents, subject to Terms and Conditions for Electronic Documents at www.sgs.com/terms_e-document.htm. Attention is drawn to the limitation of liability, indemnification and jurisdiction issues defined therein. Any holder of this document is advised that information contained hereon reflects the Company's findings at the time of its intervention only and within the limits of Client's instructions, if any. The Company's sole responsibility is to its Client and this document does not exonerate parties to a transaction from exercising all their rights and obligations under the transaction documents. This document cannot be reproduced except in full, without prior written approval of the Company. Any unauthorized alteration, forgery or falsification of the content or appearance of this document is unlawful and offenders may be prosecuted to the fullest extent of the law.

WWAN & WLAN Aux

| Conditions | Position | SAR Value (W/kg) | Coordinates (cm) | | | ΣSAR (W/kg) | Peak Location Separation Distance (mm) | SPLSR | Simultaneous Transmission SAR Test |
|------------|----------|------------------|------------------|-------|-------|-------------|--|-------|------------------------------------|
| | | | x | y | z | | | | |
| LTE Band 4 | Top side | 1.069 | -1.35 | -8.34 | -0.48 | 1.911 | 87.8 | 0.030 | SPLSR<0.04, Not required |
| WLAN Aux | | 0.842 | -0.74 | 0.58 | -0.73 | | | | |

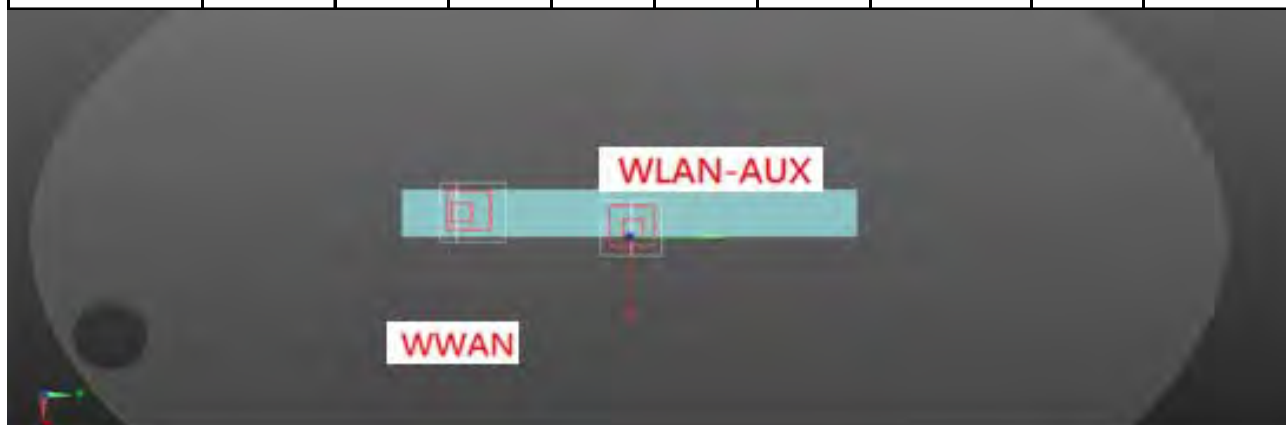

Unless otherwise stated the results shown in this test report refer only to the sample(s) tested and such sample(s) are retained for 90 days only.

除非另有說明，此報告結果僅對測試之樣品負責，同時此樣品僅保留90天。本報告未經本公司書面許可，不可部份複製。

This document is issued by the Company subject to its General Conditions of Service printed overleaf, available on request or accessible at www.sgs.com/terms_and_conditions.htm and, for electronic format documents, subject to Terms and Conditions for Electronic Documents at www.sgs.com/terms_e-document.htm. Attention is drawn to the limitation of liability, indemnification and jurisdiction issues defined therein. Any holder of this document is advised that information contained hereon reflects the Company's findings at the time of its intervention only and within the limits of Client's instructions, if any. The Company's sole responsibility is to its Client and this document does not exonerate parties to a transaction from exercising all their rights and obligations under the transaction documents. This document cannot be reproduced except in full, without prior written approval of the Company. Any unauthorized alteration, forgery or falsification of the content or appearance of this document is unlawful and offenders may be prosecuted to the fullest extent of the law.

LTE FDD Band V + BT+ 2.4GHz WLAN Aux

| No. | Conditions | Position | Distance (mm) | Max. WWAN | BT | Max. WLAN Aux | SAR Sum | SPLSR |
|-----|------------|------------------------|---------------|-----------|-------|---------------|---------|--------------------------------|
| 36 | LTE Band 5 | Back side | 0 | 0.491 | 0.094 | 0.111 | 0.696 | Σ SAR<1.6, Not required |
| | | Back side_Curve(Left) | 0 | 0.58 | - | - | - | Σ SAR<1.6, Not required |
| | | Back side_Curve(Right) | 0 | - | 0.094 | - | - | Σ SAR<1.6, Not required |
| | | Top side | 0 | 0.576 | 0.03 | 0.842 | 1.448 | Σ SAR<1.6, Not required |
| | | Bottom side | 0 | 0.076 | 0.4 | 0.007 | 0.483 | Σ SAR<1.6, Not required |
| | | Left side | 0 | 0.601 | 0.4 | 0.003 | 1.004 | Σ SAR<1.6, Not required |
| | | Right side | 0 | 0.014 | 0.094 | 0.007 | 0.115 | Σ SAR<1.6, Not required |

LTE FDD Band XIII + BT+ 2.4GHz WLAN Aux

| No. | Conditions | Position | Distance (mm) | Max. WWAN | BT | Max. WLAN Aux | SAR Sum | SPLSR |
|-----|-------------|------------------------|---------------|-----------|-------|---------------|---------|--------------------------------|
| 37 | LTE Band 13 | Back side | 0 | 0.468 | 0.094 | 0.111 | 0.673 | Σ SAR<1.6, Not required |
| | | Back side_Curve(Left) | 0 | 0.486 | - | - | - | Σ SAR<1.6, Not required |
| | | Back side_Curve(Right) | 0 | - | 0.094 | - | - | Σ SAR<1.6, Not required |
| | | Top side | 0 | 0.549 | 0.03 | 0.842 | 1.421 | Σ SAR<1.6, Not required |
| | | Bottom side | 0 | 0.093 | 0.4 | 0.007 | 0.5 | Σ SAR<1.6, Not required |
| | | Left side | 0 | 0.837 | 0.4 | 0.003 | 1.24 | Σ SAR<1.6, Not required |
| | | Right side | 0 | 0.01 | 0.094 | 0.007 | 0.111 | Σ SAR<1.6, Not required |

Unless otherwise stated the results shown in this test report refer only to the sample(s) tested and such sample(s) are retained for 90 days only.

除非另有說明，此報告結果僅對測試之樣品負責，同時此樣品僅保留90天。本報告未經本公司書面許可，不可部份複製。

This document is issued by the Company subject to its General Conditions of Service printed overleaf, available on request or accessible at www.sgs.com/terms_and_conditions.htm and, for electronic format documents, subject to Terms and Conditions for Electronic Documents at www.sgs.com/terms_e-document.htm. Attention is drawn to the limitation of liability, indemnification and jurisdiction issues defined therein. Any holder of this document is advised that information contained hereon reflects the Company's findings at the time of its intervention only and within the limits of Client's instructions, if any. The Company's sole responsibility is to its Client and this document does not exonerate parties to a transaction from exercising all their rights and obligations under the transaction documents. This document cannot be reproduced except in full, without prior written approval of the Company. Any unauthorized alteration, forgery or falsification of the content or appearance of this document is unlawful and offenders may be prosecuted to the fullest extent of the law.

LTE FDD Band XVII + BT+ 2.4GHz WLAN Aux

| No. | Conditions | Position | Distance (mm) | Max. WWAN | BT | Max. WLAN Aux | SAR Sum | SPLSR |
|-----|-------------|------------------------|---------------|-----------|-------|---------------|---------|--------------------------------|
| 38 | LTE Band 17 | Back side | 0 | 0.264 | 0.094 | 0.111 | 0.469 | Σ SAR<1.6, Not required |
| | | Back side_Curve(Left) | 0 | 0.296 | - | - | - | Σ SAR<1.6, Not required |
| | | Back side_Curve(Right) | 0 | - | 0.094 | - | - | Σ SAR<1.6, Not required |
| | | Top side | 0 | 0.223 | 0.03 | 0.842 | 1.095 | Σ SAR<1.6, Not required |
| | | Bottom side | 0 | 0.009 | 0.4 | 0.007 | 0.416 | Σ SAR<1.6, Not required |
| | | Left side | 0 | 0.438 | 0.4 | 0.003 | 0.841 | Σ SAR<1.6, Not required |
| | | Right side | 0 | 0.005 | 0.094 | 0.007 | 0.106 | Σ SAR<1.6, Not required |

Unless otherwise stated the results shown in this test report refer only to the sample(s) tested and such sample(s) are retained for 90 days only.

除非另有說明，此報告結果僅對測試之樣品負責，同時此樣品僅保留90天。本報告未經本公司書面許可，不可部份複製。

This document is issued by the Company subject to its General Conditions of Service printed overleaf, available on request or accessible at www.sgs.com/terms_and_conditions.htm and, for electronic format documents, subject to Terms and Conditions for Electronic Documents at www.sgs.com/terms_e-document.htm. Attention is drawn to the limitation of liability, indemnification and jurisdiction issues defined therein. Any holder of this document is advised that information contained hereon reflects the Company's findings at the time of its intervention only and within the limits of Client's instructions, if any. The Company's sole responsibility is to its Client and this document does not exonerate parties to a transaction from exercising all their rights and obligations under the transaction documents. This document cannot be reproduced except in full, without prior written approval of the Company. Any unauthorized alteration, forgery or falsification of the content or appearance of this document is unlawful and offenders may be prosecuted to the fullest extent of the law.

LTE FDD Band XXV + BT+ 2.4GHz WLAN Aux

| No. | Conditions | Position | Distance (mm) | Max. WWAN | BT | Max. WLAN Aux | SAR Sum | SPLSR |
|-----|-------------|------------------------|---------------|-----------|-------|---------------|--------------|--------------------------------|
| 39 | LTE Band 25 | Back side | 0 | 1.151 | 0.094 | 0.111 | 1.356 | Σ SAR<1.6, Not required |
| | | Back side_Curve(Left) | 0 | 0.979 | - | - | - | Σ SAR<1.6, Not required |
| | | Back side_Curve(Right) | 0 | - | 0.094 | - | - | Σ SAR<1.6, Not required |
| | | Top side | 0 | 1.159 | 0.03 | 0.842 | 2.031 | Analyzed as below |
| | | Bottom side | 0 | 0.026 | 0.4 | 0.007 | 0.433 | Σ SAR<1.6, Not required |
| | | Left side | 0 | 0.375 | 0.4 | 0.003 | 0.778 | Σ SAR<1.6, Not required |
| | | Right side | 0 | 0.007 | 0.094 | 0.007 | 0.108 | Σ SAR<1.6, Not required |

WWAN & BT

| Conditions | Position | SAR Value (W/kg) | Σ SAR (W/kg) | Peak Location Separation Distance (mm) | SPLSR | Simultaneous Transmission SAR Test |
|-------------|----------|------------------|---------------------|--|-------|------------------------------------|
| LTE Band 25 | Top side | 1.159 | 1.189 | 185.8 | 0.007 | SPLSR<0.04, Not required |
| BT | | 0.03 | | | | |

BT & WLAN Aux

| Conditions | Position | SAR Value (W/kg) | Σ SAR (W/kg) | Peak Location Separation Distance (mm) | SPLSR | Simultaneous Transmission SAR Test |
|------------|----------|------------------|---------------------|--|-------|------------------------------------|
| BT | Top side | 0.03 | 0.872 | 79 | 0.010 | SPLSR<0.04, Not required |
| WLAN Aux | | 0.842 | | | | |

Unless otherwise stated the results shown in this test report refer only to the sample(s) tested and such sample(s) are retained for 90 days only.

除非另有說明，此報告結果僅對測試之樣品負責，同時此樣品僅保留90天。本報告未經本公司書面許可，不可部份複製。

This document is issued by the Company subject to its General Conditions of Service printed overleaf, available on request or accessible at www.sgs.com/terms_and_conditions.htm and, for electronic format documents, subject to Terms and Conditions for Electronic Documents at www.sgs.com/terms_e-document.htm. Attention is drawn to the limitation of liability, indemnification and jurisdiction issues defined therein. Any holder of this document is advised that information contained hereon reflects the Company's findings at the time of its intervention only and within the limits of Client's instructions, if any. The Company's sole responsibility is to its Client and this document does not exonerate parties to a transaction from exercising all their rights and obligations under the transaction documents. This document cannot be reproduced except in full, without prior written approval of the Company. Any unauthorized alteration, forgery or falsification of the content or appearance of this document is unlawful and offenders may be prosecuted to the fullest extent of the law.

WWAN & WLAN Aux

| Conditions | Position | SAR Value (W/kg) | Coordinates (cm) | | | ΣSAR (W/kg) | Peak Location Separation Distance (mm) | SPLSR | Simultaneous Transmission SAR Test |
|-------------|----------|------------------|------------------|-------|-------|-------------|--|-------|------------------------------------|
| | | | x | y | z | | | | |
| LTE Band 25 | Top side | 1.159 | -1.14 | -8.47 | 0.51 | 2.001 | 89.8 | 0.032 | SPLSR<0.04, Not required |
| WLAN Aux | | 0.842 | -0.74 | 0.58 | -0.73 | | | | |

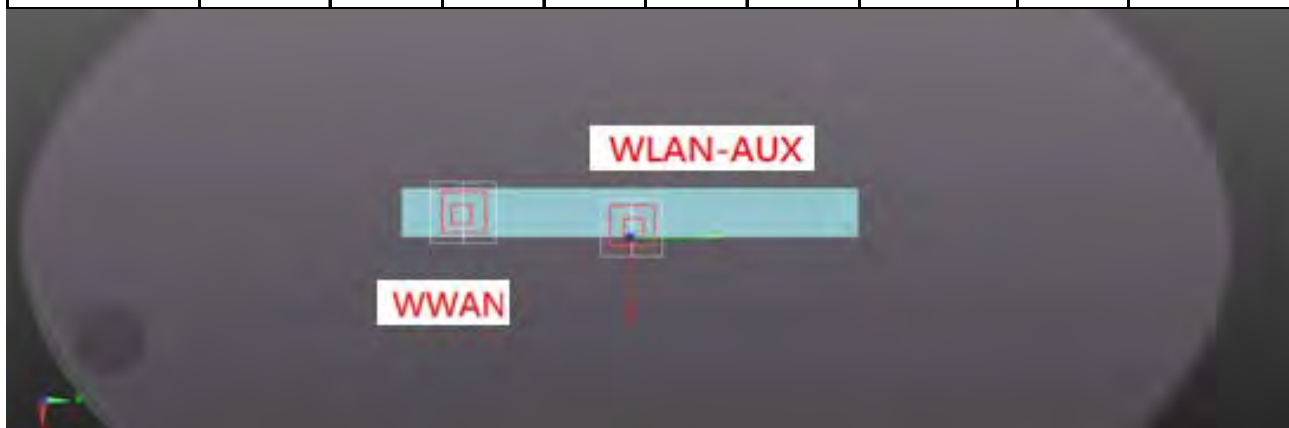

Unless otherwise stated the results shown in this test report refer only to the sample(s) tested and such sample(s) are retained for 90 days only.

除非另有說明，此報告結果僅對測試之樣品負責，同時此樣品僅保留90天。本報告未經本公司書面許可，不可部份複製。

This document is issued by the Company subject to its General Conditions of Service printed overleaf, available on request or accessible at www.sgs.com/terms_and_conditions.htm and, for electronic format documents, subject to Terms and Conditions for Electronic Documents at www.sgs.com/terms_e-document.htm. Attention is drawn to the limitation of liability, indemnification and jurisdiction issues defined therein. Any holder of this document is advised that information contained hereon reflects the Company's findings at the time of its intervention only and within the limits of Client's instructions, if any. The Company's sole responsibility is to its Client and this document does not exonerate parties to a transaction from exercising all their rights and obligations under the transaction documents. This document cannot be reproduced except in full, without prior written approval of the Company. Any unauthorized alteration, forgery or falsification of the content or appearance of this document is unlawful and offenders may be prosecuted to the fullest extent of the law.

CDMA / EVDO BC0 + BT+ 2.4GHz WLAN Aux

| No. | Conditions | Position | Distance (mm) | Max. WWAN | BT | Max. WLAN Aux | SAR Sum | SPLSR |
|-----|------------|------------------------|---------------|-----------|-------|---------------|---------|---------------------------|
| 40 | EVDO BC 0 | Back side | 0 | 0.54 | 0.094 | 0.111 | 0.745 | ΣSAR<1.6, Not required |
| | | Back side_Curve(Left) | 0 | 0.618 | - | - | - | ΣSAR<1.6, Not required |
| | | Back side_Curve(Right) | 0 | - | 0.094 | - | - | ΣSAR<1.6, Not required |
| | | Top side | 0 | 0.658 | 0.03 | 0.842 | 1.53 | ΣSAR<1.6, Not required |
| | | Bottom side | 0 | 0.07 | 0.4 | 0.007 | 0.477 | ΣSAR<1.6, Not required |
| | | Left side | 0 | 0.771 | 0.4 | 0.003 | 1.174 | ΣSAR<1.6, Not required |
| | | Right side | 0 | 0.007 | 0.094 | 0.007 | 0.108 | ΣSAR<1.6, Not required |

Unless otherwise stated the results shown in this test report refer only to the sample(s) tested and such sample(s) are retained for 90 days only.

除非另有說明，此報告結果僅對測試之樣品負責，同時此樣品僅保留90天。本報告未經本公司書面許可，不可部份複製。

This document is issued by the Company subject to its General Conditions of Service printed overleaf, available on request or accessible at www.sgs.com/terms_and_conditions.htm and, for electronic format documents, subject to Terms and Conditions for Electronic Documents at www.sgs.com/terms_e-document.htm. Attention is drawn to the limitation of liability, indemnification and jurisdiction issues defined therein. Any holder of this document is advised that information contained hereon reflects the Company's findings at the time of its intervention only and within the limits of Client's instructions, if any. The Company's sole responsibility is to its Client and this document does not exonerate parties to a transaction from exercising all their rights and obligations under the transaction documents. This document cannot be reproduced except in full, without prior written approval of the Company. Any unauthorized alteration, forgery or falsification of the content or appearance of this document is unlawful and offenders may be prosecuted to the fullest extent of the law.

CDMA / EVDO BC1 + BT+ 2.4GHz WLAN Aux

| No. | Conditions | Position | Distance (mm) | Max. WWAN | BT | Max. WLAN Aux | SAR Sum | SPLSR |
|-----|------------|------------------------|---------------|-----------|-------|---------------|--------------|--------------------------------|
| 41 | EVDO BC 1 | Back side | 0 | 1.008 | 0.094 | 0.111 | 1.213 | Σ SAR<1.6, Not required |
| | | Back side_Curve(Left) | 0 | 0.973 | - | - | - | Σ SAR<1.6, Not required |
| | | Back side_Curve(Right) | 0 | - | 0.094 | - | - | Σ SAR<1.6, Not required |
| | | Top side | 0 | 0.903 | 0.03 | 0.842 | 1.775 | Analyzed as below |
| | | Bottom side | 0 | 0.025 | 0.4 | 0.007 | 0.432 | Σ SAR<1.6, Not required |
| | | Left side | 0 | 0.341 | 0.4 | 0.003 | 0.744 | Σ SAR<1.6, Not required |
| | | Right side | 0 | 0.004 | 0.094 | 0.007 | 0.105 | Σ SAR<1.6, Not required |

WWAN & BT

| Conditions | Position | SAR Value (W/kg) | Σ SAR (W/kg) | Peak Location Separation Distance (mm) | SPLSR | Simultaneous Transmission SAR Test |
|------------|----------|------------------|---------------------|--|-------|------------------------------------|
| EVDO BC1 | Top side | 0.903 | 0.933 | 185.8 | 0.005 | SPLSR<0.04, Not required |
| BT | | 0.03 | | | | |

BT & WLAN Aux

| Conditions | Position | SAR Value (W/kg) | Σ SAR (W/kg) | Peak Location Separation Distance (mm) | SPLSR | Simultaneous Transmission SAR Test |
|------------|----------|------------------|---------------------|--|-------|------------------------------------|
| BT | Top side | 0.03 | 0.872 | 79 | 0.010 | SPLSR<0.04, Not required |
| WLAN Aux | | 0.842 | | | | |

Unless otherwise stated the results shown in this test report refer only to the sample(s) tested and such sample(s) are retained for 90 days only.

除非另有說明，此報告結果僅對測試之樣品負責，同時此樣品僅保留90天。本報告未經本公司書面許可，不可部份複製。

This document is issued by the Company subject to its General Conditions of Service printed overleaf, available on request or accessible at www.sgs.com/terms_and_conditions.htm and, for electronic format documents, subject to Terms and Conditions for Electronic Documents at www.sgs.com/terms_e-document.htm. Attention is drawn to the limitation of liability, indemnification and jurisdiction issues defined therein. Any holder of this document is advised that information contained hereon reflects the Company's findings at the time of its intervention only and within the limits of Client's instructions, if any. The Company's sole responsibility is to its Client and this document does not exonerate parties to a transaction from exercising all their rights and obligations under the transaction documents. This document cannot be reproduced except in full, without prior written approval of the Company. Any unauthorized alteration, forgery or falsification of the content or appearance of this document is unlawful and offenders may be prosecuted to the fullest extent of the law.

WWAN & WLAN Aux

| Conditions | Position | SAR Value (W/kg) | Coordinates (cm) | | | ΣSAR (W/kg) | Peak Location Separation Distance (mm) | SPLSR | Simultaneous Transmission SAR Test |
|------------|----------|------------------|------------------|-------|-------|-------------|--|-------|------------------------------------|
| | | | x | y | z | | | | |
| EVDO BC 1 | Top side | 0.903 | -0.99 | -8.56 | -0.46 | 1.745 | 89.7 | 0.026 | SPLSR<0.04, Not required |
| WLAN Aux | | 0.842 | -0.74 | 0.58 | -0.73 | | | | |

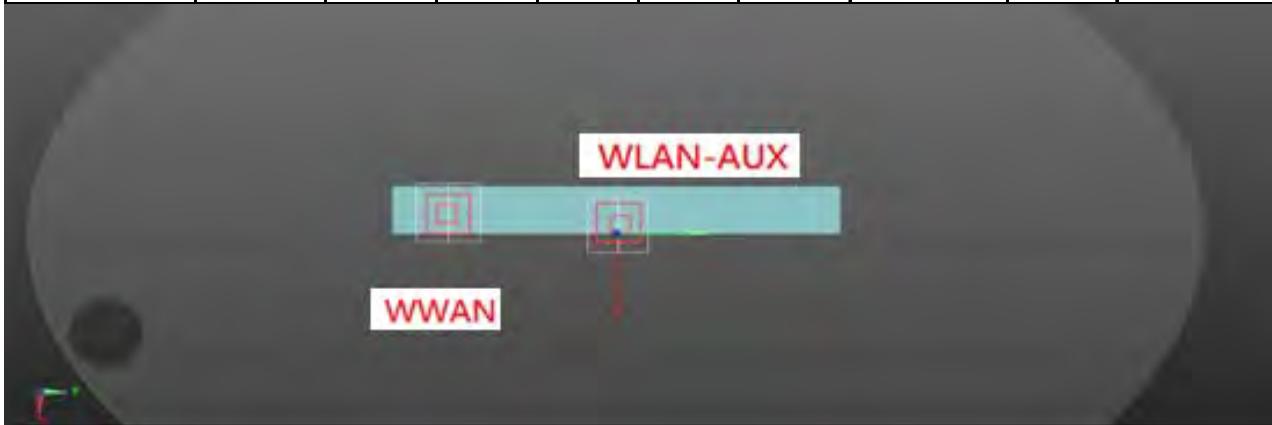

Unless otherwise stated the results shown in this test report refer only to the sample(s) tested and such sample(s) are retained for 90 days only.

除非另有說明，此報告結果僅對測試之樣品負責，同時此樣品僅保留90天。本報告未經本公司書面許可，不可部份複製。

This document is issued by the Company subject to its General Conditions of Service printed overleaf, available on request or accessible at www.sgs.com/terms_and_conditions.htm and, for electronic format documents, subject to Terms and Conditions for Electronic Documents at www.sgs.com/terms_e-document.htm. Attention is drawn to the limitation of liability, indemnification and jurisdiction issues defined therein. Any holder of this document is advised that information contained hereon reflects the Company's findings at the time of its intervention only and within the limits of Client's instructions, if any. The Company's sole responsibility is to its Client and this document does not exonerate parties to a transaction from exercising all their rights and obligations under the transaction documents. This document cannot be reproduced except in full, without prior written approval of the Company. Any unauthorized alteration, forgery or falsification of the content or appearance of this document is unlawful and offenders may be prosecuted to the fullest extent of the law.

CDMA / EVDO BC10 + BT + 2.4GHz WLAN Aux

| No. | Conditions | Position | Distance (mm) | Max. WWAN | BT | Max. WLAN Aux | SAR Sum | SPLSR |
|-----|------------|------------------------|---------------|-----------|-------|---------------|---------|--------------------------------|
| 42 | EVDO BC 10 | Back side | 0 | 0.55 | 0.094 | 0.111 | 0.755 | Σ SAR<1.6, Not required |
| | | Back side_Curve(Left) | 0 | 0.635 | - | - | - | Σ SAR<1.6, Not required |
| | | Back side_Curve(Right) | 0 | - | 0.094 | - | - | Σ SAR<1.6, Not required |
| | | Top side | 0 | 0.582 | 0.03 | 0.842 | 1.454 | Σ SAR<1.6, Not required |
| | | Bottom side | 0 | 0.058 | 0.4 | 0.007 | 0.465 | Σ SAR<1.6, Not required |
| | | Left side | 0 | 0.723 | 0.4 | 0.003 | 1.126 | Σ SAR<1.6, Not required |
| | | Right side | 0 | 0.004 | 0.094 | 0.007 | 0.105 | Σ SAR<1.6, Not required |

Unless otherwise stated the results shown in this test report refer only to the sample(s) tested and such sample(s) are retained for 90 days only.

除非另有說明，此報告結果僅對測試之樣品負責，同時此樣品僅保留90天。本報告未經本公司書面許可，不可部份複製。

This document is issued by the Company subject to its General Conditions of Service printed overleaf, available on request or accessible at www.sgs.com/terms_and_conditions.htm and, for electronic format documents, subject to Terms and Conditions for Electronic Documents at www.sgs.com/terms_e-document.htm. Attention is drawn to the limitation of liability, indemnification and jurisdiction issues defined therein. Any holder of this document is advised that information contained hereon reflects the Company's findings at the time of its intervention only and within the limits of Client's instructions, if any. The Company's sole responsibility is to its Client and this document does not exonerate parties to a transaction from exercising all their rights and obligations under the transaction documents. This document cannot be reproduced except in full, without prior written approval of the Company. Any unauthorized alteration, forgery or falsification of the content or appearance of this document is unlawful and offenders may be prosecuted to the fullest extent of the law.

GPRS 850 + BT + 5GHz WLAN Aux

| No. | Conditions | Position | Distance (mm) | Max. WWAN | BT | Max. WLAN Aux | SAR Sum | SPLSR |
|-----|------------|------------------------|---------------|-----------|-------|---------------|-------------|--------------------------------|
| 43 | 850 | Back side | 0 | 0.866 | 0.094 | 0.212 | 1.172 | Σ SAR<1.6, Not required |
| | | Back side_Curve(Left) | 0 | 0.754 | - | - | - | Σ SAR<1.6, Not required |
| | | Back side_Curve(Right) | 0 | - | 0.094 | - | - | Σ SAR<1.6, Not required |
| | | Top side | 0 | 0.762 | 0.03 | 0.928 | 1.72 | Analyzed as below |
| | | Bottom side | 0 | 0.013 | 0.4 | 0.007 | 0.42 | Σ SAR<1.6, Not required |
| | | Left side | 0 | 1.038 | 0.4 | 0.006 | 1.444 | Σ SAR<1.6, Not required |
| | | Right side | 0 | 0.002 | 0.094 | 0.029 | 0.125 | Σ SAR<1.6, Not required |

WWAN & BT

| Conditions | Position | SAR Value (W/kg) | Σ SAR (W/kg) | Peak Location Separation Distance (mm) | SPLSR | Simultaneous Transmission SAR Test |
|------------|----------|------------------|---------------------|--|-------|------------------------------------|
| GPRS 850 | Top side | 0.762 | 0.792 | 185.8 | 0.004 | SPLSR<0.04, Not required |
| BT | | 0.03 | | | | |

BT & WLAN Aux

| Conditions | Position | SAR Value (W/kg) | Σ SAR (W/kg) | Peak Location Separation Distance (mm) | SPLSR | Simultaneous Transmission SAR Test |
|------------|----------|------------------|---------------------|--|-------|------------------------------------|
| BT | Top side | 0.03 | 0.958 | 79 | 0.012 | SPLSR<0.04, Not required |
| WLAN Aux | | 0.928 | | | | |

Unless otherwise stated the results shown in this test report refer only to the sample(s) tested and such sample(s) are retained for 90 days only.

除非另有說明，此報告結果僅對測試之樣品負責，同時此樣品僅保留90天。本報告未經本公司書面許可，不可部份複製。

This document is issued by the Company subject to its General Conditions of Service printed overleaf, available on request or accessible at www.sgs.com/terms_and_conditions.htm and, for electronic format documents, subject to Terms and Conditions for Electronic Documents at www.sgs.com/terms_e-document.htm. Attention is drawn to the limitation of liability, indemnification and jurisdiction issues defined therein. Any holder of this document is advised that information contained hereon reflects the Company's findings at the time of its intervention only and within the limits of Client's instructions, if any. The Company's sole responsibility is to its Client and this document does not exonerate parties to a transaction from exercising all their rights and obligations under the transaction documents. This document cannot be reproduced except in full, without prior written approval of the Company. Any unauthorized alteration, forgery or falsification of the content or appearance of this document is unlawful and offenders may be prosecuted to the fullest extent of the law.

WWAN & WLAN Aux

| Conditions | Position | SAR Value (W/kg) | Coordinates (cm) | | | Σ SAR (W/kg) | Peak Location Separation Distance (mm) | SPLSR | Simultaneous Transmission SAR Test |
|------------|----------|------------------|------------------|-------|-------|---------------------|--|-------|------------------------------------|
| | | | x | y | z | | | | |
| GPRS 850 | Top side | 0.762 | -0.84 | -4.83 | -0.70 | 1.69 | 58 | 0.038 | SPLSR<0.04, Not required |
| WLAN Aux | | 0.928 | -1.08 | 0.96 | -0.76 | | | | |

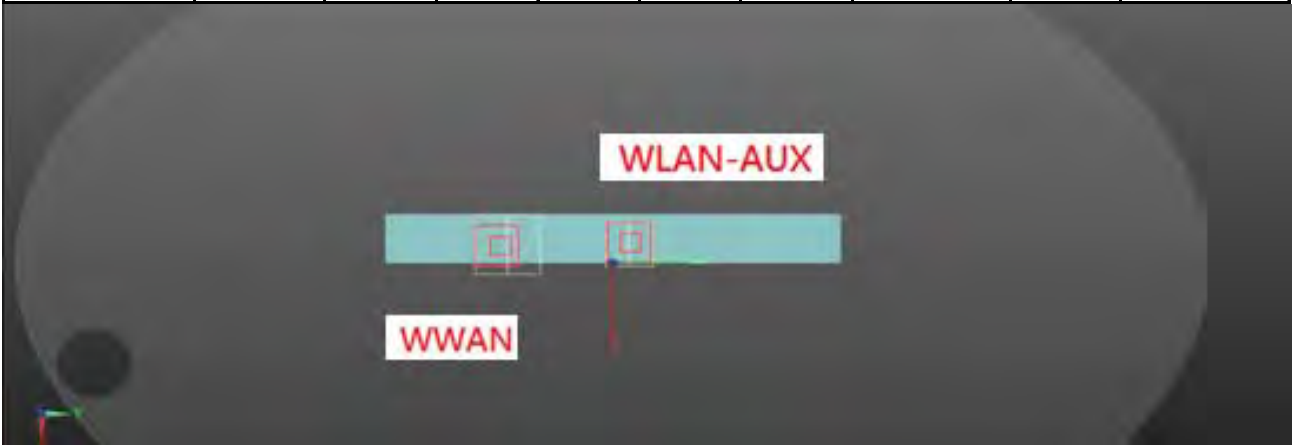

Unless otherwise stated the results shown in this test report refer only to the sample(s) tested and such sample(s) are retained for 90 days only.

除非另有說明，此報告結果僅對測試之樣品負責，同時此樣品僅保留90天。本報告未經本公司書面許可，不可部份複製。

This document is issued by the Company subject to its General Conditions of Service printed overleaf, available on request or accessible at www.sgs.com/terms_and_conditions.htm and, for electronic format documents, subject to Terms and Conditions for Electronic Documents at www.sgs.com/terms_e-document.htm. Attention is drawn to the limitation of liability, indemnification and jurisdiction issues defined therein. Any holder of this document is advised that information contained hereon reflects the Company's findings at the time of its intervention only and within the limits of Client's instructions, if any. The Company's sole responsibility is to its Client and this document does not exonerate parties to a transaction from exercising all their rights and obligations under the transaction documents. This document cannot be reproduced except in full, without prior written approval of the Company. Any unauthorized alteration, forgery or falsification of the content or appearance of this document is unlawful and offenders may be prosecuted to the fullest extent of the law.

GPRS 1900 + BT+ 5GHz WLAN Main

| No. | Conditions | Position | Distance (mm) | Max. WWAN | Max. WLAN Main | Max. WLAN Aux | SAR Sum | SPLSR |
|-----|------------|------------------------|---------------|-----------|----------------|---------------|--------------|--------------------------------|
| 44 | 1900 | Back side | 0 | 1.197 | 0.094 | 0.212 | 1.503 | Σ SAR<1.6, Not required |
| | | Back side_Curve(Left) | 0 | 1.335 | - | - | - | Σ SAR<1.6, Not required |
| | | Back side_Curve(Right) | 0 | - | 0.094 | - | - | Σ SAR<1.6, Not required |
| | | Top side | 0 | 1.144 | 0.03 | 0.928 | 2.102 | Analyzed as below |
| | | Bottom side | 0 | 0.0145 | 0.4 | 0.007 | 0.4215 | Σ SAR<1.6, Not required |
| | | Left side | 0 | 0.287 | 0.4 | 0.006 | 0.693 | Σ SAR<1.6, Not required |
| | | Right side | 0 | 0.0012 | 0.094 | 0.029 | 0.1242 | Σ SAR<1.6, Not required |

WWAN & BT

| Conditions | Position | SAR Value (W/kg) | Σ SAR (W/kg) | Peak Location Separation Distance (mm) | SPLSR | Simultaneous Transmission SAR Test |
|------------|----------|------------------|---------------------|--|-------|------------------------------------|
| GPRS 1900 | Top side | 1.144 | 1.174 | 185.8 | 0.007 | SPLSR<0.04, Not required |
| BT | | 0.03 | | | | |

BT & WLAN Aux

| Conditions | Position | SAR Value (W/kg) | Σ SAR (W/kg) | Peak Location Separation Distance (mm) | SPLSR | Simultaneous Transmission SAR Test |
|------------|----------|------------------|---------------------|--|-------|------------------------------------|
| BT | Top side | 0.03 | 0.958 | 79 | 0.012 | SPLSR<0.04, Not required |
| WLAN Aux | | 0.928 | | | | |

Unless otherwise stated the results shown in this test report refer only to the sample(s) tested and such sample(s) are retained for 90 days only.

除非另有說明，此報告結果僅對測試之樣品負責，同時此樣品僅保留90天。本報告未經本公司書面許可，不可部份複製。

This document is issued by the Company subject to its General Conditions of Service printed overleaf, available on request or accessible at www.sgs.com/terms_and_conditions.htm and, for electronic format documents, subject to Terms and Conditions for Electronic Documents at www.sgs.com/terms_e-document.htm. Attention is drawn to the limitation of liability, indemnification and jurisdiction issues defined therein. Any holder of this document is advised that information contained hereon reflects the Company's findings at the time of its intervention only and within the limits of Client's instructions, if any. The Company's sole responsibility is to its Client and this document does not exonerate parties to a transaction from exercising all their rights and obligations under the transaction documents. This document cannot be reproduced except in full, without prior written approval of the Company. Any unauthorized alteration, forgery or falsification of the content or appearance of this document is unlawful and offenders may be prosecuted to the fullest extent of the law.

WWAN & WLAN Aux

| Conditions | Position | SAR Value (W/kg) | Coordinates (cm) | | | Σ SAR (W/kg) | Peak Location Separation Distance (mm) | SPLSR | Simultaneous Transmission SAR Test |
|------------|----------|------------------|------------------|-------|-------|---------------------|--|-------|------------------------------------|
| | | | x | y | z | | | | |
| GPRS 1900 | Top side | 1.144 | -0.54 | -8.59 | 0.45 | 2.072 | 96.4 | 0.031 | SPLSR<0.04, Not required |
| WLAN Aux | | 0.928 | -1.08 | 0.96 | -0.76 | | | | |



Unless otherwise stated the results shown in this test report refer only to the sample(s) tested and such sample(s) are retained for 90 days only.

除非另有說明，此報告結果僅對測試之樣品負責，同時此樣品僅保留90天。本報告未經本公司書面許可，不可部份複製。

This document is issued by the Company subject to its General Conditions of Service printed overleaf, available on request or accessible at www.sgs.com/terms_and_conditions.htm and, for electronic format documents, subject to Terms and Conditions for Electronic Documents at www.sgs.com/terms_e-document.htm. Attention is drawn to the limitation of liability, indemnification and jurisdiction issues defined therein. Any holder of this document is advised that information contained hereon reflects the Company's findings at the time of its intervention only and within the limits of Client's instructions, if any. The Company's sole responsibility is to its Client and this document does not exonerate parties to a transaction from exercising all their rights and obligations under the transaction documents. This document cannot be reproduced except in full, without prior written approval of the Company. Any unauthorized alteration, forgery or falsification of the content or appearance of this document is unlawful and offenders may be prosecuted to the fullest extent of the law.

SGS Taiwan Ltd.

No.134,Wu Kung Road, New Taipei Industrial Park, Wuku District, New Taipei City, Taiwan 24803/新北市五股區新北產業園區五工路 134 號

台灣檢驗科技股份有限公司

t (886-2) 2299-3279

f (886-2) 2298-0488

www.tw.sgs.com

Member of SGS Group

WCDMA Band II + BT+ 5GHz WLAN Main

| No. | Conditions | Position | Distance (mm) | Max. WWAN | Max. WLAN Main | Max. WLAN Aux | SAR Sum | SPLSR |
|-----|--------------|------------------------|---------------|-----------|----------------|---------------|--------------|--------------------------------|
| 45 | WCDMA Band 2 | Back side | 0 | 0.962 | 0.094 | 0.212 | 1.268 | Σ SAR<1.6, Not required |
| | | Back side_Curve(Left) | 0 | 1.16 | - | - | - | Σ SAR<1.6, Not required |
| | | Back side_Curve(Right) | 0 | - | 0.094 | - | - | Σ SAR<1.6, Not required |
| | | Top side | 0 | 1.033 | 0.03 | 0.928 | 1.991 | Analyzed as below |
| | | Bottom side | 0 | 0.016 | 0.4 | 0.007 | 0.423 | Σ SAR<1.6, Not required |
| | | Left side | 0 | 0.299 | 0.4 | 0.006 | 0.705 | Σ SAR<1.6, Not required |
| | | Right side | 0 | 0.002 | 0.094 | 0.029 | 0.125 | Σ SAR<1.6, Not required |

WWAN & BT

| Conditions | Position | SAR Value (W/kg) | Σ SAR (W/kg) | Peak Location Separation Distance (mm) | SPLSR | Simultaneous Transmission SAR Test |
|------------|----------|------------------|---------------------|--|-------|------------------------------------|
| WCDMA B2 | Top side | 1.033 | 1.063 | 85.8 | 0.013 | SPLSR<0.04, Not required |
| BT | | 0.03 | | | | |

BT & WLAN Aux

| Conditions | Position | SAR Value (W/kg) | Σ SAR (W/kg) | Peak Location Separation Distance (mm) | SPLSR | Simultaneous Transmission SAR Test |
|------------|----------|------------------|---------------------|--|-------|------------------------------------|
| BT | Top side | 0.03 | 0.958 | 79 | 0.012 | SPLSR<0.04, Not required |
| WLAN Aux | | 0.928 | | | | |

Unless otherwise stated the results shown in this test report refer only to the sample(s) tested and such sample(s) are retained for 90 days only.

除非另有說明，此報告結果僅對測試之樣品負責，同時此樣品僅保留90天。本報告未經本公司書面許可，不可部份複製。

This document is issued by the Company subject to its General Conditions of Service printed overleaf, available on request or accessible at www.sgs.com/terms_and_conditions.htm and, for electronic format documents, subject to Terms and Conditions for Electronic Documents at www.sgs.com/terms_e-document.htm. Attention is drawn to the limitation of liability, indemnification and jurisdiction issues defined therein. Any holder of this document is advised that information contained hereon reflects the Company's findings at the time of its intervention only and within the limits of Client's instructions, if any. The Company's sole responsibility is to its Client and this document does not exonerate parties to a transaction from exercising all their rights and obligations under the transaction documents. This document cannot be reproduced except in full, without prior written approval of the Company. Any unauthorized alteration, forgery or falsification of the content or appearance of this document is unlawful and offenders may be prosecuted to the fullest extent of the law.

WWAN & WLAN Aux

| Conditions | Position | SAR Value (W/kg) | Coordinates (cm) | | | ΣSAR (W/kg) | Peak Location Separation Distance (mm) | SPLSR | Simultaneous Transmission SAR Test |
|------------|----------|------------------|------------------|-------|-------|-------------|--|-------|------------------------------------|
| | | | x | y | z | | | | |
| WCDMA B2 | Top side | 1.033 | -1.00 | -8.00 | 0.45 | 1.961 | 90.4 | 0.030 | SPLSR<0.04, Not required |
| WLAN Aux | | 0.928 | -1.08 | 0.96 | -0.76 | | | | |

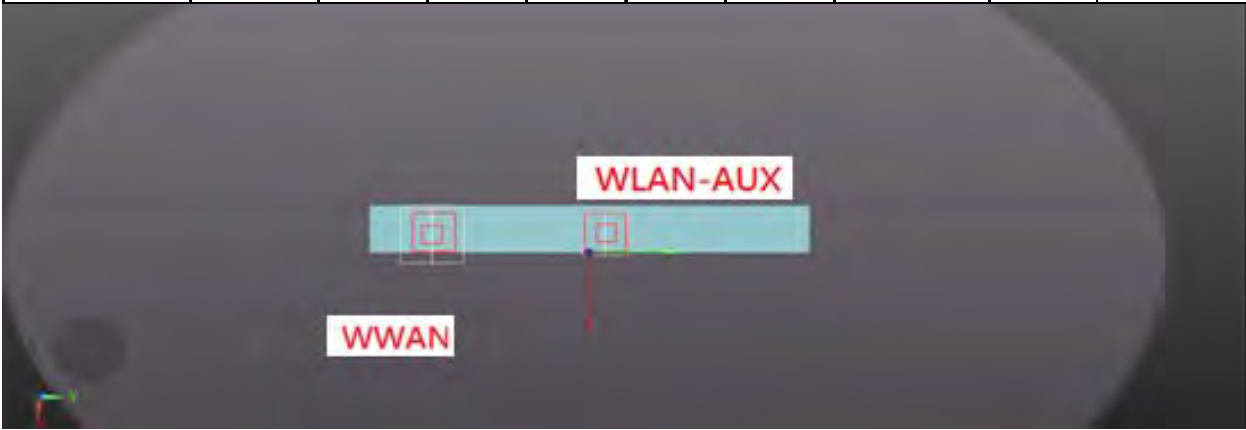

Unless otherwise stated the results shown in this test report refer only to the sample(s) tested and such sample(s) are retained for 90 days only.

除非另有說明，此報告結果僅對測試之樣品負責，同時此樣品僅保留90天。本報告未經本公司書面許可，不可部份複製。

This document is issued by the Company subject to its General Conditions of Service printed overleaf, available on request or accessible at www.sgs.com/terms_and_conditions.htm and, for electronic format documents, subject to Terms and Conditions for Electronic Documents at www.sgs.com/terms_e-document.htm. Attention is drawn to the limitation of liability, indemnification and jurisdiction issues defined therein. Any holder of this document is advised that information contained hereon reflects the Company's findings at the time of its intervention only and within the limits of Client's instructions, if any. The Company's sole responsibility is to its Client and this document does not exonerate parties to a transaction from exercising all their rights and obligations under the transaction documents. This document cannot be reproduced except in full, without prior written approval of the Company. Any unauthorized alteration, forgery or falsification of the content or appearance of this document is unlawful and offenders may be prosecuted to the fullest extent of the law.

WCDMA Band IV + BT + 5GHz WLAN Main

| No. | Conditions | Position | Distance (mm) | Max. WWAN | Max. WLAN Main | Max. WLAN Aux | SAR Sum | SPLSR |
|-----|--------------|------------------------|---------------|-----------|----------------|---------------|--------------|--------------------------------|
| 46 | WCDMA Band 4 | Back side | 0 | 0.999 | 0.094 | 0.212 | 1.305 | Σ SAR<1.6, Not required |
| | | Back side_Curve(Left) | 0 | 1.131 | - | - | - | Σ SAR<1.6, Not required |
| | | Back side_Curve(Right) | 0 | - | 0.094 | - | - | Σ SAR<1.6, Not required |
| | | Top side | 0 | 1.049 | 0.03 | 0.928 | 2.007 | Analyzed as below |
| | | Bottom side | 0 | 0.0235 | 0.4 | 0.007 | 0.4305 | Σ SAR<1.6, Not required |
| | | Left side | 0 | 0.532 | 0.4 | 0.006 | 0.938 | Σ SAR<1.6, Not required |
| | | Right side | 0 | 0.0042 | 0.094 | 0.029 | 0.1272 | Σ SAR<1.6, Not required |

WWAN & BT

| Conditions | Position | SAR Value (W/kg) | Σ SAR (W/kg) | Peak Location Separation Distance (mm) | SPLSR | Simultaneous Transmission SAR Test |
|------------|----------|------------------|---------------------|--|-------|------------------------------------|
| WCDMA B4 | Top side | 1.049 | 1.079 | 185.8 | 0.006 | SPLSR<0.04, Not required |
| BT | | 0.03 | | | | |

BT & WLAN Aux

| Conditions | Position | SAR Value (W/kg) | Σ SAR (W/kg) | Peak Location Separation Distance (mm) | SPLSR | Simultaneous Transmission SAR Test |
|------------|----------|------------------|---------------------|--|-------|------------------------------------|
| BT | Top side | 0.03 | 0.958 | 79 | 0.012 | SPLSR<0.04, Not required |
| WLAN Aux | | 0.928 | | | | |

Unless otherwise stated the results shown in this test report refer only to the sample(s) tested and such sample(s) are retained for 90 days only.

除非另有說明，此報告結果僅對測試之樣品負責，同時此樣品僅保留90天。本報告未經本公司書面許可，不可部份複製。

This document is issued by the Company subject to its General Conditions of Service printed overleaf, available on request or accessible at www.sgs.com/terms_and_conditions.htm and, for electronic format documents, subject to Terms and Conditions for Electronic Documents at www.sgs.com/terms_e-document.htm. Attention is drawn to the limitation of liability, indemnification and jurisdiction issues defined therein. Any holder of this document is advised that information contained hereon reflects the Company's findings at the time of its intervention only and within the limits of Client's instructions, if any. The Company's sole responsibility is to its Client and this document does not exonerate parties to a transaction from exercising all their rights and obligations under the transaction documents. This document cannot be reproduced except in full, without prior written approval of the Company. Any unauthorized alteration, forgery or falsification of the content or appearance of this document is unlawful and offenders may be prosecuted to the fullest extent of the law.

WWAN & WLAN Aux

| Conditions | Position | SAR Value (W/kg) | Coordinates (cm) | | | Σ SAR (W/kg) | Peak Location Separation Distance (mm) | SPLSR | Simultaneous Transmission SAR Test |
|------------|----------|------------------|------------------|-------|-------|---------------------|--|-------|------------------------------------|
| | | | x | y | z | | | | |
| WCDMA B4 | Top side | 1.049 | -0.84 | -8.59 | -0.50 | 1.977 | 95.6 | 0.029 | SPLSR<0.04, Not required |
| WLAN Aux | | 0.928 | -1.08 | 0.96 | -0.76 | | | | |

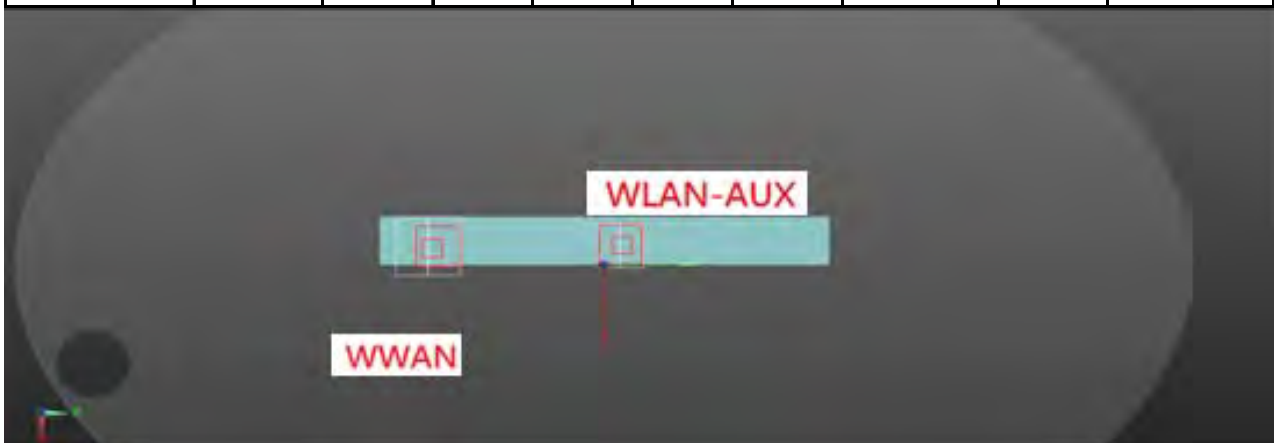

Unless otherwise stated the results shown in this test report refer only to the sample(s) tested and such sample(s) are retained for 90 days only.

除非另有說明，此報告結果僅對測試之樣品負責，同時此樣品僅保留90天。本報告未經本公司書面許可，不可部份複製。

This document is issued by the Company subject to its General Conditions of Service printed overleaf, available on request or accessible at www.sgs.com/terms_and_conditions.htm and, for electronic format documents, subject to Terms and Conditions for Electronic Documents at www.sgs.com/terms_e-document.htm. Attention is drawn to the limitation of liability, indemnification and jurisdiction issues defined therein. Any holder of this document is advised that information contained hereon reflects the Company's findings at the time of its intervention only and within the limits of Client's instructions, if any. The Company's sole responsibility is to its Client and this document does not exonerate parties to a transaction from exercising all their rights and obligations under the transaction documents. This document cannot be reproduced except in full, without prior written approval of the Company. Any unauthorized alteration, forgery or falsification of the content or appearance of this document is unlawful and offenders may be prosecuted to the fullest extent of the law.

WCDMA Band V + BT+ 5GHz WLAN Main

| No. | Conditions | Position | Distance (mm) | Max. WWAN | Max. WLAN Main | Max. WLAN Aux | SAR Sum | SPLSR |
|-----|--------------|------------------------|---------------|-----------|----------------|---------------|---------|--------------------------------|
| 47 | WCDMA Band 5 | Back side | 0 | 0.407 | 0.094 | 0.212 | 0.713 | Σ SAR<1.6, Not required |
| | | Back side_Curve(Left) | 0 | 0.402 | - | - | - | Σ SAR<1.6, Not required |
| | | Back side_Curve(Right) | 0 | - | 0.094 | - | - | Σ SAR<1.6, Not required |
| | | Top side | 0 | 0.391 | 0.03 | 0.928 | 1.349 | Analyzed as below |
| | | Bottom side | 0 | 0.035 | 0.4 | 0.007 | 0.442 | Σ SAR<1.6, Not required |
| | | Left side | 0 | 0.615 | 0.4 | 0.006 | 1.021 | Σ SAR<1.6, Not required |
| | | Right side | 0 | 0.003 | 0.094 | 0.029 | 0.126 | Σ SAR<1.6, Not required |

Unless otherwise stated the results shown in this test report refer only to the sample(s) tested and such sample(s) are retained for 90 days only.

除非另有說明，此報告結果僅對測試之樣品負責，同時此樣品僅保留90天。本報告未經本公司書面許可，不可部份複製。

This document is issued by the Company subject to its General Conditions of Service printed overleaf, available on request or accessible at www.sgs.com/terms_and_conditions.htm and, for electronic format documents, subject to Terms and Conditions for Electronic Documents at www.sgs.com/terms_e-document.htm. Attention is drawn to the limitation of liability, indemnification and jurisdiction issues defined therein. Any holder of this document is advised that information contained hereon reflects the Company's findings at the time of its intervention only and within the limits of Client's instructions, if any. The Company's sole responsibility is to its Client and this document does not exonerate parties to a transaction from exercising all their rights and obligations under the transaction documents. This document cannot be reproduced except in full, without prior written approval of the Company. Any unauthorized alteration, forgery or falsification of the content or appearance of this document is unlawful and offenders may be prosecuted to the fullest extent of the law.

LTE FDD Band II + BT+ 5GHz WLAN Aux

| No. | Conditions | Position | Distance (mm) | Max. WWAN | Max. WLAN Main | Max. WLAN Aux | SAR Sum | SPLSR |
|-----|------------|------------------------|---------------|-----------|----------------|---------------|--------------|--------------------------------|
| 48 | LTE Band 2 | Back side | 0 | 1.062 | 0.094 | 0.212 | 1.368 | Σ SAR<1.6, Not required |
| | | Back side_Curve(Left) | 0 | 1.086 | - | - | - | Σ SAR<1.6, Not required |
| | | Back side_Curve(Right) | 0 | - | 0.094 | - | - | Σ SAR<1.6, Not required |
| | | Top side | 0 | 1.09 | 0.03 | 0.928 | 2.048 | Analyzed as below |
| | | Bottom side | 0 | 0.041 | 0.4 | 0.007 | 0.448 | Σ SAR<1.6, Not required |
| | | Left side | 0 | 0.281 | 0.4 | 0.006 | 0.687 | Σ SAR<1.6, Not required |
| | | Right side | 0 | 0.027 | 0.094 | 0.029 | 0.15 | Σ SAR<1.6, Not required |

WWAN & BT

| Conditions | Position | SAR Value (W/kg) | Σ SAR (W/kg) | Peak Location Separation Distance (mm) | SPLSR | Simultaneous Transmission SAR Test |
|------------|----------|------------------|---------------------|--|-------|------------------------------------|
| LTE Band 2 | Top side | 1.09 | 1.12 | 185.8 | 0.006 | SPLSR<0.04, Not required |
| BT | | 0.03 | | | | |

BT & WLAN Aux

| Conditions | Position | SAR Value (W/kg) | Σ SAR (W/kg) | Peak Location Separation Distance (mm) | SPLSR | Simultaneous Transmission SAR Test |
|------------|----------|------------------|---------------------|--|-------|------------------------------------|
| BT | Top side | 0.03 | 0.958 | 79 | 0.012 | SPLSR<0.04, Not required |
| WLAN Aux | | 0.928 | | | | |

Unless otherwise stated the results shown in this test report refer only to the sample(s) tested and such sample(s) are retained for 90 days only.

除非另有說明，此報告結果僅對測試之樣品負責，同時此樣品僅保留90天。本報告未經本公司書面許可，不可部份複製。

This document is issued by the Company subject to its General Conditions of Service printed overleaf, available on request or accessible at www.sgs.com/terms_and_conditions.htm and, for electronic format documents, subject to Terms and Conditions for Electronic Documents at www.sgs.com/terms_e-document.htm. Attention is drawn to the limitation of liability, indemnification and jurisdiction issues defined therein. Any holder of this document is advised that information contained hereon reflects the Company's findings at the time of its intervention only and within the limits of Client's instructions, if any. The Company's sole responsibility is to its Client and this document does not exonerate parties to a transaction from exercising all their rights and obligations under the transaction documents. This document cannot be reproduced except in full, without prior written approval of the Company. Any unauthorized alteration, forgery or falsification of the content or appearance of this document is unlawful and offenders may be prosecuted to the fullest extent of the law.

WWAN & WLAN Aux

| Conditions | Position | SAR Value (W/kg) | Coordinates (cm) | | | Σ SAR (W/kg) | Peak Location Separation Distance (mm) | SPLSR | Simultaneous Transmission SAR Test |
|------------|----------|------------------|------------------|-------|-------|---------------------|--|-------|------------------------------------|
| | | | x | y | z | | | | |
| LTE Band 2 | Top side | 1.09 | -1.30 | -8.16 | 0.45 | 2.018 | 92 | 0.031 | SPLSR<0.04, Not required |
| WLAN Aux | | 0.928 | -1.08 | 0.96 | -0.76 | | | | |



Unless otherwise stated the results shown in this test report refer only to the sample(s) tested and such sample(s) are retained for 90 days only.

除非另有說明，此報告結果僅對測試之樣品負責，同時此樣品僅保留90天。本報告未經本公司書面許可，不可部份複製。

This document is issued by the Company subject to its General Conditions of Service printed overleaf, available on request or accessible at www.sgs.com/terms_and_conditions.htm and, for electronic format documents, subject to Terms and Conditions for Electronic Documents at www.sgs.com/terms_e-document.htm. Attention is drawn to the limitation of liability, indemnification and jurisdiction issues defined therein. Any holder of this document is advised that information contained hereon reflects the Company's findings at the time of its intervention only and within the limits of Client's instructions, if any. The Company's sole responsibility is to its Client and this document does not exonerate parties to a transaction from exercising all their rights and obligations under the transaction documents. This document cannot be reproduced except in full, without prior written approval of the Company. Any unauthorized alteration, forgery or falsification of the content or appearance of this document is unlawful and offenders may be prosecuted to the fullest extent of the law.

LTE FDD Band IV + BT + 5GHz WLAN Aux

| No. | Conditions | Position | Distance (mm) | Max. WWAN | Max. WLAN Main | Max. WLAN Aux | SAR Sum | SPLSR |
|-----|------------|------------------------|---------------|-----------|----------------|---------------|--------------|--------------------------------|
| 49 | LTE Band 4 | Back side | 0 | 1.193 | 0.094 | 0.212 | 1.499 | Σ SAR<1.6, Not required |
| | | Back side_Curve(Left) | 0 | 1.154 | - | - | - | Σ SAR<1.6, Not required |
| | | Back side_Curve(Right) | 0 | - | 0.094 | - | - | Σ SAR<1.6, Not required |
| | | Top side | 0 | 1.069 | 0.03 | 0.928 | 2.027 | Analyzed as below |
| | | Bottom side | 0 | 0.044 | 0.4 | 0.007 | 0.451 | Σ SAR<1.6, Not required |
| | | Left side | 0 | 0.543 | 0.4 | 0.006 | 0.949 | Σ SAR<1.6, Not required |
| | | Right side | 0 | 0.007 | 0.094 | 0.029 | 0.13 | Σ SAR<1.6, Not required |

WWAN & BT

| Conditions | Position | SAR Value (W/kg) | Σ SAR (W/kg) | Peak Location Separation Distance (mm) | SPLSR | Simultaneous Transmission SAR Test |
|------------|----------|------------------|---------------------|--|-------|------------------------------------|
| LTE Band 4 | Top side | 1.069 | 1.099 | 185.8 | 0.006 | SPLSR<0.04, Not required |
| BT | | 0.03 | | | | |

BT & WLAN Aux

| Conditions | Position | SAR Value (W/kg) | Σ SAR (W/kg) | Peak Location Separation Distance (mm) | SPLSR | Simultaneous Transmission SAR Test |
|------------|----------|------------------|---------------------|--|-------|------------------------------------|
| BT | Top side | 0.03 | 0.958 | 79 | 0.012 | SPLSR<0.04, Not required |
| WLAN Aux | | 0.928 | | | | |

Unless otherwise stated the results shown in this test report refer only to the sample(s) tested and such sample(s) are retained for 90 days only.

除非另有說明，此報告結果僅對測試之樣品負責，同時此樣品僅保留90天。本報告未經本公司書面許可，不可部份複製。

This document is issued by the Company subject to its General Conditions of Service printed overleaf, available on request or accessible at www.sgs.com/terms_and_conditions.htm and, for electronic format documents, subject to Terms and Conditions for Electronic Documents at www.sgs.com/terms_e-document.htm. Attention is drawn to the limitation of liability, indemnification and jurisdiction issues defined therein. Any holder of this document is advised that information contained hereon reflects the Company's findings at the time of its intervention only and within the limits of Client's instructions, if any. The Company's sole responsibility is to its Client and this document does not exonerate parties to a transaction from exercising all their rights and obligations under the transaction documents. This document cannot be reproduced except in full, without prior written approval of the Company. Any unauthorized alteration, forgery or falsification of the content or appearance of this document is unlawful and offenders may be prosecuted to the fullest extent of the law.

WWAN & WLAN Aux

| Conditions | Position | SAR Value (W/kg) | Coordinates (cm) | | | ΣSAR (W/kg) | Peak Location Separation Distance (mm) | SPLSR | Simultaneous Transmission SAR Test |
|------------|----------|------------------|------------------|-------|-------|-------------|--|-------|------------------------------------|
| | | | x | y | z | | | | |
| LTE Band 4 | Top side | 1.069 | -1.35 | -8.34 | -0.48 | 1.997 | 93.1 | 0.030 | SPLSR<0.04, Not required |
| WLAN Aux | | 0.928 | -1.08 | 0.96 | -0.76 | | | | |

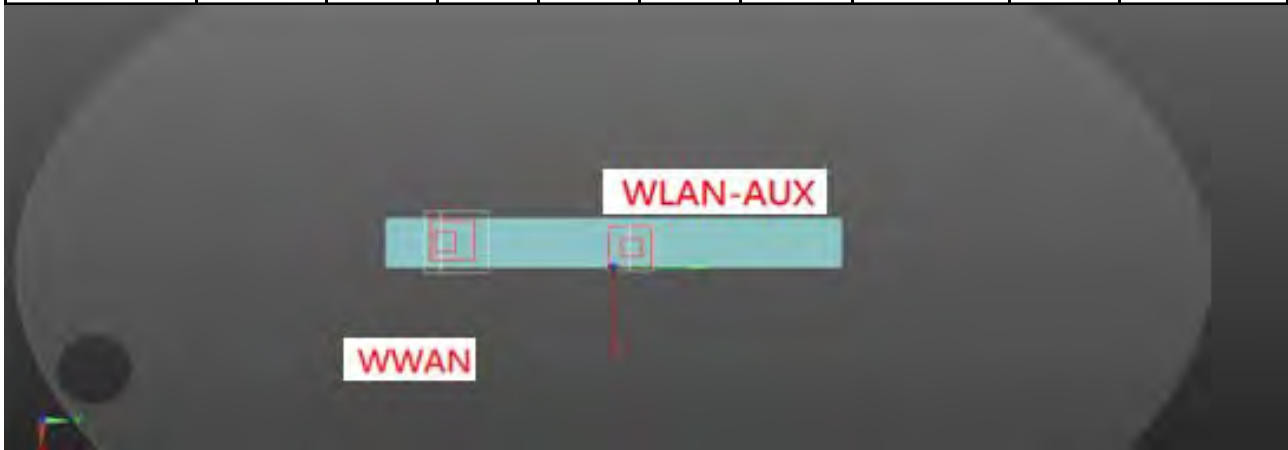

Unless otherwise stated the results shown in this test report refer only to the sample(s) tested and such sample(s) are retained for 90 days only.

除非另有說明，此報告結果僅對測試之樣品負責，同時此樣品僅保留90天。本報告未經本公司書面許可，不可部份複製。

This document is issued by the Company subject to its General Conditions of Service printed overleaf, available on request or accessible at www.sgs.com/terms_and_conditions.htm and, for electronic format documents, subject to Terms and Conditions for Electronic Documents at www.sgs.com/terms_e-document.htm. Attention is drawn to the limitation of liability, indemnification and jurisdiction issues defined therein. Any holder of this document is advised that information contained hereon reflects the Company's findings at the time of its intervention only and within the limits of Client's instructions, if any. The Company's sole responsibility is to its Client and this document does not exonerate parties to a transaction from exercising all their rights and obligations under the transaction documents. This document cannot be reproduced except in full, without prior written approval of the Company. Any unauthorized alteration, forgery or falsification of the content or appearance of this document is unlawful and offenders may be prosecuted to the fullest extent of the law.

LTE FDD Band V + BT + 5GHz WLAN Aux

| No. | Conditions | Position | Distance (mm) | Max. WWAN | BT | Max. WLAN Aux | SAR Sum | SPLSR |
|-----|------------|------------------------|---------------|-----------|-------|---------------|---------|------------------------|
| 50 | LTE Band 5 | Back side | 0 | 0.491 | 0.094 | 0.212 | 0.797 | ΣSAR<1.6, Not required |
| | | Back side_Curve(Left) | 0 | 0.58 | - | - | - | ΣSAR<1.6, Not required |
| | | Back side_Curve(Right) | 0 | - | 0.094 | - | - | ΣSAR<1.6, Not required |
| | | Top side | 0 | 0.576 | 0.03 | 0.928 | 1.534 | ΣSAR<1.6, Not required |
| | | Bottom side | 0 | 0.076 | 0.4 | 0.007 | 0.483 | ΣSAR<1.6, Not required |
| | | Left side | 0 | 0.601 | 0.4 | 0.006 | 1.007 | ΣSAR<1.6, Not required |
| | | Right side | 0 | 0.014 | 0.094 | 0.029 | 0.137 | ΣSAR<1.6, Not required |

LTE FDD Band XIII + BT + 5GHz WLAN Aux

| No. | Conditions | Position | Distance (mm) | Max. WWAN | BT | Max. WLAN Aux | SAR Sum | SPLSR |
|-----|-------------|------------------------|---------------|-----------|-------|---------------|---------|------------------------|
| 51 | LTE Band 13 | Back side | 0 | 0.468 | 0.094 | 0.212 | 0.774 | ΣSAR<1.6, Not required |
| | | Back side_Curve(Left) | 0 | 0.486 | - | - | - | ΣSAR<1.6, Not required |
| | | Back side_Curve(Right) | 0 | - | 0.094 | - | - | ΣSAR<1.6, Not required |
| | | Top side | 0 | 0.549 | 0.03 | 0.928 | 1.507 | ΣSAR<1.6, Not required |
| | | Bottom side | 0 | 0.093 | 0.4 | 0.007 | 0.5 | ΣSAR<1.6, Not required |
| | | Left side | 0 | 0.837 | 0.4 | 0.006 | 1.243 | ΣSAR<1.6, Not required |
| | | Right side | 0 | 0.01 | 0.094 | 0.029 | 0.133 | ΣSAR<1.6, Not required |

Unless otherwise stated the results shown in this test report refer only to the sample(s) tested and such sample(s) are retained for 90 days only.

除非另有說明，此報告結果僅對測試之樣品負責，同時此樣品僅保留90天。本報告未經本公司書面許可，不可部份複製。

This document is issued by the Company subject to its General Conditions of Service printed overleaf, available on request or accessible at www.sgs.com/terms_and_conditions.htm and, for electronic format documents, subject to Terms and Conditions for Electronic Documents at www.sgs.com/terms_e-document.htm. Attention is drawn to the limitation of liability, indemnification and jurisdiction issues defined therein. Any holder of this document is advised that information contained hereon reflects the Company's findings at the time of its intervention only and within the limits of Client's instructions, if any. The Company's sole responsibility is to its Client and this document does not exonerate parties to a transaction from exercising all their rights and obligations under the transaction documents. This document cannot be reproduced except in full, without prior written approval of the Company. Any unauthorized alteration, forgery or falsification of the content or appearance of this document is unlawful and offenders may be prosecuted to the fullest extent of the law.

LTE FDD Band XVII + BT + 5GHz WLAN Aux

| No. | Conditions | Position | Distance (mm) | Max. WWAN | BT | Max. WLAN Aux | SAR Sum | SPLSR |
|-----|-------------|------------------------|---------------|-----------|-------|---------------|---------|------------------------|
| 52 | LTE Band 17 | Back side | 0 | 0.264 | 0.094 | 0.212 | 0.57 | ΣSAR<1.6, Not required |
| | | Back side_Curve(Left) | 0 | 0.296 | - | - | - | ΣSAR<1.6, Not required |
| | | Back side_Curve(Right) | 0 | - | 0.094 | - | - | ΣSAR<1.6, Not required |
| | | Top side | 0 | 0.223 | 0.03 | 0.928 | 1.181 | ΣSAR<1.6, Not required |
| | | Bottom side | 0 | 0.009 | 0.4 | 0.007 | 0.416 | ΣSAR<1.6, Not required |
| | | Left side | 0 | 0.438 | 0.4 | 0.006 | 0.844 | ΣSAR<1.6, Not required |
| | | Right side | 0 | 0.005 | 0.094 | 0.029 | 0.128 | ΣSAR<1.6, Not required |

Unless otherwise stated the results shown in this test report refer only to the sample(s) tested and such sample(s) are retained for 90 days only.

除非另有說明，此報告結果僅對測試之樣品負責，同時此樣品僅保留90天。本報告未經本公司書面許可，不可部份複製。

This document is issued by the Company subject to its General Conditions of Service printed overleaf, available on request or accessible at www.sgs.com/terms_and_conditions.htm and, for electronic format documents, subject to Terms and Conditions for Electronic Documents at www.sgs.com/terms_e-document.htm. Attention is drawn to the limitation of liability, indemnification and jurisdiction issues defined therein. Any holder of this document is advised that information contained hereon reflects the Company's findings at the time of its intervention only and within the limits of Client's instructions, if any. The Company's sole responsibility is to its Client and this document does not exonerate parties to a transaction from exercising all their rights and obligations under the transaction documents. This document cannot be reproduced except in full, without prior written approval of the Company. Any unauthorized alteration, forgery or falsification of the content or appearance of this document is unlawful and offenders may be prosecuted to the fullest extent of the law.

LTE FDD Band XXV+ BT+ 5GHz WLAN Aux

| No. | Conditions | Position | Distance (mm) | Max. WWAN | BT | Max. WLAN Aux | SAR Sum | SPLSR |
|-----|-------------|------------------------|---------------|-----------|-------|---------------|--------------|--------------------------------|
| 53 | LTE Band 25 | Back side | 0 | 1.151 | 0.094 | 0.212 | 1.457 | Σ SAR<1.6, Not required |
| | | Back side_Curve(Left) | 0 | 0.979 | - | - | - | Σ SAR<1.6, Not required |
| | | Back side_Curve(Right) | 0 | - | 0.094 | - | - | Σ SAR<1.6, Not required |
| | | Top side | 0 | 1.136 | 0.03 | 0.928 | 2.094 | Σ SAR<1.6, Not required |
| | | Bottom side | 0 | 0.026 | 0.4 | 0.007 | 0.433 | Σ SAR<1.6, Not required |
| | | Left side | 0 | 0.375 | 0.4 | 0.006 | 0.781 | Σ SAR<1.6, Not required |
| | | Right side | 0 | 0.007 | 0.094 | 0.029 | 0.13 | Σ SAR<1.6, Not required |

WWAN & BT

| Conditions | Position | SAR Value (W/kg) | Σ SAR (W/kg) | Peak Location Separation Distance (mm) | SPLSR | Simultaneous Transmission SAR Test |
|-------------|----------|------------------|---------------------|--|-------|------------------------------------|
| LTE Band 25 | Top side | 1.159 | 1.189 | 185.8 | 0.007 | SPLSR<0.04, Not required |
| BT | | 0.03 | | | | |

BT & WLAN Aux

| Conditions | Position | SAR Value (W/kg) | Σ SAR (W/kg) | Peak Location Separation Distance (mm) | SPLSR | Simultaneous Transmission SAR Test |
|------------|----------|------------------|---------------------|--|-------|------------------------------------|
| BT | Top side | 0.03 | 0.958 | 79 | 0.012 | SPLSR<0.04, Not required |
| WLAN Aux | | 0.928 | | | | |

Unless otherwise stated the results shown in this test report refer only to the sample(s) tested and such sample(s) are retained for 90 days only.

除非另有說明，此報告結果僅對測試之樣品負責，同時此樣品僅保留90天。本報告未經本公司書面許可，不可部份複製。

This document is issued by the Company subject to its General Conditions of Service printed overleaf, available on request or accessible at www.sgs.com/terms_and_conditions.htm and, for electronic format documents, subject to Terms and Conditions for Electronic Documents at www.sgs.com/terms_e-document.htm. Attention is drawn to the limitation of liability, indemnification and jurisdiction issues defined therein. Any holder of this document is advised that information contained hereon reflects the Company's findings at the time of its intervention only and within the limits of Client's instructions, if any. The Company's sole responsibility is to its Client and this document does not exonerate parties to a transaction from exercising all their rights and obligations under the transaction documents. This document cannot be reproduced except in full, without prior written approval of the Company. Any unauthorized alteration, forgery or falsification of the content or appearance of this document is unlawful and offenders may be prosecuted to the fullest extent of the law.

WWAN & WLAN Aux

| Conditions | Position | SAR Value (W/kg) | Coordinates (cm) | | | ΣSAR (W/kg) | Peak Location Separation Distance (mm) | SPLSR | Simultaneous Transmission SAR Test |
|-------------|----------|------------------|------------------|-------|-------|-------------|--|-------|------------------------------------|
| | | | x | y | z | | | | |
| LTE Band 25 | Top side | 1.159 | -1.14 | -8.47 | 0.51 | 2.087 | 95.1 | 0.032 | SPLSR<0.04, Not required |
| WLAN Aux | | 0.928 | -1.08 | 0.96 | -0.76 | | | | |

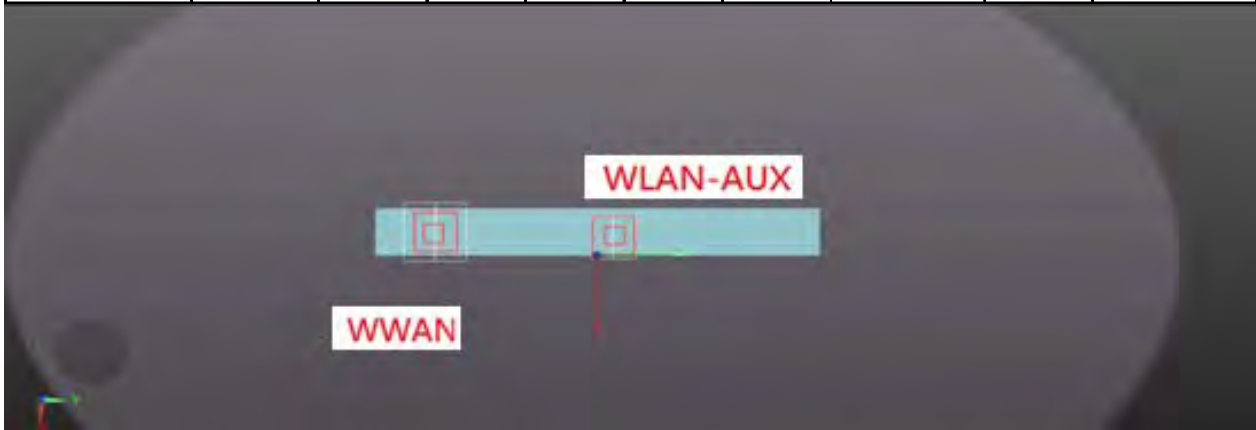

Unless otherwise stated the results shown in this test report refer only to the sample(s) tested and such sample(s) are retained for 90 days only.

除非另有說明，此報告結果僅對測試之樣品負責，同時此樣品僅保留90天。本報告未經本公司書面許可，不可部份複製。

This document is issued by the Company subject to its General Conditions of Service printed overleaf, available on request or accessible at www.sgs.com/terms_and_conditions.htm and, for electronic format documents, subject to Terms and Conditions for Electronic Documents at www.sgs.com/terms_e-document.htm. Attention is drawn to the limitation of liability, indemnification and jurisdiction issues defined therein. Any holder of this document is advised that information contained hereon reflects the Company's findings at the time of its intervention only and within the limits of Client's instructions, if any. The Company's sole responsibility is to its Client and this document does not exonerate parties to a transaction from exercising all their rights and obligations under the transaction documents. This document cannot be reproduced except in full, without prior written approval of the Company. Any unauthorized alteration, forgery or falsification of the content or appearance of this document is unlawful and offenders may be prosecuted to the fullest extent of the law.

CDMA / EVDO BC0 + BT+ 5GHz WLAN Main

| No. | Conditions | Position | Distance (mm) | Max. WWAN | BT | Max. WLAN Aux | SAR Sum | SPLSR |
|-----|------------|------------------------|---------------|-----------|-------|---------------|--------------|------------------------|
| 54 | EVDO BC 0 | Back side | 0 | 0.54 | 0.094 | 0.212 | 0.846 | ΣSAR<1.6, Not required |
| | | Back side_Curve(Left) | 0 | 0.618 | - | - | - | ΣSAR<1.6, Not required |
| | | Back side_Curve(Right) | 0 | - | 0.094 | - | - | ΣSAR<1.6, Not required |
| | | Top side | 0 | 0.658 | 0.03 | 0.928 | 1.616 | ΣSAR<1.6, Not required |
| | | Bottom side | 0 | 0.07 | 0.4 | 0.007 | 0.477 | ΣSAR<1.6, Not required |
| | | Left side | 0 | 0.771 | 0.4 | 0.006 | 1.177 | ΣSAR<1.6, Not required |
| | | Right side | 0 | 0.007 | 0.094 | 0.029 | 0.13 | ΣSAR<1.6, Not required |

WWAN & BT

| Conditions | Position | SAR Value (W/kg) | ΣSAR (W/kg) | Peak Location Separation Distance (mm) | SPLSR | Simultaneous Transmission SAR Test |
|------------|----------|------------------|-------------|--|-------|------------------------------------|
| EVDO BC 0 | Top side | 0.658 | 0.688 | 185.8 | 0.003 | SPLSR<0.04, Not required |
| BT | | 0.03 | | | | |

BT & WLAN Aux

| Conditions | Position | SAR Value (W/kg) | ΣSAR (W/kg) | Peak Location Separation Distance (mm) | SPLSR | Simultaneous Transmission SAR Test |
|------------|----------|------------------|-------------|--|-------|------------------------------------|
| BT | Top side | 0.03 | 0.958 | 79 | 0.012 | SPLSR<0.04, Not required |
| WLAN Aux | | 0.928 | | | | |

Unless otherwise stated the results shown in this test report refer only to the sample(s) tested and such sample(s) are retained for 90 days only.

除非另有說明，此報告結果僅對測試之樣品負責，同時此樣品僅保留90天。本報告未經本公司書面許可，不可部份複製。

This document is issued by the Company subject to its General Conditions of Service printed overleaf, available on request or accessible at www.sgs.com/terms_and_conditions.htm and, for electronic format documents, subject to Terms and Conditions for Electronic Documents at www.sgs.com/terms_e-document.htm. Attention is drawn to the limitation of liability, indemnification and jurisdiction issues defined therein. Any holder of this document is advised that information contained hereon reflects the Company's findings at the time of its intervention only and within the limits of Client's instructions, if any. The Company's sole responsibility is to its Client and this document does not exonerate parties to a transaction from exercising all their rights and obligations under the transaction documents. This document cannot be reproduced except in full, without prior written approval of the Company. Any unauthorized alteration, forgery or falsification of the content or appearance of this document is unlawful and offenders may be prosecuted to the fullest extent of the law.

WWAN & WLAN Aux

| Conditions | Position | SAR Value (W/kg) | Coordinates (cm) | | | Σ SAR (W/kg) | Peak Location Separation Distance (mm) | SPLSR | Simultaneous Transmission SAR Test |
|------------|----------|------------------|------------------|-------|-------|---------------------|--|-------|------------------------------------|
| | | | x | y | z | | | | |
| EVDO BC 0 | Top side | 0.658 | -1.15 | -5.29 | -0.68 | 1.586 | 62.5 | 0.032 | SPLSR<0.04, Not required |
| WLAN Aux | | 0.928 | -1.08 | 0.96 | -0.76 | | | | |

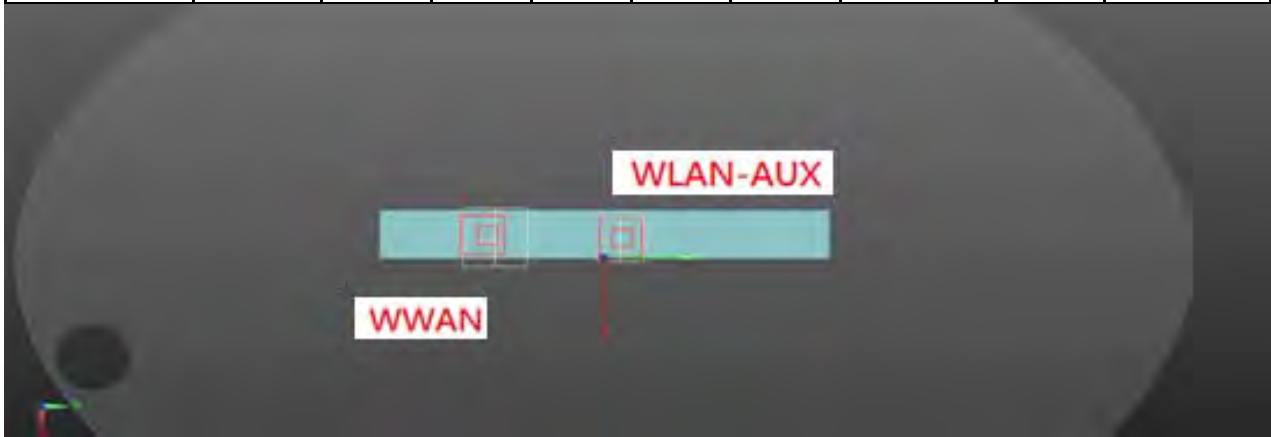

Unless otherwise stated the results shown in this test report refer only to the sample(s) tested and such sample(s) are retained for 90 days only.

除非另有說明，此報告結果僅對測試之樣品負責，同時此樣品僅保留90天。本報告未經本公司書面許可，不可部份複製。

This document is issued by the Company subject to its General Conditions of Service printed overleaf, available on request or accessible at www.sgs.com/terms_and_conditions.htm and, for electronic format documents, subject to Terms and Conditions for Electronic Documents at www.sgs.com/terms_e-document.htm. Attention is drawn to the limitation of liability, indemnification and jurisdiction issues defined therein. Any holder of this document is advised that information contained hereon reflects the Company's findings at the time of its intervention only and within the limits of Client's instructions, if any. The Company's sole responsibility is to its Client and this document does not exonerate parties to a transaction from exercising all their rights and obligations under the transaction documents. This document cannot be reproduced except in full, without prior written approval of the Company. Any unauthorized alteration, forgery or falsification of the content or appearance of this document is unlawful and offenders may be prosecuted to the fullest extent of the law.

CDMA / EVDO BC1 + BT+ 5GHz WLAN Main

| No. | Conditions | Position | Distance (mm) | Max. WWAN | BT | Max. WLAN Aux | SAR Sum | SPLSR |
|-----|------------|------------------------|---------------|-----------|-------|---------------|--------------|------------------------|
| 55 | EVDO BC 1 | Back side | 0 | 1.008 | 0.094 | 0.212 | 1.314 | ΣSAR<1.6, Not required |
| | | Back side_Curve(Left) | 0 | 0.973 | - | - | - | ΣSAR<1.6, Not required |
| | | Back side_Curve(Right) | 0 | - | 0.094 | - | - | ΣSAR<1.6, Not required |
| | | Top side | 0 | 0.903 | 0.03 | 0.928 | 1.861 | ΣSAR<1.6, Not required |
| | | Bottom side | 0 | 0.025 | 0.4 | 0.007 | 0.432 | ΣSAR<1.6, Not required |
| | | Left side | 0 | 0.341 | 0.4 | 0.006 | 0.747 | ΣSAR<1.6, Not required |
| | | Right side | 0 | 0.004 | 0.094 | 0.029 | 0.127 | ΣSAR<1.6, Not required |

WWAN & BT

| Conditions | Position | SAR Value (W/kg) | ΣSAR (W/kg) | Peak Location Separation Distance (mm) | SPLSR | Simultaneous Transmission SAR Test |
|------------|----------|------------------|-------------|--|-------|------------------------------------|
| EVDO BC 1 | Top side | 0.903 | 0.933 | 185.8 | 0.005 | SPLSR<0.04, Not required |
| BT | | 0.03 | | | | |

BT & WLAN Aux

| Conditions | Position | SAR Value (W/kg) | ΣSAR (W/kg) | Peak Location Separation Distance (mm) | SPLSR | Simultaneous Transmission SAR Test |
|------------|----------|------------------|-------------|--|-------|------------------------------------|
| BT | Top side | 0.03 | 0.958 | 79 | 0.012 | SPLSR<0.04, Not required |
| WLAN Aux | | 0.928 | | | | |

Unless otherwise stated the results shown in this test report refer only to the sample(s) tested and such sample(s) are retained for 90 days only.

除非另有說明，此報告結果僅對測試之樣品負責，同時此樣品僅保留90天。本報告未經本公司書面許可，不可部份複製。

This document is issued by the Company subject to its General Conditions of Service printed overleaf, available on request or accessible at www.sgs.com/terms_and_conditions.htm and, for electronic format documents, subject to Terms and Conditions for Electronic Documents at www.sgs.com/terms_e-document.htm. Attention is drawn to the limitation of liability, indemnification and jurisdiction issues defined therein. Any holder of this document is advised that information contained hereon reflects the Company's findings at the time of its intervention only and within the limits of Client's instructions, if any. The Company's sole responsibility is to its Client and this document does not exonerate parties to a transaction from exercising all their rights and obligations under the transaction documents. This document cannot be reproduced except in full, without prior written approval of the Company. Any unauthorized alteration, forgery or falsification of the content or appearance of this document is unlawful and offenders may be prosecuted to the fullest extent of the law.

WWAN & WLAN Aux

| Conditions | Position | SAR Value (W/kg) | Coordinates (cm) | | | ΣSAR (W/kg) | Peak Location Separation Distance (mm) | SPLSR | Simultaneous Transmission SAR Test |
|------------|----------|------------------|------------------|-------|-------|-------------|--|-------|------------------------------------|
| | | | x | y | z | | | | |
| EVDO BC 1 | Top side | 0.903 | -0.99 | -8.56 | -0.46 | 1.831 | 95.2 | 0.026 | SPLSR<0.04, Not required |
| WLAN Aux | | 0.928 | -1.08 | 0.96 | -0.76 | | | | |

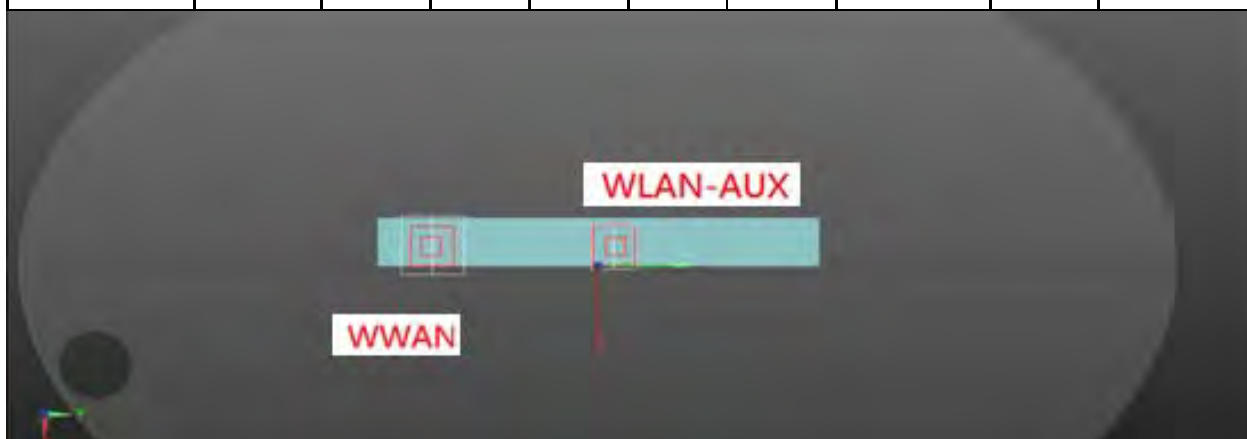

Unless otherwise stated the results shown in this test report refer only to the sample(s) tested and such sample(s) are retained for 90 days only.

除非另有說明，此報告結果僅對測試之樣品負責，同時此樣品僅保留90天。本報告未經本公司書面許可，不可部份複製。

This document is issued by the Company subject to its General Conditions of Service printed overleaf, available on request or accessible at www.sgs.com/terms_and_conditions.htm and, for electronic format documents, subject to Terms and Conditions for Electronic Documents at www.sgs.com/terms_e-document.htm. Attention is drawn to the limitation of liability, indemnification and jurisdiction issues defined therein. Any holder of this document is advised that information contained hereon reflects the Company's findings at the time of its intervention only and within the limits of Client's instructions, if any. The Company's sole responsibility is to its Client and this document does not exonerate parties to a transaction from exercising all their rights and obligations under the transaction documents. This document cannot be reproduced except in full, without prior written approval of the Company. Any unauthorized alteration, forgery or falsification of the content or appearance of this document is unlawful and offenders may be prosecuted to the fullest extent of the law.

CDMA / EVDO BC10 + BT + 5GHz WLAN Main

| No. | Conditions | Position | Distance (mm) | Max. WWAN | BT | Max. WLAN Aux | SAR Sum | SPLSR |
|-----|------------|------------------------|---------------|-----------|-------|---------------|---------|--------------------------------|
| 56 | EVDO BC 10 | Back side | 0 | 0.55 | 0.094 | 0.212 | 0.856 | Σ SAR<1.6, Not required |
| | | Back side_Curve(Left) | 0 | 0.635 | - | - | - | Σ SAR<1.6, Not required |
| | | Back side_Curve(Right) | 0 | - | 0.094 | - | - | Σ SAR<1.6, Not required |
| | | Top side | 0 | 0.582 | 0.03 | 0.928 | 1.54 | Σ SAR<1.6, Not required |
| | | Bottom side | 0 | 0.058 | 0.4 | 0.007 | 0.465 | Σ SAR<1.6, Not required |
| | | Left side | 0 | 0.723 | 0.4 | 0.006 | 1.129 | Σ SAR<1.6, Not required |
| | | Right side | 0 | 0.004 | 0.094 | 0.029 | 0.127 | Σ SAR<1.6, Not required |

Unless otherwise stated the results shown in this test report refer only to the sample(s) tested and such sample(s) are retained for 90 days only.

除非另有說明，此報告結果僅對測試之樣品負責，同時此樣品僅保留90天。本報告未經本公司書面許可，不可部份複製。

This document is issued by the Company subject to its General Conditions of Service printed overleaf, available on request or accessible at www.sgs.com/terms_and_conditions.htm and, for electronic format documents, subject to Terms and Conditions for Electronic Documents at www.sgs.com/terms_e-document.htm. Attention is drawn to the limitation of liability, indemnification and jurisdiction issues defined therein. Any holder of this document is advised that information contained hereon reflects the Company's findings at the time of its intervention only and within the limits of Client's instructions, if any. The Company's sole responsibility is to its Client and this document does not exonerate parties to a transaction from exercising all their rights and obligations under the transaction documents. This document cannot be reproduced except in full, without prior written approval of the Company. Any unauthorized alteration, forgery or falsification of the content or appearance of this document is unlawful and offenders may be prosecuted to the fullest extent of the law.

4. Instruments List

| Manufacturer | Device | Type | Serial number | Date of last calibration | Date of next calibration |
|---------------------------------|------------------------------|-----------------|---------------|--------------------------|--------------------------|
| Schmid & Partner Engineering AG | Dosimetric E-Field Probe | EX3DV4 | 3770 | Apr.28,2015 | Apr.27,2016 |
| Schmid & Partner Engineering AG | System Validation Dipole | D750V2 | 1015 | Aug.28,2014 | Aug.27,2015 |
| | | D835V2 | 4d063 | Aug.28,2014 | Aug.27,2015 |
| | | D1750V2 | 1008 | Aug.28,2014 | Aug.27,2015 |
| | | D1900V2 | 5d027 | Apr.29,2015 | Apr.28,2016 |
| | | D2450V2 | 727 | Apr.22,2015 | Apr.21,2016 |
| | | D5GHzV2 | 1023 | Jan.29,2015 | Jan.28,2016 |
| Schmid & Partner Engineering AG | Data acquisition Electronics | DAE4 | 856 | Aug.27,2015 | Aug.26,2016 |
| Schmid & Partner Engineering AG | Software | DASY 52 V52.8.8 | N/A | Calibration not required | Calibration not required |
| Schmid & Partner Engineering AG | Phantom | SAM | N/A | Calibration not required | Calibration not required |
| HP | Network Analyzer | 8753D | 3410A05547 | May.21,2015 | May.20,2016 |
| Agilent | Dielectric Probe Kit | 85070E | MY44300677 | Calibration not required | Calibration not required |
| Agilent | Dual-directional coupler | 777D | 50114 | Aug.07,2014 | Aug.06,2015 |
| | | 778D | 50313 | Aug.07,2014 | Aug.06,2015 |
| Agilent | RF Signal Generator | N5181A | MY50145142 | Feb.06,2015 | Feb.05,2016 |
| Agilent | Power Meter | E4417A | MY51410006 | Oct.25,2013 | Oct.24,2015 |
| Agilent | Power Sensor | E9301H | MY51470001 | Dec.11,2014 | Dec.10,2015 |
| TECPEL | Digital thermometer | DTM-303A | TP130078 | Mar.30,2015 | Mar.29,2016 |
| R&S | Radio Communication Test | CMU200 | 122498 | Aug.14,2014 | Aug.13,2015 |
| Anritsu | Radio Communication Test | MT8820C | 6201061014 | Aug.06,2014 | Aug.05,2015 |

Unless otherwise stated the results shown in this test report refer only to the sample(s) tested and such sample(s) are retained for 90 days only.

除非另有說明，此報告結果僅對測試之樣品負責，同時此樣品僅保留90天。本報告未經本公司書面許可，不可部份複製。

This document is issued by the Company subject to its General Conditions of Service printed overleaf, available on request or accessible at www.sgs.com/terms_and_conditions.htm and, for electronic format documents, subject to Terms and Conditions for Electronic Documents at www.sgs.com/terms_e-document.htm. Attention is drawn to the limitation of liability, indemnification and jurisdiction issues defined therein. Any holder of this document is advised that information contained hereon reflects the Company's findings at the time of its intervention only and within the limits of Client's instructions, if any. The Company's sole responsibility is to its Client and this document does not exonerate parties to a transaction from exercising all their rights and obligations under the transaction documents. This document cannot be reproduced except in full, without prior written approval of the Company. Any unauthorized alteration, forgery or falsification of the content or appearance of this document is unlawful and offenders may be prosecuted to the fullest extent of the law.

5. Measurements

Date: 2015/6/16

GPRS 850_Body-worn_Left side_CH 251

Communication System: GPRS (1Dn2Up); Frequency: 848.8 MHz

Medium parameters used: $f = 849$ MHz; $\sigma = 1.026$ S/m; $\epsilon_r = 56.515$; $\rho = 1000$ kg/m³

Phantom section: Flat Section

DASY5 Configuration:

- Probe: EX3DV4 - SN3770; ConvF(9.17, 9.17, 9.17); Calibrated: 2015/4/28;
- Sensor-Surface: 2mm (Mechanical Surface Detection)
- Electronics: DAE4 Sn856; Calibrated: 2014/8/27
- Phantom: Body;
- DASY52 52.8.8(1222); SEMCAD X 14.6.10(7331)

Configuration/Body/Area Scan (51x121x1): Interpolated grid: dx=15 mm, dy=15 mm

Maximum value of SAR (interpolated) = 1.42 W/kg

Configuration/Body/Zoom Scan (5x5x7)/Cube 0: Measurement grid:

dx=8mm, dy=8mm, dz=5mm

Reference Value = 29.58 V/m; Power Drift = 0.07 dB

Peak SAR (extrapolated) = 1.75 W/kg

SAR(1 g) = 0.991 W/kg; SAR(10 g) = 0.626 W/kg

Maximum value of SAR (measured) = 1.45 W/kg

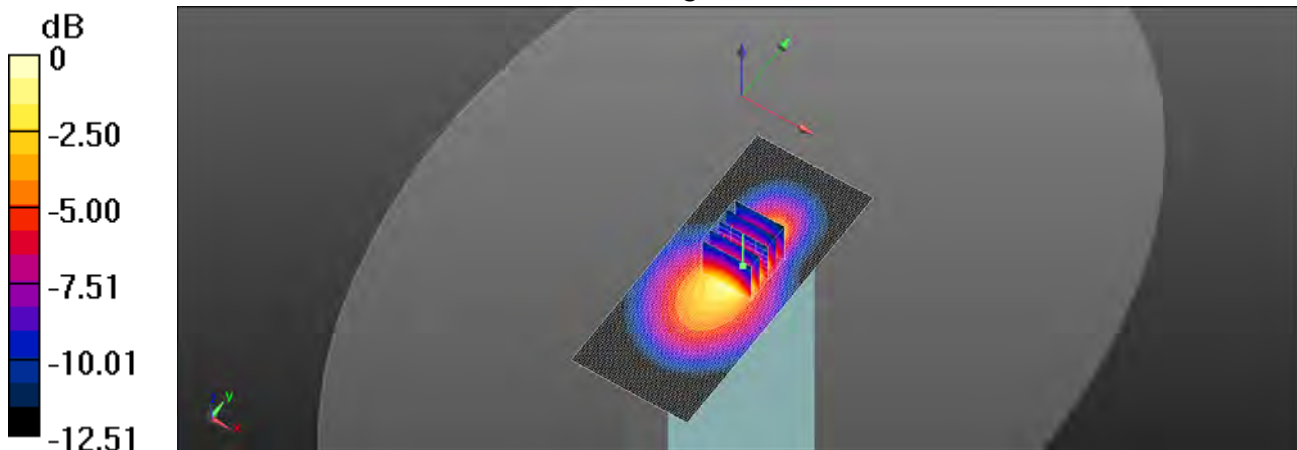

0 dB = 1.45 W/kg = 1.61 dBW/kg

Unless otherwise stated the results shown in this test report refer only to the sample(s) tested and such sample(s) are retained for 90 days only.

除非另有說明，此報告結果僅對測試之樣品負責，同時此樣品僅保留90天。本報告未經本公司書面許可，不可部份複製。

This document is issued by the Company subject to its General Conditions of Service printed overleaf, available on request or accessible at www.sgs.com/terms_and_conditions.htm and, for electronic format documents, subject to Terms and Conditions for Electronic Documents at www.sgs.com/terms_e-document.htm. Attention is drawn to the limitation of liability, indemnification and jurisdiction issues defined therein. Any holder of this document is advised that information contained hereon reflects the Company's findings at the time of its intervention only and within the limits of Client's instructions, if any. The Company's sole responsibility is to its Client and this document does not exonerate parties to a transaction from exercising all their rights and obligations under the transaction documents. This document cannot be reproduced except in full, without prior written approval of the Company. Any unauthorized alteration, forgery or falsification of the content or appearance of this document is unlawful and offenders may be prosecuted to the fullest extent of the law.

Date: 2015/6/18

GPRS 1900_Body-worn_Back(Curve)_CH 512

Communication System: GPRS (1Dn2Up); Frequency: 1850.2 MHz

Medium parameters used: $f = 1850.2$ MHz; $\sigma = 1.45$ S/m; $\epsilon_r = 53.753$; $\rho = 1000$ kg/m³

Phantom section: Flat Section

DASY5 Configuration:

- Probe: EX3DV4 - SN3770; ConvF(7.59, 7.59, 7.59); Calibrated: 2015/4/28;
- Sensor-Surface: 2mm (Mechanical Surface Detection)
- Electronics: DAE4 Sn856; Calibrated: 2014/8/27
- Phantom: Body;
- DASY52 52.8.8(1222); SEMCAD X 14.6.10(7331)

Configuration/Body/Area Scan (61x61x1): Interpolated grid: dx=15 mm, dy=15 mm

Maximum value of SAR (interpolated) = 1.79 W/kg

Configuration/Body/Zoom Scan (5x5x7)/Cube 0: Measurement grid:

dx=8mm, dy=8mm, dz=5mm

Reference Value = 4.512 V/m; Power Drift = 0.17 dB

Peak SAR (extrapolated) = 2.20 W/kg

SAR(1 g) = 1.26 W/kg; SAR(10 g) = 0.698 W/kg

Maximum value of SAR (measured) = 1.73 W/kg

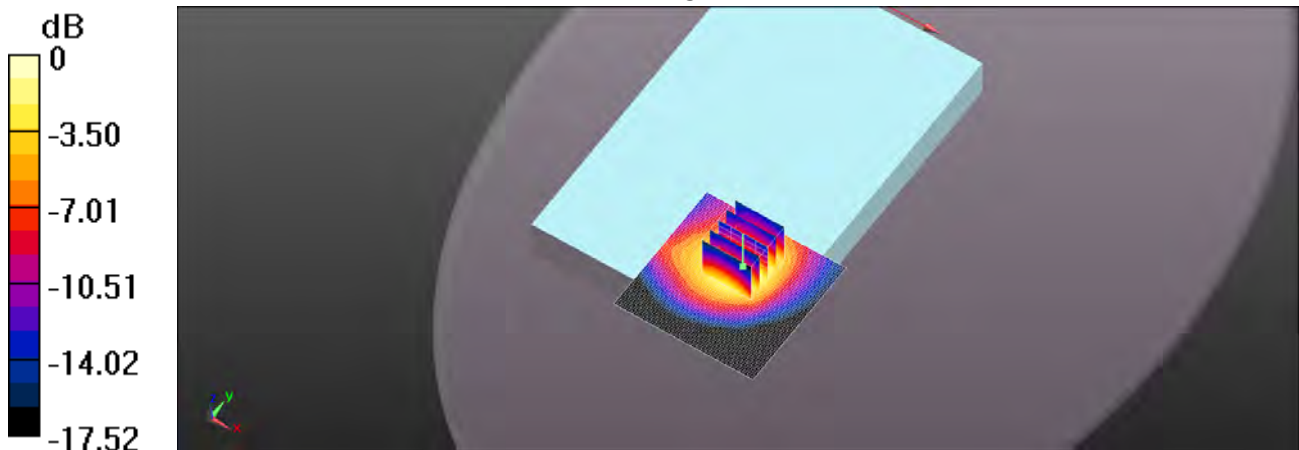

0 dB = 1.73 W/kg = 2.38 dBW/kg

Unless otherwise stated the results shown in this test report refer only to the sample(s) tested and such sample(s) are retained for 90 days only.

除非另有說明，此報告結果僅對測試之樣品負責，同時此樣品僅保留90天。本報告未經本公司書面許可，不可部份複製。

This document is issued by the Company subject to its General Conditions of Service printed overleaf, available on request or accessible at www.sgs.com/terms_and_conditions.htm and, for electronic format documents, subject to Terms and Conditions for Electronic Documents at www.sgs.com/terms_e-document.htm. Attention is drawn to the limitation of liability, indemnification and jurisdiction issues defined therein. Any holder of this document is advised that information contained hereon reflects the Company's findings at the time of its intervention only and within the limits of Client's instructions, if any. The Company's sole responsibility is to its Client and this document does not exonerate parties to a transaction from exercising all their rights and obligations under the transaction documents. This document cannot be reproduced except in full, without prior written approval of the Company. Any unauthorized alteration, forgery or falsification of the content or appearance of this document is unlawful and offenders may be prosecuted to the fullest extent of the law.

Date: 2015/6/18

WCDMA Band 2_Body-worn_Back(Curve)_CH 9262

Communication System: WCDMA; Frequency: 1852.4 MHz

Medium parameters used: $f = 1852.4$ MHz; $\sigma = 1.454$ S/m; $\epsilon_r = 53.75$; $\rho = 1000$ kg/m³

Phantom section: Flat Section

DASY5 Configuration:

- Probe: EX3DV4 - SN3770; ConvF(7.59, 7.59, 7.59); Calibrated: 2015/4/28;
- Sensor-Surface: 2mm (Mechanical Surface Detection)
- Electronics: DAE4 Sn856; Calibrated: 2014/8/27
- Phantom: Body;
- DASY52 52.8.8(1222); SEMCAD X 14.6.10(7331)

Configuration/Body/Area Scan (61x61x1): Interpolated grid: dx=15 mm, dy=15 mm

Maximum value of SAR (interpolated) = 1.61 W/kg

Configuration/Body/Zoom Scan (5x5x7)/Cube 0: Measurement grid:

dx=8mm, dy=8mm, dz=5mm

Reference Value = 4.542 V/m; Power Drift = 0.00 dB

Peak SAR (extrapolated) = 2.04 W/kg

SAR(1 g) = 1.16 W/kg; SAR(10 g) = 0.639 W/kg

Maximum value of SAR (measured) = 1.62 W/kg

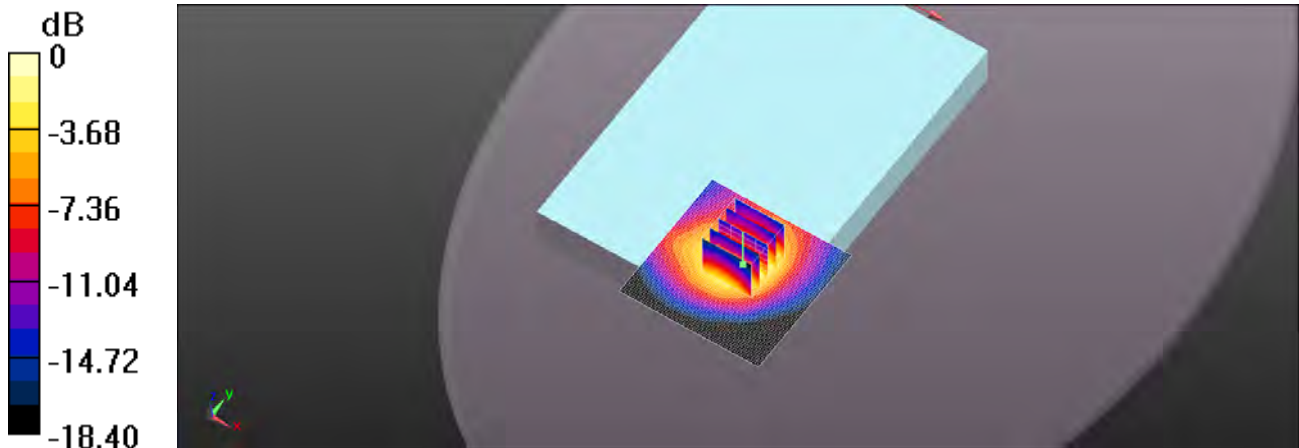

0 dB = 1.62 W/kg = 2.10 dBW/kg

Unless otherwise stated the results shown in this test report refer only to the sample(s) tested and such sample(s) are retained for 90 days only.

除非另有說明，此報告結果僅對測試之樣品負責，同時此樣品僅保留90天。本報告未經本公司書面許可，不可部份複製。

This document is issued by the Company subject to its General Conditions of Service printed overleaf, available on request or accessible at www.sgs.com/terms_and_conditions.htm and, for electronic format documents, subject to Terms and Conditions for Electronic Documents at www.sgs.com/terms_e-document.htm. Attention is drawn to the limitation of liability, indemnification and jurisdiction issues defined therein. Any holder of this document is advised that information contained hereon reflects the Company's findings at the time of its intervention only and within the limits of Client's instructions, if any. The Company's sole responsibility is to its Client and this document does not exonerate parties to a transaction from exercising all their rights and obligations under the transaction documents. This document cannot be reproduced except in full, without prior written approval of the Company. Any unauthorized alteration, forgery or falsification of the content or appearance of this document is unlawful and offenders may be prosecuted to the fullest extent of the law.

Date: 2015/6/17

WCDMA Band 4_Body-worn_Back(Curve)_CH 1513

Communication System: WCDMA; Frequency: 1752.6 MHz

Medium parameters used: $f = 1753$ MHz; $\sigma = 1.446$ S/m; $\epsilon_r = 52.808$; $\rho = 1000$ kg/m³

Phantom section: Flat Section

DASY5 Configuration:

- Probe: EX3DV4 - SN3770; ConvF(7.79, 7.79, 7.79); Calibrated: 2015/4/28;
- Sensor-Surface: 2mm (Mechanical Surface Detection)
- Electronics: DAE4 Sn856; Calibrated: 2014/8/27
- Phantom: Body;
- DASY52 52.8.8(1222); SEMCAD X 14.6.10(7331)

Configuration/Body/Area Scan (61x81x1): Interpolated grid: dx=15 mm, dy=15 mm

Maximum value of SAR (interpolated) = 1.50 W/kg

Configuration/Body/Zoom Scan (5x5x7)/Cube 0: Measurement grid:

dx=8mm, dy=8mm, dz=5mm

Reference Value = 4.935 V/m; Power Drift = 0.06 dB

Peak SAR (extrapolated) = 1.86 W/kg

SAR(1 g) = 1.07 W/kg; SAR(10 g) = 0.585 W/kg

Maximum value of SAR (measured) = 1.48 W/kg

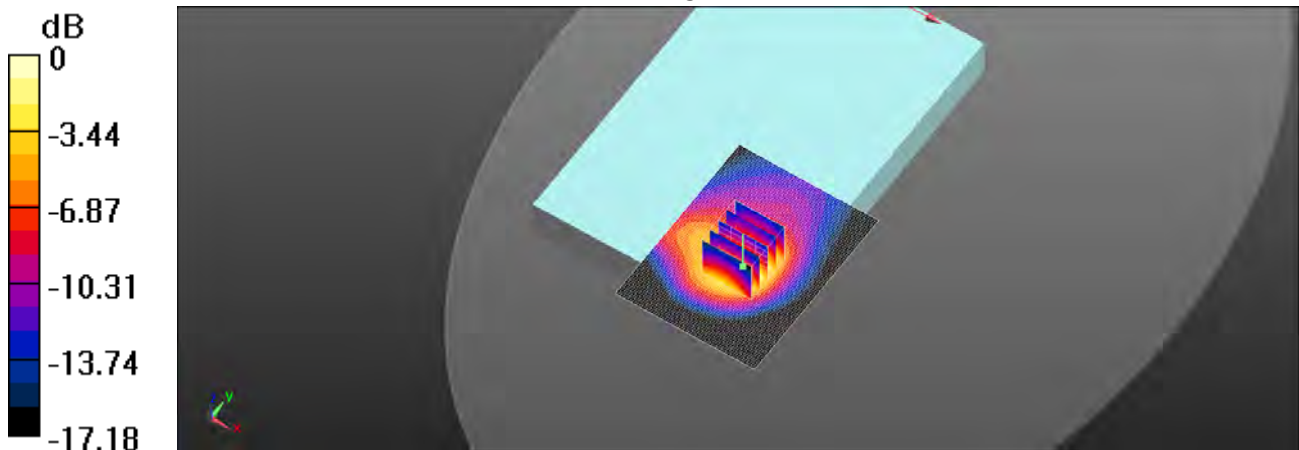

0 dB = 1.48 W/kg = 1.70 dBW/kg

Unless otherwise stated the results shown in this test report refer only to the sample(s) tested and such sample(s) are retained for 90 days only.

除非另有說明，此報告結果僅對測試之樣品負責，同時此樣品僅保留90天。本報告未經本公司書面許可，不可部份複製。

This document is issued by the Company subject to its General Conditions of Service printed overleaf, available on request or accessible at www.sgs.com/terms_and_conditions.htm and, for electronic format documents, subject to Terms and Conditions for Electronic Documents at www.sgs.com/terms_e-document.htm. Attention is drawn to the limitation of liability, indemnification and jurisdiction issues defined therein. Any holder of this document is advised that information contained hereon reflects the Company's findings at the time of its intervention only and within the limits of Client's instructions, if any. The Company's sole responsibility is to its Client and this document does not exonerate parties to a transaction from exercising all their rights and obligations under the transaction documents. This document cannot be reproduced except in full, without prior written approval of the Company. Any unauthorized alteration, forgery or falsification of the content or appearance of this document is unlawful and offenders may be prosecuted to the fullest extent of the law.

WCDMA Band 5_Body-worn_Left side_CH 4183

Communication System: WCDMA; Frequency: 836.6 MHz

Medium parameters used: $f = 837$ MHz; $\sigma = 1.014$ S/m; $\epsilon_r = 56.669$; $\rho = 1000$ kg/m³

Phantom section: Flat Section

DASY5 Configuration:

- Probe: EX3DV4 - SN3770; ConvF(9.17, 9.17, 9.17); Calibrated: 2015/4/28;
- Sensor-Surface: 2mm (Mechanical Surface Detection)
- Electronics: DAE4 Sn856; Calibrated: 2014/8/27
- Phantom: Body;
- DASY52 52.8.8(1222); SEMCAD X 14.6.10(7331)

Configuration/Body/Area Scan (51x121x1): Interpolated grid: dx=15mm, dy=15 mm

Maximum value of SAR (interpolated) = 0.718 W/kg

Configuration/Body/Zoom Scan (5x5x7)/Cube 0: Measurement grid:

dx=8mm, dy=8mm, dz=5mm

Reference Value = 20.85 V/m; Power Drift = -0.03 dB

Peak SAR (extrapolated) = 0.932 W/kg

SAR(1 g) = 0.565 W/kg; SAR(10 g) = 0.356 W/kg

Maximum value of SAR (measured) = 0.779 W/kg

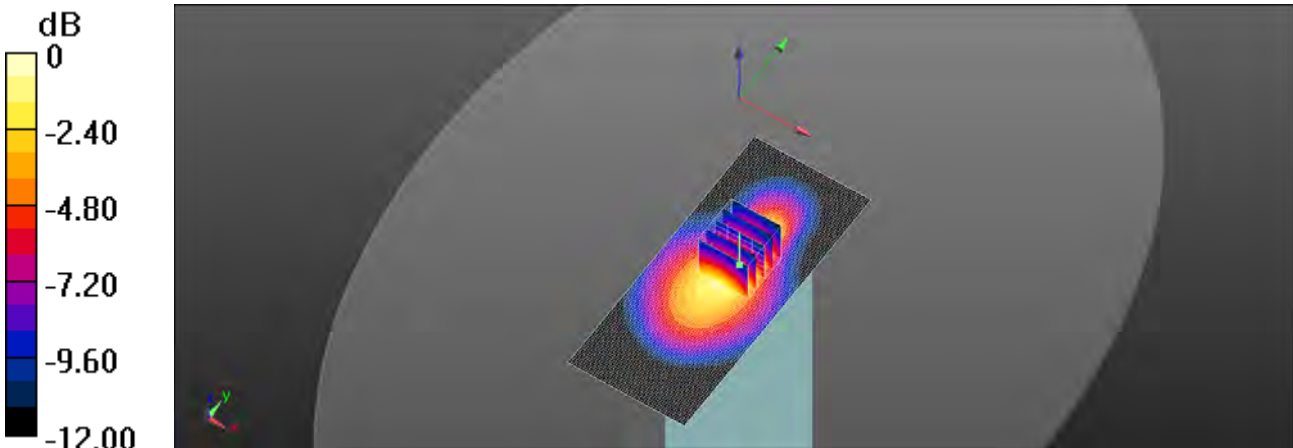

0 dB = 0.779 W/kg = -1.08 dBW/kg

Unless otherwise stated the results shown in this test report refer only to the sample(s) tested and such sample(s) are retained for 90 days only.

除非另有說明，此報告結果僅對測試之樣品負責，同時此樣品僅保留90天。本報告未經本公司書面許可，不可部份複製。

This document is issued by the Company subject to its General Conditions of Service printed overleaf, available on request or accessible at www.sgs.com/terms_and_conditions.htm and, for electronic format documents, subject to Terms and Conditions for Electronic Documents at www.sgs.com/terms_e-document.htm. Attention is drawn to the limitation of liability, indemnification and jurisdiction issues defined therein. Any holder of this document is advised that information contained hereon reflects the Company's findings at the time of its intervention only and within the limits of Client's instructions, if any. The Company's sole responsibility is to its Client and this document does not exonerate parties to a transaction from exercising all their rights and obligations under the transaction documents. This document cannot be reproduced except in full, without prior written approval of the Company. Any unauthorized alteration, forgery or falsification of the content or appearance of this document is unlawful and offenders may be prosecuted to the fullest extent of the law.

Date: 2015/6/18

LTE Band 2_Body-worn_Back(Curve)_CH 18700_20M_100-0

Communication System: LTE; Frequency: 1860 MHz

Medium parameters used: $f = 1860$ MHz; $\sigma = 1.459$ S/m; $\epsilon_r = 53.718$; $\rho = 1000$ kg/m³

Phantom section: Flat Section

DASY5 Configuration:

- Probe: EX3DV4 - SN3770; ConvF(7.59, 7.59, 7.59); Calibrated: 2015/4/28;
- Sensor-Surface: 2mm (Mechanical Surface Detection)
- Electronics: DAE4 Sn856; Calibrated: 2014/8/27
- Phantom: Body;
- DASY52 52.8.8(1222); SEMCAD X 14.6.10(7331)

Configuration/Body/Area Scan (61x61x1): Interpolated grid: dx=15 mm, dy=15 mm

Maximum value of SAR (interpolated) = 1.44 W/kg

Configuration/Body/Zoom Scan (5x5x7)/Cube 0: Measurement grid:

dx=8mm, dy=8mm, dz=5mm

Reference Value = 4.320 V/m; Power Drift = 0.16 dB

Peak SAR (extrapolated) = 1.84 W/kg

SAR(1 g) = 1.03 W/kg; SAR(10 g) = 0.569 W/kg

Maximum value of SAR (measured) = 1.46 W/kg

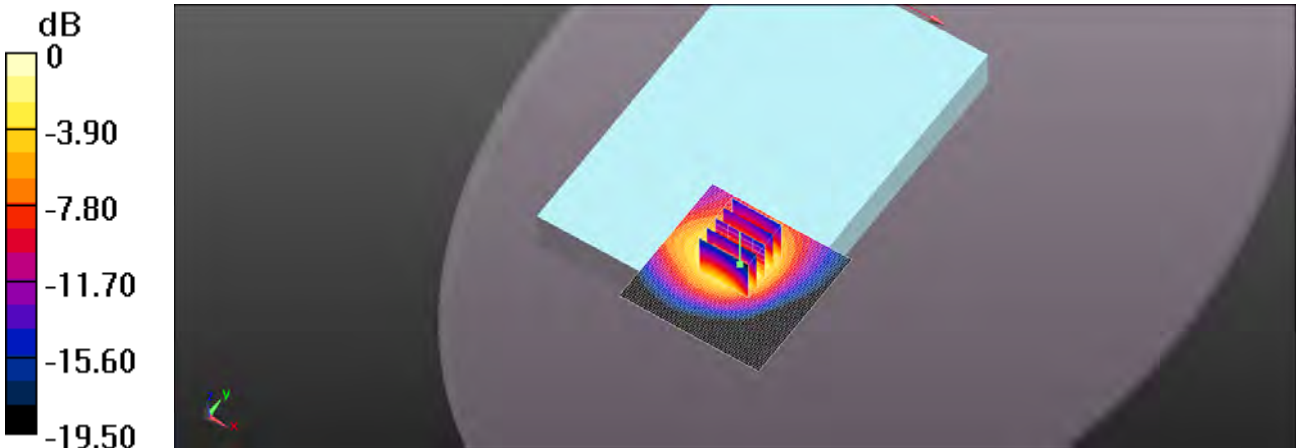

0 dB = 1.46 W/kg = 1.64 dBW/kg

Unless otherwise stated the results shown in this test report refer only to the sample(s) tested and such sample(s) are retained for 90 days only.

除非另有說明，此報告結果僅對測試之樣品負責，同時此樣品僅保留90天。本報告未經本公司書面許可，不可部份複製。

This document is issued by the Company subject to its General Conditions of Service printed overleaf, available on request or accessible at www.sgs.com/terms_and_conditions.htm and, for electronic format documents, subject to Terms and Conditions for Electronic Documents at www.sgs.com/terms_e-document.htm. Attention is drawn to the limitation of liability, indemnification and jurisdiction issues defined therein. Any holder of this document is advised that information contained hereon reflects the Company's findings at the time of its intervention only and within the limits of Client's instructions, if any. The Company's sole responsibility is to its Client and this document does not exonerate parties to a transaction from exercising all their rights and obligations under the transaction documents. This document cannot be reproduced except in full, without prior written approval of the Company. Any unauthorized alteration, forgery or falsification of the content or appearance of this document is unlawful and offenders may be prosecuted to the fullest extent of the law.

Date: 2015/6/17

LTE Band 4_Body-worn_Back_CH 20175_20M_1-0

Communication System: LTE; Frequency: 1732.5 MHz

Medium parameters used: $f = 1732.5$ MHz; $\sigma = 1.425$ S/m; $\epsilon_r = 52.831$; $\rho = 1000$ kg/m³

Phantom section: Flat Section

DASY5 Configuration:

- Probe: EX3DV4 - SN3770; ConvF(7.79, 7.79, 7.79); Calibrated: 2015/4/28;
- Sensor-Surface: 2mm (Mechanical Surface Detection)
- Electronics: DAE4 Sn856; Calibrated: 2014/8/27
- Phantom: Body;
- DASY52 52.8.8(1222); SEMCAD X 14.6.10(7331)

Configuration/Body/Area Scan (61x61x1): Interpolated grid: dx=15 mm, dy=15 mm

Maximum value of SAR (interpolated) = 1.43 W/kg

Configuration/Body/Zoom Scan (5x5x7)/Cube 0: Measurement grid:

dx=8mm, dy=8mm, dz=5mm

Reference Value = 5.429 V/m; Power Drift = 0.19 dB

Peak SAR (extrapolated) = 1.95 W/kg

SAR(1 g) = 1.15 W/kg; SAR(10 g) = 0.625 W/kg

Maximum value of SAR (measured) = 1.59 W/kg

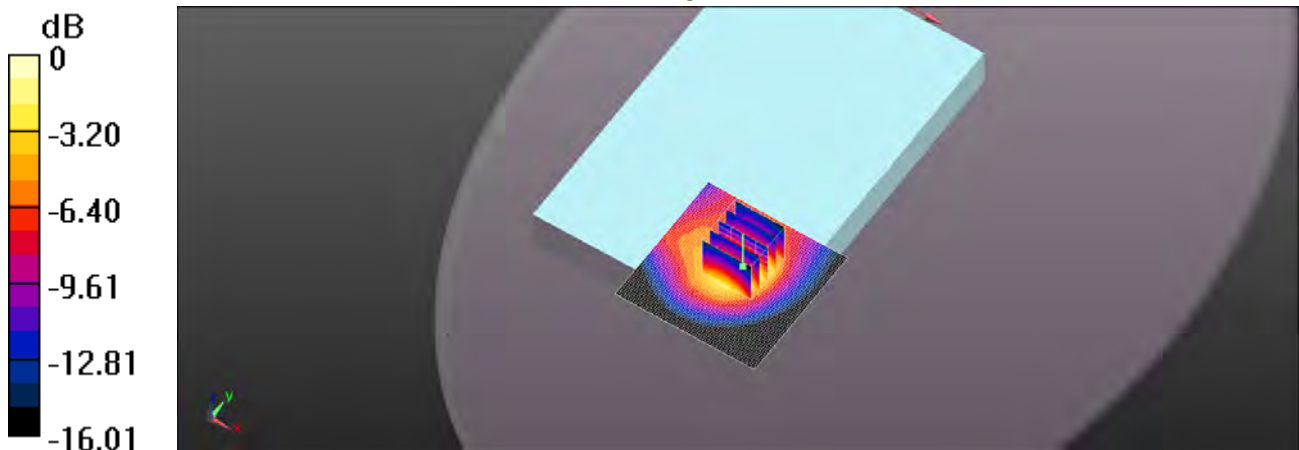

0 dB = 1.59 W/kg = 2.01 dBW/kg

Unless otherwise stated the results shown in this test report refer only to the sample(s) tested and such sample(s) are retained for 90 days only.

除非另有說明，此報告結果僅對測試之樣品負責，同時此樣品僅保留90天。本報告未經本公司書面許可，不可部份複製。

This document is issued by the Company subject to its General Conditions of Service printed overleaf, available on request or accessible at www.sgs.com/terms_and_conditions.htm and, for electronic format documents, subject to Terms and Conditions for Electronic Documents at www.sgs.com/terms_e-document.htm. Attention is drawn to the limitation of liability, indemnification and jurisdiction issues defined therein. Any holder of this document is advised that information contained hereon reflects the Company's findings at the time of its intervention only and within the limits of Client's instructions, if any. The Company's sole responsibility is to its Client and this document does not exonerate parties to a transaction from exercising all their rights and obligations under the transaction documents. This document cannot be reproduced except in full, without prior written approval of the Company. Any unauthorized alteration, forgery or falsification of the content or appearance of this document is unlawful and offenders may be prosecuted to the fullest extent of the law.

LTE Band 5_Body-worn_Left side_CH 20600_10M_1-49

Communication System: LTE; Frequency: 844 MHz

Medium parameters used: $f = 844 \text{ MHz}$; $\sigma = 1.02 \text{ S/m}$; $\epsilon_r = 56.606$; $\rho = 1000 \text{ kg/m}^3$

Phantom section: Flat Section

DASY5 Configuration:

- Probe: EX3DV4 - SN3770; ConvF(9.17, 9.17, 9.17); Calibrated: 2015/4/28;
- Sensor-Surface: 2mm (Mechanical Surface Detection)
- Electronics: DAE4 Sn856; Calibrated: 2014/8/27
- Phantom: Body;
- DASY52 52.8.8(1222); SEMCAD X 14.6.10(7331)

Configuration/Body/Area Scan (61x111x1): Interpolated grid: $dx=15 \text{ mm}$, $dy=15 \text{ mm}$

Maximum value of SAR (interpolated) = 0.596 W/kg

Configuration/Body/Zoom Scan (5x5x7)/Cube 0: Measurement grid:

$dx=8\text{mm}$, $dy=8\text{mm}$, $dz=5\text{mm}$

Reference Value = 18.01 V/m; Power Drift = 0.10 dB

Peak SAR (extrapolated) = 0.741 W/kg

SAR(1 g) = 0.432 W/kg; SAR(10 g) = 0.255 W/kg

Maximum value of SAR (measured) = 0.606 W/kg

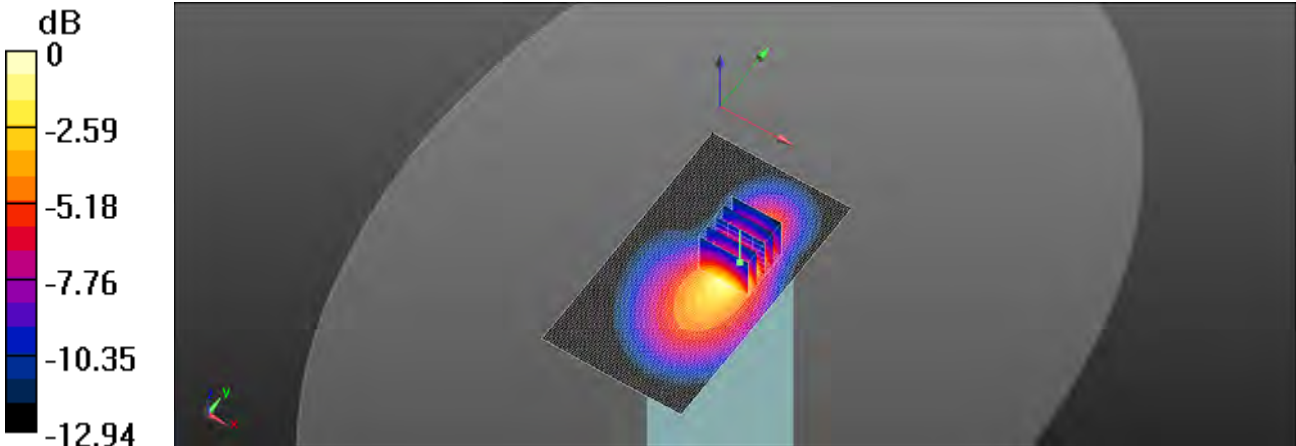

0 dB = 0.606 W/kg = -2.18 dBW/kg

Unless otherwise stated the results shown in this test report refer only to the sample(s) tested and such sample(s) are retained for 90 days only.

除非另有說明，此報告結果僅對測試之樣品負責，同時此樣品僅保留90天。本報告未經本公司書面許可，不可部份複製。

This document is issued by the Company subject to its General Conditions of Service printed overleaf, available on request or accessible at www.sgs.com/terms_and_conditions.htm and, for electronic format documents, subject to Terms and Conditions for Electronic Documents at www.sgs.com/terms_e-document.htm. Attention is drawn to the limitation of liability, indemnification and jurisdiction issues defined therein. Any holder of this document is advised that information contained hereon reflects the Company's findings at the time of its intervention only and within the limits of Client's instructions, if any. The Company's sole responsibility is to its Client and this document does not exonerate parties to a transaction from exercising all their rights and obligations under the transaction documents. This document cannot be reproduced except in full, without prior written approval of the Company. Any unauthorized alteration, forgery or falsification of the content or appearance of this document is unlawful and offenders may be prosecuted to the fullest extent of the law.

Date: 2015/6/15

LTE Band 13_Body-worn_Left side_CH 23230_10M_1-25

Communication System: LTE; Frequency: 782 MHz

Medium parameters used: $f = 782 \text{ MHz}$; $\sigma = 1.005 \text{ S/m}$; $\epsilon_r = 53.042$; $\rho = 1000 \text{ kg/m}^3$

Phantom section: Flat Section

DASY5 Configuration:

- Probe: EX3DV4 - SN3770; ConvF(9.3, 9.3, 9.3); Calibrated: 2015/4/28;
- Sensor-Surface: 2mm (Mechanical Surface Detection)
- Electronics: DAE4 Sn856; Calibrated: 2014/8/27
- Phantom: Body;
- DASY52 52.8.8(1222); SEMCAD X 14.6.10(7331)

Configuration/Body/Area Scan (61x111x1): Interpolated grid: $dx=15 \text{ mm}$, $dy=15 \text{ mm}$

Maximum value of SAR (interpolated) = 0.803 W/kg

Configuration/Body/Zoom Scan (5x5x7)/Cube 0: Measurement grid:

$dx=8\text{mm}$, $dy=8\text{mm}$, $dz=5\text{mm}$

Reference Value = 20.82 V/m; Power Drift = 0.06 dB

Peak SAR (extrapolated) = 0.954 W/kg

SAR(1 g) = 0.594 W/kg; SAR(10 g) = 0.372 W/kg

Maximum value of SAR (measured) = 0.801 W/kg

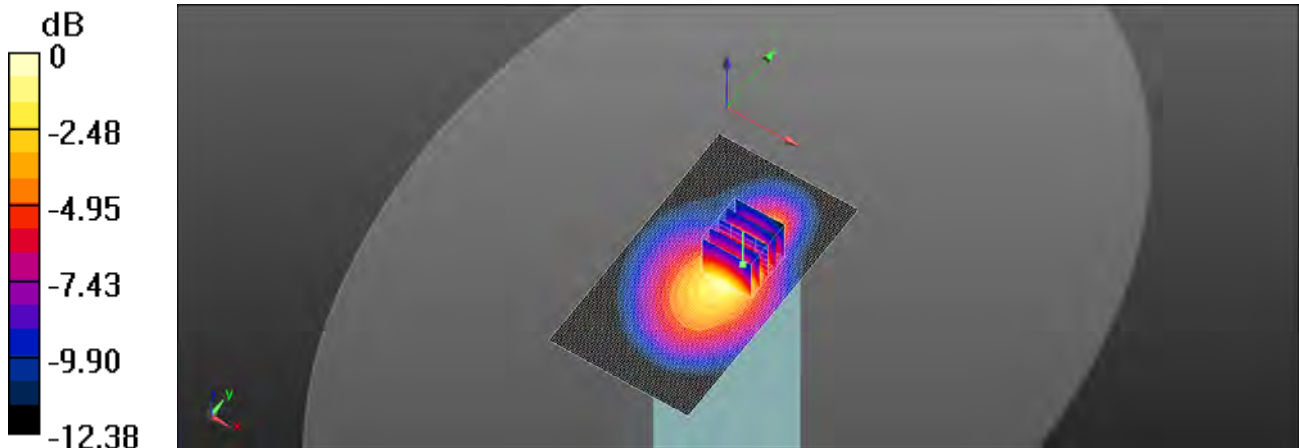

0 dB = 0.801 W/kg = -0.96 dBW/kg

Unless otherwise stated the results shown in this test report refer only to the sample(s) tested and such sample(s) are retained for 90 days only.

除非另有說明，此報告結果僅對測試之樣品負責，同時此樣品僅保留90天。本報告未經本公司書面許可，不可部份複製。

This document is issued by the Company subject to its General Conditions of Service printed overleaf, available on request or accessible at www.sgs.com/terms_and_conditions.htm and, for electronic format documents, subject to Terms and Conditions for Electronic Documents at www.sgs.com/terms_e-document.htm. Attention is drawn to the limitation of liability, indemnification and jurisdiction issues defined therein. Any holder of this document is advised that information contained hereon reflects the Company's findings at the time of its intervention only and within the limits of Client's instructions, if any. The Company's sole responsibility is to its Client and this document does not exonerate parties to a transaction from exercising all their rights and obligations under the transaction documents. This document cannot be reproduced except in full, without prior written approval of the Company. Any unauthorized alteration, forgery or falsification of the content or appearance of this document is unlawful and offenders may be prosecuted to the fullest extent of the law.

Date: 2015/6/15

LTE Band 17_Body-worn_Left side_CH 23800_10M_1-25

Communication System: LTE; Frequency: 711 MHz

Medium parameters used: $f = 711 \text{ MHz}$; $\sigma = 0.974 \text{ S/m}$; $\epsilon_r = 53.797$; $\rho = 1000 \text{ kg/m}^3$

Phantom section: Flat Section

DASY5 Configuration:

- Probe: EX3DV4 - SN3770; ConvF(9.3, 9.3, 9.3); Calibrated: 2015/4/28;
- Sensor-Surface: 2mm (Mechanical Surface Detection)
- Electronics: DAE4 Sn856; Calibrated: 2014/8/27
- Phantom: Body;
- DASY52 52.8.8(1222); SEMCAD X 14.6.10(7331)

Configuration/Body/Area Scan (61x111x1): Interpolated grid: $dx=15 \text{ mm}$, $dy=15 \text{ mm}$

Maximum value of SAR (interpolated) = 0.537 W/kg

Configuration/Body/Zoom Scan (5x5x7)/Cube 0: Measurement grid:

$dx=8\text{mm}$, $dy=8\text{mm}$, $dz=5\text{mm}$

Reference Value = 19.47 V/m; Power Drift = 0.16 dB

Peak SAR (extrapolated) = 0.719 W/kg

SAR(1 g) = 0.397 W/kg; SAR(10 g) = 0.252 W/kg

Maximum value of SAR (measured) = 0.594 W/kg

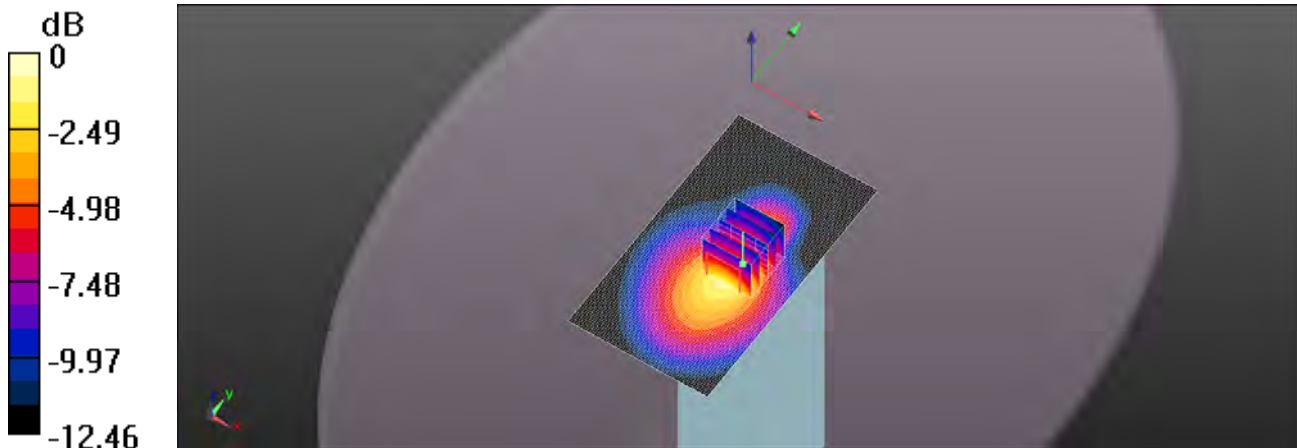

0 dB = 0.594 W/kg = -2.26 dBW/kg

Unless otherwise stated the results shown in this test report refer only to the sample(s) tested and such sample(s) are retained for 90 days only.

除非另有說明，此報告結果僅對測試之樣品負責，同時此樣品僅保留90天。本報告未經本公司書面許可，不可部份複製。

This document is issued by the Company subject to its General Conditions of Service printed overleaf, available on request or accessible at www.sgs.com/terms_and_conditions.htm and, for electronic format documents, subject to Terms and Conditions for Electronic Documents at www.sgs.com/terms_e-document.htm. Attention is drawn to the limitation of liability, indemnification and jurisdiction issues defined therein. Any holder of this document is advised that information contained hereon reflects the Company's findings at the time of its intervention only and within the limits of Client's instructions, if any. The Company's sole responsibility is to its Client and this document does not exonerate parties to a transaction from exercising all their rights and obligations under the transaction documents. This document cannot be reproduced except in full, without prior written approval of the Company. Any unauthorized alteration, forgery or falsification of the content or appearance of this document is unlawful and offenders may be prosecuted to the fullest extent of the law.

LET Band 25_Body-worn_Top side_CH 26590_20M_50-50

Communication System: LTE; Frequency: 1905 MHz

Medium parameters used: $f = 1905 \text{ MHz}$; $\sigma = 1.508 \text{ S/m}$; $\epsilon_r = 53.572$; $\rho = 1000 \text{ kg/m}^3$

Phantom section: Flat Section

DASY5 Configuration:

- Probe: EX3DV4 - SN3770; ConvF(7.59, 7.59, 7.59); Calibrated: 2015/4/28;
- Sensor-Surface: 2mm (Mechanical Surface Detection)
- Electronics: DAE4 Sn856; Calibrated: 2014/8/27
- Phantom: Body;
- DASY52 52.8.8(1222); SEMCAD X 14.6.10(7331)

Configuration/Body/Area Scan (61x61x1): Interpolated grid: $dx=15 \text{ mm}$, $dy=15 \text{ mm}$

Maximum value of SAR (interpolated) = 1.60 W/kg

Configuration/Body/Zoom Scan (5x5x7)/Cube 0: Measurement grid:

$dx=8\text{mm}$, $dy=8\text{mm}$, $dz=5\text{mm}$

Reference Value = 7.854 V/m; Power Drift = 0.10 dB

Peak SAR (extrapolated) = 2.07 W/kg

SAR(1 g) = 1.14 W/kg; SAR(10 g) = 0.604 W/kg

Maximum value of SAR (measured) = 1.59 W/kg

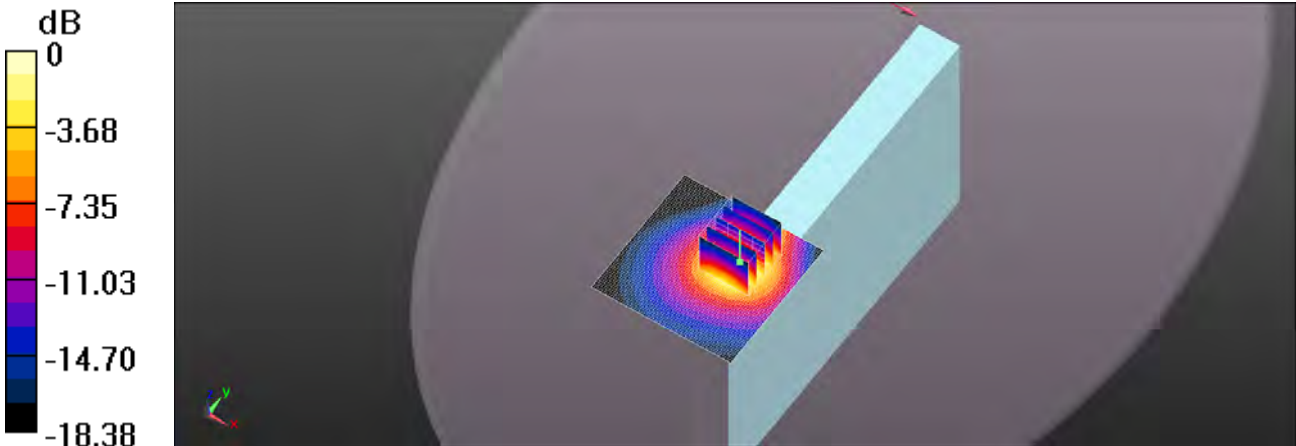

0 dB = 1.59 W/kg = 2.01 dBW/kg

Unless otherwise stated the results shown in this test report refer only to the sample(s) tested and such sample(s) are retained for 90 days only.

除非另有說明，此報告結果僅對測試之樣品負責，同時此樣品僅保留90天。本報告未經本公司書面許可，不可部份複製。

This document is issued by the Company subject to its General Conditions of Service printed overleaf, available on request or accessible at www.sgs.com/terms_and_conditions.htm and, for electronic format documents, subject to Terms and Conditions for Electronic Documents at www.sgs.com/terms_e-document.htm. Attention is drawn to the limitation of liability, indemnification and jurisdiction issues defined therein. Any holder of this document is advised that information contained hereon reflects the Company's findings at the time of its intervention only and within the limits of Client's instructions, if any. The Company's sole responsibility is to its Client and this document does not exonerate parties to a transaction from exercising all their rights and obligations under the transaction documents. This document cannot be reproduced except in full, without prior written approval of the Company. Any unauthorized alteration, forgery or falsification of the content or appearance of this document is unlawful and offenders may be prosecuted to the fullest extent of the law.

Date: 2015/6/16

EVDO BC0_Body-worn_Left side_CH 384

Communication System: 1xEvDO; Frequency: 836.52 MHz

Medium parameters used: $f = 837$ MHz; $\sigma = 1.014$ S/m; $\epsilon_r = 56.669$; $\rho = 1000$ kg/m³

Phantom section: Flat Section

DASY5 Configuration:

- Probe: EX3DV4 - SN3770; ConvF(9.17, 9.17, 9.17); Calibrated: 2015/4/28;
- Sensor-Surface: 2mm (Mechanical Surface Detection)
- Electronics: DAE4 Sn856; Calibrated: 2014/8/27
- Phantom: Body;
- DASY52 52.8.8(1222); SEMCAD X 14.6.10(7331)

Configuration/Body/Area Scan (51x121x1): Interpolated grid: dx=15 mm, dy=15 mm

Maximum value of SAR (interpolated) = 1.02 W/kg

Configuration/Body/Zoom Scan (5x5x7)/Cube 0: Measurement grid:

dx=8mm, dy=8mm, dz=5mm

Reference Value = 25.75 V/m; Power Drift = -0.09 dB

Peak SAR (extrapolated) = 1.26 W/kg

SAR(1 g) = 0.73 W/kg; SAR(10 g) = 0.44 W/kg

Maximum value of SAR (measured) = 1.04 W/kg

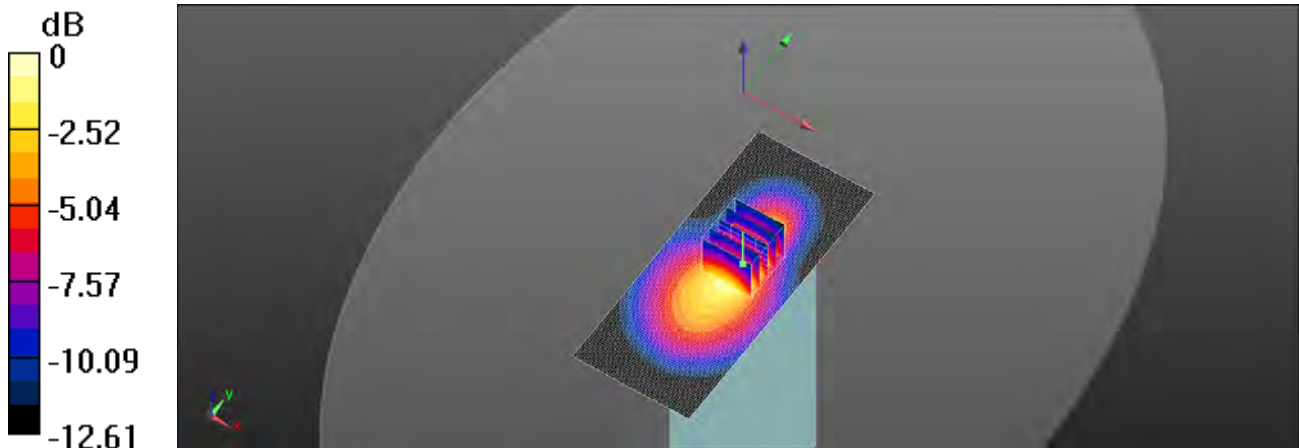

0 dB = 1.04 W/kg = 0.17 dBW/kg

Unless otherwise stated the results shown in this test report refer only to the sample(s) tested and such sample(s) are retained for 90 days only.

除非另有說明，此報告結果僅對測試之樣品負責，同時此樣品僅保留90天。本報告未經本公司書面許可，不可部份複製。

This document is issued by the Company subject to its General Conditions of Service printed overleaf, available on request or accessible at www.sgs.com/terms_and_conditions.htm and, for electronic format documents, subject to Terms and Conditions for Electronic Documents at www.sgs.com/terms_e-document.htm. Attention is drawn to the limitation of liability, indemnification and jurisdiction issues defined therein. Any holder of this document is advised that information contained hereon reflects the Company's findings at the time of its intervention only and within the limits of Client's instructions, if any. The Company's sole responsibility is to its Client and this document does not exonerate parties to a transaction from exercising all their rights and obligations under the transaction documents. This document cannot be reproduced except in full, without prior written approval of the Company. Any unauthorized alteration, forgery or falsification of the content or appearance of this document is unlawful and offenders may be prosecuted to the fullest extent of the law.

EVDO BC1_Body-worn_Back_CH 1175

Communication System: 1xEvDO; Frequency: 1908.75 MHz

Medium parameters used: $f = 1909$ MHz; $\sigma = 1.513$ S/m; $\epsilon_r = 53.621$; $\rho = 1000$ kg/m³

Phantom section: Flat Section

DASY5 Configuration:

- Probe: EX3DV4 - SN3770; ConvF(7.59, 7.59, 7.59); Calibrated: 2015/4/28;
- Sensor-Surface: 2mm (Mechanical Surface Detection)
- Electronics: DAE4 Sn856; Calibrated: 2014/8/27
- Phantom: Body;
- DASY52 52.8.8(1222); SEMCAD X 14.6.10(7331)

Configuration/Body/Area Scan (61x61x1): Interpolated grid: dx=15 mm, dy=15 mm

Maximum value of SAR (interpolated) = 1.37 W/kg

Configuration/Body/Zoom Scan (5x5x7)/Cube 0: Measurement grid:

dx=8mm, dy=8mm, dz=5mm

Reference Value = 4.984 V/m; Power Drift = 0.11 dB

Peak SAR (extrapolated) = 1.75 W/kg

SAR(1 g) = 1 W/kg; SAR(10 g) = 0.563 W/kg

Maximum value of SAR (measured) = 1.36 W/kg

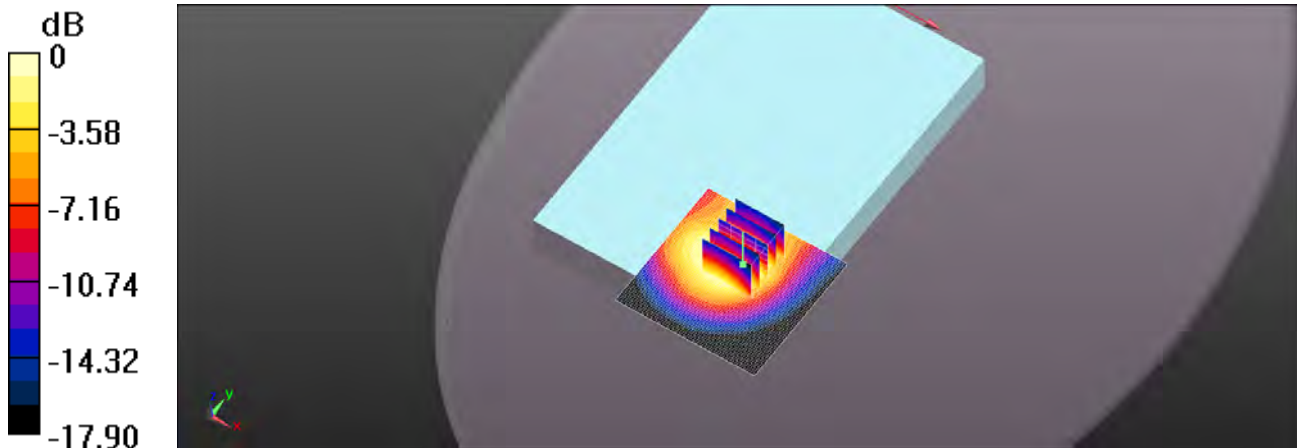

0 dB = 1.36 W/kg = 1.34 dBW/kg

Unless otherwise stated the results shown in this test report refer only to the sample(s) tested and such sample(s) are retained for 90 days only.

除非另有說明，此報告結果僅對測試之樣品負責，同時此樣品僅保留90天。本報告未經本公司書面許可，不可部份複製。

This document is issued by the Company subject to its General Conditions of Service printed overleaf, available on request or accessible at www.sgs.com/terms_and_conditions.htm and, for electronic format documents, subject to Terms and Conditions for Electronic Documents at www.sgs.com/terms_e-document.htm. Attention is drawn to the limitation of liability, indemnification and jurisdiction issues defined therein. Any holder of this document is advised that information contained hereon reflects the Company's findings at the time of its intervention only and within the limits of Client's instructions, if any. The Company's sole responsibility is to its Client and this document does not exonerate parties to a transaction from exercising all their rights and obligations under the transaction documents. This document cannot be reproduced except in full, without prior written approval of the Company. Any unauthorized alteration, forgery or falsification of the content or appearance of this document is unlawful and offenders may be prosecuted to the fullest extent of the law.

Date: 2015/6/16

EVDO BC10_Body-worn_Left side_CH 684

Communication System: 1xEvDO; Frequency: 823.1 MHz

Medium parameters used: $f = 823.1$ MHz; $\sigma = 0.999$ S/m; $\epsilon_r = 56.773$; $\rho = 1000$ kg/m³

Phantom section: Flat Section

DASY5 Configuration:

- Probe: EX3DV4 - SN3770; ConvF(9.17, 9.17, 9.17); Calibrated: 2015/4/28;
- Sensor-Surface: 2mm (Mechanical Surface Detection)
- Electronics: DAE4 Sn856; Calibrated: 2014/8/27
- Phantom: Body;
- DASY52 52.8.8(1222); SEMCAD X 14.6.10(7331)

Configuration/Body/Area Scan (71x121x1): Interpolated grid: dx=15 mm, dy=15 mm

Maximum value of SAR (interpolated) = 1.01 W/kg

Configuration/Body/Zoom Scan (5x5x7)/Cube 0: Measurement grid:

dx=8mm, dy=8mm, dz=5mm

Reference Value = 28.67 V/m; Power Drift = -0.10 dB

Peak SAR (extrapolated) = 1.20 W/kg

SAR(1 g) = 0.668 W/kg; SAR(10 g) = 0.412 W/kg

Maximum value of SAR (measured) = 0.995 W/kg

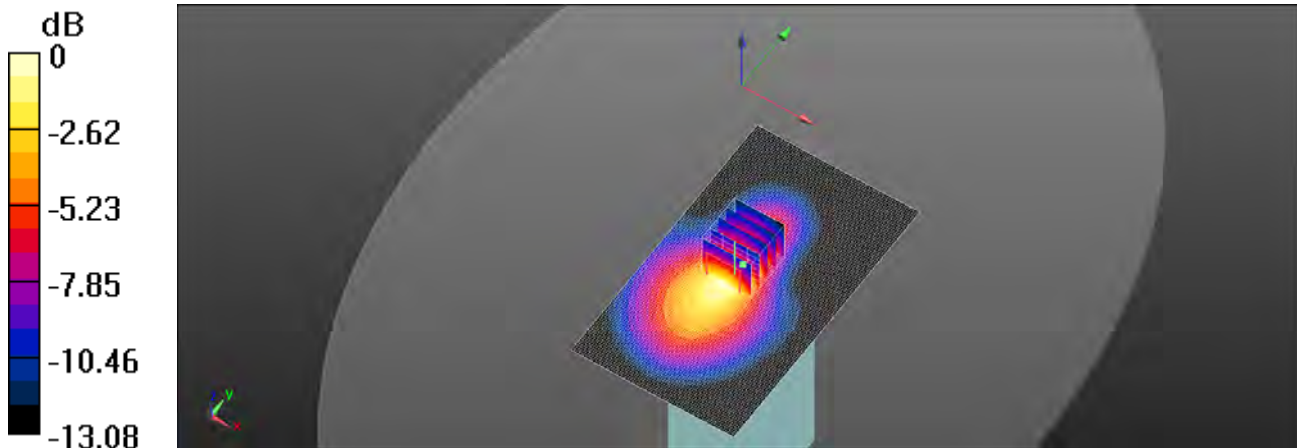

0 dB = 0.995 W/kg = -0.02 dBW/kg

Unless otherwise stated the results shown in this test report refer only to the sample(s) tested and such sample(s) are retained for 90 days only.

除非另有說明，此報告結果僅對測試之樣品負責，同時此樣品僅保留90天。本報告未經本公司書面許可，不可部份複製。

This document is issued by the Company subject to its General Conditions of Service printed overleaf, available on request or accessible at www.sgs.com/terms_and_conditions.htm and, for electronic format documents, subject to Terms and Conditions for Electronic Documents at www.sgs.com/terms_e-document.htm. Attention is drawn to the limitation of liability, indemnification and jurisdiction issues defined therein. Any holder of this document is advised that information contained hereon reflects the Company's findings at the time of its intervention only and within the limits of Client's instructions, if any. The Company's sole responsibility is to its Client and this document does not exonerate parties to a transaction from exercising all their rights and obligations under the transaction documents. This document cannot be reproduced except in full, without prior written approval of the Company. Any unauthorized alteration, forgery or falsification of the content or appearance of this document is unlawful and offenders may be prosecuted to the fullest extent of the law.

Date: 2015/6/19

WLAN802.11 b 2.4G_Body_Right side_CH 1_Main

Communication System: WLAN 2.45G; Frequency: 2412 MHz

Medium parameters used: $f = 2412$ MHz; $\sigma = 1.992$ S/m; $\epsilon_r = 51.436$; $\rho = 1000$ kg/m³

Phantom section: Flat Section

DASY5 Configuration:

- Probe: EX3DV4 - SN3770; ConvF(7.21, 7.21, 7.21); Calibrated: 2015/4/28;
- Sensor-Surface: 2mm (Mechanical Surface Detection)
- Electronics: DAE4 Sn856; Calibrated: 2014/8/27
- Phantom: Body;
- DASY52 52.8.8(1222); SEMCAD X 14.6.10(7331)

Configuration/Body/Area Scan (71x91x1): Interpolated grid: dx=12 mm, dy=12 mm

Maximum value of SAR (interpolated) = 1.58 W/kg

Configuration/Body/Zoom Scan (7x7x7)/Cube 0: Measurement grid:

dx=5mm, dy=5mm, dz=5mm

Reference Value = 6.773 V/m; Power Drift = 0.15 dB

Peak SAR (extrapolated) = 1.97 W/kg

SAR(1 g) = 0.915 W/kg; SAR(10 g) = 0.394 W/kg

Maximum value of SAR (measured) = 1.43 W/kg

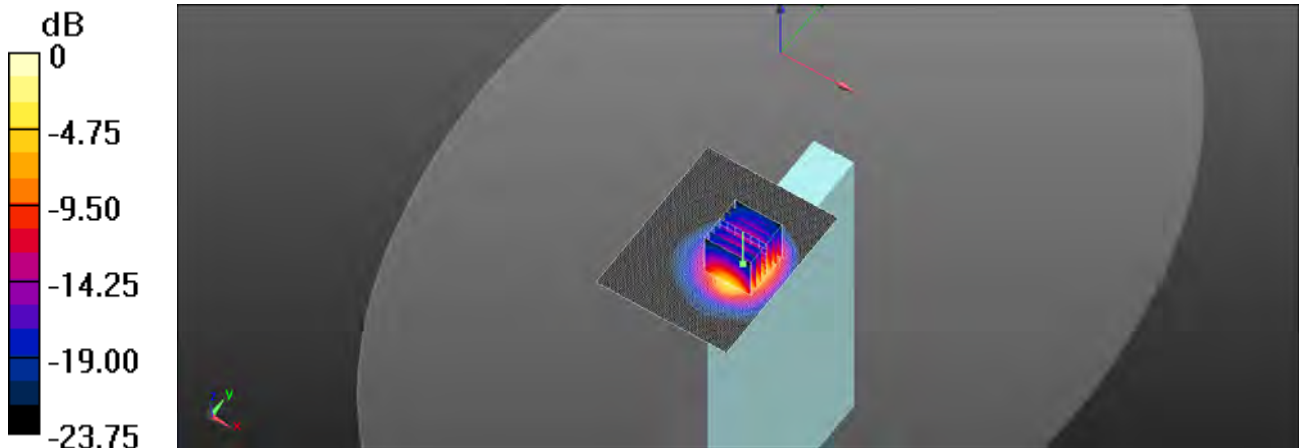

0 dB = 1.43 W/kg = 1.55 dBW/kg

Unless otherwise stated the results shown in this test report refer only to the sample(s) tested and such sample(s) are retained for 90 days only.

除非另有說明，此報告結果僅對測試之樣品負責，同時此樣品僅保留90天。本報告未經本公司書面許可，不可部份複製。

This document is issued by the Company subject to its General Conditions of Service printed overleaf, available on request or accessible at www.sgs.com/terms_and_conditions.htm and, for electronic format documents, subject to Terms and Conditions for Electronic Documents at www.sgs.com/terms_e-document.htm. Attention is drawn to the limitation of liability, indemnification and jurisdiction issues defined therein. Any holder of this document is advised that information contained hereon reflects the Company's findings at the time of its intervention only and within the limits of Client's instructions, if any. The Company's sole responsibility is to its Client and this document does not exonerate parties to a transaction from exercising all their rights and obligations under the transaction documents. This document cannot be reproduced except in full, without prior written approval of the Company. Any unauthorized alteration, forgery or falsification of the content or appearance of this document is unlawful and offenders may be prosecuted to the fullest extent of the law.

Date: 2015/6/20

WLAN802.11 a 5.2G_Body_Right side_CH 40_Main

Communication System: WLAN 5G; Frequency: 5200 MHz

Medium parameters used: $f = 5200 \text{ MHz}$; $\sigma = 5.462 \text{ S/m}$; $\epsilon_r = 47.93$; $\rho = 1000 \text{ kg/m}^3$

Phantom section: Flat Section

DASY5 Configuration:

- Probe: EX3DV4 - SN3770; ConvF(4.7, 4.7, 4.7); Calibrated: 2015/4/28;
- Sensor-Surface: 2mm (Mechanical Surface Detection)
- Electronics: DAE4 Sn856; Calibrated: 2014/8/27
- Phantom: Body;
- DASY52 52.8.8(1222); SEMCAD X 14.6.10(7331)

Configuration/Body/Area Scan (71x91x1): Interpolated grid: $dx=10 \text{ mm}$, $dy=10 \text{ mm}$

Maximum value of SAR (interpolated) = 0.708 W/kg

Configuration/Body/Zoom Scan (7x7x12)/Cube 0: Measurement grid:

$dx=4\text{mm}$, $dy=4\text{mm}$, $dz=2\text{mm}$

Reference Value = 11.54 V/m; Power Drift = -0.19 dB

Peak SAR (extrapolated) = 1.55 W/kg

SAR(1 g) = 0.383 W/kg; SAR(10 g) = 0.116 W/kg

Maximum value of SAR (measured) = 0.761 W/kg

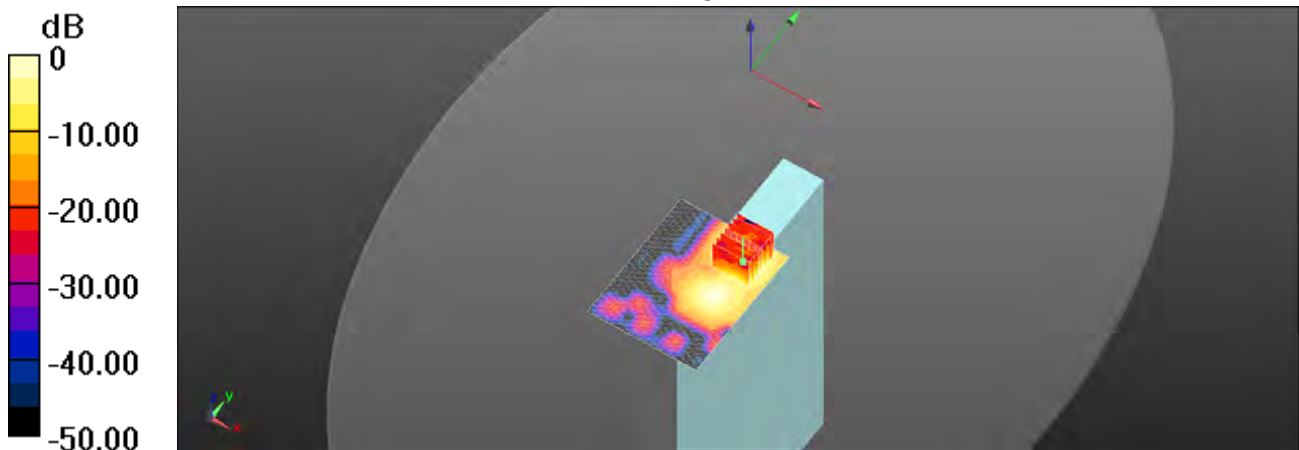

0 dB = 0.761 W/kg = -1.19 dBW/kg

Unless otherwise stated the results shown in this test report refer only to the sample(s) tested and such sample(s) are retained for 90 days only.

除非另有說明，此報告結果僅對測試之樣品負責，同時此樣品僅保留90天。本報告未經本公司書面許可，不可部份複製。

This document is issued by the Company subject to its General Conditions of Service printed overleaf, available on request or accessible at www.sgs.com/terms_and_conditions.htm and, for electronic format documents, subject to Terms and Conditions for Electronic Documents at www.sgs.com/terms_e-document.htm. Attention is drawn to the limitation of liability, indemnification and jurisdiction issues defined therein. Any holder of this document is advised that information contained hereon reflects the Company's findings at the time of its intervention only and within the limits of Client's instructions, if any. The Company's sole responsibility is to its Client and this document does not exonerate parties to a transaction from exercising all their rights and obligations under the transaction documents. This document cannot be reproduced except in full, without prior written approval of the Company. Any unauthorized alteration, forgery or falsification of the content or appearance of this document is unlawful and offenders may be prosecuted to the fullest extent of the law.

Date: 2015/6/20

WLAN802.11 n(40M) 5.2G_Body_Right side_CH 46_Main

Communication System: WLAN 5G; Frequency: 5230 MHz

Medium parameters used: $f = 5230$ MHz; $\sigma = 5.507$ S/m; $\epsilon_r = 47.832$; $\rho = 1000$ kg/m³

Phantom section: Flat Section

DASY5 Configuration:

- Probe: EX3DV4 - SN3770; ConvF(4.7, 4.7, 4.7); Calibrated: 2015/4/28;
- Sensor-Surface: 2mm (Mechanical Surface Detection)
- Electronics: DAE4 Sn856; Calibrated: 2014/8/27
- Phantom: Body;
- DASY52 52.8.8(1222); SEMCAD X 14.6.10(7331)

Configuration/Body/Area Scan (71x91x1): Interpolated grid: dx=10 mm, dy=10 mm

Maximum value of SAR (interpolated) = 0.593 W/kg

Configuration/Body/Zoom Scan (7x7x12)/Cube 0: Measurement grid:

dx=4mm, dy=4mm, dz=2mm

Reference Value = 9.846 V/m; Power Drift = -0.12 dB

Peak SAR (extrapolated) = 1.29 W/kg

SAR(1 g) = 0.303 W/kg; SAR(10 g) = 0.090 W/kg

Maximum value of SAR (measured) = 0.587 W/kg

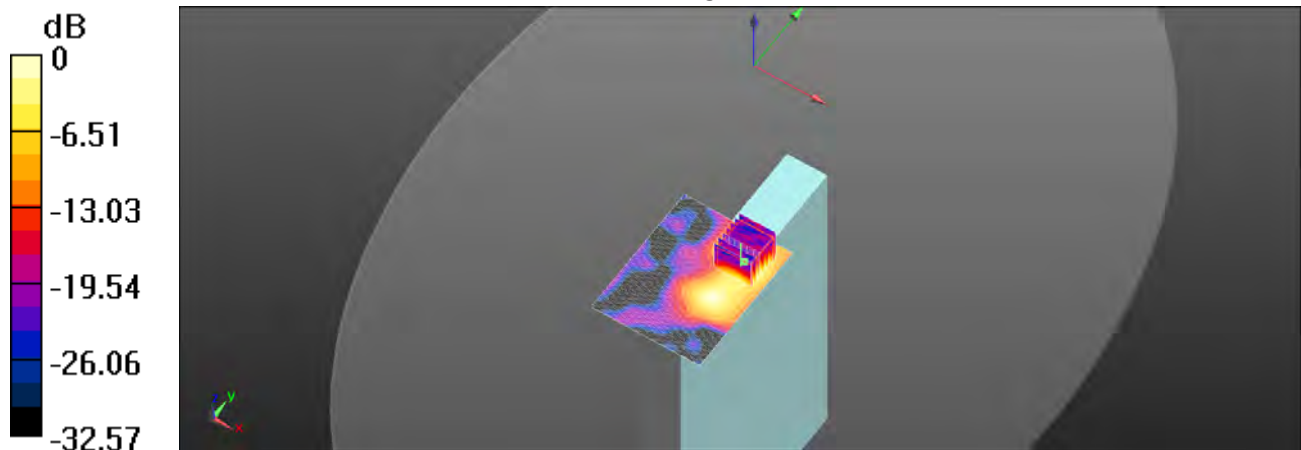

0 dB = 0.587 W/kg = -2.31 dBW/kg

Unless otherwise stated the results shown in this test report refer only to the sample(s) tested and such sample(s) are retained for 90 days only.

除非另有說明，此報告結果僅對測試之樣品負責，同時此樣品僅保留90天。本報告未經本公司書面許可，不可部份複製。

This document is issued by the Company subject to its General Conditions of Service printed overleaf, available on request or accessible at www.sgs.com/terms_and_conditions.htm and, for electronic format documents, subject to Terms and Conditions for Electronic Documents at www.sgs.com/terms_e-document.htm. Attention is drawn to the limitation of liability, indemnification and jurisdiction issues defined therein. Any holder of this document is advised that information contained hereon reflects the Company's findings at the time of its intervention only and within the limits of Client's instructions, if any. The Company's sole responsibility is to its Client and this document does not exonerate parties to a transaction from exercising all their rights and obligations under the transaction documents. This document cannot be reproduced except in full, without prior written approval of the Company. Any unauthorized alteration, forgery or falsification of the content or appearance of this document is unlawful and offenders may be prosecuted to the fullest extent of the law.

Date: 2015/6/21

WLAN802.11 n(20M) 5.3G_Body_Right side_CH 60_Main

Communication System: WLAN 5G; Frequency: 5300 MHz

Medium parameters used: $f = 5300$ MHz; $\sigma = 5.609$ S/m; $\epsilon_r = 47.56$; $\rho = 1000$ kg/m³

Phantom section: Flat Section

DASY5 Configuration:

- Probe: EX3DV4 - SN3770; ConvF(4.7, 4.7, 4.7); Calibrated: 2015/4/28;
- Sensor-Surface: 2mm (Mechanical Surface Detection)
- Electronics: DAE4 Sn856; Calibrated: 2014/8/27
- Phantom: Body;
- DASY52 52.8.8(1222); SEMCAD X 14.6.10(7331)

Configuration/Body/Area Scan (71x91x1): Interpolated grid: dx=10 mm, dy=10 mm

Maximum value of SAR (interpolated) = 0.498 W/kg

Configuration/Body/Zoom Scan (7x7x12)/Cube 0: Measurement grid:

dx=4mm, dy=4mm, dz=2mm

Reference Value = 4.687 V/m; Power Drift = 0.12 dB

Peak SAR (extrapolated) = 1.07 W/kg

SAR(1 g) = 0.261 W/kg; SAR(10 g) = 0.078 W/kg.

Maximum value of SAR (measured) = 0.522 W/kg

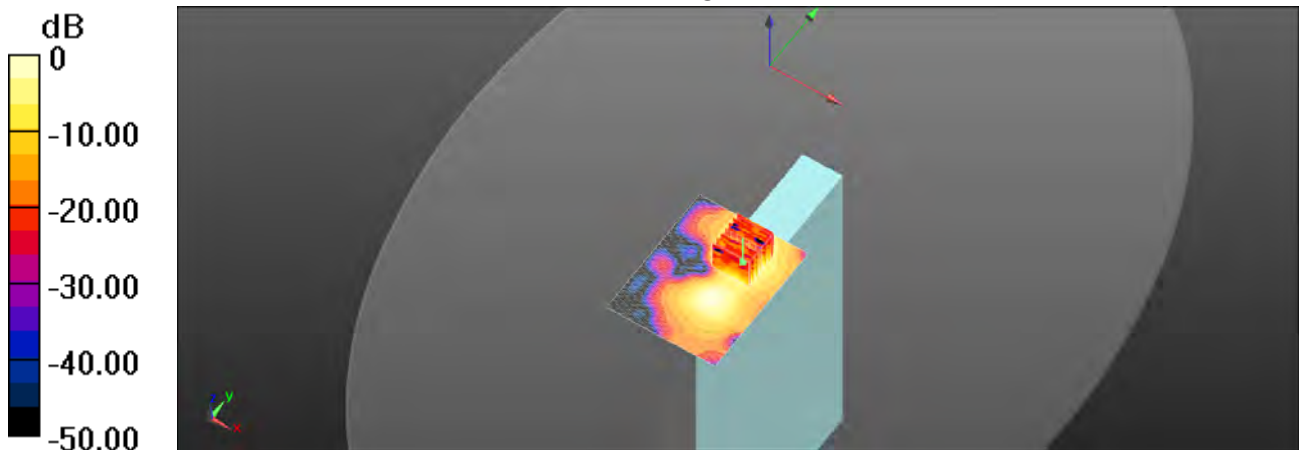

0 dB = 0.522 W/kg = -2.82 dBW/kg

Unless otherwise stated the results shown in this test report refer only to the sample(s) tested and such sample(s) are retained for 90 days only.

除非另有說明，此報告結果僅對測試之樣品負責，同時此樣品僅保留90天。本報告未經本公司書面許可，不可部份複製。

This document is issued by the Company subject to its General Conditions of Service printed overleaf, available on request or accessible at www.sgs.com/terms_and_conditions.htm and, for electronic format documents, subject to Terms and Conditions for Electronic Documents at www.sgs.com/terms_e-document.htm. Attention is drawn to the limitation of liability, indemnification and jurisdiction issues defined therein. Any holder of this document is advised that information contained hereon reflects the Company's findings at the time of its intervention only and within the limits of Client's instructions, if any. The Company's sole responsibility is to its Client and this document does not exonerate parties to a transaction from exercising all their rights and obligations under the transaction documents. This document cannot be reproduced except in full, without prior written approval of the Company. Any unauthorized alteration, forgery or falsification of the content or appearance of this document is unlawful and offenders may be prosecuted to the fullest extent of the law.

Date: 2015/6/21

WLAN802.11 n(40M) 5.3G_Body_Right side_CH 54_Main

Communication System: WLAN 5G; Frequency: 5270 MHz

 Medium parameters used: $f = 5270$ MHz; $\sigma = 5.567$ S/m; $\epsilon_r = 47.696$; $\rho = 1000$ kg/m³

Phantom section: Flat Section

DASY5 Configuration:

- Probe: EX3DV4 - SN3770; ConvF(4.7, 4.7, 4.7); Calibrated: 2015/4/28;
- Sensor-Surface: 2mm (Mechanical Surface Detection)
- Electronics: DAE4 Sn856; Calibrated: 2014/8/27
- Phantom: Body;
- DASY52 52.8.8(1222); SEMCAD X 14.6.10(7331)

Configuration/Body/Area Scan (71x91x1): Interpolated grid: dx=10 mm, dy=10 mm

Maximum value of SAR (interpolated) = 0.534 W/kg

Configuration/Body/Zoom Scan (7x7x12)/Cube 0: Measurement grid:

dx=4mm, dy=4mm, dz=2mm

Reference Value = 8.546 V/m; Power Drift = 0.04 dB

Peak SAR (extrapolated) = 1.12 W/kg

SAR(1 g) = 0.270 W/kg; SAR(10 g) = 0.082 W/kg

Maximum value of SAR (measured) = 0.519 W/kg

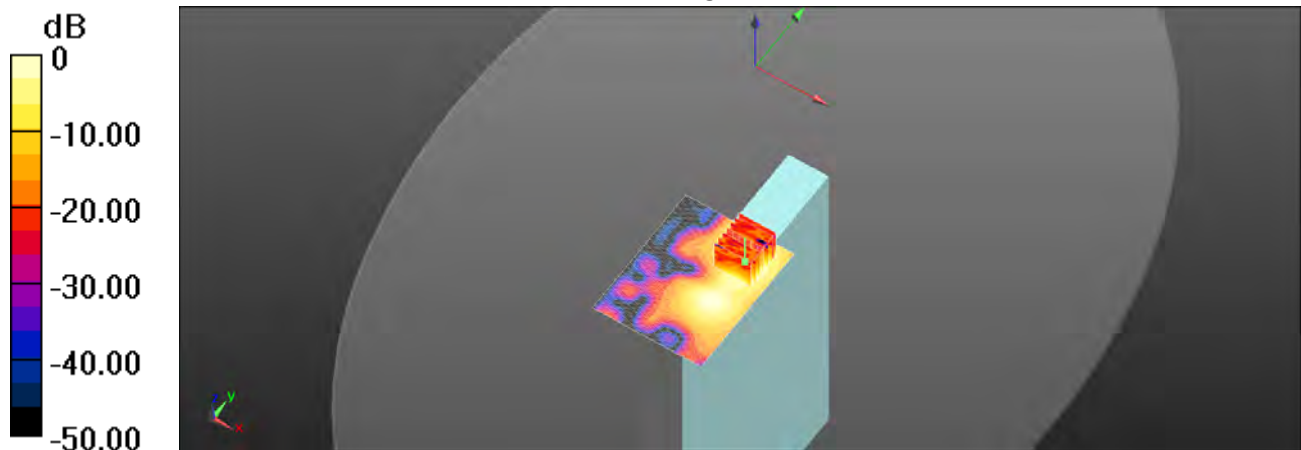

0 dB = 0.519 W/kg = -2.85 dBW/kg

Unless otherwise stated the results shown in this test report refer only to the sample(s) tested and such sample(s) are retained for 90 days only.

除非另有說明，此報告結果僅對測試之樣品負責，同時此樣品僅保留90天。本報告未經本公司書面許可，不可部份複製。

This document is issued by the Company subject to its General Conditions of Service printed overleaf, available on request or accessible at www.sgs.com/terms_and_conditions.htm and, for electronic format documents, subject to Terms and Conditions for Electronic Documents at www.sgs.com/terms_e-document.htm. Attention is drawn to the limitation of liability, indemnification and jurisdiction issues defined therein. Any holder of this document is advised that information contained hereon reflects the Company's findings at the time of its intervention only and within the limits of Client's instructions, if any. The Company's sole responsibility is to its Client and this document does not exonerate parties to a transaction from exercising all their rights and obligations under the transaction documents. This document cannot be reproduced except in full, without prior written approval of the Company. Any unauthorized alteration, forgery or falsification of the content or appearance of this document is unlawful and offenders may be prosecuted to the fullest extent of the law.

SGS Taiwan Ltd.

No.134,Wu Kung Road, New Taipei Industrial Park, Wuku District, New Taipei City, Taiwan 24803/新北市五股區新北產業園區五工路 134 號

台灣檢驗科技股份有限公司

t (886-2) 2299-3279

f (886-2) 2298-0488

www.tw.sgs.com

Member of SGS Group

WLAN802.11 n(20M) 5.6G_Body_Right side_CH 104_Main

Communication System: WLAN 5G; Frequency: 5520 MHz

Medium parameters used: $f = 5520 \text{ MHz}$; $\sigma = 5.91 \text{ S/m}$; $\epsilon_r = 46.795$; $\rho = 1000 \text{ kg/m}^3$

Phantom section: Flat Section

DASY5 Configuration:

- Probe: EX3DV4 - SN3770; ConvF(4.03, 4.03, 4.03); Calibrated: 2015/4/28;
- Sensor-Surface: 2mm (Mechanical Surface Detection)
- Electronics: DAE4 Sn856; Calibrated: 2014/8/27
- Phantom: Body;
- DASY52 52.8.8(1222); SEMCAD X 14.6.10(7331)

Configuration/Body/Area Scan (71x91x1): Interpolated grid: $dx=10 \text{ mm}$, $dy=10 \text{ mm}$

Maximum value of SAR (interpolated) = 0.549 W/kg

Configuration/Body/Zoom Scan (7x7x12)/Cube 0: Measurement grid:

$dx=4\text{mm}$, $dy=4\text{mm}$, $dz=2\text{mm}$

Reference Value = 8.736 V/m; Power Drift = 0.16 dB

Peak SAR (extrapolated) = 1.12 W/kg

SAR(1 g) = 0.276 W/kg; SAR(10 g) = 0.085 W/kg

Maximum value of SAR (measured) = 0.539 W/kg

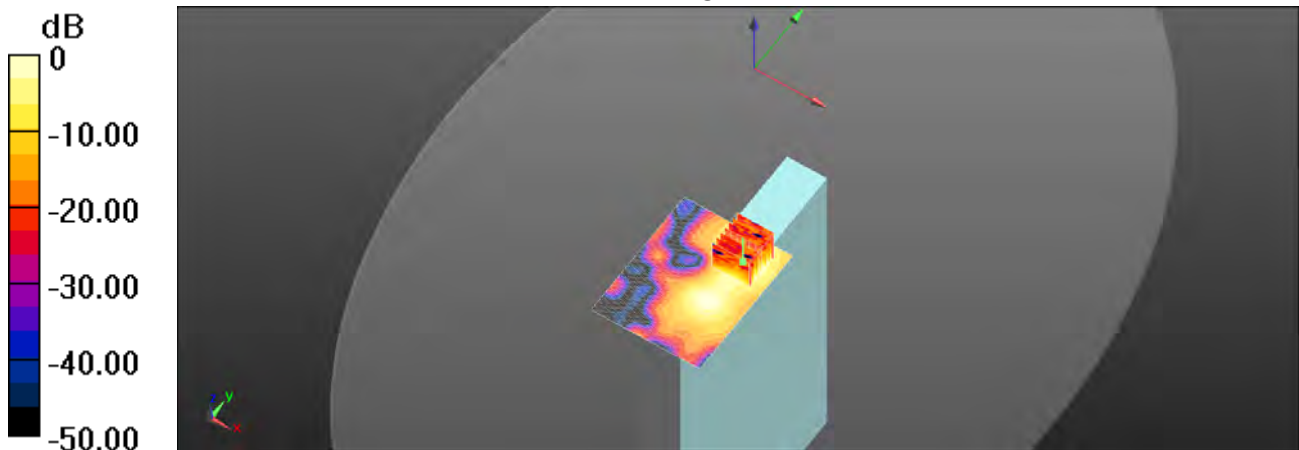

0 dB = 0.539 W/kg = -2.68 dBW/kg

Unless otherwise stated the results shown in this test report refer only to the sample(s) tested and such sample(s) are retained for 90 days only.

除非另有說明，此報告結果僅對測試之樣品負責，同時此樣品僅保留90天。本報告未經本公司書面許可，不可部份複製。

This document is issued by the Company subject to its General Conditions of Service printed overleaf, available on request or accessible at www.sgs.com/terms_and_conditions.htm and, for electronic format documents, subject to Terms and Conditions for Electronic Documents at www.sgs.com/terms_e-document.htm. Attention is drawn to the limitation of liability, indemnification and jurisdiction issues defined therein. Any holder of this document is advised that information contained hereon reflects the Company's findings at the time of its intervention only and within the limits of Client's instructions, if any. The Company's sole responsibility is to its Client and this document does not exonerate parties to a transaction from exercising all their rights and obligations under the transaction documents. This document cannot be reproduced except in full, without prior written approval of the Company. Any unauthorized alteration, forgery or falsification of the content or appearance of this document is unlawful and offenders may be prosecuted to the fullest extent of the law.

Date: 2015/6/22

WLAN802.11 n(20M) 5.6G_Body_Right side_CH 120_Main

Communication System: WLAN 5G; Frequency: 5600 MHz

Medium parameters used: $f = 5600$ MHz; $\sigma = 6.004$ S/m; $\epsilon_r = 46.575$; $\rho = 1000$ kg/m³

Phantom section: Flat Section

DASY5 Configuration:

- Probe: EX3DV4 - SN3770; ConvF(4.03, 4.03, 4.03); Calibrated: 2015/4/28;
- Sensor-Surface: 2mm (Mechanical Surface Detection)
- Electronics: DAE4 Sn856; Calibrated: 2014/8/27
- Phantom: Body;
- DASY52 52.8.8(1222); SEMCAD X 14.6.10(7331)

Configuration/Body/Area Scan (71x91x1): Interpolated grid: dx=10 mm, dy=10 mm

Maximum value of SAR (interpolated) = 0.598 W/kg

Configuration/Body/Zoom Scan (7x7x12)/Cube 0: Measurement grid: dx=4mm, dy=4mm, dz=2mm

Reference Value = 5.764 V/m; Power Drift = 0.15 dB

Peak SAR (extrapolated) = 1.39 W/kg

SAR(1 g) = 0.313 W/kg; SAR(10 g) = 0.098 W/kg.

Maximum value of SAR (measured) = 0.632 W/kg

Configuration/Body/Zoom Scan (7x7x12)/Cube 1: Measurement grid:

dx=4mm, dy=4mm, dz=2mm

Reference Value = 5.764 V/m; Power Drift = 0.15 dB

Peak SAR (extrapolated) = 1.19 W/kg

SAR(1 g) = 0.251 W/kg; SAR(10 g) = 0.065 W/kg

Maximum value of SAR (measured) = 0.546 W/kg

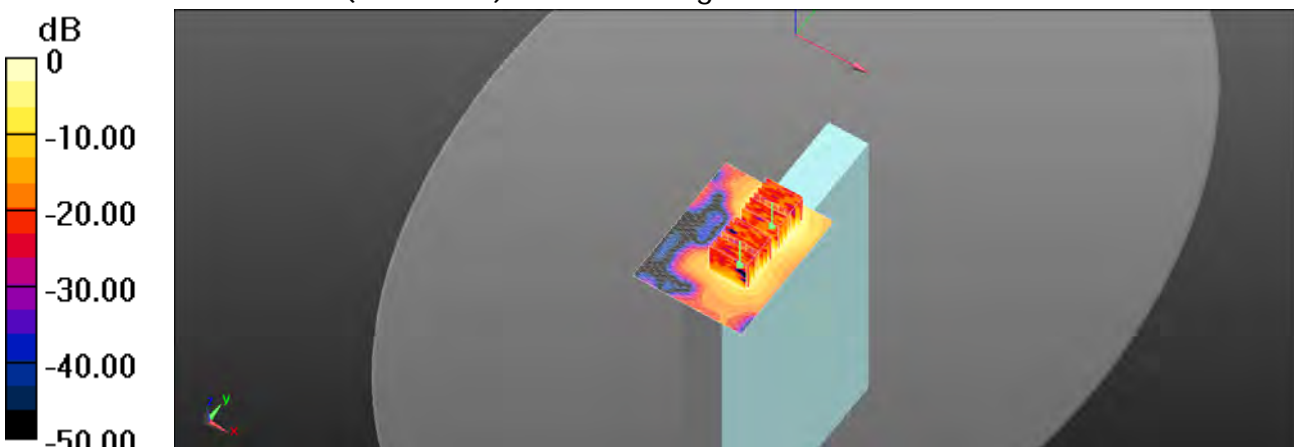

0 dB = 0.546 W/kg = -2.63 dBW/kg

Unless otherwise stated the results shown in this test report refer only to the sample(s) tested and such sample(s) are retained for 90 days only.

除非另有說明，此報告結果僅對測試之樣品負責，同時此樣品僅保留90天。本報告未經本公司書面許可，不可部份複製。

This document is issued by the Company subject to its General Conditions of Service printed overleaf, available on request or accessible at www.sgs.com/terms_and_conditions.htm and, for electronic format documents, subject to Terms and Conditions for Electronic Documents at www.sgs.com/terms_e-document.htm. Attention is drawn to the limitation of liability, indemnification and jurisdiction issues defined therein. Any holder of this document is advised that information contained hereon reflects the Company's findings at the time of its intervention only and within the limits of Client's instructions, if any. The Company's sole responsibility is to its Client and this document does not exonerate parties to a transaction from exercising all their rights and obligations under the transaction documents. This document cannot be reproduced except in full, without prior written approval of the Company. Any unauthorized alteration, forgery or falsification of the content or appearance of this document is unlawful and offenders may be prosecuted to the fullest extent of the law.

Date: 2015/6/22

WLAN802.11 n(20M) 5.6G_Body_Right side_CH 140_Main

Communication System: WLAN 5G; Frequency: 5700 MHz

 Medium parameters used: $f = 5700 \text{ MHz}$; $\sigma = 6.037 \text{ S/m}$; $\epsilon_r = 46.301$; $\rho = 1000 \text{ kg/m}^3$

Phantom section: Flat Section

DASY5 Configuration:

- Probe: EX3DV4 - SN3770; ConvF(4.03, 4.03, 4.03); Calibrated: 2015/4/28;
- Sensor-Surface: 2mm (Mechanical Surface Detection)
- Electronics: DAE4 Sn856; Calibrated: 2014/8/27
- Phantom: Body;
- DASY52 52.8.8(1222); SEMCAD X 14.6.10(7331)

Configuration/Body/Area Scan (71x91x1): Interpolated grid: $dx=10 \text{ mm}$, $dy=10 \text{ mm}$

Maximum value of SAR (interpolated) = 0.624 W/kg

Configuration/Body/Zoom Scan (7x7x12)/Cube 0: Measurement grid:

 $dx=4\text{mm}$, $dy=4\text{mm}$, $dz=2\text{mm}$

Reference Value = 6.024 V/m; Power Drift = 0.16 dB

Peak SAR (extrapolated) = 1.41 W/kg

SAR(1 g) = 0.324 W/kg; SAR(10 g) = 0.102 W/kg

Maximum value of SAR (measured) = 0.655 W/kg

Configuration/Body/Zoom Scan (7x7x12)/Cube 1: Measurement grid:

 $dx=4\text{mm}$, $dy=4\text{mm}$, $dz=2\text{mm}$

Reference Value = 6.024 V/m; Power Drift = 0.16 dB

Peak SAR (extrapolated) = 1.31 W/kg

SAR(1 g) = 0.263 W/kg; SAR(10 g) = 0.069 W/kg

Maximum value of SAR (measured) = 0.565 W/kg

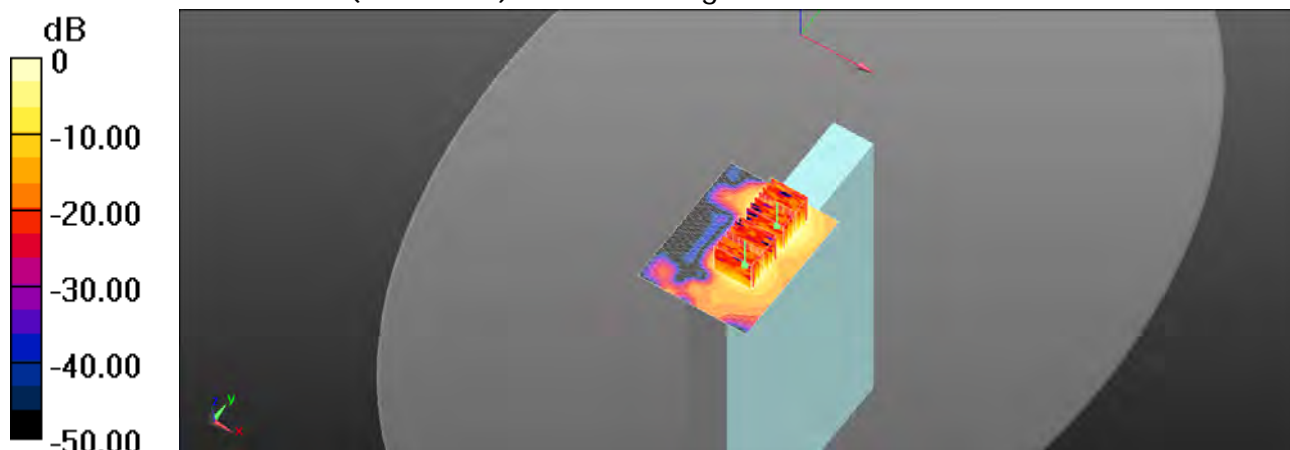
 $0 \text{ dB} = 0.565 \text{ W/kg} = -2.48 \text{ dBW/kg}$

Unless otherwise stated the results shown in this test report refer only to the sample(s) tested and such sample(s) are retained for 90 days only.

除非另有說明，此報告結果僅對測試之樣品負責，同時此樣品僅保留90天。本報告未經本公司書面許可，不可部份複製。

This document is issued by the Company subject to its General Conditions of Service printed overleaf, available on request or accessible at www.sgs.com/terms_and_conditions.htm and, for electronic format documents, subject to Terms and Conditions for Electronic Documents at www.sgs.com/terms_e-document.htm. Attention is drawn to the limitation of liability, indemnification and jurisdiction issues defined therein. Any holder of this document is advised that information contained hereon reflects the Company's findings at the time of its intervention only and within the limits of Client's instructions, if any. The Company's sole responsibility is to its Client and this document does not exonerate parties to a transaction from exercising all their rights and obligations under the transaction documents. This document cannot be reproduced except in full, without prior written approval of the Company. Any unauthorized alteration, forgery or falsification of the content or appearance of this document is unlawful and offenders may be prosecuted to the fullest extent of the law.

Date: 2015/6/22

WLAN802.11 n(40M) 5.8G_Body_Right side_CH 159_Main

Communication System: WLAN 5G; Frequency: 5795 MHz

Medium parameters used: $f = 5795$ MHz; $\sigma = 6.208$ S/m; $\epsilon_r = 46.024$; $\rho = 1000$ kg/m³

Phantom section: Flat Section

DASY5 Configuration:

- Probe: EX3DV4 - SN3770; ConvF(4.33, 4.33, 4.33); Calibrated: 2015/4/28;
- Sensor-Surface: 2mm (Mechanical Surface Detection)
- Electronics: DAE4 Sn856; Calibrated: 2014/8/27
- Phantom: Body;
- DASY52 52.8.8(1222); SEMCAD X 14.6.10(7331)

Configuration/Body/Area Scan (71x91x1): Interpolated grid: dx=10 mm, dy=10 mm.

Maximum value of SAR (interpolated) = 0.733 W/kg

Configuration/Body/Zoom Scan (7x7x12)/Cube 0: Measurement grid:

dx=4mm, dy=4mm, dz=2mm

Reference Value = 6.559 V/m; Power Drift = 0.09 dB

Peak SAR (extrapolated) = 1.58 W/kg

SAR(1 g) = 0.349 W/kg; SAR(10 g) = 0.099 W/kg

Maximum value of SAR (measured) = 0.740 W/kg

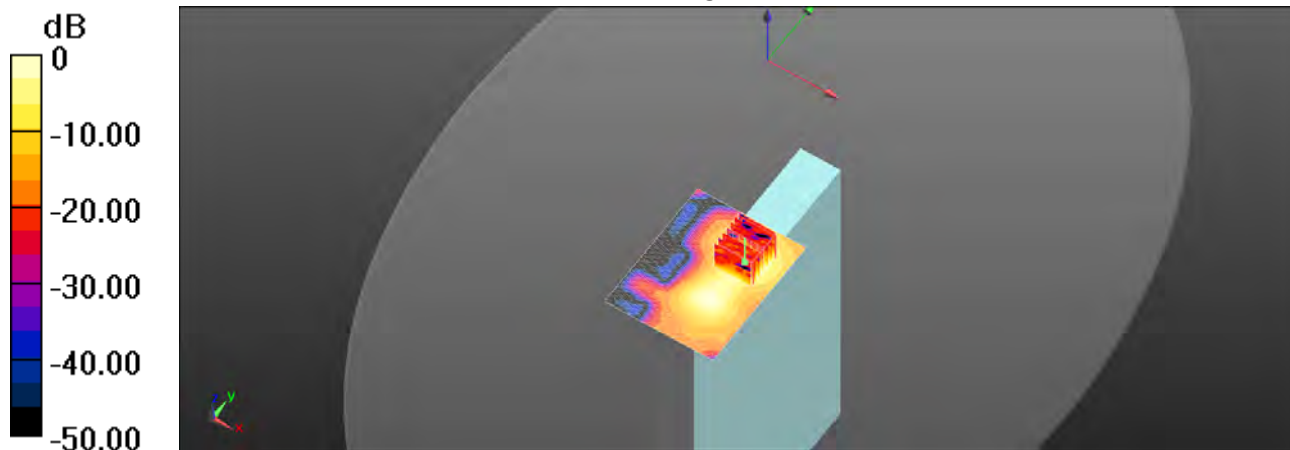

0 dB = 0.740 W/kg = -1.31 dBW/kg

Unless otherwise stated the results shown in this test report refer only to the sample(s) tested and such sample(s) are retained for 90 days only.

除非另有說明，此報告結果僅對測試之樣品負責，同時此樣品僅保留90天。本報告未經本公司書面許可，不可部份複製。

This document is issued by the Company subject to its General Conditions of Service printed overleaf, available on request or accessible at www.sgs.com/terms_and_conditions.htm and, for electronic format documents, subject to Terms and Conditions for Electronic Documents at www.sgs.com/terms_e-document.htm. Attention is drawn to the limitation of liability, indemnification and jurisdiction issues defined therein. Any holder of this document is advised that information contained hereon reflects the Company's findings at the time of its intervention only and within the limits of Client's instructions, if any. The Company's sole responsibility is to its Client and this document does not exonerate parties to a transaction from exercising all their rights and obligations under the transaction documents. This document cannot be reproduced except in full, without prior written approval of the Company. Any unauthorized alteration, forgery or falsification of the content or appearance of this document is unlawful and offenders may be prosecuted to the fullest extent of the law.

Date: 2015/6/19

WLAN802.11 b 2.4G_Body_Top side_CH 6_Aux

Communication System: WLAN 2.45G; Frequency: 2437 MHz

Medium parameters used: $f = 2437$ MHz; $\sigma = 2.019$ S/m; $\epsilon_r = 51.353$; $\rho = 1000$ kg/m³

Phantom section: Flat Section

DASY5 Configuration:

- Probe: EX3DV4 - SN3770; ConvF(7.21, 7.21, 7.21); Calibrated: 2015/4/28;
- Sensor-Surface: 2mm (Mechanical Surface Detection)
- Electronics: DAE4 Sn856; Calibrated: 2014/8/27
- Phantom: Body;
- DASY52 52.8.8(1222); SEMCAD X 14.6.10(7331)

Configuration/Body/Area Scan (71x71x1): Interpolated grid: dx=12 mm, dy=12 mm

Maximum value of SAR (interpolated) = 1.60 W/kg

Configuration/Body/Zoom Scan (7x7x7)/Cube 0: Measurement grid:

dx=5mm, dy=5mm, dz=5mm

Reference Value = 23.52 V/m; Power Drift = 0.14 dB

Peak SAR (extrapolated) = 2.20 W/kg

SAR(1 g) = 0.830 W/kg; SAR(10 g) = 0.315 W/kg

Maximum value of SAR (measured) = 1.36 W/kg

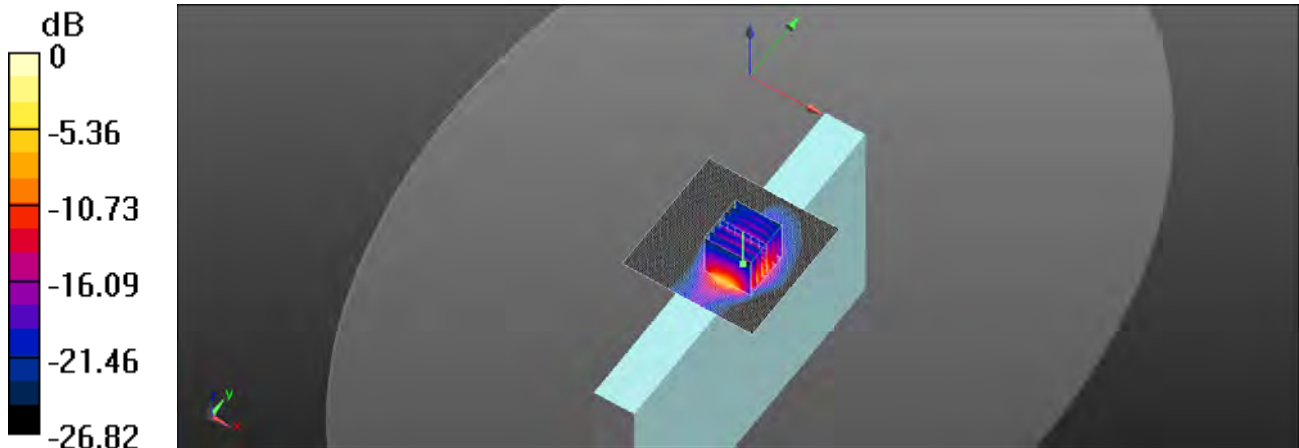

0 dB = 1.36 W/kg = 1.34 dBW/kg

Unless otherwise stated the results shown in this test report refer only to the sample(s) tested and such sample(s) are retained for 90 days only.

除非另有說明，此報告結果僅對測試之樣品負責，同時此樣品僅保留90天。本報告未經本公司書面許可，不可部份複製。

This document is issued by the Company subject to its General Conditions of Service printed overleaf, available on request or accessible at www.sgs.com/terms_and_conditions.htm and, for electronic format documents, subject to Terms and Conditions for Electronic Documents at www.sgs.com/terms_e-document.htm. Attention is drawn to the limitation of liability, indemnification and jurisdiction issues defined therein. Any holder of this document is advised that information contained hereon reflects the Company's findings at the time of its intervention only and within the limits of Client's instructions, if any. The Company's sole responsibility is to its Client and this document does not exonerate parties to a transaction from exercising all their rights and obligations under the transaction documents. This document cannot be reproduced except in full, without prior written approval of the Company. Any unauthorized alteration, forgery or falsification of the content or appearance of this document is unlawful and offenders may be prosecuted to the fullest extent of the law.

Date: 2015/6/20

WLAN802.11 a 5.2G_Body_Top side_CH 36_Aux

Communication System: WLAN 5G; Frequency: 5180 MHz

Medium parameters used: $f = 5180 \text{ MHz}$; $\sigma = 5.424 \text{ S/m}$; $\epsilon_r = 48.079$; $\rho = 1000 \text{ kg/m}^3$

Phantom section: Flat Section

DASY5 Configuration:

- Probe: EX3DV4 - SN3770; ConvF(4.7, 4.7, 4.7); Calibrated: 2015/4/28;
- Sensor-Surface: 2mm (Mechanical Surface Detection)
- Electronics: DAE4 Sn856; Calibrated: 2014/8/27
- Phantom: Body;
- DASY52 52.8.8(1222); SEMCAD X 14.6.10(7331)

Configuration/Body/Area Scan (71x71x1): Interpolated grid: $dx=10 \text{ mm}$, $dy=10 \text{ mm}$

Maximum value of SAR (interpolated) = 1.53 W/kg

Configuration/Body/Zoom Scan (7x7x12)/Cube 0: Measurement grid: $dx=4\text{mm}$, $dy=4\text{mm}$, $dz=2\text{mm}$

Reference Value = 7.653 V/m; Power Drift = 0.12 dB

Peak SAR (extrapolated) = 4.05 W/kg

SAR(1 g) = 0.792 W/kg; SAR(10 g) = 0.197 W/kg

Maximum value of SAR (measured) = 1.72 W/kg

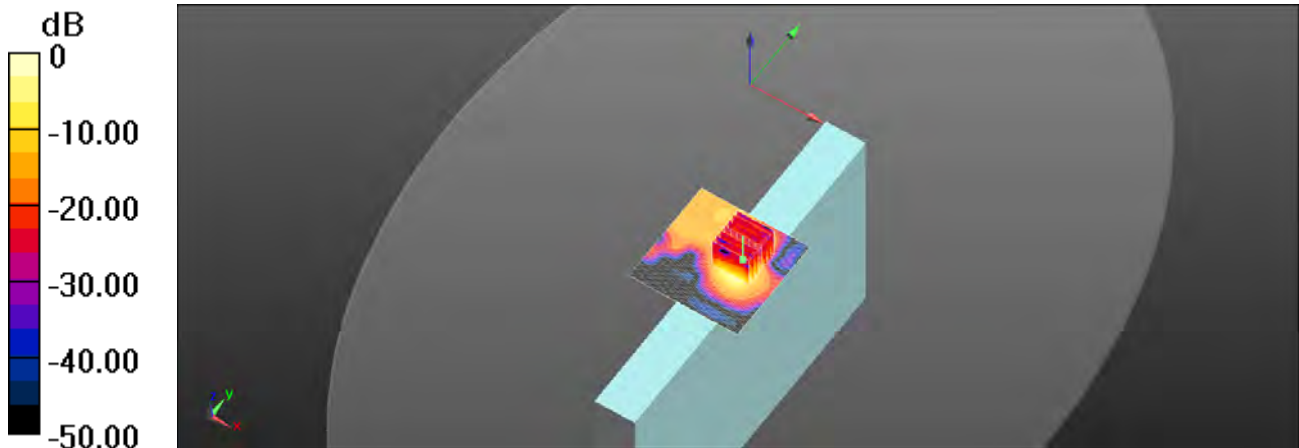

0 dB = 1.72 W/kg = 2.36 dBW/kg

Unless otherwise stated the results shown in this test report refer only to the sample(s) tested and such sample(s) are retained for 90 days only.

除非另有說明，此報告結果僅對測試之樣品負責，同時此樣品僅保留90天。本報告未經本公司書面許可，不可部份複製。

This document is issued by the Company subject to its General Conditions of Service printed overleaf, available on request or accessible at www.sgs.com/terms_and_conditions.htm and, for electronic format documents, subject to Terms and Conditions for Electronic Documents at www.sgs.com/terms_e-document.htm. Attention is drawn to the limitation of liability, indemnification and jurisdiction issues defined therein. Any holder of this document is advised that information contained hereon reflects the Company's findings at the time of its intervention only and within the limits of Client's instructions, if any. The Company's sole responsibility is to its Client and this document does not exonerate parties to a transaction from exercising all their rights and obligations under the transaction documents. This document cannot be reproduced except in full, without prior written approval of the Company. Any unauthorized alteration, forgery or falsification of the content or appearance of this document is unlawful and offenders may be prosecuted to the fullest extent of the law.

Date: 2015/6/21

WLAN802.11 n(40M) 5.2G_Body_Top side_CH 46_Aux

Communication System: WLAN 5G; Frequency: 5230 MHz

Medium parameters used: $f = 5230$ MHz; $\sigma = 5.507$ S/m; $\epsilon_r = 47.832$; $\rho = 1000$ kg/m³

Phantom section: Flat Section

DASY5 Configuration:

- Probe: EX3DV4 - SN3770; ConvF(4.7, 4.7, 4.7); Calibrated: 2015/4/28;
- Sensor-Surface: 2mm (Mechanical Surface Detection)
- Electronics: DAE4 Sn856; Calibrated: 2014/8/27
- Phantom: Body;
- DASY52 52.8.8(1222); SEMCAD X 14.6.10(7331)

Configuration/Body/Area Scan (71x71x1): Interpolated grid: dx=10 mm, dy=10 mm

Maximum value of SAR (interpolated) = 1.62 W/kg

Configuration/Body/Zoom Scan (7x7x12)/Cube 0: Measurement grid:

dx=4mm, dy=4mm, dz=2mm

Reference Value = 4.568 V/m; Power Drift = 0.17 dB

Peak SAR (extrapolated) = 4.17 W/kg

SAR(1 g) = 0.775 W/kg; SAR(10 g) = 0.194 W/kg

Maximum value of SAR (measured) = 1.64 W/kg

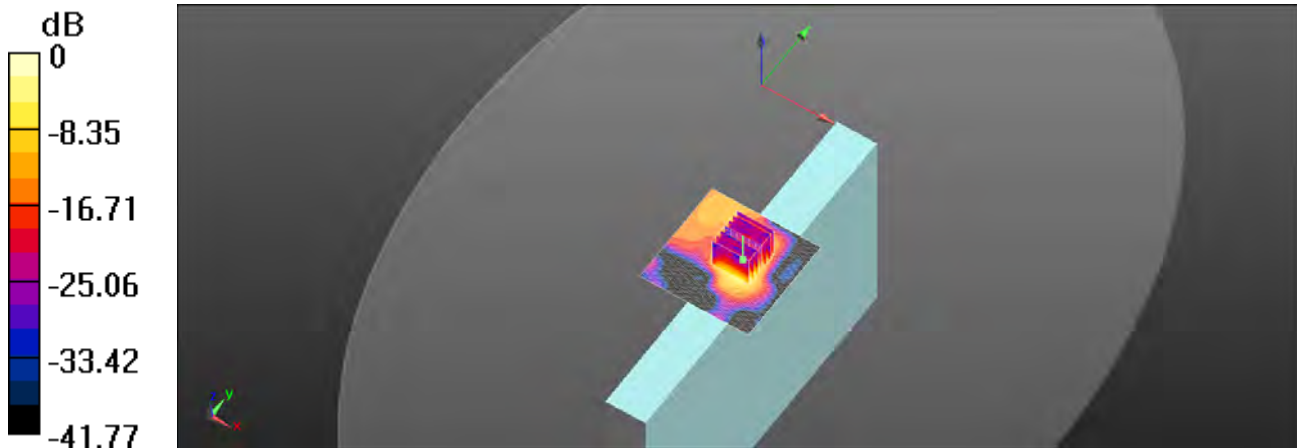

0 dB = 1.64 W/kg = 2.15 dBW/kg

Unless otherwise stated the results shown in this test report refer only to the sample(s) tested and such sample(s) are retained for 90 days only.

除非另有說明，此報告結果僅對測試之樣品負責，同時此樣品僅保留90天。本報告未經本公司書面許可，不可部份複製。

This document is issued by the Company subject to its General Conditions of Service printed overleaf, available on request or accessible at www.sgs.com/terms_and_conditions.htm and, for electronic format documents, subject to Terms and Conditions for Electronic Documents at www.sgs.com/terms_e-document.htm. Attention is drawn to the limitation of liability, indemnification and jurisdiction issues defined therein. Any holder of this document is advised that information contained hereon reflects the Company's findings at the time of its intervention only and within the limits of Client's instructions, if any. The Company's sole responsibility is to its Client and this document does not exonerate parties to a transaction from exercising all their rights and obligations under the transaction documents. This document cannot be reproduced except in full, without prior written approval of the Company. Any unauthorized alteration, forgery or falsification of the content or appearance of this document is unlawful and offenders may be prosecuted to the fullest extent of the law.

Date: 2015/6/21

WLAN802.11 n(20M) 5.3G_Body_Top side_CH 60_Aux

Communication System: WLAN 5G; Frequency: 5300 MHz

Medium parameters used: $f = 5300$ MHz; $\sigma = 5.609$ S/m; $\epsilon_r = 47.56$; $\rho = 1000$ kg/m³

Phantom section: Flat Section

DASY5 Configuration:

- Probe: EX3DV4 - SN3770; ConvF(4.7, 4.7, 4.7); Calibrated: 2015/4/28;
- Sensor-Surface: 2mm (Mechanical Surface Detection)
- Electronics: DAE4 Sn856; Calibrated: 2014/8/27
- Phantom: Body;
- DASY52 52.8.8(1222); SEMCAD X 14.6.10(7331)

Configuration/Body/Area Scan (71x71x1): Interpolated grid: dx=10 mm, dy=10 mm

Maximum value of SAR (interpolated) = 1.40 W/kg

Configuration/Body/Zoom Scan (7x7x12)/Cube 0: Measurement grid:

dx=4mm, dy=4mm, dz=2mm

Reference Value = 6.878 V/m; Power Drift = 0.10 dB

Peak SAR (extrapolated) = 3.68 W/kg

SAR(1 g) = 0.690 W/kg; SAR(10 g) = 0.177 W/kg

Maximum value of SAR (measured) = 1.52 W/kg

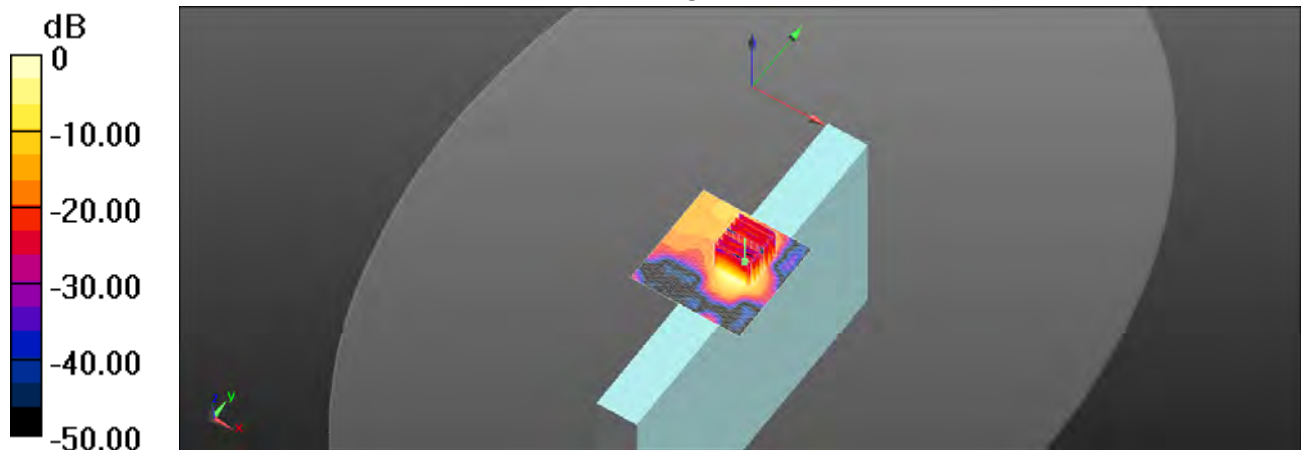

0 dB = 1.52 W/kg = 1.82 dBW/kg

Unless otherwise stated the results shown in this test report refer only to the sample(s) tested and such sample(s) are retained for 90 days only.

除非另有說明，此報告結果僅對測試之樣品負責，同時此樣品僅保留90天。本報告未經本公司書面許可，不可部份複製。

This document is issued by the Company subject to its General Conditions of Service printed overleaf, available on request or accessible at www.sgs.com/terms_and_conditions.htm and, for electronic format documents, subject to Terms and Conditions for Electronic Documents at www.sgs.com/terms_e-document.htm. Attention is drawn to the limitation of liability, indemnification and jurisdiction issues defined therein. Any holder of this document is advised that information contained hereon reflects the Company's findings at the time of its intervention only and within the limits of Client's instructions, if any. The Company's sole responsibility is to its Client and this document does not exonerate parties to a transaction from exercising all their rights and obligations under the transaction documents. This document cannot be reproduced except in full, without prior written approval of the Company. Any unauthorized alteration, forgery or falsification of the content or appearance of this document is unlawful and offenders may be prosecuted to the fullest extent of the law.

Date: 2015/6/21

WLAN802.11 n(40M) 5.3G_Body_Top side_CH 54_Aux

Communication System: WLAN 5G; Frequency: 5270 MHz

Medium parameters used: $f = 5270$ MHz; $\sigma = 5.567$ S/m; $\epsilon_r = 47.696$; $\rho = 1000$ kg/m³

Phantom section: Flat Section

DASY5 Configuration:

- Probe: EX3DV4 - SN3770; ConvF(4.7, 4.7, 4.7); Calibrated: 2015/4/28;
- Sensor-Surface: 2mm (Mechanical Surface Detection)
- Electronics: DAE4 Sn856; Calibrated: 2014/8/27
- Phantom: Body;
- DASY52 52.8.8(1222); SEMCAD X 14.6.10(7331)

Configuration/Body/Area Scan (71x71x1): Interpolated grid: dx=10 mm, dy=10 mm

Maximum value of SAR (interpolated) = 1.65 W/kg

Configuration/Body/Zoom Scan (7x7x12)/Cube 0: Measurement grid:

dx=4mm, dy=4mm, dz=2mm

Reference Value = 4.598 V/m; Power Drift = 0.17 dB

Peak SAR (extrapolated) = 4.27 W/kg

SAR(1 g) = 0.793 W/kg; SAR(10 g) = 0.199 W/kg

Maximum value of SAR (measured) = 1.68 W/kg

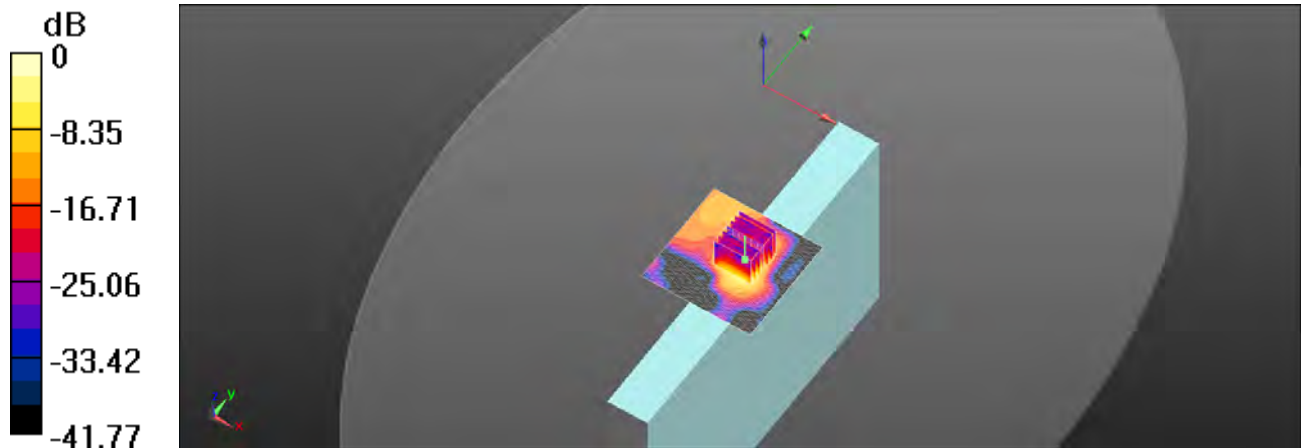

0 dB = 1.68 W/kg = 2.25 dBW/kg

Unless otherwise stated the results shown in this test report refer only to the sample(s) tested and such sample(s) are retained for 90 days only.

除非另有說明，此報告結果僅對測試之樣品負責，同時此樣品僅保留90天。本報告未經本公司書面許可，不可部份複製。

This document is issued by the Company subject to its General Conditions of Service printed overleaf, available on request or accessible at www.sgs.com/terms_and_conditions.htm and, for electronic format documents, subject to Terms and Conditions for Electronic Documents at www.sgs.com/terms_e-document.htm. Attention is drawn to the limitation of liability, indemnification and jurisdiction issues defined therein. Any holder of this document is advised that information contained hereon reflects the Company's findings at the time of its intervention only and within the limits of Client's instructions, if any. The Company's sole responsibility is to its Client and this document does not exonerate parties to a transaction from exercising all their rights and obligations under the transaction documents. This document cannot be reproduced except in full, without prior written approval of the Company. Any unauthorized alteration, forgery or falsification of the content or appearance of this document is unlawful and offenders may be prosecuted to the fullest extent of the law.

Date: 2015/6/22

WLAN802.11 n(20M) 5.6G_Body_Top side_CH 120_Aux

Communication System: WLAN 5G; Frequency: 5600 MHz

Medium parameters used: $f = 5600$ MHz; $\sigma = 6.004$ S/m; $\epsilon_r = 46.575$; $\rho = 1000$ kg/m³

Phantom section: Flat Section

DASY5 Configuration:

- Probe: EX3DV4 - SN3770; ConvF(4.03, 4.03, 4.03); Calibrated: 2015/4/28;
- Sensor-Surface: 2mm (Mechanical Surface Detection)
- Electronics: DAE4 Sn856; Calibrated: 2014/8/27
- Phantom: Body;
- DASY52 52.8.8(1222); SEMCAD X 14.6.10(7331)

Configuration/Body/Area Scan (71x71x1): Interpolated grid: dx=10 mm, dy=10 mm

Maximum value of SAR (interpolated) = 1.28 W/kg

Configuration/Body/Zoom Scan (7x7x12)/Cube 0: Measurement grid:

dx=4mm, dy=4mm, dz=2mm

Reference Value = 5.503 V/m; Power Drift = 0.10 dB

Peak SAR (extrapolated) = 4.00 W/kg

SAR(1 g) = 0.654 W/kg; SAR(10 g) = 0.149 W/kg

Maximum value of SAR (measured) = 1.51 W/kg

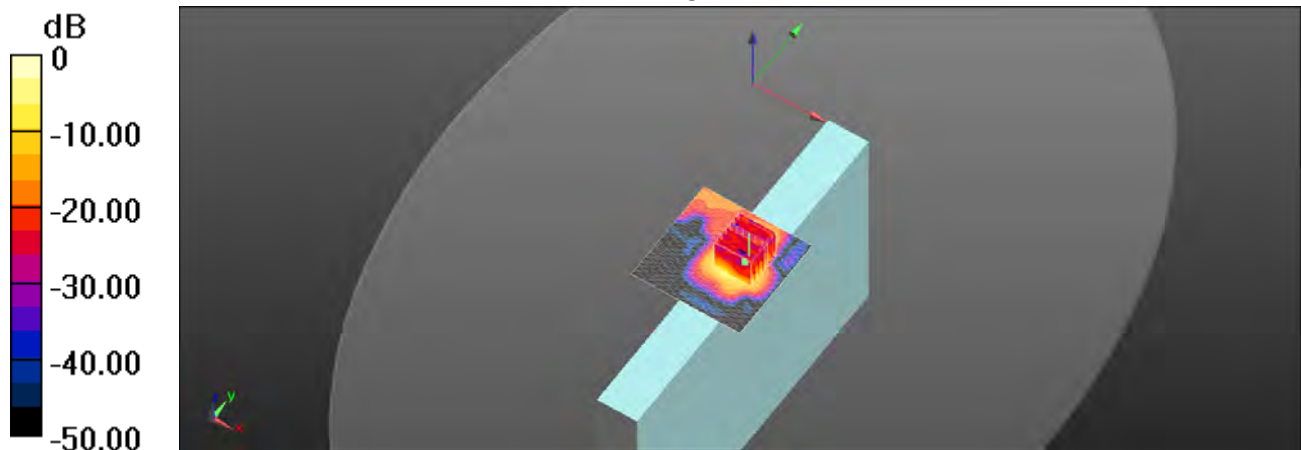

0 dB = 1.51 W/kg = 1.79 dBW/kg

Unless otherwise stated the results shown in this test report refer only to the sample(s) tested and such sample(s) are retained for 90 days only.

除非另有說明，此報告結果僅對測試之樣品負責，同時此樣品僅保留90天。本報告未經本公司書面許可，不可部份複製。

This document is issued by the Company subject to its General Conditions of Service printed overleaf, available on request or accessible at www.sgs.com/terms_and_conditions.htm and, for electronic format documents, subject to Terms and Conditions for Electronic Documents at www.sgs.com/terms_e-document.htm. Attention is drawn to the limitation of liability, indemnification and jurisdiction issues defined therein. Any holder of this document is advised that information contained hereon reflects the Company's findings at the time of its intervention only and within the limits of Client's instructions, if any. The Company's sole responsibility is to its Client and this document does not exonerate parties to a transaction from exercising all their rights and obligations under the transaction documents. This document cannot be reproduced except in full, without prior written approval of the Company. Any unauthorized alteration, forgery or falsification of the content or appearance of this document is unlawful and offenders may be prosecuted to the fullest extent of the law.

Date: 2015/6/22

WLAN802.11 n(40M) 5.8G_Body_Top side_CH 159_Aux

Communication System: WLAN 5G; Frequency: 5795 MHz

Medium parameters used: $f = 5795$ MHz; $\sigma = 6.208$ S/m; $\epsilon_r = 46.024$; $\rho = 1000$ kg/m³

Phantom section: Flat Section

DASY5 Configuration:

- Probe: EX3DV4 - SN3770; ConvF(4.33, 4.33, 4.33); Calibrated: 2015/4/28;
- Sensor-Surface: 2mm (Mechanical Surface Detection)
- Electronics: DAE4 Sn856; Calibrated: 2014/8/27
- Phantom: Body;
- DASY52 52.8.8(1222); SEMCAD X 14.6.10(7331)

Configuration/Body/Area Scan (71x71x1): Interpolated grid: dx=10 mm, dy=10 mm

Maximum value of SAR (interpolated) = 1.33 W/kg

Configuration/Body/Zoom Scan (7x7x12)/Cube 0: Measurement grid:

dx=4mm, dy=4mm, dz=2mm

Reference Value = 3.611 V/m; Power Drift = 0.12 dB

Peak SAR (extrapolated) = 3.61 W/kg

SAR(1 g) = 0.586 W/kg; SAR(10 g) = 0.126 W/kg

Maximum value of SAR (measured) = 1.38 W/kg

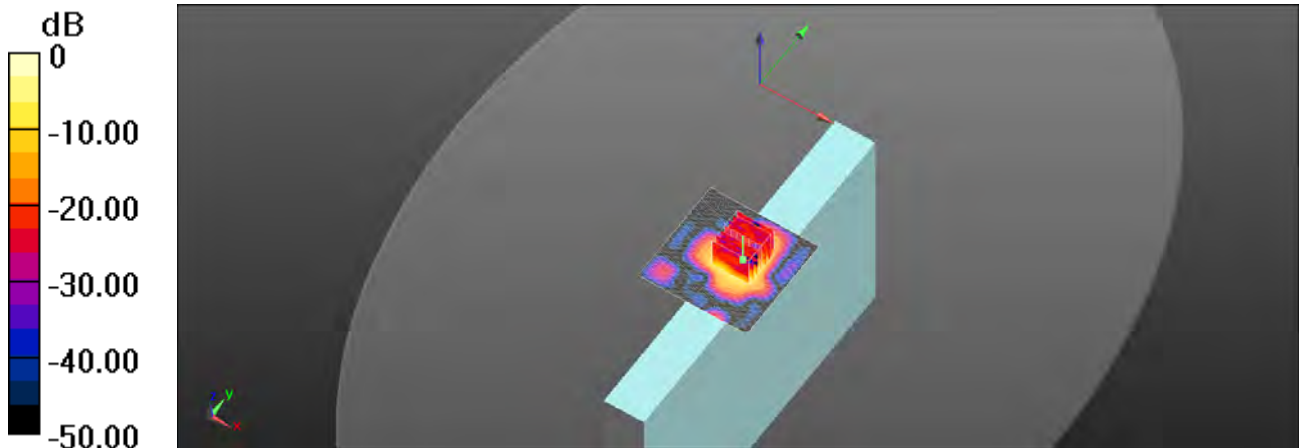

0 dB = 1.38 W/kg = 1.40 dBW/kg

Unless otherwise stated the results shown in this test report refer only to the sample(s) tested and such sample(s) are retained for 90 days only.

除非另有說明，此報告結果僅對測試之樣品負責，同時此樣品僅保留90天。本報告未經本公司書面許可，不可部份複製。

This document is issued by the Company subject to its General Conditions of Service printed overleaf, available on request or accessible at www.sgs.com/terms_and_conditions.htm and, for electronic format documents, subject to Terms and Conditions for Electronic Documents at www.sgs.com/terms_e-document.htm. Attention is drawn to the limitation of liability, indemnification and jurisdiction issues defined therein. Any holder of this document is advised that information contained hereon reflects the Company's findings at the time of its intervention only and within the limits of Client's instructions, if any. The Company's sole responsibility is to its Client and this document does not exonerate parties to a transaction from exercising all their rights and obligations under the transaction documents. This document cannot be reproduced except in full, without prior written approval of the Company. Any unauthorized alteration, forgery or falsification of the content or appearance of this document is unlawful and offenders may be prosecuted to the fullest extent of the law.

6. SAR System Performance Verification

Date: 2015/6/15

Dipole 750 MHz_SN:1015_Body

Communication System: CW; Frequency: 750 MHz

 Medium parameters used: $f = 750 \text{ MHz}$; $\sigma = 0.981 \text{ S/m}$; $\epsilon_r = 52.393$; $\rho = 1000 \text{ kg/m}^3$

Phantom section: Flat Section

DASY5 Configuration:

- Probe: EX3DV4 - SN3770; ConvF(9.3, 9.3, 9.3); Calibrated: 2015/4/28;
- Sensor-Surface: 2mm (Mechanical Surface Detection)
- Electronics: DAE4 Sn856; Calibrated: 2014/8/27
- Phantom: Body;
- DASY52 52.8.8(1222); SEMCAD X 14.6.10(7331)

Configuration/Pin=250mW/Area Scan (41x141x1): Interpolated grid:

 $dx=15 \text{ mm}$, $dy=15 \text{ mm}$

Maximum value of SAR (interpolated) = 2.69 W/kg

Configuration/Pin=250mW/Zoom Scan (7x7x7)/Cube 0: Measurement

 grid: $dx=5\text{mm}$, $dy=5\text{mm}$, $dz=5\text{mm}$

Reference Value = 52.19 V/m; Power Drift = 0.01 dB

Peak SAR (extrapolated) = 3.17 W/kg

SAR(1 g) = 2.18 W/kg; SAR(10 g) = 1.46 W/kg

Maximum value of SAR (measured) = 2.74 W/kg

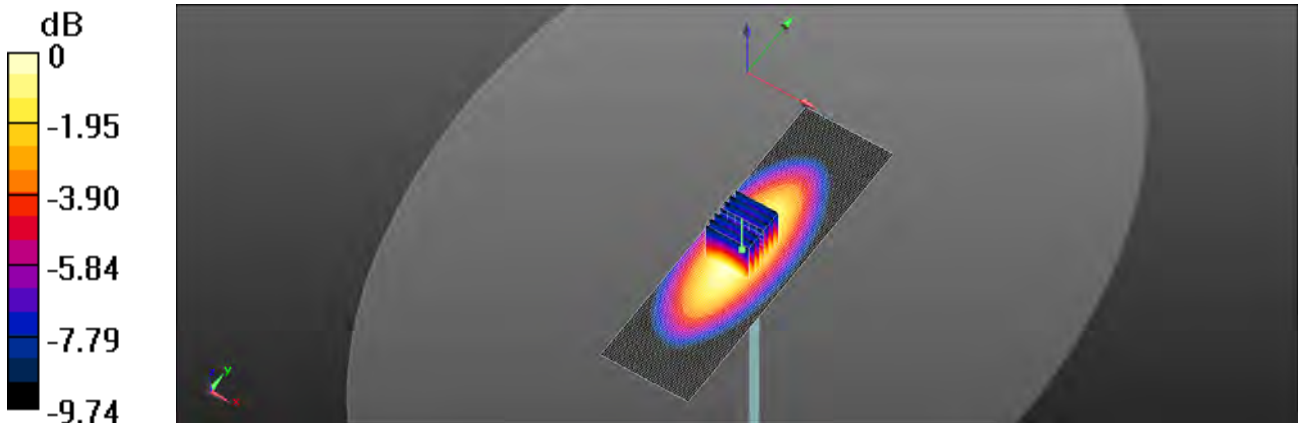
 $0 \text{ dB} = 2.74 \text{ W/kg} = 4.38 \text{ dBW/kg}$

Unless otherwise stated the results shown in this test report refer only to the sample(s) tested and such sample(s) are retained for 90 days only.

除非另有說明，此報告結果僅對測試之樣品負責，同時此樣品僅保留90天。本報告未經本公司書面許可，不可部份複製。

This document is issued by the Company subject to its General Conditions of Service printed overleaf, available on request or accessible at www.sgs.com/terms_and_conditions.htm and, for electronic format documents, subject to Terms and Conditions for Electronic Documents at www.sgs.com/terms_e-document.htm. Attention is drawn to the limitation of liability, indemnification and jurisdiction issues defined therein. Any holder of this document is advised that information contained hereon reflects the Company's findings at the time of its intervention only and within the limits of Client's instructions, if any. The Company's sole responsibility is to its Client and this document does not exonerate parties to a transaction from exercising all their rights and obligations under the transaction documents. This document cannot be reproduced except in full, without prior written approval of the Company. Any unauthorized alteration, forgery or falsification of the content or appearance of this document is unlawful and offenders may be prosecuted to the fullest extent of the law.

Date: 2015/6/16

Dipole 835 MHz_SN:4d063_Body

Communication System: CW; Frequency: 835 MHz

Medium parameters used: $f = 835 \text{ MHz}$; $\sigma = 1.01 \text{ S/m}$; $\epsilon_r = 56.648$; $\rho = 1000 \text{ kg/m}^3$

Phantom section: Flat Section

DASY5 Configuration:

- Probe: EX3DV4 - SN3770; ConvF(9.17, 9.17, 9.17); Calibrated: 2015/4/28;
- Sensor-Surface: 2mm (Mechanical Surface Detection)
- Electronics: DAE4 Sn856; Calibrated: 2014/8/27
- Phantom: Body;
- DASY52 52.8.8(1222); SEMCAD X 14.6.10(7331)

Configuration/Pin=250mW/Area Scan (41x121x1): Interpolated grid:

$dx=15 \text{ mm}$, $dy=15 \text{ mm}$

Maximum value of SAR (interpolated) = 3.10 W/kg

Configuration/Pin=250mW/Zoom Scan (7x7x7)/Cube 0: Measurement

grid: $dx=5\text{mm}$, $dy=5\text{mm}$, $dz=5\text{mm}$

Reference Value = 56.93 V/m; Power Drift = -0.11 dB

Peak SAR (extrapolated) = 3.58 W/kg

SAR(1 g) = 2.42 W/kg; SAR(10 g) = 1.59 W/kg

Maximum value of SAR (measured) = 3.06 W/kg

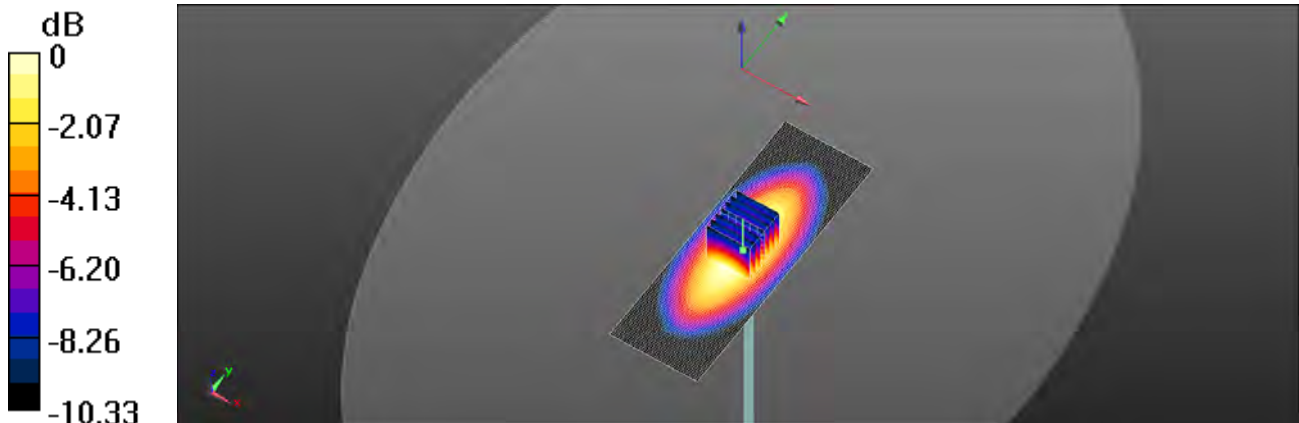

0 dB = 3.06 W/kg = 4.86 dBW/kg

Unless otherwise stated the results shown in this test report refer only to the sample(s) tested and such sample(s) are retained for 90 days only.

除非另有說明，此報告結果僅對測試之樣品負責，同時此樣品僅保留90天。本報告未經本公司書面許可，不可部份複製。

This document is issued by the Company subject to its General Conditions of Service printed overleaf, available on request or accessible at www.sgs.com/terms_and_conditions.htm and, for electronic format documents, subject to Terms and Conditions for Electronic Documents at www.sgs.com/terms_e-document.htm. Attention is drawn to the limitation of liability, indemnification and jurisdiction issues defined therein. Any holder of this document is advised that information contained hereon reflects the Company's findings at the time of its intervention only and within the limits of Client's instructions, if any. The Company's sole responsibility is to its Client and this document does not exonerate parties to a transaction from exercising all their rights and obligations under the transaction documents. This document cannot be reproduced except in full, without prior written approval of the Company. Any unauthorized alteration, forgery or falsification of the content or appearance of this document is unlawful and offenders may be prosecuted to the fullest extent of the law.

Date: 2015/6/17

Dipole 1750 MHz_SN:1008_Body

Communication System: CW; Frequency: 1750 MHz

Medium parameters used: $f = 1750$ MHz; $\sigma = 1.442$ S/m; $\epsilon_r = 52.821$; $\rho = 1000$ kg/m³

Phantom section: Flat Section

DASY5 Configuration:

- Probe: EX3DV4 - SN3770; ConvF(7.79, 7.79, 7.79); Calibrated: 2015/4/28;
- Sensor-Surface: 2mm (Mechanical Surface Detection)
- Electronics: DAE4 Sn856; Calibrated: 2014/8/27
- Phantom: Body;
- DASY52 52.8.8(1222); SEMCAD X 14.6.10(7331)

Configuration/Pin=250mW/Area Scan (41x71x1): Interpolated grid: dx=15 mm, dy=15 mm

Maximum value of SAR (interpolated) = 14.0 W/kg

Configuration/Pin=250mW/Zoom Scan (7x7x7)/Cube 0: Measurement grid: dx=5mm, dy=5mm, dz=5mm

Reference Value = 97.78 V/m; Power Drift = -0.00 dB

Peak SAR (extrapolated) = 16.7 W/kg

SAR(1 g) = 9.43 W/kg; SAR(10 g) = 5.02 W/kg

Maximum value of SAR (measured) = 13.4 W/kg

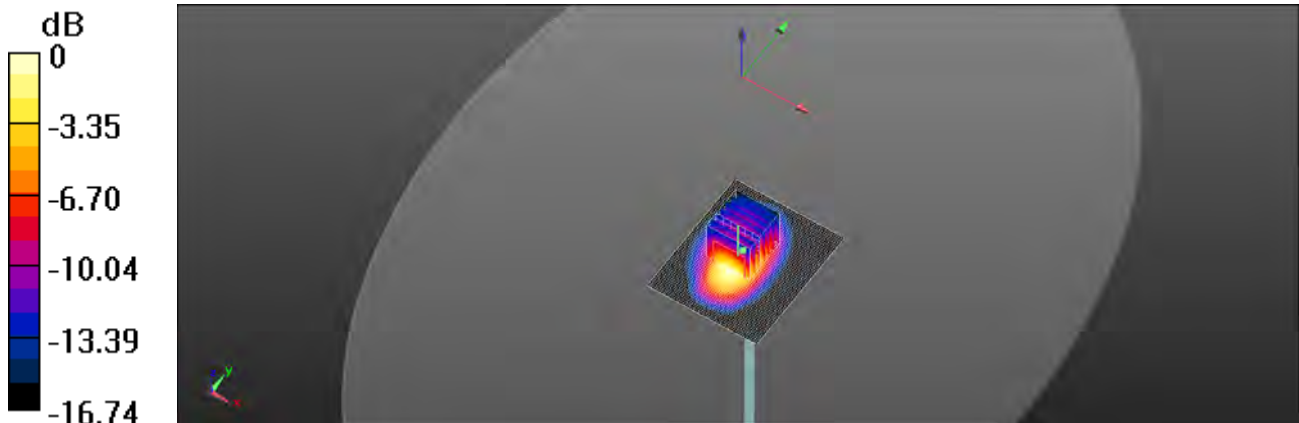

0 dB = 13.4 W/kg = 11.27 dBW/kg

Unless otherwise stated the results shown in this test report refer only to the sample(s) tested and such sample(s) are retained for 90 days only.

除非另有說明，此報告結果僅對測試之樣品負責，同時此樣品僅保留90天。本報告未經本公司書面許可，不可部份複製。

This document is issued by the Company subject to its General Conditions of Service printed overleaf, available on request or accessible at www.sgs.com/terms_and_conditions.htm and, for electronic format documents, subject to Terms and Conditions for Electronic Documents at www.sgs.com/terms_e-document.htm. Attention is drawn to the limitation of liability, indemnification and jurisdiction issues defined therein. Any holder of this document is advised that information contained hereon reflects the Company's findings at the time of its intervention only and within the limits of Client's instructions, if any. The Company's sole responsibility is to its Client and this document does not exonerate parties to a transaction from exercising all their rights and obligations under the transaction documents. This document cannot be reproduced except in full, without prior written approval of the Company. Any unauthorized alteration, forgery or falsification of the content or appearance of this document is unlawful and offenders may be prosecuted to the fullest extent of the law.

Dipole 1900 MHz_SN:5d027_Body

Communication System: CW; Frequency: 1900 MHz

Medium parameters used: $f = 1900$ MHz; $\sigma = 1.501$ S/m; $\epsilon_r = 53.595$; $\rho = 1000$ kg/m³

Phantom section: Flat Section

DASY5 Configuration:

- Probe: EX3DV4 - SN3770; ConvF(7.59, 7.59, 7.59); Calibrated: 2015/4/28;
- Sensor-Surface: 2mm (Mechanical Surface Detection)
- Electronics: DAE4 Sn856; Calibrated: 2014/8/27
- Phantom: Body;
- DASY52 52.8.8(1222); SEMCAD X 14.6.10(7331)

Configuration/Pin=250mW/Area Scan (31x71x1): Interpolated grid: dx=15 mm, dy=15 mm

Maximum value of SAR (interpolated) = 15.0 W/kg

Configuration/Pin=250mW/Zoom Scan (7x7x7)/Cube 0: Measurement grid: dx=5mm, dy=5mm, dz=5mm

Reference Value = 96.67 V/m; Power Drift = -0.03 dB

Peak SAR (extrapolated) = 17.7 W/kg

SAR(1 g) = 9.87 W/kg; SAR(10 g) = 5.19 W/kg

Maximum value of SAR (measured) = 13.9 W/kg

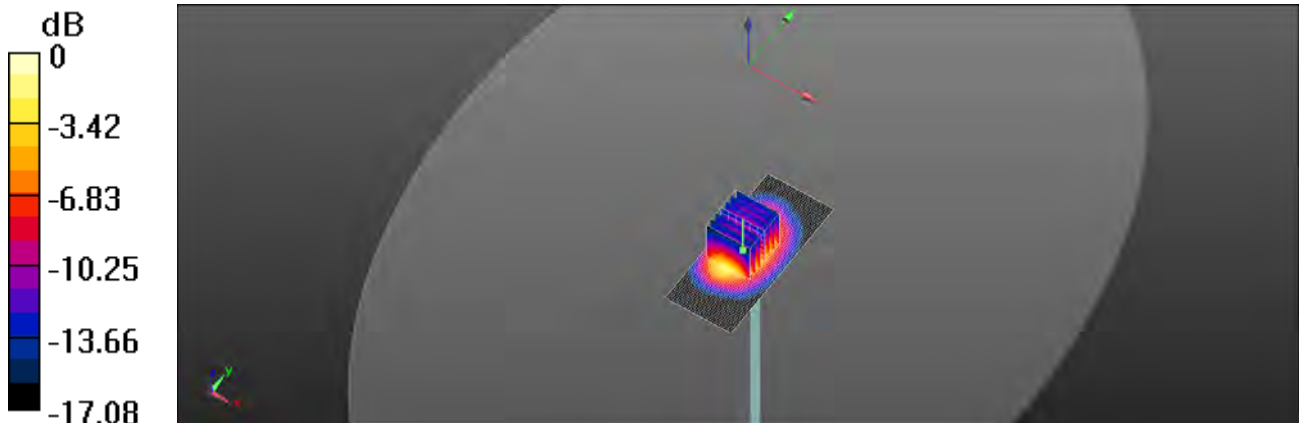

0 dB = 13.9 W/kg = 11.43 dBW/kg

Unless otherwise stated the results shown in this test report refer only to the sample(s) tested and such sample(s) are retained for 90 days only.

除非另有說明，此報告結果僅對測試之樣品負責，同時此樣品僅保留90天。本報告未經本公司書面許可，不可部份複製。

This document is issued by the Company subject to its General Conditions of Service printed overleaf, available on request or accessible at www.sgs.com/terms_and_conditions.htm and, for electronic format documents, subject to Terms and Conditions for Electronic Documents at www.sgs.com/terms_e-document.htm. Attention is drawn to the limitation of liability, indemnification and jurisdiction issues defined therein. Any holder of this document is advised that information contained hereon reflects the Company's findings at the time of its intervention only and within the limits of Client's instructions, if any. The Company's sole responsibility is to its Client and this document does not exonerate parties to a transaction from exercising all their rights and obligations under the transaction documents. This document cannot be reproduced except in full, without prior written approval of the Company. Any unauthorized alteration, forgery or falsification of the content or appearance of this document is unlawful and offenders may be prosecuted to the fullest extent of the law.

Date: 2015/6/19

Dipole 2450 MHz_SN:727_Body

Communication System: CW; Frequency: 2450 MHz

Medium parameters used: $f = 2450$ MHz; $\sigma = 2.037$ S/m; $\epsilon_r = 51.276$; $\rho = 1000$ kg/m³

Phantom section: Flat Section

DASY5 Configuration:

- Probe: EX3DV4 - SN3770; ConvF(7.21, 7.21, 7.21); Calibrated: 2015/4/28;
- Sensor-Surface: 2mm (Mechanical Surface Detection)
- Electronics: DAE4 Sn856; Calibrated: 2014/8/27
- Phantom: Body;
- DASY52 52.8.8(1222); SEMCAD X 14.6.10(7331)

Configuration/Pin=250mW/Area Scan (31x61x1): Interpolated grid: dx=12 mm, dy=12 mm

Maximum value of SAR (interpolated) = 22.5 W/kg

Configuration/Pin=250mW/Zoom Scan (7x7x7)/Cube 0: Measurement grid: dx=5mm, dy=5mm, dz=5mm

Reference Value = 103.9 V/m; Power Drift = -0.02 dB

Peak SAR (extrapolated) = 30.8 W/kg

SAR(1 g) = 13.8 W/kg; SAR(10 g) = 6.21 W/kg

Maximum value of SAR (measured) = 22.1 W/kg

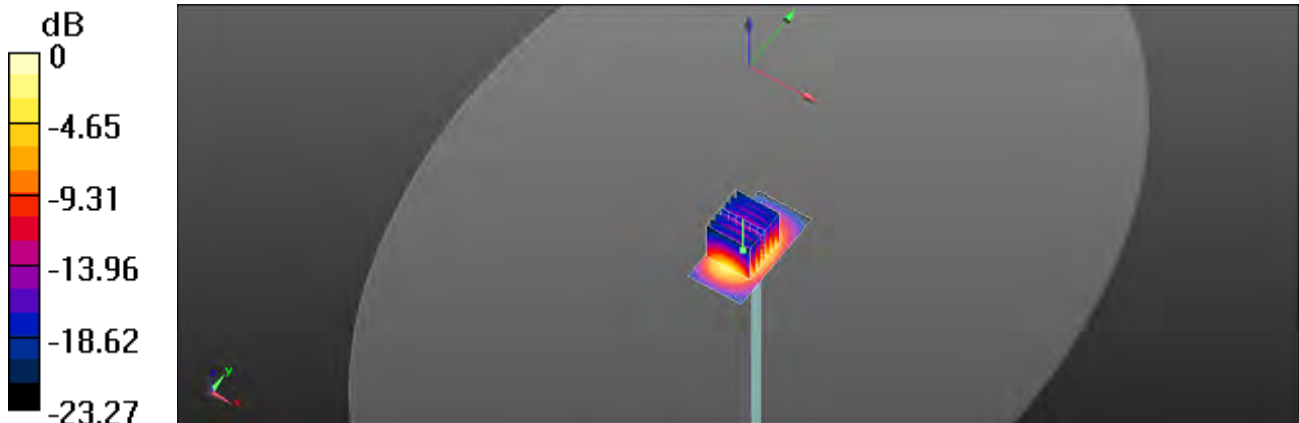

0 dB = 22.1 W/kg = 13.44 dBW/kg

Unless otherwise stated the results shown in this test report refer only to the sample(s) tested and such sample(s) are retained for 90 days only.

除非另有說明，此報告結果僅對測試之樣品負責，同時此樣品僅保留90天。本報告未經本公司書面許可，不可部份複製。

This document is issued by the Company subject to its General Conditions of Service printed overleaf, available on request or accessible at www.sgs.com/terms_and_conditions.htm and, for electronic format documents, subject to Terms and Conditions for Electronic Documents at www.sgs.com/terms_e-document.htm. Attention is drawn to the limitation of liability, indemnification and jurisdiction issues defined therein. Any holder of this document is advised that information contained hereon reflects the Company's findings at the time of its intervention only and within the limits of Client's instructions, if any. The Company's sole responsibility is to its Client and this document does not exonerate parties to a transaction from exercising all their rights and obligations under the transaction documents. This document cannot be reproduced except in full, without prior written approval of the Company. Any unauthorized alteration, forgery or falsification of the content or appearance of this document is unlawful and offenders may be prosecuted to the fullest extent of the law.

Dipole 5200 MHz_SN:1023_Body

Communication System: CW; Frequency: 5200 MHz

Medium parameters used: $f = 5200$ MHz; $\sigma = 5.462$ S/m; $\epsilon_r = 47.93$; $\rho = 1000$ kg/m³

Phantom section: Flat Section

DASY5 Configuration:

- Probe: EX3DV4 - SN3770; ConvF(4.7, 4.7, 4.7); Calibrated: 2015/4/28;
- Sensor-Surface: 2mm (Mechanical Surface Detection)
- Electronics: DAE4 Sn856; Calibrated: 2014/8/27
- Phantom: Body;
- DASY52 52.8.8(1222); SEMCAD X 14.6.10(7331)

Configuration/Pin=100mW/Area Scan (41x81x1): Interpolated grid: dx=10 mm, dy=10 mm

Maximum value of SAR (interpolated) = 15.2 W/kg

Configuration/Pin=100mW/Zoom Scan (7x7x12)/Cube 0: Measurement grid: dx=4mm, dy=4mm, dz=2mm

Reference Value = 53.89 V/m; Power Drift = 0.03 dB

Peak SAR (extrapolated) = 31.7 W/kg

SAR(1 g) = 7.08 W/kg; SAR(10 g) = 1.99 W/kg

Maximum value of SAR (measured) = 14.8 W/kg

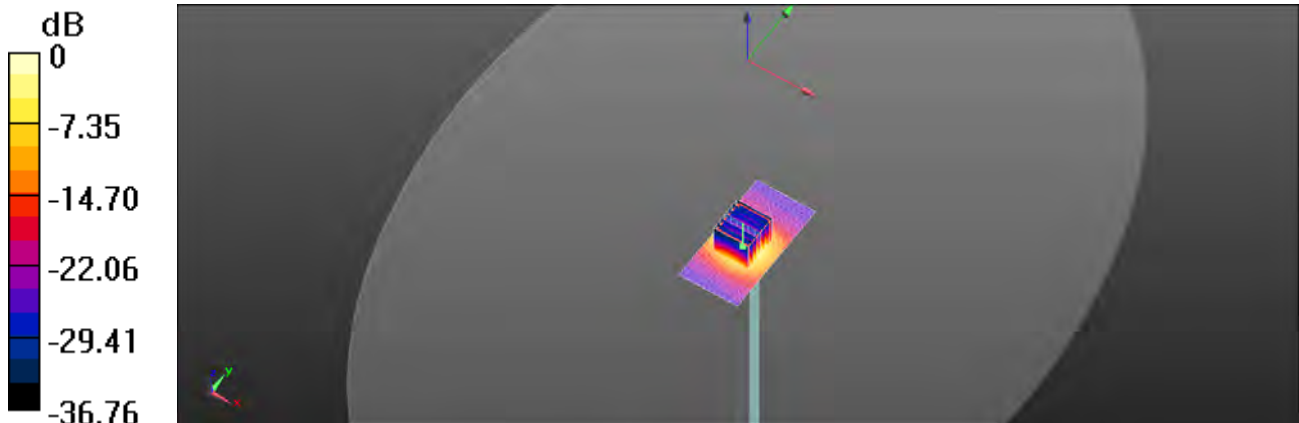

0 dB = 14.8 W/kg = 11.70 dBW/kg

Unless otherwise stated the results shown in this test report refer only to the sample(s) tested and such sample(s) are retained for 90 days only.

除非另有說明，此報告結果僅對測試之樣品負責，同時此樣品僅保留90天。本報告未經本公司書面許可，不可部份複製。

This document is issued by the Company subject to its General Conditions of Service printed overleaf, available on request or accessible at www.sgs.com/terms_and_conditions.htm and, for electronic format documents, subject to Terms and Conditions for Electronic Documents at www.sgs.com/terms_e-document.htm. Attention is drawn to the limitation of liability, indemnification and jurisdiction issues defined therein. Any holder of this document is advised that information contained hereon reflects the Company's findings at the time of its intervention only and within the limits of Client's instructions, if any. The Company's sole responsibility is to its Client and this document does not exonerate parties to a transaction from exercising all their rights and obligations under the transaction documents. This document cannot be reproduced except in full, without prior written approval of the Company. Any unauthorized alteration, forgery or falsification of the content or appearance of this document is unlawful and offenders may be prosecuted to the fullest extent of the law.

Date: 2015/6/21

Dipole 5300 MHz_SN:1023_Body

Communication System: CW; Frequency: 5300 MHz

Medium parameters used: $f = 5300$ MHz; $\sigma = 5.609$ S/m; $\epsilon_r = 47.56$; $\rho = 1000$ kg/m³

Phantom section: Flat Section

DASY5 Configuration:

- Probe: EX3DV4 - SN3770; ConvF(4.7, 4.7, 4.7); Calibrated: 2015/4/28;
- Sensor-Surface: 2mm (Mechanical Surface Detection)
- Electronics: DAE4 Sn856; Calibrated: 2014/8/27
- Phantom: Body;
- DASY52 52.8.8(1222); SEMCAD X 14.6.10(7331)

Configuration/Pin=100mW/Area Scan (41x81x1): Interpolated grid: dx=10 mm, dy=10 mm

Maximum value of SAR (interpolated) = 16.1 W/kg

Configuration/Pin=100mW/Zoom Scan (7x7x12)/Cube 0: Measurement grid: dx=4mm, dy=4mm, dz=2mm

Reference Value = 54.74 V/m; Power Drift = -0.02 dB

Peak SAR (extrapolated) = 33.5 W/kg

SAR(1 g) = 7.49 W/kg; SAR(10 g) = 2.11 W/kg

Maximum value of SAR (measured) = 15.6 W/kg

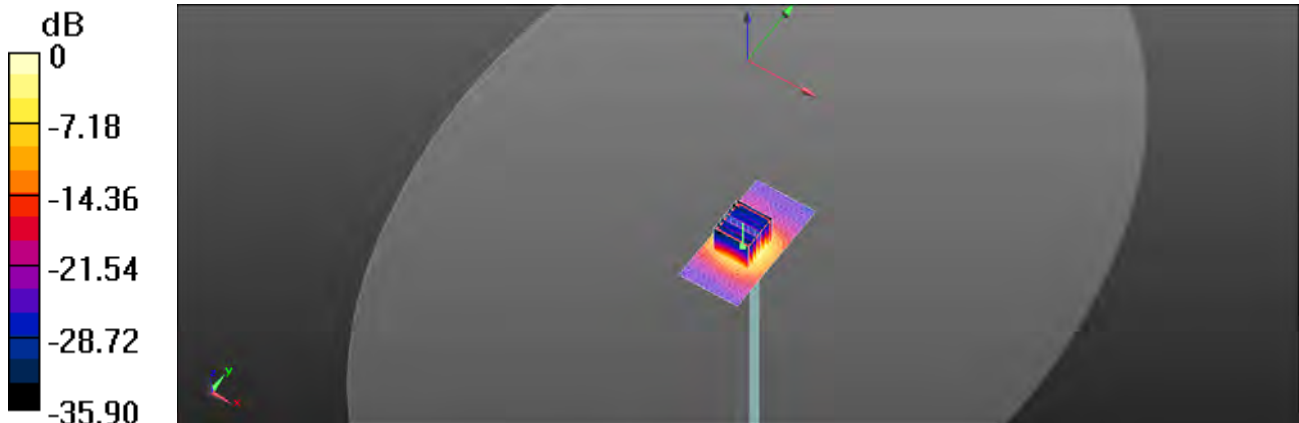

0 dB = 15.6 W/kg = 11.93 dBW/kg

Unless otherwise stated the results shown in this test report refer only to the sample(s) tested and such sample(s) are retained for 90 days only.

除非另有說明，此報告結果僅對測試之樣品負責，同時此樣品僅保留90天。本報告未經本公司書面許可，不可部份複製。

This document is issued by the Company subject to its General Conditions of Service printed overleaf, available on request or accessible at www.sgs.com/terms_and_conditions.htm and, for electronic format documents, subject to Terms and Conditions for Electronic Documents at www.sgs.com/terms_e-document.htm. Attention is drawn to the limitation of liability, indemnification and jurisdiction issues defined therein. Any holder of this document is advised that information contained hereon reflects the Company's findings at the time of its intervention only and within the limits of Client's instructions, if any. The Company's sole responsibility is to its Client and this document does not exonerate parties to a transaction from exercising all their rights and obligations under the transaction documents. This document cannot be reproduced except in full, without prior written approval of the Company. Any unauthorized alteration, forgery or falsification of the content or appearance of this document is unlawful and offenders may be prosecuted to the fullest extent of the law.

Dipole 5600 MHz_SN:1023_Body

Communication System: CW; Frequency: 5600 MHz

Medium parameters used: $f = 5600$ MHz; $\sigma = 6.004$ S/m; $\epsilon_r = 46.575$; $\rho = 1000$ kg/m³

Phantom section: Flat Section

DASY5 Configuration:

- Probe: EX3DV4 - SN3770; ConvF(4.03, 4.03, 4.03); Calibrated: 2015/4/28;
- Sensor-Surface: 2mm (Mechanical Surface Detection)
- Electronics: DAE4 Sn856; Calibrated: 2014/8/27
- Phantom: Body;
- DASY52 52.8.8(1222); SEMCAD X 14.6.10(7331)

Configuration/Pin=100mW/Area Scan (41x81x1): Interpolated grid: dx=10 mm, dy=10 mm

Maximum value of SAR (interpolated) = 17.4 W/kg

Configuration/Pin=100mW/Zoom Scan (7x7x12)/Cube 0: Measurement grid: dx=4mm, dy=4mm, dz=2mm

Reference Value = 55.83 V/m; Power Drift = -0.04 dB

Peak SAR (extrapolated) = 37.4 W/kg

SAR(1 g) = 7.81 W/kg; SAR(10 g) = 2.16 W/kg

Maximum value of SAR (measured) = 16.6 W/kg

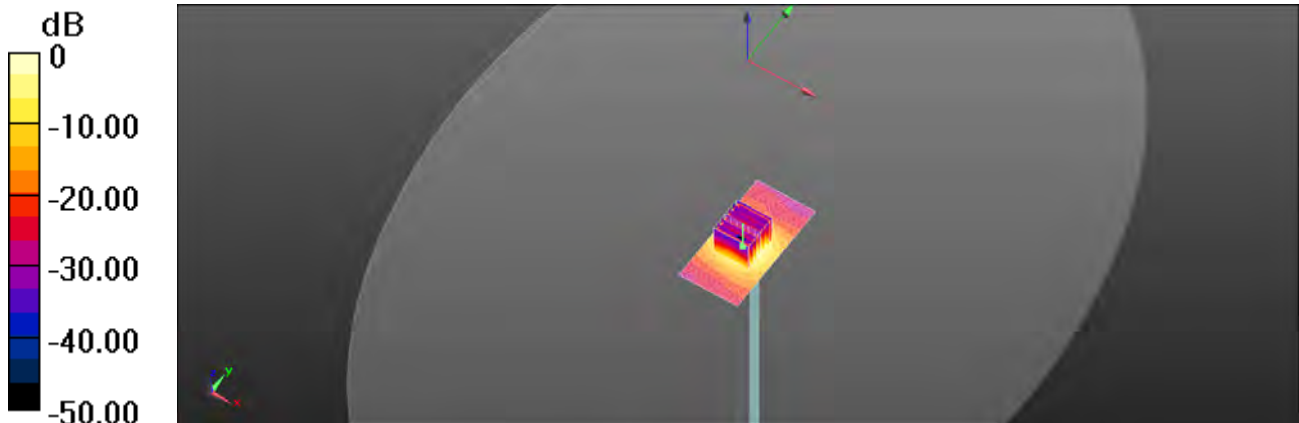

0 dB = 16.6 W/kg = 12.20 dBW/kg

Unless otherwise stated the results shown in this test report refer only to the sample(s) tested and such sample(s) are retained for 90 days only.

除非另有說明，此報告結果僅對測試之樣品負責，同時此樣品僅保留90天。本報告未經本公司書面許可，不可部份複製。

This document is issued by the Company subject to its General Conditions of Service printed overleaf, available on request or accessible at www.sgs.com/terms_and_conditions.htm and, for electronic format documents, subject to Terms and Conditions for Electronic Documents at www.sgs.com/terms_e-document.htm. Attention is drawn to the limitation of liability, indemnification and jurisdiction issues defined therein. Any holder of this document is advised that information contained hereon reflects the Company's findings at the time of its intervention only and within the limits of Client's instructions, if any. The Company's sole responsibility is to its Client and this document does not exonerate parties to a transaction from exercising all their rights and obligations under the transaction documents. This document cannot be reproduced except in full, without prior written approval of the Company. Any unauthorized alteration, forgery or falsification of the content or appearance of this document is unlawful and offenders may be prosecuted to the fullest extent of the law.

Dipole 5800 MHz_SN:1023_Body

Communication System: CW; Frequency: 5800 MHz

Medium parameters used: $f = 5800 \text{ MHz}$; $\sigma = 6.21 \text{ S/m}$; $\epsilon_r = 46.008$; $\rho = 1000 \text{ kg/m}^3$

Phantom section: Flat Section

DASY5 Configuration:

- Probe: EX3DV4 - SN3770; ConvF(4.33, 4.33, 4.33); Calibrated: 2015/4/28;
- Sensor-Surface: 2mm (Mechanical Surface Detection)
- Electronics: DAE4 Sn856; Calibrated: 2014/8/27
- Phantom: Body;
- DASY52 52.8.8(1222); SEMCAD X 14.6.10(7331)

Configuration/Pin=100mW/Area Scan (41x81x1): Interpolated grid: $dx=10 \text{ mm}$, $dy=10 \text{ mm}$

Maximum value of SAR (interpolated) = 16.5 W/kg

Configuration/Pin=100mW/Zoom Scan (7x7x12)/Cube 0: Measurement grid: $dx=4 \text{ mm}$, $dy=4 \text{ mm}$, $dz=2 \text{ mm}$

Reference Value = 54.44 V/m; Power Drift = 0.03 dB

Peak SAR (extrapolated) = 34.8 W/kg

SAR(1 g) = 7.51 W/kg; SAR(10 g) = 2.08 W/kg

Maximum value of SAR (measured) = 15.9 W/kg

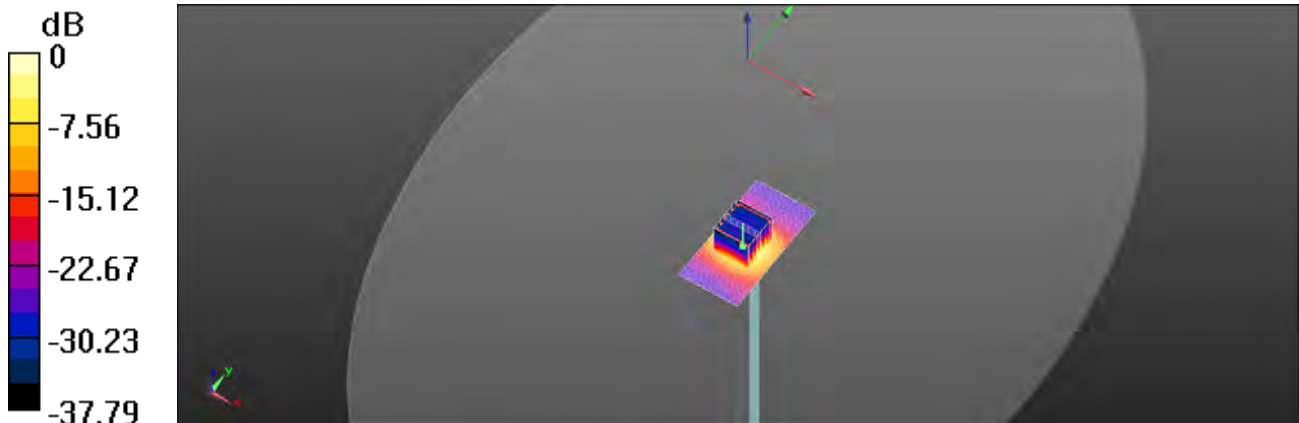

0 dB = 15.9 W/kg = 12.01 dBW/kg

Unless otherwise stated the results shown in this test report refer only to the sample(s) tested and such sample(s) are retained for 90 days only.

除非另有說明，此報告結果僅對測試之樣品負責，同時此樣品僅保留90天。本報告未經本公司書面許可，不可部份複製。

This document is issued by the Company subject to its General Conditions of Service printed overleaf, available on request or accessible at www.sgs.com/terms_and_conditions.htm and, for electronic format documents, subject to Terms and Conditions for Electronic Documents at www.sgs.com/terms_e-document.htm. Attention is drawn to the limitation of liability, indemnification and jurisdiction issues defined therein. Any holder of this document is advised that information contained hereon reflects the Company's findings at the time of its intervention only and within the limits of Client's instructions, if any. The Company's sole responsibility is to its Client and this document does not exonerate parties to a transaction from exercising all their rights and obligations under the transaction documents. This document cannot be reproduced except in full, without prior written approval of the Company. Any unauthorized alteration, forgery or falsification of the content or appearance of this document is unlawful and offenders may be prosecuted to the fullest extent of the law.

7. DAE & Probe Calibration Certificate

Calibration Laboratory of
Schmid & Partner
Engineering AG
Zeughausstrasse 43, 8004 Zurich, Switzerland



S Schweizerischer Kalibrierdienst
C Service suisse d'étalonnage
S Servizio svizzero di taratura
S Swiss Calibration Service

Accredited by the Swiss Accreditation Service (SAS)
The Swiss Accreditation Service is one of the signatories to the EA
Multilateral Agreement for the recognition of calibration certificates

Accreditation No. : SCS 108

Client SGS - TW (Auden)

Certificate No. DAE4-856_Aug14

CALIBRATION CERTIFICATE

Object: DAE4 - SD 000 D04 BM - SN: 856

Calibration procedure(s): QA CAL-06.v28
Calibration procedure for the data acquisition electronics (DAE)

Calibration date: August 27, 2014

This calibration certificate documents the traceability to national standards, which realize the physical units of measurements (SI).
The measurements and the uncertainties with confidence probability are given on the following pages and are part of the certificate.

All calibrations have been conducted in the closed laboratory facility: environment temperature (22 ± 3)°C and humidity < 70%.

Calibration Equipment used (MSTE critical for calibration)

| Primary Standards | ID # | Cal. Date / Certificate No. | Scheduled Calibration |
|-------------------------------|--------------------|-----------------------------|------------------------|
| Keithley Multimeter Type 2007 | SN: 0810278 | 01-Oct-13 (No. 13978) | Oct-14 |
| Secondary Standards | ID # | Check Date (in house) | Scheduled Check |
| Auto DAE Calibrator Unit | SE LMS 053 AA 1001 | 07-Jan-14 (in house check) | In house check, Jan-15 |
| Calibrator Box V2.1 | SE LMS 005 AA 1002 | 07-Jan-14 (in house check) | In house check, Jan-15 |

Calibrated by: Name: Dominique Sieder, Function: Technician, Signature: 

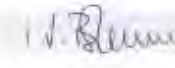
Approved by: Fin Baumgartner, Deputy Technical Manager, Signature: 

Issued: August 27, 2014

This calibration certificate shall not be reproduced except in full without written approval of the laboratory.

Certificate No: DAE4-856_Aug14

Page 1 of 5

Unless otherwise stated the results shown in this test report refer only to the sample(s) tested and such sample(s) are retained for 90 days only.

除非另有說明，此報告結果僅對測試之樣品負責，同時此樣品僅保留90天。本報告未經本公司書面許可，不可部份複製。

This document is issued by the Company subject to its General Conditions of Service printed overleaf, available on request or accessible at www.sgs.com/terms_and_conditions.htm and, for electronic format documents, subject to Terms and Conditions for Electronic Documents at www.sgs.com/terms_e-document.htm. Attention is drawn to the limitation of liability, indemnification and jurisdiction issues defined therein. Any holder of this document is advised that information contained hereon reflects the Company's findings at the time of its intervention only and within the limits of Client's instructions, if any. The Company's sole responsibility is to its Client and this document does not exonerate parties to a transaction from exercising all their rights and obligations under the transaction documents. This document cannot be reproduced except in full, without prior written approval of the Company. Any unauthorized alteration, forgery or falsification of the content or appearance of this document is unlawful and offenders may be prosecuted to the fullest extent of the law.

**Calibration Laboratory of
Schmid & Partner
Engineering AG**
Zaughausstrasse 43, 8004 Zurich, Switzerland



S Schweizerischer Kalibrierdienst
C Service suisse d'étalonnage
S Servizio svizzero di taratura
S Swiss Calibration Service

Accredited by the Swiss Accreditation Service (SAS)
The Swiss Accreditation Service is one of the signatories to the EA
Multilateral Agreement for the recognition of calibration certificates

Accreditation No.: **SCS 108**

Glossary

DAE data acquisition electronics
Connector angle information used in DASY system to align probe sensor X to the robot coordinate system.

Methods Applied and Interpretation of Parameters

- **DC Voltage Measurement:** Calibration Factor assessed for use in DASY system by comparison with a calibrated instrument traceable to national standards. The figure given corresponds to the full scale range of the voltmeter in the respective range.
- **Connector angle:** The angle of the connector is assessed measuring the angle mechanically by a tool inserted. Uncertainty is not required.
- The following parameters as documented in the Appendix contain technical information as a result from the performance test and require no uncertainty.
 - **DC Voltage Measurement Linearity:** Verification of the Linearity at +10% and -10% of the nominal calibration voltage. Influence of offset voltage is included in this measurement.
 - **Common mode sensitivity:** Influence of a positive or negative common mode voltage on the differential measurement.
 - **Channel separation:** Influence of a voltage on the neighbor channels not subject to an input voltage.
 - **AD Converter Values with inputs shorted:** Values on the internal AD converter corresponding to zero input voltage
 - **Input Offset Measurement:** Output voltage and statistical results over a large number of zero voltage measurements.
 - **Input Offset Current:** Typical value for information; Maximum channel input offset current, not considering the input resistance.
 - **Input resistance:** Typical value for information; DAE input resistance at the connector, during internal auto-zeroing and during measurement.
 - **Low Battery Alarm Voltage:** Typical value for information. Below this voltage, a battery alarm signal is generated.
 - **Power consumption:** Typical value for information. Supply currents in various operating modes.

Unless otherwise stated the results shown in this test report refer only to the sample(s) tested and such sample(s) are retained for 90 days only.

除非另有說明，此報告結果僅對測試之樣品負責，同時此樣品僅保留90天。本報告未經本公司書面許可，不可部份複製。

This document is issued by the Company subject to its General Conditions of Service printed overleaf, available on request or accessible at www.sgs.com/terms_and_conditions.htm and, for electronic format documents, subject to Terms and Conditions for Electronic Documents at www.sgs.com/terms_e-document.htm. Attention is drawn to the limitation of liability, indemnification and jurisdiction issues defined therein. Any holder of this document is advised that information contained hereon reflects the Company's findings at the time of its intervention only and within the limits of Client's instructions, if any. The Company's sole responsibility is to its Client and this document does not exonerate parties to a transaction from exercising all their rights and obligations under the transaction documents. This document cannot be reproduced except in full, without prior written approval of the Company. Any unauthorized alteration, forgery or falsification of the content or appearance of this document is unlawful and offenders may be prosecuted to the fullest extent of the law.

DC Voltage Measurement

A/D - Converter Resolution nominal

High Range: 1LSB = 6.1 μ V, full range = -100...+500 mV

Low Range: 1LSB = 61nV, full range = -1...+3mV

DASY measurement parameters: Auto Zero Time: 3 sec; Measuring time: 3 sec

| Calibration Factors | X | Y | Z |
|---------------------|-----------------------|-----------------------|-----------------------|
| High Range | 403.468 ± 0.02% (k=2) | 404.581 ± 0.02% (k=2) | 403.903 ± 0.02% (k=2) |
| Low Range | 3.97681 ± 1.50% (k=2) | 3.97783 ± 1.50% (k=2) | 3.97815 ± 1.50% (k=2) |

Connector Angle

| | |
|---|--------------|
| Connector Angle to be used in DASY system | 52.5 ° ± 1 ° |
|---|--------------|

Unless otherwise stated the results shown in this test report refer only to the sample(s) tested and such sample(s) are retained for 90 days only.

除非另有說明，此報告結果僅對測試之樣品負責，同時此樣品僅保留90天。本報告未經本公司書面許可，不可部份複製。

This document is issued by the Company subject to its General Conditions of Service printed overleaf, available on request or accessible at www.sgs.com/terms_and_conditions.htm and, for electronic format documents, subject to Terms and Conditions for Electronic Documents at www.sgs.com/terms_e-document.htm. Attention is drawn to the limitation of liability, indemnification and jurisdiction issues defined therein. Any holder of this document is advised that information contained hereon reflects the Company's findings at the time of its intervention only and within the limits of Client's instructions, if any. The Company's sole responsibility is to its Client and this document does not exonerate parties to a transaction from exercising all their rights and obligations under the transaction documents. This document cannot be reproduced except in full, without prior written approval of the Company. Any unauthorized alteration, forgery or falsification of the content or appearance of this document is unlawful and offenders may be prosecuted to the fullest extent of the law.

Appendix (Additional assessments outside the scope of SCS108)

1. DC Voltage Linearity

| High Range | Reading (μV) | Difference (μV) | Error (%) |
|-------------------|---------------------------|------------------------------|-----------|
| Channel X + Input | 19999.33 | 0.84 | 0.00 |
| Channel X + Input | 19998.90 | -2.25 | -0.01 |
| Channel X - Input | -20000.45 | 0.34 | -0.00 |
| Channel Y + Input | 19999.95 | 0.95 | 0.00 |
| Channel Y + Input | 19997.51 | -3.82 | -0.02 |
| Channel Y - Input | -20000.77 | 0.07 | -0.00 |
| Channel Z + Input | 19997.26 | -0.19 | -0.00 |
| Channel Z + Input | 19997.65 | -3.57 | -0.02 |
| Channel Z - Input | -20002.47 | -1.55 | 0.01 |

| Low Range | Reading (μV) | Difference (μV) | Error (%) |
|-------------------|---------------------------|------------------------------|-----------|
| Channel X + Input | 2001.05 | -0.05 | -0.00 |
| Channel X + Input | 200.34 | 0.80 | 0.40 |
| Channel X - Input | -198.31 | 0.26 | -0.13 |
| Channel Y + Input | 2001.39 | 0.26 | 0.01 |
| Channel Y + Input | 201.08 | -0.36 | -0.18 |
| Channel Y - Input | -199.24 | -0.78 | 0.39 |
| Channel Z + Input | 2000.92 | -0.18 | -0.01 |
| Channel Z + Input | 200.26 | -1.22 | -0.60 |
| Channel Z - Input | -199.91 | -1.47 | 0.74 |

2. Common mode sensitivity

DASY measurement parameters: Auto Zero Time: 3 sec; Measuring time: 3 sec

| | Common mode Input Voltage (mV) | High Range Average Reading (μV) | Low Range Average Reading (μV) |
|-----------|--------------------------------|--|---|
| Channel X | 200 | -14.75 | -16.42 |
| | -200 | 17.19 | 15.88 |
| Channel Y | 200 | -2.17 | -2.25 |
| | -200 | 0.90 | 0.51 |
| Channel Z | 200 | 10.27 | 10.05 |
| | -200 | -13.06 | -13.03 |

3. Channel separation

DASY measurement parameters: Auto Zero Time: 3 sec; Measuring time: 3 sec

| | Input Voltage (mV) | Channel X (μV) | Channel Y (μV) | Channel Z (μV) |
|-----------|--------------------|-----------------------------|-----------------------------|-----------------------------|
| Channel X | 200 | - | 3.81 | -1.15 |
| Channel Y | 200 | 7.99 | - | 3.07 |
| Channel Z | 200 | 8.55 | 5.24 | - |

Unless otherwise stated the results shown in this test report refer only to the sample(s) tested and such sample(s) are retained for 90 days only.

除非另有說明，此報告結果僅對測試之樣品負責，同時此樣品僅保留90天。本報告未經本公司書面許可，不可部份複製。

This document is issued by the Company subject to its General Conditions of Service printed overleaf, available on request or accessible at www.sgs.com/terms_and_conditions.htm and, for electronic format documents, subject to Terms and Conditions for Electronic Documents at www.sgs.com/terms_e-document.htm. Attention is drawn to the limitation of liability, indemnification and jurisdiction issues defined therein. Any holder of this document is advised that information contained hereon reflects the Company's findings at the time of its intervention only and within the limits of Client's instructions, if any. The Company's sole responsibility is to its Client and this document does not exonerate parties to a transaction from exercising all their rights and obligations under the transaction documents. This document cannot be reproduced except in full, without prior written approval of the Company. Any unauthorized alteration, forgery or falsification of the content or appearance of this document is unlawful and offenders may be prosecuted to the fullest extent of the law.

4. AD-Converter Values with Inputs shorted

DASY measurement parameters: Auto Zero Time: 3 sec; Measuring time: 3 sec;

| | High Range (LSB) | Low Range (LSB) |
|-----------|------------------|-----------------|
| Channel X | 16226 | 16620 |
| Channel Y | 15842 | 16809 |
| Channel Z | 15875 | 16811 |

5. Input Offset Measurement

DASY measurement parameters: Auto Zero Time: 3 sec; Measuring time: 3 sec;
Input 10MΩ

| | Average (μV) | min. Offset (μV) | max. Offset (μV) | Std. Deviation (μV) |
|-----------|--------------|------------------|------------------|---------------------|
| Channel X | 0.72 | -0.77 | 1.88 | 0.38 |
| Channel Y | -0.24 | -1.07 | 1.48 | 0.42 |
| Channel Z | -0.98 | -2.01 | 0.07 | 0.40 |

6. Input Offset Current

Nominal input circuitry offset current on all channels: $\leq 25\text{nA}$

7. Input Resistance (Typical values for information)

| | Zeroing (kΩ) | Measuring (MΩ) |
|-----------|--------------|----------------|
| Channel X | 200 | 200 |
| Channel Y | 200 | 200 |
| Channel Z | 200 | 200 |

8. Low Battery Alarm Voltage (Typical values for information)

| Typical values | Alarm Level (VDC) |
|----------------|-------------------|
| Supply (+ Vcc) | +7.8 |
| Supply (- Vcc) | -7.8 |

9. Power Consumption (Typical values for information)

| Typical values | Switched off (mA) | Stand by (mA) | Transmitting (mA) |
|----------------|-------------------|---------------|-------------------|
| Supply (+ Vcc) | +0.01 | +8 | +14 |
| Supply (- Vcc) | -0.01 | -8 | -9 |

Unless otherwise stated the results shown in this test report refer only to the sample(s) tested and such sample(s) are retained for 90 days only.

除非另有說明，此報告結果僅對測試之樣品負責，同時此樣品僅保留90天。本報告未經本公司書面許可，不可部份複製。

This document is issued by the Company subject to its General Conditions of Service printed overleaf, available on request or accessible at www.sgs.com/terms_and_conditions.htm and, for electronic format documents, subject to Terms and Conditions for Electronic Documents at www.sgs.com/terms_e-document.htm. Attention is drawn to the limitation of liability, indemnification and jurisdiction issues defined therein. Any holder of this document is advised that information contained hereon reflects the Company's findings at the time of its intervention only and within the limits of Client's instructions, if any. The Company's sole responsibility is to its Client and this document does not exonerate parties to a transaction from exercising all their rights and obligations under the transaction documents. This document cannot be reproduced except in full, without prior written approval of the Company. Any unauthorized alteration, forgery or falsification of the content or appearance of this document is unlawful and offenders may be prosecuted to the fullest extent of the law.

**Calibration Laboratory of
Schmid & Partner
Engineering AG**
Zeughausstrasse 43, 8004 Zurich, Switzerland



S Schweizerischer Kalibrierdienst
C Service suisse d'étalonnage
S Servizio svizzero di taratura
S Swiss Calibration Service

Accredited by the Swiss Accreditation Service (SAS)
The Swiss Accreditation Service is one of the signatories to the EA
Multilateral Agreement for the recognition of calibration certificates

Accreditation No.: **SCS 0108**

Client **SGS-TW (Auden)**

Certificate No: **EX3-3770_Apr15**

CALIBRATION CERTIFICATE

Object: **EX3DV4 - SN:3770**

Calibration procedure(s): **QA CAL-01.v9, QA CAL-14.v4, QA CAL-23.v5, QA CAL-25.v6
Calibration procedure for dosimetric E-field probes**

Calibration date: **April 28, 2015**

This calibration certificate documents the traceability to national standards, which realize the physical units of measurements (SI).
The measurements and the uncertainties with confidence probability are given on the following pages and are part of the certificate.

All calibrations have been conducted in the closed laboratory facility: environment temperature (22 ± 3)°C and humidity < 70%.

Calibration Equipment used (M&TE critical for calibration)

| Primary Standards | ID | Cal Date (Certificate No.) | Scheduled Calibration |
|----------------------------|-----------------|-----------------------------------|------------------------|
| Power meter E4419B | GB41293874 | 01-Apr-15 (No. 217-02128) | Mar-16 |
| Power sensor E4412A | MY41498087 | 01-Apr-15 (No. 217-02128) | Mar-16 |
| Reference 3 dB Attenuator | SN: S5054 (3c) | 01-Apr-15 (No. 217-02129) | Mar-16 |
| Reference 20 dB Attenuator | SN: S5277 (20x) | 01-Apr-15 (No. 217-02132) | Mar-16 |
| Reference 30 dB Attenuator | SN: S5129 (30b) | 01-Apr-15 (No. 217-02133) | Mar-16 |
| Reference Probe ES3DV2 | SN: 3013 | 30-Dec-14 (No. ES3-3013_Dec14) | Dec-15 |
| DAE4 | SN: 660 | 14-Jan-15 (No. DAE4-660_Jan15) | Jan-16 |
| Secondary Standards | ID | Check Date (in house) | Scheduled Check |
| RF generator HP 8648C | US3642U01700 | 4-Aug-99 (in house check Apr-13) | In house check: Apr-16 |
| Network Analyzer HP 8753E | US37390585 | 18-Oct-01 (in house check Oct-14) | In house check: Oct-15 |

| | Name | Function | Signature |
|----------------|----------------|-----------------------|-----------|
| Calibrated by: | Jeton Kastrati | Laboratory Technician | |
| Approved by: | Katja Pokovic | Technical Manager | |

Issued: April 30, 2015

This calibration certificate shall not be reproduced except in full without written approval of the laboratory.

Unless otherwise stated the results shown in this test report refer only to the sample(s) tested and such sample(s) are retained for 90 days only.

除非另有說明，此報告結果僅對測試之樣品負責，同時此樣品僅保留90天。本報告未經本公司書面許可，不可部份複製。

This document is issued by the Company subject to its General Conditions of Service printed overleaf, available on request or accessible at www.sgs.com/terms_and_conditions.htm and, for electronic format documents, subject to Terms and Conditions for Electronic Documents at www.sgs.com/terms_e-document.htm. Attention is drawn to the limitation of liability, indemnification and jurisdiction issues defined therein. Any holder of this document is advised that information contained hereon reflects the Company's findings at the time of its intervention only and within the limits of Client's instructions, if any. The Company's sole responsibility is to its Client and this document does not exonerate parties to a transaction from exercising all their rights and obligations under the transaction documents. This document cannot be reproduced except in full, without prior written approval of the Company. Any unauthorized alteration, forgery or falsification of the content or appearance of this document is unlawful and offenders may be prosecuted to the fullest extent of the law.

**Calibration Laboratory of
Schmid & Partner
Engineering AG**
Zeughausstrasse 43, 8004 Zurich, Switzerland



S Schweizerischer Kalibrierdienst
C Service suisse d'étalonnage
S Servizio svizzero di taratura
Swiss Calibration Service

Accredited by the Swiss Accreditation Service (SAS)
The Swiss Accreditation Service is one of the signatories to the EA
Multilateral Agreement for the recognition of calibration certificates

Accreditation No.: **SCS 0108**

Glossary:

| | |
|--------------------------|---|
| TSL | issue simulating liquid |
| NORM _{x,y,z} | sensitivity in free space |
| ConvF | sensitivity in TSL / NORM _{x,y,z} |
| DCP | diode compression point |
| CF | crest factor (1/duty_cycle) of the RF signal |
| A, B, C, D | modulation dependent linearization parameters |
| Polarization φ | φ rotation around probe axis |
| Polarization ϑ | ϑ rotation around an axis that is in the plane normal to probe axis (at measurement center), i.e., $\vartheta = 0$ is normal to probe axis |
| Connector Angle | information used in DASY system to align probe sensor X to the robot coordinate system |

Calibration is Performed According to the Following Standards:

- a) IEEE Std 1528-2013, "IEEE Recommended Practice for Determining the Peak Spatial-Averaged Specific Absorption Rate (SAR) in the Human Head from Wireless Communications Devices: Measurement Techniques", June 2013
- b) IEC 62209-1, "Procedure to measure the Specific Absorption Rate (SAR) for hand-held devices used in close proximity to the ear (frequency range of 300 MHz to 3 GHz)", February 2005

Methods Applied and Interpretation of Parameters:

- **NORM_{x,y,z}**: Assessed for E-field polarization $\vartheta = 0$ ($f \leq 900$ MHz in TEM-cell; $f > 1800$ MHz: R22 waveguide). NORM_{x,y,z} are only intermediate values, i.e., the uncertainties of NORM_{x,y,z} does not affect the E²-field uncertainty inside TSL (see below ConvF).
- **NORM(f)_{x,y,z} = NORM_{x,y,z} * frequency_response** (see Frequency Response Chart). This linearization is implemented in DASY4 software versions later than 4.2. The uncertainty of the frequency response is included in the stated uncertainty of ConvF.
- **DCP_{x,y,z}**: DCP are numerical linearization parameters assessed based on the data of power sweep with CW signal (no uncertainty required). DCP does not depend on frequency nor media.
- **PAR**: PAR is the Peak to Average Ratio that is not calibrated but determined based on the signal characteristics
- **A_{x,y,z}; B_{x,y,z}; C_{x,y,z}; D_{x,y,z}; VR_{x,y,z}; A, B, C, D** are numerical linearization parameters assessed based on the data of power sweep for specific modulation signal. The parameters do not depend on frequency nor media. VR is the maximum calibration range expressed in RMS voltage across the diode.
- **ConvF and Boundary Effect Parameters**: Assessed in flat phantom using E-field (or Temperature Transfer Standard for $f \leq 800$ MHz) and inside waveguide using analytical field distributions based on power measurements for $f > 800$ MHz. The same setups are used for assessment of the parameters applied for boundary compensation (alpha, depth) of which typical uncertainty values are given. These parameters are used in DASY4 software to improve probe accuracy close to the boundary. The sensitivity in TSL corresponds to NORM_{x,y,z} * ConvF whereby the uncertainty corresponds to that given for ConvF. A frequency dependent ConvF is used in DASY version 4.4 and higher which allows extending the validity from ± 50 MHz to ± 100 MHz.
- **Spherical isotropy (3D deviation from isotropy)**: in a field of low gradients realized using a flat phantom exposed by a patch antenna.
- **Sensor Offset**: The sensor offset corresponds to the offset of virtual measurement center from the probe tip (on probe axis). No tolerance required.
- **Connector Angle**: The angle is assessed using the information gained by determining the NORM_x (no uncertainty required).

Unless otherwise stated the results shown in this test report refer only to the sample(s) tested and such sample(s) are retained for 90 days only.

除非另有說明，此報告結果僅對測試之樣品負責，同時此樣品僅保留90天。本報告未經本公司書面許可，不可部份複製。

This document is issued by the Company subject to its General Conditions of Service printed overleaf, available on request or accessible at www.sgs.com/terms_and_conditions.htm and, for electronic format documents, subject to Terms and Conditions for Electronic Documents at www.sgs.com/terms_e-document.htm. Attention is drawn to the limitation of liability, indemnification and jurisdiction issues defined therein. Any holder of this document is advised that information contained hereon reflects the Company's findings at the time of its intervention only and within the limits of Client's instructions, if any. The Company's sole responsibility is to its Client and this document does not exonerate parties to a transaction from exercising all their rights and obligations under the transaction documents. This document cannot be reproduced except in full, without prior written approval of the Company. Any unauthorized alteration, forgery or falsification of the content or appearance of this document is unlawful and offenders may be prosecuted to the fullest extent of the law.

Probe EX3DV4

SN:3770

Manufactured: July 6, 2010
Calibrated: April 28, 2015

Calibrated for DASY/EASY Systems
(Note: non-compatible with DASY2 system!)

Unless otherwise stated the results shown in this test report refer only to the sample(s) tested and such sample(s) are retained for 90 days only.

除非另有說明，此報告結果僅對測試之樣品負責，同時此樣品僅保留90天。本報告未經本公司書面許可，不可部份複製。

This document is issued by the Company subject to its General Conditions of Service printed overleaf, available on request or accessible at www.sgs.com/terms_and_conditions.htm and, for electronic format documents, subject to Terms and Conditions for Electronic Documents at www.sgs.com/terms_e-document.htm. Attention is drawn to the limitation of liability, indemnification and jurisdiction issues defined therein. Any holder of this document is advised that information contained hereon reflects the Company's findings at the time of its intervention only and within the limits of Client's instructions, if any. The Company's sole responsibility is to its Client and this document does not exonerate parties to a transaction from exercising all their rights and obligations under the transaction documents. This document cannot be reproduced except in full, without prior written approval of the Company. Any unauthorized alteration, forgery or falsification of the content or appearance of this document is unlawful and offenders may be prosecuted to the fullest extent of the law.

EX3DV4- SN:3770

April 28, 2015

DASY/EASY - Parameters of Probe: EX3DV4 - SN:3770

Basic Calibration Parameters

| | Sensor X | Sensor Y | Sensor Z | Unc (k=2) |
|---|----------|----------|----------|---------------|
| Norm ($\mu\text{V}/(\text{V}/\text{m})^2$) ^A | 0.31 | 0.62 | 0.40 | $\pm 10.1 \%$ |
| DCP (mV) ^B | 105.3 | 100.7 | 101.6 | |

Modulation Calibration Parameters

| UID | Communication System Name | | A dB | B dB $\sqrt{\mu\text{V}}$ | C | D dB | VR mV | Unc ^E (k=2) |
|-----|---------------------------|---|---------|------------------------------|-----|---------|----------|---------------------------|
| 0 | CW | X | 0.0 | 0.0 | 1.0 | 0.00 | 145.1 | $\pm 3.8 \%$ |
| | | Y | 0.0 | 0.0 | 1.0 | | 129.4 | |
| | | Z | 0.0 | 0.0 | 1.0 | | 138.4 | |

The reported uncertainty of measurement is stated as the standard uncertainty of measurement multiplied by the coverage factor k=2, which for a normal distribution corresponds to a coverage probability of approximately 95%.

^A The uncertainties of NormX,Y,Z do not affect the E²-field uncertainty inside TSL (see Pages 5 and 6).

^B Numerical linearization parameter: uncertainty not required.

^E Uncertainty is determined using the max. deviation from linear response applying rectangular distribution and is expressed for the square of the field value.

Unless otherwise stated the results shown in this test report refer only to the sample(s) tested and such sample(s) are retained for 90 days only.

除非另有說明，此報告結果僅對測試之樣品負責，同時此樣品僅保留90天。本報告未經本公司書面許可，不可部份複製。

This document is issued by the Company subject to its General Conditions of Service printed overleaf, available on request or accessible at www.sgs.com/terms_and_conditions.htm and, for electronic format documents, subject to Terms and Conditions for Electronic Documents at www.sgs.com/terms_e-document.htm. Attention is drawn to the limitation of liability, indemnification and jurisdiction issues defined therein. Any holder of this document is advised that information contained hereon reflects the Company's findings at the time of its intervention only and within the limits of Client's instructions, if any. The Company's sole responsibility is to its Client and this document does not exonerate parties to a transaction from exercising all their rights and obligations under the transaction documents. This document cannot be reproduced except in full, without prior written approval of the Company. Any unauthorized alteration, forgery or falsification of the content or appearance of this document is unlawful and offenders may be prosecuted to the fullest extent of the law.

DASY/EASY - Parameters of Probe: EX3DV4 - SN:3770

Calibration Parameter Determined in Head Tissue Simulating Media

| f (MHz) ^C | Relative Permittivity ^F | Conductivity (S/m) ^F | ConvF X | ConvF Y | ConvF Z | Alpha ^G | Depth ^G (mm) | Unct. (k=2) |
|----------------------|------------------------------------|---------------------------------|---------|---------|---------|--------------------|-------------------------|-------------|
| 750 | 41.9 | 0.89 | 9.53 | 9.53 | 9.53 | 0.26 | 1.28 | ± 12.0 % |
| 835 | 41.5 | 0.90 | 9.13 | 9.13 | 9.13 | 0.21 | 1.53 | ± 12.0 % |
| 900 | 41.5 | 0.97 | 8.89 | 8.89 | 8.89 | 0.23 | 1.38 | ± 12.0 % |
| 1450 | 40.5 | 1.20 | 8.19 | 8.19 | 8.19 | 0.18 | 1.59 | ± 12.0 % |
| 1750 | 40.1 | 1.37 | 8.04 | 8.04 | 8.04 | 0.38 | 0.80 | ± 12.0 % |
| 1900 | 40.0 | 1.40 | 7.82 | 7.82 | 7.82 | 0.36 | 0.80 | ± 12.0 % |
| 2000 | 40.0 | 1.40 | 7.81 | 7.81 | 7.81 | 0.36 | 0.80 | ± 12.0 % |
| 2300 | 39.5 | 1.67 | 7.47 | 7.47 | 7.47 | 0.27 | 0.96 | ± 12.0 % |
| 2450 | 39.2 | 1.80 | 7.16 | 7.16 | 7.16 | 0.34 | 0.80 | ± 12.0 % |
| 2600 | 39.0 | 1.96 | 6.85 | 6.85 | 6.85 | 0.34 | 0.92 | ± 12.0 % |
| 5250 | 35.9 | 4.71 | 5.27 | 5.27 | 5.27 | 0.30 | 1.80 | ± 13.1 % |
| 5600 | 35.5 | 5.07 | 4.65 | 4.65 | 4.65 | 0.35 | 1.80 | ± 13.1 % |
| 5750 | 35.4 | 5.22 | 4.92 | 4.92 | 4.92 | 0.40 | 1.80 | ± 13.1 % |

^C Frequency validity above 300 MHz of ± 100 MHz only applies for DASY v4.4 and higher (see Page 2), else it is restricted to ± 50 MHz. The uncertainty is the RSS of the ConvF uncertainty at calibration frequency and the uncertainty for the indicated frequency band. Frequency validity below 300 MHz is ± 10, 25, 40, 50 and 70 MHz for ConvF assessments at 30, 64, 128, 150 and 220 MHz respectively. Above 5 GHz frequency validity can be extended to ± 110 MHz.

^F At frequencies below 3 GHz, the validity of tissue parameters (ϵ and σ) can be relaxed to ± 10% if liquid compensation formula is applied to measured SAR values. At frequencies above 3 GHz, the validity of tissue parameters (ϵ and σ) is restricted to ± 5%. The uncertainty is the RSS of the ConvF uncertainty for indicated target tissue parameters.

^G Alpha/Depth are determined during calibration. SPEAG warrants that the remaining deviation due to the boundary effect after compensation is always less than ± 1% for frequencies below 3 GHz and below ± 2% for frequencies between 3-6 GHz at any distance larger than half the probe tip diameter from the boundary.

Unless otherwise stated the results shown in this test report refer only to the sample(s) tested and such sample(s) are retained for 90 days only.

除非另有說明，此報告結果僅對測試之樣品負責，同時此樣品僅保留90天。本報告未經本公司書面許可，不可部份複製。

This document is issued by the Company subject to its General Conditions of Service printed overleaf, available on request or accessible at www.sgs.com/terms_and_conditions.htm and, for electronic format documents, subject to Terms and Conditions for Electronic Documents at www.sgs.com/terms_e-document.htm. Attention is drawn to the limitation of liability, indemnification and jurisdiction issues defined therein. Any holder of this document is advised that information contained hereon reflects the Company's findings at the time of its intervention only and within the limits of Client's instructions, if any. The Company's sole responsibility is to its Client and this document does not exonerate parties to a transaction from exercising all their rights and obligations under the transaction documents. This document cannot be reproduced except in full, without prior written approval of the Company. Any unauthorized alteration, forgery or falsification of the content or appearance of this document is unlawful and offenders may be prosecuted to the fullest extent of the law.

DASY/EASY - Parameters of Probe: EX3DV4 - SN:3770

Calibration Parameter Determined in Body Tissue Simulating Media

| f (MHz) ^C | Relative Permittivity ^F | Conductivity (S/m) ^F | ConvF X | ConvF Y | ConvF Z | Alpha ^G | Depth (mm) ^G | Unct. (k=2) |
|----------------------|------------------------------------|---------------------------------|---------|---------|---------|--------------------|-------------------------|-------------|
| 750 | 55.5 | 0.96 | 9.30 | 9.30 | 9.30 | 0.25 | 1.38 | ± 12.0 % |
| 835 | 55.2 | 0.97 | 9.17 | 9.17 | 9.17 | 0.34 | 1.05 | ± 12.0 % |
| 900 | 55.0 | 1.05 | 8.91 | 8.91 | 8.91 | 0.30 | 1.20 | ± 12.0 % |
| 1450 | 54.0 | 1.30 | 8.12 | 8.12 | 8.12 | 0.18 | 1.62 | ± 12.0 % |
| 1750 | 53.4 | 1.49 | 7.79 | 7.79 | 7.79 | 0.44 | 0.80 | ± 12.0 % |
| 1900 | 53.3 | 1.52 | 7.59 | 7.59 | 7.59 | 0.44 | 0.80 | ± 12.0 % |
| 2000 | 53.3 | 1.52 | 7.73 | 7.73 | 7.73 | 0.42 | 0.80 | ± 12.0 % |
| 2300 | 52.9 | 1.81 | 7.32 | 7.32 | 7.32 | 0.41 | 0.80 | ± 12.0 % |
| 2450 | 52.7 | 1.95 | 7.21 | 7.21 | 7.21 | 0.31 | 0.80 | ± 12.0 % |
| 2600 | 52.5 | 2.16 | 6.96 | 6.96 | 6.96 | 0.27 | 0.80 | ± 12.0 % |
| 5250 | 48.9 | 5.36 | 4.70 | 4.70 | 4.70 | 0.35 | 1.90 | ± 13.1 % |
| 5600 | 48.5 | 5.77 | 4.03 | 4.03 | 4.03 | 0.45 | 1.90 | ± 13.1 % |
| 5750 | 48.3 | 5.94 | 4.33 | 4.33 | 4.33 | 0.50 | 1.90 | ± 13.1 % |

^C Frequency validity above 300 MHz of ± 100 MHz only applies for DASY v4.4 and higher (see Page 2), else it is restricted to ± 50 MHz. The uncertainty is the RSS of the ConvF uncertainty at calibration frequency and the uncertainty for the indicated frequency band. Frequency validity below 300 MHz is ± 10, 25, 40, 50 and 70 MHz for ConvF assessments at 30, 64, 128, 150 and 220 MHz respectively. Above 5 GHz frequency validity can be extended to ± 110 MHz.

^F At frequencies below 3 GHz, the validity of tissue parameters (ϵ and σ) can be relaxed to ± 10% if liquid compensation formula is applied to measured SAR values. At frequencies above 3 GHz, the validity of tissue parameters (ϵ and σ) is restricted to ± 5%. The uncertainty is the RSS of the ConvF uncertainty for indicated target tissue parameters.

^G Alpha/Depth are determined during calibration. SPEAG warrants that the remaining deviation due to the boundary effect after compensation is always less than ± 1% for frequencies below 3 GHz and below ± 2% for frequencies between 3-6 GHz at any distance larger than half the probe tip diameter from the boundary.

Unless otherwise stated the results shown in this test report refer only to the sample(s) tested and such sample(s) are retained for 90 days only.

除非另有說明，此報告結果僅對測試之樣品負責，同時此樣品僅保留90天。本報告未經本公司書面許可，不可部份複製。

This document is issued by the Company subject to its General Conditions of Service printed overleaf, available on request or accessible at www.sgs.com/terms_and_conditions.htm and, for electronic format documents, subject to Terms and Conditions for Electronic Documents at www.sgs.com/terms_e-document.htm. Attention is drawn to the limitation of liability, indemnification and jurisdiction issues defined therein. Any holder of this document is advised that information contained hereon reflects the Company's findings at the time of its intervention only and within the limits of Client's instructions, if any. The Company's sole responsibility is to its Client and this document does not exonerate parties to a transaction from exercising all their rights and obligations under the transaction documents. This document cannot be reproduced except in full, without prior written approval of the Company. Any unauthorized alteration, forgery or falsification of the content or appearance of this document is unlawful and offenders may be prosecuted to the fullest extent of the law.

EX3DV4-SN:3770

April 28, 2015

Frequency Response of E-Field (TEM-Cell:ifi110 EXX, Waveguide: R22)

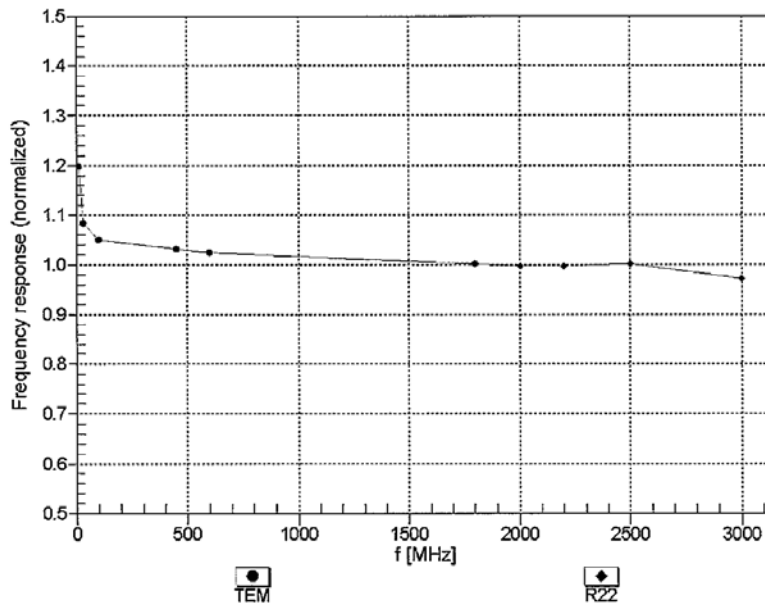

Uncertainty of Frequency Response of E-field: $\pm 6.3\%$ ($k=2$)

Unless otherwise stated the results shown in this test report refer only to the sample(s) tested and such sample(s) are retained for 90 days only.

除非另有說明，此報告結果僅對測試之樣品負責，同時此樣品僅保留90天。本報告未經本公司書面許可，不可部份複製。

This document is issued by the Company subject to its General Conditions of Service printed overleaf, available on request or accessible at www.sgs.com/terms_and_conditions.htm and, for electronic format documents, subject to Terms and Conditions for Electronic Documents at www.sgs.com/terms_e-document.htm. Attention is drawn to the limitation of liability, indemnification and jurisdiction issues defined therein. Any holder of this document is advised that information contained hereon reflects the Company's findings at the time of its intervention only and within the limits of Client's instructions, if any. The Company's sole responsibility is to its Client and this document does not exonerate parties to a transaction from exercising all their rights and obligations under the transaction documents. This document cannot be reproduced except in full, without prior written approval of the Company. Any unauthorized alteration, forgery or falsification of the content or appearance of this document is unlawful and offenders may be prosecuted to the fullest extent of the law.

EX3DV4-SN:3770

April 28, 2015

Receiving Pattern (ϕ), $\theta = 0^\circ$

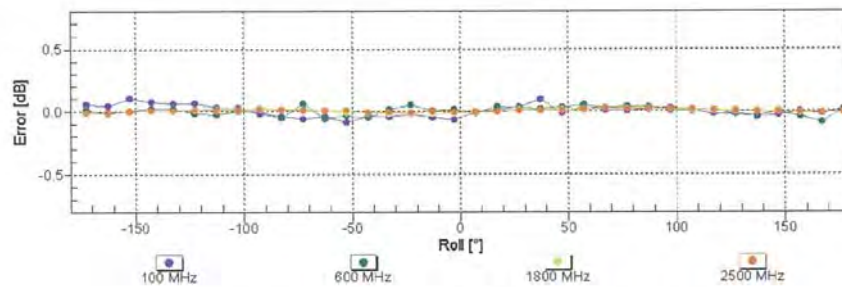
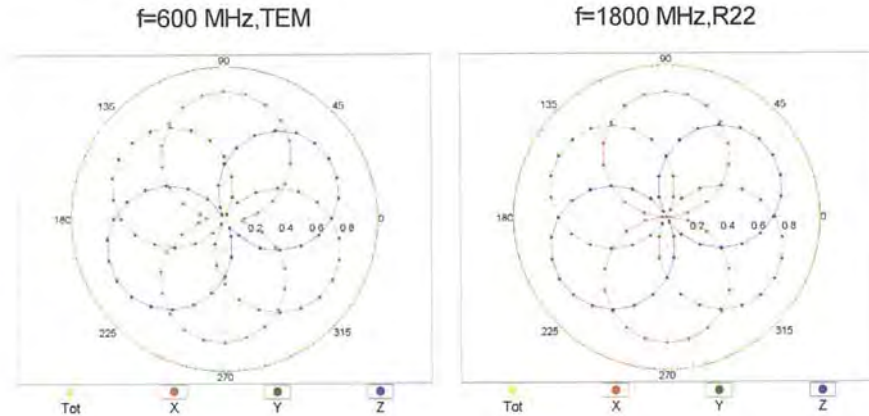

Uncertainty of Axial Isotropy Assessment: $\pm 0.5\%$ ($k=2$)

Unless otherwise stated the results shown in this test report refer only to the sample(s) tested and such sample(s) are retained for 90 days only.

除非另有說明，此報告結果僅對測試之樣品負責，同時此樣品僅保留90天。本報告未經本公司書面許可，不可部份複製。

This document is issued by the Company subject to its General Conditions of Service printed overleaf, available on request or accessible at www.sgs.com/terms_and_conditions.htm and, for electronic format documents, subject to Terms and Conditions for Electronic Documents at www.sgs.com/terms_e-document.htm. Attention is drawn to the limitation of liability, indemnification and jurisdiction issues defined therein. Any holder of this document is advised that information contained hereon reflects the Company's findings at the time of its intervention only and within the limits of Client's instructions, if any. The Company's sole responsibility is to its Client and this document does not exonerate parties to a transaction from exercising all their rights and obligations under the transaction documents. This document cannot be reproduced except in full, without prior written approval of the Company. Any unauthorized alteration, forgery or falsification of the content or appearance of this document is unlawful and offenders may be prosecuted to the fullest extent of the law.

Dynamic Range $f(SAR_{head})$ (TEM cell, $f_{eval} = 1900$ MHz)

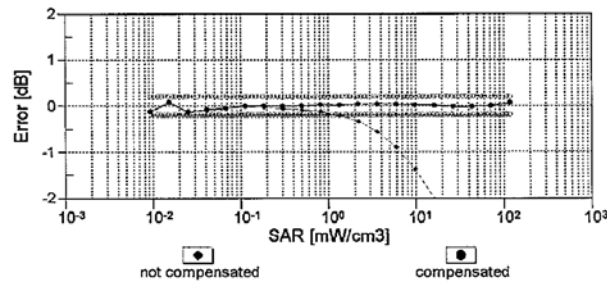
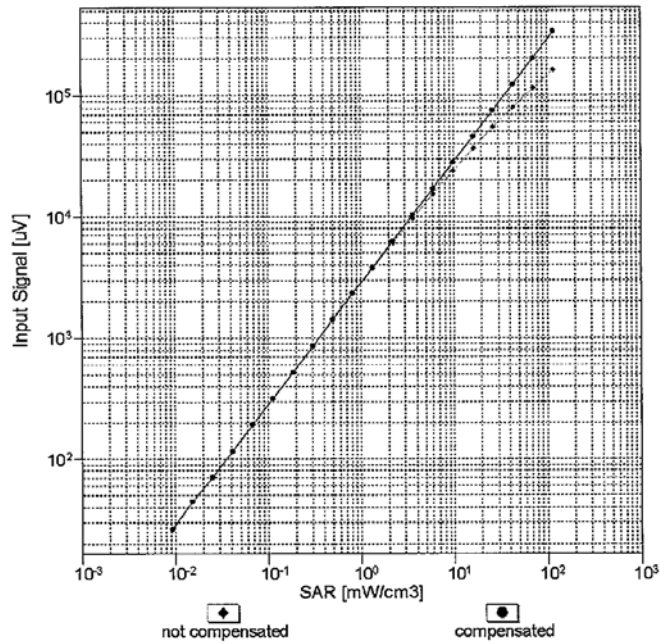

Uncertainty of Linearity Assessment: $\pm 0.6\%$ ($k=2$)

Unless otherwise stated the results shown in this test report refer only to the sample(s) tested and such sample(s) are retained for 90 days only.

除非另有說明，此報告結果僅對測試之樣品負責，同時此樣品僅保留90天。本報告未經本公司書面許可，不可部份複製。

This document is issued by the Company subject to its General Conditions of Service printed overleaf, available on request or accessible at www.sgs.com/terms_and_conditions.htm and, for electronic format documents, subject to Terms and Conditions for Electronic Documents at www.sgs.com/terms_e-document.htm. Attention is drawn to the limitation of liability, indemnification and jurisdiction issues defined therein. Any holder of this document is advised that information contained hereon reflects the Company's findings at the time of its intervention only and within the limits of Client's instructions, if any. The Company's sole responsibility is to its Client and this document does not exonerate parties to a transaction from exercising all their rights and obligations under the transaction documents. This document cannot be reproduced except in full, without prior written approval of the Company. Any unauthorized alteration, forgery or falsification of the content or appearance of this document is unlawful and offenders may be prosecuted to the fullest extent of the law.

EX3DV4-SN:3770

April 28, 2015

Conversion Factor Assessment

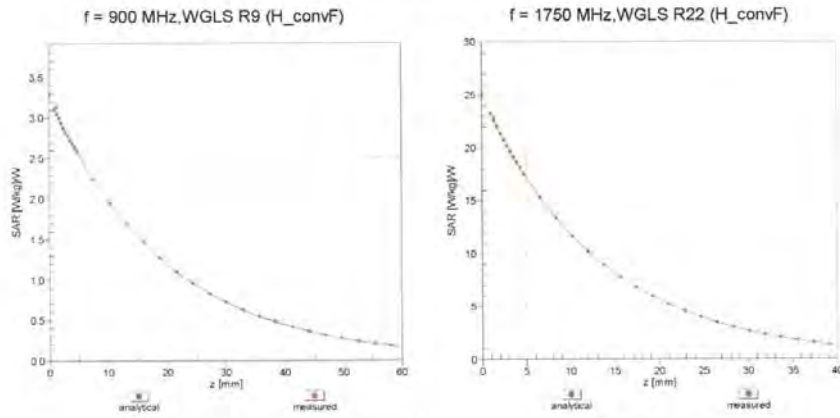

Deviation from Isotropy in Liquid

Error (ϕ, θ), $f = 900 \text{ MHz}$

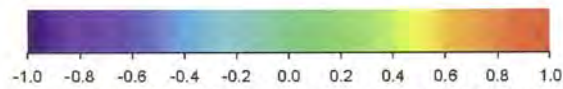
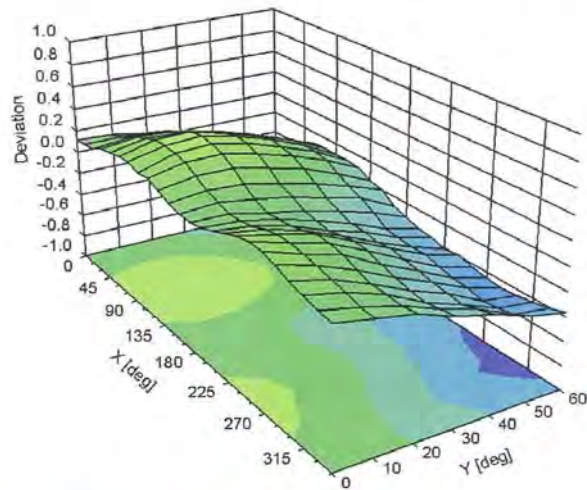

Uncertainty of Spherical Isotropy Assessment: $\pm 2.6\%$ ($k=2$)

Unless otherwise stated the results shown in this test report refer only to the sample(s) tested and such sample(s) are retained for 90 days only.

除非另有說明，此報告結果僅對測試之樣品負責，同時此樣品僅保留90天。本報告未經本公司書面許可，不可部份複製。

This document is issued by the Company subject to its General Conditions of Service printed overleaf, available on request or accessible at www.sgs.com/terms_and_conditions.htm and, for electronic format documents, subject to Terms and Conditions for Electronic Documents at www.sgs.com/terms_e-document.htm. Attention is drawn to the limitation of liability, indemnification and jurisdiction issues defined therein. Any holder of this document is advised that information contained hereon reflects the Company's findings at the time of its intervention only and within the limits of Client's instructions, if any. The Company's sole responsibility is to its Client and this document does not exonerate parties to a transaction from exercising all their rights and obligations under the transaction documents. This document cannot be reproduced except in full, without prior written approval of the Company. Any unauthorized alteration, forgery or falsification of the content or appearance of this document is unlawful and offenders may be prosecuted to the fullest extent of the law.

DASY/EASY - Parameters of Probe: EX3DV4 - SN:3770

Other Probe Parameters

| | |
|---|------------|
| Sensor Arrangement | Triangular |
| Connector Angle (°) | -32.7 |
| Mechanical Surface Detection Mode | enabled |
| Optical Surface Detection Mode | disabled |
| Probe Overall Length | 337 mm |
| Probe Body Diameter | 10 mm |
| Tip Length | 9 mm |
| Tip Diameter | 2.5 mm |
| Probe Tip to Sensor X Calibration Point | 1 mm |
| Probe Tip to Sensor Y Calibration Point | 1 mm |
| Probe Tip to Sensor Z Calibration Point | 1 mm |
| Recommended Measurement Distance from Surface | 1.4 mm |

Unless otherwise stated the results shown in this test report refer only to the sample(s) tested and such sample(s) are retained for 90 days only.

除非另有說明，此報告結果僅對測試之樣品負責，同時此樣品僅保留90天。本報告未經本公司書面許可，不可部份複製。

This document is issued by the Company subject to its General Conditions of Service printed overleaf, available on request or accessible at www.sgs.com/terms_and_conditions.htm and, for electronic format documents, subject to Terms and Conditions for Electronic Documents at www.sgs.com/terms_e-document.htm. Attention is drawn to the limitation of liability, indemnification and jurisdiction issues defined therein. Any holder of this document is advised that information contained hereon reflects the Company's findings at the time of its intervention only and within the limits of Client's instructions, if any. The Company's sole responsibility is to its Client and this document does not exonerate parties to a transaction from exercising all their rights and obligations under the transaction documents. This document cannot be reproduced except in full, without prior written approval of the Company. Any unauthorized alteration, forgery or falsification of the content or appearance of this document is unlawful and offenders may be prosecuted to the fullest extent of the law.

8. Uncertainty Budget

Measurement Uncertainty evaluation template for DUT SAR test
IEEE 1528

| A | c | D | e | | f | g | h=c * f / e | i=c * g / e | k |
|--|---------------------------|-----------------------------|-----|-----------|---------|----------|-------------------------|-------------------------|-------------|
| Source of Uncertainty | Tolerance/ Uncertainty | Probability Distributiol | Div | Div Value | ci (1g) | ci (10g) | Standard uncertainty | Standard uncertainty | vi, or Veff |
| Measurement system | | | | | | | | | |
| Probe calibration | 6.55% | N | 1 | 1 | 1 | 1 | 6.55% | 6.55% | ∞ |
| <i>Isotropy, Axial</i> | 3.50% | R | √3 | 1.732 | 1 | 1 | 2.02% | 2.02% | ∞ |
| <i>Isotropy, Hemispherical</i> | 9.60% | R | √3 | 1.732 | 1 | 1 | 5.54% | 5.54% | ∞ |
| Boundary Effect | 1.00% | R | √3 | 1.732 | 1 | 1 | 0.58% | 0.58% | ∞ |
| Linearity | 4.70% | R | √3 | 1.732 | 1 | 1 | 2.71% | 2.71% | ∞ |
| Detection Limits | 1.00% | R | √3 | 1.732 | 1 | 1 | 0.58% | 0.58% | ∞ |
| Readout Electronics | 0.30% | N | 1 | 1 | 1 | 1 | 0.30% | 0.30% | ∞ |
| Response time | 0.80% | R | √3 | 1.732 | 1 | 1 | 0.46% | 0.46% | ∞ |
| Integration Time | 2.60% | R | √3 | 1.732 | 1 | 1 | 1.50% | 1.50% | ∞ |
| Measurement drift (class A evaluation) | | | | | | | | | |
| RF ambient condition - noise | 3.00% | R | √3 | 1.732 | 1 | 1 | 1.73% | 1.73% | ∞ |
| RF ambient conditions - reflections | 3.00% | R | √3 | 1.732 | 1 | 1 | 1.73% | 1.73% | ∞ |
| Probe positioner Mechanical restrictions | 0.40% | R | √3 | 1.732 | 1 | 1 | 0.23% | 0.23% | ∞ |
| Probe Positioning with respect to phantom shell | 2.90% | R | √3 | 1.732 | 1 | 1 | 1.67% | 1.67% | ∞ |
| Post-processing | 1.00% | R | √3 | 1.732 | 1 | 1 | 0.58% | 0.58% | ∞ |
| Max SAR Eval | 1.00% | R | √3 | 1.732 | 1 | 1 | 0.58% | 0.58% | ∞ |
| Test Sample related | | | | | | | | | |
| Test sample positioning | 2.90% | N | 1 | 1 | 1 | 1 | 2.90% | 2.90% | M-1 |
| Device Holder Uncertainty | 3.60% | N | 1 | 1 | 1 | 1 | 3.60% | 3.60% | M-1 |
| Drift of output power | 5.00% | R | √3 | 1.732 | 1 | 1 | 2.89% | 2.89% | ∞ |
| Phantom and Setup | | | | | | | | | |
| Phantom Uncertainty | 4.00% | R | √3 | 1.732 | 1 | 1 | 2.31% | 2.31% | ∞ |
| Deviation from reference liquid target ϵ_r (Body) | 3.04% | N | 1 | 1 | 0.64 | 0.43 | 1.95% | 1.31% | M |
| Deviation from reference liquid target σ (Body) | 3.74% | N | 1 | 1 | 0.6 | 0.49 | 2.24% | 1.83% | M |
| Liquid conductivity σ – temperature uncertainty | 2.20% | R | √3 | 1.732 | 0.78 | 0.71 | 0.99% | 0.90% | ∞ |
| Liquid permittivity ϵ – temperature uncertainty | 0.20% | R | √3 | 1.732 | 0.23 | 0.26 | 0.03% | 0.03% | ∞ |
| Combined standard uncertainty | | RSS | | | | | 11.99% | 11.82% | |
| Expant uncertainty (95% confidence interval), K=2 | | | | | | | 23.97% | 23.64% | |

Unless otherwise stated the results shown in this test report refer only to the sample(s) tested and such sample(s) are retained for 90 days only.

除非另有說明，此報告結果僅對測試之樣品負責，同時此樣品僅保留90天。本報告未經本公司書面許可，不可部份複製。

This document is issued by the Company subject to its General Conditions of Service printed overleaf, available on request or accessible at www.sgs.com/terms_and_conditions.htm and, for electronic format documents, subject to Terms and Conditions for Electronic Documents at www.sgs.com/terms_e-document.htm. Attention is drawn to the limitation of liability, indemnification and jurisdiction issues defined therein. Any holder of this document is advised that information contained hereon reflects the Company's findings at the time of its intervention only and within the limits of Client's instructions, if any. The Company's sole responsibility is to its Client and this document does not exonerate parties to a transaction from exercising all their rights and obligations under the transaction documents. This document cannot be reproduced except in full, without prior written approval of the Company. Any unauthorized alteration, forgery or falsification of the content or appearance of this document is unlawful and offenders may be prosecuted to the fullest extent of the law.

9. Phantom Description

Schmid & Partner Engineering AG

s p e a g

Zeughausstrasse 43, 8004 Zurich, Switzerland
Phone +41 1 245 9700, Fax +41 1 245 9779
info@speag.com, http://www.speag.com

Certificate of Conformity / First Article Inspection

| | |
|--------------|--|
| Item | SAM Twin Phantom V4.0 |
| Type No | QD 000 P40 C |
| Series No | TP-1150 and higher |
| Manufacturer | SPEAG Zeughausstrasse 43 CH-8004 Zurich Switzerland |

Tests

The series production process used allows the limitation to test of first articles.
Complete tests were made on the pre-series Type No. QD 000 P40 AA, Serial No. TP-1001 and on the series first article Type No. QD 000 P40 BA, Serial No. TP-1006. Certain parameters have been retested using further series items (called samples) or are tested at each item.

| Test | Requirement | Details | Units tested |
|-----------------------------|--|--|---|
| Dimensions | Compliant with the geometry according to the CAD model. | IT/IS CAD File (*) | First article, Samples |
| Material thickness of shell | Compliant with the requirements according to the standards | 2mm +/- 0.2mm in flat and specific areas of head section | First article, Samples, TP-1314 ff. |
| Material thickness at ERP | Compliant with the requirements according to the standards | 6mm +/- 0.2mm at ERP | First article, A3 items |
| Material parameters | Dielectric parameters for required frequencies | 300 MHz – 6 GHz; Relative permittivity < 5. Loss tangent < 0.05 | Material samples |
| Material resistivity | The material has been tested to be compatible with the liquids defined in the standards if handled and cleaned according to the instructions. Observe technical Note for material compatibility. | DEGMRE based simulating liquids | Pre-series, First article, Material samples |
| Sagging | Compliant with the requirements according to the standards. Sagging of the flat section when filled with tissue simulating liquid | < 1% typical < 0.6% if filled with 155mm of HSL900 and without DUT below | Prototypes, Sample testing |

Standards

- (1) CENELEC EN 50361
 - (2) IEEE Std 1528-2003
 - (3) IEC 62209 Part 1
 - (4) FCC OET Bulletin 65, Supplement C, Edition 01-01
- (*) The IT/IS CAD file is derived from [2] and is also within the tolerance requirements of the shapes of the other documents.

Conformity

Based on the sample tests above, we certify that this item is in compliance with the uncertainty requirements of SAR measurements specified in standards [1] to [4]

Date 07.07.2005

Signature / Stamp

s p e a g

Schmid & Partner Engineering AG
Zeughausstrasse 43, 8004 Zurich, Switzerland
Phone +41 1 245 9700, Fax +41 1 245 9779
info@speag.com, http://www.speag.com

Doc No: S&P - QD 000 P40 C - 3

Page 1 (1)

Unless otherwise stated the results shown in this test report refer only to the sample(s) tested and such sample(s) are retained for 90 days only.

除非另有說明，此報告結果僅對測試之樣品負責，同時此樣品僅保留90天。本報告未經本公司書面許可，不可部份複製。

This document is issued by the Company subject to its General Conditions of Service printed overleaf, available on request or accessible at www.sgs.com/terms_and_conditions.htm and, for electronic format documents, subject to Terms and Conditions for Electronic Documents at www.sgs.com/terms_e-document.htm. Attention is drawn to the limitation of liability, indemnification and jurisdiction issues defined therein. Any holder of this document is advised that information contained hereon reflects the Company's findings at the time of its intervention only and within the limits of Client's instructions, if any. The Company's sole responsibility is to its Client and this document does not exonerate parties to a transaction from exercising all their rights and obligations under the transaction documents. This document cannot be reproduced except in full, without prior written approval of the Company. Any unauthorized alteration, forgery or falsification of the content or appearance of this document is unlawful and offenders may be prosecuted to the fullest extent of the law.

SGS Taiwan Ltd.

台灣檢驗科技股份有限公司

No.134,Wu Kung Road, New Taipei Industrial Park, Wuku District, New Taipei City, Taiwan 24803/新北市五股區新北產業園區五工路 134 號

t (886-2) 2299-3279

f (886-2) 2298-0488

www.tw.sgs.com

Member of SGS Group

10. System Validation from Original Equipment Supplier

Calibration Laboratory of
Schmid & Partner
Engineering AG
Zeughausstrasse 43, 8004 Zurich, Switzerland



S Schweizerischer Kalibrierdienst
S Service suisse d'étalonnage
S Servizio svizzero di taratura
S Swiss Calibration Service

Accredited by the Swiss Accreditation Service (SAS)
The Swiss Accreditation Service is one of the signatories to the EA
Multilateral Agreement for the recognition of calibration certificates

Accreditation No.: SCS 108

Client: SGS-TW (Auden)

Certificate No.: D750V3-1015_Aug14

| CALIBRATION CERTIFICATE | | | |
|---|--|-----------------------------------|-------------------------|
| Object | D750V3 - SN: 1015 | | |
| Calibration procedure(s) | QA CAL-05.v9 Calibration procedure for dipole validation kits above 700 MHz | | |
| Calibration date: | August 28, 2014 | | |
| <p>This calibration certificate documents the traceability to national standards, which realize the physical units of measurements (SI). The measurements and the uncertainties with confidence probability are given on the following pages and are part of the certificate.</p> <p>All calibrations have been conducted in the closed laboratory facility; environment temperature (22 ± 0.1°C) and humidity < 70%.</p> <p>Calibration Equipment used (MATE optical for calibration)</p> | | | |
| Primary Standards | ID # | Cal Date (Certificate No.) | Scheduled Calibration |
| Power meter EPM-442A | GB37480794 | 09-Oct-13 (No. 217-01427) | Oct-14 |
| Power sensor HP 8481A | US37292783 | 09-Oct-13 (No. 217-01827) | Oct-14 |
| Power sensor HP 8481A | MY41092317 | 09-Oct-13 (No. 217-01828) | Oct-14 |
| Reference 20 dB Attenuator | SN: 5058 (29K) | 03-Apr-14 (No. 217-01916) | Apr-15 |
| Type-N mismatch combination | SN: 5047.2 / 00327 | 03-Apr-14 (No. 217-01921) | Apr-15 |
| Reference Probe ES3DV3 | SN: 3205 | 30-Dec-13 (No. ES3-3205_Dec13) | Dec-14 |
| DAE# | SN: 601 | 18-Aug-14 (No. DAE4-601_Aug14) | Aug-15 |
| Secondary Standards | ID # | Check Date (in house) | Scheduled Check |
| RF generator R&S SMT-05 | 100005 | 04-Aug-14 (in house check Oct-13) | In house check: Oct-14 |
| Network Analyzer HP 8753E | US37390585 84205 | 18-Oct-01 (in house check Oct-13) | In house check: Oct-14 |
| Calibrated by: | Name: Minsel Weber | Function: Laboratory Technician | Signature: |
| Approved by: | Name: Karin Pollock | Function: Technical Manager | Signature: |
| This calibration certificate shall not be reproduced except in full without written approval of the laboratory. | | | Issued: August 28, 2014 |

Certificate No.: D750V3-1015_Aug14

Page 1 of 8

Unless otherwise stated the results shown in this test report refer only to the sample(s) tested and such sample(s) are retained for 90 days only.

除非另有說明，此報告結果僅對測試之樣品負責，同時此樣品僅保留90天。本報告未經本公司書面許可，不可部份複製。

This document is issued by the Company subject to its General Conditions of Service printed overleaf, available on request or accessible at www.sgs.com/terms_and_conditions.htm and, for electronic format documents, subject to Terms and Conditions for Electronic Documents at www.sgs.com/terms_e-document.htm. Attention is drawn to the limitation of liability, indemnification and jurisdiction issues defined therein. Any holder of this document is advised that information contained hereon reflects the Company's findings at the time of its intervention only and within the limits of Client's instructions, if any. The Company's sole responsibility is to its Client and this document does not exonerate parties to a transaction from exercising all their rights and obligations under the transaction documents. This document cannot be reproduced except in full, without prior written approval of the Company. Any unauthorized alteration, forgery or falsification of the content or appearance of this document is unlawful and offenders may be prosecuted to the fullest extent of the law.

**Calibration Laboratory of
Schmid & Partner
Engineering AG**
Zeughausstrasse 43, 8004 Zürich, Switzerland



S Schweizerischer Kalibrierdienst
C Service suisse d'étalonnage
S Servizio svizzero di etalonni
S Swiss Calibration Service

Accredited by the Swiss Accreditation Service (SAS)
The Swiss Accreditation Service is one of the signatories to the EA
Multilateral Agreement for the recognition of calibration certificates

Accreditation No.: **SCS 108**

Glossary:

TSL tissue simulating liquid
ConvF sensitivity in TSL / NORM x,y,z
N/A not applicable or not measured

Calibration is Performed According to the Following Standards:

- IEEE Std 1528-2013, "IEEE Recommended Practice for Determining the Peak Spatial-Averaged Specific Absorption Rate (SAR) in the Human Head from Wireless Communications Devices: Measurement Techniques", June 2013
- IEC 62209-1, "Procedure to measure the Specific Absorption Rate (SAR) for hand-held devices used in close proximity to the ear (frequency range of 300 MHz to 3 GHz)", February 2005
- KDB 865664, "SAR Measurement Requirements for 100 MHz to 6 GHz"

Additional Documentation:

- DASY4/5 System Handbook

Methods Applied and Interpretation of Parameters:

- Measurement Conditions:** Further details are available from the Validation Report at the end of the certificate. All figures stated in the certificate are valid at the frequency indicated.
- Antenna Parameters with TSL:** The dipole is mounted with the spacer to position its feed point exactly below the center marking of the flat phantom section, with the arms oriented parallel to the body axis.
- Feed Point Impedance and Return Loss:** These parameters are measured with the dipole positioned under the liquid filled phantom. The impedance stated is transformed from the measurement at the SMA connector to the feed point. The Return Loss ensures low reflected power. No uncertainty required.
- Electrical Delay:** One-way delay between the SMA connector and the antenna feed point. No uncertainty required.
- SAR measured:** SAR measured at the stated antenna input power.
- SAR normalized:** SAR as measured, normalized to an input power of 1 W at the antenna connector.
- SAR for nominal TSL parameters:** The measured TSL parameters are used to calculate the nominal SAR result.

The reported uncertainty of measurement is stated as the standard uncertainty of measurement multiplied by the coverage factor $k=2$, which for a normal distribution corresponds to a coverage probability of approximately 95%.

Unless otherwise stated the results shown in this test report refer only to the sample(s) tested and such sample(s) are retained for 90 days only.

除非另有說明，此報告結果僅對測試之樣品負責，同時此樣品僅保留90天。本報告未經本公司書面許可，不可部份複製。

This document is issued by the Company subject to its General Conditions of Service printed overleaf, available on request or accessible at www.sgs.com/terms_and_conditions.htm and, for electronic format documents, subject to Terms and Conditions for Electronic Documents at www.sgs.com/terms_e-document.htm. Attention is drawn to the limitation of liability, indemnification and jurisdiction issues defined therein. Any holder of this document is advised that information contained hereon reflects the Company's findings at the time of its intervention only and within the limits of Client's instructions, if any. The Company's sole responsibility is to its Client and this document does not exonerate parties to a transaction from exercising all their rights and obligations under the transaction documents. This document cannot be reproduced except in full, without prior written approval of the Company. Any unauthorized alteration, forgery or falsification of the content or appearance of this document is unlawful and offenders may be prosecuted to the fullest extent of the law.

Measurement Conditions

DASY system configuration, as per as not given on page 1.

| | | |
|------------------------------|------------------------|-------------|
| DASY Version | DASY5 | V52.6.6 |
| Extrapolation | Advanced Extrapolation | |
| Phantom | Modular Flat Phantom | |
| Distance Dipole Center - TSL | 15 mm | With Spacer |
| Zoom Scan Resolution | dx, dy, dz = 5 mm | |
| Frequency | 750 MHz ± 1 MHz | |

Head TSL parameters

The following parameters and calculations were applied.

| | Temperature | Permittivity | Conductivity |
|---|-----------------|--------------|------------------|
| Nominal Head TSL parameters | 22.0 °C | 41.9 | 0.89 mho/m |
| Measured Head TSL parameters | (22.0 ± 0.2) °C | 42.2 ± 6 % | 0.91 mho/m ± 6 % |
| Head TSL temperature change during test | < 0.5 °C | | |

SAR result with Head TSL

| SAR averaged over 1 cm ³ (1 g) of Head TSL | Condition | |
|---|--------------------|--------------------------|
| SAR measured | 250 mW input power | 2.11 W/kg |
| SAR for nominal Head TSL parameters | normalized to 1W | 8.31 W/kg ± 17.0 % (k=2) |

| SAR averaged over 10 cm ³ (10 g) of Head TSL | Condition | |
|---|--------------------|--------------------------|
| SAR measured | 250 mW input power | 1.38 W/kg |
| SAR for nominal Head TSL parameters | normalized to 1W | 5.45 W/kg ± 16.5 % (k=2) |

Body TSL parameters

The following parameters and calculations were applied.

| | Temperature | Permittivity | Conductivity |
|---|-----------------|--------------|------------------|
| Nominal Body TSL parameters | 22.0 °C | 55.5 | 0.96 mho/m |
| Measured Body TSL parameters | (22.0 ± 0.2) °C | 55.4 ± 6 % | 0.99 mho/m ± 6 % |
| Body TSL temperature change during test | < 0.5 °C | | |

SAR result with Body TSL

| SAR averaged over 1 cm ³ (1 g) of Body TSL | Condition | |
|---|--------------------|--------------------------|
| SAR measured | 250 mW input power | 2.24 W/kg |
| SAR for nominal Body TSL parameters | normalized to 1W | 8.75 W/kg ± 17.0 % (k=2) |

| SAR averaged over 10 cm ³ (10 g) of Body TSL | Condition | |
|---|--------------------|--------------------------|
| SAR measured | 250 mW input power | 1.49 W/kg |
| SAR for nominal Body TSL parameters | normalized to 1W | 5.85 W/kg ± 16.5 % (k=2) |

Unless otherwise stated the results shown in this test report refer only to the sample(s) tested and such sample(s) are retained for 90 days only.

除非另有說明，此報告結果僅對測試之樣品負責，同時此樣品僅保留90天。本報告未經本公司書面許可，不可部份複製。

This document is issued by the Company subject to its General Conditions of Service printed overleaf, available on request or accessible at www.sgs.com/terms_and_conditions.htm and, for electronic format documents, subject to Terms and Conditions for Electronic Documents at www.sgs.com/terms_e-document.htm. Attention is drawn to the limitation of liability, indemnification and jurisdiction issues defined therein. Any holder of this document is advised that information contained hereon reflects the Company's findings at the time of its intervention only and within the limits of Client's instructions, if any. The Company's sole responsibility is to its Client and this document does not exonerate parties to a transaction from exercising all their rights and obligations under the transaction documents. This document cannot be reproduced except in full, without prior written approval of the Company. Any unauthorized alteration, forgery or falsification of the content or appearance of this document is unlawful and offenders may be prosecuted to the fullest extent of the law.

Appendix (Additional assessments outside the scope of SCS108)

Antenna Parameters with Head TSL

| | |
|--------------------------------------|-------------------------------|
| Impedance, transformed to feed point | 53.1 Ω - 0.4 $j\Omega$ |
| Return Loss | - 30.4 dB |

Antenna Parameters with Body TSL

| | |
|--------------------------------------|-------------------------------|
| Impedance, transformed to feed point | 48.3 Ω - 2.9 $j\Omega$ |
| Return Loss | - 29.5 dB |

General Antenna Parameters and Design

| | |
|----------------------------------|----------|
| Electrical Delay (one direction) | 1.037 ns |
|----------------------------------|----------|

After long term use with 100W radiated power, only a slight warming of the dipole near the feedpoint can be measured.

The dipole is made of standard semirigid coaxial cable. The center conductor of the feeding line is directly connected to the second arm of the dipole. The antenna is therefore short-circuited for DC-signals. On some of the dipoles, small end caps are added to the dipole arms in order to improve matching when loaded according to the position as explained in the "Measurement Conditions" paragraph. The SAR data are not affected by this change. The overall dipole length is still according to the Standard.

No excessive force must be applied to the dipole arms, because they might bend or the soldered connections near the feedpoint may be damaged.

Additional EUT Data

| | |
|-----------------|----------------|
| Manufactured by | SPEAG |
| Manufactured on | March 22, 2010 |

Unless otherwise stated the results shown in this test report refer only to the sample(s) tested and such sample(s) are retained for 90 days only.

除非另有說明，此報告結果僅對測試之樣品負責，同時此樣品僅保留90天。本報告未經本公司書面許可，不可部份複製。

This document is issued by the Company subject to its General Conditions of Service printed overleaf, available on request or accessible at www.sgs.com/terms_and_conditions.htm and, for electronic format documents, subject to Terms and Conditions for Electronic Documents at www.sgs.com/terms_e-document.htm. Attention is drawn to the limitation of liability, indemnification and jurisdiction issues defined therein. Any holder of this document is advised that information contained hereon reflects the Company's findings at the time of its intervention only and within the limits of Client's instructions, if any. The Company's sole responsibility is to its Client and this document does not exonerate parties to a transaction from exercising all their rights and obligations under the transaction documents. This document cannot be reproduced except in full, without prior written approval of the Company. Any unauthorized alteration, forgery or falsification of the content or appearance of this document is unlawful and offenders may be prosecuted to the fullest extent of the law.

DASY5 Validation Report for Head TSL

Date: 28.08.2014

Test Laboratory: SPEAG, Zurich, Switzerland

DUT: Dipole 750 MHz; Type: D750V3; Serial: D750V3 - SN: 1015

Communication System: UID 0 - CW; Frequency: 750 MHz
Medium parameters used: $f = 750 \text{ MHz}$; $\sigma = 0.91 \text{ S/m}$; $\epsilon_r = 42.2$; $\rho = 1000 \text{ kg/m}^3$
Phantom section: Flat Section
Measurement Standard: DASY5 (IEEE/IEC/ANSI C63.19-2011)

DASY52 Configuration:

- Probe: ES3DV3 - SN3205; ConvF(6.37, 6.37, 6.37); Calibrated: 30.12.2013;
- Sensor-Surface: 3mm (Mechanical Surface Detection)
- Electronics: DAE4 Sn601; Calibrated: 18.08.2014
- Phantom: Flat Phantom 4.9L; Type: QD000P49AA; Serial: 1001
- DASY52 52.8.8(1222); SEMCAD X 14.6.10(7331)

Dipole Calibration for Head Tissue/Pin=250 mW, d=15mm/Zoom Scan (7x7x7)/Cube 0:

Measurement grid: $dx=5\text{mm}$, $dy=5\text{mm}$, $dz=5\text{mm}$
Reference Value = 53.68 V/m; Power Drift = 0.01 dB
Peak SAR (extrapolated) = 3.13 W/kg
SAR(1 g) = 2.11 W/kg; SAR(10 g) = 1.38 W/kg
Maximum value of SAR (measured) = 2.46 W/kg

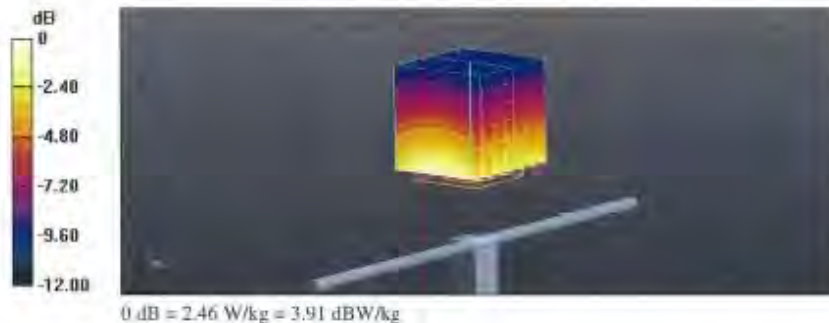

Unless otherwise stated the results shown in this test report refer only to the sample(s) tested and such sample(s) are retained for 90 days only.

除非另有說明，此報告結果僅對測試之樣品負責，同時此樣品僅保留90天。本報告未經本公司書面許可，不可部份複製。

This document is issued by the Company subject to its General Conditions of Service printed overleaf, available on request or accessible at www.sgs.com/terms_and_conditions.htm and, for electronic format documents, subject to Terms and Conditions for Electronic Documents at www.sgs.com/terms_e-document.htm. Attention is drawn to the limitation of liability, indemnification and jurisdiction issues defined therein. Any holder of this document is advised that information contained hereon reflects the Company's findings at the time of its intervention only and within the limits of Client's instructions, if any. The Company's sole responsibility is to its Client and this document does not exonerate parties to a transaction from exercising all their rights and obligations under the transaction documents. This document cannot be reproduced except in full, without prior written approval of the Company. Any unauthorized alteration, forgery or falsification of the content or appearance of this document is unlawful and offenders may be prosecuted to the fullest extent of the law.

Impedance Measurement Plot for Head TSL

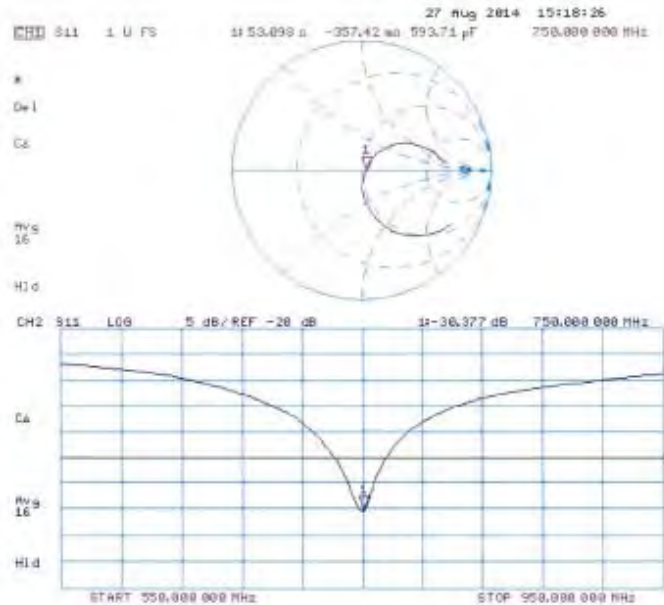

Unless otherwise stated the results shown in this test report refer only to the sample(s) tested and such sample(s) are retained for 90 days only.

除非另有說明，此報告結果僅對測試之樣品負責，同時此樣品僅保留90天。本報告未經本公司書面許可，不可部份複製。

This document is issued by the Company subject to its General Conditions of Service printed overleaf, available on request or accessible at www.sgs.com/terms_and_conditions.htm and, for electronic format documents, subject to Terms and Conditions for Electronic Documents at www.sgs.com/terms_e-document.htm. Attention is drawn to the limitation of liability, indemnification and jurisdiction issues defined therein. Any holder of this document is advised that information contained hereon reflects the Company's findings at the time of its intervention only and within the limits of Client's instructions, if any. The Company's sole responsibility is to its Client and this document does not exonerate parties to a transaction from exercising all their rights and obligations under the transaction documents. This document cannot be reproduced except in full, without prior written approval of the Company. Any unauthorized alteration, forgery or falsification of the content or appearance of this document is unlawful and offenders may be prosecuted to the fullest extent of the law.

DASY5 Validation Report for Body TSL

Date: 27.08.2014

Test Laboratory: SPEAG, Zurich, Switzerland

DUT: Dipole 750 MHz; Type: D750V3; Serial: D750V3 - SN: 1015

Communication System: UID 0 - CW; Frequency: 750 MHz
Medium parameters used: $f = 750$ MHz; $\sigma = 0.99$ S/m; $\epsilon_r = 55.4$; $\rho = 1000$ kg/m³
Phantom section: Flat Section
Measurement Standard: DASY5 (IEEE/IEC/ANSI C63.19-2011)

DASY52 Configuration:

- Probe: ES3DV3 - SN3205; ConvF(6.13, 6.13, 6.13); Calibrated: 30.12.2013;
- Sensor-Surface: 3mm (Mechanical Surface Detection)
- Electronics: DAE4 Sn601; Calibrated: 18.08.2014
- Phantom: Flat Phantom 4.9L; Type: QD000P49AA; Serial: 1001
- DASY52 52.8,8(1222); SEMCAD X 14.6.10(7331)

Dipole Calibration for Body Tissue/Pin=250 mW, d=15mm/Zoom Scan (7x7x7)/Cube 0:

Measurement grid: dx=5mm, dy=5mm, dz=5mm
Reference Value = 53.06 V/m; Power Drift = -0.02 dB
Peak SAR (extrapolated) = 3.26 W/kg
SAR(1 g) = 2.24 W/kg; SAR(10 g) = 1.49 W/kg
Maximum value of SAR (measured) = 2.60 W/kg

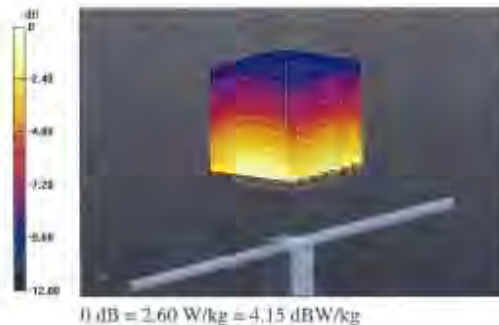

Unless otherwise stated the results shown in this test report refer only to the sample(s) tested and such sample(s) are retained for 90 days only.

除非另有說明，此報告結果僅對測試之樣品負責，同時此樣品僅保留90天。本報告未經本公司書面許可，不可部份複製。

This document is issued by the Company subject to its General Conditions of Service printed overleaf, available on request or accessible at www.sgs.com/terms_and_conditions.htm and, for electronic format documents, subject to Terms and Conditions for Electronic Documents at www.sgs.com/terms_e-document.htm. Attention is drawn to the limitation of liability, indemnification and jurisdiction issues defined therein. Any holder of this document is advised that information contained hereon reflects the Company's findings at the time of its intervention only and within the limits of Client's instructions, if any. The Company's sole responsibility is to its Client and this document does not exonerate parties to a transaction from exercising all their rights and obligations under the transaction documents. This document cannot be reproduced except in full, without prior written approval of the Company. Any unauthorized alteration, forgery or falsification of the content or appearance of this document is unlawful and offenders may be prosecuted to the fullest extent of the law.

Impedance Measurement Plot for Body TSL

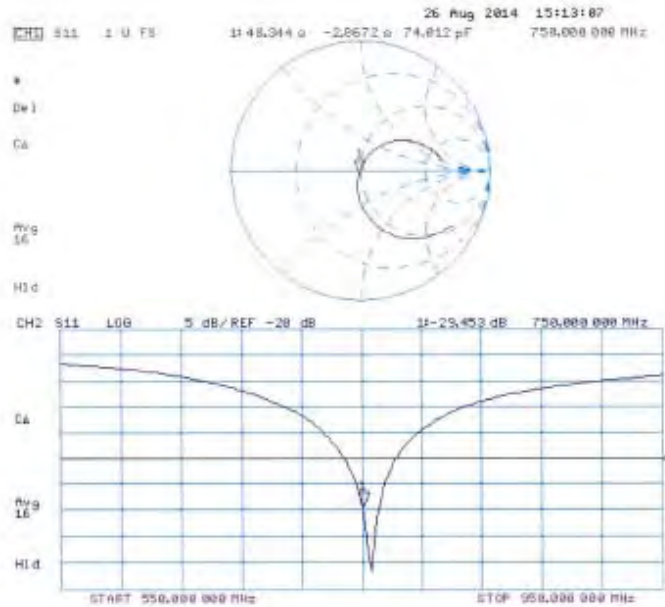

Unless otherwise stated the results shown in this test report refer only to the sample(s) tested and such sample(s) are retained for 90 days only.

除非另有說明，此報告結果僅對測試之樣品負責，同時此樣品僅保留90天。本報告未經本公司書面許可，不可部份複製。

This document is issued by the Company subject to its General Conditions of Service printed overleaf, available on request or accessible at www.sgs.com/terms_and_conditions.htm and, for electronic format documents, subject to Terms and Conditions for Electronic Documents at www.sgs.com/terms_e-document.htm. Attention is drawn to the limitation of liability, indemnification and jurisdiction issues defined therein. Any holder of this document is advised that information contained hereon reflects the Company's findings at the time of its intervention only and within the limits of Client's instructions, if any. The Company's sole responsibility is to its Client and this document does not exonerate parties to a transaction from exercising all their rights and obligations under the transaction documents. This document cannot be reproduced except in full, without prior written approval of the Company. Any unauthorized alteration, forgery or falsification of the content or appearance of this document is unlawful and offenders may be prosecuted to the fullest extent of the law.

**Calibration Laboratory of
Schmid & Partner
Engineering AG**
Zeughausstrasse 43, 8004 Zurich, Switzerland



S Schweizerischer Kalibrierdienst
C Service suisse d'étalonnage
S Servizio svizzero di taratura
S Swiss Calibration Service

Accredited by the Swiss Accreditation Service (SAS)
The Swiss Accreditation Service is one of the signatories to the EA
Multilateral Agreement for the recognition of calibration certificates

Accreditation No.: **SCS 108**

Client **SGS-TW (Auden)**

Certificate No: **D835V2-4d063_Aug14**

CALIBRATION CERTIFICATE

Object: **D835V2 - SN: 4d063**

Calibration procedure(s): **QA CAL-05.v9
Calibration procedure for dipole validation kits above 700 MHz**

Calibration date: **August 28, 2014**

This calibration certificate documents the traceability to national standards, which realize the physical units of measurements (SI).
The measurements and the uncertainties with confidence probability are given on the following pages and are part of the certificate.

All calibrations have been conducted in the closed laboratory facility, environment temperature (22 ± 3)°C and humidity < 70%.

Calibration Equipment used (MPE critical for calibration)

| Primary Standards | ID # | Cal. Date (Certificate No.) | Scheduled Calibration |
|----------------------------|--------------------|-----------------------------------|-----------------------|
| Power meter EPM-442A | 0837480704 | 09-Oct-13 (No. 217-01827) | Oct-14 |
| Power sensor HP 8461A | US37292793 | 09-Oct-13 (No. 217-01827) | Oct-14 |
| Power sensor HP 8481A | MY41092317 | 09-Oct-13 (No. 217-01828) | Oct-14 |
| Reference 20 dB Attenuator | SN: 5008 (20K) | 03-Apr-14 (No. 217-01816) | Apr-15 |
| Type-N mismatch combinator | SN: 5047.2 / 06327 | 03-Apr-14 (No. 217-01921) | Apr-15 |
| Reference Probe ES30DV3 | SN: 3206 | 30-Dec-13 (No. ES3-3206_Dec13) | Dec-14 |
| DAE4 | SN: 601 | 18-Aug-14 (No. DAE4-601_Aug14) | Aug-15 |
| Secondary Standards | ID # | Check Date (in house) | Scheduled Check |
| RF generator R&S SMT-06 | 100006 | 04-Aug-09 (in house check Oct-13) | in house check Oct-16 |
| Network Analyzer HP 8753E | US37390695 54206 | 18-Oct-01 (in house check Oct-15) | in house check Oct-14 |

Calibrated by: **Name: Michael Walser, Function: Laboratory Technician, Signature: [Signature]**

Approved by: **Name: Katja Polovic, Function: Technical Manager, Signature: [Signature]**

Issued: August 28, 2014

The calibration certificate shall not be reproduced except in full without written approval of the laboratory.

Certificate No: D835V2-4d063_Aug14

Page 1 of 8

Unless otherwise stated the results shown in this test report refer only to the sample(s) tested and such sample(s) are retained for 90 days only.

除非另有說明，此報告結果僅對測試之樣品負責，同時此樣品僅保留90天。本報告未經本公司書面許可，不可部份複製。

This document is issued by the Company subject to its General Conditions of Service printed overleaf, available on request or accessible at www.sgs.com/terms_and_conditions.htm and, for electronic format documents, subject to Terms and Conditions for Electronic Documents at www.sgs.com/terms_e-document.htm. Attention is drawn to the limitation of liability, indemnification and jurisdiction issues defined therein. Any holder of this document is advised that information contained hereon reflects the Company's findings at the time of its intervention only and within the limits of Client's instructions, if any. The Company's sole responsibility is to its Client and this document does not exonerate parties to a transaction from exercising all their rights and obligations under the transaction documents. This document cannot be reproduced except in full, without prior written approval of the Company. Any unauthorized alteration, forgery or falsification of the content or appearance of this document is unlawful and offenders may be prosecuted to the fullest extent of the law.

Calibration Laboratory of
Schmid & Partner
Engineering AG
Zeughausstrasse 43, 8004 Zurich, Switzerland



S Schweizerischer Kalibrierdienst
S Service suisse d'étalonnage
S Servizio svizzero di taratura
S Swiss Calibration Service

Accredited by the Swiss Accreditation Service (BAS)
The Swiss Accreditation Service is one of the signatories to the EA
Multilateral Agreement for the recognition of calibration certificates

Accreditation No.: **SCS 108**

Glossary:

TSL tissue simulating liquid
ConvF sensitivity in TSL / NORM x,y,z
N/A not applicable or not measured

Calibration is Performed According to the Following Standards:

- IEEE Std 1528-2013, "IEEE Recommended Practice for Determining the Peak Spatial-Averaged Specific Absorption Rate (SAR) in the Human Head from Wireless Communications Devices; Measurement Techniques", June 2013
- IEC 62209-1, "Procedure to measure the Specific Absorption Rate (SAR) for hand-held devices used in close proximity to the ear (frequency range of 300 MHz to 3 GHz)", February 2005
- KDB 865664, "SAR Measurement Requirements for 100 MHz to 6 GHz"

Additional Documentation:

- DASY4/5 System Handbook

Methods Applied and Interpretation of Parameters:

- Measurement Conditions:* Further details are available from the Validation Report at the end of the certificate. All figures stated in the certificate are valid at the frequency indicated.
- Antenna Parameters with TSL:* The dipole is mounted with the spacer to position its feed point exactly below the center marking of the flat phantom section, with the arms oriented parallel to the body axis.
- Feed Point Impedance and Return Loss:* These parameters are measured with the dipole positioned under the liquid filled phantom. The impedance stated is transformed from the measurement at the SMA connector to the feed point. The Return Loss ensures low reflected power. No uncertainty required.
- Electrical Delay:* One-way delay between the SMA connector and the antenna feed point. No uncertainty required.
- SAR measured:* SAR measured at the stated antenna input power.
- SAR normalized:* SAR as measured, normalized to an input power of 1 W at the antenna connector.
- SAR for nominal TSL parameters:* The measured TSL parameters are used to calculate the nominal SAR result.

The reported uncertainty of measurement is stated as the standard uncertainty of measurement multiplied by the coverage factor $k=2$, which for a normal distribution corresponds to a coverage probability of approximately 95%.

Unless otherwise stated the results shown in this test report refer only to the sample(s) tested and such sample(s) are retained for 90 days only.

除非另有說明，此報告結果僅對測試之樣品負責，同時此樣品僅保留90天。本報告未經本公司書面許可，不可部份複製。

This document is issued by the Company subject to its General Conditions of Service printed overleaf, available on request or accessible at www.sgs.com/terms_and_conditions.htm and, for electronic format documents, subject to Terms and Conditions for Electronic Documents at www.sgs.com/terms_e-document.htm. Attention is drawn to the limitation of liability, indemnification and jurisdiction issues defined therein. Any holder of this document is advised that information contained hereon reflects the Company's findings at the time of its intervention only and within the limits of Client's instructions, if any. The Company's sole responsibility is to its Client and this document does not exonerate parties to a transaction from exercising all their rights and obligations under the transaction documents. This document cannot be reproduced except in full, without prior written approval of the Company. Any unauthorized alteration, forgery or falsification of the content or appearance of this document is unlawful and offenders may be prosecuted to the fullest extent of the law.

Measurement Conditions

DASY system configuration, as far as not given on page 1.

| | | |
|------------------------------|------------------------|-------------|
| DASY Version | DASY5 | V52.8.8 |
| Extrapolation | Advanced Extrapolation | |
| Phantom | Modular Flat Phantom | |
| Distance Dipole Center - TSL | 15 mm | with Spacer |
| Zoom Scan Resolution | dx, dy, dz = 5 mm | |
| Frequency | 835 MHz ± 1 MHz | |

Head TSL parameters

The following parameters and calculations were applied.

| | Temperature | Permittivity | Conductivity |
|---|-----------------|--------------|------------------|
| Nominal Head TSL parameters | 22.0 °C | 41.5 | 0.90 mho/m |
| Measured Head TSL parameters | (22.0 ± 0.2) °C | 42.0 ± 6 % | 0.94 mho/m ± 6 % |
| Head TSL temperature change during test | < 0.5 °C | --- | --- |

SAR result with Head TSL

| SAR averaged over 1 cm ³ (1 g) of Head TSL | Condition | |
|---|--------------------|--------------------------|
| SAR measured | 250 mW input power | 2.38 W/kg |
| SAR for nominal Head TSL parameters | normalized to 1W | 9.24 W/kg ± 17.0 % (k=2) |

| SAR averaged over 10 cm ³ (10 g) of Head TSL | condition | |
|---|--------------------|--------------------------|
| SAR measured | 250 mW input power | 1.55 W/kg |
| SAR for nominal Head TSL parameters | normalized to 1W | 6.05 W/kg ± 16.5 % (k=2) |

Body TSL parameters

The following parameters and calculations were applied.

| | Temperature | Permittivity | Conductivity |
|---|-----------------|--------------|------------------|
| Nominal Body TSL parameters | 22.0 °C | 55.2 | 0.97 mho/m |
| Measured Body TSL parameters | (22.0 ± 0.2) °C | 55.2 ± 6 % | 1.01 mho/m ± 6 % |
| Body TSL temperature change during test | < 0.5 °C | --- | --- |

SAR result with Body TSL

| SAR averaged over 1 cm ³ (1 g) of Body TSL | Condition | |
|---|--------------------|--------------------------|
| SAR measured | 250 mW input power | 2.41 W/kg |
| SAR for nominal Body TSL parameters | normalized to 1W | 9.35 W/kg ± 17.0 % (k=2) |

| SAR averaged over 10 cm ³ (10 g) of Body TSL | condition | |
|---|--------------------|--------------------------|
| SAR measured | 250 mW input power | 1.59 W/kg |
| SAR for nominal Body TSL parameters | normalized to 1W | 6.21 W/kg ± 16.5 % (k=2) |

Unless otherwise stated the results shown in this test report refer only to the sample(s) tested and such sample(s) are retained for 90 days only.

除非另有說明，此報告結果僅對測試之樣品負責，同時此樣品僅保留90天。本報告未經本公司書面許可，不可部份複製。

This document is issued by the Company subject to its General Conditions of Service printed overleaf, available on request or accessible at www.sgs.com/terms_and_conditions.htm and, for electronic format documents, subject to Terms and Conditions for Electronic Documents at www.sgs.com/terms_e-document.htm. Attention is drawn to the limitation of liability, indemnification and jurisdiction issues defined therein. Any holder of this document is advised that information contained hereon reflects the Company's findings at the time of its intervention only and within the limits of Client's instructions, if any. The Company's sole responsibility is to its Client and this document does not exonerate parties to a transaction from exercising all their rights and obligations under the transaction documents. This document cannot be reproduced except in full, without prior written approval of the Company. Any unauthorized alteration, forgery or falsification of the content or appearance of this document is unlawful and offenders may be prosecuted to the fullest extent of the law.

Appendix (Additional assessments outside the scope of SCS108)

Antenna Parameters with Head TSL

| | |
|--------------------------------------|-------------------------------|
| Impedance, transformed to feed point | 51.7 Ω -3.6 j Ω |
| Return Loss | -28.2 dB |

Antenna Parameters with Body TSL

| | |
|--------------------------------------|-------------------------------|
| Impedance, transformed to feed point | 47.1 Ω -5.8 j Ω |
| Return Loss | -29.7 dB |

General Antenna Parameters and Design

| | |
|----------------------------------|----------|
| Electrical Delay (one direction) | 1.021 ns |
|----------------------------------|----------|

After long term use with 100W radiated power, only a slight warming of the dipole near the feedpoint can be measured.

The dipole is made of standard samigin coaxial cable. The center conductor of the feeding line is directly connected to the second arm of the dipole. The antenna is therefore short-circuited for DC-signals. On some of the dipoles, small end caps are added to the dipole arms in order to improve matching when loaded according to the position as explained in the "Measurement Conditions" paragraph. The SAR data are not affected by this change. The overall dipole length is still according to the Standard.

No excessive force must be applied to the dipole arms, because they might bend or the soldered connections near the feedpoint may be damaged.

Additional EUT Data

| | |
|-----------------|-------------------|
| Manufactured by | SPEAG |
| Manufactured on | November 27, 2006 |

Unless otherwise stated the results shown in this test report refer only to the sample(s) tested and such sample(s) are retained for 90 days only.

除非另有說明，此報告結果僅對測試之樣品負責，同時此樣品僅保留90天。本報告未經本公司書面許可，不可部份複製。

This document is issued by the Company subject to its General Conditions of Service printed overleaf, available on request or accessible at www.sgs.com/terms_and_conditions.htm and, for electronic format documents, subject to Terms and Conditions for Electronic Documents at www.sgs.com/terms_e-document.htm. Attention is drawn to the limitation of liability, indemnification and jurisdiction issues defined therein. Any holder of this document is advised that information contained hereon reflects the Company's findings at the time of its intervention only and within the limits of Client's instructions, if any. The Company's sole responsibility is to its Client and this document does not exonerate parties to a transaction from exercising all their rights and obligations under the transaction documents. This document cannot be reproduced except in full, without prior written approval of the Company. Any unauthorized alteration, forgery or falsification of the content or appearance of this document is unlawful and offenders may be prosecuted to the fullest extent of the law.

DASY5 Validation Report for Head TSL

Date: 28.08.2014

Test Laboratory: SPEAG, Zürich, Switzerland

DUT: Dipole 835 MHz; Type: D835V2; Serial: D835V2 - SN: 4d063

Communication System: UID 0 - CW; Frequency: 835 MHz
Medium parameters used: $f = 835 \text{ MHz}$; $\sigma = 0.94 \text{ S/m}$; $\epsilon_r = 42$; $\rho = 1000 \text{ kg/m}^3$
Phantom section: Flat Section
Measurement Standard: DASY5 (IEEE/IEC/ANSI C63.19-2011)

DASY52 Configuration:

- Probe: ES3DV3 - SN3205; ConvF(6.22, 6.22, 6.22); Calibrated: 30.12.2013;
- Sensor-Surface: 3mm (Mechanical Surface Detection)
- Electronics: DAE4 Sn601; Calibrated: 18.08.2014
- Phantom: Flat Phantom 4.9L; Type: QD000P49AA; Serial: 1001
- DASY52 52.8.8(1222); SEMCAD X 14.6.10(7331)

Dipole Calibration for Head Tissue/Pin=250 mW, d=15mm/Zoom Scan (7x7x7)/Cube 0:

Measurement grid: $dx=5\text{mm}$, $dy=5\text{mm}$, $dz=5\text{mm}$
Reference Value = 56.23 V/m; Power Drift = -0.02 dB
Peak SAR (extrapolated) = 3.53 W/kg
SAR(1 g) = 2.38 W/kg; SAR(10 g) = 1.55 W/kg
Maximum value of SAR (measured) = 2.78 W/kg

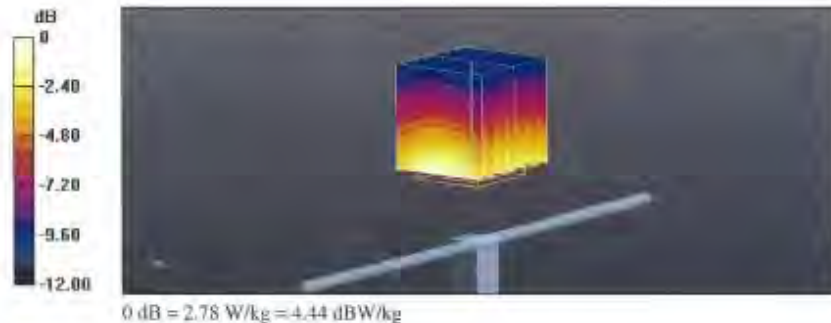

Unless otherwise stated the results shown in this test report refer only to the sample(s) tested and such sample(s) are retained for 90 days only.

除非另有說明，此報告結果僅對測試之樣品負責，同時此樣品僅保留90天。本報告未經本公司書面許可，不可部份複製。

This document is issued by the Company subject to its General Conditions of Service printed overleaf, available on request or accessible at www.sgs.com/terms_and_conditions.htm and, for electronic format documents, subject to Terms and Conditions for Electronic Documents at www.sgs.com/terms_e-document.htm. Attention is drawn to the limitation of liability, indemnification and jurisdiction issues defined therein. Any holder of this document is advised that information contained hereon reflects the Company's findings at the time of its intervention only and within the limits of Client's instructions, if any. The Company's sole responsibility is to its Client and this document does not exonerate parties to a transaction from exercising all their rights and obligations under the transaction documents. This document cannot be reproduced except in full, without prior written approval of the Company. Any unauthorized alteration, forgery or falsification of the content or appearance of this document is unlawful and offenders may be prosecuted to the fullest extent of the law.

Impedance Measurement Plot for Head TSL

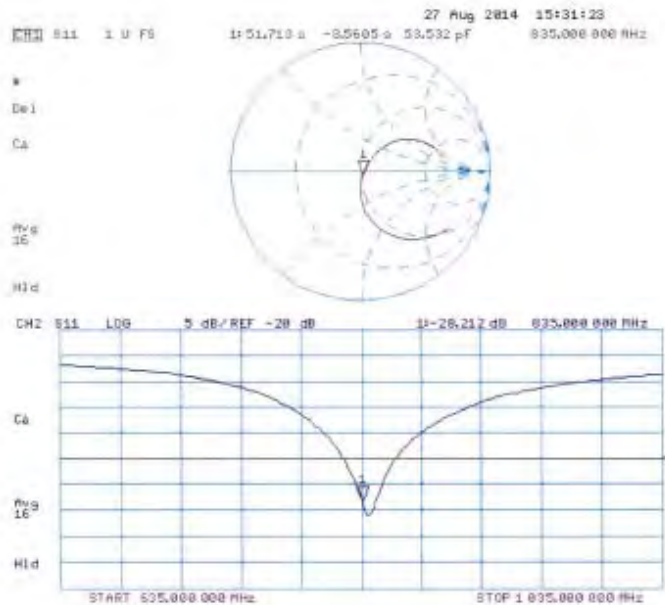

Unless otherwise stated the results shown in this test report refer only to the sample(s) tested and such sample(s) are retained for 90 days only.

除非另有說明，此報告結果僅對測試之樣品負責，同時此樣品僅保留90天。本報告未經本公司書面許可，不可部份複製。

This document is issued by the Company subject to its General Conditions of Service printed overleaf, available on request or accessible at www.sgs.com/terms_and_conditions.htm and, for electronic format documents, subject to Terms and Conditions for Electronic Documents at www.sgs.com/terms_e-document.htm. Attention is drawn to the limitation of liability, indemnification and jurisdiction issues defined therein. Any holder of this document is advised that information contained hereon reflects the Company's findings at the time of its intervention only and within the limits of Client's instructions, if any. The Company's sole responsibility is to its Client and this document does not exonerate parties to a transaction from exercising all their rights and obligations under the transaction documents. This document cannot be reproduced except in full, without prior written approval of the Company. Any unauthorized alteration, forgery or falsification of the content or appearance of this document is unlawful and offenders may be prosecuted to the fullest extent of the law.

DASY5 Validation Report for Body TSL

Date: 27.08.2014

Test Laboratory: SPEAG, Zurich, Switzerland

DUT: Dipole 835 MHz; Type: D835V2; Serial: D835V2 - SN: 4d063

Communication System: UID 0 - CW; Frequency: 835 MHz
Medium parameters used: $f = 835 \text{ MHz}$; $\sigma = 1.01 \text{ S/m}$; $\epsilon_r = 55.2$; $\rho = 1000 \text{ kg/m}^3$
Phantom section: Flat Section
Measurement Standard: DASY5 (IEEE/IEC/ANSI C63.19-2011)

DASY52 Configuration:

- Probe: ES3DV3 - SN3205; ConvF(6.09, 6.09, 6.09); Calibrated: 30.12.2013;
- Sensor-Surface; 3mm (Mechanical Surface Detection)
- Electronics: DAE4 Sn601; Calibrated: 18.08.2014
- Phantom: Flat Phantom 4.9L; Type: QD000P49AA; Serial: 1001
- DASY52 52.8.8(1222); SEMCAD X 14.6.10(7331)

Dipole Calibration for Body Tissue/Pin=250 mW, d=15mm/Zoom Scan (7x7x7)/Cube 0:

Measurement grid: $dx=5\text{mm}$, $dy=5\text{mm}$, $dz=5\text{mm}$
Reference Value = 54.65 V/m; Power Drift = -0.03 dB
Peak SAR (extrapolated) = 3.53 W/kg
SAR(1 g) = 2.41 W/kg; SAR(10 g) = 1.59 W/kg
Maximum value of SAR (measured) = 2.80 W/kg

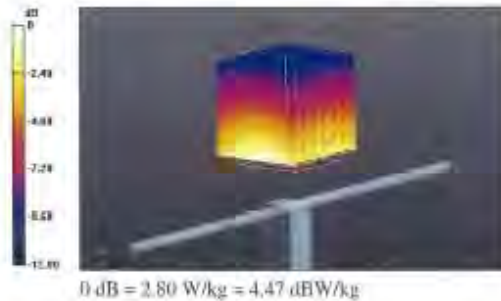

Unless otherwise stated the results shown in this test report refer only to the sample(s) tested and such sample(s) are retained for 90 days only.

除非另有說明，此報告結果僅對測試之樣品負責，同時此樣品僅保留90天。本報告未經本公司書面許可，不可部份複製。

This document is issued by the Company subject to its General Conditions of Service printed overleaf, available on request or accessible at www.sgs.com/terms_and_conditions.htm and, for electronic format documents, subject to Terms and Conditions for Electronic Documents at www.sgs.com/terms_e-document.htm. Attention is drawn to the limitation of liability, indemnification and jurisdiction issues defined therein. Any holder of this document is advised that information contained hereon reflects the Company's findings at the time of its intervention only and within the limits of Client's instructions, if any. The Company's sole responsibility is to its Client and this document does not exonerate parties to a transaction from exercising all their rights and obligations under the transaction documents. This document cannot be reproduced except in full, without prior written approval of the Company. Any unauthorized alteration, forgery or falsification of the content or appearance of this document is unlawful and offenders may be prosecuted to the fullest extent of the law.

Impedance Measurement Plot for Body TSL

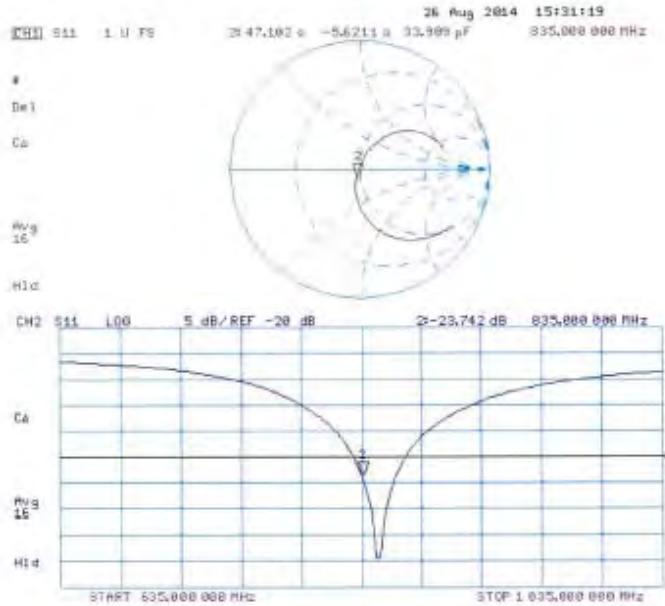

Unless otherwise stated the results shown in this test report refer only to the sample(s) tested and such sample(s) are retained for 90 days only.

除非另有說明，此報告結果僅對測試之樣品負責，同時此樣品僅保留90天。本報告未經本公司書面許可，不可部份複製。

This document is issued by the Company subject to its General Conditions of Service printed overleaf, available on request or accessible at www.sgs.com/terms_and_conditions.htm and, for electronic format documents, subject to Terms and Conditions for Electronic Documents at www.sgs.com/terms_e-document.htm. Attention is drawn to the limitation of liability, indemnification and jurisdiction issues defined therein. Any holder of this document is advised that information contained hereon reflects the Company's findings at the time of its intervention only and within the limits of Client's instructions, if any. The Company's sole responsibility is to its Client and this document does not exonerate parties to a transaction from exercising all their rights and obligations under the transaction documents. This document cannot be reproduced except in full, without prior written approval of the Company. Any unauthorized alteration, forgery or falsification of the content or appearance of this document is unlawful and offenders may be prosecuted to the fullest extent of the law.

**Calibration Laboratory of
Schmid & Partner
Engineering AG**
Zeughausstrasse 43, 8004 Zurich, Switzerland



S Schweizerischer Kalibrierdienst
C Service suisse d'étalonnage
S Servizio svizzero di taratura
S Swiss Calibration Service

Accredited by the Swiss Accreditation Service (SAS)
The Swiss Accreditation Service is one of the signatories to the EA
Multilateral Agreement for the recognition of calibration certificates

Accreditation No.: **SCS 108**

Client **SGS-TW (Auden)**

Certificate No: **D1750V2-1008_Aug14**

CALIBRATION CERTIFICATE

Object: **D1750V2 - SN: 1008**

Calibration procedure(s): **QA CAL-05.v9
Calibration procedure for dipole validation kits above 700 MHz**

Calibration date: **August 28, 2014**

This calibration certificate documents the traceability to national standards, which realize the physical units of measurements (SI).
The measurements and the uncertainties with confidence probability are given on the following pages and are part of the certificate.

All calibrations have been conducted in the closed laboratory facility; environment: temperature (22 ± 0.5°C) and humidity < 70%.

Calibration Equipment used (M&E critical for calibration)

| Primary Standards | ID # | Cal Date (Certificate No.) | Scheduled Calibration |
|-----------------------------|--------------------|-----------------------------------|------------------------|
| Power meter EPM-442A | 0507480704 | 09-Oct-13 (No. 217-01827) | Oct-14 |
| Power sensor HP 8481A | US37292783 | 09-Oct-13 (No. 217-01827) | Oct-14 |
| Power sensor HP 8481A | MY41092317 | 09-Oct-13 (No. 217-01828) | Oct-14 |
| Reference 20 dB Attenuator | SN: 5058 (20K) | 03-Apr-14 (No. 217-01518) | Apr-15 |
| Type-N mismatch combination | SN: 5047.2 / 06327 | 03-Apr-14 (No. 217-01921) | Apr-15 |
| Reference Probe ES30V3 | SN: 3205 | 30-Dec-13 (No. ES3-3206_Disc13) | Dec-14 |
| DAE4 | SN: 601 | 18-Aug-14 (No. DAE4-601_Aug14) | Aug-15 |
| Secondary Standards | ID # | Check Date (in house) | Scheduled Check |
| RF generator RAS SMT-06 | 100005 | 04-Aug-09 (in house check Oct-13) | in house check: Oct-18 |
| Network Analyzer HP 8753E | US3739U585 84209 | 18-Oct-01 (in house check Oct-13) | in house check: Oct-14 |

Calibrated by: **Michael Weber** (Name) / **Laboratory Technician** (Function) / *[Signature]* (Signature)

Approved by: **Karla Foubler** (Name) / **Technical Manager** (Function) / *[Signature]* (Signature)

Issued: August 28, 2014

This calibration certificate shall not be reproduced except in full without written approval of the laboratory.

Unless otherwise stated the results shown in this test report refer only to the sample(s) tested and such sample(s) are retained for 90 days only.

除非另有說明，此報告結果僅對測試之樣品負責，同時此樣品僅保留90天。本報告未經本公司書面許可，不可部份複製。

This document is issued by the Company subject to its General Conditions of Service printed overleaf, available on request or accessible at www.sgs.com/terms_and_conditions.htm and, for electronic format documents, subject to Terms and Conditions for Electronic Documents at www.sgs.com/terms_e-document.htm. Attention is drawn to the limitation of liability, indemnification and jurisdiction issues defined therein. Any holder of this document is advised that information contained hereon reflects the Company's findings at the time of its intervention only and within the limits of Client's instructions, if any. The Company's sole responsibility is to its Client and this document does not exonerate parties to a transaction from exercising all their rights and obligations under the transaction documents. This document cannot be reproduced except in full, without prior written approval of the Company. Any unauthorized alteration, forgery or falsification of the content or appearance of this document is unlawful and offenders may be prosecuted to the fullest extent of the law.

Calibration Laboratory of
Schmid & Partner
Engineering AG
Zuglharstrasse 43, 8004 Zurich, Switzerland



S Schweizerischer Kalibrierdienst
C Service suisse d'étalonnage
S Servizio svizzero di taratura
S Swiss Calibration Service

Approved by the Swiss Accreditation Service (SAS)
The Swiss Accreditation Service is one of the signatories to the EA
Multilateral Agreement for the recognition of calibration certificates

Accreditation No.: **SCS 108**

Glossary:

TSL tissue simulating liquid
ConvF sensitivity in TSL / NORM x,y,z
N/A not applicable or not measured

Calibration is Performed According to the Following Standards:

- IEEE Std 1528-2013, "IEEE Recommended Practice for Determining the Peak Spatial-Averaged Specific Absorption Rate (SAR) in the Human Head from Wireless Communications Devices; Measurement Techniques", June 2013
- IEC 62209-1, "Procedure to measure the Specific Absorption Rate (SAR) for hand-held devices used in close proximity to the ear (frequency range of 300 MHz to 3 GHz)", February 2005
- KDB 865884, "SAR Measurement Requirements for 100 MHz to 6 GHz"

Additional Documentation:

- DASY4/5 System Handbook

Methods Applied and Interpretation of Parameters:

- Measurement Conditions:** Further details are available from the Validation Report at the end of the certificate. All figures stated in the certificate are valid at the frequency indicated.
- Antenna Parameters with TSL:** The dipole is mounted with the spacer to position its feed point exactly below the center marking of the flat phantom section, with the arms oriented parallel to the body axis.
- Feed Point Impedance and Return Loss:** These parameters are measured with the dipole positioned under the liquid filled phantom. The impedance stated is transformed from the measurement at the SMA connector to the feed point. The Return Loss ensures low reflected power. No uncertainty required.
- Electrical Delay:** One-way delay between the SMA connector and the antenna feed point. No uncertainty required.
- SAR measured:** SAR measured at the stated antenna input power.
- SAR normalized:** SAR as measured, normalized to an input power of 1 W at the antenna connector.
- SAR for nominal TSL parameters:** The measured TSL parameters are used to calculate the nominal SAR result.

The reported uncertainty of measurement is stated as the standard uncertainty of measurement multiplied by the coverage factor $k=2$, which for a normal distribution corresponds to a coverage probability of approximately 95%.

Unless otherwise stated the results shown in this test report refer only to the sample(s) tested and such sample(s) are retained for 90 days only.

除非另有說明，此報告結果僅對測試之樣品負責，同時此樣品僅保留90天。本報告未經本公司書面許可，不可部份複製。

This document is issued by the Company subject to its General Conditions of Service printed overleaf, available on request or accessible at www.sgs.com/terms_and_conditions.htm and, for electronic format documents, subject to Terms and Conditions for Electronic Documents at www.sgs.com/terms_e-document.htm. Attention is drawn to the limitation of liability, indemnification and jurisdiction issues defined therein. Any holder of this document is advised that information contained hereon reflects the Company's findings at the time of its intervention only and within the limits of Client's instructions, if any. The Company's sole responsibility is to its Client and this document does not exonerate parties to a transaction from exercising all their rights and obligations under the transaction documents. This document cannot be reproduced except in full, without prior written approval of the Company. Any unauthorized alteration, forgery or falsification of the content or appearance of this document is unlawful and offenders may be prosecuted to the fullest extent of the law.

Measurement Conditions

DASY system configuration, as far as not given on page 1.

| | | |
|------------------------------|------------------------|-------------|
| DASY Version | DASY5 | V52.6.6 |
| Extrapolation | Advanced Extrapolation | |
| Phantom | Modular Flat Phantom | |
| Distance Dipole Center - TSL | 10 mm | with Spacer |
| Zoom Scan Resolution | dx, dy, dz = 5 mm | |
| Frequency | 1750 MHz ± 1 MHz | |

Head TSL parameters

The following parameters and calculations were applied:

| | Temperature | Permittivity | Conductivity |
|---|-----------------|--------------|------------------|
| Nominal Head TSL parameters | 22.0 °C | 40.1 | 1.37 mho/m |
| Measured Head TSL parameters | (22.0 ± 0.2) °C | 39.2 ± 6 % | 1.37 mho/m ± 6 % |
| Head TSL temperature change during test | < 0.5 °C | — | — |

SAR result with Head TSL

| SAR averaged over 1 cm ³ (1 g) of Head TSL | Condition | |
|---|--------------------|--------------------------|
| SAR measured | 250 mW input power | 9.26 W/kg |
| SAR for nominal Head TSL parameters | normalized to 1W | 36.9 W/kg ± 17.0 % (k=2) |
| | | |
| SAR averaged over 10 cm ³ (10 g) of Head TSL | Condition | |
| SAR measured | 250 mW input power | 4.91 W/kg |
| SAR for nominal Head TSL parameters | normalized to 1W | 19.6 W/kg ± 16.5 % (k=2) |

Body TSL parameters

The following parameters and calculations were applied:

| | Temperature | Permittivity | Conductivity |
|---|-----------------|--------------|------------------|
| Nominal Body TSL parameters | 22.0 °C | 53.4 | 1.49 mho/m |
| Measured Body TSL parameters | (22.0 ± 0.2) °C | 52.0 ± 6 % | 1.49 mho/m ± 6 % |
| Body TSL temperature change during test | < 0.5 °C | — | — |

SAR result with Body TSL

| SAR averaged over 1 cm ³ (1 g) of Body TSL | Condition | |
|---|--------------------|--------------------------|
| SAR measured | 250 mW input power | 9.44 W/kg |
| SAR for nominal Body TSL parameters | normalized to 1W | 37.5 W/kg ± 17.0 % (k=2) |
| | | |
| SAR averaged over 10 cm ³ (10 g) of Body TSL | Condition | |
| SAR measured | 250 mW input power | 5.07 W/kg |
| SAR for nominal Body TSL parameters | normalized to 1W | 20.2 W/kg ± 16.5 % (k=2) |

Unless otherwise stated the results shown in this test report refer only to the sample(s) tested and such sample(s) are retained for 90 days only.

除非另有說明，此報告結果僅對測試之樣品負責，同時此樣品僅保留90天。本報告未經本公司書面許可，不可部份複製。

This document is issued by the Company subject to its General Conditions of Service printed overleaf, available on request or accessible at www.sgs.com/terms_and_conditions.htm and, for electronic format documents, subject to Terms and Conditions for Electronic Documents at www.sgs.com/terms_e-document.htm. Attention is drawn to the limitation of liability, indemnification and jurisdiction issues defined therein. Any holder of this document is advised that information contained hereon reflects the Company's findings at the time of its intervention only and within the limits of Client's instructions, if any. The Company's sole responsibility is to its Client and this document does not exonerate parties to a transaction from exercising all their rights and obligations under the transaction documents. This document cannot be reproduced except in full, without prior written approval of the Company. Any unauthorized alteration, forgery or falsification of the content or appearance of this document is unlawful and offenders may be prosecuted to the fullest extent of the law.

Appendix (Additional assessments outside the scope of SCS108)

Antenna Parameters with Head TSL

| | |
|--------------------------------------|--------------------------------|
| Impedance, transformed to feed point | 50.4 Ω + 0.3 j Ω |
| Return Loss | -46.4 dB |

Antenna Parameters with Body TSL

| | |
|--------------------------------------|--------------------------------|
| Impedance, transformed to feed point | 46.4 Ω + 0.3 j Ω |
| Return Loss | -28.5 dB |

General Antenna Parameters and Design

| | |
|----------------------------------|----------|
| Electrical Delay (one direction) | 1.222 ns |
|----------------------------------|----------|

After long term use with 100W radiated power, only a slight warming of the dipole near the feedpoint can be measured.

The dipole is made of standard semirigid coaxial cable. The center conductor of the feeding line is directly connected to the second arm of the dipole. The antenna is therefore short-circuited for DC-signals. On some of the dipoles, small end caps are added to the dipole arms in order to improve matching when loaded according to the position as explained in the "Measurement Conditions" paragraph. The SAR data are not affected by this change. The overall dipole length is still according to the Standard. No excessive force must be applied to the dipole arms, because they might bend or the soldered connections near the feedpoint may be damaged.

Additional EUT Data

| | |
|-----------------|-------------------|
| Manufactured by | SPEAG |
| Manufactured on | February 11, 2009 |

Unless otherwise stated the results shown in this test report refer only to the sample(s) tested and such sample(s) are retained for 90 days only.

除非另有說明，此報告結果僅對測試之樣品負責，同時此樣品僅保留90天。本報告未經本公司書面許可，不可部份複製。

This document is issued by the Company subject to its General Conditions of Service printed overleaf, available on request or accessible at www.sgs.com/terms_and_conditions.htm and, for electronic format documents, subject to Terms and Conditions for Electronic Documents at www.sgs.com/terms_e-document.htm. Attention is drawn to the limitation of liability, indemnification and jurisdiction issues defined therein. Any holder of this document is advised that information contained hereon reflects the Company's findings at the time of its intervention only and within the limits of Client's instructions, if any. The Company's sole responsibility is to its Client and this document does not exonerate parties to a transaction from exercising all their rights and obligations under the transaction documents. This document cannot be reproduced except in full, without prior written approval of the Company. Any unauthorized alteration, forgery or falsification of the content or appearance of this document is unlawful and offenders may be prosecuted to the fullest extent of the law.

DASY5 Validation Report for Head TSL

Date: 28.08.2014

Test Laboratory: SPEAG, Zurich, Switzerland

DUT: Dipole 1750 MHz; Type: D1750V2; Serial: D1750V2 - SN: 1008

Communication System: UID 0 - CW; Frequency: 1750 MHz
Medium parameters used: $f = 1750$ MHz; $\sigma = 1.37$ S/m; $\epsilon_r = 39.2$; $\rho = 1000$ kg/m³
Phantom section: Flat Section
Measurement Standard: DASY5 (IEEE/IEC/ANSI C63.19-2011)

DASY52 Configuration:

- Probe: ES3DV3 - SN3205; ConvF(5.23, 5.23, 5.23); Calibrated: 30.12.2013;
- Sensor-Surface: 3mm (Mechanical Surface Detection)
- Electronics: DAE4 Sn601; Calibrated: 18.08.2014
- Phantom: Flat Phantom 5.0 (front); Type: QD000P50AA; Serial: 1001
- DASY52 52.8.8(1222); SEMCAD X (4.6.10(7331))

Dipole Calibration for Head Tissue/Pin=250 mW, d=10mm/Zoom Scan (7x7x7)/Cube 0:

Measurement grid: dx=5mm, dy=5mm, dz=5mm
Reference Value = 95.53 V/m; Power Drift = -0.01 dB
Peak SAR (extrapolated) = 16.7 W/kg
SAR(1 g) = 9.26 W/kg; SAR(10 g) = 4.91 W/kg
Maximum value of SAR (measured) = 11.6 W/kg

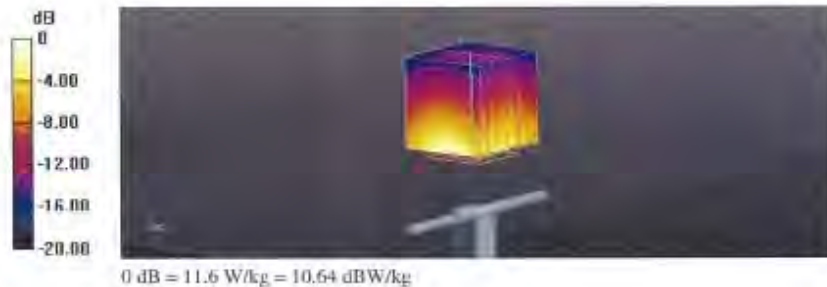

Unless otherwise stated the results shown in this test report refer only to the sample(s) tested and such sample(s) are retained for 90 days only.

除非另有說明，此報告結果僅對測試之樣品負責，同時此樣品僅保留90天。本報告未經本公司書面許可，不可部份複製。

This document is issued by the Company subject to its General Conditions of Service printed overleaf, available on request or accessible at www.sgs.com/terms_and_conditions.htm and, for electronic format documents, subject to Terms and Conditions for Electronic Documents at www.sgs.com/terms_e-document.htm. Attention is drawn to the limitation of liability, indemnification and jurisdiction issues defined therein. Any holder of this document is advised that information contained hereon reflects the Company's findings at the time of its intervention only and within the limits of Client's instructions, if any. The Company's sole responsibility is to its Client and this document does not exonerate parties to a transaction from exercising all their rights and obligations under the transaction documents. This document cannot be reproduced except in full, without prior written approval of the Company. Any unauthorized alteration, forgery or falsification of the content or appearance of this document is unlawful and offenders may be prosecuted to the fullest extent of the law.

Impedance Measurement Plot for Head TSL

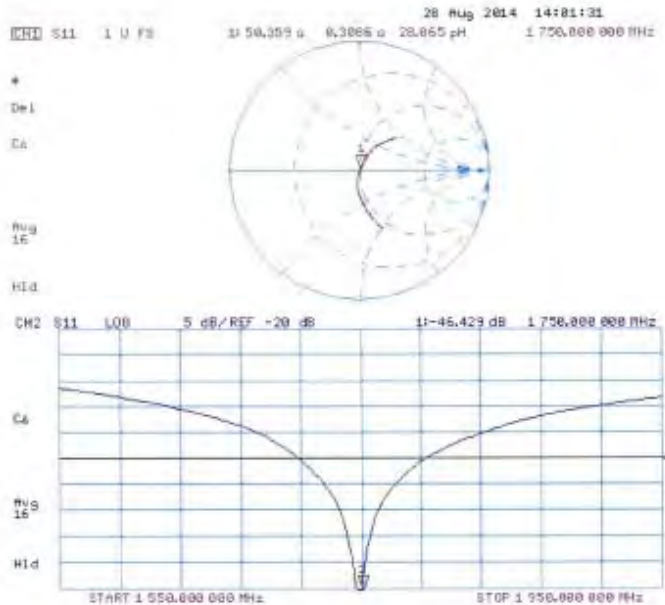

Unless otherwise stated the results shown in this test report refer only to the sample(s) tested and such sample(s) are retained for 90 days only.

除非另有說明，此報告結果僅對測試之樣品負責，同時此樣品僅保留90天。本報告未經本公司書面許可，不可部份複製。

This document is issued by the Company subject to its General Conditions of Service printed overleaf, available on request or accessible at www.sgs.com/terms_and_conditions.htm and, for electronic format documents, subject to Terms and Conditions for Electronic Documents at www.sgs.com/terms_e-document.htm. Attention is drawn to the limitation of liability, indemnification and jurisdiction issues defined therein. Any holder of this document is advised that information contained hereon reflects the Company's findings at the time of its intervention only and within the limits of Client's instructions, if any. The Company's sole responsibility is to its Client and this document does not exonerate parties to a transaction from exercising all their rights and obligations under the transaction documents. This document cannot be reproduced except in full, without prior written approval of the Company. Any unauthorized alteration, forgery or falsification of the content or appearance of this document is unlawful and offenders may be prosecuted to the fullest extent of the law.

DASY5 Validation Report for Body TSL

Date: 28.08.2014

Test Laboratory: SPEAG, Zurich, Switzerland

DUT: Dipole 1750 MHz; Type: D1750V2; Serial: D1750V2 - SN: 1008

Communication System: UID 0 - CW; Frequency: 1750 MHz
Medium parameters used: $f = 1750$ MHz; $\sigma = 1.49$ S/m; $\epsilon_r = 52$; $\rho = 1000$ kg/m³
Phantom section: Flat Section
Measurement Standard: DASY5 (IEEE/IEC/ANSI C63.19-2011)

DASY52 Configuration:

- Probe: ES3DV3 - SN3205; ConvF(4.89, 4.89, 4.89); Calibrated: 30.12.2013;
- Sensor-Surface: 3mm (Mechanical Surface Detection)
- Electronics: DAE4 Sn601; Calibrated: 18.08.2014
- Phantom: Flat Phantom 5.0 (back); Type: QD000P50AA; Serial: 1002
- DASY52 52.8.8(1222); SEMCAD X 14.6.10(7331)

Dipole Calibration for Body Tissue/Pin=250 mW, d=10mm/Zoom Scan (7x7x7)/Cube 0:

Measurement grid: dx=5mm, dy=5mm, dz=5mm
Reference Value = 93.44 V/m; Power Drift = 0.01 dB
Peak SAR (extrapolated) = 16.3 W/kg
SAR(1 g) = 9.44 W/kg; SAR(10 g) = 5.07 W/kg
Maximum value of SAR (measured) = 11.9 W/kg

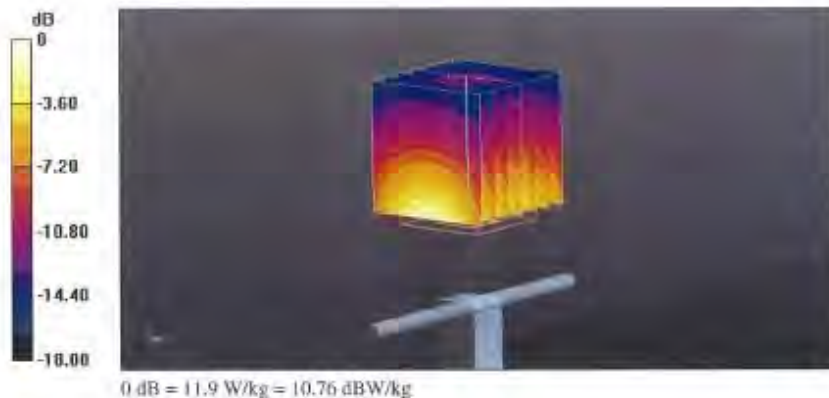

Unless otherwise stated the results shown in this test report refer only to the sample(s) tested and such sample(s) are retained for 90 days only.

除非另有說明，此報告結果僅對測試之樣品負責，同時此樣品僅保留90天。本報告未經本公司書面許可，不可部份複製。

This document is issued by the Company subject to its General Conditions of Service printed overleaf, available on request or accessible at www.sgs.com/terms_and_conditions.htm and, for electronic format documents, subject to Terms and Conditions for Electronic Documents at www.sgs.com/terms_e-document.htm. Attention is drawn to the limitation of liability, indemnification and jurisdiction issues defined therein. Any holder of this document is advised that information contained hereon reflects the Company's findings at the time of its intervention only and within the limits of Client's instructions, if any. The Company's sole responsibility is to its Client and this document does not exonerate parties to a transaction from exercising all their rights and obligations under the transaction documents. This document cannot be reproduced except in full, without prior written approval of the Company. Any unauthorized alteration, forgery or falsification of the content or appearance of this document is unlawful and offenders may be prosecuted to the fullest extent of the law.

Impedance Measurement Plot for Body TSL

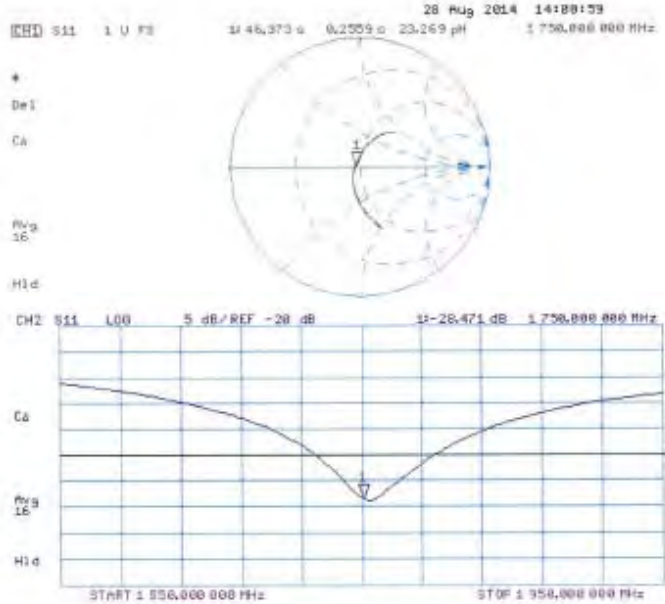

Unless otherwise stated the results shown in this test report refer only to the sample(s) tested and such sample(s) are retained for 90 days only.

除非另有說明，此報告結果僅對測試之樣品負責，同時此樣品僅保留90天。本報告未經本公司書面許可，不可部份複製。

This document is issued by the Company subject to its General Conditions of Service printed overleaf, available on request or accessible at www.sgs.com/terms_and_conditions.htm and, for electronic format documents, subject to Terms and Conditions for Electronic Documents at www.sgs.com/terms_e-document.htm. Attention is drawn to the limitation of liability, indemnification and jurisdiction issues defined therein. Any holder of this document is advised that information contained hereon reflects the Company's findings at the time of its intervention only and within the limits of Client's instructions, if any. The Company's sole responsibility is to its Client and this document does not exonerate parties to a transaction from exercising all their rights and obligations under the transaction documents. This document cannot be reproduced except in full, without prior written approval of the Company. Any unauthorized alteration, forgery or falsification of the content or appearance of this document is unlawful and offenders may be prosecuted to the fullest extent of the law.

**Calibration Laboratory of
Schmid & Partner
Engineering AG**
Zeughausstrasse 43, 8004 Zurich, Switzerland



S Schweizerischer Kalibrierdienst
C Service suisse d'étalonnage
S Servizio svizzero di taratura
S Swiss Calibration Service

Accredited by the Swiss Accreditation Service (SAS)
The Swiss Accreditation Service is one of the signatories to the EA
Multilateral Agreement for the recognition of calibration certificates

Accreditation No.: **SCS 0108**

Client **SGS-TW (Auden)**

Certificate No: **D1900V2-5d027_Apr15**

CALIBRATION CERTIFICATE

Object **D1900V2 - SN:5d027**

Calibration procedure(s) **QA CAL-05.v9
Calibration procedure for dipole validation kits above 700 MHz**

Calibration date: **April 29, 2015**

This calibration certificate documents the traceability to national standards, which realize the physical units of measurements (SI).
The measurements and the uncertainties with confidence probability are given on the following pages and are part of the certificate.

All calibrations have been conducted in the closed laboratory facility; environment temperature (22 ± 3)°C and humidity < 70%.

Calibration Equipment used (M&TE critical for calibration)

| Primary Standards | ID # | Cal Date (Certificate No.) | Scheduled Calibration |
|-----------------------------|--------------------|-----------------------------------|------------------------|
| Power meter EPM-442A | GB37480704 | 07-Oct-14 (No. 217-02020) | Oct-15 |
| Power sensor HP 8481A | US37292783 | 07-Oct-14 (No. 217-02020) | Oct-15 |
| Power sensor HP 8481A | MY41092317 | 07-Oct-14 (No. 217-02021) | Oct-15 |
| Reference 20 dB Attenuator | SN: 5058 (20k) | 01-Apr-15 (No. 217-02131) | Mar-16 |
| Type-N mismatch combination | SN: 5047.2 / 06327 | 01-Apr-15 (No. 217-02134) | Mar-16 |
| Reference Probe ES3DV3 | SN: 3205 | 30-Dec-14 (No. ES3-3205_Dec14) | Dec-15 |
| DAE4 | SN: 601 | 18-Aug-14 (No. DAE4-601_Aug14) | Aug-15 |
| Secondary Standards | ID # | Check Date (in house) | Scheduled Check |
| RF generator R&S SMT-06 | 100005 | 04-Aug-99 (in house check Oct-13) | In house check: Oct-16 |
| Network Analyzer HP 8753E | US37390585 S4206 | 18-Oct-01 (in house check Oct-14) | In house check: Oct-15 |

Calibrated by: **Name** Claudio Leubler **Function** Laboratory Technician **Signature**

Approved by: **Name** Katja Pokovic **Function** Technical Manager **Signature**

Issued: April 29, 2015

This calibration certificate shall not be reproduced except in full without written approval of the laboratory.

Unless otherwise stated the results shown in this test report refer only to the sample(s) tested and such sample(s) are retained for 90 days only.

除非另有說明，此報告結果僅對測試之樣品負責，同時此樣品僅保留90天。本報告未經本公司書面許可，不可部份複製。

This document is issued by the Company subject to its General Conditions of Service printed overleaf, available on request or accessible at www.sgs.com/terms_and_conditions.htm and, for electronic format documents, subject to Terms and Conditions for Electronic Documents at www.sgs.com/terms_e-document.htm. Attention is drawn to the limitation of liability, indemnification and jurisdiction issues defined therein. Any holder of this document is advised that information contained hereon reflects the Company's findings at the time of its intervention only and within the limits of Client's instructions, if any. The Company's sole responsibility is to its Client and this document does not exonerate parties to a transaction from exercising all their rights and obligations under the transaction documents. This document cannot be reproduced except in full, without prior written approval of the Company. Any unauthorized alteration, forgery or falsification of the content or appearance of this document is unlawful and offenders may be prosecuted to the fullest extent of the law.

**Calibration Laboratory of
Schmid & Partner
Engineering AG**
Zeughausstrasse 43, 8004 Zurich, Switzerland



S Schweizerischer Kalibrierdienst
C Service suisse d'étalonnage
S Servizio svizzero di taratura
S Swiss Calibration Service

Accredited by the Swiss Accreditation Service (SAS)
The Swiss Accreditation Service is one of the signatories to the EA
Multilateral Agreement for the recognition of calibration certificates

Accreditation No.: SCS 0108

Glossary:

TSL tissue simulating liquid
ConvF sensitivity in TSL / NORM x,y,z
N/A not applicable or not measured

Calibration is Performed According to the Following Standards:

- IEEE Std 1528-2013, "IEEE Recommended Practice for Determining the Peak Spatial-Averaged Specific Absorption Rate (SAR) in the Human Head from Wireless Communications Devices: Measurement Techniques", June 2013
- IEC 62209-1, "Procedure to measure the Specific Absorption Rate (SAR) for hand-held devices used in close proximity to the ear (frequency range of 300 MHz to 3 GHz)", February 2005
- KDB 865664, "SAR Measurement Requirements for 100 MHz to 6 GHz"

Additional Documentation:

- DASY4/5 System Handbook

Methods Applied and Interpretation of Parameters:

- Measurement Conditions:** Further details are available from the Validation Report at the end of the certificate. All figures stated in the certificate are valid at the frequency indicated.
- Antenna Parameters with TSL:** The dipole is mounted with the spacer to position its feed point exactly below the center marking of the flat phantom section, with the arms oriented parallel to the body axis.
- Feed Point Impedance and Return Loss:** These parameters are measured with the dipole positioned under the liquid filled phantom. The impedance stated is transformed from the measurement at the SMA connector to the feed point. The Return Loss ensures low reflected power. No uncertainty required.
- Electrical Delay:** One-way delay between the SMA connector and the antenna feed point. No uncertainty required.
- SAR measured:** SAR measured at the stated antenna input power.
- SAR normalized:** SAR as measured, normalized to an input power of 1 W at the antenna connector.
- SAR for nominal TSL parameters:** The measured TSL parameters are used to calculate the nominal SAR result.

The reported uncertainty of measurement is stated as the standard uncertainty of measurement multiplied by the coverage factor $k=2$, which for a normal distribution corresponds to a coverage probability of approximately 95%.

Measurement Conditions

DASY system configuration, as far as not given on page 1.

| | | |
|------------------------------|------------------------|-------------|
| DASY Version | DASY5 | V52.8.8 |
| Extrapolation | Advanced Extrapolation | |
| Phantom | Modular Flat Phantom | |
| Distance Dipole Center - TSL | 10 mm | with Spacer |
| Zoom Scan Resolution | dx, dy, dz = 5 mm | |
| Frequency | 1900 MHz \pm 1 MHz | |

Head TSL parameters

The following parameters and calculations were applied.

| | Temperature | Permittivity | Conductivity |
|---|---------------------|----------------|----------------------|
| Nominal Head TSL parameters | 22.0 °C | 40.0 | 1.40 mho/m |
| Measured Head TSL parameters | (22.0 \pm 0.2) °C | 38.6 \pm 6 % | 1.37 mho/m \pm 6 % |
| Head TSL temperature change during test | < 0.5 °C | ---- | ---- |

SAR result with Head TSL

| SAR averaged over 1 cm ³ (1 g) of Head TSL | Condition | |
|---|--------------------|------------------------------|
| SAR measured | 250 mW input power | 10.1 W/kg |
| SAR for nominal Head TSL parameters | normalized to 1W | 40.6 W/kg \pm 17.0 % (k=2) |

| SAR averaged over 10 cm ³ (10 g) of Head TSL | condition | |
|---|--------------------|------------------------------|
| SAR measured | 250 mW input power | 5.30 W/kg |
| SAR for nominal Head TSL parameters | normalized to 1W | 21.3 W/kg \pm 16.5 % (k=2) |

Body TSL parameters

The following parameters and calculations were applied.

| | Temperature | Permittivity | Conductivity |
|---|---------------------|----------------|----------------------|
| Nominal Body TSL parameters | 22.0 °C | 53.3 | 1.52 mho/m |
| Measured Body TSL parameters | (22.0 \pm 0.2) °C | 52.8 \pm 6 % | 1.50 mho/m \pm 6 % |
| Body TSL temperature change during test | < 0.5 °C | ---- | ---- |

SAR result with Body TSL

| SAR averaged over 1 cm ³ (1 g) of Body TSL | Condition | |
|---|--------------------|------------------------------|
| SAR measured | 250 mW input power | 9.78 W/kg |
| SAR for nominal Body TSL parameters | normalized to 1W | 39.3 W/kg \pm 17.0 % (k=2) |

| SAR averaged over 10 cm ³ (10 g) of Body TSL | condition | |
|---|--------------------|------------------------------|
| SAR measured | 250 mW input power | 5.20 W/kg |
| SAR for nominal Body TSL parameters | normalized to 1W | 20.9 W/kg \pm 16.5 % (k=2) |

Unless otherwise stated the results shown in this test report refer only to the sample(s) tested and such sample(s) are retained for 90 days only.

除非另有說明，此報告結果僅對測試之樣品負責，同時此樣品僅保留90天。本報告未經本公司書面許可，不可部份複製。

This document is issued by the Company subject to its General Conditions of Service printed overleaf, available on request or accessible at www.sgs.com/terms_and_conditions.htm and, for electronic format documents, subject to Terms and Conditions for Electronic Documents at www.sgs.com/terms_e-document.htm. Attention is drawn to the limitation of liability, indemnification and jurisdiction issues defined therein. Any holder of this document is advised that information contained hereon reflects the Company's findings at the time of its intervention only and within the limits of Client's instructions, if any. The Company's sole responsibility is to its Client and this document does not exonerate parties to a transaction from exercising all their rights and obligations under the transaction documents. This document cannot be reproduced except in full, without prior written approval of the Company. Any unauthorized alteration, forgery or falsification of the content or appearance of this document is unlawful and offenders may be prosecuted to the fullest extent of the law.

Appendix (Additional assessments outside the scope of SCS 0108)

Antenna Parameters with Head TSL

| | |
|--------------------------------------|--------------------------------|
| Impedance, transformed to feed point | 50.2 Ω + 2.5 j Ω |
| Return Loss | - 32.2 dB |

Antenna Parameters with Body TSL

| | |
|--------------------------------------|--------------------------------|
| Impedance, transformed to feed point | 46.5 Ω + 2.5 j Ω |
| Return Loss | - 27.0 dB |

General Antenna Parameters and Design

| | |
|----------------------------------|----------|
| Electrical Delay (one direction) | 1.197 ns |
|----------------------------------|----------|

After long term use with 100W radiated power, only a slight warming of the dipole near the feedpoint can be measured.

The dipole is made of standard semirigid coaxial cable. The center conductor of the feeding line is directly connected to the second arm of the dipole. The antenna is therefore short-circuited for DC-signals. On some of the dipoles, small end caps are added to the dipole arms in order to improve matching when loaded according to the position as explained in the "Measurement Conditions" paragraph. The SAR data are not affected by this change. The overall dipole length is still according to the Standard.

No excessive force must be applied to the dipole arms, because they might bend or the soldered connections near the feedpoint may be damaged.

Additional EUT Data

| | |
|-----------------|-------------------|
| Manufactured by | SPEAG |
| Manufactured on | December 17, 2002 |

Unless otherwise stated the results shown in this test report refer only to the sample(s) tested and such sample(s) are retained for 90 days only.

除非另有說明，此報告結果僅對測試之樣品負責，同時此樣品僅保留90天。本報告未經本公司書面許可，不可部份複製。

This document is issued by the Company subject to its General Conditions of Service printed overleaf, available on request or accessible at www.sgs.com/terms_and_conditions.htm and, for electronic format documents, subject to Terms and Conditions for Electronic Documents at www.sgs.com/terms_e-document.htm. Attention is drawn to the limitation of liability, indemnification and jurisdiction issues defined therein. Any holder of this document is advised that information contained hereon reflects the Company's findings at the time of its intervention only and within the limits of Client's instructions, if any. The Company's sole responsibility is to its Client and this document does not exonerate parties to a transaction from exercising all their rights and obligations under the transaction documents. This document cannot be reproduced except in full, without prior written approval of the Company. Any unauthorized alteration, forgery or falsification of the content or appearance of this document is unlawful and offenders may be prosecuted to the fullest extent of the law.

DASY5 Validation Report for Head TSL

Date: 29.04.2015

Test Laboratory: SPEAG, Zurich, Switzerland

DUT: Dipole 1900 MHz; Type: D1900V2; Serial: D1900V2 - SN:5d027

Communication System: UID 0 - CW; Frequency: 1900 MHz
Medium parameters used: $f = 1900$ MHz; $\sigma = 1.37$ S/m; $\epsilon_r = 38.6$; $\rho = 1000$ kg/m³
Phantom section: Flat Section
Measurement Standard: DASY5 (IEEE/IEC/ANSI C63.19-2011)

DASY52 Configuration:

- Probe: ES3DV3 - SN3205; ConvF(5, 5, 5); Calibrated: 30.12.2014;
- Sensor-Surface: 3mm (Mechanical Surface Detection)
- Electronics: DAE4 Sn601; Calibrated: 18.08.2014
- Phantom: Flat Phantom 5.0 (front); Type: QD000P50AA; Serial: 1001
- DASY52 52.8.8(1222); SEMCAD X 14.6.10(7331)

Dipole Calibration for Head Tissue/Pin=250 mW, d=10mm/Zoom Scan (7x7x7)/Cube 0:

Measurement grid: dx=5mm, dy=5mm, dz=5mm
Reference Value = 97.71 V/m; Power Drift = 0.03 dB
Peak SAR (extrapolated) = 18.5 W/kg
SAR(1 g) = 10.1 W/kg; SAR(10 g) = 5.3 W/kg
Maximum value of SAR (measured) = 12.3 W/kg

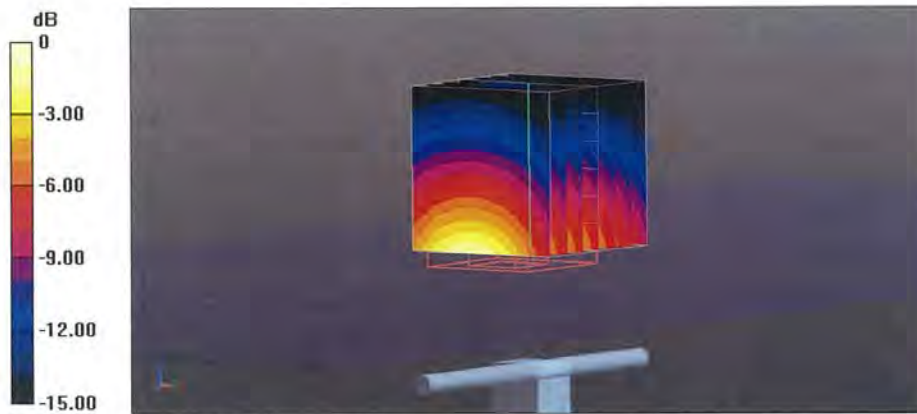

0 dB = 12.3 W/kg = 10.90 dBW/kg

Unless otherwise stated the results shown in this test report refer only to the sample(s) tested and such sample(s) are retained for 90 days only.

除非另有說明，此報告結果僅對測試之樣品負責，同時此樣品僅保留90天。本報告未經本公司書面許可，不可部份複製。

This document is issued by the Company subject to its General Conditions of Service printed overleaf, available on request or accessible at www.sgs.com/terms_and_conditions.htm and, for electronic format documents, subject to Terms and Conditions for Electronic Documents at www.sgs.com/terms_e-document.htm. Attention is drawn to the limitation of liability, indemnification and jurisdiction issues defined therein. Any holder of this document is advised that information contained hereon reflects the Company's findings at the time of its intervention only and within the limits of Client's instructions, if any. The Company's sole responsibility is to its Client and this document does not exonerate parties to a transaction from exercising all their rights and obligations under the transaction documents. This document cannot be reproduced except in full, without prior written approval of the Company. Any unauthorized alteration, forgery or falsification of the content or appearance of this document is unlawful and offenders may be prosecuted to the fullest extent of the law.

Impedance Measurement Plot for Head TSL

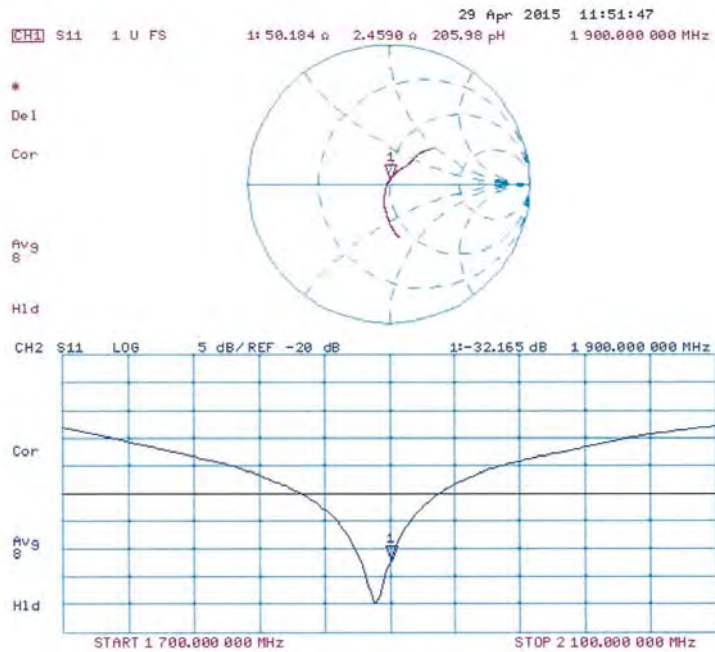

Unless otherwise stated the results shown in this test report refer only to the sample(s) tested and such sample(s) are retained for 90 days only.

除非另有說明，此報告結果僅對測試之樣品負責，同時此樣品僅保留90天。本報告未經本公司書面許可，不可部份複製。

This document is issued by the Company subject to its General Conditions of Service printed overleaf, available on request or accessible at www.sgs.com/terms_and_conditions.htm and, for electronic format documents, subject to Terms and Conditions for Electronic Documents at www.sgs.com/terms_e-document.htm. Attention is drawn to the limitation of liability, indemnification and jurisdiction issues defined therein. Any holder of this document is advised that information contained hereon reflects the Company's findings at the time of its intervention only and within the limits of Client's instructions, if any. The Company's sole responsibility is to its Client and this document does not exonerate parties to a transaction from exercising all their rights and obligations under the transaction documents. This document cannot be reproduced except in full, without prior written approval of the Company. Any unauthorized alteration, forgery or falsification of the content or appearance of this document is unlawful and offenders may be prosecuted to the fullest extent of the law.

DASY5 Validation Report for Body TSL

Date: 29.04.2015

Test Laboratory: SPEAG, Zurich, Switzerland

DUT: Dipole 1900 MHz; Type: D1900V2; Serial: D1900V2 - SN: 5d027

Communication System: UID 0 - CW; Frequency: 1900 MHz
Medium parameters used: $f = 1900$ MHz; $\sigma = 1.5$ S/m; $\epsilon_r = 52.8$; $\rho = 1000$ kg/m³
Phantom section: Flat Section
Measurement Standard: DASY5 (IEEE/IEC/ANSI C63.19-2011)

DASY52 Configuration:

- Probe: ES3DV3 - SN3205; ConvF(4.65, 4.65, 4.65); Calibrated: 30.12.2014;
- Sensor-Surface: 3mm (Mechanical Surface Detection)
- Electronics: DAE4 Sn601; Calibrated: 18.08.2014
- Phantom: Flat Phantom 5.0 (back); Type: QD000P50AA; Serial: 1002
- DASY52 52.8.8(1222); SEMCAD X 14.6.10(7331)

Dipole Calibration for Body Tissue/Pin=250 mW, d=10mm/Zoom Scan (7x7x7)/Cube 0:

Measurement grid: dx=5mm, dy=5mm, dz=5mm
Reference Value = 94.63 V/m; Power Drift = 0.06 dB
Peak SAR (extrapolated) = 16.7 W/kg
SAR(1 g) = 9.78 W/kg; SAR(10 g) = 5.2 W/kg
Maximum value of SAR (measured) = 12.4 W/kg

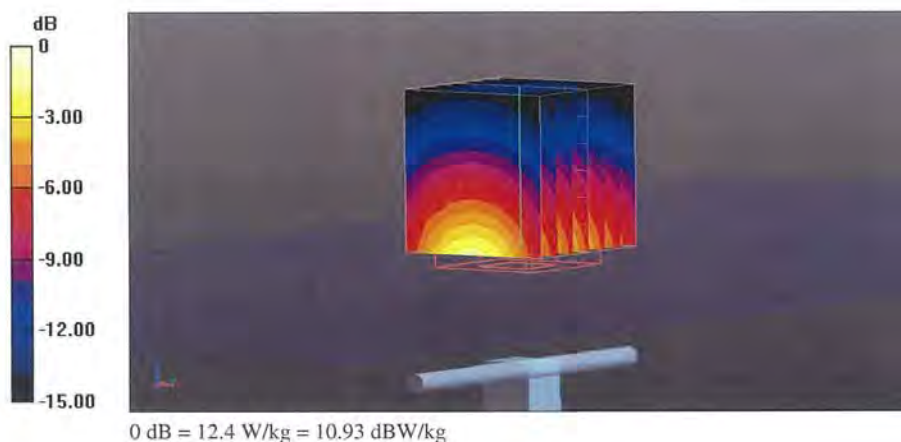

Unless otherwise stated the results shown in this test report refer only to the sample(s) tested and such sample(s) are retained for 90 days only.

除非另有說明，此報告結果僅對測試之樣品負責，同時此樣品僅保留90天。本報告未經本公司書面許可，不可部份複製。

This document is issued by the Company subject to its General Conditions of Service printed overleaf, available on request or accessible at www.sgs.com/terms_and_conditions.htm and, for electronic format documents, subject to Terms and Conditions for Electronic Documents at www.sgs.com/terms_e-document.htm. Attention is drawn to the limitation of liability, indemnification and jurisdiction issues defined therein. Any holder of this document is advised that information contained hereon reflects the Company's findings at the time of its intervention only and within the limits of Client's instructions, if any. The Company's sole responsibility is to its Client and this document does not exonerate parties to a transaction from exercising all their rights and obligations under the transaction documents. This document cannot be reproduced except in full, without prior written approval of the Company. Any unauthorized alteration, forgery or falsification of the content or appearance of this document is unlawful and offenders may be prosecuted to the fullest extent of the law.

Impedance Measurement Plot for Body TSL

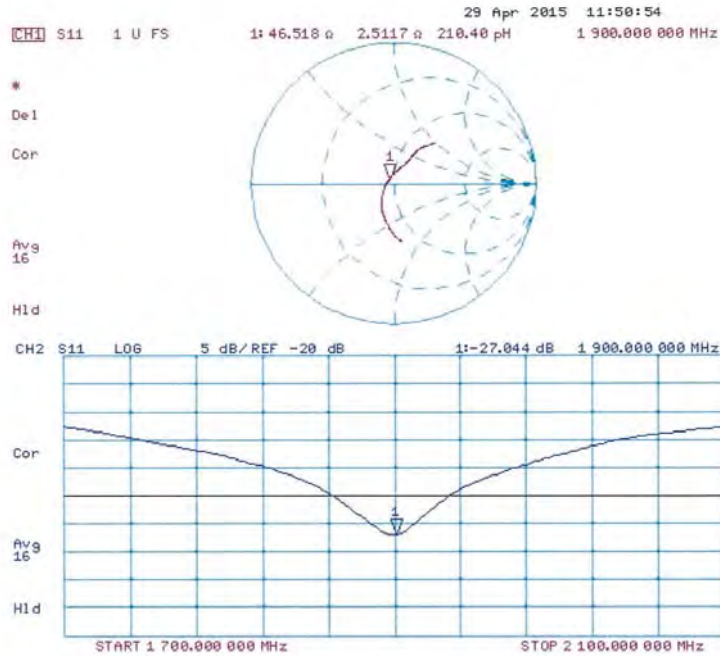

Unless otherwise stated the results shown in this test report refer only to the sample(s) tested and such sample(s) are retained for 90 days only.

除非另有說明，此報告結果僅對測試之樣品負責，同時此樣品僅保留90天。本報告未經本公司書面許可，不可部份複製。

This document is issued by the Company subject to its General Conditions of Service printed overleaf, available on request or accessible at www.sgs.com/terms_and_conditions.htm and, for electronic format documents, subject to Terms and Conditions for Electronic Documents at www.sgs.com/terms_e-document.htm. Attention is drawn to the limitation of liability, indemnification and jurisdiction issues defined therein. Any holder of this document is advised that information contained hereon reflects the Company's findings at the time of its intervention only and within the limits of Client's instructions, if any. The Company's sole responsibility is to its Client and this document does not exonerate parties to a transaction from exercising all their rights and obligations under the transaction documents. This document cannot be reproduced except in full, without prior written approval of the Company. Any unauthorized alteration, forgery or falsification of the content or appearance of this document is unlawful and offenders may be prosecuted to the fullest extent of the law.

**Calibration Laboratory of
Schmid & Partner
Engineering AG**
Zeughausstrasse 43, 8004 Zurich, Switzerland



S Schweizerischer Kalibrierdienst
C Service suisse d'étalonnage
S Servizio svizzero di taratura
S Swiss Calibration Service

Accredited by the Swiss Accreditation Service (SAS)
The Swiss Accreditation Service is one of the signatories to the EA
Multilateral Agreement for the recognition of calibration certificates

Accreditation No.: **SCS 0108**

Client **SGS-TW (Auden)**

Certificate No: **D2450V2-727_Apr15**

CALIBRATION CERTIFICATE

Object: **D2450V2 - SN: 727**

Calibration procedure(s): **QA CAL-05.v9
Calibration procedure for dipole validation kits above 700 MHz**

Calibration date: **April 22, 2015**

This calibration certificate documents the traceability to national standards, which realize the physical units of measurements (SI).
The measurements and the uncertainties with confidence probability are given on the following pages and are part of the certificate.

All calibrations have been conducted in the closed laboratory facility: environment temperature (22 ± 3)°C and humidity < 70%.

Calibration Equipment used (M&TE critical for calibration)

| Primary Standards | ID # | Cal Date (Certificate No.) | Scheduled Calibration |
|-----------------------------|--------------------|-----------------------------------|------------------------|
| Power meter EPM-442A | GB37480704 | 07-Oct-14 (No. 217-02020) | Oct-15 |
| Power sensor HP 8481A | US37292783 | 07-Oct-14 (No. 217-02020) | Oct-15 |
| Power sensor HP 8481A | MY41092317 | 07-Oct-14 (No. 217-02021) | Oct-15 |
| Reference 20 dB Attenuator | SN: 5058 (20k) | 01-Apr-15 (No. 217-02131) | Mar-16 |
| Type-N mismatch combination | SN: 5047.2 / 05327 | 01-Apr-15 (No. 217-02134) | Mar-16 |
| Reference Probe ES3DV3 | SN: 3205 | 30-Dec-14 (No. ES3-3205_Dec14) | Dec-15 |
| DAE4 | SN: 601 | 18-Aug-14 (No. DAE4-601_Aug14) | Aug-15 |
| Secondary Standards | ID # | Check Date (in house) | Scheduled Check |
| RF generator R&S SMT-06 | 100005 | 04-Aug-99 (in house check Oct-13) | In house check: Oct-16 |
| Network Analyzer HP 8753E | US37390585 S4206 | 18-Oct-01 (in house check Oct-14) | In house check: Oct-15 |

| | | | |
|----------------|------------------------------|-----------------------------------|---------------|
| Calibrated by: | Name Michael Weber | Function Laboratory Technician | Signature |
| Approved by: | Name Katja Pokovic | Function Technical Manager | |

Issued: April 23, 2015

This calibration certificate shall not be reproduced except in full without written approval of the laboratory.

Unless otherwise stated the results shown in this test report refer only to the sample(s) tested and such sample(s) are retained for 90 days only.

除非另有說明，此報告結果僅對測試之樣品負責，同時此樣品僅保留90天。本報告未經本公司書面許可，不可部份複製。

This document is issued by the Company subject to its General Conditions of Service printed overleaf, available on request or accessible at www.sgs.com/terms_and_conditions.htm and, for electronic format documents, subject to Terms and Conditions for Electronic Documents at www.sgs.com/terms_e-document.htm. Attention is drawn to the limitation of liability, indemnification and jurisdiction issues defined therein. Any holder of this document is advised that information contained hereon reflects the Company's findings at the time of its intervention only and within the limits of Client's instructions, if any. The Company's sole responsibility is to its Client and this document does not exonerate parties to a transaction from exercising all their rights and obligations under the transaction documents. This document cannot be reproduced except in full, without prior written approval of the Company. Any unauthorized alteration, forgery or falsification of the content or appearance of this document is unlawful and offenders may be prosecuted to the fullest extent of the law.

**Calibration Laboratory of
Schmid & Partner
Engineering AG**
Zeughausstrasse 43, 8004 Zurich, Switzerland



S Schweizerischer Kalibrierdienst
C Service suisse d'étalonnage
S Servizio svizzero di taratura
S Swiss Calibration Service

Accredited by the Swiss Accreditation Service (SAS)
The Swiss Accreditation Service is one of the signatories to the EA
Multilateral Agreement for the recognition of calibration certificates

Accreditation No.: **SCS 0108**

Glossary:

| | |
|-------|---------------------------------|
| TSL | tissue simulating liquid |
| ConvF | sensitivity in TSL / NORM x,y,z |
| N/A | not applicable or not measured |

Calibration is Performed According to the Following Standards:

- a) IEEE Std 1528-2013, "IEEE Recommended Practice for Determining the Peak Spatial-Averaged Specific Absorption Rate (SAR) in the Human Head from Wireless Communications Devices: Measurement Techniques", June 2013
- b) IEC 62209-1, "Procedure to measure the Specific Absorption Rate (SAR) for hand-held devices used in close proximity to the ear (frequency range of 300 MHz to 3 GHz)", February 2005
- c) KDB 865664, "SAR Measurement Requirements for 100 MHz to 6 GHz"

Additional Documentation:

- d) DAS4/5 System Handbook

Methods Applied and Interpretation of Parameters:

- *Measurement Conditions:* Further details are available from the Validation Report at the end of the certificate. All figures stated in the certificate are valid at the frequency indicated.
- *Antenna Parameters with TSL:* The dipole is mounted with the spacer to position its feed point exactly below the center marking of the flat phantom section, with the arms oriented parallel to the body axis.
- *Feed Point Impedance and Return Loss:* These parameters are measured with the dipole positioned under the liquid filled phantom. The impedance stated is transformed from the measurement at the SMA connector to the feed point. The Return Loss ensures low reflected power. No uncertainty required.
- *Electrical Delay:* One-way delay between the SMA connector and the antenna feed point. No uncertainty required.
- *SAR measured:* SAR measured at the stated antenna input power.
- *SAR normalized:* SAR as measured, normalized to an input power of 1 W at the antenna connector.
- *SAR for nominal TSL parameters:* The measured TSL parameters are used to calculate the nominal SAR result.

The reported uncertainty of measurement is stated as the standard uncertainty of measurement multiplied by the coverage factor $k=2$, which for a normal distribution corresponds to a coverage probability of approximately 95%.

Unless otherwise stated the results shown in this test report refer only to the sample(s) tested and such sample(s) are retained for 90 days only.

除非另有說明，此報告結果僅對測試之樣品負責，同時此樣品僅保留90天。本報告未經本公司書面許可，不可部份複製。

This document is issued by the Company subject to its General Conditions of Service printed overleaf, available on request or accessible at www.sgs.com/terms_and_conditions.htm and, for electronic format documents, subject to Terms and Conditions for Electronic Documents at www.sgs.com/terms_e-document.htm. Attention is drawn to the limitation of liability, indemnification and jurisdiction issues defined therein. Any holder of this document is advised that information contained hereon reflects the Company's findings at the time of its intervention only and within the limits of Client's instructions, if any. The Company's sole responsibility is to its Client and this document does not exonerate parties to a transaction from exercising all their rights and obligations under the transaction documents. This document cannot be reproduced except in full, without prior written approval of the Company. Any unauthorized alteration, forgery or falsification of the content or appearance of this document is unlawful and offenders may be prosecuted to the fullest extent of the law.

Measurement Conditions

DASY system configuration, as far as not given on page 1.

| | | |
|------------------------------|------------------------|-------------|
| DASY Version | DASY5 | V52.8.8 |
| Extrapolation | Advanced Extrapolation | |
| Phantom | Modular Flat Phantom | |
| Distance Dipole Center - TSL | 10 mm | with Spacer |
| Zoom Scan Resolution | dx, dy, dz = 5 mm | |
| Frequency | 2450 MHz \pm 1 MHz | |

Head TSL parameters

The following parameters and calculations were applied.

| | Temperature | Permittivity | Conductivity |
|---|---------------------|----------------|----------------------|
| Nominal Head TSL parameters | 22.0 °C | 39.2 | 1.80 mho/m |
| Measured Head TSL parameters | (22.0 \pm 0.2) °C | 37.6 \pm 6 % | 1.82 mho/m \pm 6 % |
| Head TSL temperature change during test | < 0.5 °C | ---- | ---- |

SAR result with Head TSL

| SAR averaged over 1 cm ³ (1 g) of Head TSL | Condition | |
|---|--------------------|------------------------------|
| SAR measured | 250 mW input power | 13.2 W/kg |
| SAR for nominal Head TSL parameters | normalized to 1W | 52.0 W/kg \pm 17.0 % (k=2) |

| SAR averaged over 10 cm ³ (10 g) of Head TSL | condition | |
|---|--------------------|------------------------------|
| SAR measured | 250 mW input power | 6.10 W/kg |
| SAR for nominal Head TSL parameters | normalized to 1W | 24.2 W/kg \pm 16.5 % (k=2) |

Body TSL parameters

The following parameters and calculations were applied.

| | Temperature | Permittivity | Conductivity |
|---|---------------------|----------------|----------------------|
| Nominal Body TSL parameters | 22.0 °C | 52.7 | 1.95 mho/m |
| Measured Body TSL parameters | (22.0 \pm 0.2) °C | 50.6 \pm 6 % | 2.02 mho/m \pm 6 % |
| Body TSL temperature change during test | < 0.5 °C | ---- | ---- |

SAR result with Body TSL

| SAR averaged over 1 cm ³ (1 g) of Body TSL | Condition | |
|---|--------------------|------------------------------|
| SAR measured | 250 mW input power | 13.1 W/kg |
| SAR for nominal Body TSL parameters | normalized to 1W | 51.0 W/kg \pm 17.0 % (k=2) |

| SAR averaged over 10 cm ³ (10 g) of Body TSL | condition | |
|---|--------------------|------------------------------|
| SAR measured | 250 mW input power | 6.10 W/kg |
| SAR for nominal Body TSL parameters | normalized to 1W | 24.0 W/kg \pm 16.5 % (k=2) |

Unless otherwise stated the results shown in this test report refer only to the sample(s) tested and such sample(s) are retained for 90 days only.

除非另有說明，此報告結果僅對測試之樣品負責，同時此樣品僅保留90天。本報告未經本公司書面許可，不可部份複製。

This document is issued by the Company subject to its General Conditions of Service printed overleaf, available on request or accessible at www.sgs.com/terms_and_conditions.htm and, for electronic format documents, subject to Terms and Conditions for Electronic Documents at www.sgs.com/terms_e-document.htm. Attention is drawn to the limitation of liability, indemnification and jurisdiction issues defined therein. Any holder of this document is advised that information contained hereon reflects the Company's findings at the time of its intervention only and within the limits of Client's instructions, if any. The Company's sole responsibility is to its Client and this document does not exonerate parties to a transaction from exercising all their rights and obligations under the transaction documents. This document cannot be reproduced except in full, without prior written approval of the Company. Any unauthorized alteration, forgery or falsification of the content or appearance of this document is unlawful and offenders may be prosecuted to the fullest extent of the law.

Appendix (Additional assessments outside the scope of SCS 0108)

Antenna Parameters with Head TSL

| | |
|--------------------------------------|--------------------------------|
| Impedance, transformed to feed point | 56.2 Ω + 1.3 j Ω |
| Return Loss | - 24.6 dB |

Antenna Parameters with Body TSL

| | |
|--------------------------------------|--------------------------------|
| Impedance, transformed to feed point | 51.8 Ω + 3.3 j Ω |
| Return Loss | - 28.6 dB |

General Antenna Parameters and Design

| | |
|----------------------------------|----------|
| Electrical Delay (one direction) | 1.149 ns |
|----------------------------------|----------|

After long term use with 100W radiated power, only a slight warming of the dipole near the feedpoint can be measured.

The dipole is made of standard semirigid coaxial cable. The center conductor of the feeding line is directly connected to the second arm of the dipole. The antenna is therefore short-circuited for DC-signals. On some of the dipoles, small end caps are added to the dipole arms in order to improve matching when loaded according to the position as explained in the "Measurement Conditions" paragraph. The SAR data are not affected by this change. The overall dipole length is still according to the Standard.

No excessive force must be applied to the dipole arms, because they might bend or the soldered connections near the feedpoint may be damaged.

Additional EUT Data

| | |
|-----------------|------------------|
| Manufactured by | SPEAG |
| Manufactured on | January 09, 2003 |

DASY5 Validation Report for Head TSL

Date: 22.04.2015

Test Laboratory: SPEAG, Zurich, Switzerland

DUT: Dipole 2450 MHz; Type: D2450V2; Serial: D2450V2 - SN: 727

Communication System: UID 0 - CW; Frequency: 2450 MHz
 Medium parameters used: $f = 2450$ MHz; $\sigma = 1.82$ S/m; $\epsilon_r = 37.6$; $\rho = 1000$ kg/m³
 Phantom section: Flat Section
 Measurement Standard: DASY5 (IEEE/IEC/ANSI C63.19-2011)

DASY52 Configuration:

- Probe: ES3DV3 - SN3205; ConvF(4.54, 4.54, 4.54); Calibrated: 30.12.2014;
- Sensor-Surface: 3mm (Mechanical Surface Detection)
- Electronics: DAE4 Sn601; Calibrated: 18.08.2014
- Phantom: Flat Phantom 5.0 (front); Type: QD000P50AA; Serial: 1001
- DASY52 52.8.8(1222); SEMCAD X 14.6.10(7331)

Dipole Calibration for Head Tissue/Pin=250 mW, d=10mm/Zoom Scan (7x7x7)/Cube 0:

Measurement grid: dx=5mm, dy=5mm, dz=5mm
 Reference Value = 101.5 V/m; Power Drift = 0.01 dB
 Peak SAR (extrapolated) = 27.4 W/kg
SAR(1 g) = 13.2 W/kg; SAR(10 g) = 6.1 W/kg
 Maximum value of SAR (measured) = 17.5 W/kg

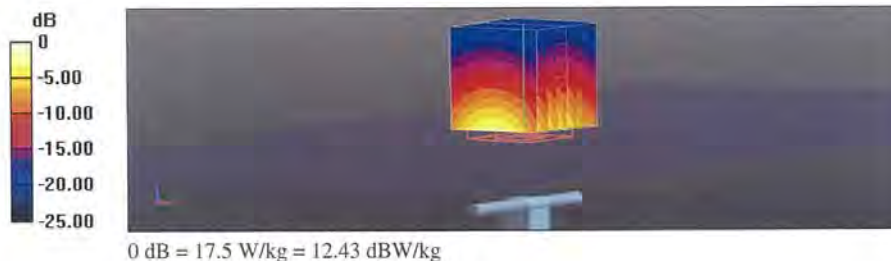

Unless otherwise stated the results shown in this test report refer only to the sample(s) tested and such sample(s) are retained for 90 days only.

除非另有說明，此報告結果僅對測試之樣品負責，同時此樣品僅保留90天。本報告未經本公司書面許可，不可部份複製。

This document is issued by the Company subject to its General Conditions of Service printed overleaf, available on request or accessible at www.sgs.com/terms_and_conditions.htm and, for electronic format documents, subject to Terms and Conditions for Electronic Documents at www.sgs.com/terms_e-document.htm. Attention is drawn to the limitation of liability, indemnification and jurisdiction issues defined therein. Any holder of this document is advised that information contained hereon reflects the Company's findings at the time of its intervention only and within the limits of Client's instructions, if any. The Company's sole responsibility is to its Client and this document does not exonerate parties to a transaction from exercising all their rights and obligations under the transaction documents. This document cannot be reproduced except in full, without prior written approval of the Company. Any unauthorized alteration, forgery or falsification of the content or appearance of this document is unlawful and offenders may be prosecuted to the fullest extent of the law.

Impedance Measurement Plot for Head TSL

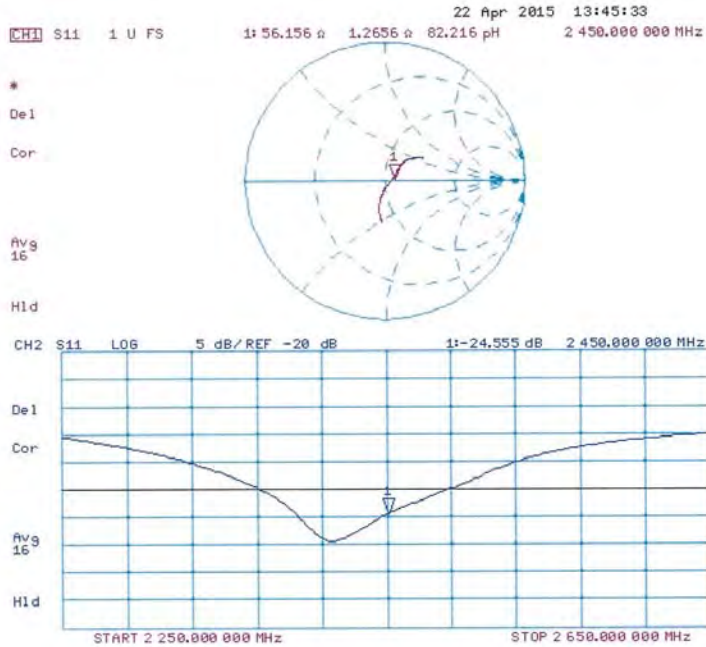

Unless otherwise stated the results shown in this test report refer only to the sample(s) tested and such sample(s) are retained for 90 days only.

除非另有說明，此報告結果僅對測試之樣品負責，同時此樣品僅保留90天。本報告未經本公司書面許可，不可部份複製。

This document is issued by the Company subject to its General Conditions of Service printed overleaf, available on request or accessible at www.sgs.com/terms_and_conditions.htm and, for electronic format documents, subject to Terms and Conditions for Electronic Documents at www.sgs.com/terms_e-document.htm. Attention is drawn to the limitation of liability, indemnification and jurisdiction issues defined therein. Any holder of this document is advised that information contained hereon reflects the Company's findings at the time of its intervention only and within the limits of Client's instructions, if any. The Company's sole responsibility is to its Client and this document does not exonerate parties to a transaction from exercising all their rights and obligations under the transaction documents. This document cannot be reproduced except in full, without prior written approval of the Company. Any unauthorized alteration, forgery or falsification of the content or appearance of this document is unlawful and offenders may be prosecuted to the fullest extent of the law.

DASY5 Validation Report for Body TSL

Date: 22.04.2015

Test Laboratory: SPEAG, Zurich, Switzerland

DUT: Dipole 2450 MHz; Type: D2450V2; Serial: D2450V2 - SN: 727

Communication System: UID 0 - CW; Frequency: 2450 MHz

Medium parameters used: $f = 2450$ MHz; $\sigma = 2.02$ S/m; $\epsilon_r = 50.6$; $\rho = 1000$ kg/m³

Phantom section: Flat Section

Measurement Standard: DASY5 (IEEE/IEC/ANSI C63.19-2011)

DASY52 Configuration:

- Probe: ES3DV3 - SN3205; ConvF(4.32, 4.32, 4.32); Calibrated: 30.12.2014;
- Sensor-Surface: 3mm (Mechanical Surface Detection)
- Electronics: DAE4 Sn601; Calibrated: 18.08.2014
- Phantom: Flat Phantom 5.0 (back); Type: QD000P50AA; Serial: 1002
- DASY52 52.8.8(1222); SEMCAD X 14.6.10(7331)

Dipole Calibration for Body Tissue/Pin=250 mW, d=10mm/Zoom Scan (7x7x7)/Cube 0:

Measurement grid: dx=5mm, dy=5mm, dz=5mm

Reference Value = 95.54 V/m; Power Drift = -0.01 dB

Peak SAR (extrapolated) = 27.2 W/kg

SAR(1 g) = 13.1 W/kg; SAR(10 g) = 6.1 W/kg

Maximum value of SAR (measured) = 17.4 W/kg

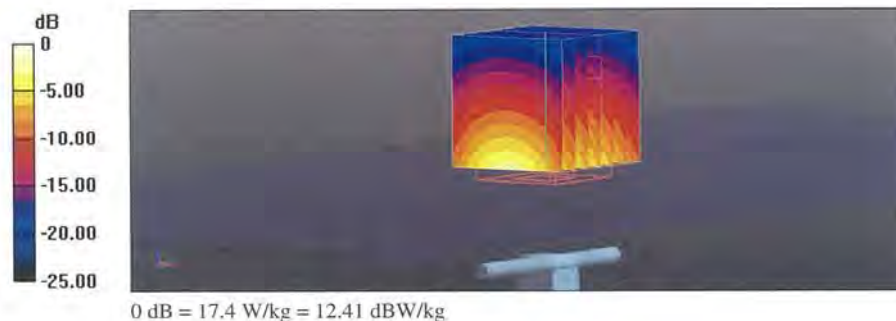

Unless otherwise stated the results shown in this test report refer only to the sample(s) tested and such sample(s) are retained for 90 days only.

除非另有說明，此報告結果僅對測試之樣品負責，同時此樣品僅保留90天。本報告未經本公司書面許可，不可部份複製。

This document is issued by the Company subject to its General Conditions of Service printed overleaf, available on request or accessible at www.sgs.com/terms_and_conditions.htm and, for electronic format documents, subject to Terms and Conditions for Electronic Documents at www.sgs.com/terms_e-document.htm. Attention is drawn to the limitation of liability, indemnification and jurisdiction issues defined therein. Any holder of this document is advised that information contained hereon reflects the Company's findings at the time of its intervention only and within the limits of Client's instructions, if any. The Company's sole responsibility is to its Client and this document does not exonerate parties to a transaction from exercising all their rights and obligations under the transaction documents. This document cannot be reproduced except in full, without prior written approval of the Company. Any unauthorized alteration, forgery or falsification of the content or appearance of this document is unlawful and offenders may be prosecuted to the fullest extent of the law.

Impedance Measurement Plot for Body TSL

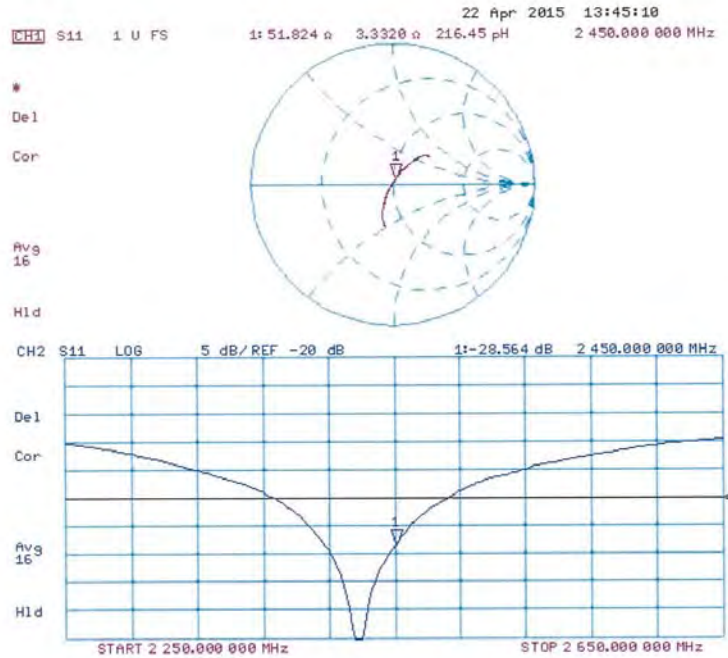

Unless otherwise stated the results shown in this test report refer only to the sample(s) tested and such sample(s) are retained for 90 days only.

除非另有說明，此報告結果僅對測試之樣品負責，同時此樣品僅保留90天。本報告未經本公司書面許可，不可部份複製。

This document is issued by the Company subject to its General Conditions of Service printed overleaf, available on request or accessible at www.sgs.com/terms_and_conditions.htm and, for electronic format documents, subject to Terms and Conditions for Electronic Documents at www.sgs.com/terms_e-document.htm. Attention is drawn to the limitation of liability, indemnification and jurisdiction issues defined therein. Any holder of this document is advised that information contained hereon reflects the Company's findings at the time of its intervention only and within the limits of Client's instructions, if any. The Company's sole responsibility is to its Client and this document does not exonerate parties to a transaction from exercising all their rights and obligations under the transaction documents. This document cannot be reproduced except in full, without prior written approval of the Company. Any unauthorized alteration, forgery or falsification of the content or appearance of this document is unlawful and offenders may be prosecuted to the fullest extent of the law.

**Calibration Laboratory of
Schmid & Partner
Engineering AG**
Zeughausstrasse 43, 8004 Zurich, Switzerland



S Schweizerischer Kalibrierdienst
C Service suisse d'étalonnage
S Servizio svizzero di taratura
S Swiss Calibration Service

Accredited by the Swiss Accreditation Service (SAS)
The Swiss Accreditation Service is one of the signatories to the EA
Multilateral Agreement for the recognition of calibration certificates

Accreditation No.: **SCS 0108**

Client **SGS-TW (Auden)**

Certificate No: **D5GHzV2-1023_Jan15**

CALIBRATION CERTIFICATE

Object: **D5GHzV2 - SN:1023**

Calibration procedure(s): **QA CAL-22.v2
Calibration procedure for dipole validation kits between 3-6 GHz**

Calibration date: **January 29, 2015**

This calibration certificate documents the traceability to national standards, which realize the physical units of measurements (SI). The measurements and the uncertainties with confidence probability are given on the following pages and are part of the certificate.

All calibrations have been conducted in the closed laboratory facility: environment temperature (22 ± 3°C and humidity < 70%.

Calibration Equipment used (M&TE critical for calibration):

| Primary Standards | ID # | Cal Date (Certificate No.) | Scheduled Calibration |
|-----------------------------|-------------------|-----------------------------------|------------------------|
| Power meter EPM-442A | GB37480704 | 07-Oct-14 (No. 217-02020) | Oct-15 |
| Power sensor HP 8481A | US37292783 | 07-Oct-14 (No. 217-02020) | Oct-15 |
| Power sensor HP 8481A | MY41092317 | 07-Oct-14 (No. 217-02021) | Oct-15 |
| Reference 20 dB Attenuator | SN: 5058 (30k) | 03-Apr-14 (No. 217-01916) | Apr-15 |
| Type-N mismatch combination | SN: 80472 / 06327 | 03-Apr-14 (No. 217-01921) | Apr-15 |
| Reference Probe EX3DV4 | SN: 3503 | 30-Dec-14 (No. EX3-3503_Dec14) | Dec-15 |
| DAEs | SN: 801 | 18-Aug-14 (No. DAE4-801_Aug14) | Aug-15 |
| Secondary Standards | ID # | Check Date (in house) | Scheduled Check |
| RF generator R&S SMT 06 | 100005 | 04-Aug-09 (in house check Oct-13) | In house check: Oct-15 |
| Network Analyzer HP 8753E | US37360080 54206 | 19-Oct-01 (in house check Oct-14) | In house check: Oct-15 |

Calibrated by: **Name: Michael Weber, Function: Laboratory Technician, Signature: [Signature]**

Approved by: **Name: Katja Polovinc, Function: Technical Manager, Signature: [Signature]**

Issued: January 29, 2015

This calibration certificate shall not be reproduced except in full without written approval of the laboratory.

Unless otherwise stated the results shown in this test report refer only to the sample(s) tested and such sample(s) are retained for 90 days only.

除非另有說明，此報告結果僅對測試之樣品負責，同時此樣品僅保留90天。本報告未經本公司書面許可，不可部份複製。

This document is issued by the Company subject to its General Conditions of Service printed overleaf, available on request or accessible at www.sgs.com/terms_and_conditions.htm and, for electronic format documents, subject to Terms and Conditions for Electronic Documents at www.sgs.com/terms_e-document.htm. Attention is drawn to the limitation of liability, indemnification and jurisdiction issues defined therein. Any holder of this document is advised that information contained hereon reflects the Company's findings at the time of its intervention only and within the limits of Client's instructions, if any. The Company's sole responsibility is to its Client and this document does not exonerate parties to a transaction from exercising all their rights and obligations under the transaction documents. This document cannot be reproduced except in full, without prior written approval of the Company. Any unauthorized alteration, forgery or falsification of the content or appearance of this document is unlawful and offenders may be prosecuted to the fullest extent of the law.

**Calibration Laboratory of
Schmid & Partner
Engineering AG**
Zeughausstrasse 43, 8004 Zurich, Switzerland



S Schweizerischer Kalibrierdienst
S Service suisse d'étalonnage
C Servizio svizzero di taratura
S Swiss Calibration Service

Accredited by the Swiss Accreditation Service (SAS)
The Swiss Accreditation Service is one of the signatories to the EA
Multilateral Agreement for the recognition of calibration certificates

Accreditation No.: **SCS 0106**

Glossary:

TSL tissue simulating liquid
ConyF sensitivity in TSL / NORM x,y,z
N/A not applicable or not measured

Calibration is Performed According to the Following Standards:

- a) IEC 62209-2, "Evaluation of Human Exposure to Radio Frequency Fields from Handheld and Body-Mounted Wireless Communication Devices in the Frequency Range of 30 MHz to 6 GHz: Human models, Instrumentation, and Procedures". Part 2: "Procedure to determine the Specific Absorption Rate (SAR) for including accessories and multiple transmitters", March 2010
- b) KDB 865664, "SAR Measurement Requirements for 100 MHz to 6 GHz"
- c) IEEE Std 1528-2013, "IEEE Recommended Practice for Determining the Peak Spatial-Averaged Specific Absorption Rate (SAR) in the Human Head from Wireless Communications Devices: Measurement Techniques", June 2013

Additional Documentation:

- d) DASY4/5 System Handbook

Methods Applied and Interpretation of Parameters:

- *Measurement Conditions:* Further details are available from the Validation Report at the end of the certificate. All figures stated in the certificate are valid at the frequency indicated.
- *Antenna Parameters with TSL:* The dipole is mounted with the spacer to position its feed point exactly below the center marking of the flat phantom section, with the arms oriented parallel to the body axis.
- *Feed Point Impedance and Return Loss:* These parameters are measured with the dipole positioned under the liquid filled phantom. The impedance stated is transformed from the measurement at the SMA connector to the feed point. The Return Loss ensures low reflected power. No uncertainty required.
- *Electrical Delay:* One-way delay between the SMA connector and the antenna feed point. No uncertainty required.
- *SAR measured:* SAR measured at the stated antenna input power.
- *SAR normalized:* SAR as measured, normalized to an input power of 1 W at the antenna connector.
- *SAR for nominal TSL parameters:* The measured TSL parameters are used to calculate the nominal SAR result.

The reported uncertainty of measurement is stated as the standard uncertainty of measurement multiplied by the coverage factor $k=2$, which for a normal distribution corresponds to a coverage probability of approximately 95%.

Unless otherwise stated the results shown in this test report refer only to the sample(s) tested and such sample(s) are retained for 90 days only.

除非另有說明，此報告結果僅對測試之樣品負責，同時此樣品僅保留90天。本報告未經本公司書面許可，不可部份複製。

This document is issued by the Company subject to its General Conditions of Service printed overleaf, available on request or accessible at www.sgs.com/terms_and_conditions.htm and, for electronic format documents, subject to Terms and Conditions for Electronic Documents at www.sgs.com/terms_e-document.htm. Attention is drawn to the limitation of liability, indemnification and jurisdiction issues defined therein. Any holder of this document is advised that information contained hereon reflects the Company's findings at the time of its intervention only and within the limits of Client's instructions, if any. The Company's sole responsibility is to its Client and this document does not exonerate parties to a transaction from exercising all their rights and obligations under the transaction documents. This document cannot be reproduced except in full, without prior written approval of the Company. Any unauthorized alteration, forgery or falsification of the content or appearance of this document is unlawful and offenders may be prosecuted to the fullest extent of the law.

Measurement Conditions

DASY system configuration, as far as not given on page 1.

| | | |
|------------------------------|--|----------------------------------|
| DASY Version | DASY5 | V52.6.6 |
| Extrapolation | Advanced Extrapolation | |
| Phantom | Modular Flat Phantom V5.0 | |
| Distance Dipole Center - TSL | 10 mm | with Spacer |
| Zoom Scan Resolution | $dx, dy = 4.0 \text{ mm}$, $dz = 1.4 \text{ mm}$ | Graded Ratio = 1.4 (Z direction) |
| Frequency | 5200 MHz \pm 1 MHz 5300 MHz \pm 1 MHz 5600 MHz \pm 1 MHz 5600 MHz \pm 1 MHz | |

Head TSL parameters at 5200 MHz

The following parameters and calculations were applied:

| | Temperature | Permittivity | Conductivity |
|---|---------------------|----------------|----------------------|
| Nominal Head TSL parameters | 22.0 °C | 36.0 | 4.56 mho/m |
| Measured Head TSL parameters | (22.0 \pm 0.2) °C | 36.9 \pm 0 % | 4.56 mho/m \pm 0 % |
| Head TSL temperature change during test | < 0.5 °C | — | — |

SAR result with Head TSL at 5200 MHz

| SAR averaged over 1 cm ³ (1 g) of Head TSL | Condition | |
|---|--------------------|------------------------------|
| SAR measured | 100 mW input power | 7.78 W/kg |
| SAR for nominal Head TSL parameters | normalized to 1W | 77.9 W/kg \pm 19.9 % (k=2) |

| SAR averaged over 10 cm ³ (10 g) of Head TSL | Condition | |
|---|--------------------|------------------------------|
| SAR measured | 100 mW input power | 22.2 W/kg |
| SAR for nominal Head TSL parameters | normalized to 1W | 22.2 W/kg \pm 19.5 % (k=2) |

Unless otherwise stated the results shown in this test report refer only to the sample(s) tested and such sample(s) are retained for 90 days only.

除非另有說明，此報告結果僅對測試之樣品負責，同時此樣品僅保留90天。本報告未經本公司書面許可，不可部份複製。

This document is issued by the Company subject to its General Conditions of Service printed overleaf, available on request or accessible at www.sgs.com/terms_and_conditions.htm and, for electronic format documents, subject to Terms and Conditions for Electronic Documents at www.sgs.com/terms_e-document.htm. Attention is drawn to the limitation of liability, indemnification and jurisdiction issues defined therein. Any holder of this document is advised that information contained hereon reflects the Company's findings at the time of its intervention only and within the limits of Client's instructions, if any. The Company's sole responsibility is to its Client and this document does not exonerate parties to a transaction from exercising all their rights and obligations under the transaction documents. This document cannot be reproduced except in full, without prior written approval of the Company. Any unauthorized alteration, forgery or falsification of the content or appearance of this document is unlawful and offenders may be prosecuted to the fullest extent of the law.

Head TSL parameters at 5300 MHz

The following parameters and calculations were applied:

| | Temperature | Permittivity | Conductivity |
|---|-----------------|--------------|------------------|
| Nominal Head TSL parameters | 22.0 °C | 35.9 | 4.78 mho/m |
| Measured Head TSL parameters | (22.0 ± 0.2) °C | 36.1 ± 6 % | 4.86 mho/m ± 6 % |
| Head TSL temperature change during test | < 0.5 °C | — | — |

SAR result with Head TSL at 5300 MHz

| SAR averaged over 1 cm ³ (1 g) of Head TSL | Condition | |
|---|--------------------|----------------------------|
| SAR measured | 100 mW input power | 6.17 W/kg |
| SAR for nominal Head TSL parameters | normalized to 1W | 61.7 W / kg ± 19.9 % (k=2) |

| SAR averaged over 10 cm ³ (10 g) of Head TSL | condition | |
|---|--------------------|--------------------------|
| SAR measured | 100 mW input power | 2.34 W/kg |
| SAR for nominal Head TSL parameters | normalized to 1W | 23.4 W/kg ± 19.5 % (k=2) |

Head TSL parameters at 5600 MHz

The following parameters and calculations were applied:

| | Temperature | Permittivity | Conductivity |
|---|-----------------|--------------|------------------|
| Nominal Head TSL parameters | 22.0 °C | 35.5 | 5.07 mho/m |
| Measured Head TSL parameters | (22.0 ± 0.2) °C | 35.7 ± 6 % | 4.97 mho/m ± 6 % |
| Head TSL temperature change during test | < 0.5 °C | — | — |

SAR result with Head TSL at 5600 MHz

| SAR averaged over 1 cm ³ (1 g) of Head TSL | Condition | |
|---|--------------------|--------------------------|
| SAR measured | 100 mW input power | 6.14 W/kg |
| SAR for nominal Head TSL parameters | normalized to 1W | 61.4 W/kg ± 19.9 % (k=2) |

| SAR averaged over 10 cm ³ (10 g) of Head TSL | condition | |
|---|--------------------|--------------------------|
| SAR measured | 100 mW input power | 2.31 W/kg |
| SAR for nominal Head TSL parameters | normalized to 1W | 23.1 W/kg ± 19.5 % (k=2) |

Unless otherwise stated the results shown in this test report refer only to the sample(s) tested and such sample(s) are retained for 90 days only.

除非另有說明，此報告結果僅對測試之樣品負責，同時此樣品僅保留90天。本報告未經本公司書面許可，不可部份複製。

This document is issued by the Company subject to its General Conditions of Service printed overleaf, available on request or accessible at www.sgs.com/terms_and_conditions.htm and, for electronic format documents, subject to Terms and Conditions for Electronic Documents at www.sgs.com/terms_e-document.htm. Attention is drawn to the limitation of liability, indemnification and jurisdiction issues defined therein. Any holder of this document is advised that information contained hereon reflects the Company's findings at the time of its intervention only and within the limits of Client's instructions, if any. The Company's sole responsibility is to its Client and this document does not exonerate parties to a transaction from exercising all their rights and obligations under the transaction documents. This document cannot be reproduced except in full, without prior written approval of the Company. Any unauthorized alteration, forgery or falsification of the content or appearance of this document is unlawful and offenders may be prosecuted to the fullest extent of the law.

Head TSL parameters at 5800 MHz

The following parameters and calculations were applied:

| | Temperature | Permittivity | Conductivity |
|---|-----------------|--------------|------------------|
| Nominal Head TSL parameters | 22.0 °C | 35.3 | 5.27 mho/m |
| Measured Head TSL parameters | (22.0 ± 0.2) °C | 35.4 ± 6 % | 5.18 mho/m ± 6 % |
| Head TSL temperature change during test | < 0.5 °C | — | — |

SAR result with Head TSL at 5800 MHz

| SAR averaged over 1 cm ² (1 g) of Head TSL | Condition | |
|---|--------------------|--------------------------|
| SAR measured | 100 mW input power | 7.82 W/kg |
| SAR for nominal Head TSL parameters | normalized to 1W | 78.2 W/kg ± 19.9 % (k=2) |

| SAR averaged over 10 cm ² (10 g) of Head TSL | Condition | |
|---|--------------------|--------------------------|
| SAR measured | 100 mW input power | 2.23 W/kg |
| SAR for nominal Head TSL parameters | normalized to 1W | 22.3 W/kg ± 19.5 % (k=2) |

Unless otherwise stated the results shown in this test report refer only to the sample(s) tested and such sample(s) are retained for 90 days only.

除非另有說明，此報告結果僅對測試之樣品負責，同時此樣品僅保留90天。本報告未經本公司書面許可，不可部份複製。

This document is issued by the Company subject to its General Conditions of Service printed overleaf, available on request or accessible at www.sgs.com/terms_and_conditions.htm and, for electronic format documents, subject to Terms and Conditions for Electronic Documents at www.sgs.com/terms_e-document.htm. Attention is drawn to the limitation of liability, indemnification and jurisdiction issues defined therein. Any holder of this document is advised that information contained hereon reflects the Company's findings at the time of its intervention only and within the limits of Client's instructions, if any. The Company's sole responsibility is to its Client and this document does not exonerate parties to a transaction from exercising all their rights and obligations under the transaction documents. This document cannot be reproduced except in full, without prior written approval of the Company. Any unauthorized alteration, forgery or falsification of the content or appearance of this document is unlawful and offenders may be prosecuted to the fullest extent of the law.

Body TSL parameters at 5200 MHz

The following parameters and calculations were applied:

| | Temperature | Permittivity | Conductivity |
|---|-----------------|--------------|------------------|
| Nominal Body TSL parameters | 22.0 °C | 49.0 | 5.30 mho/m |
| Measured Body TSL parameters | (22.0 ± 0.2) °C | 49.4 ± 6 % | 5.42 mho/m ± 6 % |
| Body TSL temperature change during test | < 0.5 °C | — | — |

SAR result with Body TSL at 5200 MHz

| SAR averaged over 1 cm ³ (1 g) of Body TSL | Condition | |
|---|--------------------|--------------------------|
| SAR measured | 100 mW input power | 7.33 W/kg |
| SAR for nominal Body TSL parameters | normalized to 1W | 73.5 W/kg ± 19.9 % (k=2) |

| SAR averaged over 10 cm ³ (10 g) of Body TSL | Condition | |
|---|--------------------|--------------------------|
| SAR measured | 100 mW input power | 2.04 W/kg |
| SAR for nominal Body TSL parameters | normalized to 1W | 20.5 W/kg ± 19.5 % (k=2) |

Body TSL parameters at 5300 MHz

The following parameters and calculations were applied:

| | Temperature | Permittivity | Conductivity |
|---|-----------------|--------------|------------------|
| Nominal Body TSL parameters | 22.0 °C | 48.9 | 5.42 mho/m |
| Measured Body TSL parameters | (22.0 ± 0.2) °C | 49.2 ± 6 % | 5.55 mho/m ± 6 % |
| Body TSL temperature change during test | < 0.5 °C | — | — |

SAR result with Body TSL at 5300 MHz

| SAR averaged over 1 cm ³ (1 g) of Body TSL | Condition | |
|---|--------------------|--------------------------|
| SAR measured | 100 mW input power | 7.45 W/kg |
| SAR for nominal Body TSL parameters | normalized to 1W | 74.6 W/kg ± 19.9 % (k=2) |

| SAR averaged over 10 cm ³ (10 g) of Body TSL | Condition | |
|---|--------------------|--------------------------|
| SAR measured | 100 mW input power | 2.07 W/kg |
| SAR for nominal Body TSL parameters | normalized to 1W | 20.8 W/kg ± 19.5 % (k=2) |

Unless otherwise stated the results shown in this test report refer only to the sample(s) tested and such sample(s) are retained for 90 days only.

除非另有說明，此報告結果僅對測試之樣品負責，同時此樣品僅保留90天。本報告未經本公司書面許可，不可部份複製。

This document is issued by the Company subject to its General Conditions of Service printed overleaf, available on request or accessible at www.sgs.com/terms_and_conditions.htm and, for electronic format documents, subject to Terms and Conditions for Electronic Documents at www.sgs.com/terms_e-document.htm. Attention is drawn to the limitation of liability, indemnification and jurisdiction issues defined therein. Any holder of this document is advised that information contained hereon reflects the Company's findings at the time of its intervention only and within the limits of Client's instructions, if any. The Company's sole responsibility is to its Client and this document does not exonerate parties to a transaction from exercising all their rights and obligations under the transaction documents. This document cannot be reproduced except in full, without prior written approval of the Company. Any unauthorized alteration, forgery or falsification of the content or appearance of this document is unlawful and offenders may be prosecuted to the fullest extent of the law.

Body TSL parameters at 5600 MHz

The following parameters and calculations were applied:

| | Temperature | Permittivity | Conductivity |
|---|-----------------|--------------|------------------|
| Nominal Body TSL parameters | 22.0 °C | 48.5 | 5.77 mho/m |
| Measured Body TSL parameters | (22.0 ± 0.2) °C | 48.7 ± 6 % | 5.86 mho/m ± 6 % |
| Body TSL temperature change during test | < 0.5 °C | — | — |

SAR result with Body TSL at 5600 MHz

| SAR averaged over 1 cm ³ (1 g) of Body TSL | Condition | |
|---|--------------------|--------------------------|
| SAR measured | 100 mW input power | 7.77 W/kg |
| SAR for nominal Body TSL parameters | normalized to 1W | 77.9 W/kg ± 19.9 % (k=2) |

| SAR averaged over 10 cm ³ (10 g) of Body TSL | condition | |
|---|--------------------|--------------------------|
| SAR measured | 100 mW input power | 2.15 W/kg |
| SAR for nominal Body TSL parameters | normalized to 1W | 21.6 W/kg ± 19.5 % (k=2) |

Body TSL parameters at 5800 MHz

The following parameters and calculations were applied:

| | Temperature | Permittivity | Conductivity |
|---|-----------------|--------------|------------------|
| Nominal Body TSL parameters | 22.0 °C | 48.2 | 5.00 mho/m |
| Measured Body TSL parameters | (22.0 ± 0.2) °C | 48.4 ± 6 % | 6.25 mho/m ± 6 % |
| Body TSL temperature change during test | < 0.5 °C | — | — |

SAR result with Body TSL at 5800 MHz

| SAR averaged over 1 cm ³ (1 g) of Body TSL | Condition | |
|---|--------------------|--------------------------|
| SAR measured | 100 mW input power | 7.54 W/kg |
| SAR for nominal Body TSL parameters | normalized to 1W | 75.6 W/kg ± 19.9 % (k=2) |

| SAR averaged over 10 cm ³ (10 g) of Body TSL | condition | |
|---|--------------------|--------------------------|
| SAR measured | 100 mW input power | 2.07 W/kg |
| SAR for nominal Body TSL parameters | normalized to 1W | 20.7 W/kg ± 19.5 % (k=2) |

Unless otherwise stated the results shown in this test report refer only to the sample(s) tested and such sample(s) are retained for 90 days only.

除非另有說明，此報告結果僅對測試之樣品負責，同時此樣品僅保留90天。本報告未經本公司書面許可，不可部份複製。

This document is issued by the Company subject to its General Conditions of Service printed overleaf, available on request or accessible at www.sgs.com/terms_and_conditions.htm and, for electronic format documents, subject to Terms and Conditions for Electronic Documents at www.sgs.com/terms_e-document.htm. Attention is drawn to the limitation of liability, indemnification and jurisdiction issues defined therein. Any holder of this document is advised that information contained hereon reflects the Company's findings at the time of its intervention only and within the limits of Client's instructions, if any. The Company's sole responsibility is to its Client and this document does not exonerate parties to a transaction from exercising all their rights and obligations under the transaction documents. This document cannot be reproduced except in full, without prior written approval of the Company. Any unauthorized alteration, forgery or falsification of the content or appearance of this document is unlawful and offenders may be prosecuted to the fullest extent of the law.

Appendix (Additional assessments outside the scope of SCS0108)
Antenna Parameters with Head TSL at 5200 MHz

| | |
|--------------------------------------|-----------------|
| Impedance, transformed to feed point | 49.2 Ω - 8.5 jΩ |
| Return Loss | -21.4 dB |

Antenna Parameters with Head TSL at 5300 MHz

| | |
|--------------------------------------|-----------------|
| Impedance, transformed to feed point | 51.0 Ω - 3.8 jΩ |
| Return Loss | -26.2 dB |

Antenna Parameters with Head TSL at 5600 MHz

| | |
|--------------------------------------|-----------------|
| Impedance, transformed to feed point | 53.4 Ω - 2.7 jΩ |
| Return Loss | -27.5 dB |

Antenna Parameters with Head TSL at 5800 MHz

| | |
|--------------------------------------|-----------------|
| Impedance, transformed to feed point | 55.6 Ω + 1.0 jΩ |
| Return Loss | -25.4 dB |

Antenna Parameters with Body TSL at 5200 MHz

| | |
|--------------------------------------|-----------------|
| Impedance, transformed to feed point | 49.0 Ω - 7.1 jΩ |
| Return Loss | -22.8 dB |

Antenna Parameters with Body TSL at 5300 MHz

| | |
|--------------------------------------|-----------------|
| Impedance, transformed to feed point | 51.5 Ω - 2.2 jΩ |
| Return Loss | -31.7 dB |

Antenna Parameters with Body TSL at 5600 MHz

| | |
|--------------------------------------|-----------------|
| Impedance, transformed to feed point | 54.0 Ω - 1.5 jΩ |
| Return Loss | -26.8 dB |

Unless otherwise stated the results shown in this test report refer only to the sample(s) tested and such sample(s) are retained for 90 days only.

除非另有說明，此報告結果僅對測試之樣品負責，同時此樣品僅保留90天。本報告未經本公司書面許可，不可部份複製。

This document is issued by the Company subject to its General Conditions of Service printed overleaf, available on request or accessible at www.sgs.com/terms_and_conditions.htm and, for electronic format documents, subject to Terms and Conditions for Electronic Documents at www.sgs.com/terms_e-document.htm. Attention is drawn to the limitation of liability, indemnification and jurisdiction issues defined therein. Any holder of this document is advised that information contained hereon reflects the Company's findings at the time of its intervention only and within the limits of Client's instructions, if any. The Company's sole responsibility is to its Client and this document does not exonerate parties to a transaction from exercising all their rights and obligations under the transaction documents. This document cannot be reproduced except in full, without prior written approval of the Company. Any unauthorized alteration, forgery or falsification of the content or appearance of this document is unlawful and offenders may be prosecuted to the fullest extent of the law.

Antenna Parameters with Body TSL at 5800 MHz

| | |
|--------------------------------------|-----------------|
| Impedance, transformed to feed point | 55.8 Ω + 2.8 jΩ |
| Return Loss | > 24.5 dB |

General Antenna Parameters and Design

| | |
|----------------------------------|----------|
| Electrical Delay (one direction) | 1.199 ns |
|----------------------------------|----------|

After long term use with 100W radiated power, only a slight warming of the dipole near the feedpoint can be measured.

The dipole is made of standard semirigid coaxial cable. The center conductor of the feeding line is directly connected to the second arm of the dipole. The antenna is therefore short-circuited for DC-signals. On some of the dipoles, small end caps are added to the dipole arms in order to improve matching when loaded according to the position as explained in the 'Measurement Conditions' paragraph. The SAR data are not affected by this change. The overall dipole length is still according to the Standard.

No excessive force must be applied to the dipole arms, because they might bend or the soldered connections near the feedpoint may be damaged.

Additional EUT Data

| | |
|-----------------|-------------------|
| Manufactured by | SPEAG |
| Manufactured on | February 05, 2004 |

Unless otherwise stated the results shown in this test report refer only to the sample(s) tested and such sample(s) are retained for 90 days only.

除非另有說明，此報告結果僅對測試之樣品負責，同時此樣品僅保留90天。本報告未經本公司書面許可，不可部份複製。

This document is issued by the Company subject to its General Conditions of Service printed overleaf, available on request or accessible at www.sgs.com/terms_and_conditions.htm and, for electronic format documents, subject to Terms and Conditions for Electronic Documents at www.sgs.com/terms_e-document.htm. Attention is drawn to the limitation of liability, indemnification and jurisdiction issues defined therein. Any holder of this document is advised that information contained hereon reflects the Company's findings at the time of its intervention only and within the limits of Client's instructions, if any. The Company's sole responsibility is to its Client and this document does not exonerate parties to a transaction from exercising all their rights and obligations under the transaction documents. This document cannot be reproduced except in full, without prior written approval of the Company. Any unauthorized alteration, forgery or falsification of the content or appearance of this document is unlawful and offenders may be prosecuted to the fullest extent of the law.

DASY5 Validation Report for Head TSL

Date: 28/01/2015

Test Laboratory: SPEAG, Zurich, Switzerland

DUT: Dipole 5GHz; Type: D5GHzV2; Serial: D5GHzV2 - SN:1023

Communication System: UID 0 - CW; Frequency: 5200 MHz, Frequency: 5300 MHz, Frequency: 5600 MHz, Frequency: 5800 MHz

Medium parameters used: $f = 5200$ MHz; $\sigma = 4.56$ S/m; $\epsilon_r = 36.5$; $\rho = 1000$ kg/m³, Medium parameters used: $f = 5300$ MHz; $\sigma = 4.66$ S/m; $\epsilon_r = 36.1$; $\rho = 1000$ kg/m³, Medium parameters used: $f = 5600$ MHz; $\sigma = 4.97$ S/m; $\epsilon_r = 35.7$; $\rho = 1000$ kg/m³, Medium parameters used: $f = 5800$ MHz; $\sigma = 5.18$ S/m; $\epsilon_r = 35.4$; $\rho = 1000$ kg/m³

Phantom section: Flat Section

Measurement Standard: DASY5 (IEEE/IEC/ANSI C63.19-2011)

DASY52 Configuration:

- Probe: EX3DV4 - SN3503; ConvF(5.51, 5.51, 5.51); Calibrated: 30.12.2014, ConvF(5.21, 5.21, 5.21); Calibrated: 30.12.2014, ConvF(4.92, 4.92, 4.92); Calibrated: 30.12.2014, ConvF(4.9, 4.9, 4.9); Calibrated: 30.12.2014;
- Sensor-Surface: 1.4mm (Mechanical Surface Detection)
- Electronics: DAE4 Sn601; Calibrated: 18.08.2014
- Phantom: Flat Phantom 5.0 (front); Type: QD000P50AA; Serial: 1001
- DASY52 52.8.8(1222); SEMCAD X 14.6.10(7331)

Dipole Calibration for Head Tissue/Pin=100mW, dist=10mm, f=5200 MHz/Zoom Scan, dist=1.4mm (8x8x7)/Cube 0: Measurement grid: dx=4mm, dy=4mm, dz=1.4mm
Reference Value = 64.14 V/m; Power Drift = 0.07 dB
Peak SAR (extrapolated) = 28.3 W/kg
SAR(1 g) = 7.78 W/kg; SAR(10 g) = 2.22 W/kg
Maximum value of SAR (measured) = 17.8 W/kg

Dipole Calibration for Head Tissue/Pin=100mW, dist=10mm, f=5300 MHz/Zoom Scan, dist=1.4mm (8x8x7)/Cube 0: Measurement grid: dx=4mm, dy=4mm, dz=1.4mm
Reference Value = 65.47 V/m; Power Drift = 0.05 dB
Peak SAR (extrapolated) = 30.7 W/kg
SAR(1 g) = 8.17 W/kg; SAR(10 g) = 2.34 W/kg
Maximum value of SAR (measured) = 18.6 W/kg

Dipole Calibration for Head Tissue/Pin=100mW, dist=10mm, f=5600 MHz/Zoom Scan, dist=1.4mm (8x8x7)/Cube 0: Measurement grid: dx=4mm, dy=4mm, dz=1.4mm
Reference Value = 63.68 V/m; Power Drift = 0.08 dB
Peak SAR (extrapolated) = 32.2 W/kg
SAR(1 g) = 8.14 W/kg; SAR(10 g) = 2.31 W/kg
Maximum value of SAR (measured) = 18.9 W/kg

Unless otherwise stated the results shown in this test report refer only to the sample(s) tested and such sample(s) are retained for 90 days only.

除非另有說明，此報告結果僅對測試之樣品負責，同時此樣品僅保留90天。本報告未經本公司書面許可，不可部份複製。

This document is issued by the Company subject to its General Conditions of Service printed overleaf, available on request or accessible at www.sgs.com/terms_and_conditions.htm and, for electronic format documents, subject to Terms and Conditions for Electronic Documents at www.sgs.com/terms_e-document.htm. Attention is drawn to the limitation of liability, indemnification and jurisdiction issues defined therein. Any holder of this document is advised that information contained hereon reflects the Company's findings at the time of its intervention only and within the limits of Client's instructions, if any. The Company's sole responsibility is to its Client and this document does not exonerate parties to a transaction from exercising all their rights and obligations under the transaction documents. This document cannot be reproduced except in full, without prior written approval of the Company. Any unauthorized alteration, forgery or falsification of the content or appearance of this document is unlawful and offenders may be prosecuted to the fullest extent of the law.

Dipole Calibration for Head Tissue/Pin=100mW, dist=10mm, f=5800 MHz/Zoom Scan, dist=1.4mm (8x8x7)/Cube 0: Measurement grid: dx=4mm, dy=4mm, dz=1.4mm
 Reference Value = 61.76 V/m; Power Drift = 0.06 dB
 Peak SAR (extrapolated) = 32.0 W/kg
 SAR(1 g) = 7.82 W/kg; SAR(10 g) = 2.23 W/kg
 Maximum value of SAR (measured) = 18.4 W/kg

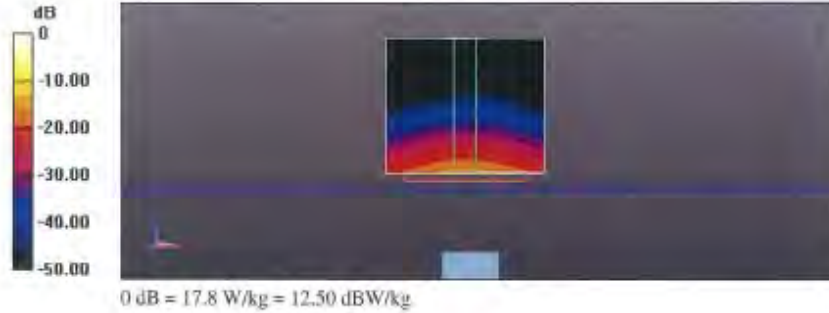

Unless otherwise stated the results shown in this test report refer only to the sample(s) tested and such sample(s) are retained for 90 days only.

除非另有說明，此報告結果僅對測試之樣品負責，同時此樣品僅保留90天。本報告未經本公司書面許可，不可部份複製。

This document is issued by the Company subject to its General Conditions of Service printed overleaf, available on request or accessible at www.sgs.com/terms_and_conditions.htm and, for electronic format documents, subject to Terms and Conditions for Electronic Documents at www.sgs.com/terms_e-document.htm. Attention is drawn to the limitation of liability, indemnification and jurisdiction issues defined therein. Any holder of this document is advised that information contained hereon reflects the Company's findings at the time of its intervention only and within the limits of Client's instructions, if any. The Company's sole responsibility is to its Client and this document does not exonerate parties to a transaction from exercising all their rights and obligations under the transaction documents. This document cannot be reproduced except in full, without prior written approval of the Company. Any unauthorized alteration, forgery or falsification of the content or appearance of this document is unlawful and offenders may be prosecuted to the fullest extent of the law.

Impedance Measurement Plot for Head TSL

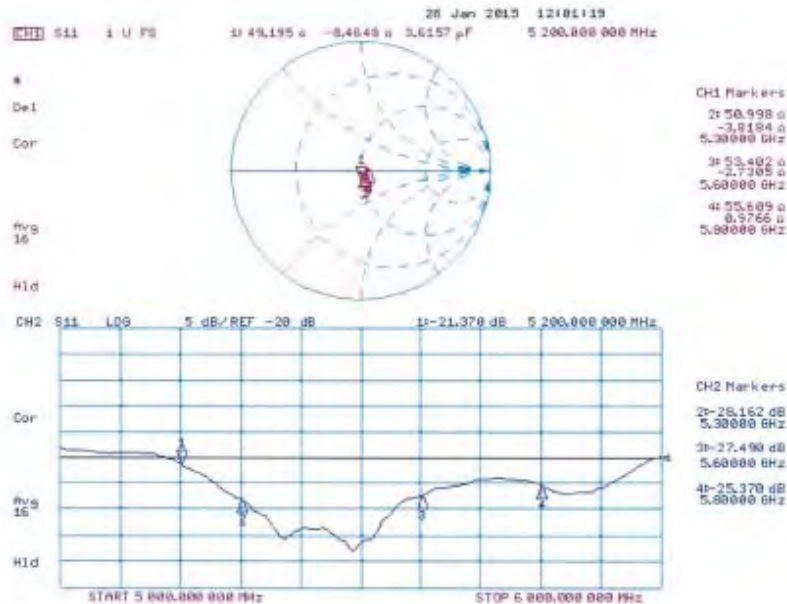

Unless otherwise stated the results shown in this test report refer only to the sample(s) tested and such sample(s) are retained for 90 days only.

除非另有說明，此報告結果僅對測試之樣品負責，同時此樣品僅保留90天。本報告未經本公司書面許可，不可部份複製。

This document is issued by the Company subject to its General Conditions of Service printed overleaf, available on request or accessible at www.sgs.com/terms_and_conditions.htm and, for electronic format documents, subject to Terms and Conditions for Electronic Documents at www.sgs.com/terms_e-document.htm. Attention is drawn to the limitation of liability, indemnification and jurisdiction issues defined therein. Any holder of this document is advised that information contained hereon reflects the Company's findings at the time of its intervention only and within the limits of Client's instructions, if any. The Company's sole responsibility is to its Client and this document does not exonerate parties to a transaction from exercising all their rights and obligations under the transaction documents. This document cannot be reproduced except in full, without prior written approval of the Company. Any unauthorized alteration, forgery or falsification of the content or appearance of this document is unlawful and offenders may be prosecuted to the fullest extent of the law.

DASY5 Validation Report for Body TSL

Date: 29.01.2015

Test Laboratory: SPEAG, Zurich, Switzerland

DUT: Dipole 5GHz; Type: D5GHzV2; Serial: D5GHzV2 - SN:1023

Communication System: UID 0 - CW; Frequency: 5200 MHz; Frequency: 5300 MHz; Frequency: 5600 MHz; Frequency: 5800 MHz

Medium parameters used: $f = 5200$ MHz; $\sigma = 3.42$ S/m; $\epsilon_r = 49.4$; $\rho = 1000$ kg/m³; Medium parameters used: $f = 5300$ MHz; $\sigma = 5.55$ S/m; $\epsilon_r = 49.2$; $\rho = 1000$ kg/m³; Medium parameters used: $f = 5600$ MHz; $\sigma = 5.96$ S/m; $\epsilon_r = 48.7$; $\rho = 1000$ kg/m³; Medium parameters used: $f = 5800$ MHz; $\sigma = 6.25$ S/m; $\epsilon_r = 48.4$; $\rho = 1000$ kg/m³

Phantom section: Flat Section

Measurement Standard: DASY5 (IEEE/IEC/ANSI C63.19-2011)

DASY52 Configuration:

- Probe: EX3DV4 - SN3503; ConvF(4.95, 4.95, 4.95); Calibrated: 30.12.2014, ConvF(4.78, 4.78, 4.78); Calibrated: 30.12.2014, ConvF(4.35, 4.35, 4.35); Calibrated: 30.12.2014, ConvF(4.32, 4.32, 4.32); Calibrated: 30.12.2014.
- Sensor-Surface: 1.4mm (Mechanical Surface Detection)
- Electronics: DAE4-Sn601; Calibrated: 18.08.2014
- Phantom: Flat Phantom 3.0 (back); Type: QD000P50AA; Serial: 1002
- DASY52 52.8.8(1222); SEMCAD X 14.6.10(7331)

Dipole Calibration for Body Tissue/Pin=100mW, dist=10mm, f=5200 MHz/Zoom Scan, dist=1.4mm (8x8x7)/Cube 0: Measurement grid: dx=4mm, dy=4mm, dz=1.4mm
Reference Value = 57.97 V/m; Power Drift = -0.02 dB
Peak SAR (extrapolated) = 28.6 W/kg
SAR(1 g) = 7.33 W/kg; SAR(10 g) = 2.04 W/kg
Maximum value of SAR (measured) = 17.3 W/kg

Dipole Calibration for Body Tissue/Pin=100mW, dist=10mm, f=5300 MHz/Zoom Scan, dist=1.4mm (8x8x7)/Cube 0: Measurement grid: dx=4mm, dy=4mm, dz=1.4mm
Reference Value = 57.58 V/m; Power Drift = -0.06 dB
Peak SAR (extrapolated) = 30.0 W/kg
SAR(1 g) = 7.45 W/kg; SAR(10 g) = 2.07 W/kg
Maximum value of SAR (measured) = 17.8 W/kg

Dipole Calibration for Body Tissue/Pin=100mW, dist=10mm, f=5600 MHz/Zoom Scan, dist=1.4mm (8x8x7)/Cube 0: Measurement grid: dx=4mm, dy=4mm, dz=1.4mm
Reference Value = 56.88 V/m; Power Drift = 0.06 dB
Peak SAR (extrapolated) = 34.4 W/kg
SAR(1 g) = 7.77 W/kg; SAR(10 g) = 2.15 W/kg
Maximum value of SAR (measured) = 19.3 W/kg

Unless otherwise stated the results shown in this test report refer only to the sample(s) tested and such sample(s) are retained for 90 days only.

除非另有說明，此報告結果僅對測試之樣品負責，同時此樣品僅保留90天。本報告未經本公司書面許可，不可部份複製。

This document is issued by the Company subject to its General Conditions of Service printed overleaf, available on request or accessible at www.sgs.com/terms_and_conditions.htm and, for electronic format documents, subject to Terms and Conditions for Electronic Documents at www.sgs.com/terms_e-document.htm. Attention is drawn to the limitation of liability, indemnification and jurisdiction issues defined therein. Any holder of this document is advised that information contained hereon reflects the Company's findings at the time of its intervention only and within the limits of Client's instructions, if any. The Company's sole responsibility is to its Client and this document does not exonerate parties to a transaction from exercising all their rights and obligations under the transaction documents. This document cannot be reproduced except in full, without prior written approval of the Company. Any unauthorized alteration, forgery or falsification of the content or appearance of this document is unlawful and offenders may be prosecuted to the fullest extent of the law.

Dipole Calibration for Body Tissue/Pin=100mW, dist=10mm, f=5800 MHz/Zoom Scan, dist=1.4mm (8x8x7)/Cube 0: Measurement grid: dx=4mm, dy=4mm, dz=1.4mm
Reference Value = 55.10 V/m; Power Drift = 0.05 dB
Peak SAR (extrapolated) = 35.2 W/kg
SAR(1 g) = 7.54 W/kg; SAR(10 g) = 2.07 W/kg
Maximum value of SAR (measured) = 19.1 W/kg

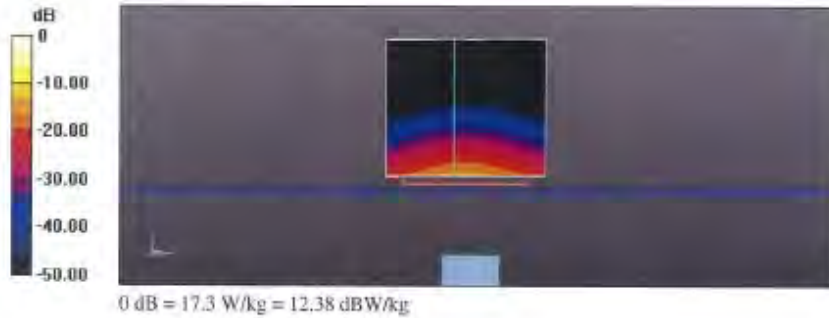

Unless otherwise stated the results shown in this test report refer only to the sample(s) tested and such sample(s) are retained for 90 days only.

除非另有說明，此報告結果僅對測試之樣品負責，同時此樣品僅保留90天。本報告未經本公司書面許可，不可部份複製。

This document is issued by the Company subject to its General Conditions of Service printed overleaf, available on request or accessible at www.sgs.com/terms_and_conditions.htm and, for electronic format documents, subject to Terms and Conditions for Electronic Documents at www.sgs.com/terms_e-document.htm. Attention is drawn to the limitation of liability, indemnification and jurisdiction issues defined therein. Any holder of this document is advised that information contained hereon reflects the Company's findings at the time of its intervention only and within the limits of Client's instructions, if any. The Company's sole responsibility is to its Client and this document does not exonerate parties to a transaction from exercising all their rights and obligations under the transaction documents. This document cannot be reproduced except in full, without prior written approval of the Company. Any unauthorized alteration, forgery or falsification of the content or appearance of this document is unlawful and offenders may be prosecuted to the fullest extent of the law.

Impedance Measurement Plot for Body TSL

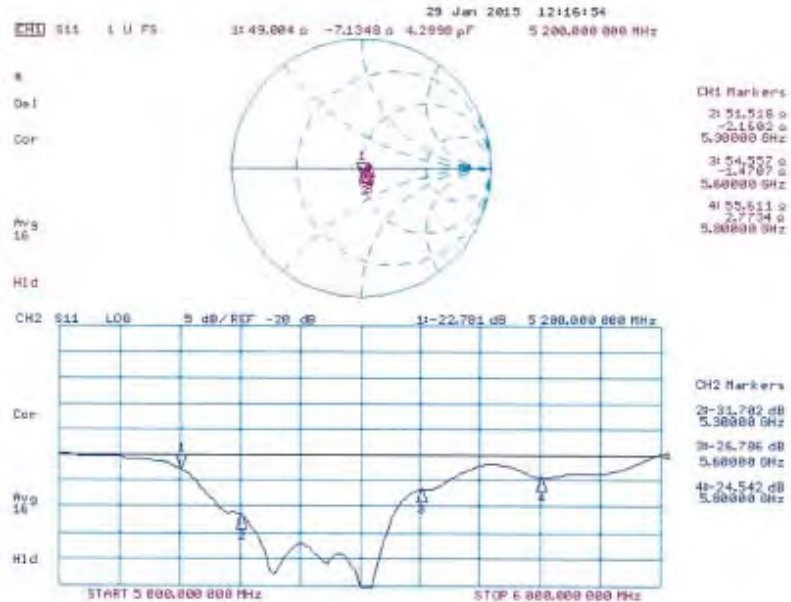

- End of 1st part of report -

Unless otherwise stated the results shown in this test report refer only to the sample(s) tested and such sample(s) are retained for 90 days only.

除非另有說明，此報告結果僅對測試之樣品負責，同時此樣品僅保留90天。本報告未經本公司書面許可，不可部份複製。

This document is issued by the Company subject to its General Conditions of Service printed overleaf, available on request or accessible at www.sgs.com/terms_and_conditions.htm and, for electronic format documents, subject to Terms and Conditions for Electronic Documents at www.sgs.com/terms_e-document.htm. Attention is drawn to the limitation of liability, indemnification and jurisdiction issues defined therein. Any holder of this document is advised that information contained hereon reflects the Company's findings at the time of its intervention only and within the limits of Client's instructions, if any. The Company's sole responsibility is to its Client and this document does not exonerate parties to a transaction from exercising all their rights and obligations under the transaction documents. This document cannot be reproduced except in full, without prior written approval of the Company. Any unauthorized alteration, forgery or falsification of the content or appearance of this document is unlawful and offenders may be prosecuted to the fullest extent of the law.