



FCC RF Test Report

APPLICANT : UNIVERSAL GLOBAL SCIENTIFIC INDUSTRIAL CO., LTD.
EQUIPMENT : Wireless IoT module
BRAND NAME : UGSI
MODEL NAME : WM-BN-BM-22
FCC ID : COFWMBNBM22
STANDARD : FCC Part 15 Subpart C §15.247
CLASSIFICATION : (DTS) Digital Transmission System

The product was received on Feb. 22, 2018 and testing was completed on Mar. 28, 2018. We, SPORTON INTERNATIONAL INC., would like to declare that the tested sample has been evaluated in accordance with the test procedures and has been in compliance with the applicable technical standards.

The test results in this report apply exclusively to the tested model / sample. Without written approval of SPORTON INTERNATIONAL INC., the test report shall not be reproduced except in full.

Reviewed by: Joseph Lin / Supervisor

Approved by: Jones Tsai / Manager



SPORTON INTERNATIONAL INC.

No. 52, Hwa Ya 1st Rd., Hwa Ya Technology Park, Kwei-Shan District, Tao Yuan City, Taiwan, R.O.C.

SPORTON INTERNATIONAL INC.

TEL : 886-3-327-3456

FAX : 886-3-328-4978

FCC ID: COFWMBNBM22

Page Number : 1 of 35

Report Issued Date : Mar. 29, 2018

Report Version : Rev. 02

Report Template No.: BU5-FR15CWLAC MA Version 2.0



TABLE OF CONTENTS

REVISION HISTORY..... 3

SUMMARY OF TEST RESULT 4

1 GENERAL DESCRIPTION 5

 1.1 Applicant 5

 1.2 Manufacturer 5

 1.3 Product Feature of Equipment Under Test..... 5

 1.4 Modification of EUT 5

 1.5 Testing Location 5

 1.6 Applicable Standards 6

2 TEST CONFIGURATION OF EQUIPMENT UNDER TEST 7

 2.1 Carrier Frequency and Channel 7

 2.2 Test Mode 7

 2.3 Connection Diagram of Test System 8

 2.4 Support Unit used in test configuration and system 9

 2.5 EUT Operation Test Setup 9

 2.6 Measurement Results Explanation Example 10

3 TEST RESULT 11

 3.1 6dB and 99% Bandwidth Measurement 11

 3.2 Output Power Measurement 13

 3.3 Power Spectral Density Measurement 14

 3.4 Conducted Band Edges and Spurious Emission Measurement 16

 3.5 Radiated Band Edges and Spurious Emission Measurement 26

 3.6 AC Conducted Emission Measurement 30

 3.7 Antenna Requirements 33

4 LIST OF MEASURING EQUIPMENT 34

5 UNCERTAINTY OF EVALUATION 35

APPENDIX A. CONDUCTED TEST RESULTS

APPENDIX B. AC CONDUCTED EMISSION TEST RESULT

APPENDIX C. RADIATED SPURIOUS EMISSION

APPENDIX D. RADIATED SPURIOUS EMISSION PLOTS

APPENDIX E. DUTY CYCLE PLOTS

APPENDIX F. SETUP PHOTOGRAPHS



SUMMARY OF TEST RESULT

Report Section	FCC Rule	Description	Limit	Result	Remark
3.1	15.247(a)(2)	6dB Bandwidth	$\geq 0.5\text{MHz}$	Pass	-
3.1	-	99% Bandwidth	-	Pass	-
3.2	15.247(b)	Power Output Measurement	$\leq 30\text{dBm}$	Pass	-
3.3	15.247(e)	Power Spectral Density	$\leq 8\text{dBm}/3\text{kHz}$	Pass	-
3.4	15.247(d)	Conducted Band Edges	$\leq 20\text{dBc}$	Pass	-
		Conducted Spurious Emission		Pass	-
3.5	15.247(d)	Radiated Band Edges and Radiated Spurious Emission	15.209(a) & 15.247(d)	Pass	Under limit 2.51 dB at 2386.335 MHz
3.6	15.207	AC Conducted Emission	15.207(a)	Pass	Under limit 14.52 dB at 0.542 MHz
3.7	15.203 & 15.247(b)	Antenna Requirement	N/A	Pass	-



1 General Description

1.1 Applicant

UNIVERSAL GLOBAL SCIENTIFIC INDUSTRIAL CO., LTD.
141, Lane 351, Sec. 1, Taiping Road., Tsaotuen, Nantou 54261, Taiwan

1.2 Manufacturer

UNIVERSAL GLOBAL SCIENTIFIC INDUSTRIAL CO., LTD.
141, Lane 351, Sec. 1, Taiping Road., Tsaotuen, Nantou 54261, Taiwan

1.3 Product Feature of Equipment Under Test

Bluetooth and Wi-Fi 2.4GHz 802.11b/g/n

Product Specification subjective to this standard	
Antenna Type	WLAN: PIFA Antenna Bluetooth: PIFA Antenna

1.4 Modification of EUT

No modifications are made to the EUT during all test items.

1.5 Testing Location

Sporton Lab is accredited to ISO 17025 by Taiwan Accreditation Foundation (TAF code : 1190) and the FCC designation No. TW1190 and TW0007 under the FCC 2.948(e) by Mutual Recognition Agreement (MRA) in FCC Test.

Test Site	SPORTON INTERNATIONAL INC.	
Test Site Location	No. 52, Hwa Ya 1 st Rd., Hwa Ya Technology Park, Kwei-Shan District, Tao Yuan City, Taiwan, R.O.C. TEL: +886-3-327-3456 FAX: +886-3-328-4978	
Test Site No.	Sporton Site No.	
	TH05-HY	CO05-HY

Note: The test site complies with ANSI C63.4 2014 requirement.

Test Site	SPORTON INTERNATIONAL INC.	
Test Site Location	No.58, Aly. 75, Ln. 564, Wenhua 3rd Rd. Guishan Dist, Taoyuan City, Taiwan (R.O.C.) TEL: +886-3-327-0868 FAX: +886-3-327-0855	
Test Site No.	Sporton Site No.	
	03CH12-HY	

Note: The test site complies with ANSI C63.4 2014 requirement.



1.6 Applicable Standards

According to the specifications of the manufacturer, the EUT must comply with the requirements of the following standards:

- ♦ FCC Part 15 Subpart C §15.247
- ♦ FCC KDB Publication No. 558074 D01 DTS Meas. Guidance v04
- ♦ ANSI C63.10-2013

Remark:

1. All test items were verified and recorded according to the standards and without any deviation during the test.
2. This EUT has also been tested and complied with the requirements of FCC Part 15, Subpart B, recorded in a separate test report.



2 Test Configuration of Equipment Under Test

- a. The EUT has been associated with peripherals and configuration operated in a manner tended to maximize its emission characteristics in a typical application. Frequency range investigated: conduction emission (150 kHz to 30 MHz), radiation emission (9 kHz to the 10th harmonic of the highest fundamental frequency or to 40 GHz, whichever is lower). For radiated measurement, pre-scanned in three orthogonal panels, X, Y, Z. The worst cases (X plane) were recorded in this report.
- b. AC power line Conducted Emission was tested under maximum output power.

2.1 Carrier Frequency and Channel

Frequency Band	Channel	Freq. (MHz)	Channel	Freq. (MHz)
2400-2483.5 MHz	1	2412	7	2442
	2	2417	8	2447
	3	2422	9	2452
	4	2427	10	2457
	5	2432	11	2462
	6	2437		

2.2 Test Mode

Final test modes are considering the modulation and worse data rates as below table.

Modulation	Data Rate
802.11b	1 Mbps
802.11g	6 Mbps
802.11n HT20	MCS0

Test Cases	
AC Conducted Emission	Mode 1 :Bluetooth Link + USB Cable (Charging from Notebook) Mode 2 WLAN Link + USB Cable (Charging from Notebook)
Remark: The worst case of conducted emission is mode 2; only the test data of it was reported.	

2.3 Connection Diagram of Test System

<WLAN Tx Mode>

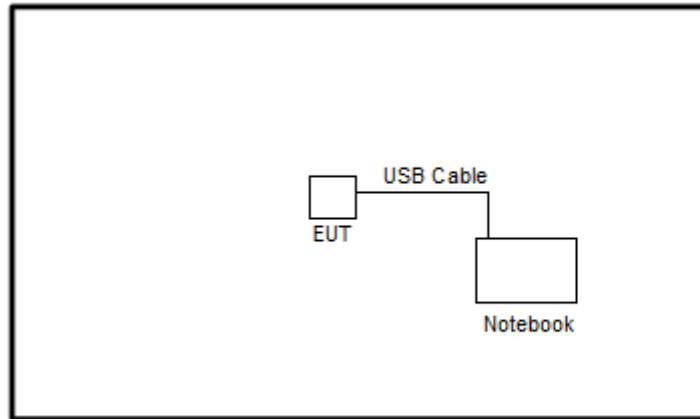

<AC Conducted Emission Mode in Bluetooth Link>

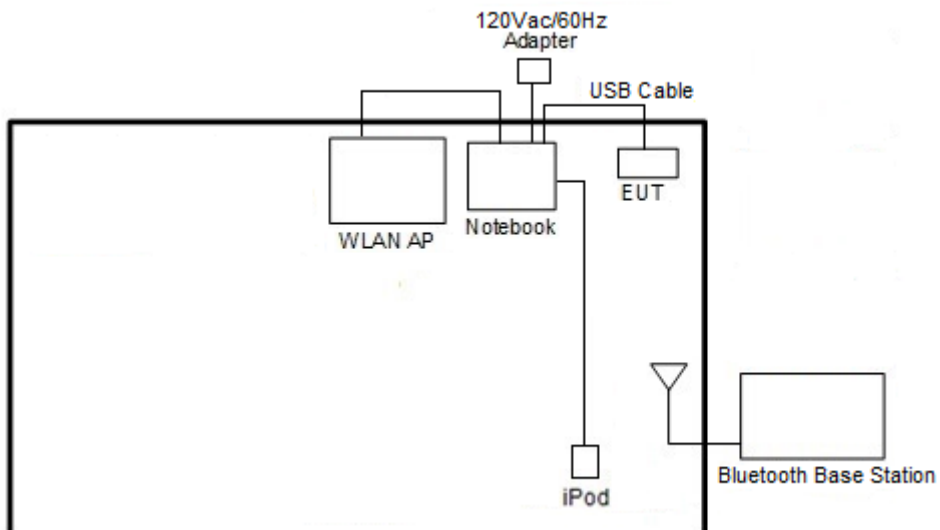

<AC Conducted Emission Mode in WLAN Link>

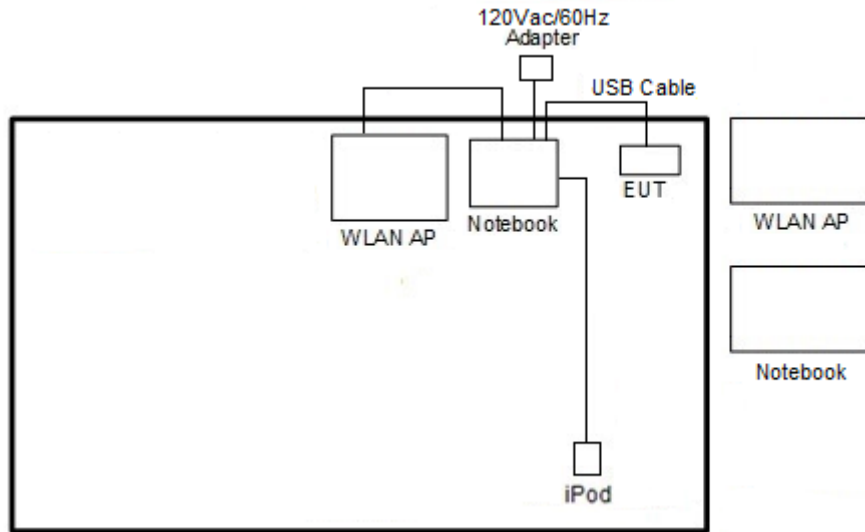

2.4 Support Unit used in test configuration and system

Item	Equipment	Trade Name	Model Name	FCC ID	Data Cable	Power Cord
1.	Bluetooth Base Station	R&S	CBT32	N/A	N/A	Unshielded, 1.8 m
2.	WLAN AP	ASUS	RT-AC66U	MSQ-RTAC66U	N/A	Unshielded, 1.8 m
3.	Notebook	Lenovo	E335	FCC DoC	N/A	AC I/P: Unshielded, 1.2 m DC O/P: Shielded, 1.8 m
4.	Notebook	DELL	Latitude E6320	FCC DoC/ Contains FCC ID: QDS-BRCM1054	N/A	AC I/P: Unshielded, 1.2 m DC O/P: Shielded, 1.8 m
5.	iPod	Apple	A1285	FCC DoC	Shielded, 1.0 m	N/A
6.	Cable	MTJ	MT18A-600	N/A	N/A	N/A

2.5 EUT Operation Test Setup

The RF test items, the test programme was installed in Notebook which was programmed in order to make the EUT get into the engineering modes to provide channel selection, power level, data rate and the application type and for continuous transmitting signals.



2.6 Measurement Results Explanation Example

For all conducted test items:

The offset level is set in the spectrum analyzer to compensate the RF cable loss and attenuator factor between EUT conducted output port and spectrum analyzer. With the offset compensation, the spectrum analyzer reading level is exactly the EUT RF output level.

Example:

The spectrum analyzer offset is derived from RF cable loss and attenuator factor.

Offset = RF cable loss + attenuator factor.

Following shows an offset computation example with cable loss 4.2 dB and 10dB attenuator.

$$\begin{aligned} \text{Offset(dB)} &= \text{RF cable loss(dB)} + \text{attenuator factor(dB)}. \\ &= 4.2 + 10 = 14.2 \text{ (dB)} \end{aligned}$$

3 Test Result

3.1 6dB and 99% Bandwidth Measurement

3.1.1 Limit of 6dB and 99% Bandwidth

The minimum 6 dB bandwidth shall be at least 500 kHz.

3.1.2 Measuring Instruments

The measuring equipment is listed in the section 4 of this test report.

3.1.3 Test Procedures

1. The testing follows FCC KDB Publication No. 558074 DTS D01 Meas. Guidance v04.
2. The RF output of EUT was connected to the spectrum analyzer by RF cable and attenuator. The path loss was compensated to the results for each measurement.
3. Set to the maximum power setting and enable the EUT transmit continuously.
4. Make the measurement with the spectrum analyzer's resolution bandwidth (RBW) = 100 kHz. Set the Video bandwidth (VBW) = 300 kHz. In order to make an accurate measurement. The 6 dB bandwidth must be greater than 500 kHz.
5. For 99% Bandwidth Measurement, the spectrum analyzer's resolution bandwidth (RBW) = 1MHz and set the Video bandwidth (VBW) = 3MHz.
6. Measure and record the results in the test report.

3.1.4 Test Setup

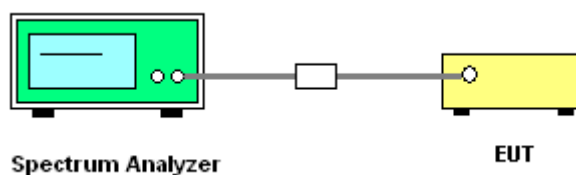



3.1.5 Test Result of 6dB and 99% Occupied Bandwidth

Please refer to Appendix A.

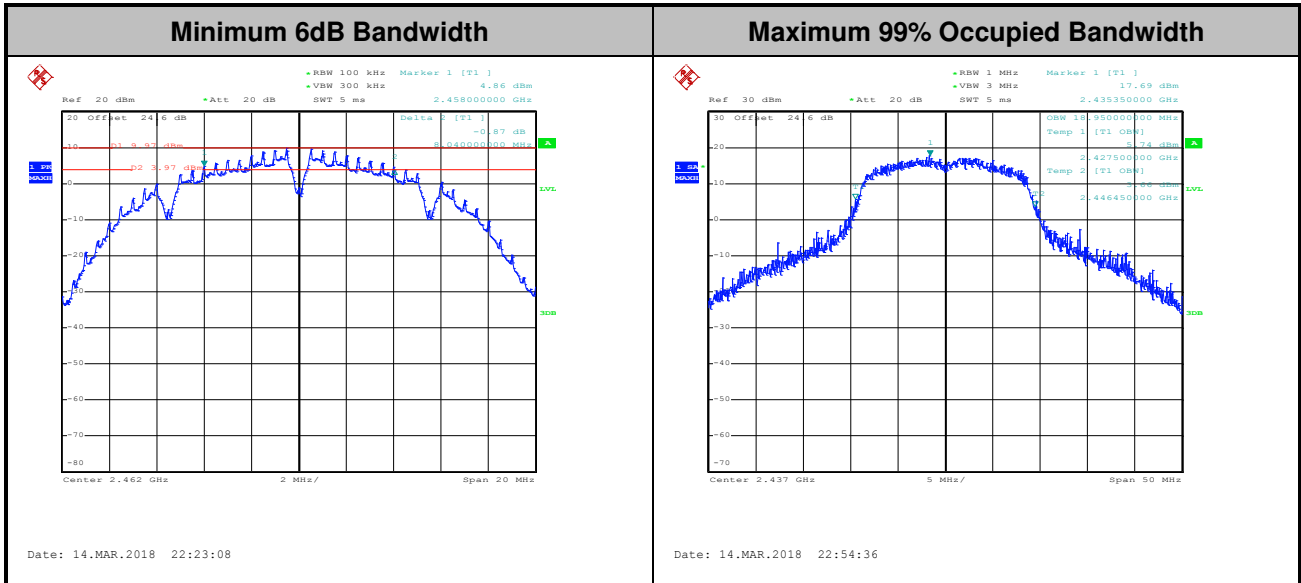

Note : The occupied channel bandwidth is maintained within the band of operation for all of the modulations.

3.2 Output Power Measurement

3.2.1 Limit of Output Power

For systems using digital modulation in the 2400-2483.5MHz, the limit for peak output power is 30dBm. If transmitting antenna with directional gain greater than 6dBi is used, the peak output power from the intentional radiator shall be reduced below the above stated value by the amount in dB that the directional gain of the antenna exceeds 6 dBi. In case of point-to-point operation, the limit has to be reduced by 1dB for every 3dB that the directional gain of the antenna exceeds 6dBi.

3.2.2 Measuring Instruments

The measuring equipment is listed in the section 4 of this test report.

3.2.3 Test Procedures

1. The testing follows the Measurement Procedure of FCC KDB No. 558074 DTS D01 Meas. Guidance v04 section 9.1.3 PKPM1 Peak power meter method.
2. The RF output of EUT was connected to the power meter by RF cable and attenuator. The path loss was compensated to the results for each measurement.
3. Set to the maximum power setting and enable the EUT transmit continuously.
4. Measure the conducted output power and record the results in the test report.

3.2.4 Test Setup

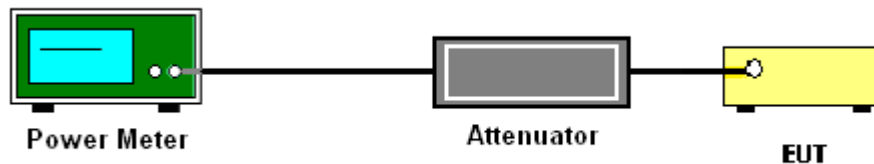

3.2.5 Test Result of Peak Output Power

Please refer to Appendix A.

3.2.6 Test Result of Average output Power (Reporting Only)

Please refer to Appendix A.

3.3 Power Spectral Density Measurement

3.3.1 Limit of Power Spectral Density

The peak power spectral density shall not be greater than 8dBm in any 3kHz band at any time interval of continuous transmission.

3.3.2 Measuring Instruments

The measuring equipment is listed in the section 4 of this test report.

3.3.3 Test Procedures

1. The testing follows Measurement Procedure 10.2 Method PKPSD of FCC KDB Publication No. 558074 D01 DTS Meas. Guidance v04
2. The RF output of EUT was connected to the spectrum analyzer by RF cable and attenuator. The path loss was compensated to the results for each measurement.
3. Set to the maximum power setting and enable the EUT transmit continuously.
4. Make the measurement with the spectrum analyzer's resolution bandwidth (RBW) = 3 kHz. Video bandwidth VBW = 10 kHz In order to make an accurate measurement, set the span to 1.5 times DTS Channel Bandwidth. (6dB BW)
5. Detector = peak, Sweep time = auto couple, Trace mode = max hold, Allow trace to fully stabilize. Use the peak marker function to determine the maximum power level.
6. Measure and record the results in the test report.

3.3.4 Test Setup





3.3.5 Test Result of Power Spectral Density

Please refer to Appendix A.

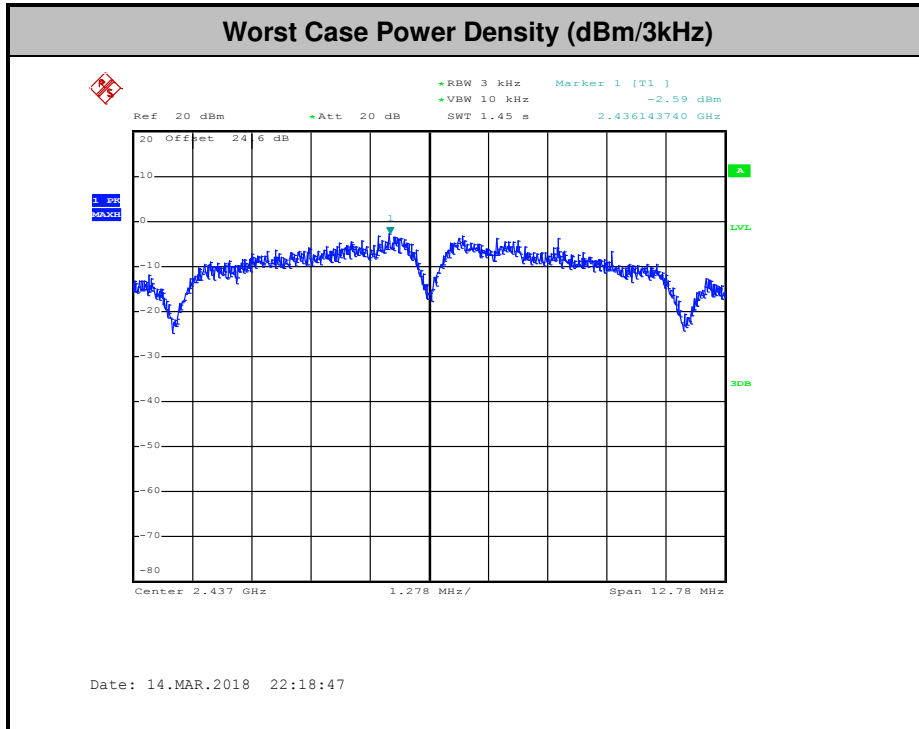

3.4 Conducted Band Edges and Spurious Emission Measurement

3.4.1 Limit of Conducted Band Edges and Spurious Emission Measurement

In any 100 kHz bandwidth outside of the authorized frequency band, the emissions which fall in the non-restricted bands shall be attenuated at least 20 dB / 30dB relative to the maximum PSD level in 100 kHz by RF conducted measurement.

3.4.2 Measuring Instruments

The measuring equipment is listed in the section 4 of this test report.

3.4.3 Test Procedures

1. The testing follows FCC KDB Publication No. 558074 D01 DTS Meas. Guidance v04.
2. The RF output of EUT was connected to the spectrum analyzer by RF cable and attenuator. The path loss was compensated to the results for each measurement.
3. Set to the maximum power setting and enable the EUT transmit continuously.
4. Set RBW = 100 kHz, VBW=300 kHz, Peak Detector. Unwanted Emissions measured in any 100 kHz bandwidth outside of the authorized frequency band shall be attenuated by at least 20 dB relative to the maximum in-band peak PSD level in 100 kHz when maximum peak conducted output power procedure is used. If the transmitter complies with the conducted power limits based on the use of RMS averaging over a time interval, the attenuation required under this paragraph shall be 30 dB instead of 20 dB per 15.247(d).
5. Measure and record the results in the test report.
6. The RF fundamental frequency should be excluded against the limit line in the operating frequency band.

3.4.4 Test Setup





3.4.5 Test Result of Conducted Band Edges and Spurious Emission

Test Engineer : White Lin and Lena Ho	Temperature :	21~25°C
	Relative Humidity :	51~54%

Test Mode :	802.11b	Test Channel :	01
-------------	---------	----------------	----

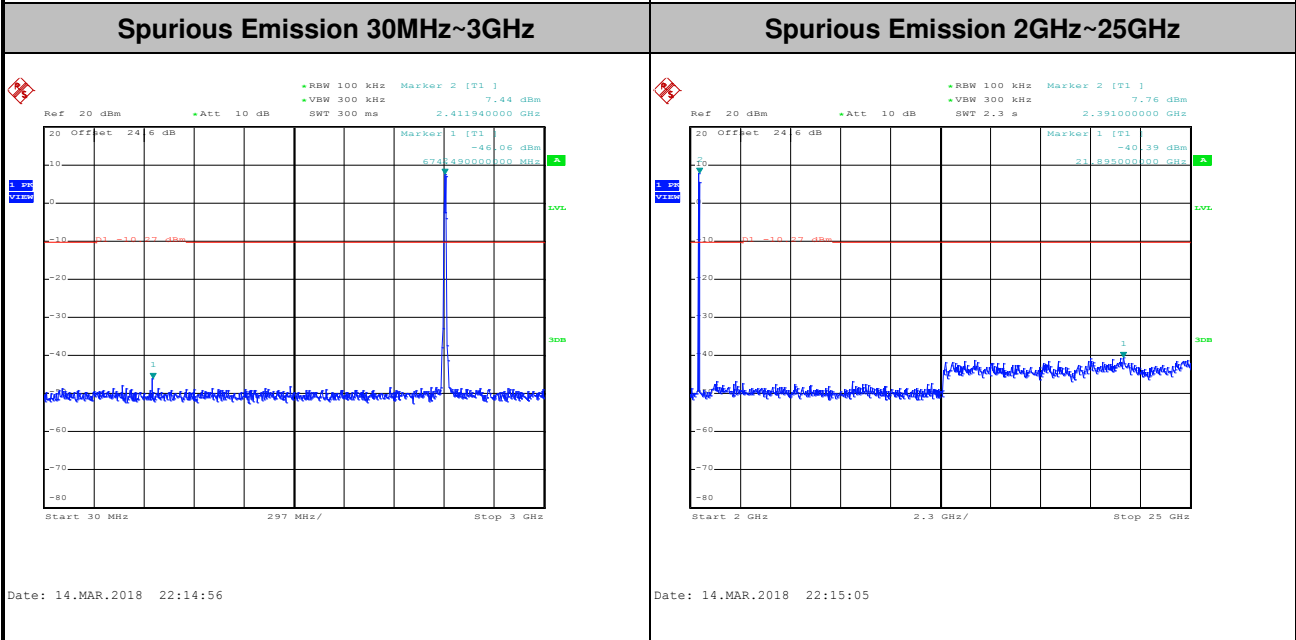
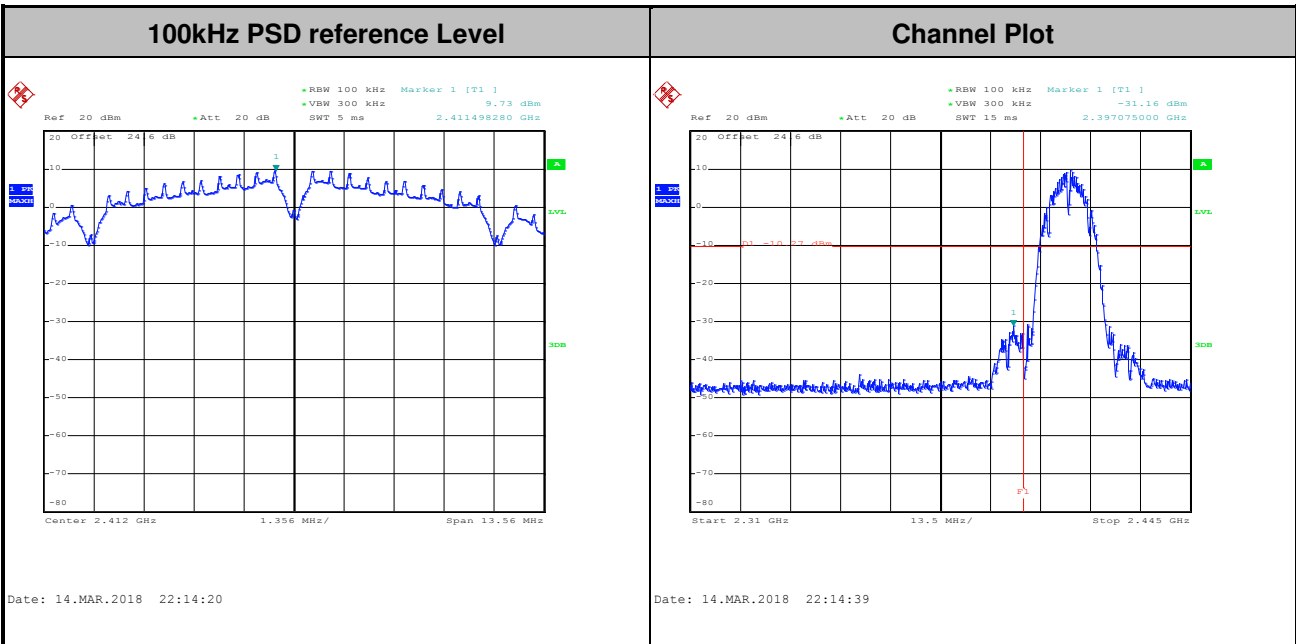



Test Mode :	802.11b	Test Channel :	06
-------------	---------	----------------	----

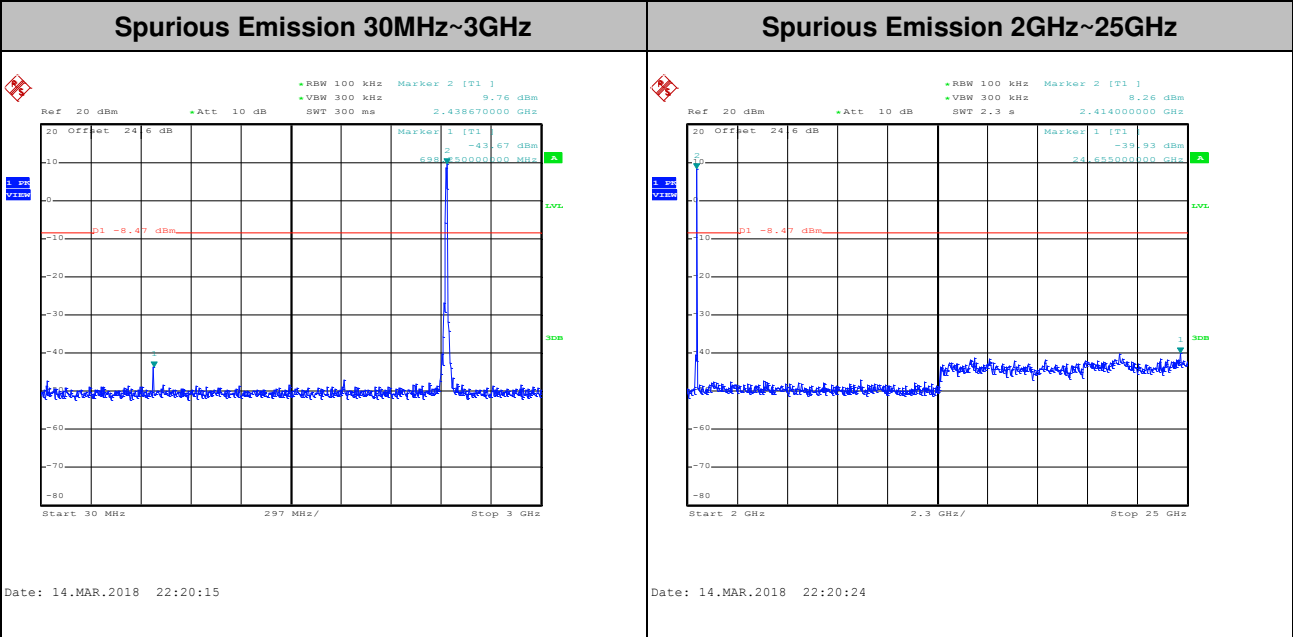
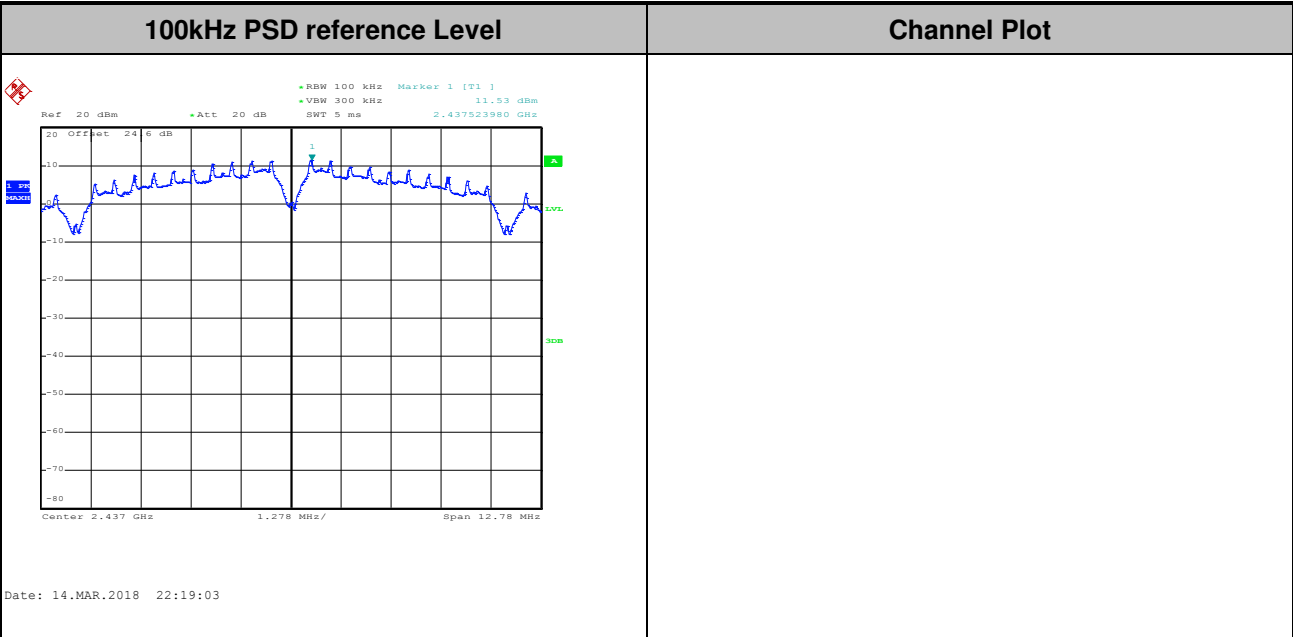



Test Mode :	802.11b	Test Channel :	11
-------------	---------	----------------	----

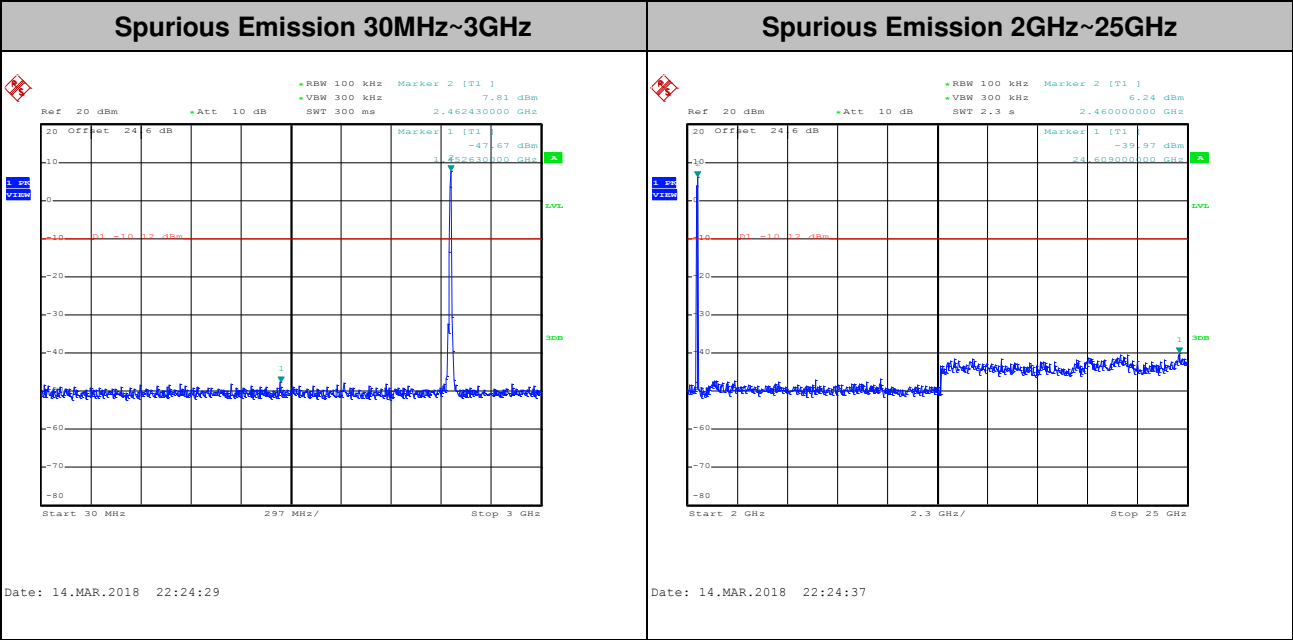
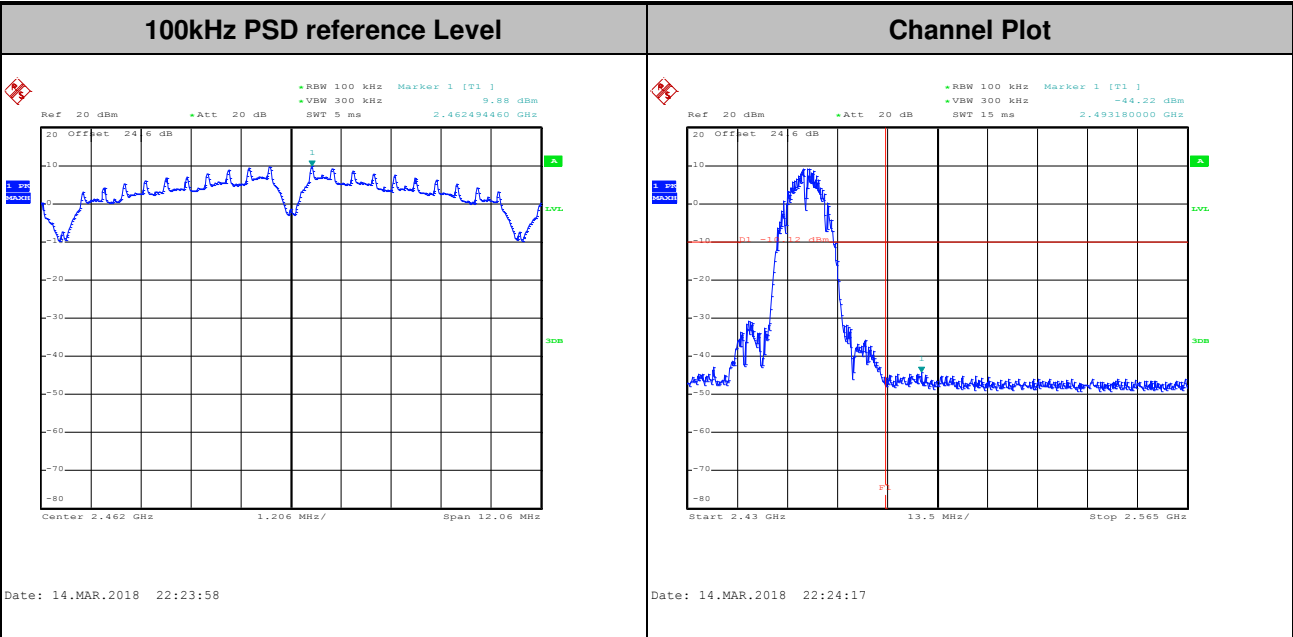



Test Mode : 802.11g Test Channel : 01

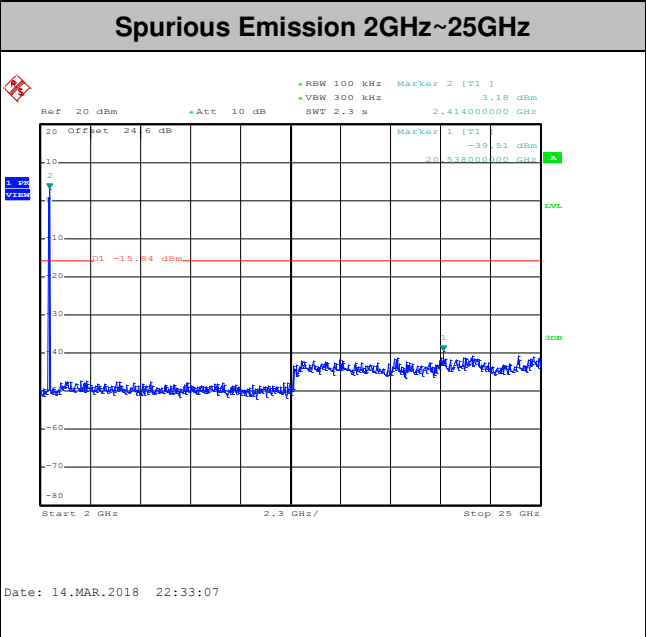
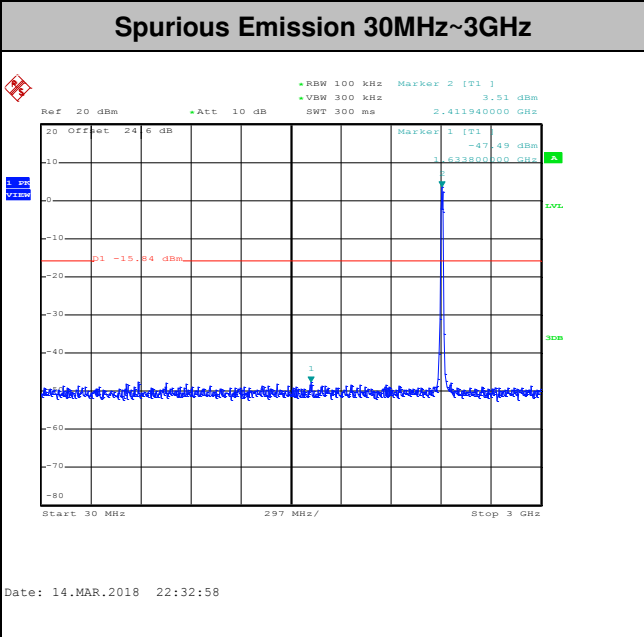
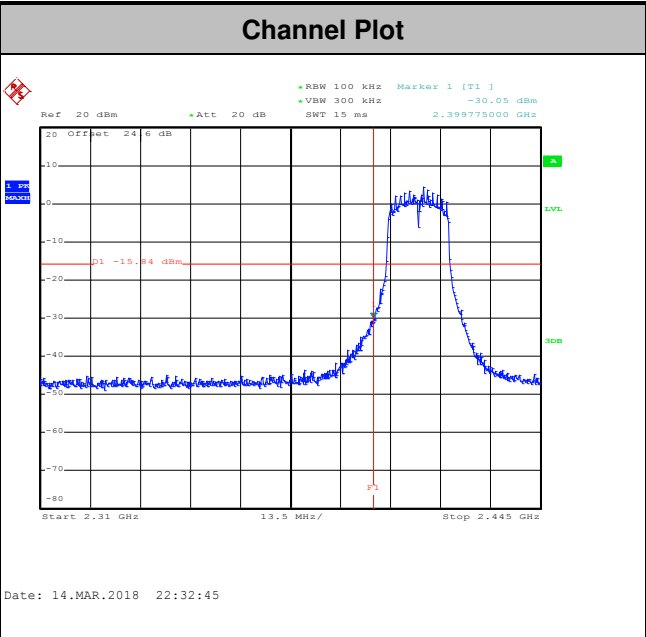
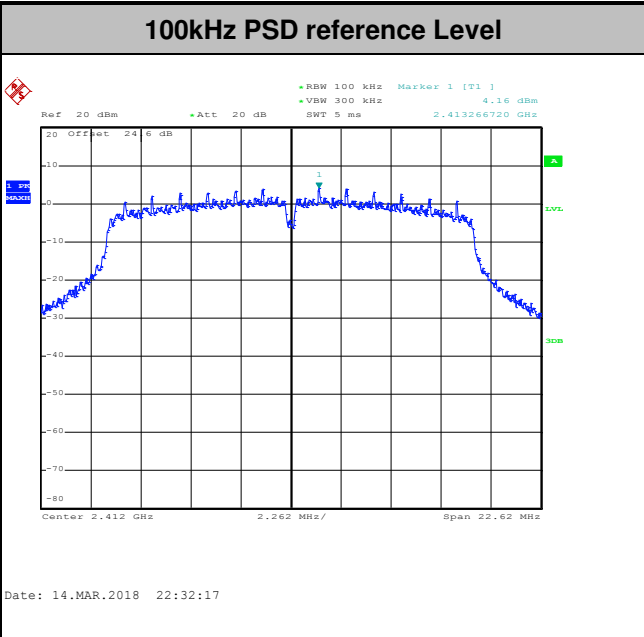



Test Mode :	802.11g	Test Channel :	06
-------------	---------	----------------	----

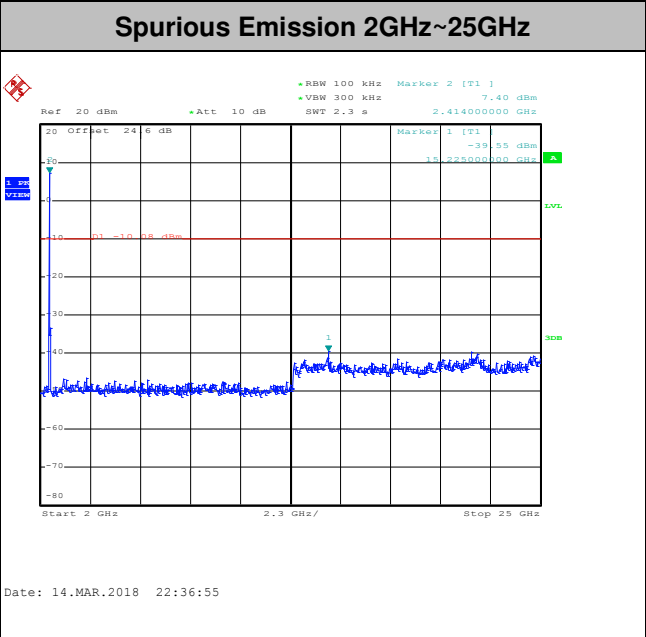
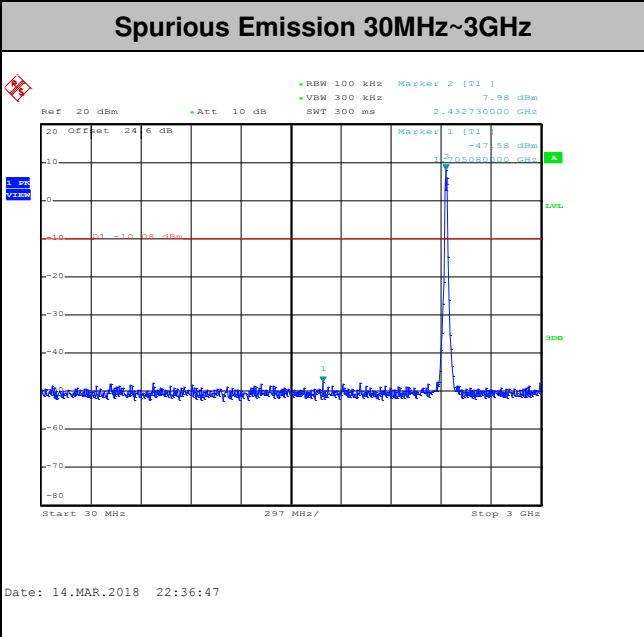
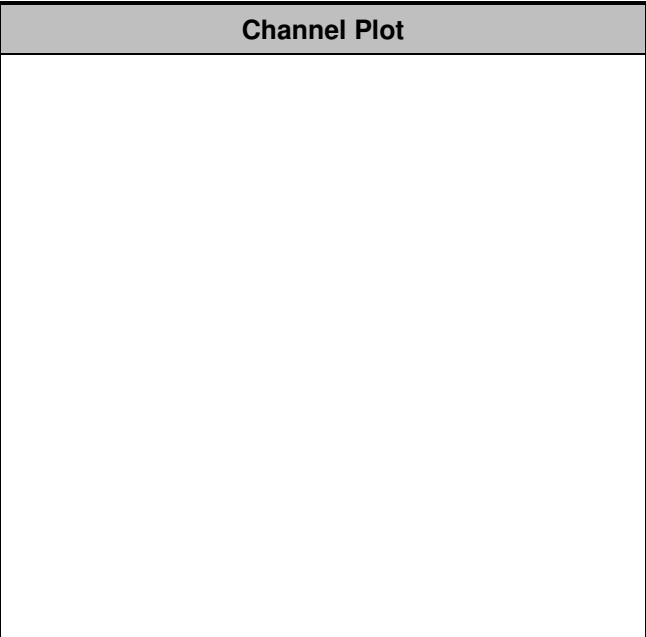
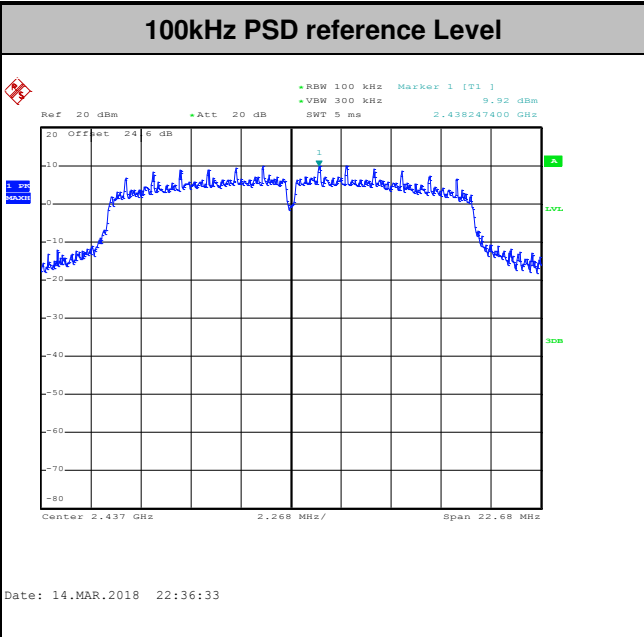



Test Mode :	802.11g	Test Channel :	11
-------------	---------	----------------	----

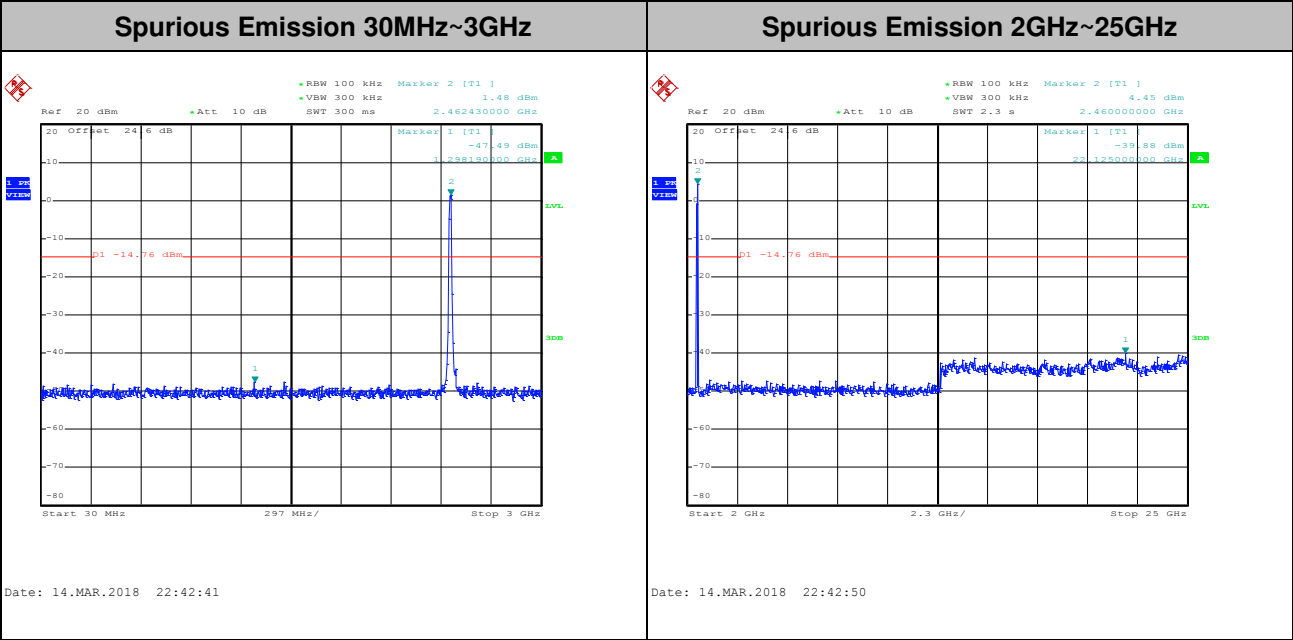
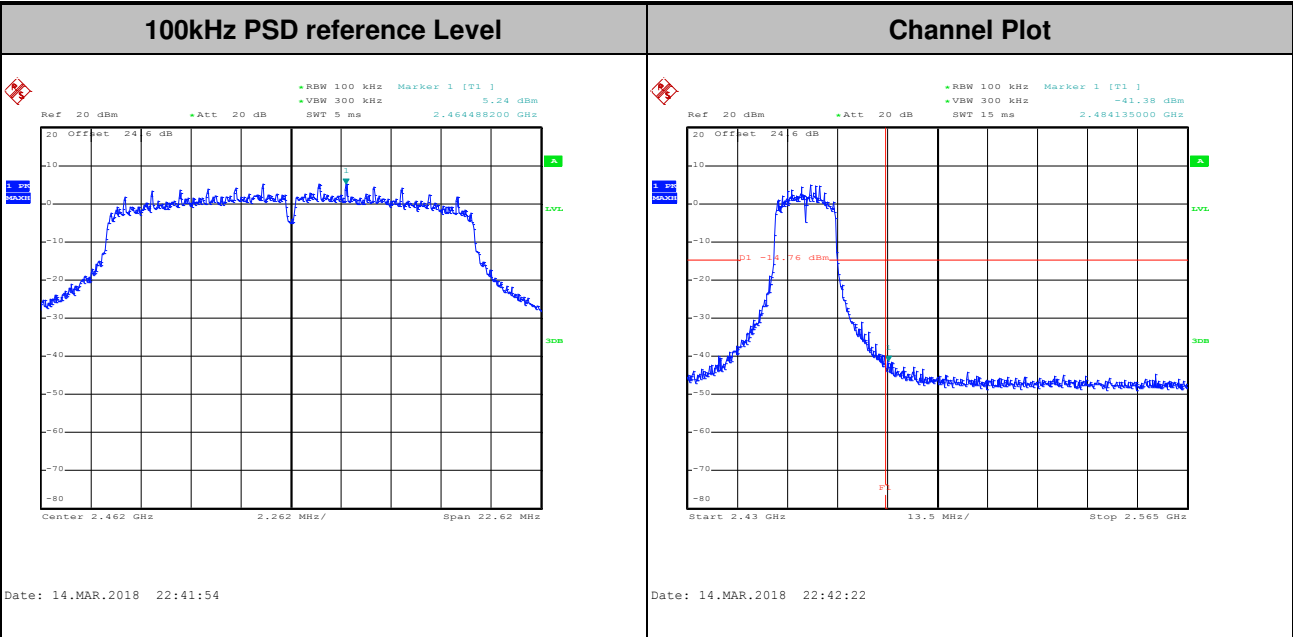



Test Mode :	802.11n HT20	Test Channel :	01
-------------	--------------	----------------	----

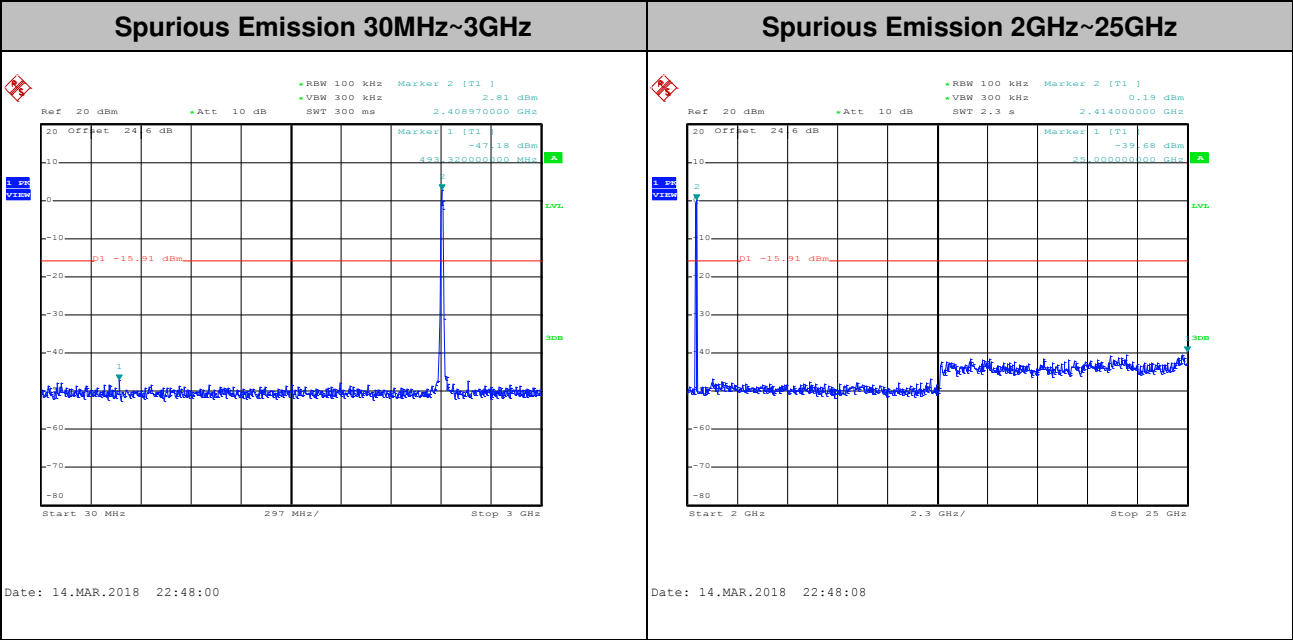
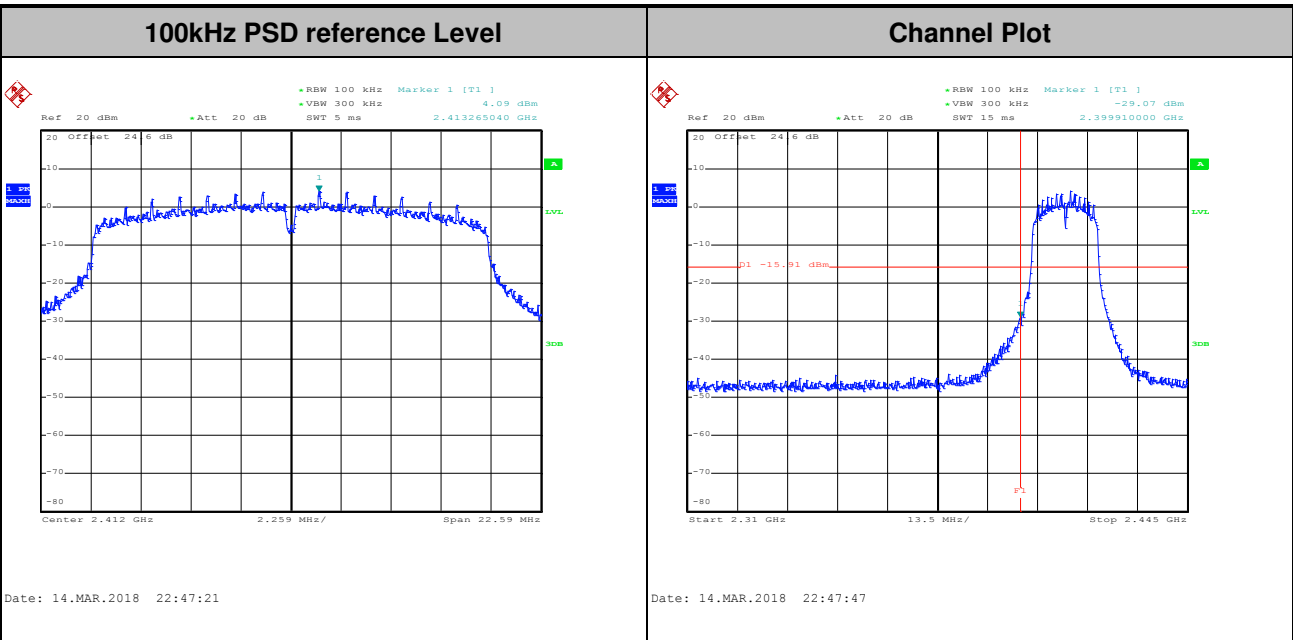



Test Mode :	802.11n HT20	Test Channel :	06
-------------	--------------	----------------	----

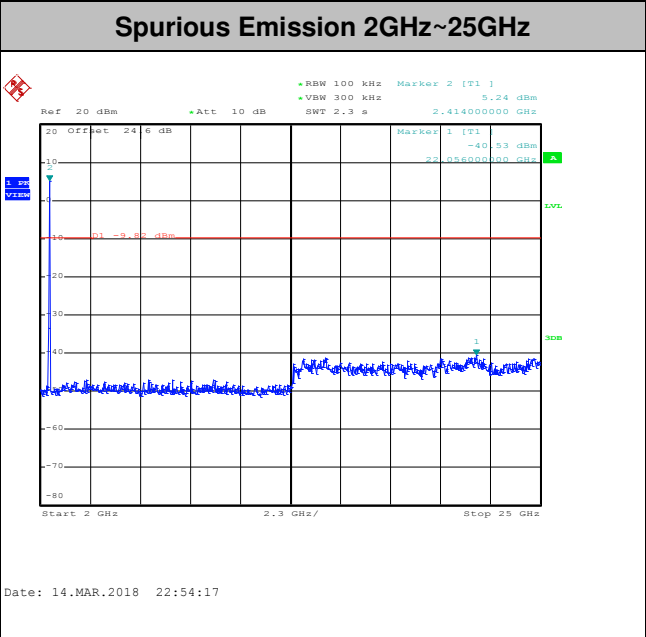
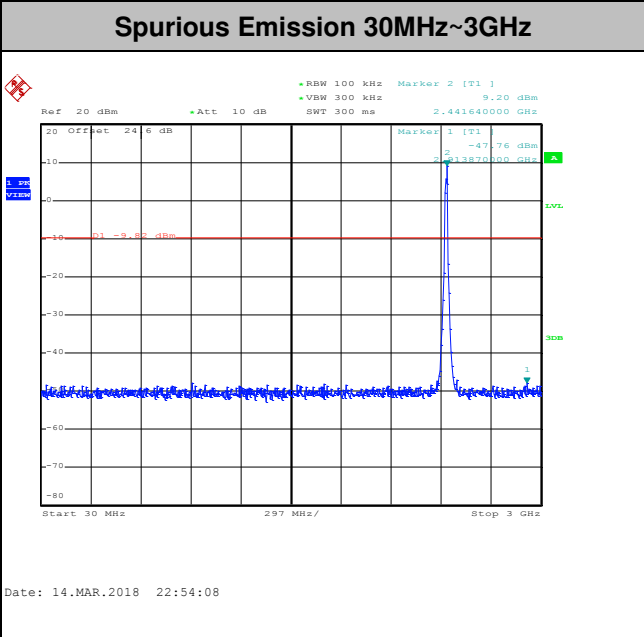
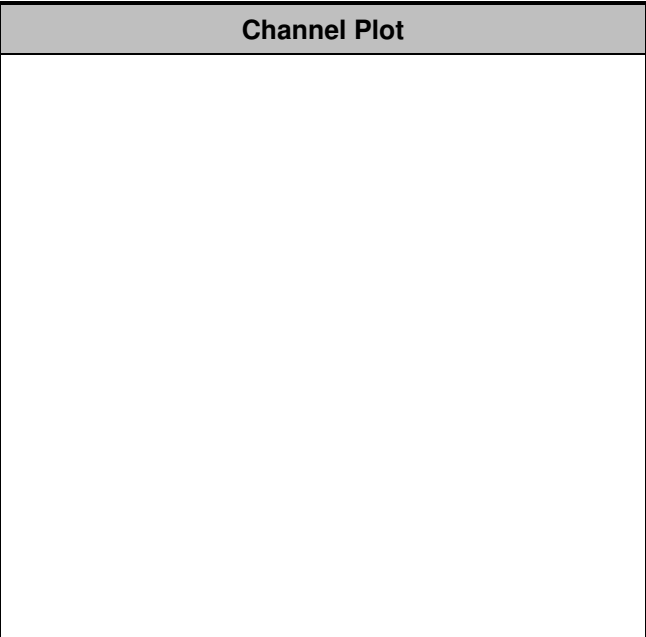
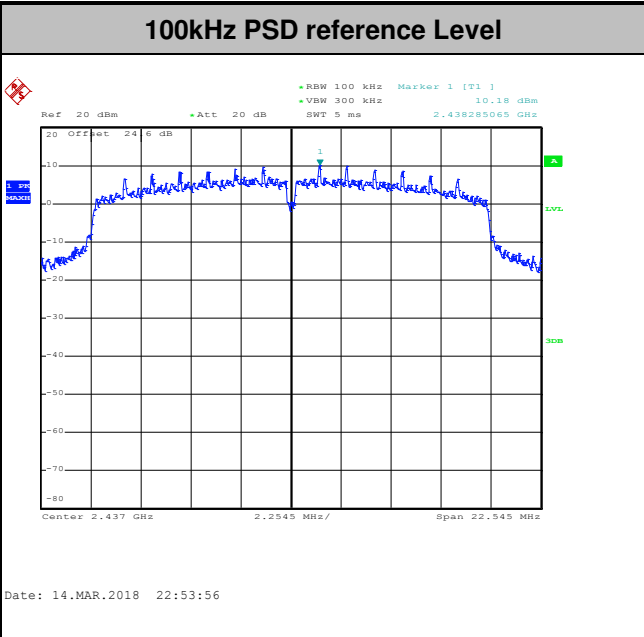



Test Mode :	802.11n HT20	Test Channel :	11
-------------	--------------	----------------	----

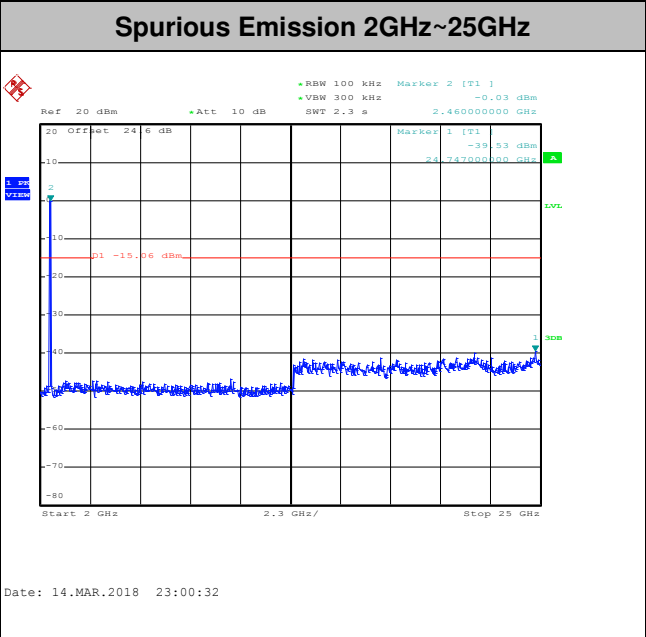
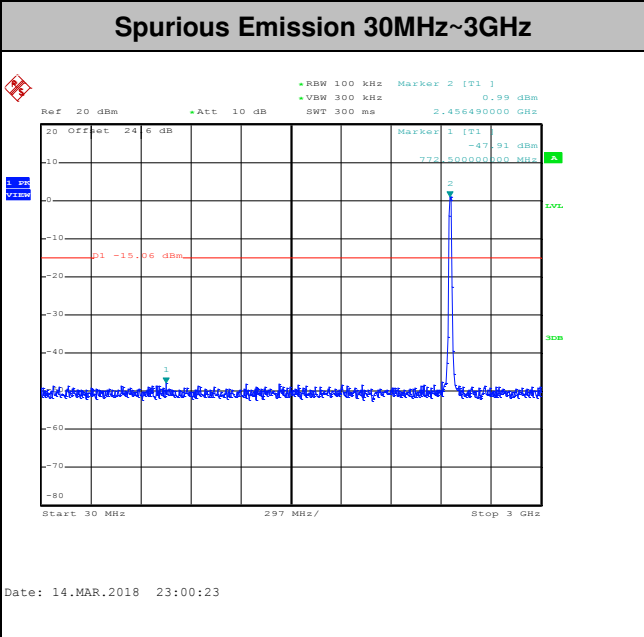
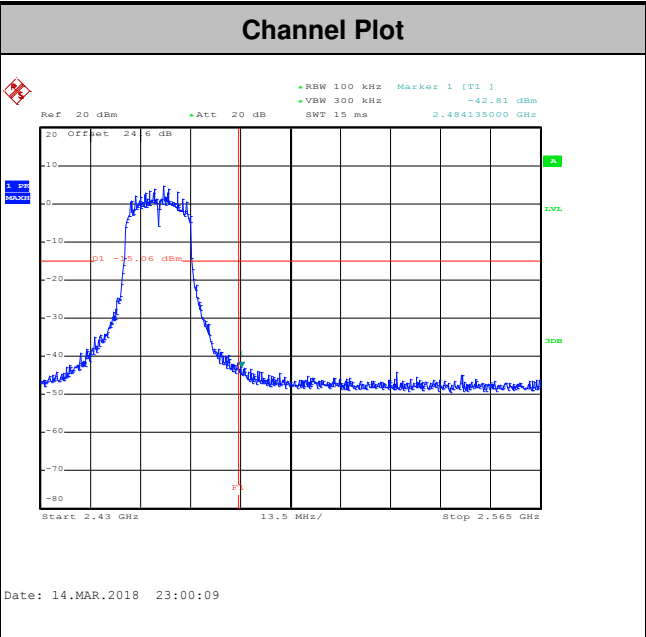
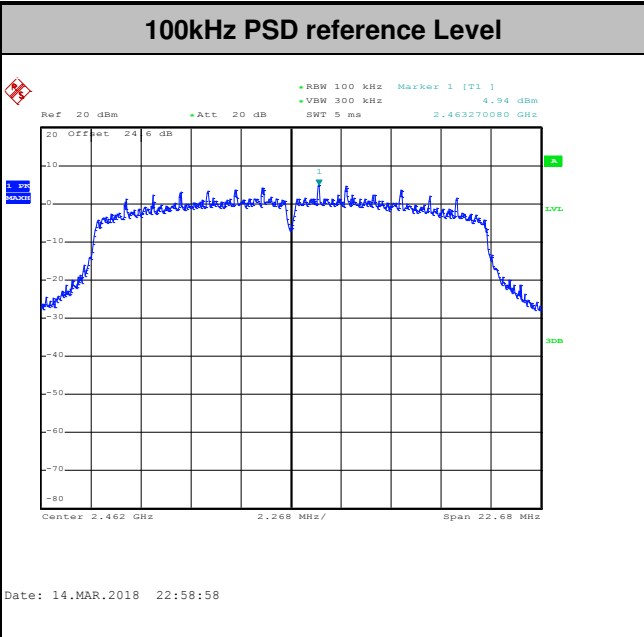



3.5 Radiated Band Edges and Spurious Emission Measurement

3.5.1 Limit of Radiated band edge and Spurious Emission Measurement

In any 100 kHz bandwidth outside the intentional radiator frequency band, all harmonics/spurious must be at least 20 dB below the highest emission level within the authorized band. If the output power of this device was measured by spectrum analyzer, the attenuation under this paragraph shall be 30 dB instead of 20 dB. In addition, radiated emissions which fall in the restricted bands must also comply with the limits as below.

Frequency (MHz)	Field Strength (microvolts/meter)	Measurement Distance (meters)
0.009 – 0.490	2400/F(kHz)	300
0.490 – 1.705	24000/F(kHz)	30
1.705 – 30.0	30	30
30 – 88	100	3
88 – 216	150	3
216 - 960	200	3
Above 960	500	3

3.5.2 Measuring Instruments

The measuring equipment is listed in the section 4 of this test report.



3.5.3 Test Procedures

1. The testing follows FCC KDB Publication No. 558074 D01 DTS Meas. Guidance v04.
2. The EUT was arranged to its worst case and then tune the antenna tower (from 1 m to 4 m) and turntable (from 0 degree to 360 degrees) to find the maximum reading. A pre-amp and a high pass filter are used for the test in order to get better signal level.
3. The EUT was placed on a turntable with 0.8 meter for frequency below 1GHz and 1.5 meter for frequency above 1GHz respectively above ground.
4. The EUT was set 3 meters from the interference receiving antenna, which was mounted on the top of a variable height antenna tower.
5. Corrected Reading: Antenna Factor + Cable Loss + Read Level - Preamp Factor = Level
6. For testing below 1GHz, if the emission level of the EUT in peak mode was 3 dB lower than the limit specified, then peak values of EUT will be reported, otherwise, the emissions will be repeated one by one using the CISPR quasi-peak method and reported.
7. For testing above 1GHz, the emission level of the EUT in peak mode was 20dB lower than average limit (that means the emission level in average mode also complies with the limit in average mode), then peak values of EUT will be reported, otherwise, the emissions will be measured in average mode again and reported.
8. Use the following spectrum analyzer settings:
 - (1) Span shall wide enough to fully capture the emission being measured;
 - (2) Set RBW=100 kHz for $f < 1$ GHz; VBW \geq RBW; Sweep = auto; Detector function = peak; Trace = max hold;
 - (3) Set RBW = 1 MHz, VBW= 3MHz for $f \geq 1$ GHz for peak measurement.
For average measurement:
 - VBW = 10 Hz, when duty cycle is no less than 98 percent.
 - VBW $\geq 1/T$, when duty cycle is less than 98 percent where T is the minimum transmission duration over which the transmitter is on and is transmitting at its maximum power control level for the tested mode of operation.

3.5.4 Test Setup

For radiated emissions below 30MHz



For radiated emissions from 30MHz to 1GHz

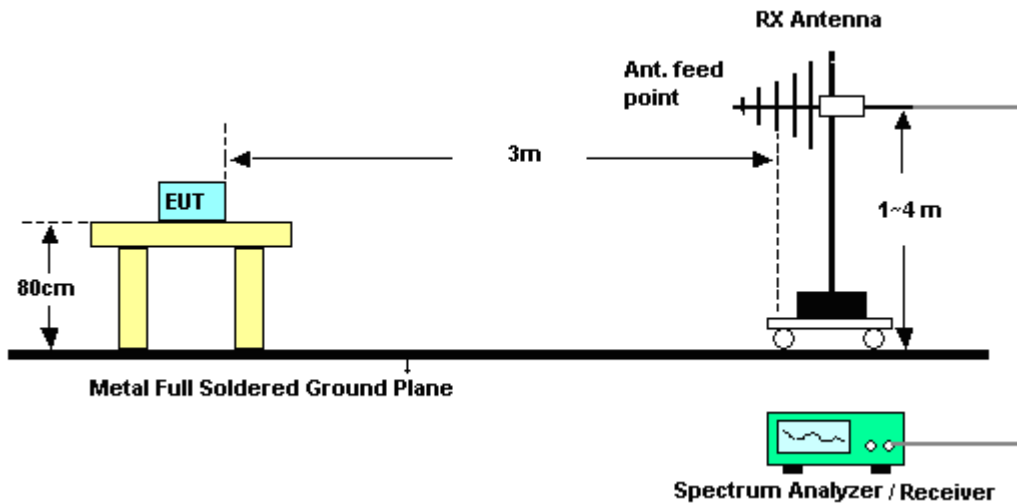

For radiated emissions above 1GHz

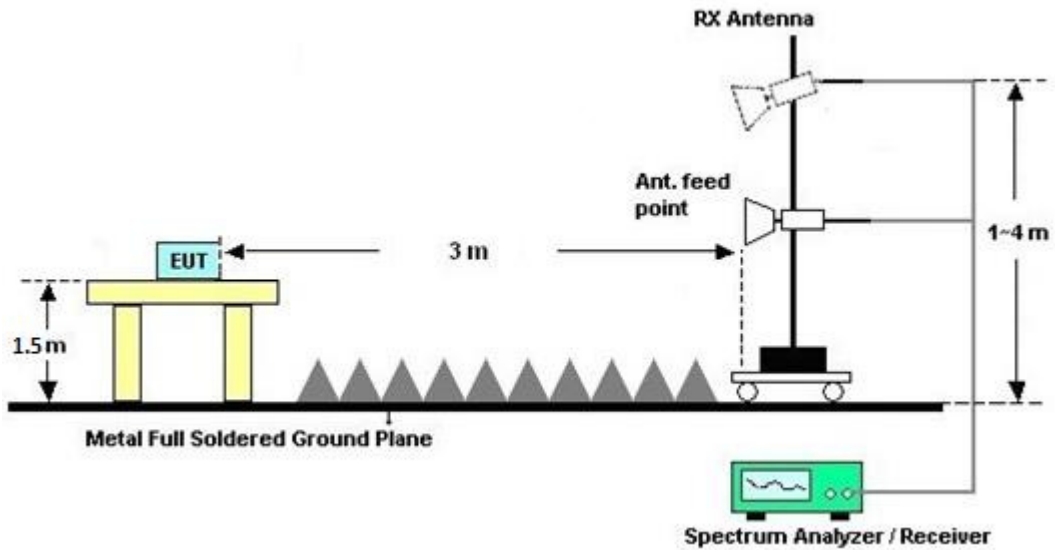

3.5.5 Test Results of Radiated Spurious Emissions (9kHz ~ 30MHz)

The low frequency, which started from 9 kHz to 30MHz, was pre-scanned and the result which was 20dB lower than the limit line was not reported.

There is a comparison data of both open-field test site and semi-Anechoic chamber, and the result came out very similar.

3.5.6 Test Result of Radiated Spurious at Band Edges

Please refer to Appendix C and D.

3.5.7 Duty Cycle

Please refer to Appendix E.

3.5.8 Test Result of Radiated Spurious Emission (30MHz ~ 10th Harmonic)

Please refer to Appendix C and D.



3.6 AC Conducted Emission Measurement

3.6.1 Limit of AC Conducted Emission

For equipment that is designed to be connected to the public utility (AC) power line, the radio frequency voltage that is conducted back onto the AC power line on any frequency or frequencies within the band 150 kHz to 30 MHz shall not exceed the limits in the following table.

Frequency of Emission (MHz)	Conducted Limit (dB μ V)	
	Quasi-Peak	Average
0.15-0.5	66 to 56*	56 to 46*
0.5-5	56	46
5-30	60	50

*Decreases with the logarithm of the frequency.

3.6.2 Measuring Instruments

The measuring equipment is listed in the section 4 of this test report.

3.6.3 Test Procedures

1. The EUT was placed 0.4 meter from the conducting wall of the shielding room, and it was kept at least 80 centimeters from any other grounded conducting surface.
2. Connect EUT to the power mains through a line impedance stabilization network (LISN).
3. All the support units are connecting to the other LISN.
4. The LISN provides 50 ohm coupling impedance for the measuring instrument.
5. The FCC states that a 50 ohm, 50 microhenry LISN should be used.
6. Both sides of AC line were checked for maximum conducted interference.
7. The frequency range from 150 kHz to 30 MHz was searched.
8. Set the test-receiver system to Peak Detect Function and specified bandwidth (IF bandwidth = 9kHz) with Maximum Hold Mode.

3.6.4 Test Setup

<AC Conducted Emission Mode in Bluetooth Link>

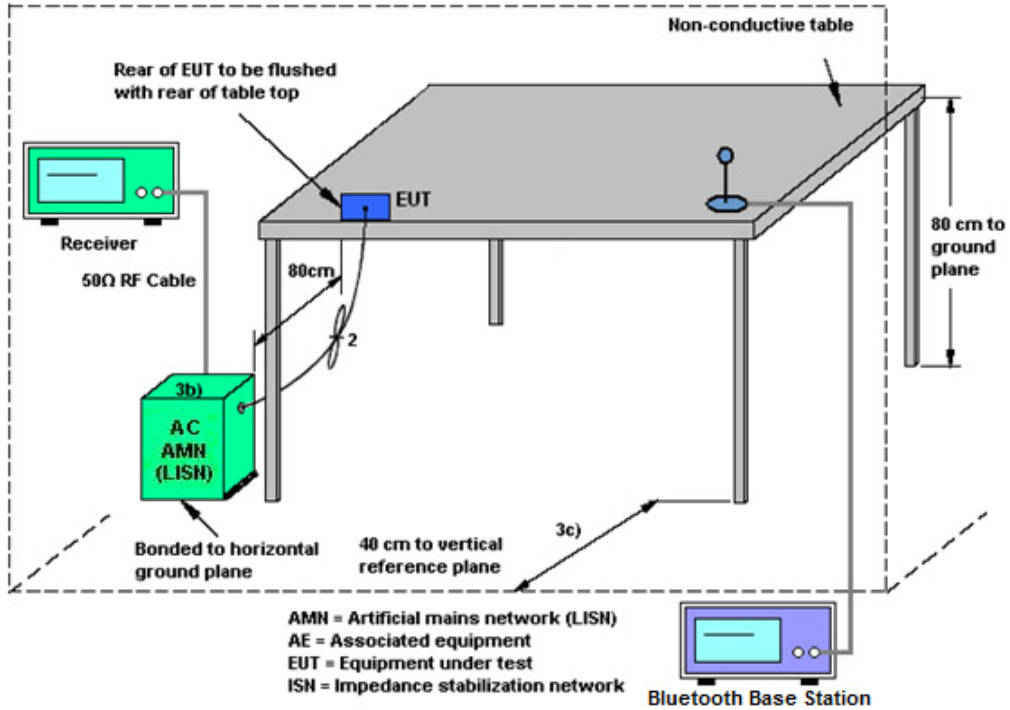

<AC Conducted Emission Mode in WLAN Link>

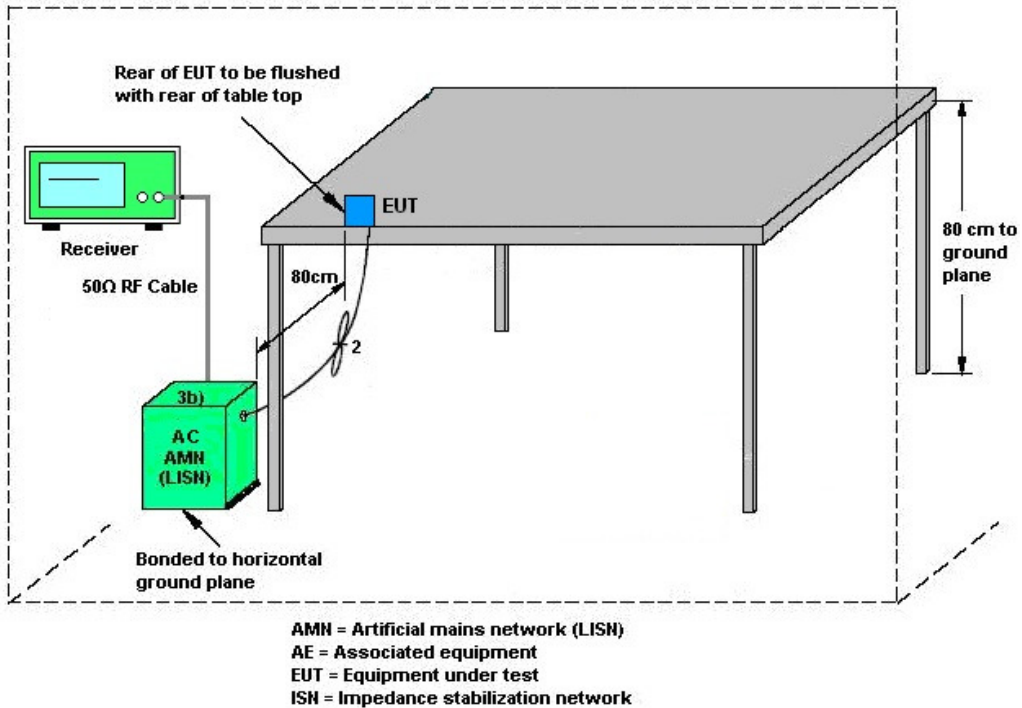



3.6.5 Test Result of AC Conducted Emission

Please refer to Appendix B.



3.7 Antenna Requirements

3.7.1 Standard Applicable

If directional gain of transmitting Antennas is greater than 6dBi, the power shall be reduced by the same level in dB comparing to gain minus 6dBi. The use of a permanently attached Antenna or of an Antenna that uses a unique coupling to the intentional radiator shall be considered sufficient to comply with the rule.

3.7.2 Antenna Anti-Replacement Construction

An embedded-in antenna design is used.

3.7.3 Antenna Gain

The antenna peak gain of EUT is less than 6 dBi. Therefore, it is not necessary to reduce maximum peak output power limit.



4 List of Measuring Equipment

Instrument	Manufacturer	Model No.	Serial No.	Characteristics	Calibration Date	Test Date	Due Date	Remark
Power Meter	Anritsu	ML2495A	1240001	N/A	Sep. 07, 2017	Feb. 27, 2018~ Mar. 14, 2018	Sep. 06, 2018	Conducted (TH05-HY)
Power Sensor	Anritsu	MA2411B	1207349	300MHz~40GHz	Sep. 07, 2017	Feb. 27, 2018~ Mar. 14, 2018	Sep. 06, 2018	Conducted (TH05-HY)
Spectrum Analyzer	Rohde & Schwarz	FSP40	100055	9kHz~40GHz	Jun. 20, 2017	Feb. 27, 2018~ Mar. 14, 2018	Jun. 19, 2018	Conducted (TH05-HY)
AC Power Source	ChainTek	APC-1000W	N/A	N/A	N/A	Mar. 28, 2018	N/A	Conduction (CO05-HY)
EMI Test Receiver	Rohde & Schwarz	ESR3	102388	3.6GHz	Dec. 08, 2017	Mar. 28, 2018	Dec. 07, 2018	Conduction (CO05-HY)
LISN	Rohde & Schwarz	ENV216	100080	9kHz~30MHz	Nov. 30, 2017	Mar. 28, 2018	Nov. 29, 2018	Conduction (CO05-HY)
LISN	Rohde & Schwarz	ENV216	100081	9kHz~30MHz	Dec. 08, 2017	Mar. 28, 2018	Dec. 07, 2018	Conduction (CO05-HY)
Test Software	Rohde & Schwarz	EMC32 V10.30	N/A	N/A	N/A	Mar. 28, 2018	N/A	Conduction (CO05-HY)
Amplifier	MITEQ	TTA1840-35-H G	1871923	18GHz~40GHz, V SWR : 2.5:1 max	Jul. 18, 2017	Feb. 14, 2018~ Mar. 16, 2018	Jul. 17, 2018	Radiation (03CH12-HY)
Bilog Antenna	TESEQ	CBL 6111D&N-6-06	35414&AT-N0 602	30MHz~1GHz	Oct. 14, 2017	Feb. 14, 2018~ Mar. 16, 2018	Oct. 13, 2018	Radiation (03CH12-HY)
Bilog Antenna	TESEQ	CBL 6111D&00800 N1D01N-06	40103&07	30MHz to 1GHz	Jan. 10, 2018	Mar. 16, 2018	Jan. 09, 2019	Radiation (03CH12-HY)
Loop Antenna	Rohde & Schwarz	HFH2-Z2	100488	9 kHz~30 MHz	Nov. 23, 2017	Feb. 14, 2018~ Mar. 16, 2018	Nov. 22, 2019	Radiation (03CH12-HY)
EMI Test Receiver	Rohde & Schwarz	ESU26	100390	20Hz~26.5GHz	Dec. 25, 2017	Feb. 14, 2018~ Mar. 16, 2018	Dec. 24, 2018	Radiation (03CH12-HY)
Horn Antenna	SCHWARZBE CK	BBHA 9120D	9120D-1328	1GHz ~ 18GHz	Oct. 20, 2017	Feb. 14, 2018~ Mar. 16, 2018	Oct. 19, 2018	Radiation (03CH12-HY)
Preamplifier	COM-POWER	PA-103	161075	10MHz~1GHz	Mar. 23, 2017	Feb. 14, 2018~ Mar. 16, 2018	Mar. 22, 2018	Radiation (03CH12-HY)
Preamplifier	Keysight	83017A	MY53270148	1GHz~26.5GHz	Jan. 15, 2018	Feb. 14, 2018~ Mar. 16, 2018	Jan. 14, 2019	Radiation (03CH12-HY)
Preamplifier	MITEQ	AMF-7D-0010 1800	2025787	1GHZ~18GHZ	Feb. 13, 2017	Feb. 14, 2018~ Mar. 16, 2018	Feb. 12, 2019	Radiation (03CH12-HY)
Filter	Wainwright	WHKX12-2700 -3000-18000-6 0ST	SN2	3 GHz Highpass	Jul. 17, 2017	Feb. 14, 2018~ Mar. 16, 2018	Jul. 16, 2018	Radiation (03CH12-HY)
Antenna Mast	EMEC	AM-BS-4500-B	N/A	1m~4m	N/A	Feb. 14, 2018~ Mar. 16, 2018	N/A	Radiation (03CH12-HY)
Turn Table	EMEC	TT2000	N/A	0~360 Degree	N/A	Feb. 14, 2018~ Mar. 16, 2018	N/A	Radiation (03CH12-HY)
Attenuator	Fairview Microwave	SA18S5W-10	n/a	10db	Mar. 24, 2017	Feb. 14, 2018~ Mar. 16, 2018	Mar. 23, 2018	Radiation (03CH12-HY)
Spectrum Analyzer	Keysight	N9010A	MY55370485	10Hz~44GHz	Oct. 31, 2017	Feb. 14, 2018~ Mar. 16, 2018	Oct. 30, 2018	Radiation (03CH12-HY)
Test Software	Audix	E3 6.2009-8-24	RK-000989	N/A	N/A	Feb. 14, 2018~ Mar. 16, 2018	N/A	Radiation (03CH12-HY)



5 Uncertainty of Evaluation

Uncertainty of Conducted Emission Measurement (150 kHz ~ 30 MHz)

Measuring Uncertainty for a Level of Confidence of 95% ($U = 2Uc(y)$)	2.7
---	-----

Uncertainty of Radiated Emission Measurement (30 MHz ~ 1000 MHz)

Measuring Uncertainty for a Level of Confidence of 95% ($U = 2Uc(y)$)	5.1
---	-----

Uncertainty of Radiated Emission Measurement (1000 MHz ~ 18000 MHz)

Measuring Uncertainty for a Level of Confidence of 95% ($U = 2Uc(y)$)	5.2
---	-----

Uncertainty of Radiated Emission Measurement (18000 MHz ~ 40000 MHz)

Measuring Uncertainty for a Level of Confidence of 95% ($U = 2Uc(y)$)	4.7
---	-----

Appendix A. Test Result of Conducted Test Items

Test Engineer:	White Lin/Lena Lo	Temperature:	21~25	°C
Test Date:	2018/02/27 ~ 2018/03/14	Relative Humidity:	51~54	%

TEST RESULTS DATA
6dB and 99% Occupied Bandwidth

2.4GHz Band								
Mod.	Data Rate	N _{TX}	CH.	Freq. (MHz)	99% Occupied BW (MHz)	6dB BW (MHz)	6dB BW Limit (MHz)	Pass/Fail
11b	1Mbps	1	1	2412	14.20	9.04	0.50	Pass
11b	1Mbps	1	6	2437	14.30	8.52	0.50	Pass
11b	1Mbps	1	11	2462	14.20	8.04	0.50	Pass
11g	6Mbps	1	1	2412	17.30	15.08	0.50	Pass
11g	6Mbps	1	6	2437	18.10	15.12	0.50	Pass
11g	6Mbps	1	11	2462	17.35	15.08	0.50	Pass
HT20	MCS0	1	1	2412	18.35	15.06	0.50	Pass
HT20	MCS0	1	6	2437	18.95	15.03	0.50	Pass
HT20	MCS0	1	11	2462	18.20	15.12	0.50	Pass

TEST RESULTS DATA
Peak Power Table

2.4GHz Band										
Mod.	Data Rate	N _{TX}	CH.	Freq. (MHz)	Peak Conducted Power (dBm)	Conducted Power Limit (dBm)	DG (dBi)	EIRP Power (dBm)	EIRP Power Limit (dBm)	Pass /Fail
11b	1Mbps	1	1	2412	20.42	30.00	0.56	20.98	36.00	Pass
11b	1Mbps	1	6	2437	22.26	30.00	0.56	22.82	36.00	Pass
11b	1Mbps	1	11	2462	20.58	30.00	0.56	21.14	36.00	Pass
11g	6Mbps	1	1	2412	24.82	30.00	0.56	25.38	36.00	Pass
11g	6Mbps	1	6	2437	26.07	30.00	0.56	26.63	36.00	Pass
11g	6Mbps	1	11	2462	25.09	30.00	0.56	25.65	36.00	Pass
HT20	MCS0	1	1	2412	24.11	30.00	0.56	24.67	36.00	Pass
HT20	MCS0	1	6	2437	26.14	30.00	0.56	26.70	36.00	Pass
HT20	MCS0	1	11	2462	25.08	30.00	0.56	25.64	36.00	Pass

TEST RESULTS DATA
Average Power Table
(Reporting Only)

2.4GHz Band						
Mod.	Data Rate	N _{TX}	CH.	Freq. (MHz)	Duty Factor (dB)	Average Conducted Power (dBm)
11b	1Mbps	1	1	2412	0.04	18.01
11b	1Mbps	1	6	2437	0.04	19.92
11b	1Mbps	1	11	2462	0.04	18.38
11g	6Mbps	1	1	2412	0.20	15.09
11g	6Mbps	1	6	2437	0.20	20.28
11g	6Mbps	1	11	2462	0.20	16.09
HT20	MCS0	1	1	2412	0.24	14.79
HT20	MCS0	1	6	2437	0.24	20.00
HT20	MCS0	1	11	2462	0.24	15.62

TEST RESULTS DATA
Peak Power Density

2.4GHz Band								
Mod.	Data Rate	N _{TX}	CH.	Freq. (MHz)	Peak PSD (dBm /3kHz)	DG (dBi)	Peak PSD Limit (dBm /3kHz)	Pass/Fail
11b	1Mbps	1	1	2412	-3.32	0.56	8.00	Pass
11b	1Mbps	1	6	2437	-2.59	0.56	8.00	Pass
11b	1Mbps	1	11	2462	-3.88	0.56	8.00	Pass
11g	6Mbps	1	1	2412	-10.49	0.56	8.00	Pass
11g	6Mbps	1	6	2437	-4.87	0.56	8.00	Pass
11g	6Mbps	1	11	2462	-8.30	0.56	8.00	Pass
HT20	MCS0	1	1	2412	-9.90	0.56	8.00	Pass
HT20	MCS0	1	6	2437	-4.20	0.56	8.00	Pass
HT20	MCS0	1	11	2462	-9.95	0.56	8.00	Pass



Appendix B. AC Conducted Emission Test Results

Test Engineer :	Blue Lan	Temperature :	25~26°C
		Relative Humidity :	56~57%

EUT Information

Report NO : 822214
 Test Mode : Mode 2
 Test Voltage : Power From System
 Phase : Line

Full Spectrum

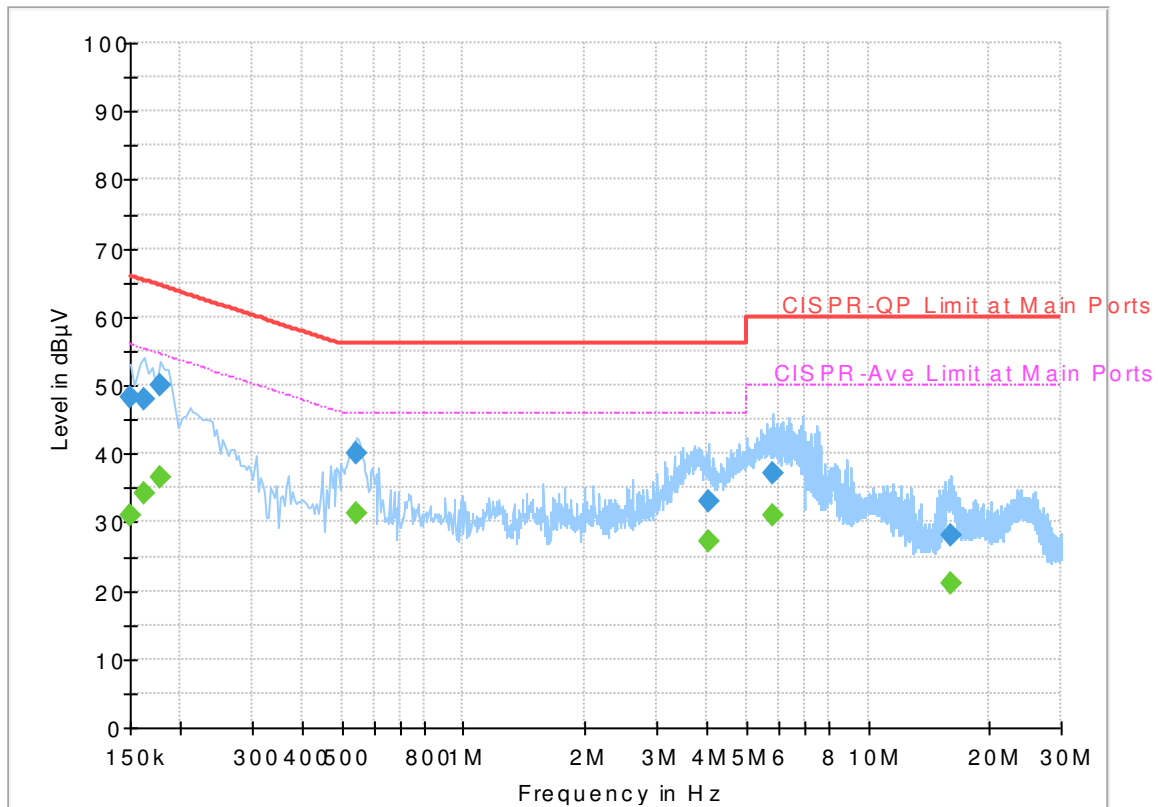

Final Result

Frequency (MHz)	QuasiPeak (dBµV)	Average (dBµV)	Limit (dBµV)	Margin (dB)	Line	Filter	Corr. (dB)
0.150000	---	31.00	56.00	25.00	L1	OFF	19.5
0.150000	48.19	---	66.00	17.81	L1	OFF	19.5
0.162000	---	34.10	55.36	21.26	L1	OFF	19.5
0.162000	48.05	---	65.36	17.31	L1	OFF	19.5
0.178000	---	36.54	54.58	18.04	L1	OFF	19.5
0.178000	49.92	---	64.58	14.66	L1	OFF	19.5
0.546000	---	31.35	46.00	14.65	L1	OFF	19.5
0.546000	39.96	---	56.00	16.04	L1	OFF	19.5
4.026000	---	27.21	46.00	18.79	L1	OFF	19.6
4.026000	33.15	---	56.00	22.85	L1	OFF	19.6
5.818000	---	30.85	50.00	19.15	L1	OFF	19.6
5.818000	37.12	---	60.00	22.88	L1	OFF	19.6
16.026000	---	21.18	50.00	28.82	L1	OFF	19.8
16.026000	27.96	---	60.00	32.04	L1	OFF	19.8

EUT Information

Report NO : 822214
 Test Mode : Mode 2
 Test Voltage : Power From System
 Phase : Neutral

Full Spectrum

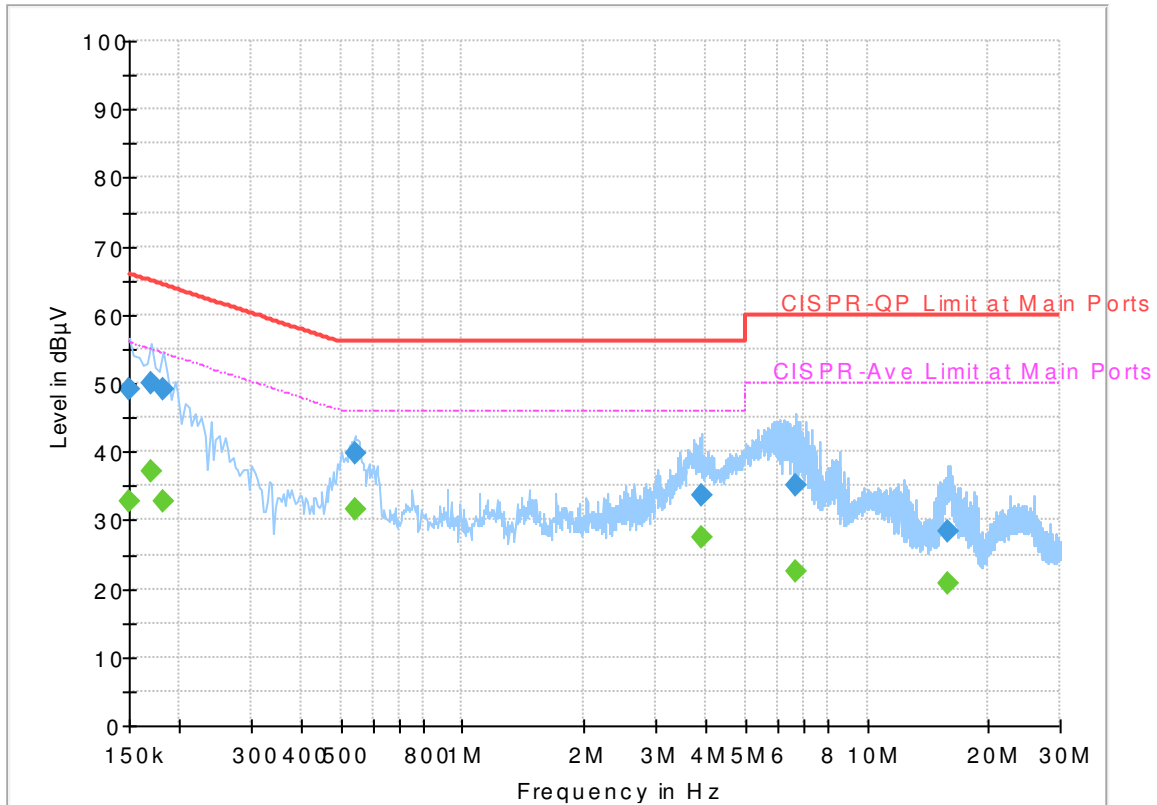

Final Result

Frequency (MHz)	QuasiPeak (dBµV)	Average (dBµV)	Limit (dBµV)	Margin (dB)	Line	Filter	Corr. (dB)
0.150000	---	32.86	56.00	23.14	N	OFF	19.5
0.150000	49.08	---	66.00	16.92	N	OFF	19.5
0.170000	---	37.06	54.96	17.90	N	OFF	19.5
0.170000	50.10	---	64.96	14.86	N	OFF	19.5
0.182000	---	32.76	54.39	21.63	N	OFF	19.5
0.182000	49.15	---	64.39	15.24	N	OFF	19.5
0.542000	---	31.48	46.00	14.52	N	OFF	19.5
0.542000	39.68	---	56.00	16.32	N	OFF	19.5
3.914000	---	27.54	46.00	18.46	N	OFF	19.6
3.914000	33.53	---	56.00	22.47	N	OFF	19.6
6.642000	---	22.42	50.00	27.58	N	OFF	19.6
6.642000	35.17	---	60.00	24.83	N	OFF	19.6
15.822000	---	20.64	50.00	29.36	N	OFF	19.8
15.822000	28.46	---	60.00	31.54	N	OFF	19.8



Appendix C. Radiated Spurious Emission

Test Engineer :	Watt Tseng, Karl Hou, and Nick Yu	Temperature :	22~23°C
		Relative Humidity :	59~61%

2.4GHz 2400~2483.5MHz

WIFI 802.11b (Band Edge @ 3m)

WIFI	Note	Frequency	Level	Over	Limit	Read	Antenna	Path	Preamp	Ant	Table	Peak	Pol.	
Ant.				Limit	Line	Level	Factor	Loss	Factor	Pos	Pos	Avg.		
1		(MHz)	(dBμV/m)	(dB)	(dBμV/m)	(dBμV)	(dB/m)	(dB)	(dB)	(cm)	(deg)	(P/A)	(H/V)	
802.11b CH 01 2412MHz		2387.175	59.21	-14.79	74	49.58	27.15	14.06	31.58	106	126	P	H	
		2386.335	51.49	-2.51	54	41.86	27.15	14.06	31.58	106	126	A	H	
	*	2412	110.01	-	-	100.31	27.19	14.08	31.57	106	126	P	H	
	*	2412	106.11	-	-	96.41	27.19	14.08	31.57	106	126	A	H	
													H	
														H
			2386.965	58.08	-15.92	74	48.45	27.15	14.06	31.58	385	188	P	V
			2386.86	49.36	-4.64	54	39.73	27.15	14.06	31.58	385	188	A	V
	*		2412	106.86	-	-	97.16	27.19	14.08	31.57	385	188	P	V
	*		2412	102.91	-	-	93.21	27.19	14.08	31.57	385	188	A	V
														V
														V
802.11b CH 06 2437MHz		2389.1	56.6	-17.4	74	46.97	27.15	14.06	31.58	100	127	P	H	
		2388.82	47.93	-6.07	54	38.3	27.15	14.06	31.58	100	127	A	H	
	*	2437	112.38	-	-	102.57	27.28	14.1	31.57	100	127	P	H	
	*	2437	108.43	-	-	98.62	27.28	14.1	31.57	100	127	A	H	
			2484.95	55.62	-18.38	74	45.68	27.36	14.14	31.56	100	127	P	H
			2485.65	44.69	-9.31	54	34.75	27.36	14.14	31.56	100	127	A	H
			2388.26	54.41	-19.59	74	44.78	27.15	14.06	31.58	371	188	P	V
			2388.4	44.11	-9.89	54	34.48	27.15	14.06	31.58	371	188	A	V
	*		2437	109.57	-	-	99.76	27.28	14.1	31.57	371	188	P	V
	*		2437	105.59	-	-	95.78	27.28	14.1	31.57	371	188	A	V
			2498.25	54.14	-19.86	74	44.15	27.4	14.14	31.55	371	188	P	V
			2486.91	42.25	-11.75	54	32.31	27.36	14.14	31.56	371	188	A	V



802.11b CH 11 2462MHz	*	2462	109.51	-	-	99.64	27.32	14.11	31.56	111	127	P	H
	*	2462	105.42	-	-	95.55	27.32	14.11	31.56	111	127	A	H
		2491.04	58.26	-15.74	74	48.28	27.4	14.14	31.56	111	127	P	H
		2486.96	48.45	-5.55	54	38.51	27.36	14.14	31.56	111	127	A	H
													H
													H
	*	2462	106.67	-	-	96.8	27.32	14.11	31.56	363	176	P	V
	*	2462	102.07	-	-	92.2	27.32	14.11	31.56	363	176	A	V
		2486.96	56.47	-17.53	74	46.53	27.36	14.14	31.56	363	176	P	V
		2487.88	45.56	-8.44	54	35.58	27.4	14.14	31.56	363	176	A	V
													V
													V
Remark	1. No other spurious found. 2. All results are PASS against Peak and Average limit line.												



**2.4GHz 2400~2483.5MHz
WIFI 802.11b (Harmonic @ 3m)**

WIFI Ant. 1	Note	Frequency (MHz)	Level (dBμV/m)	Over Limit (dB)	Limit Line (dBμV/m)	Read Level (dBμV)	Antenna Factor (dB/m)	Path Loss (dB)	Preamp Factor (dB)	Ant Pos (cm)	Table Pos (deg)	Peak Avg. (P/A)	Pol. (H/V)	
802.11b CH 01 2412MHz		4824	48.89	-25.11	74	75.57	31.36	6.7	64.74	100	0	P	H	
													H	
													H	
													H	
			4824	47.08	-26.92	74	73.76	31.36	6.7	64.74	100	0	P	V
														V
														V
802.11b CH 06 2437MHz		4874	52.2	-21.8	74	78.71	31.46	6.73	64.7	108	143	P	H	
		4874	51.04	-2.96	54	77.55	31.46	6.73	64.7	108	143	A	H	
		7311	49.12	-24.88	74	69.76	36.11	8.07	64.82	100	0	P	H	
													H	
			4874	48.67	-25.33	74	75.18	31.46	6.73	64.7	100	0	P	V
			7311	47.95	-26.05	74	68.59	36.11	8.07	64.82	100	0	P	V
														V
802.11b CH 11 2462MHz		4924	49.79	-24.21	74	76.16	31.56	6.73	64.66	100	0	P	H	
		7386	48.15	-25.85	74	68.67	36.33	8.01	64.86	100	0	P	H	
													H	
													H	
			4924	47.64	-26.36	74	74.01	31.56	6.73	64.66	100	0	P	V
			7386	46.77	-27.23	74	67.29	36.33	8.01	64.86	100	0	P	V
														V
Remark	1. No other spurious found.													
	2. All results are PASS against Peak and Average limit line.													



**2.4GHz 2400~2483.5MHz
WIFI 802.11g (Band Edge @ 3m)**

WIFI Ant. 1	Note	Frequency (MHz)	Level (dBμV/m)	Over Limit (dB)	Limit Line (dBμV/m)	Read Level (dBμV)	Antenna Factor (dB/m)	Path Loss (dB)	Preamp Factor (dB)	Ant Pos (cm)	Table Pos (deg)	Peak Avg. (P/A)	Pol. (H/V)	
802.11g CH 01 2412MHz		2389.065	63.18	-10.82	74	53.55	27.15	14.06	31.58	109	128	P	H	
		2390	50.1	-3.9	54	40.46	27.15	14.06	31.57	109	128	A	H	
	*	2412	108.27	-	-	98.57	27.19	14.08	31.57	109	128	P	H	
	*	2412	98.27	-	-	88.57	27.19	14.08	31.57	109	128	A	H	
													H	
														H
			2390	59.05	-14.95	74	49.41	27.15	14.06	31.57	384	218	P	V
			2390	47.72	-6.28	54	38.08	27.15	14.06	31.57	384	218	A	V
	*		2412	104.95	-	-	95.25	27.19	14.08	31.57	384	218	P	V
	*		2412	95.11	-	-	85.41	27.19	14.08	31.57	384	218	A	V
														V
														V
802.11g CH 06 2437MHz		2388.68	59.89	-14.11	74	50.26	27.15	14.06	31.58	100	127	P	H	
		2389.38	46.05	-7.95	54	36.42	27.15	14.06	31.58	100	127	A	H	
	*	2437	113.47	-	-	103.66	27.28	14.1	31.57	100	127	P	H	
	*	2437	103.46	-	-	93.65	27.28	14.1	31.57	100	127	A	H	
			2486.14	59.21	-14.79	74	49.27	27.36	14.14	31.56	100	127	P	H
			2483.5	45.16	-8.84	54	35.22	27.36	14.14	31.56	100	127	A	H
			2389.8	54.98	-19.02	74	45.34	27.15	14.06	31.57	326	169	P	V
			2389.94	43.77	-10.23	54	34.13	27.15	14.06	31.57	326	169	A	V
	*		2437	109.31	-	-	99.5	27.28	14.1	31.57	326	169	P	V
	*		2437	99.66	-	-	89.85	27.28	14.1	31.57	326	169	A	V
			2484.81	56.76	-17.24	74	46.82	27.36	14.14	31.56	326	169	P	V
			2483.62	43.41	-10.59	54	33.47	27.36	14.14	31.56	326	169	A	V



802.11g CH 11 2462MHz	*	2462	108.44	-	-	98.57	27.32	14.11	31.56	114	123	P	H
	*	2462	98.65	-	-	88.78	27.32	14.11	31.56	114	123	A	H
		2483.76	65.13	-8.87	74	55.19	27.36	14.14	31.56	114	123	P	H
		2483.56	51.17	-2.83	54	41.23	27.36	14.14	31.56	114	123	A	H
													H
													H
	*	2462	105.07	-	-	95.2	27.32	14.11	31.56	359	170	P	V
	*	2462	96.01	-	-	86.14	27.32	14.11	31.56	359	170	A	V
		2484.24	62.48	-11.52	74	52.54	27.36	14.14	31.56	359	170	P	V
		2483.76	48.17	-5.83	54	38.23	27.36	14.14	31.56	359	170	A	V
													V
													V
Remark	1. No other spurious found. 2. All results are PASS against Peak and Average limit line.												



**2.4GHz 2400~2483.5MHz
WIFI 802.11g (Harmonic @ 3m)**

WIFI Ant. 1	Note	Frequency (MHz)	Level (dBμV/m)	Over Limit (dB)	Limit Line (dBμV/m)	Read Level (dBμV)	Antenna Factor (dB/m)	Path Loss (dB)	Preamp Factor (dB)	Ant Pos (cm)	Table Pos (deg)	Peak Avg. (P/A)	Pol. (H/V)
802.11g CH 01 2412MHz		4824	43.82	-30.18	74	70.5	31.36	6.7	64.74	100	0	P	H
													H
													H
													H
		4824	42.76	-31.24	74	69.44	31.36	6.7	64.74	100	0	P	V
													V
													V
802.11g CH 06 2437MHz		4874	48.79	-25.21	74	75.3	31.46	6.73	64.7	100	0	P	H
		7311	49.27	-24.73	74	69.91	36.11	8.07	64.82	100	0	P	H
													H
													H
		4874	45.04	-28.96	74	71.55	31.46	6.73	64.7	100	0	P	V
		7311	48.4	-25.6	74	69.04	36.11	8.07	64.82	100	0	P	V
													V
802.11g CH 11 2462MHz		4924	45.37	-28.63	74	71.74	31.56	6.73	64.66	100	0	P	H
		7386	47.27	-26.73	74	67.79	36.33	8.01	64.86	100	0	P	H
													H
													H
		4924	41.15	-32.85	74	67.52	31.56	6.73	64.66	100	0	P	V
		7386	45.43	-28.57	74	65.95	36.33	8.01	64.86	100	0	P	V
													V
Remark	1. No other spurious found.												
	2. All results are PASS against Peak and Average limit line.												



**2.4GHz 2400~2483.5MHz
WIFI 802.11n HT20 (Band Edge @ 3m)**

WIFI Ant. 1	Note	Frequency (MHz)	Level (dBμV/m)	Over Limit (dB)	Limit Line (dBμV/m)	Read Level (dBμV)	Antenna Factor (dB/m)	Path Loss (dB)	Preamp Factor (dB)	Ant Pos (cm)	Table Pos (deg)	Peak Avg. (P/A)	Pol. (H/V)	
802.11n HT20 CH 01 2412MHz		2389.065	63.15	-10.85	74	53.52	27.15	14.06	31.58	106	125	P	H	
		2390	51.38	-2.62	54	41.74	27.15	14.06	31.57	106	125	A	H	
	*	2412	107.85	-	-	98.15	27.19	14.08	31.57	106	125	P	H	
	*	2412	98.36	-	-	88.66	27.19	14.08	31.57	106	125	A	H	
													H	
													H	
			2389.8	61.15	-12.85	74	51.51	27.15	14.06	31.57	376	190	P	V
			2389.905	48.7	-5.3	54	39.06	27.15	14.06	31.57	376	190	A	V
		*	2412	104.94	-	-	95.24	27.19	14.08	31.57	376	190	P	V
		*	2412	95.08	-	-	85.38	27.19	14.08	31.57	376	190	A	V
													V	
													V	
802.11n HT20 CH 06 2437MHz		2388.82	58.33	-15.67	74	48.7	27.15	14.06	31.58	100	126	P	H	
		2389.24	46.43	-7.57	54	36.8	27.15	14.06	31.58	100	126	A	H	
		*	2437	112.44	-	-	102.63	27.28	14.1	31.57	100	126	P	H
		*	2437	103.11	-	-	93.3	27.28	14.1	31.57	100	126	A	H
			2487.12	59.66	-14.34	74	49.72	27.36	14.14	31.56	100	126	P	H
			2483.62	45.59	-8.41	54	35.65	27.36	14.14	31.56	100	126	A	H
			2389.1	54.93	-19.07	74	45.3	27.15	14.06	31.58	326	171	P	V
			2386.3	43.96	-10.04	54	34.33	27.15	14.06	31.58	326	171	A	V
		*	2437	109.82	-	-	100.01	27.28	14.1	31.57	326	171	P	V
		*	2437	99.79	-	-	89.98	27.28	14.1	31.57	326	171	A	V
		2492.58	56.25	-17.75	74	46.26	27.4	14.14	31.55	326	171	P	V	
		2483.55	43.49	-10.51	54	33.55	27.36	14.14	31.56	326	171	A	V	



802.11n HT20 CH 11 2462MHz	*	2462	108.5	-	-	98.63	27.32	14.11	31.56	110	128	P	H
	*	2462	98.99	-	-	89.12	27.32	14.11	31.56	110	128	A	H
		2484.4	65.85	-8.15	74	55.91	27.36	14.14	31.56	110	128	P	H
		2483.8	51	-3	54	41.06	27.36	14.14	31.56	110	128	A	H
													H
													H
	*	2462	104.88	-	-	95.01	27.32	14.11	31.56	400	169	P	V
	*	2462	94.88	-	-	85.01	27.32	14.11	31.56	400	169	A	V
		2484.04	65.93	-8.07	74	55.99	27.36	14.14	31.56	400	169	P	V
		2483.56	49.01	-4.99	54	39.07	27.36	14.14	31.56	400	169	A	V
													V
												V	
Remark	1. No other spurious found. 2. All results are PASS against Peak and Average limit line.												



**2.4GHz 2400~2483.5MHz
WIFI 802.11n HT20 (Harmonic @ 3m)**

WIFI Ant. 1	Note	Frequency (MHz)	Level (dBμV/m)	Over Limit (dB)	Limit Line (dBμV/m)	Read Level (dBμV)	Antenna Factor (dB/m)	Path Loss (dB)	Preamp Factor (dB)	Ant Pos (cm)	Table Pos (deg)	Peak Avg. (P/A)	Pol. (H/V)	
802.11n HT20 CH 01 2412MHz		4824	45.51	-28.49	74	72.19	31.36	6.7	64.74	100	0	P	H	
													H	
													H	
													H	
			4824	41.99	-32.01	74	68.67	31.36	6.7	64.74	100	0	P	V
														V
														V
802.11n HT20 CH 06 2437MHz		4874	48.44	-25.56	74	74.95	31.46	6.73	64.7	100	0	P	H	
		7311	48.36	-25.64	74	69	36.11	8.07	64.82	100	0	P	H	
													H	
													H	
			4874	44.72	-29.28	74	71.23	31.46	6.73	64.7	100	0	P	V
			7311	47.11	-26.89	74	67.75	36.11	8.07	64.82	100	0	P	V
														V
802.11n HT20 CH 11 2462MHz		4924	43.8	-30.2	74	70.17	31.56	6.73	64.66	100	0	P	H	
		7386	47.8	-26.2	74	68.32	36.33	8.01	64.86	100	0	P	H	
													H	
													H	
			4924	41.39	-32.61	74	67.76	31.56	6.73	64.66	100	0	P	V
			7386	46.13	-27.87	74	66.65	36.33	8.01	64.86	100	0	P	V
														V
Remark	1. No other spurious found.													
	2. All results are PASS against Peak and Average limit line.													



Note symbol

*	Fundamental Frequency which can be ignored. However, the level of any unwanted emissions shall not exceed the level of the fundamental frequency.
!	Test result is over limit line.
P/A	Peak or Average
H/V	Horizontal or Vertical



A calculation example for radiated spurious emission is shown as below:

WIFI	Note	Frequency	Level	Over	Limit	Read	Antenna	Path	Preamp	Ant	Table	Peak	Pol.
Ant.				Limit	Line	Level	Factor	Loss	Factor	Pos	Pos	Avg.	
1		(MHz)	(dBμV/m)	(dB)	(dBμV/m)	(dBμV)	(dB/m)	(dB)	(dB)	(cm)	(deg)	(P/A)	(H/V)
802.11b		2390	55.45	-18.55	74	54.51	32.22	4.58	35.86	103	308	P	H
CH 01													
2412MHz		2390	43.54	-10.46	54	42.6	32.22	4.58	35.86	103	308	A	H

1. Path Loss(dB) = Cable loss(dB) + Filter loss(dB) + Attenuator loss(dB)
2. Level(dBμV/m) =
Antenna Factor(dB/m) + Path Loss(dB) + Read Level(dBμV) - Preamp Factor(dB)
3. Over Limit(dB) = Level(dBμV/m) – Limit Line(dBμV/m)

For Peak Limit @ 2390MHz:

1. Level(dBμV/m)
= Antenna Factor(dB/m) + Path Loss(dB) + Read Level(dBμV) - Preamp Factor(dB)
= 32.22(dB/m) + 4.58(dB) + 54.51(dBμV) – 35.86 (dB)
= 55.45 (dBμV/m)
2. Over Limit(dB)
= Level(dBμV/m) – Limit Line(dBμV/m)
= 55.45(dBμV/m) – 74(dBμV/m)
= -18.55(dB)

For Average Limit @ 2390MHz:

1. Level(dBμV/m)
= Antenna Factor(dB/m) + Path Loss(dB) + Read Level(dBμV) - Preamp Factor(dB)
= 32.22(dB/m) + 4.58(dB) + 42.6(dBμV) – 35.86 (dB)
= 43.54 (dBμV/m)
2. Over Limit(dB)
= Level(dBμV/m) – Limit Line(dBμV/m)
= 43.54(dBμV/m) – 54(dBμV/m)
= -10.46(dB)

Both peak and average measured complies with the limit line, so test result is “PASS”.



Appendix D. Radiated Spurious Emission Plots

Test Engineer :	Watt Tseng, Karl Hou, and Nick Yu	Temperature :	22~23°C
		Relative Humidity :	59~61%

Note symbol

-L	Low channel location
-R	High channel location



2.4GHz 2400~2483.5MHz

WIFI 802.11b (Band Edge @ 3m)

WIFI	2.4GHz 2400~2483.5MHz Band Edge @ 3m	
ANT	802.11b CH01 2412MHz	
1	Horizontal	Fundamental
Peak	<p>Site : 03CH12-HY Condition : PEAK_BE_74 3m HORN_9120D_1328 HORIZONTAL RBW:1000.000kHz VBW:3000.000kHz SWT:Auto Detector : Peak Project : 822214 Mode : 1 Setting : 17</p>	<p>Site : 03CH12-HY Condition : PEAK_74 3m HORN_9120D_1328 HORIZONTAL RBW:1000.000kHz VBW:3000.000kHz SWT:Auto Detector : Peak Project : 822214 Mode : 1 Setting : 17</p>
Avg.	<p>Site : 03CH12-HY Condition : AVG_BE_54 3m HORN_9120D_1328 HORIZONTAL RBW:1000.000kHz VBW:0.010kHz SWT:Auto Detector : Peak Project : 822214 Mode : 1 Setting : 17</p>	<p>Site : 03CH12-HY Condition : AVG_54 3m HORN_9120D_1328 HORIZONTAL RBW:1000.000kHz VBW:0.010kHz SWT:Auto Detector : Peak Project : 822214 Mode : 1 Setting : 17</p>

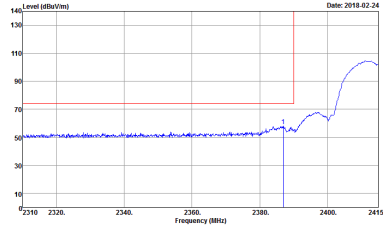
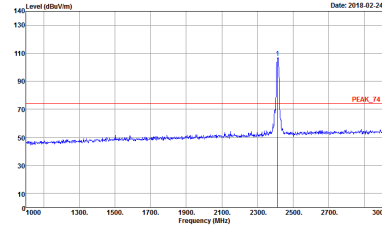
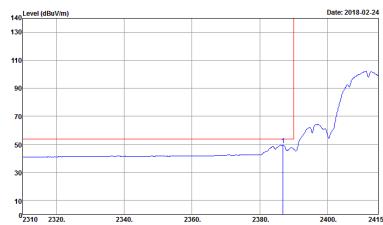
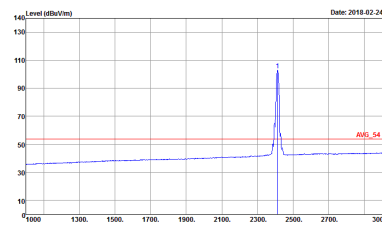

WIFI	2.4GHz 2400~2483.5MHz Band Edge @ 3m	
ANT	802.11b CH01 2412MHz	
1	Vertical	Fundamental
Peak	 <p>Site : 03CH12-HY Condition : PEAK_9C_74 3m HORN_91200_1328 VERTICAL RBW:3000.000kHz VBW:3000.000kHz SWT:Auto Detector : Peak Project : 822214 Mode : 1 Setting : 17</p>	 <p>Site : 03CH12-HY Condition : PEAK_74 3m HORN_91200_1328 VERTICAL RBW:3000.000kHz VBW:3000.000kHz SWT:Auto Detector : Peak Project : 822214 Mode : 1 Setting : 17</p>
Avg.	 <p>Site : 03CH12-HY Condition : AVG_BE_54 3m HORN_91200_1328 VERTICAL RBW:3000.000kHz VBW:0.010kHz SWT:Auto Detector : Peak Project : 822214 Mode : 1 Setting : 17</p>	 <p>Site : 03CH12-HY Condition : AVG_54 3m HORN_91200_1328 VERTICAL RBW:3000.000kHz VBW:0.010kHz SWT:Auto Detector : Peak Project : 822214 Mode : 1 Setting : 17</p>



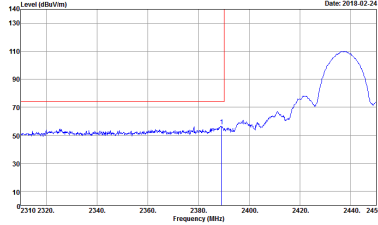
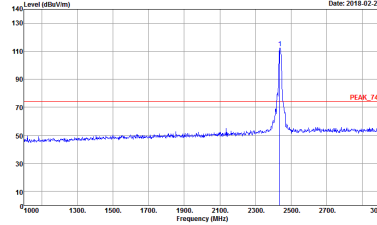
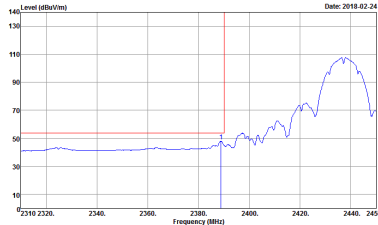
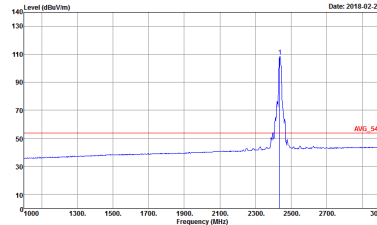

WIFI	2.4GHz 2400~2483.5MHz Band Edge @ 3m	
ANT	802.11b CH06 2437MHz - L	
1	Horizontal	Fundamental
Peak	 <p>Site : 03CH12-HY Condition : PEAK_9C_74 3m HORN_91200_1328 HORIZONTAL RBW:3000.000KHz VBW:3000.000KHz SWT:Auto Detector : Peak Project : 822214 Mode : 2 Setting : 18.5</p>	 <p>Site : 03CH12-HY Condition : PEAK_74 3m HORN_91200_1328 HORIZONTAL RBW:3000.000KHz VBW:3000.000KHz SWT:Auto Detector : Peak Project : 822214 Mode : 2 Setting : 18.5</p>
Avg.	 <p>Site : 03CH12-HY Condition : AVG_BE_54 3m HORN_91200_1328 HORIZONTAL RBW:3000.000KHz VBW:10.000KHz SWT:Auto Detector : Peak Project : 822214 Mode : 2 Setting : 18.5</p>	 <p>Site : 03CH12-HY Condition : AVG_54 3m HORN_91200_1328 HORIZONTAL RBW:3000.000KHz VBW:10.000KHz SWT:Auto Detector : Peak Project : 822214 Mode : 2 Setting : 18.5</p>

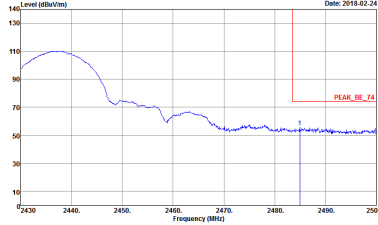
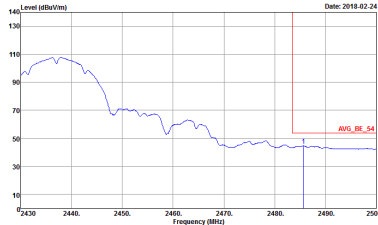

WIFI	2.4GHz 2400~2483.5MHz Band Edge @ 3m	
ANT	802.11b CH06 2437MHz - R	
1	Horizontal	Fundamental
<p>Peak</p>	 <p>Site : 03CH2-HY Condition : PEAK_BE_74 3m HORN_9120D_1328 HORIZONTAL Detector : Peak Project : 822214 Mode : 2 Setting : 18.5</p>	<p>Left blank</p>
<p>Avg.</p>	 <p>Site : 03CH2-HY Condition : AVG_BE_54 3m HORN_9120D_1328 HORIZONTAL Detector : Peak Project : 822214 Mode : 2 Setting : 18.5</p>	<p>Left blank</p>

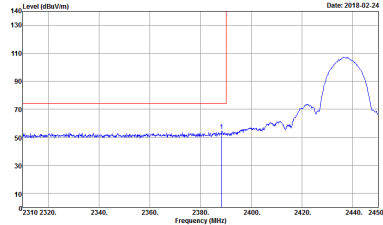
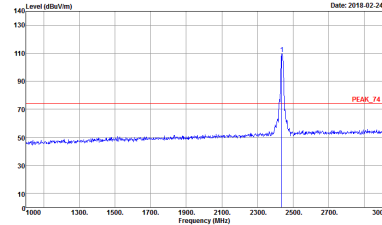

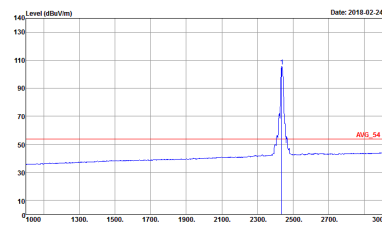
WIFI	2.4GHz 2400~2483.5MHz Band Edge @ 3m	
ANT	802.11b CH06 2437MHz - L	
1	Vertical	Fundamental
Peak	 <p>Site : 03CH12-11Y Condition : PEAK_9C_74 3m HORN_91200_1328 VERTICAL RBW:3000.000kHz VBW:3000.000kHz SWT:Auto Detector : Peak Project : 822214 Mode : 2 Setting : 18.5</p>	 <p>Site : 03CH12-11Y Condition : PEAK_74 3m HORN_91200_1328 VERTICAL RBW:3000.000kHz VBW:3000.000kHz SWT:Auto Detector : Peak Project : 822214 Mode : 2 Setting : 18.5</p>
Avg.	 <p>Site : 03CH12-11Y Condition : AVG_BE_54 3m HORN_91200_1328 VERTICAL RBW:3000.000kHz VBW:0.010kHz SWT:Auto Detector : Peak Project : 822214 Mode : 2 Setting : 18.5</p>	 <p>Site : 03CH12-11Y Condition : AVG_54 3m HORN_91200_1328 VERTICAL RBW:3000.000kHz VBW:0.010kHz SWT:Auto Detector : Peak Project : 822214 Mode : 2 Setting : 18.5</p>



WIFI	2.4GHz 2400~2483.5MHz Band Edge @ 3m	
ANT	802.11b CH06 2437MHz - R	
1	Vertical	Fundamental
<p>Peak</p>		<p>Left blank</p>
<p>Avg.</p>		<p>Left blank</p>

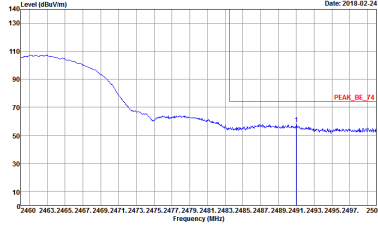
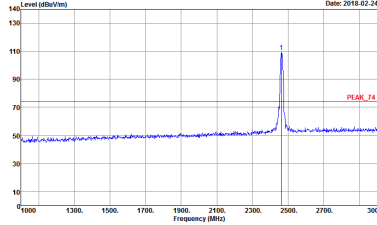
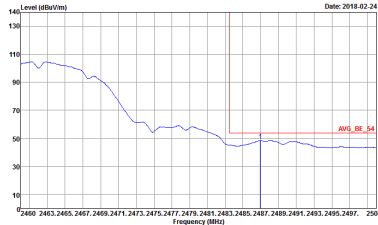
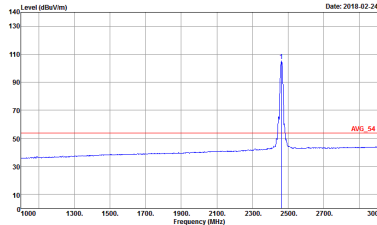

WIFI	2.4GHz 2400~2483.5MHz Band Edge @ 3m	
ANT	802.11b CH11 2462MHz	
1	Horizontal	Fundamental
Peak	 <p>Site : 03CH12-HY Condition : PEAK_BE_74 3m HORN_9120D_1328 HORIZONTAL RBW:3000.000KHz VBW:3000.000KHz SWT:Auto Detector : Peak Project : 822214 Mode : 3 Setting : 17</p>	 <p>Site : 03CH12-HY Condition : PEAK_74 3m HORN_9120D_1328 HORIZONTAL RBW:3000.000KHz VBW:3000.000KHz SWT:Auto Detector : Peak Project : 822214 Mode : 3 Setting : 17</p>
Avg.	 <p>Site : 03CH12-HY Condition : AVG_BE_54 3m HORN_9120D_1328 HORIZONTAL RBW:3000.000KHz VBW:0.030KHz SWT:Auto Detector : Peak Project : 822214 Mode : 3 Setting : 17</p>	 <p>Site : 03CH12-HY Condition : AVG_54 3m HORN_9120D_1328 HORIZONTAL RBW:3000.000KHz VBW:0.030KHz SWT:Auto Detector : Peak Project : 822214 Mode : 3 Setting : 17</p>

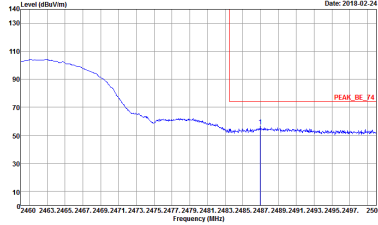
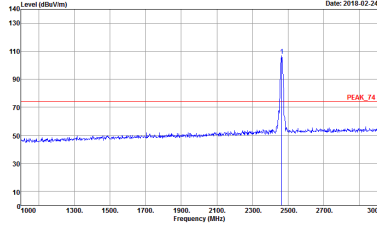
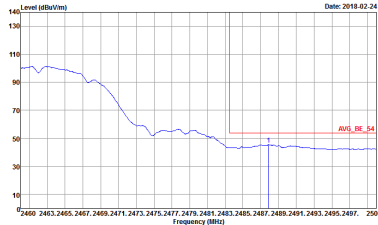
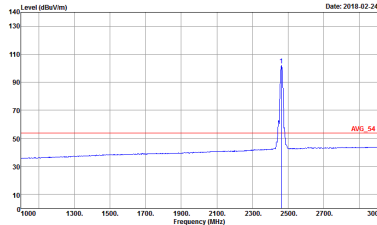

WIFI	2.4GHz 2400~2483.5MHz Band Edge @ 3m	
ANT	802.11b CH11 2462MHz	
1	Vertical	Fundamental
Peak	 <p>Site : 03CH12-HY Condition : PEAK_BE_74 3m HORN_9120D_1328 VERTICAL RBW:3000.000kHz VBW:3000.000kHz SWT:Auto Detector : Peak Project : 822214 Mode : 3 Setting : 17</p>	 <p>Site : 03CH12-HY Condition : PEAK_74 3m HORN_9120D_1328 VERTICAL RBW:3000.000kHz VBW:3000.000kHz SWT:Auto Detector : Peak Project : 822214 Mode : 3 Setting : 17</p>
Avg.	 <p>Site : 03CH12-HY Condition : AVG_BE_54 3m HORN_9120D_1328 VERTICAL RBW:3000.000kHz VBW:0.010kHz SWT:Auto Detector : Peak Project : 822214 Mode : 3 Setting : 17</p>	 <p>Site : 03CH12-HY Condition : AVG_54 3m HORN_9120D_1328 VERTICAL RBW:3000.000kHz VBW:0.010kHz SWT:Auto Detector : Peak Project : 822214 Mode : 3 Setting : 17</p>



2.4GHz 2400~2483.5MHz
WIFI 802.11g (Band Edge @ 3m)

Table with 4 columns: WIFI, ANT, 1, and two sub-columns for Horizontal and Fundamental. Rows are labeled 'Peak' and 'Avg.' containing spectral plots and technical parameters.

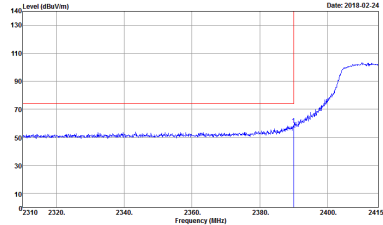
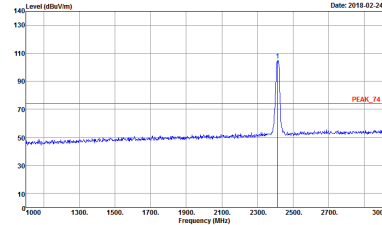
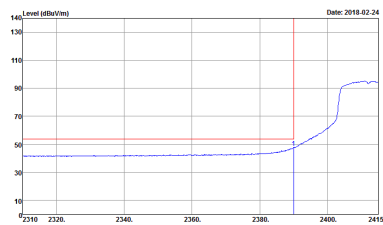
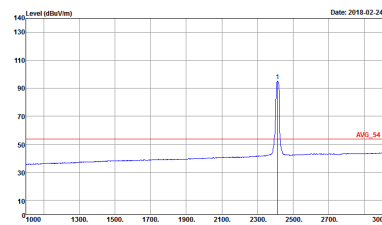

WIFI	2.4GHz 2400~2483.5MHz Band Edge @ 3m	
ANT	802.11g CH01 2412MHz	
1	Vertical	Fundamental
Peak	 <p>Site : 03CH12-HY Condition : PEAK_9C_74 3m HORN_9120D_1328 VERTICAL RBW:3000.000kHz VBW:3000.000kHz SWT:Auto Detector : Peak Project : 822214 Mode : 4 Setting : 13.5</p>	 <p>Site : 03CH12-HY Condition : PEAK_74 3m HORN_9120D_1328 VERTICAL RBW:3000.000kHz VBW:3000.000kHz SWT:Auto Detector : Peak Project : 822214 Mode : 4 Setting : 13.5</p>
Avg.	 <p>Site : 03CH12-HY Condition : AVG_BE_54 3m HORN_9120D_1328 VERTICAL RBW:3000.000kHz VBW:1.000kHz SWT:Auto Detector : Peak Project : 822214 Mode : 4 Setting : 13.5</p>	 <p>Site : 03CH12-HY Condition : AVG_54 3m HORN_9120D_1328 VERTICAL RBW:3000.000kHz VBW:1.000kHz SWT:Auto Detector : Peak Project : 822214 Mode : 4 Setting : 13.5</p>

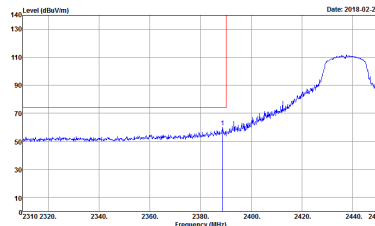
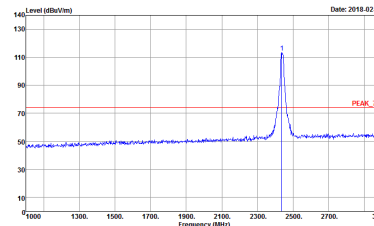
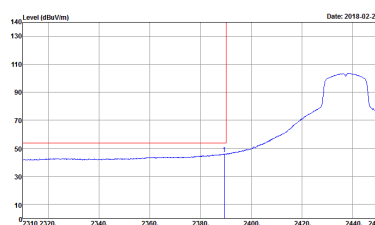
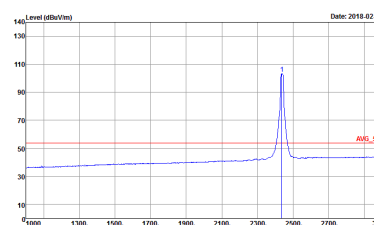

WIFI	2.4GHz 2400~2483.5MHz Band Edge @ 3m	
ANT	802.11g CH06 2437MHz - L	
1	Horizontal	Fundamental
Peak	 <p>Site : 03CH12-11Y Condition : PEAK_BE_74 3m HORN_91200_1328 HORIZONTAL RBW:3000.000kHz VBW:3000.000kHz SWT:Auto Detector : Peak Project : 822214 Mode : 6 Setting : 19</p>	 <p>Site : 03CH12-11Y Condition : PEAK_F4 3m HORN_91200_1328 HORIZONTAL RBW:3000.000kHz VBW:3000.000kHz SWT:Auto Detector : Peak Project : 822214 Mode : 6 Setting : 19</p>
Avg.	 <p>Site : 03CH12-11Y Condition : AVG_BE_54 3m HORN_91200_1328 HORIZONTAL RBW:3000.000kHz VBW:1.000kHz SWT:Auto Detector : Peak Project : 822214 Mode : 6 Setting : 19</p>	 <p>Site : 03CH12-11Y Condition : AVG_F4 3m HORN_91200_1328 HORIZONTAL RBW:3000.000kHz VBW:1.000kHz SWT:Auto Detector : Peak Project : 822214 Mode : 6 Setting : 19</p>

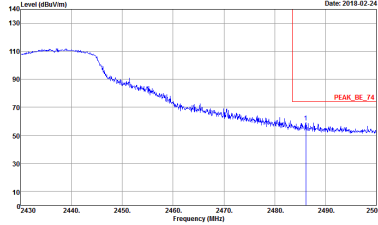
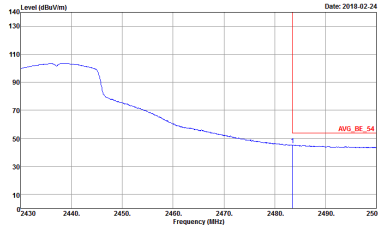

WIFI	2.4GHz 2400~2483.5MHz Band Edge @ 3m	
ANT	802.11g CH06 2437MHz - R	
1	Horizontal	Fundamental
<p>Peak</p>	 <p>Site : 03CH2-1Y Condition : PEAK_BE_74 3m HORN_9120D_1328 HORIZONTAL Detector : Peak Project : 822214 Mode : 0 Setting : 19</p>	<p>Left blank</p>
<p>Avg.</p>	 <p>Site : 03CH2-1Y Condition : AVG_BE_54 3m HORN_9120D_1328 HORIZONTAL Detector : Peak Project : 822214 Mode : 0 Setting : 19</p>	<p>Left blank</p>

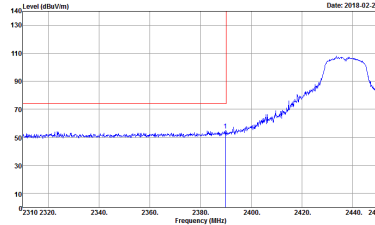
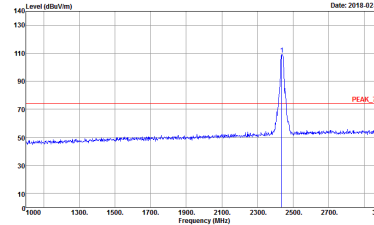
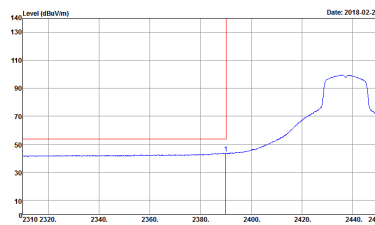
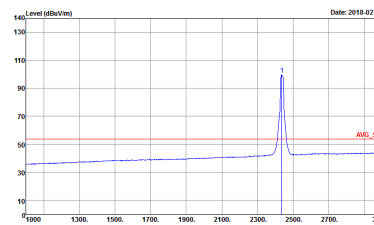

WIFI	2.4GHz 2400~2483.5MHz Band Edge @ 3m	
ANT	802.11g CH06 2437MHz - L	
1	Vertical	Fundamental
Peak	 <p>Site : 03CH12-11Y Condition : PEAK_BE_14 3m HORN_9120D_1328 VERTICAL RBW:1000.000KHz VBW:3000.000KHz SWT:Auto Detector : Peak Project : 822214 Mode : 6 Setting : 19</p>	 <p>Site : 03CH12-11Y Condition : PEAK_F4 3m HORN_9120D_1328 VERTICAL RBW:1000.000KHz VBW:3000.000KHz SWT:Auto Detector : Peak Project : 822214 Mode : 6 Setting : 19</p>
Avg.	 <p>Site : 03CH12-11Y Condition : AVG_BE_14 3m HORN_9120D_1328 VERTICAL RBW:1000.000KHz VBW:1.000KHz SWT:Auto Detector : Peak Project : 822214 Mode : 6 Setting : 19</p>	 <p>Site : 03CH12-11Y Condition : AVG_F4 3m HORN_9120D_1328 VERTICAL RBW:1000.000KHz VBW:1.000KHz SWT:Auto Detector : Peak Project : 822214 Mode : 6 Setting : 19</p>

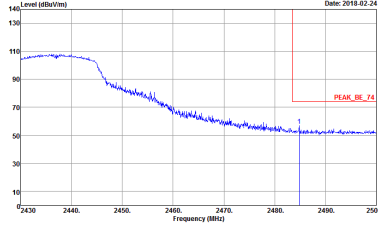
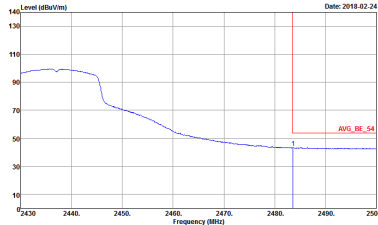

WIFI	2.4GHz 2400~2483.5MHz Band Edge @ 3m	
ANT	802.11g CH06 2437MHz - R	
1	Vertical	Fundamental
Peak	 <p>Site : 03CH2-HY Condition : PEAK_BE_74 3m HORN_9120D_1328 VERTICAL RBW:10000000Hz VBW:3000.0000Hz SWT:Auto Detector : Peak Project : 822214 Mode : 0 Setting : 19</p>	Left Blank
Avg.	 <p>Site : 03CH2-HY Condition : AVG_BE_54 3m HORN_9120D_1328 VERTICAL RBW:10000000Hz VBW:1.0000Hz SWT:Auto Detector : Peak Project : 822214 Mode : 0 Setting : 19</p>	Left Blank

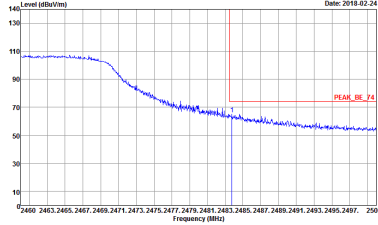
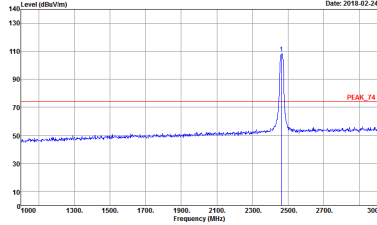
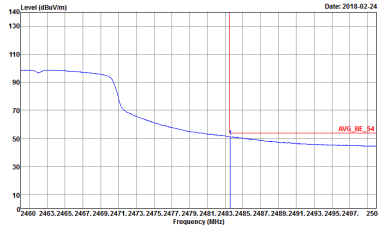
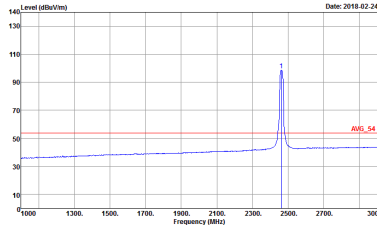

WIFI	2.4GHz 2400~2483.5MHz Band Edge @ 3m	
ANT	802.11g CH11 2462MHz	
1	Horizontal	Fundamental
Peak	 <p>Site : 03CH12-HY Condition : PEAK_BE_74 3m HORN_9120D_1328 HORIZONTAL RBW:3000.000KHz VBW:3000.000KHz SWT:Auto Detector : Peak Project : 822214 Mode : 0 Setting : 14.5</p>	 <p>Site : 03CH12-HY Condition : PEAK_74 3m HORN_9120D_1328 HORIZONTAL RBW:3000.000KHz VBW:3000.000KHz SWT:Auto Detector : Peak Project : 822214 Mode : 0 Setting : 14.5</p>
Avg.	 <p>Site : 03CH12-HY Condition : AVG_BE_54 3m HORN_9120D_1328 HORIZONTAL RBW:1000.000KHz VBW:1.000KHz SWT:Auto Detector : Peak Project : 822214 Mode : 0 Setting : 14.5</p>	 <p>Site : 03CH12-HY Condition : AVG_54 3m HORN_9120D_1328 HORIZONTAL RBW:1000.000KHz VBW:1.000KHz SWT:Auto Detector : Peak Project : 822214 Mode : 0 Setting : 14.5</p>

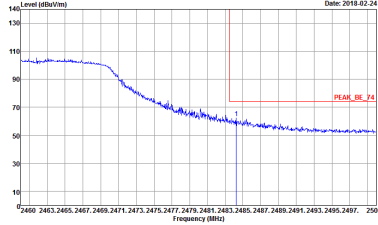
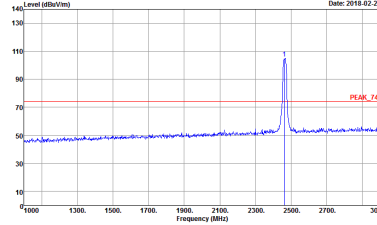
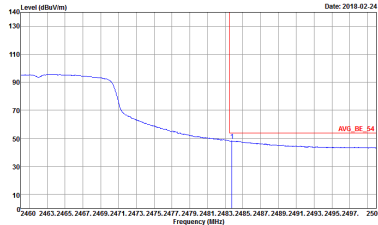
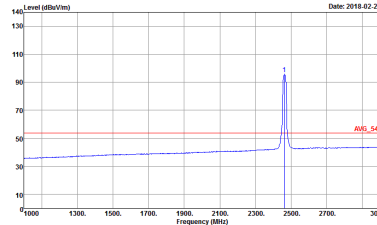

WIFI	2.4GHz 2400~2483.5MHz Band Edge @ 3m	
ANT	802.11g CH11 2462MHz	
1	Vertical	Fundamental
Peak	 <p>Site : 03CH12-HY Condition : PEAK_BE_74 3m HORN_9120D_1328 VERTICAL RBW:3000.000KHz VBW:3000.000KHz SWT:Auto Detector : Peak Project : 822214 Mode : 0 Setting : 14.5</p>	 <p>Site : 03CH12-HY Condition : PEAK_F4 3m HORN_9120D_1328 VERTICAL RBW:3000.000KHz VBW:3000.000KHz SWT:Auto Detector : Peak Project : 822214 Mode : 0 Setting : 14.5</p>
Avg.	 <p>Site : 03CH12-HY Condition : AVG_BE_54 3m HORN_9120D_1328 VERTICAL RBW:1000.000KHz VBW:1.000KHz SWT:Auto Detector : Peak Project : 822214 Mode : 0 Setting : 14.5</p>	 <p>Site : 03CH12-HY Condition : AVG_F4 3m HORN_9120D_1328 VERTICAL RBW:1000.000KHz VBW:1.000KHz SWT:Auto Detector : Peak Project : 822214 Mode : 0 Setting : 14.5</p>



2.4GHz 2400~2483.5MHz

WIFI 802.11n HT20 (Band Edge @ 3m)

WIFI	2.4GHz 2400~2483.5MHz Band Edge @ 3m	
ANT	802.11n HT20 CH01 2412MHz	
1	Horizontal	Fundamental
Peak	<p>Site : 03CH12-HY Condition : PEAK_BE_74 3m HORN_9120D_1328 HORIZONTAL Detector : Peak Project : 822214 Mode : 7 Setting : 13.5</p>	<p>Site : 03CH12-HY Condition : PEAK_F4 3m HORN_9120D_1328 HORIZONTAL Detector : Peak Project : 822214 Mode : 7 Setting : 13.5</p>
Avg.	<p>Site : 03CH12-HY Condition : AVG_BE_54 3m HORN_9120D_1328 HORIZONTAL Detector : Peak Project : 822214 Mode : 7 Setting : 13.5</p>	<p>Site : 03CH12-HY Condition : AVG_F4 3m HORN_9120D_1328 HORIZONTAL Detector : Peak Project : 822214 Mode : 7 Setting : 13.5</p>



WIFI	2.4GHz 2400~2483.5MHz Band Edge @ 3m	
ANT	802.11n HT20 CH01 2412MHz	
1	Vertical	Fundamental
Peak	<p>Site : 03CH12-HY Condition : PEAK_9C_74 3m HORN_9120D_1328 VERTICAL RBW:1000.000kHz VBW:3000.000kHz SWT:Auto Detector : Peak Project : 822214 Mode : 7 Setting : 13.5</p>	<p>Site : 03CH12-HY Condition : PEAK_74 3m HORN_9120D_1328 VERTICAL RBW:1000.000kHz VBW:3000.000kHz SWT:Auto Detector : Peak Project : 822214 Mode : 7 Setting : 13.5</p>
Avg.	<p>Site : 03CH12-HY Condition : AVG_BE_54 3m HORN_9120D_1328 VERTICAL RBW:1000.000kHz VBW:1.000kHz SWT:Auto Detector : Peak Project : 822214 Mode : 7 Setting : 13.5</p>	<p>Site : 03CH12-HY Condition : AVG_54 3m HORN_9120D_1328 VERTICAL RBW:1000.000kHz VBW:1.000kHz SWT:Auto Detector : Peak Project : 822214 Mode : 7 Setting : 13.5</p>

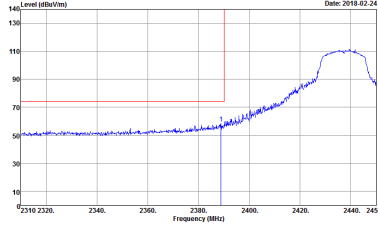
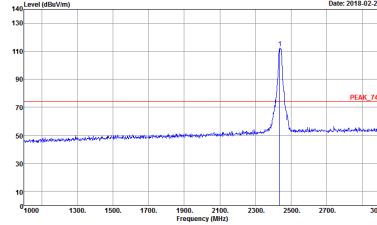
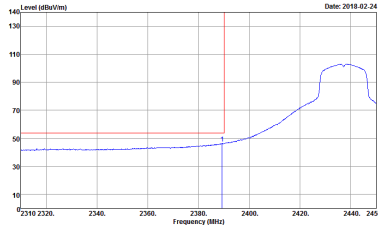
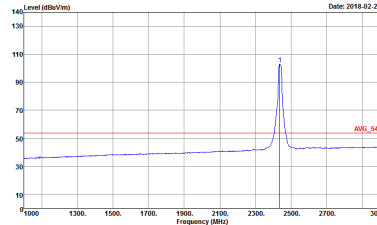

WIFI	2.4GHz 2400~2483.5MHz Band Edge @ 3m	
ANT	802.11n HT20 CH06 2437MHz - L	
1	Horizontal	Fundamental
Peak	 <p>Site : 03CH12-11Y Condition : PEAK_BE_74 3m HORN_9120D_1328 HORIZONTAL RBW:3000.000KHz VBW:3000.000KHz SWT:Auto Detector : Peak Project : 822214 Mode : 8 Setting : 19</p>	 <p>Site : 03CH12-11Y Condition : PEAK_F4 3m HORN_9120D_1328 HORIZONTAL RBW:3000.000KHz VBW:3000.000KHz SWT:Auto Detector : Peak Project : 822214 Mode : 8 Setting : 19</p>
Avg.	 <p>Site : 03CH12-11Y Condition : AVG_BE_54 3m HORN_9120D_1328 HORIZONTAL RBW:1000.000KHz VBW:1.000KHz SWT:Auto Detector : Peak Project : 822214 Mode : 8 Setting : 19</p>	 <p>Site : 03CH12-11Y Condition : AVG_F4 3m HORN_9120D_1328 HORIZONTAL RBW:1000.000KHz VBW:1.000KHz SWT:Auto Detector : Peak Project : 822214 Mode : 8 Setting : 19</p>



WIFI	2.4GHz 2400~2483.5MHz Band Edge @ 3m	
ANT	802.11n HT20 CH06 2437MHz - R	
1	Horizontal	Fundamental
Peak	<p>Site : 03CH2-1Y Condition : PEAK_BE_74 3m HORN_9120D_1328 HORIZONTAL Detector : Peak Project : 822214 Mode : 8 Setting : 19</p>	Left blank
Avg.	<p>Site : 03CH2-1Y Condition : AVG_BE_54 3m HORN_9120D_1328 HORIZONTAL Detector : Peak Project : 822214 Mode : 8 Setting : 19</p>	Left blank

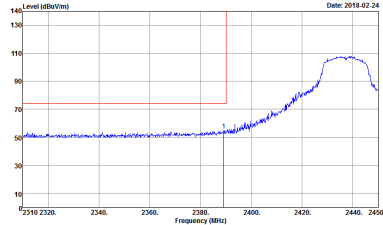
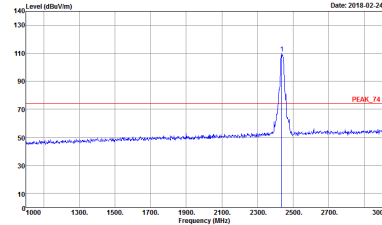
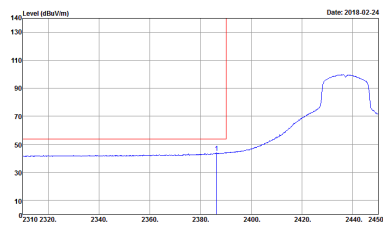
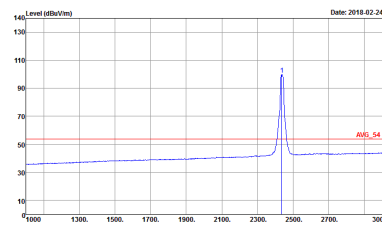

WIFI	2.4GHz 2400~2483.5MHz Band Edge @ 3m	
ANT	802.11n HT20 CH06 2437MHz - L	
1	Vertical	Fundamental
Peak	 <p>Site : 03CH12-11Y Condition : PEAK_9C_74 3m HORN_9120D_1328 VERTICAL RBW:1000.000KHz VBW:3000.000KHz SWT:Auto Detector : Peak Project : 822214 Mode : 8 Setting : 19</p>	 <p>Site : 03CH12-11Y Condition : PEAK_74 3m HORN_9120D_1328 VERTICAL RBW:1000.000KHz VBW:3000.000KHz SWT:Auto Detector : Peak Project : 822214 Mode : 8 Setting : 19</p>
Avg.	 <p>Site : 03CH12-11Y Condition : AVG_BE_54 3m HORN_9120D_1328 VERTICAL RBW:1000.000KHz VBW:1.000KHz SWT:Auto Detector : Peak Project : 822214 Mode : 8 Setting : 19</p>	 <p>Site : 03CH12-11Y Condition : AVG_54 3m HORN_9120D_1328 VERTICAL RBW:1000.000KHz VBW:1.000KHz SWT:Auto Detector : Peak Project : 822214 Mode : 8 Setting : 19</p>

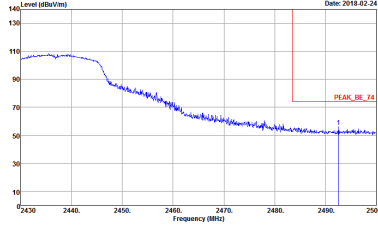
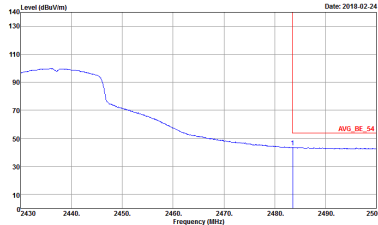

WIFI	2.4GHz 2400~2483.5MHz Band Edge @ 3m	
ANT	802.11n HT20 CH06 2437MHz - R	
1	Vertical	Fundamental
Peak	 <p>Site : 03CH2-HY Condition : PEAK_BE_74 3m HORN_9120D_1328 VERTICAL RBW:10000000Hz VBW:3000.0000Hz SWT:Auto Detector : Peak Project : 822214 Mode : 8 Setting : 19</p>	Left Blank
Avg.	 <p>Site : 03CH2-HY Condition : AVG_BE_54 3m HORN_9120D_1328 VERTICAL RBW:10000000Hz VBW:1.0000Hz SWT:Auto Detector : Peak Project : 822214 Mode : 8 Setting : 19</p>	Left Blank

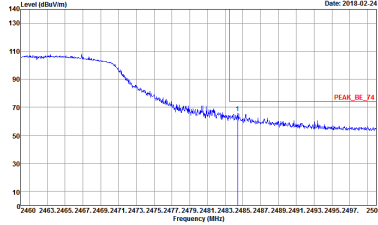
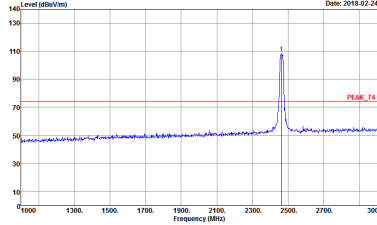
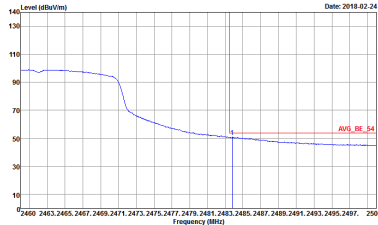
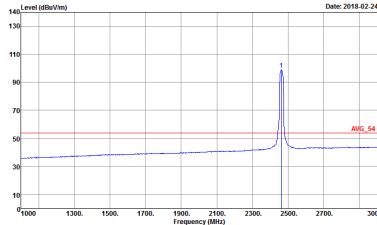

WIFI	2.4GHz 2400~2483.5MHz Band Edge @ 3m	
ANT	802.11n HT20 CH11 2462MHz	
1	Horizontal	Fundamental
Peak	 <p>Site : 03CH12-HY Condition : PEAK_BE_74 3m HORN_9120D_1328 HORIZONTAL Detector : Peak Project : 822214 Mode : 9 Setting : 14</p>	 <p>Site : 03CH12-HY Condition : PEAK_F4 3m HORN_9120D_1328 HORIZONTAL Detector : Peak Project : 822214 Mode : 9 Setting : 14</p>
Avg.	 <p>Site : 03CH12-HY Condition : AVG_BE_54 3m HORN_9120D_1328 HORIZONTAL Detector : Peak Project : 822214 Mode : 9 Setting : 14</p>	 <p>Site : 03CH12-HY Condition : AVG_F4 3m HORN_9120D_1328 HORIZONTAL Detector : Peak Project : 822214 Mode : 9 Setting : 14</p>

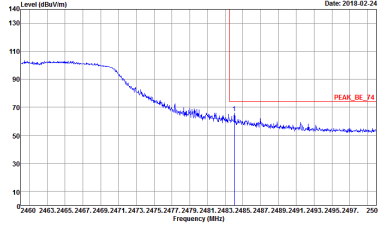
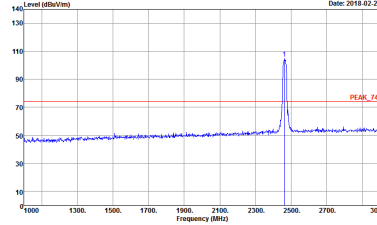
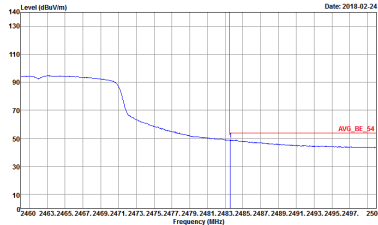
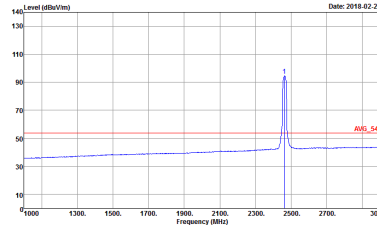

WIFI	2.4GHz 2400~2483.5MHz Fundamental @ 3m	
ANT	802.11n HT20 CH11 2462MHz	
1	Vertical	Fundamental
Peak	 <p>Site : 03CH12-HY Condition : PEAK_BE_74 3m HORN_9120D_1328 VERTICAL RBW:3000.000KHz VBW:3000.000KHz SWT:Auto Detector : Peak Project : 822214 Mode : 9 Setting : 14</p>	 <p>Site : 03CH12-HY Condition : PEAK_74 3m HORN_9120D_1328 VERTICAL RBW:3000.000KHz VBW:3000.000KHz SWT:Auto Detector : Peak Project : 822214 Mode : 9 Setting : 14</p>
Avg.	 <p>Site : 03CH12-HY Condition : AVG_BE_54 3m HORN_9120D_1328 VERTICAL RBW:3000.000KHz VBW:1.000KHz SWT:Auto Detector : Peak Project : 822214 Mode : 9 Setting : 14</p>	 <p>Site : 03CH12-HY Condition : AVG_54 3m HORN_9120D_1328 VERTICAL RBW:3000.000KHz VBW:1.000KHz SWT:Auto Detector : Peak Project : 822214 Mode : 9 Setting : 14</p>



2.4GHz 2400~2483.5MHz
WIFI 802.11b (Harmonic @ 3m)

WIFI	2.4GHz 2400~2483.5MHz Harmonic @ 3m	
ANT	802.11b CH01 2412MHz	
1	Horizontal	Vertical
Peak Avg.	<p>Site : 03CH12-44Y Condition : PEAK_74 3m HORN_91200_1328 HORIZONTAL Detector : Peak Project : 822214 Mode : 1 Setting : 17</p>	<p>Site : 03CH12-44Y Condition : PEAK_74 3m HORN_91200_1328 VERTICAL Detector : Peak Project : 822214 Mode : 1 Setting : 17</p>



WIFI	2.4GHz 2400~2483.5MHz Harmonic @ 3m	
ANT	802.11b CH06 2437MHz	
1	Horizontal	Vertical
Peak Avg.	<p>Site : 03CH2-11Y Condition : PEAK_74 3m HORN_91200_1328 HORIZONTAL Detector : Peak Project : 822214 Mode : 2 Setting : 18.5</p>	<p>Site : 03CH2-11Y Condition : PEAK_74 3m HORN_91200_1328 VERTICAL Detector : Peak Project : 822214 Mode : 2 Setting : 18.5</p>



WIFI	2.4GHz 2400~2483.5MHz Harmonic @ 3m	
ANT	802.11b CH11 2462MHz	
1	Horizontal	Vertical
Peak Avg.	<p>Site : 03CH12-11Y Condition : PEAK_74 3m HORN_91200_1328 HORIZONTAL Detector : Peak Project : 822214 Mode : 3 Setting : 17</p>	<p>Site : 03CH12-11Y Condition : PEAK_74 3m HORN_91200_1328 VERTICAL Detector : Peak Project : 822214 Mode : 3 Setting : 17</p>



2.4GHz 2400~2483.5MHz
WIFI 802.11g (Harmonic @ 3m)

WIFI	2.4GHz 2400~2483.5MHz Harmonic @ 3m	
ANT	802.11g CH01 2412MHz	
1	Horizontal	Vertical
Peak Avg.	<p>Site : 03CH12-44Y Condition : PEAK_74 3m HORN_91200_1328 HORIZONTAL Detector : Peak Project : 822214 Mode : 4 Setting : 13.5</p>	<p>Site : 03CH12-44Y Condition : PEAK_74 3m HORN_91200_1328 VERTICAL Detector : Peak Project : 822214 Mode : 4 Setting : 13.5</p>

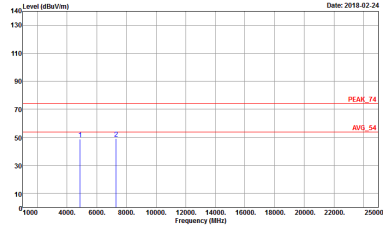
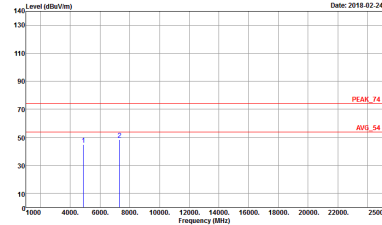

WIFI	2.4GHz 2400~2483.5MHz Harmonic @ 3m	
ANT	802.11g CH06 2437MHz	
1	Horizontal	Vertical
<p>Peak</p> <p>Avg.</p>	 <p>Site : 03CH2-11Y Condition : PEAK_F4 3m HORN_91200_1328 HORIZONTAL Detector : Peak Project : 822214 Mode : 6 Setting : 19</p>	 <p>Site : 03CH2-11Y Condition : PEAK_F4 3m HORN_91200_1328 VERTICAL Detector : Peak Project : 822214 Mode : 6 Setting : 19</p>



WIFI	2.4GHz 2400~2483.5MHz Harmonic @ 3m	
ANT	802.11g CH11 2462MHz	
1	Horizontal	Vertical
Peak Avg.	<p>Site : 03CH12-11Y Condition : PEAK_74 3m HORN_91200_1328 HORIZONTAL Detector : Peak Project : 822214 Mode : 6 Setting : 14.5</p>	<p>Site : 03CH12-11Y Condition : PEAK_74 3m HORN_91200_1328 VERTICAL Detector : Peak Project : 822214 Mode : 6 Setting : 14.5</p>



2.4GHz 2400~2483.5MHz
WIFI 802.11n HT20 (Harmonic @ 3m)

WIFI	2.4GHz 2400~2483.5MHz Harmonic @ 3m	
ANT	802.11n HT20 CH01 2412MHz	
1	Horizontal	Vertical
Peak Avg.		

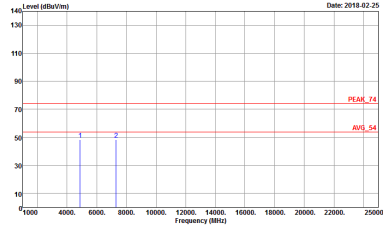
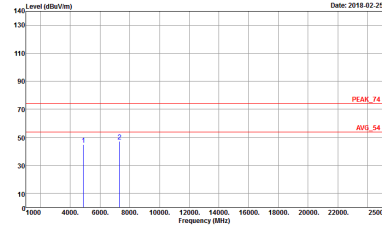

WIFI	2.4GHz 2400~2483.5MHz Harmonic @ 3m	
ANT	802.11n HT20 CH06 2437MHz	
1	Horizontal	Vertical
<p>Peak</p> <p>Avg.</p>	 <p>Site : 03CH2-11Y Condition : PEAK_74 3m HORN_91200_1328 HORIZONTAL Detector : Peak Project : 822214 Mode : 9 Setting : 19</p>	 <p>Site : 03CH2-11Y Condition : PEAK_74 3m HORN_91200_1328 VERTICAL Detector : Peak Project : 822214 Mode : 9 Setting : 19</p>



WIFI	2.4GHz 2400~2483.5MHz Harmonic @ 3m	
ANT	802.11n HT20 CH11 2462MHz	
1	Horizontal	Vertical
Peak Avg.	<p>Site : 03CH12-1#Y Condition : PEAK_74 3m HORN_91200_1328 HORIZONTAL Detector : Peak Project : 822214 Mode : 9 Setting : 14</p>	<p>Site : 03CH12-1#Y Condition : PEAK_74 3m HORN_91200_1328 VERTICAL Detector : Peak Project : 822214 Mode : 9 Setting : 14</p>



Emission below 1GHz
2.4GHz WIFI 802.11b (LF)

WIFI	2.4GHz 2400~2483.5MHz	
ANT	802.11b LF	
1	Horizontal	Vertical
QP / Peak	<p>Site : 03CH12-HY Condition : QP 3m 802.11b_6111D_40103 HORIZONTAL Detector : Peak Project : 822214 Mode : 16</p>	<p>Site : 03CH12-HY Condition : QP 3m 802.11b_6111D_40103 VERTICAL Detector : Peak Project : 822214 Mode : 16</p>



Appendix E. Duty Cycle Plots

Band	Duty Cycle (%)	T(us)	1/T(kHz)	VBW Setting	Duty Factor (dB)
802.11b	99.04	-	-	10Hz	0.04
802.11g	95.41	2080.00	0.48	1kHz	0.20
2.4GHz 802.11n HT20	94.61	1930.00	0.52	1kHz	0.24

802.11b

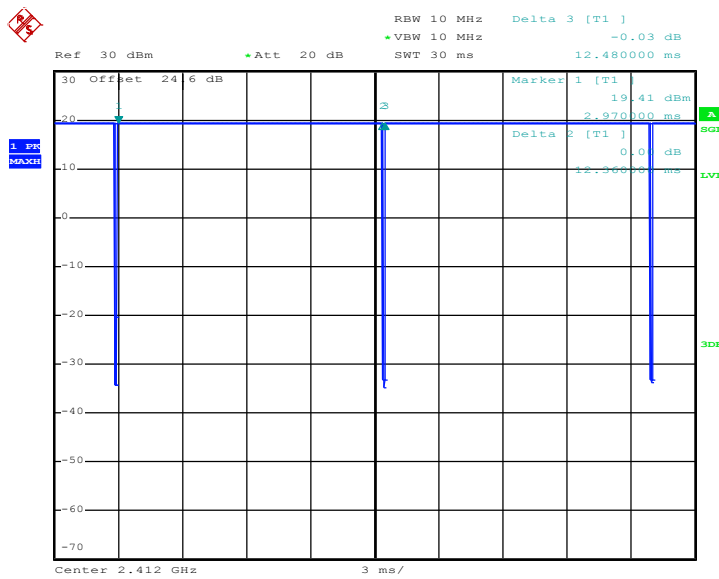

Date: 27.FEB.2018 15:26:07



802.11g

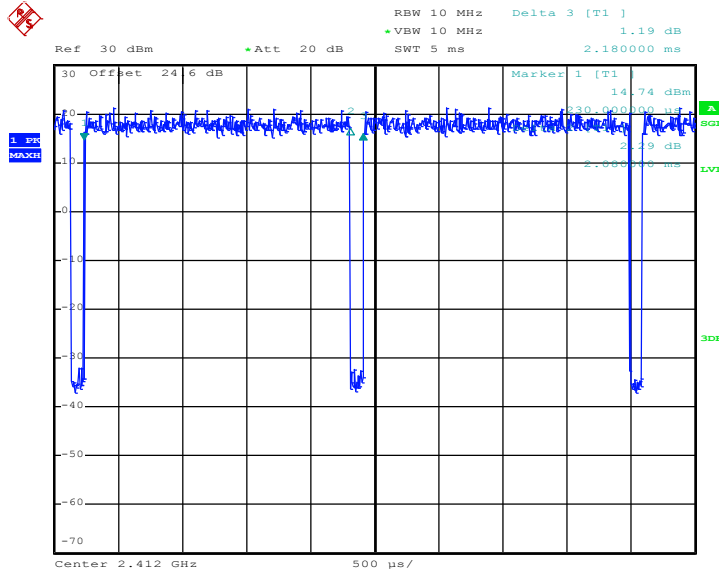

Date: 27.FEB.2018 15:42:56

802.11n HT20

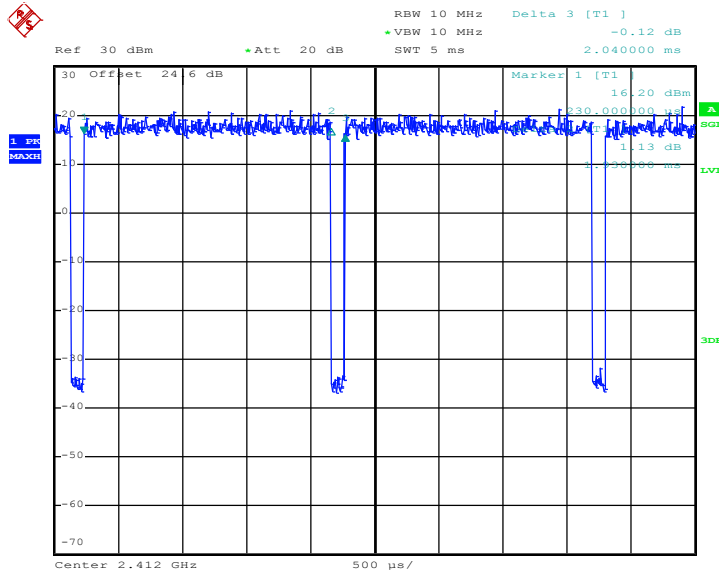

Date: 27.FEB.2018 16:14:33