



FCC RF Test Report

APPLICANT : UNIVERSAL GLOBAL SCIENTIFIC INDUSTRIAL CO., LTD.
EQUIPMENT : Wireless IoT module
BRAND NAME : UGSI
MODEL NAME : WM-BN-BM-22
FCC ID : COFWMBNBM22
STANDARD : FCC Part 15 Subpart C §15.247
CLASSIFICATION : (DTS) Digital Transmission System

The product was received on Feb. 22, 2018 and testing was completed on Mar. 28, 2018. We, SPORTON INTERNATIONAL INC., would like to declare that the tested sample has been evaluated in accordance with the test procedures and has been in compliance with the applicable technical standards.

The test results in this report apply exclusively to the tested model / sample. Without written approval of SPORTON INTERNATIONAL INC., the test report shall not be reproduced except in full.

Reviewed by: Joseph Lin / Supervisor

Approved by: Jones Tsai / Manager



SPORTON INTERNATIONAL INC.

No. 52, Hwa Ya 1st Rd., Hwa Ya Technology Park, Kwei-Shan District, Tao Yuan City, Taiwan, R.O.C.

SPORTON INTERNATIONAL INC.

TEL : 886-3-327-3456

FAX : 886-3-328-4978

FCC ID: COFWMBNBM22

Page Number : 1 of 35

Report Issued Date : Mar. 29, 2018

Report Version : Rev. 02

Report Template No.: BU5-FR15CBT4.0 Version 2.0



TABLE OF CONTENTS

REVISION HISTORY.....3

SUMMARY OF TEST RESULT4

1 GENERAL DESCRIPTION.....5

 1.1 Applicant5

 1.2 Manufacturer.....5

 1.3 Product Feature of Equipment Under Test.....5

 1.4 Modification of EUT5

 1.5 Testing Location5

 1.6 Applicable Standards.....6

2 TEST CONFIGURATION OF EQUIPMENT UNDER TEST.....7

 2.1 Carrier Frequency Channel7

 2.2 Test Mode.....8

 2.3 Connection Diagram of Test System.....9

 2.4 Support Unit used in test configuration and system10

 2.5 EUT Operation Test Setup10

 2.6 Measurement Results Explanation Example.....11

3 TEST RESULT12

 3.1 6dB and 99% Bandwidth Measurement12

 3.2 Output Power Measurement.....16

 3.3 Power Spectral Density Measurement17

 3.4 Conducted Band Edges and Spurious Emission Measurement21

 3.5 Radiated Band Edges and Spurious Emission Measurement26

 3.6 AC Conducted Emission Measurement.....30

 3.7 Antenna Requirements33

4 LIST OF MEASURING EQUIPMENT.....34

5 UNCERTAINTY OF EVALUATION.....35

APPENDIX A. CONDUCTED TEST RESULTS

APPENDIX B. AC CONDUCTED EMISSION TEST RESULT

APPENDIX C. RADIATED SPURIOUS EMISSION

APPENDIX D. RADIATED SPURIOUS EMISSION PLOTS

APPENDIX E. DUTY CYCLE PLOTS

APPENDIX F. SETUP PHOTOGRAPHS



SUMMARY OF TEST RESULT

Report Section	FCC Rule	Description	Limit	Result	Remark
3.1	15.247(a)(2)	6dB Bandwidth	$\geq 0.5\text{MHz}$	Pass	-
3.1	-	99% Bandwidth	-	Pass	-
3.2	15.247(b)(3)	Peak Output Power	$\leq 30\text{dBm}$	Pass	-
3.3	15.247(e)	Power Spectral Density	$\leq 8\text{dBm}/3\text{kHz}$	Pass	-
3.4	15.247(d)	Conducted Band Edges and Spurious Emission	$\leq 20\text{dBc}$	Pass	-
3.5	15.247(d)	Radiated Band Edges and Spurious Emission	15.209(a) & 15.247(d)	Pass	Under limit 3.74 dB at 210.360 MHz
3.6	15.207	AC Conducted Emission	15.207(a)	Pass	Under limit 14.52 dB at 0.542 MHz
3.7	15.203 & 15.247(b)	Antenna Requirement	N/A	Pass	-



1 General Description

1.1 Applicant

UNIVERSAL GLOBAL SCIENTIFIC INDUSTRIAL CO., LTD.
141, Lane 351, Sec. 1, Taiping Road., Tsao-tuen, Nantou 54261, Taiwan

1.2 Manufacturer

UNIVERSAL GLOBAL SCIENTIFIC INDUSTRIAL CO., LTD.
141, Lane 351, Sec. 1, Taiping Road., Tsao-tuen, Nantou 54261, Taiwan

1.3 Product Feature of Equipment Under Test

Bluetooth and Wi-Fi 2.4GHz 802.11b/g/n

Product Specification subjective to this standard	
Antenna Type	WLAN: PIFA Antenna Bluetooth: PIFA Antenna

1.4 Modification of EUT

No modifications are made to the EUT during all test items.

1.5 Testing Location

Sporton Lab is accredited to ISO 17025 by Taiwan Accreditation Foundation (TAF code : 1190) and the FCC designation No. TW1190 and TW0007 under the FCC 2.948(e) by Mutual Recognition Agreement (MRA) in FCC Test.

Test Site	SPORTON INTERNATIONAL INC.	
Test Site Location	No. 52, Hwa Ya 1 st Rd., Hwa Ya Technology Park, Kwei-Shan District, Tao Yuan City, Taiwan, R.O.C. TEL: +886-3-327-3456 FAX: +886-3-328-4978	
Test Site No.	Sporton Site No.	
	TH05-HY	CO05-HY

Note: The test site complies with ANSI C63.4 2014 requirement.

Test Site	SPORTON INTERNATIONAL INC.	
Test Site Location	No.58, Aly. 75, Ln. 564, Wenhua 3rd Rd. Guishan Dist, Taoyuan City, Taiwan (R.O.C.) TEL: +886-3-327-0868 FAX: +886-3-327-0855	
Test Site No.	Sporton Site No.	
	03CH12-HY	

Note: The test site complies with ANSI C63.4 2014 requirement.



1.6 Applicable Standards

According to the specifications of the manufacturer, the EUT must comply with the requirements of the following standards:

- ♦ FCC Part 15 Subpart C §15.247
- ♦ FCC KDB Publication No. 558074 D01 DTS Meas. Guidance v04
- ♦ ANSI C63.10-2013

Remark:

1. All test items were verified and recorded according to the standards and without any deviation during the test.
2. This EUT has also been tested and complied with the requirements of FCC Part 15, Subpart B, recorded in a separate test report.



2 Test Configuration of Equipment Under Test

2.1 Carrier Frequency Channel

Frequency Band	Channel	Freq. (MHz)	Channel	Freq. (MHz)
2400-2483.5 MHz	0	2402	21	2444
	1	2404	22	2446
	2	2406	23	2448
	3	2408	24	2450
	4	2410	25	2452
	5	2412	26	2454
	6	2414	27	2456
	7	2416	28	2458
	8	2418	29	2460
	9	2420	30	2462
	10	2422	31	2464
	11	2424	32	2466
	12	2426	33	2468
	13	2428	34	2470
	14	2430	35	2472
	15	2432	36	2474
	16	2434	37	2476
	17	2436	38	2478
	18	2438	39	2480
	19	2440	-	-
20	2442	-	-	



2.2 Test Mode

- a. The EUT has been associated with peripherals and configuration operated in a manner tended to maximize its emission characteristics in a typical application. Frequency range investigated: conduction emission (150 kHz to 30 MHz), radiation emission (9 kHz to the 10th harmonic of the highest fundamental frequency or to 40 GHz, whichever is lower). For radiated measurement, pre-scanned in three orthogonal panels, X, Y, Z. The worst cases (X plane) were recorded in this report.
- b. AC power line Conducted Emission was tested under maximum output power.

The following summary table is showing all test modes to demonstrate in compliance with the standard.

Summary table of Test Cases	
Test Item	Data Rate / Modulation
	Bluetooth – LE / GFSK
Conducted TCs	Mode 1: Bluetooth Tx CH00_2402 MHz_1Mbps Mode 2: Bluetooth Tx CH19_2440 MHz_1Mbps Mode 3: Bluetooth Tx CH39_2480 MHz_1Mbps
Radiated TCs	Mode 1: Bluetooth Tx CH00_2402 MHz_1Mbps Mode 2: Bluetooth Tx CH19_2440 MHz_1Mbps Mode 3: Bluetooth Tx CH39_2480 MHz_1Mbps
AC Conducted Emission	Mode 1: Bluetooth Link + USB Cable (Charging from Notebook) Mode 2: WLAN Link + USB Cable (Charging from Notebook)
Remark: The worst case of conducted emission is mode 2; only the test data of it was reported.	

2.3 Connection Diagram of Test System

< Radiated Spurious Emission >

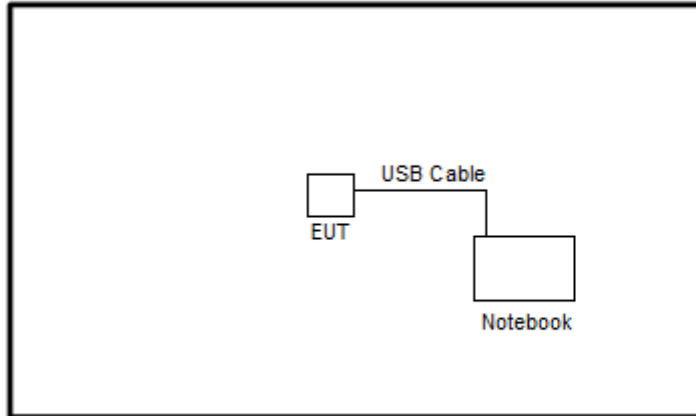

<AC Conducted Emission Mode in Bluetooth Link>

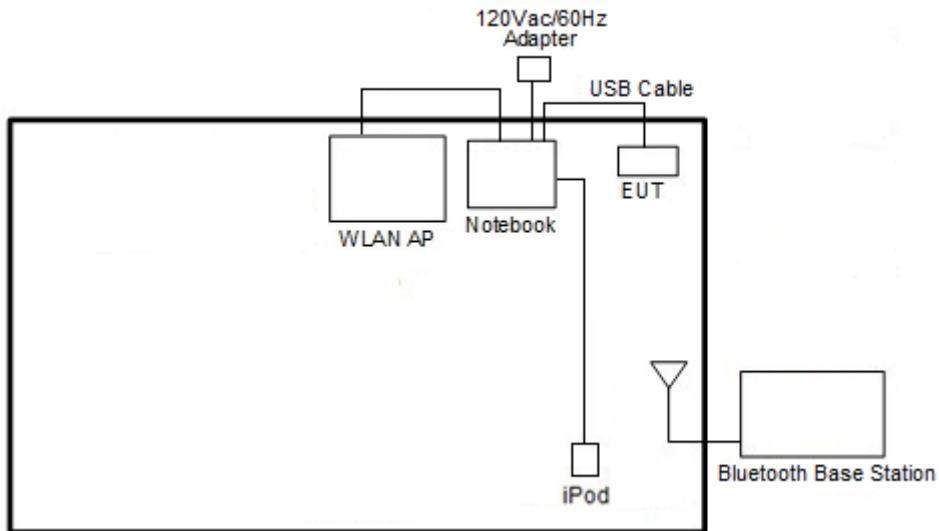

<AC Conducted Emission Mode in WLAN Link>

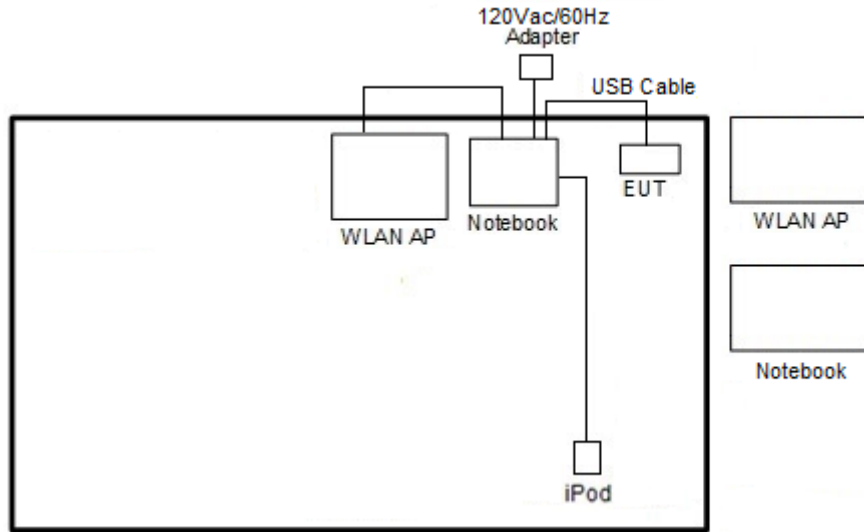

2.4 Support Unit used in test configuration and system

Item	Equipment	Trade Name	Model Name	FCC ID	Data Cable	Power Cord
1.	Notebook	Lenovo	E335	FCC DoC	N/A	AC I/P: Unshielded, 1.2 m DC O/P: Shielded, 1.8 m
2.	Notebook	DELL	Latitude E6320	FCC DoC/ Contains FCC ID: QDS-BRCM1054	N/A	AC I/P: Unshielded, 1.2 m DC O/P: Shielded, 1.8 m
3.	Bluetooth Base Station	R&S	CBT32	N/A	N/A	Unshielded, 1.8 m
4.	WLAN AP	ASUS	RT-AC66U	MSQ-RTAC66U	N/A	Unshielded, 1.8m
5.	iPod	Apple	A1285	FCC DoC	Shielded, 1.0 m	N/A
6.	Cable	MTJ	MT18A-600	N/A	N/A	N/A

2.5 EUT Operation Test Setup

The RF test items, utility “BlueTool” was installed in Notebook which was programmed in order to make the EUT get into the engineering modes to provide channel selection, power level, data rate and the application type and for continuous transmitting signals.



2.6 Measurement Results Explanation Example

For all conducted test items:

The offset level is set in the spectrum analyzer to compensate the RF cable loss and attenuator factor between EUT conducted output port and spectrum analyzer. With the offset compensation, the spectrum analyzer reading level is exactly the EUT RF output level.

Example :

The spectrum analyzer offset is derived from RF cable loss and attenuator factor.

Offset = RF cable loss + attenuator factor.

Following shows an offset computation example with cable loss 4.2 dB and 10dB attenuator.

$$\begin{aligned} \text{Offset(dB)} &= \text{RF cable loss(dB)} + \text{attenuator factor(dB)}. \\ &= 4.2 + 10 = 14.2 \text{ (dB)} \end{aligned}$$

3 Test Result

3.1 6dB and 99% Bandwidth Measurement

3.1.1 Limit of 6dB and 99% Bandwidth

The minimum 6 dB bandwidth shall be at least 500 kHz.

3.1.2 Measuring Instruments

The measuring equipment is listed in the section 4 of this test report.

3.1.3 Test Procedures

1. The testing follows FCC KDB Publication No. 558074 D01 DTS Meas. Guidance v04.
2. The RF output of EUT was connected to the spectrum analyzer by RF cable and attenuator. The path loss was compensated to the results for each measurement.
3. Set to the maximum power setting and enable the EUT transmit continuously.
4. Make the measurement with the spectrum analyzer's resolution bandwidth (RBW) = 100 kHz. Set the Video bandwidth (VBW) = 300 kHz. In order to make an accurate measurement. The 6 dB bandwidth must be greater than 500 kHz.
5. For 99% Bandwidth Measurement, the spectrum analyzer's resolution bandwidth (RBW) is set 30kHz and set the Video bandwidth (VBW) = 100kHz.
6. Measure and record the results in the test report.

3.1.4 Test Setup





3.1.5 Test Result of 6dB Bandwidth

Please refer to Appendix A.

6 dB Bandwidth Plot on Channel 00

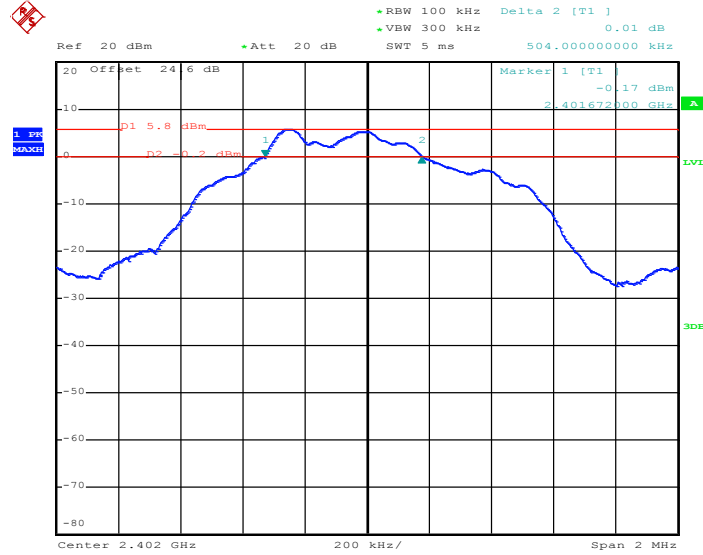

Date: 15.MAR.2018 03:26:00

6 dB Bandwidth Plot on Channel 19

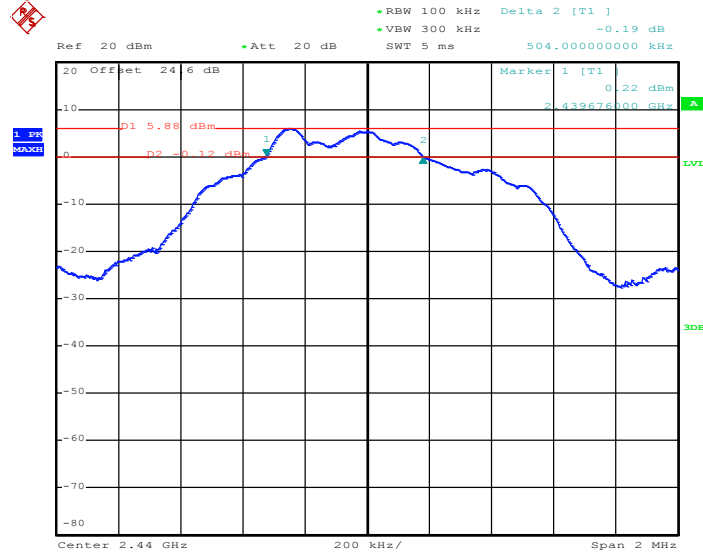

Date: 15.MAR.2018 03:30:10



6 dB Bandwidth Plot on Channel 39

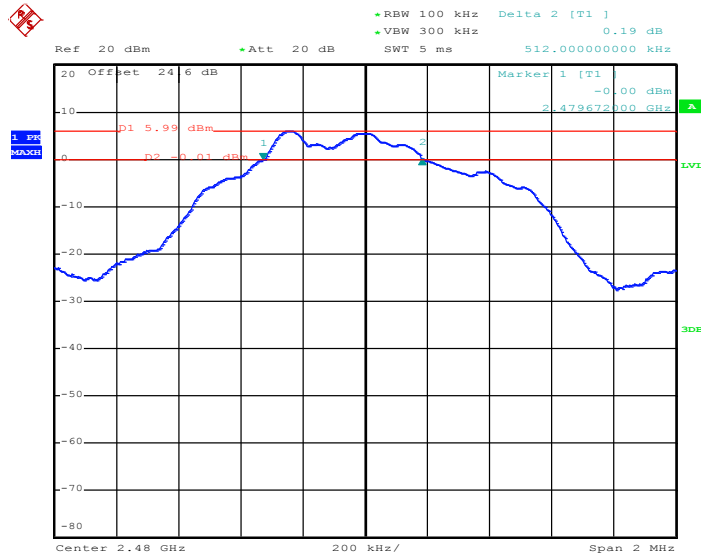

Date: 15.MAR.2018 03:35:04

3.1.6 Test Result of 99% Occupied Bandwidth

Please refer to Appendix A.

99% Bandwidth Plot on Channel 00

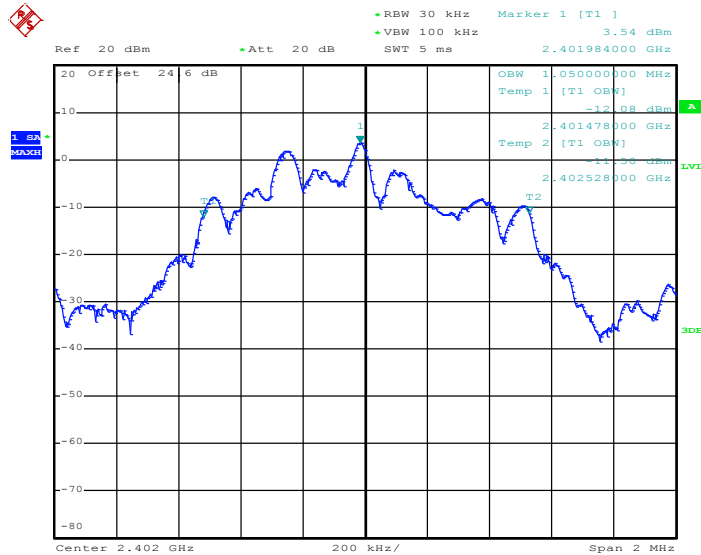

Date: 15.MAR.2018 03:27:05



99% Occupied Bandwidth Plot on Channel 19

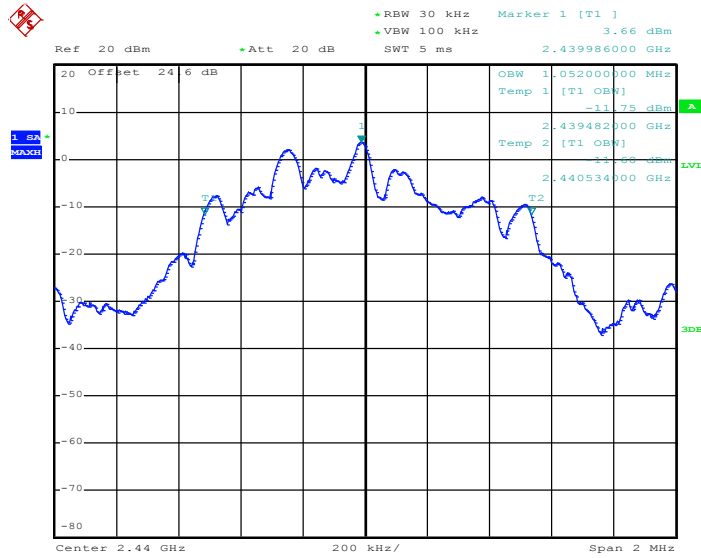

Date: 15.MAR.2018 03:31:06

99% Occupied Bandwidth Plot on Channel 39

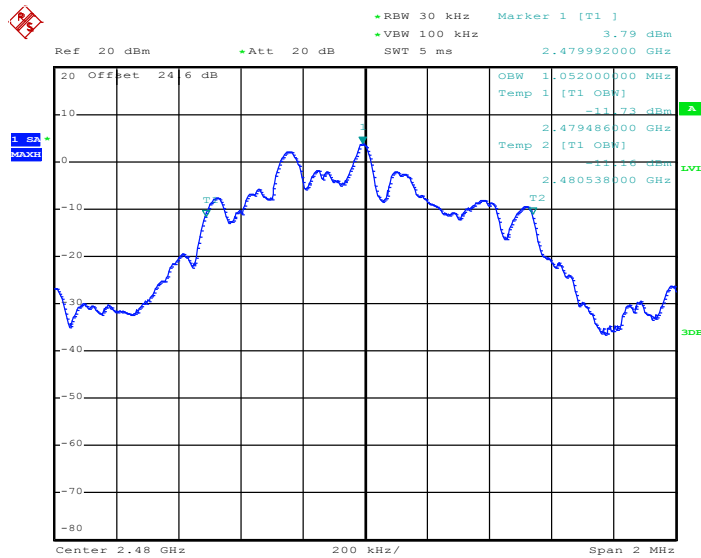

Date: 15.MAR.2018 03:37:13

Note: The occupied channel bandwidth is maintained within the band of operation for all of the modulations.

3.2 Output Power Measurement

3.2.1 Limit of Output Power

For systems using digital modulation in the 2400-2483.5MHz, the limit for peak output power is 30dBm. If transmitting antenna of directional gain greater than 6dBi is used, the peak output power from the intentional radiator shall be reduced below the above stated value by the amount in dB that the directional gain of the antenna exceeds 6 dBi. In case of point-to-point operation, the limit has to be reduced by 1dB for every 3dB that the directional gain of the antenna exceeds 6dBi.

3.2.2 Measuring Instruments

The measuring equipment is listed in the section 4 of this test report.

3.2.3 Test Procedures

1. The testing follows the Measurement Procedure of FCC KDB No. 558074 DTS D01 Meas. Guidance v04 section 9.1.3 PKPM1 Peak power meter method.
2. The RF output of EUT was connected to the power meter by RF cable and attenuator. The path loss was compensated to the results for each measurement.
3. Set to the maximum power setting and enable the EUT transmit continuously.
4. Measure the conducted output power and record the results in the test report.

3.2.4 Test Setup

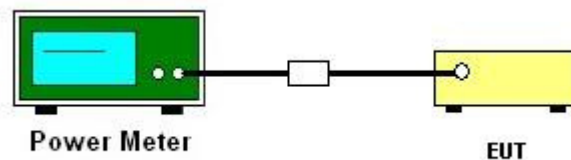

3.2.5 Test Result of Peak Output Power

Please refer to Appendix A.

3.2.6 Test Result of Average Output Power (Reporting Only)

Please refer to Appendix A.

3.3 Power Spectral Density Measurement

3.3.1 Limit of Power Spectral Density

The peak power spectral density shall not be greater than 8dBm in any 3kHz band at any time interval of continuous transmission.

3.3.2 Measuring Instruments

The measuring equipment is listed in the section 4 of this test report.

3.3.3 Test Procedures

1. The testing follows Measurement Procedure 10.2 Method PKPSD of FCC KDB Publication No. 558074 D01 DTS Meas. Guidance v04
2. The RF output of EUT was connected to the spectrum analyzer by RF cable and attenuator. The path loss was compensated to the results for each measurement.
3. Set to the maximum power setting and enable the EUT transmit continuously.
4. Make the measurement with the spectrum analyzer's resolution bandwidth (RBW) = 3 kHz. Video bandwidth VBW = 10 kHz In order to make an accurate measurement, set the span to 1.5 times DTS Channel Bandwidth. (6dB BW)
5. Detector = peak, Sweep time = auto couple, Trace mode = max hold, Allow trace to fully stabilize. Use the peak marker function to determine the maximum power level.
6. Measure and record the results in the test report.
7. The Measured power density (dBm)/ 100kHz is a reference level and used as 20dBc down limit line for Conducted Band Edges and Conducted Spurious Emission.

3.3.4 Test Setup

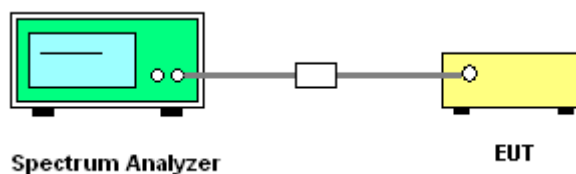

3.3.5 Test Result of Power Spectral Density

Please refer to Appendix A.



3.3.6 Test Result of Power Spectral Density Plots (100kHz)

PSD 100kHz Plot on Channel 00

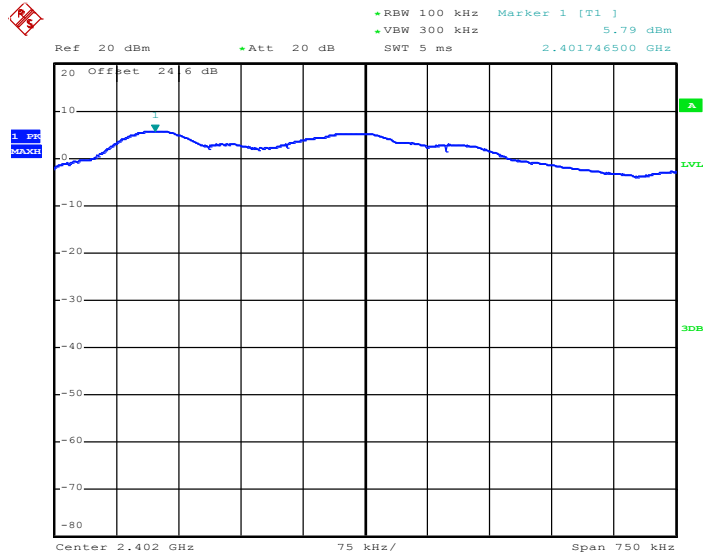

Date: 15.MAR.2018 03:26:32

PSD 100kHz Plot on Channel 19

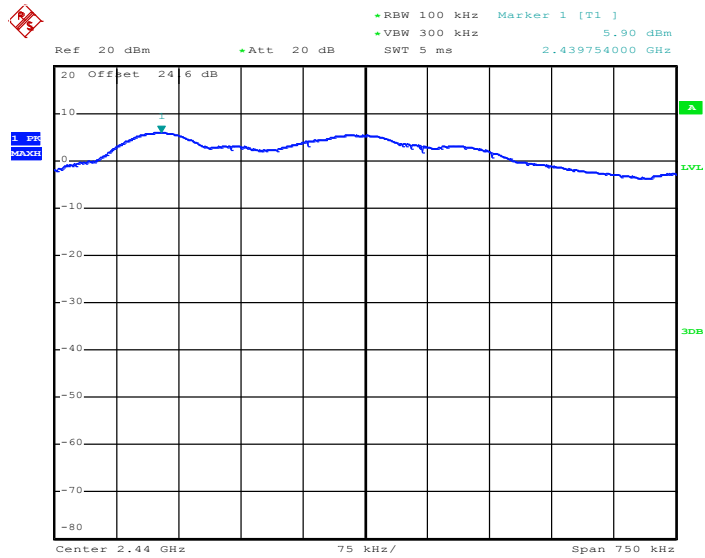

Date: 15.MAR.2018 03:30:37



PSD 100kHz Plot on Channel 39

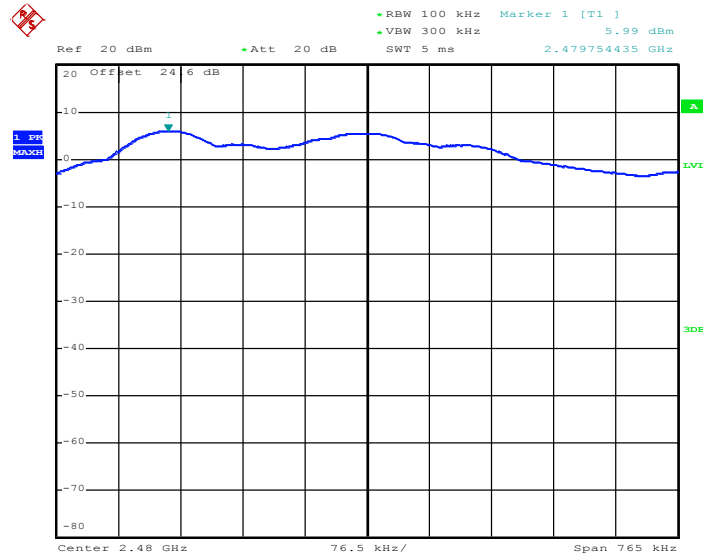

Date: 15.MAR.2018 03:36:05

3.3.7 Test Result of Power Spectral Density Plots (3kHz)

PSD 3kHz Plot on Channel 00

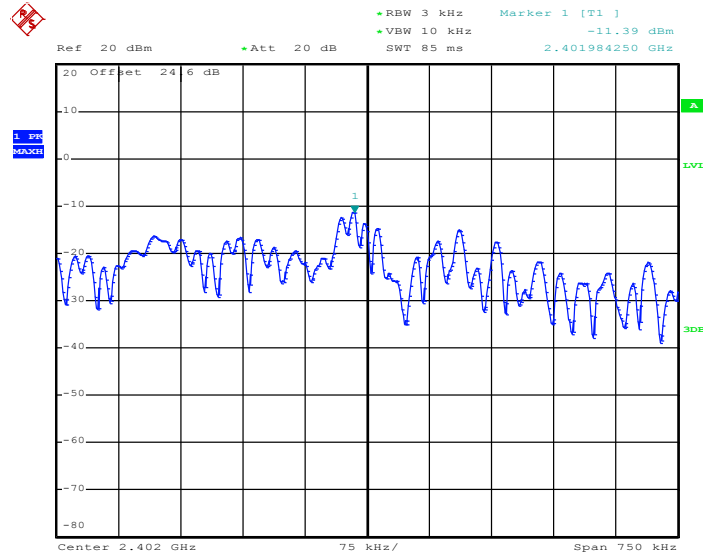

Date: 15.MAR.2018 03:26:15



PSD 3kHz Plot on Channel 19

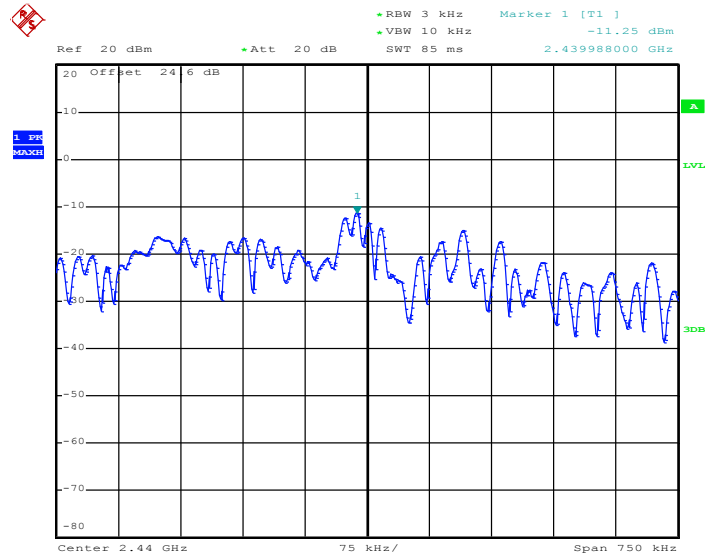

Date: 15.MAR.2018 03:30:23

PSD 3kHz Plot on Channel 39

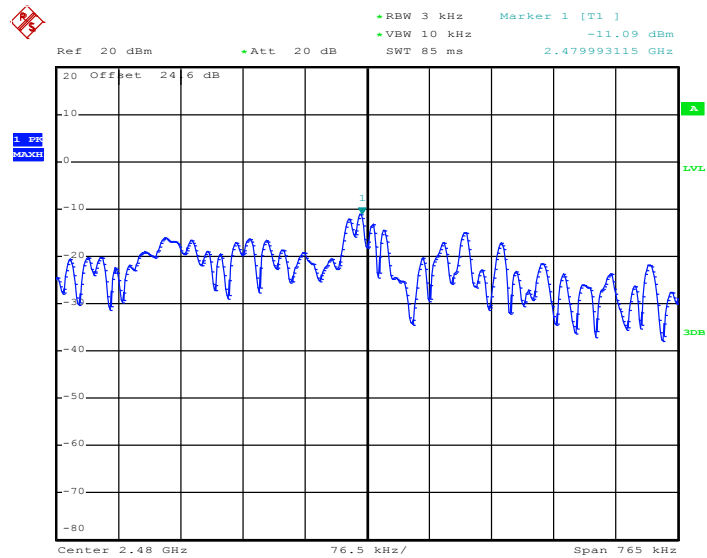

Date: 15.MAR.2018 03:35:45

3.4 Conducted Band Edges and Spurious Emission Measurement

3.4.1 Limit of Conducted Band Edges and Spurious Emission

All harmonics/spurious must be at least 20 dB down from the highest emission level within the authorized band.

3.4.2 Measuring Instruments

The measuring equipment is listed in the section 4 of this test report.

3.4.3 Test Procedure

1. The testing follows FCC KDB Publication No. 558074 D01 DTS Meas. Guidance v04.
2. The RF output of EUT was connected to the spectrum analyzer by RF cable and attenuator. The path loss was compensated to the results for each measurement.
3. Set to the maximum power setting and enable the EUT transmit continuously.
4. Set RBW = 100 kHz, VBW=300 kHz, Peak Detector. Unwanted Emissions measured in any 100 kHz bandwidth outside of the authorized frequency band shall be attenuated by at least 20 dB relative to the maximum in-band peak PSD level in 100 kHz when maximum peak conducted output power procedure is used. If the transmitter complies with the conducted power limits based on the use of RMS averaging over a time interval, the attenuation required under this paragraph shall be 30 dB instead of 20 dB.
5. Measure and record the results in the test report.
6. The RF fundamental frequency should be excluded against the limit line in the operating frequency band.

3.4.4 Test Setup

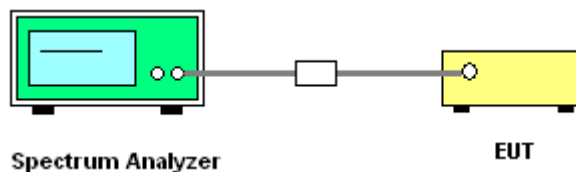



3.4.5 Test Result of Conducted Band Edges Plots

Low Band Edge Plot on Channel 00

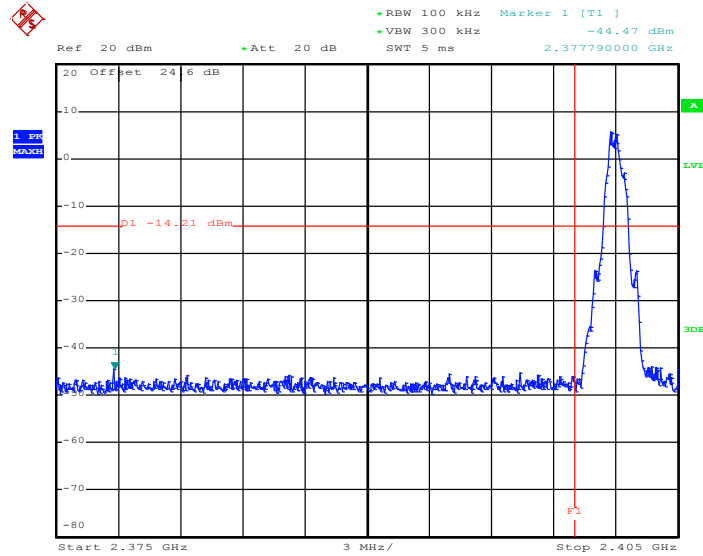

Date: 15.MAR.2018 03:26:48

High Band Edge Plot on Channel 39

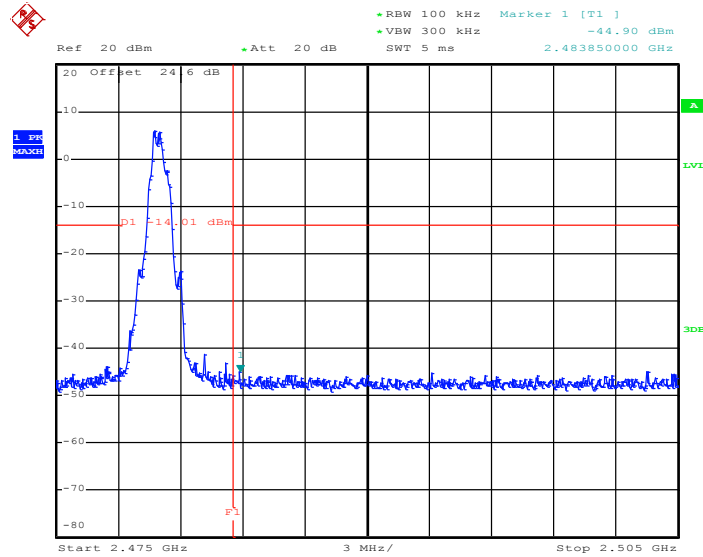

Date: 15.MAR.2018 03:36:38



Conducted Spurious Emission Plot on Bluetooth LE 1Mbps GFSK Channel 19

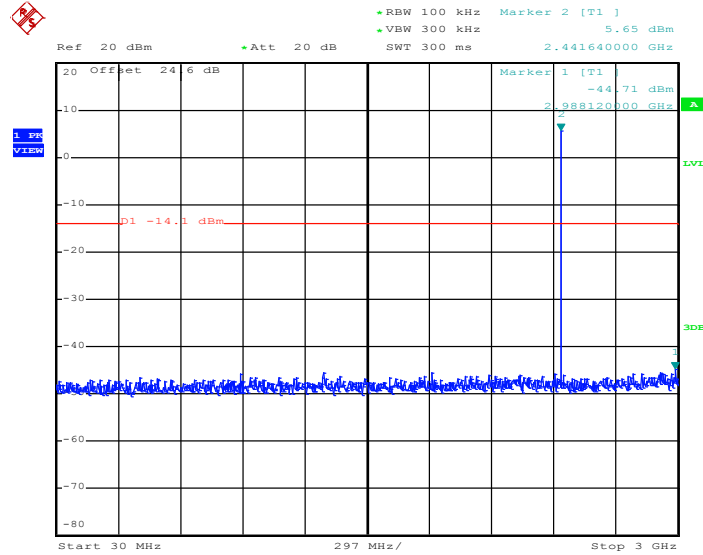

Date: 15.MAR.2018 03:32:48

Conducted Spurious Emission Plot on Bluetooth LE 1Mbps GFSK Channel 19

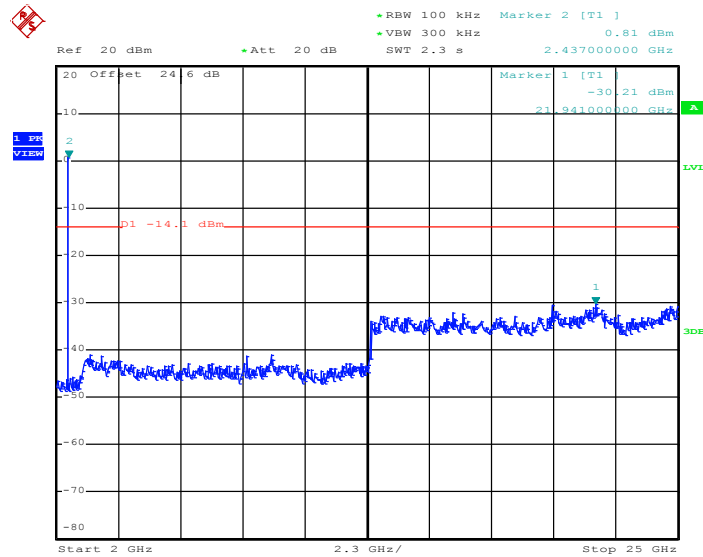

Date: 15.MAR.2018 03:32:57



Conducted Spurious Emission Plot on Bluetooth LE 1Mbps GFSK Channel 39

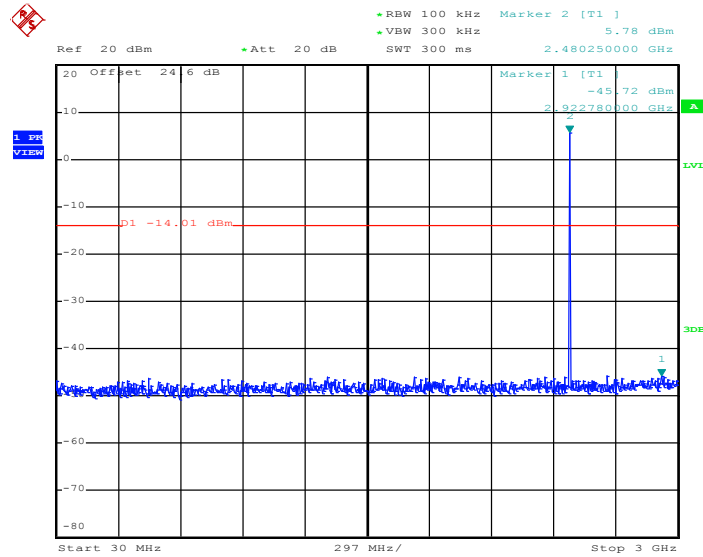

Date: 15.MAR.2018 03:40:33

Conducted Spurious Emission Plot on Bluetooth LE 1Mbps GFSK Channel 39

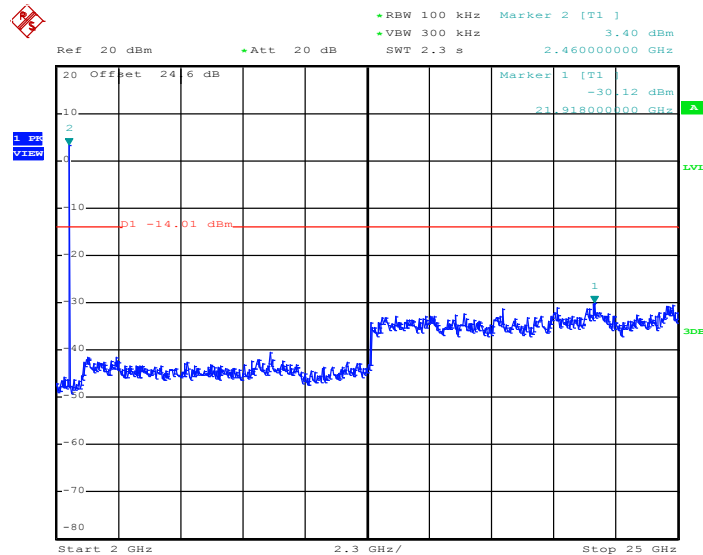

Date: 15.MAR.2018 03:40:42



3.5 Radiated Band Edges and Spurious Emission Measurement

3.5.1 Limit of Radiated Band Edges and Spurious Emission

In any 100 kHz bandwidth outside the intentional radiator frequency band, all harmonics/spurious must be at least 20 dB below the highest emission level within the authorized band. If the output power of this device was measured by spectrum analyzer, the attenuation under this paragraph shall be 30 dB instead of 20 dB. In addition, radiated emissions which fall in the restricted bands must also comply with the limits as below.

Frequency (MHz)	Field Strength (microvolts/meter)	Measurement Distance (meters)
0.009 – 0.490	2400/F(kHz)	300
0.490 – 1.705	24000/F(kHz)	30
1.705 – 30.0	30	30
30 – 88	100	3
88 – 216	150	3
216 - 960	200	3
Above 960	500	3

3.5.2 Measuring Instruments

The measuring equipment is listed in the section 4 of this test report.



3.5.3 Test Procedures

1. The testing follows FCC KDB Publication No. 558074 D01 DTS Meas. Guidance v04.
2. The EUT was arranged to its worst case and then tune the antenna tower (from 1 m to 4 m) and turntable (from 0 degree to 360 degrees) to find the maximum reading. A pre-amp and a high pass filter are used for the test in order to get better signal level.
3. The EUT was placed on a turntable with 0.8 meter for frequency below 1GHz and 1.5 meter for frequency above 1GHz respectively above ground.
4. The EUT was set 3 meters from the interference receiving antenna, which was mounted on the top of a variable height antenna tower.
5. Corrected Reading: Antenna Factor + Cable Loss + Read Level - Preamp Factor = Level
6. For testing below 1GHz, if the emission level of the EUT in peak mode was 3 dB lower than the limit specified, then peak values of EUT will be reported, otherwise, the emissions will be repeated one by one using the CISPR quasi-peak method and reported.
7. For testing above 1GHz, the emission level of the EUT in peak mode was 20dB lower than average limit (that means the emission level in average mode also complies with the limit in average mode), then peak values of EUT will be reported, otherwise, the emissions will be measured in average mode again and reported.
8. Use the following spectrum analyzer settings:
 - (1) Span shall wide enough to fully capture the emission being measured;
 - (2) Set RBW=100 kHz for $f < 1$ GHz; $VBW \geq RBW$; Sweep = auto; Detector function = peak; Trace = max hold;
 - (3) Set RBW = 1 MHz, VBW= 3MHz for $f \geq 1$ GHz for peak measurement.
For average measurement:
 - $VBW = 10$ Hz, when duty cycle is no less than 98 percent.
 - $VBW \geq 1/T$, when duty cycle is less than 98 percent where T is the minimum transmission duration over which the transmitter is on and is transmitting at its maximum power control level for the tested mode of operation.

3.5.4 Test Setup

For radiated emissions below 30MHz

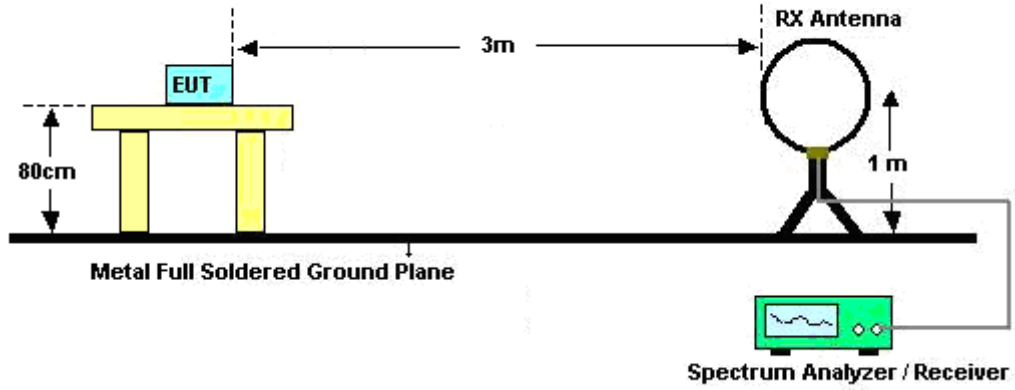

For radiated emissions from 30MHz to 1GHz

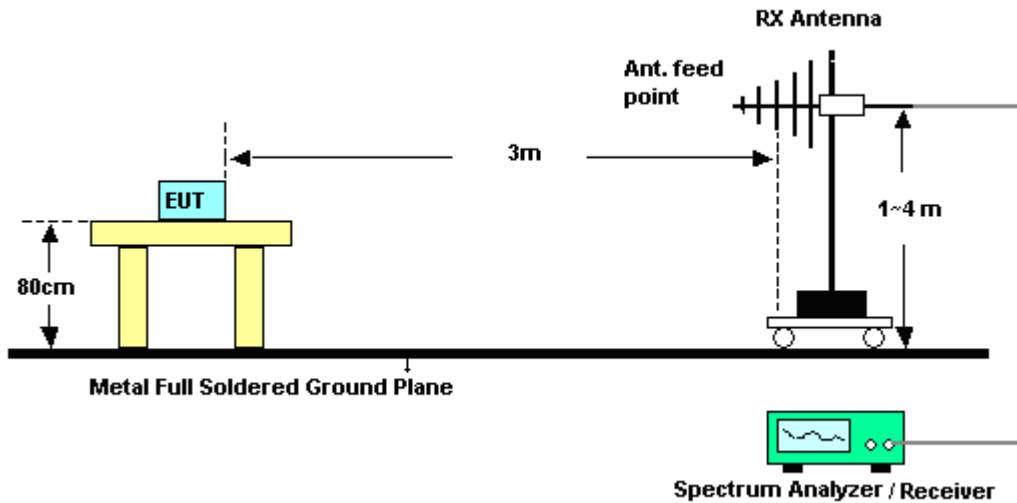

For radiated emissions above 1GHz

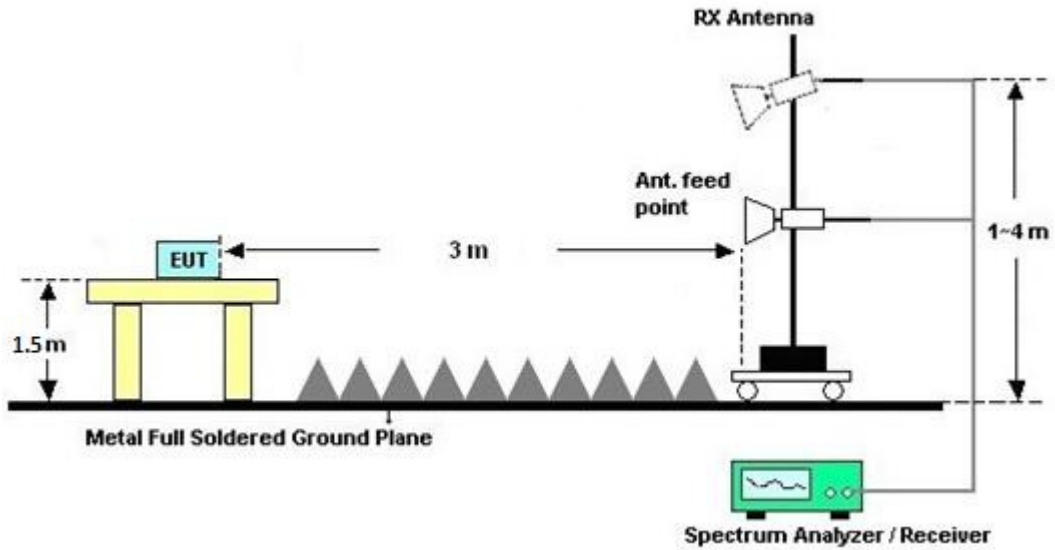

3.5.5 Test Results of Radiated Spurious Emissions (9 kHz ~ 30 MHz)

The low frequency, which started from 9 kHz to 30MHz, was pre-scanned and the result which was 20dB lower than the limit line was not reported.

There is a comparison data of both open-field test site and semi-Anechoic chamber, and the result came out very similar.

3.5.6 Test Result of Radiated Spurious at Band Edges

Please refer to Appendix C and D.

3.5.7 Duty Cycle

Please refer to Appendix E.

3.5.8 Test Result of Radiated Spurious Emission (30MHz ~ 10th Harmonic)

Please refer to Appendix C and D.



3.6 AC Conducted Emission Measurement

3.6.1 Limit of AC Conducted Emission

For equipment that is designed to be connected to the public utility (AC) power line, the radio frequency voltage that is conducted back onto the AC power line on any frequency or frequencies within the band 150 kHz to 30 MHz shall not exceed the limits in the following table.

Frequency of emission (MHz)	Conducted limit (dBµV)	
	Quasi-peak	Average
0.15-0.5	66 to 56*	56 to 46*
0.5-5	56	46
5-30	60	50

*Decreases with the logarithm of the frequency.

3.6.2 Measuring Instruments

The section 4.0 of List of Measuring Equipment of this test report is used for test.

3.6.3 Test Procedures

1. The EUT was placed 0.4 meter from the conducting wall of the shielding room was kept at least 80 centimeters from any other grounded conducting surface.
2. Connect EUT to the power mains through a line impedance stabilization network (LISN).
3. All the support units are connecting to the other LISN.
4. The LISN provides 50 ohm coupling impedance for the measuring instrument.
5. The FCC states that a 50 ohm, 50 microhenry LISN should be used.
6. Both sides of AC line were checked for maximum conducted interference.
7. The frequency range from 150 kHz to 30 MHz was searched.
8. Set the test-receiver system to Peak Detect Function and specified bandwidth (IF Bandwidth = 9kHz) with Maximum Hold Mode. Then measurement is also conducted by Average Detector and Quasi-Peak Detector Function respectively.

3.6.4 Test Setup

<AC Conducted Emission Mode in Bluetooth Link>

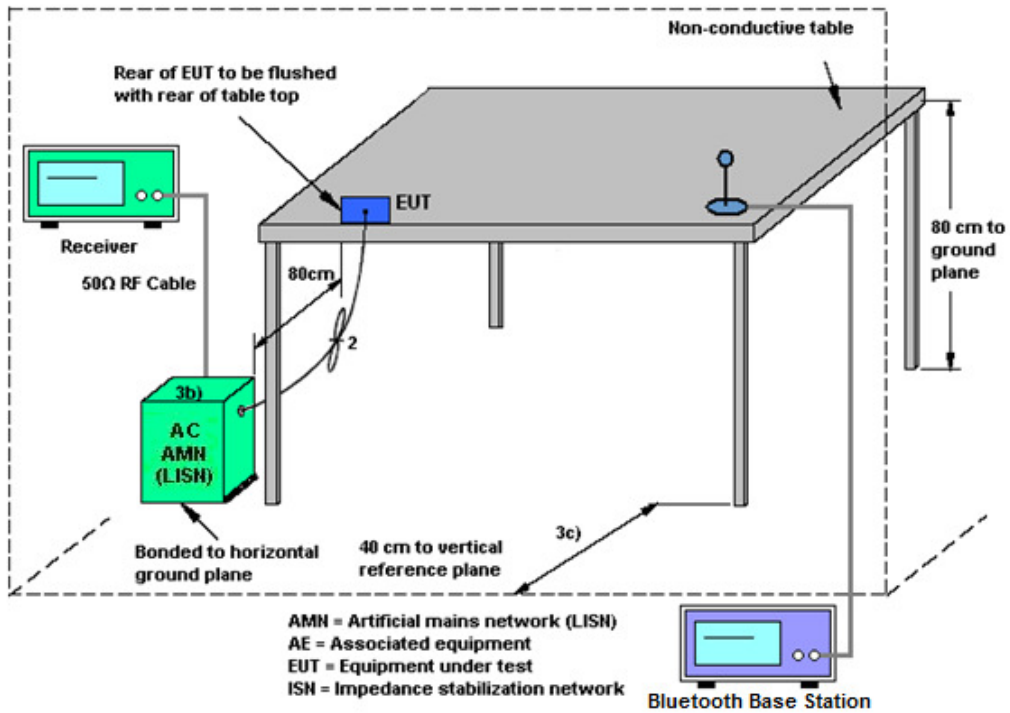

<AC Conducted Emission Mode in WLAN Link>

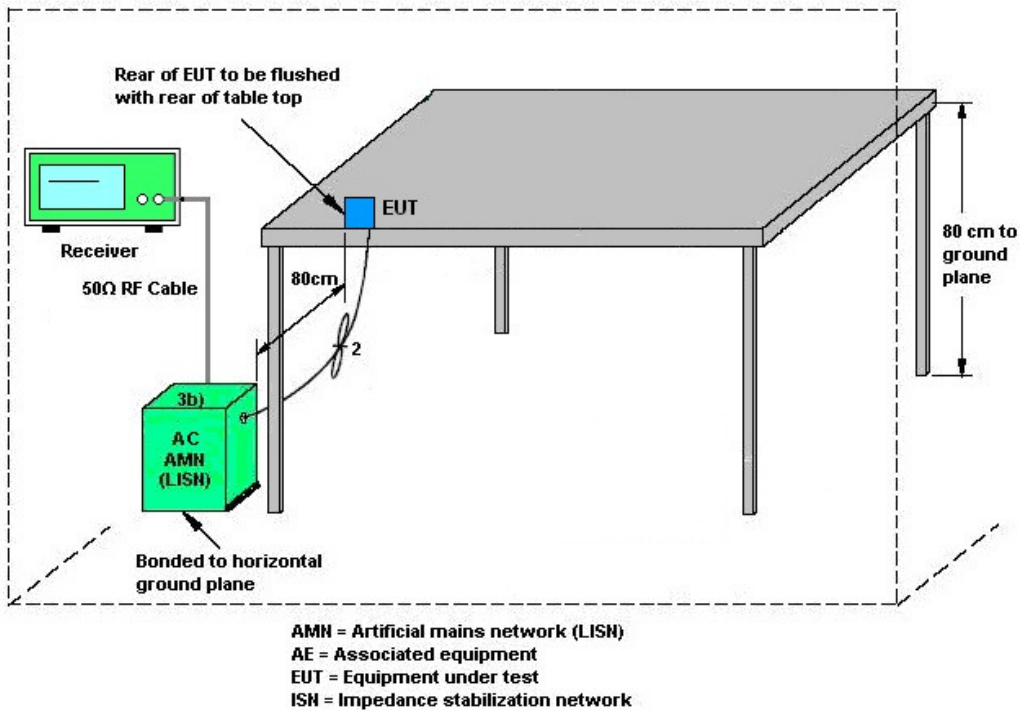



3.6.5 Test Result of AC Conducted Emission

Please refer to Appendix B.



3.7 Antenna Requirements

3.7.1 Standard Applicable

If directional gain of transmitting antennas is greater than 6dBi, the power shall be reduced by the same level in dB comparing to gain minus 6dBi. The use of a permanently attached antenna or of an antenna that uses a unique coupling to the intentional radiator shall be considered sufficient to comply with the rule.

3.7.2 Antenna Anti-Replacement Construction

An embedded-in antenna design is used.

3.7.3 Antenna Gain

The antenna peak gain of EUT is less than 6 dBi. Therefore, it is not necessary to reduce maximum peak output power limit.



4 List of Measuring Equipment

Instrument	Manufacturer	Model No.	Serial No.	Characteristics	Calibration Date	Test Date	Due Date	Remark
Power Meter	Agilent	E4416A	GB41292344	N/A	Dec. 20, 2017	Mar. 12, 2018~ Mar. 14 2018	Dec. 19, 2018	Conducted (TH05-HY)
Power Sensor	Agilent	E9327A	US40441548	50MHz~18GHz	Dec. 20, 2017	Mar. 12, 2018~ Mar. 14 2018	Dec. 19, 2018	Conducted (TH05-HY)
Spectrum Analyzer	Rohde & Schwarz	FSP40	100055	9kHz~40GHz	Jun. 20, 2017	Mar. 12, 2018~ Mar. 14 2018	Jun. 19, 2018	Conducted (TH05-HY)
AC Power Source	ChainTek	APC-1000W	N/A	N/A	N/A	Mar. 28, 2018	N/A	Conduction (CO05-HY)
EMI Test Receiver	Rohde & Schwarz	ESR3	102388	3.6GHz	Dec. 08, 2017	Mar. 28, 2018	Dec. 07, 2018	Conduction (CO05-HY)
LISN	Rohde & Schwarz	ENV216	100080	9kHz~30MHz	Nov. 30, 2017	Mar. 28, 2018	Nov. 29, 2018	Conduction (CO05-HY)
LISN	Rohde & Schwarz	ENV216	100081	9kHz~30MHz	Dec. 08, 2017	Mar. 28, 2018	Dec. 07, 2018	Conduction (CO05-HY)
Software	Rohde & Schwarz	EMC32 V10.30	N/A	N/A	N/A	Mar. 28, 2018	N/A	Conduction (CO05-HY)
Amplifier	MITEQ	TTA1840-35-HG	1871923	18GHz~40GHz, VSWR : 2.5:1 max	Jul. 18, 2017	Feb. 14, 2018~ Mar. 16, 2018	Jul. 17, 2018	Radiation (03CH12-HY)
Bilog Antenna	TESEQ	CBL 6111D&N-6-06	35414&AT- N0602	30MHz~1GHz	Oct. 14, 2017	Feb. 14, 2018~ Mar. 16, 2018	Oct. 13, 2018	Radiation (03CH12-HY)
Bilog Antenna	TESEQ	CBL 6111D&00800 N1D01N-06	40103&07	30MHz to 1GHz	Jan. 10, 2018	Mar. 16, 2018	Jan. 09, 2019	Radiation (03CH12-HY)
Loop Antenna	Rohde & Schwarz	HFH2-Z2	100488	9 kHz~30 MHz	Nov. 23, 2017	Feb. 14, 2018~ Mar. 16, 2018	Nov. 22, 2019	Radiation (03CH12-HY)
EMI Test Receiver	Rohde & Schwarz	ESU26	100390	20Hz~26.5GHz	Dec. 25, 2017	Feb. 14, 2018~ Mar. 16, 2018	Dec. 24, 2018	Radiation (03CH12-HY)
Horn Antenna	SCHWARZBECK	BBHA 9120D	9120D-1328	1GHz ~ 18GHz	Oct. 20, 2017	Feb. 14, 2018~ Mar. 16, 2018	Oct. 19, 2018	Radiation (03CH12-HY)
Preamplifier	COM-POWER	PA-103	161075	10MHz~1GHz	Mar. 23, 2017	Feb. 14, 2018~ Mar. 16, 2018	Mar. 22, 2018	Radiation (03CH12-HY)
Preamplifier	Keysight	83017A	MY53270148	1GHz~26.5GHz	Jan. 15, 2018	Feb. 14, 2018~ Mar. 16, 2018	Jan. 14, 2019	Radiation (03CH12-HY)
Preamplifier	MITEQ	AMF-7D-00101800	2025787	1GHZ~18GHZ	Feb. 13, 2017	Feb. 14, 2018~ Mar. 16, 2018	Feb. 12, 2019	Radiation (03CH12-HY)
Filter	Wainwright	WHKX12-2700-3000-18000-60ST	SN2	3 GHz Highpass	Jul. 17, 2017	Feb. 14, 2018~ Mar. 16, 2018	Jul. 16, 2018	Radiation (03CH12-HY)
Antenna Mast	EMEC	AM-BS-4500-B	N/A	1m~4m	N/A	Feb. 14, 2018~ Mar. 16, 2018	N/A	Radiation (03CH12-HY)
Turn Table	EMEC	TT2000	N/A	0~360 Degree	N/A	Feb. 14, 2018~ Mar. 16, 2018	N/A	Radiation (03CH12-HY)
Attenuator	Fairview Microwave	SA18S5W-10	n/a	10db	Mar. 24, 2017	Feb. 14, 2018~ Mar. 16, 2018	Mar. 23, 2018	Radiation (03CH12-HY)
Spectrum Analyzer	Keysight	N9010A	MY55370485	10Hz~44GHz	Oct. 31, 2017	Feb. 14, 2018~ Mar. 16, 2018	Oct. 30, 2018	Radiation (03CH12-HY)
Software	Audix	E3 6.2009-8-24	RK-000989	N/A	N/A	Feb. 14, 2018~ Mar. 16, 2018	N/A	Radiation (03CH12-HY)



5 Uncertainty of Evaluation

Uncertainty of Conducted Emission Measurement (150 kHz ~ 30 MHz)

Measuring Uncertainty for a Level of Confidence of 95% ($U = 2Uc(y)$)	2.7
---	-----

Uncertainty of Radiated Emission Measurement (30 MHz ~ 1000 MHz)

Measuring Uncertainty for a Level of Confidence of 95% ($U = 2Uc(y)$)	5.1
---	-----

Uncertainty of Radiated Emission Measurement (1000 MHz ~ 18000 MHz)

Measuring Uncertainty for a Level of Confidence of 95% ($U = 2Uc(y)$)	5.2
---	-----

Uncertainty of Radiated Emission Measurement (18000 MHz ~ 40000 MHz)

Measuring Uncertainty for a Level of Confidence of 95% ($U = 2Uc(y)$)	4.7
---	-----

Appendix A. Test Result of Conducted Test Items

Test Engineer:	Lena Lo	Temperature:	21~25	°C
Test Date:	2018/03/12 ~ 2018/03/14	Relative Humidity:	51~54	%

TEST RESULTS DATA
6dB and 99% Occupied Bandwidth

Mod.	Data Rate	NTX	CH.	Freq. (MHz)	99% Occupied BW (MHz)	6dB BW (MHz)	6dB BW Limit (MHz)	Pass/Fail
BLE	1Mbps	1	0	2402	1.050	0.504	0.50	Pass
BLE	1Mbps	1	19	2440	1.052	0.504	0.50	Pass
BLE	1Mbps	1	39	2480	1.052	0.512	0.50	Pass

TEST RESULTS DATA
Peak Power Table

Mod.	Data Rate	NTX	CH.	Freq. (MHz)	Peak Conducted Power (dBm)	Conducted Power Limit (dBm)	DG (dBi)	EIRP Power (dBm)	EIRP Power Limit (dBm)	Pass /Fail
BLE	1Mbps	1	0	2402	6.48	30.00	0.56	7.04	36.00	Pass
BLE	1Mbps	1	19	2440	6.43	30.00	0.56	6.99	36.00	Pass
BLE	1Mbps	1	39	2480	6.64	30.00	0.56	7.20	36.00	Pass

TEST RESULTS DATA
Average Power Table
(Reporting Only)

Mod.	Data Rate	NTX	CH.	Freq. (MHz)	Duty Factor (dB)	Average Conducted Power (dBm)
BLE	1Mbps	1	0	2402	2.11	6.30
BLE	1Mbps	1	19	2440	2.11	6.25
BLE	1Mbps	1	39	2480	2.11	6.40

TEST RESULTS DATA
Peak Power Density

Mod.	Data Rate	NTX	CH.	Freq. (MHz)	Peak PSD (dBm /100kHz)	Peak PSD (dBm /3kHz)	DG (dBi)	Peak PSD Limit (dBm /3kHz)	Pass/Fail
BLE	1Mbps	1	0	2402	5.79	-11.39	0.56	8.00	Pass
BLE	1Mbps	1	19	2440	5.90	-11.25	0.56	8.00	Pass
BLE	1Mbps	1	39	2480	5.99	-11.09	0.56	8.00	Pass

Note: PSD (dBm/ 100kHz) is a reference level used for Conducted Band Edges and Conducted Spurious Emission 20dBc limit.



Appendix B. AC Conducted Emission Test Results

Test Engineer :	Blue Lan	Temperature :	25~26°C
		Relative Humidity :	56~57%

EUT Information

Report NO : 822214
 Test Mode : Mode 2
 Test Voltage : Power From System
 Phase : Line

Full Spectrum

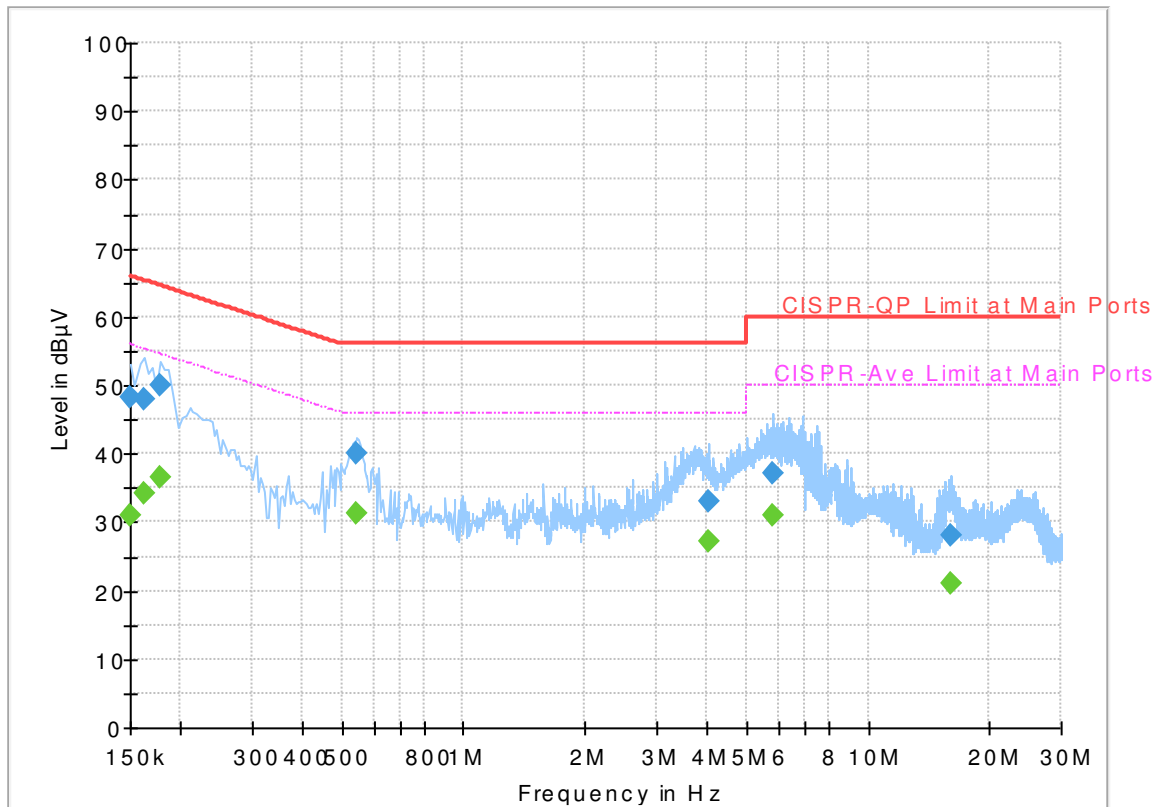

Final Result

Frequency (MHz)	QuasiPeak (dBµV)	Average (dBµV)	Limit (dBµV)	Margin (dB)	Line	Filter	Corr. (dB)
0.150000	---	31.00	56.00	25.00	L1	OFF	19.5
0.150000	48.19	---	66.00	17.81	L1	OFF	19.5
0.162000	---	34.10	55.36	21.26	L1	OFF	19.5
0.162000	48.05	---	65.36	17.31	L1	OFF	19.5
0.178000	---	36.54	54.58	18.04	L1	OFF	19.5
0.178000	49.92	---	64.58	14.66	L1	OFF	19.5
0.546000	---	31.35	46.00	14.65	L1	OFF	19.5
0.546000	39.96	---	56.00	16.04	L1	OFF	19.5
4.026000	---	27.21	46.00	18.79	L1	OFF	19.6
4.026000	33.15	---	56.00	22.85	L1	OFF	19.6
5.818000	---	30.85	50.00	19.15	L1	OFF	19.6
5.818000	37.12	---	60.00	22.88	L1	OFF	19.6
16.026000	---	21.18	50.00	28.82	L1	OFF	19.8
16.026000	27.96	---	60.00	32.04	L1	OFF	19.8

EUT Information

Report NO : 822214
 Test Mode : Mode 2
 Test Voltage : Power From System
 Phase : Neutral

Full Spectrum

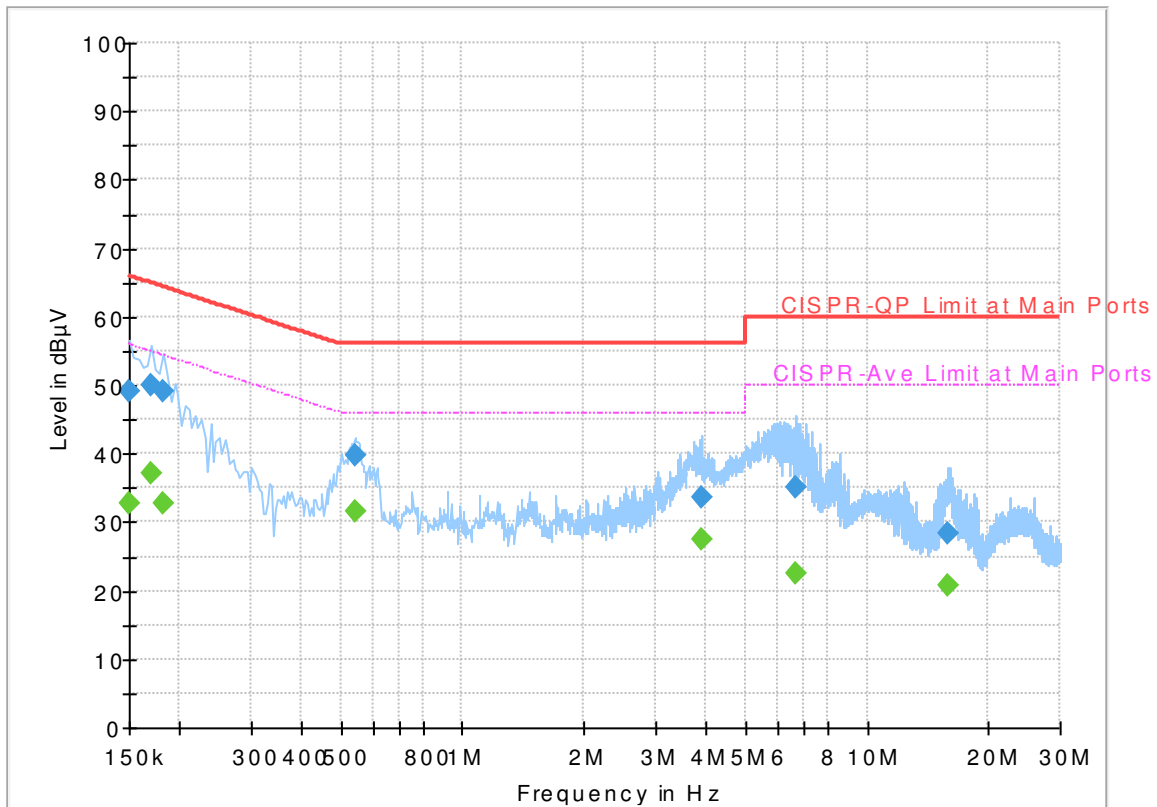

Final Result

Frequency (MHz)	QuasiPeak (dBµV)	Average (dBµV)	Limit (dBµV)	Margin (dB)	Line	Filter	Corr. (dB)
0.150000	---	32.86	56.00	23.14	N	OFF	19.5
0.150000	49.08	---	66.00	16.92	N	OFF	19.5
0.170000	---	37.06	54.96	17.90	N	OFF	19.5
0.170000	50.10	---	64.96	14.86	N	OFF	19.5
0.182000	---	32.76	54.39	21.63	N	OFF	19.5
0.182000	49.15	---	64.39	15.24	N	OFF	19.5
0.542000	---	31.48	46.00	14.52	N	OFF	19.5
0.542000	39.68	---	56.00	16.32	N	OFF	19.5
3.914000	---	27.54	46.00	18.46	N	OFF	19.6
3.914000	33.53	---	56.00	22.47	N	OFF	19.6
6.642000	---	22.42	50.00	27.58	N	OFF	19.6
6.642000	35.17	---	60.00	24.83	N	OFF	19.6
15.822000	---	20.64	50.00	29.36	N	OFF	19.8
15.822000	28.46	---	60.00	31.54	N	OFF	19.8



Appendix C. Radiated Spurious Emission

Test Engineer :	Watt Tseng, Karl Hou, and Nick Yu	Temperature :	22~23°C
		Relative Humidity :	59~61%

2.4GHz 2400~2483.5MHz

BLE (Band Edge @ 3m)

BLE	Note	Frequency	Level	Over	Limit	Read	Antenna	Path	Preamp	Ant	Table	Peak	Pol.	
		(MHz)	(dBμV/m)	(dB)	Limit	Level	Factor	Loss	Factor	Pos	Pos	Avg.		
					Line	(dBμV)	(dB/m)	(dB)	(dB)	(cm)	(deg)	(P/A)	(H/V)	
BLE CH 00 2402MHz		2340.24	53.35	-20.65	74	43.87	27.03	14.03	31.58	124	149	P	H	
		2352.42	42.69	-11.31	54	33.17	27.07	14.03	31.58	124	149	A	H	
	*	2402	101.52	-	-	91.87	27.15	14.07	31.57	124	149	P	H	
	*	2402	100.54	-	-	90.89	27.15	14.07	31.57	124	149	A	H	
													H	
														H
			2389.17	53.49	-20.51	74	43.86	27.15	14.06	31.58	388	188	P	V
			2354.835	42.91	-11.09	54	33.39	27.07	14.03	31.58	388	188	A	V
	*		2402	99.4	-	-	89.75	27.15	14.07	31.57	388	188	P	V
	*		2402	98.37	-	-	88.72	27.15	14.07	31.57	388	188	A	V
														V
														V
BLE CH 19 2440MHz		2382.52	53.22	-20.78	74	43.63	27.11	14.06	31.58	143	231	P	H	
		2370.9	42.8	-11.2	54	33.23	27.11	14.04	31.58	143	231	A	H	
	*	2440	100.61	-	-	90.8	27.28	14.1	31.57	143	231	P	H	
	*	2440	99.48	-	-	89.67	27.28	14.1	31.57	143	231	A	H	
			2493.91	53.2	-20.8	74	43.21	27.4	14.14	31.55	143	231	P	H
			2493.84	42.99	-11.01	54	33	27.4	14.14	31.55	143	231	A	H
			2363.76	53.65	-20.35	74	44.12	27.07	14.04	31.58	326	174	P	V
			2343.32	42.92	-11.08	54	33.44	27.03	14.03	31.58	326	174	A	V
	*		2440	97.81	-	-	88	27.28	14.1	31.57	326	174	P	V
	*		2440	96.6	-	-	86.79	27.28	14.1	31.57	326	174	A	V
			2492.65	53.85	-20.15	74	43.86	27.4	14.14	31.55	326	174	P	V
			2492.44	42.99	-11.01	54	33	27.4	14.14	31.55	326	174	A	V



BLE CH 39 2480MHz	*	2480	101.04	-	-	91.12	27.36	14.12	31.56	109	228	P	H
	*	2480	100.15	-	-	90.23	27.36	14.12	31.56	109	228	A	H
		2498.24	54.31	-19.69	74	44.32	27.4	14.14	31.55	109	228	P	H
		2483.76	43.41	-10.59	54	33.47	27.36	14.14	31.56	109	228	A	H
													H
													H
	*	2480	98.68	-	-	88.76	27.36	14.12	31.56	359	172	P	V
	*	2480	97.78	-	-	87.86	27.36	14.12	31.56	359	172	A	V
		2499.2	53.71	-20.29	74	43.72	27.4	14.14	31.55	359	172	P	V
		2499.04	43.01	-10.99	54	33.02	27.4	14.14	31.55	359	172	A	V
													V
													V
Remark	1. No other spurious found. 2. All results are PASS against Peak and Average limit line.												



2.4GHz 2400~2483.5MHz
BLE (Harmonic @ 3m)

BLE	Note	Frequency (MHz)	Level (dBµV/m)	Over Limit (dB)	Limit Line (dBµV/m)	Read Level (dBµV)	Antenna Factor (dB/m)	Path Loss (dB)	Preamp Factor (dB)	Ant Pos (cm)	Table Pos (deg)	Peak Avg. (P/A)	Pol. (H/V)
BLE CH 00 2402MHz		4804	43.93	-30.07	74	70.66	31.32	6.7	64.75	100	0	P	H
													H
													H
													H
		4804	43.64	-30.36	74	70.37	31.32	6.7	64.75	100	0	P	V
													V
													V
BLE CH 19 2440MHz		4880	40.37	-33.63	74	66.88	31.46	6.73	64.7	100	0	P	H
		7320	44.18	-29.82	74	64.8	36.15	8.06	64.83	100	0	P	H
													H
													H
		4880	39.3	-34.7	74	65.81	31.46	6.73	64.7	100	0	P	V
		7320	44.32	-29.68	74	64.94	36.15	8.06	64.83	100	0	P	V
													V
BLE CH 39 2480MHz		4960	40.94	-33.06	74	67.19	31.63	6.75	64.63	100	0	P	H
		7440	44.68	-29.32	74	65.02	36.47	8.07	64.88	100	0	P	H
													H
													H
		4960	42.05	-31.95	74	68.3	31.63	6.75	64.63	100	0	P	V
		7440	44.89	-29.11	74	65.23	36.47	8.07	64.88	100	0	P	V
													V
Remark	1. No other spurious found.												
	2. All results are PASS against Peak and Average limit line.												



Emission below 1GHz

2.4GHz BLE (LF)

BLE	Note	Frequency	Level	Over	Limit	Read	Antenna	Path	Preamp	Ant	Table	Peak	Pol.	
		(MHz)	(dBμV/m)	(dB)	(dBμV/m)	(dBμV)	(dB/m)	(dB)	(dB)	(cm)	(deg)	(P/A)	(H/V)	
2.4GHz BLE LF		66.99	33.93	-6.07	40	51.78	11.86	0.72	30.43	100	0	P	H	
		80.76	32.41	-7.59	40	48.82	13.19	0.82	30.42	-	-	P	H	
		210.36	34.13	-9.37	43.5	48.07	14.99	1.33	30.26	-	-	P	H	
		309.8	34.46	-11.54	46	43.9	19.15	1.53	30.12	-	-	P	H	
		359.5	35.87	-10.13	46	43.82	20.52	1.57	30.04	-	-	P	H	
		768.3	33.49	-12.51	46	32.59	27.95	2.35	29.4	-	-	P	H	
													H	
													H	
													H	
													H	
													H	
													H	
			80.22	35.26	-4.74	40	51.67	13.19	0.82	30.42	-	-	P	V
			87.24	36.17	-3.83	40	51.62	14.14	0.82	30.41	-	-	P	V
			210.36	39.76	-3.74	43.5	53.7	14.99	1.33	30.26	100	0	P	V
			300.7	29.77	-16.23	46	39.33	19.09	1.49	30.14	-	-	P	V
			359.5	28.21	-17.79	46	36.16	20.52	1.57	30.04	-	-	P	V
			423.9	28.03	-17.97	46	33.7	22.56	1.7	29.93	-	-	P	V
														V
														V
													V	
													V	
													V	
													V	
Remark	1. No other spurious found. 2. All results are PASS against limit line.													



Note symbol

*	Fundamental Frequency which can be ignored. However, the level of any unwanted emissions shall not exceed the level of the fundamental frequency.
!	Test result is over limit line.
P/A	Peak or Average
H/V	Horizontal or Vertical



A calculation example for radiated spurious emission is shown as below:

BLE	Note	Frequency	Level	Over	Limit	Read	Antenna	Path	Preamp	Ant	Table	Peak	Pol.
		(MHz)	(dBμV/m)	(dB)	(dBμV/m)	(dBμV)	(dB/m)	(dB)	(dB)	(cm)	(deg)	(P/A)	(H/V)
BLE CH 00 2402MHz		2390	55.45	-18.55	74	54.51	32.22	4.58	35.86	103	308	P	H
		2390	43.54	-10.46	54	42.6	32.22	4.58	35.86	103	308	A	H

1. Path Loss(dB) = Cable loss(dB) + Filter loss(dB) + Attenuator loss(dB)
2. Level(dBμV/m) =
Antenna Factor(dB/m) + Path Loss(dB) + Read Level(dBμV) - Preamp Factor(dB)
3. Over Limit(dB) = Level(dBμV/m) – Limit Line(dBμV/m)

For Peak Limit @ 2390MHz:

1. Level(dBμV/m)
= Antenna Factor(dB/m) + Path Loss(dB) + Read Level(dBμV) - Preamp Factor(dB)
= 32.22(dB/m) + 4.58(dB) + 54.51(dBμV) – 35.86 (dB)
= 55.45 (dBμV/m)
2. Over Limit(dB)
= Level(dBμV/m) – Limit Line(dBμV/m)
= 55.45(dBμV/m) – 74(dBμV/m)
= -18.55(dB)

For Average Limit @ 2390MHz:

1. Level(dBμV/m)
= Antenna Factor(dB/m) + Path Loss(dB) + Read Level(dBμV) - Preamp Factor(dB)
= 32.22(dB/m) + 4.58(dB) + 42.6(dBμV) – 35.86 (dB)
= 43.54 (dBμV/m)
2. Over Limit(dB)
= Level(dBμV/m) – Limit Line(dBμV/m)
= 43.54(dBμV/m) – 54(dBμV/m)
= -10.46(dB)

Both peak and average measured complies with the limit line, so test result is “PASS”.



Appendix D. Radiated Spurious Emission Plots

Test Engineer :	Watt Tseng, Karl Hou, and Nick Yu	Temperature :	22~23°C
		Relative Humidity :	59~61%

Note symbol

-L	Low channel location
-R	High channel location



2.4GHz 2400~2483.5MHz

BLE (Band Edge @ 3m)

BLE	2.4GHz 2400~2483.5MHz Band Edge @ 3m	
ANT	BLE CH00 2402MHz	
1	Horizontal	Fundamental
Peak	<p>Site : 03CH12-HY Condition : PEAK_BE_74 3m HORN_91200_1328 HORIZONTAL RBW:1000.000kHz VBW:3000.000kHz SWT:Auto Detector : Peak Project : 822214 Mode : 10</p>	<p>Site : 03CH12-HY Condition : PEAK_FA_3m HORN_91200_1328 HORIZONTAL RBW:1000.000kHz VBW:3000.000kHz SWT:Auto Detector : Peak Project : 822214 Mode : 10</p>
Avg.	<p>Site : 03CH12-HY Condition : AVG_BE_54 3m HORN_91200_1328 HORIZONTAL RBW:1000.000kHz VBW:3.000kHz SWT:Auto Detector : Peak Project : 822214 Mode : 10</p>	<p>Site : 03CH12-HY Condition : AVG_FA_3m HORN_91200_1328 HORIZONTAL RBW:1000.000kHz VBW:3.000kHz SWT:Auto Detector : Peak Project : 822214 Mode : 10</p>



BLE	2.4GHz 2400~2483.5MHz Band Edge @ 3m	
ANT	BLE CH00 2402MHz	
1	Vertical	Fundamental
Peak	<p>Site : 03CH12-11Y Condition : PEAK_9C_74 3m HORN_9120D_1328 VERTICAL RBW:3000.000kHz VBW:3000.000kHz SWT:Auto Detector : Peak Project : 822214 Mode : 10</p>	<p>Site : 03CH12-11Y Condition : PEAK_74 3m HORN_9120D_1328 VERTICAL RBW:3000.000kHz VBW:3000.000kHz SWT:Auto Detector : Peak Project : 822214 Mode : 10</p>
Avg	<p>Site : 03CH12-11Y Condition : AVG_BE_54 3m HORN_9120D_1328 VERTICAL RBW:3000.000kHz VBW:3.000kHz SWT:Auto Detector : Peak Project : 822214 Mode : 10</p>	<p>Site : 03CH12-11Y Condition : AVG_54 3m HORN_9120D_1328 VERTICAL RBW:3000.000kHz VBW:3.000kHz SWT:Auto Detector : Peak Project : 822214 Mode : 10</p>

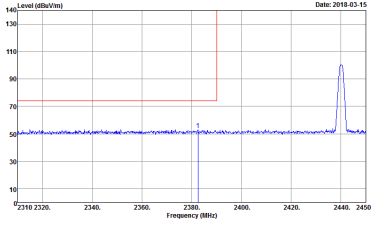
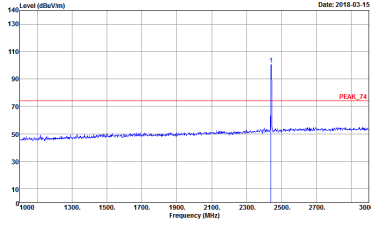
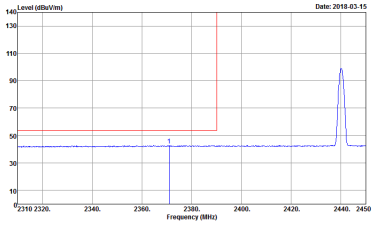
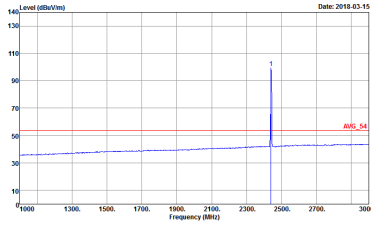

BLE	2.4GHz 2400~2483.5MHz Band Edge @ 3m	
ANT	BLE CH19 2440MHz - L	
1	Horizontal	Fundamental
Peak	 <p>Site : 03CH12-HY Condition : PEAK_BE_74 3m HORN_91200_1328 HORIZONTAL Detector : Peak Project : 822214 Mode : II</p>	 <p>Site : 03CH12-HY Condition : PEAK_74 3m HORN_91200_1328 HORIZONTAL Detector : Peak Project : 822214 Mode : II</p>
Avg.	 <p>Site : 03CH12-HY Condition : AVG_BE_54 3m HORN_91200_1328 HORIZONTAL Detector : Peak Project : 822214 Mode : II</p>	 <p>Site : 03CH12-HY Condition : AVG_54 3m HORN_91200_1328 HORIZONTAL Detector : Peak Project : 822214 Mode : II</p>

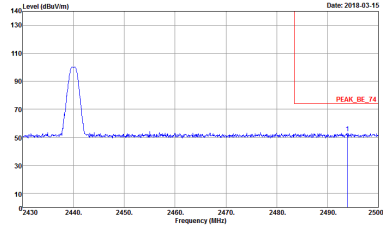
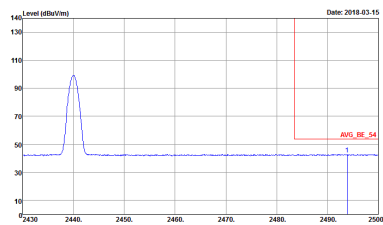

BLE	2.4GHz 2400~2483.5MHz Band Edge @ 3m	
ANT	BLE CH19 2440MHz - R	
1	Horizontal	Fundamental
<p>Peak</p>	 <p>Site : 03CH2-HY Condition : PEAK_BE_74 3m HORN_9120D_1328 HORIZONTAL Detector : Peak Project : 822214 Mode : 11</p>	<p>Left blank</p>
<p>Avg.</p>	 <p>Site : 03CH2-HY Condition : AVG_BE_54 3m HORN_9120D_1328 HORIZONTAL Detector : Peak Project : 822214 Mode : 11</p>	<p>Left blank</p>

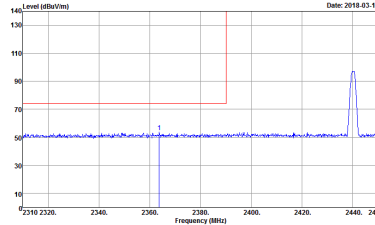
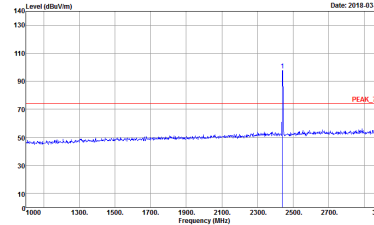
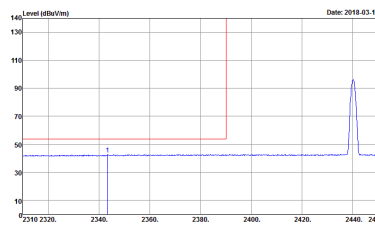
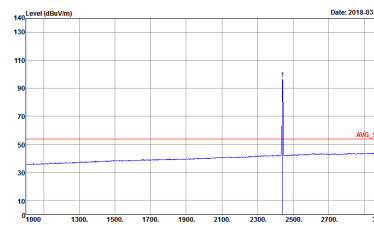

BLE	2.4GHz 2400~2483.5MHz Band Edge @ 3m	
ANT	BLE CH19 2440MHz - L	
1	Vertical	Fundamental
Peak	 <p>Site : 03CH12-HY Condition : PEAK_9C_74 3m HORN_9120D_1328 VERTICAL RBW:3000.000kHz VBW:3000.000kHz SWT:Auto Detector : Peak Project : 822214 Mode : 11</p>	 <p>Site : 03CH12-HY Condition : PEAK_74 3m HORN_9120D_1328 VERTICAL RBW:3000.000kHz VBW:3000.000kHz SWT:Auto Detector : Peak Project : 822214 Mode : 11</p>
Avg.	 <p>Site : 03CH12-HY Condition : AVG_BE_54 3m HORN_9120D_1328 VERTICAL RBW:3000.000kHz VBW:3.000kHz SWT:Auto Detector : Peak Project : 822214 Mode : 11</p>	 <p>Site : 03CH12-HY Condition : AVG_54 3m HORN_9120D_1328 VERTICAL RBW:3000.000kHz VBW:3.000kHz SWT:Auto Detector : Peak Project : 822214 Mode : 11</p>

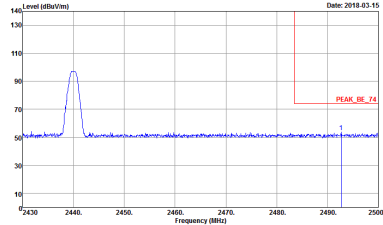
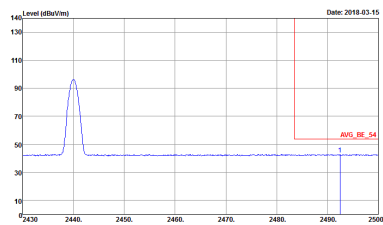

BLE	2.4GHz 2400~2483.5MHz Band Edge @ 3m	
ANT	BLE CH19 2440MHz - R	
1	Vertical	Fundamental
<p>Peak</p>	 <p>Site : 03CH2-HY Condition : PEAK_BE_74 3m HORN_9120D_1328 VERTICAL RBW:10000000Hz VBW:30000000Hz SWT:Auto Detector : Peak Project : 822214 Mode : 11</p>	<p>Left blank</p>
<p>Avg.</p>	 <p>Site : 03CH2-HY Condition : AVG_BE_54 3m HORN_9120D_1328 VERTICAL RBW:10000000Hz VBW:30000000Hz SWT:Auto Detector : Peak Project : 822214 Mode : 11</p>	<p>Left blank</p>

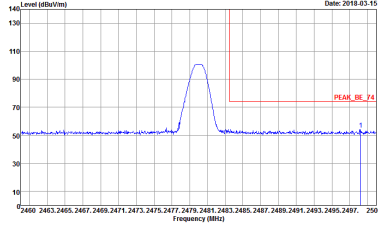
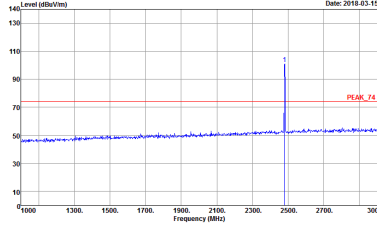
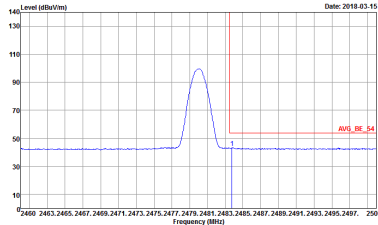
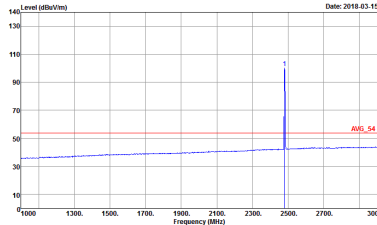

BLE	2.4GHz 2400~2483.5MHz Band Edge @ 3m	
ANT	BLE CH39 2480MHz	
1	Horizontal	Fundamental
<p>Peak</p>	 <p>Site : 03CH12-HY Condition : PEAK_BE_74 3m HORN_9120D_1328 HORIZONTAL RBW:3000.000kHz VBW:3000.000kHz SWT:Auto Detector : Peak Project : 822214 Mode : 12</p>	 <p>Site : 03CH12-HY Condition : PEAK_74 3m HORN_9120D_1328 HORIZONTAL RBW:3000.000kHz VBW:3000.000kHz SWT:Auto Detector : Peak Project : 822214 Mode : 12</p>
<p>Avg.</p>	 <p>Site : 03CH12-HY Condition : AVG_BE_54 3m HORN_9120D_1328 HORIZONTAL RBW:3000.000kHz VBW:3.000kHz SWT:Auto Detector : Peak Project : 822214 Mode : 12</p>	 <p>Site : 03CH12-HY Condition : AVG_54 3m HORN_9120D_1328 HORIZONTAL RBW:3000.000kHz VBW:3.000kHz SWT:Auto Detector : Peak Project : 822214 Mode : 12</p>

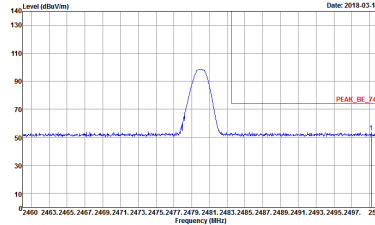
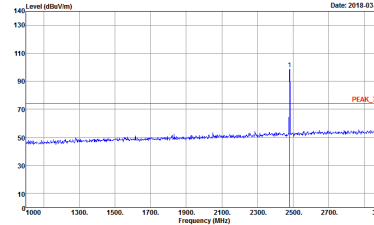
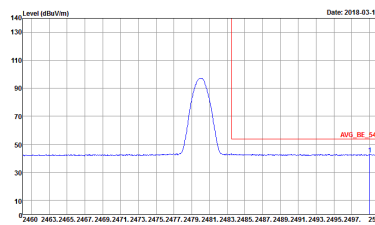
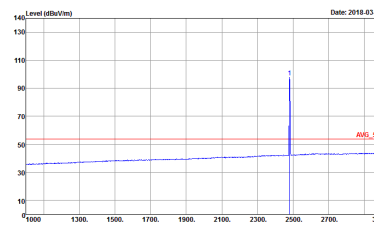

BLE	2.4GHz 2400~2483.5MHz Band Edge @ 3m	
ANT	BLE CH39 2480MHz	
1	Vertical	Fundamental
<p>Peak</p>	 <p>Site : 03CH12-HY Condition : PEAK_BE_74 3m HORN_9120D_1328 VERTICAL RBW:3000.000kHz VBW:3000.000kHz SWT:Auto Detector : Peak Project : 822214 Mode : 12</p>	 <p>Site : 03CH12-HY Condition : PEAK_74 3m HORN_9120D_1328 VERTICAL RBW:3000.000kHz VBW:3000.000kHz SWT:Auto Detector : Peak Project : 822214 Mode : 12</p>
<p>Avg.</p>	 <p>Site : 03CH12-HY Condition : AVG_BE_54 3m HORN_9120D_1328 VERTICAL RBW:3000.000kHz VBW:3.000kHz SWT:Auto Detector : Peak Project : 822214 Mode : 12</p>	 <p>Site : 03CH12-HY Condition : AVG_54 3m HORN_9120D_1328 VERTICAL RBW:3000.000kHz VBW:3.000kHz SWT:Auto Detector : Peak Project : 822214 Mode : 12</p>



2.4GHz 2400~2483.5MHz

BLE (Harmonic @ 3m)

BLE	2.4GHz 2400~2483.5MHz Harmonic @ 3m	
ANT	BLE CH00 2402MHz	
1	Horizontal	Vertical
Peak Avg.	<p>Site : 03CH12-44Y Condition : PEAK_74 3m HORN_91200_1328 HORIZONTAL Detector : Peak Project : 822214 Mode : 10</p>	<p>Site : 03CH12-44Y Condition : PEAK_74 3m HORN_91200_1328 VERTICAL Detector : Peak Project : 822214 Mode : 10</p>

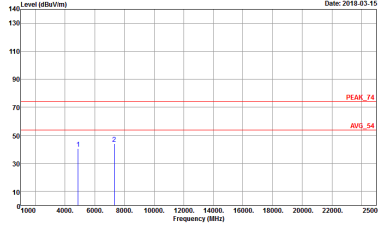
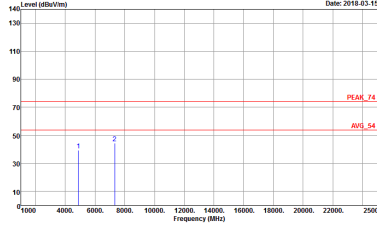

BLE	2.4GHz 2400~2483.5MHz Harmonic @ 3m	
ANT	BLE CH19 2440MHz	
1	Horizontal	Vertical
<p>Peak</p> <p>Avg.</p>	 <p>Site : 03CH12-11Y Condition : PEAK_74 3m HORN_91200_1328 HORIZONTAL Detector : Peak Project : 822214 Mode : 11</p>	 <p>Site : 03CH12-11Y Condition : PEAK_74 3m HORN_91200_1328 VERTICAL Detector : Peak Project : 822214 Mode : 11</p>



BLE	2.4GHz 2400~2483.5MHz Harmonic @ 3m	
ANT	BLE CH39 2480MHz	
1	Horizontal	Vertical
Peak	<p>Site : 03CH12-11Y Condition : PEAK_74 3m HORN_91200_1328 HORIZONTAL Detector : Peak Project : 822214 Mode : 12</p>	<p>Site : 03CH12-11Y Condition : PEAK_74 3m HORN_91200_1328 VERTICAL Detector : Peak Project : 822214 Mode : 12</p>



Emission below 1GHz

2.4GHz BLE (LF)

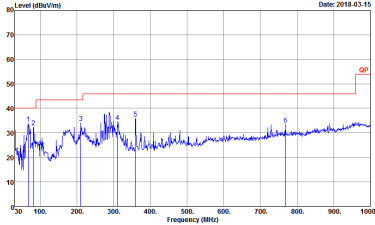
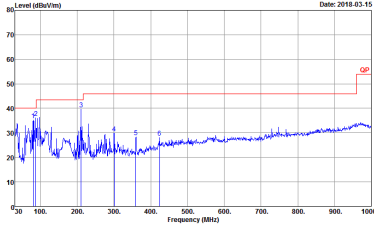
BLE	2.4GHz 2400~2483.5MHz	
ANT	BLE LF	
1	Horizontal	Vertical
<p>QP / Peak</p>	 <p>Site : 03CH12-HY Condition : QP 3m SILEOS_6111D_35414 HORIZONTAL Detector : Peak Project : 822214 Mode : 17</p>	 <p>Site : 03CH12-HY Condition : QP 3m SILEOS_6111D_35414 VERTICAL Detector : Peak Project : 822214 Mode : 17</p>



Appendix E. Duty Cycle Plots

Band	Duty Cycle (%)	T(us)	1/T(kHz)	VBW Setting	Duty Factor (dB)
Bluetooth -LE	61.54	384	2.60	3kHz	2.11

Bluetooth - LE

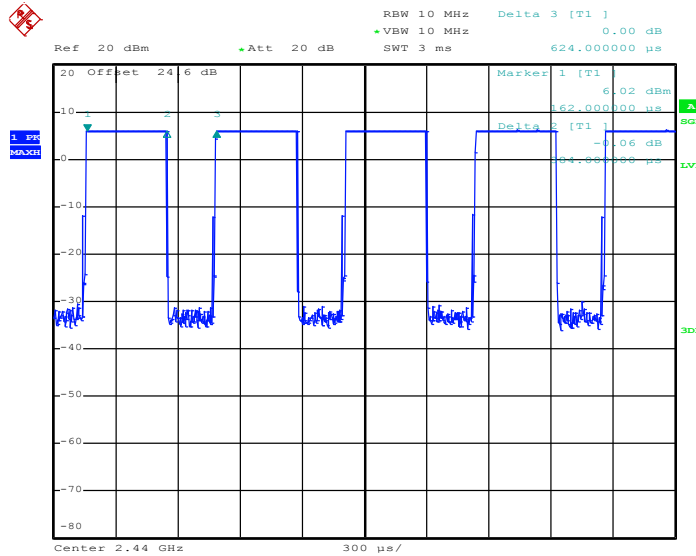

Date: 12.MAR.2018 22:58:35