

# FCC RF Test Report

**APPLICANT** : Universal Global Scientific Industrial Co., Ltd.  
**EQUIPMENT** : Bluetooth Module  
**BRAND NAME** : USI  
**MODEL NAME** : BM-GP-BR-65  
**FCC ID** : COFBMGPBR65  
**STANDARD** : FCC Part 15 Subpart C §15.247  
**CLASSIFICATION** : (DTS) Digital Transmission System

The product was received on Jun. 05, 2013 and completely tested on Jun. 13, 2013. We, SPORTON INTERNATIONAL INC., would like to declare that the tested sample has been evaluated in accordance with the procedures and shown the compliance with the applicable technical standards.

The test results in this report apply exclusively to the tested model / sample. Without written approval of SPORTON INTERNATIONAL INC., the test report shall not be reproduced except in full.



Reviewed by: Joseph Lin / Supervisor

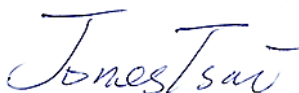

Approved by: Jones Tsai / Manager



**SPORTON INTERNATIONAL INC.**

No. 52, Hwa Ya 1<sup>st</sup> Rd., Hwa Ya Technology Park, Kwei-Shan Hsiang, Tao Yuan Hsien, Taiwan, R.O.C.



# TABLE OF CONTENTS

**REVISION HISTORY..... 3**

**SUMMARY OF TEST RESULT ..... 4**

**1 GENERAL DESCRIPTION..... 5**

    1.1 Applicant ..... 5

    1.2 Manufacturer..... 5

    1.3 Feature of Equipment Under Test ..... 5

    1.4 Product Specification of Equipment Under Test..... 5

    1.5 Modification of EUT ..... 6

    1.6 Testing Site..... 6

    1.7 Applied Standards ..... 6

**2 TEST CONFIGURATION OF EQUIPMENT UNDER TEST..... 7**

    2.1 Descriptions of Test Mode ..... 7

    2.2 Test Mode..... 7

    2.3 Connection Diagram of Test System..... 8

    2.4 Support Unit used in test configuration and system ..... 9

    2.5 EUT Operation Test Setup ..... 9

    2.6 Measurement Results Explanation Example..... 10

**3 TEST RESULT ..... 11**

    3.1 6dB and 99% Bandwidth Measurement ..... 11

    3.2 Peak Output Power Measurement ..... 16

    3.3 Power Spectral Density Measurement ..... 18

    3.4 Conducted Band Edges and Spurious Emission Measurement ..... 24

    3.5 Radiated Band Edges and Spurious Emission Measurement ..... 33

    3.6 AC Conducted Emission Measurement..... 42

    3.7 Antenna Requirements..... 46

**4 LIST OF MEASURING EQUIPMENT..... 47**

**5 UNCERTAINTY OF EVALUATION..... 48**

**APPENDIX A. PHOTOGRAPHS OF EUT**

**APPENDIX B. SETUP PHOTOGRAPHS**



### REVISION HISTORY

REPORT NO.	VERSION	DESCRIPTION	ISSUED DATE
FR360543B	Rev. 01	Initial issue of report	Jun. 21, 2013



### SUMMARY OF TEST RESULT

Report Section	FCC Rule	IC Rule	Description	Limit	Result	Remark
3.1	15.247(a)(2)	RSS-210 A8.2(a)	6dB Bandwidth	$\geq 0.5\text{MHz}$	Pass	-
3.1	-	RSS-Gen 4.6.1	99% Bandwidth	-	Pass	-
3.2	15.247(b)(1)	RSS-210 A8.1(b)	Peak Output Power	$\leq 30\text{dBm}$	Pass	-
3.3	15.247(e)	RSS-210 A8.2(b)	Power Spectral Density	$\leq 8\text{dBm}$	Pass	-
3.4	15.247(d)	RSS-210 A8.5	Conducted Band Edges and Spurious Emission	$\leq 20\text{dBc}$	Pass	-
3.5	15.247(d)	RSS-210 A8.5	Radiated Band Edges and Spurious Emission	15.209(a) & 15.247(d)	Pass	Under limit 6.38 dB at 59.970 MHz
3.6	15.207	RSS-210 Gen 7.2.2	AC Conducted Emission	15.207(a)	Pass	Under limit 10.90 dB at 0.150 MHz
3.7	15.203 & 15.247(b)	RSS-210 A8.4	Antenna Requirement	N/A	Pass	-

# 1 General Description

## 1.1 Applicant

Universal Global Scientific Industrial Co., Ltd.

141, Lane 351, Sec. 1, Taiping Road., Tsaotuen, Nantou 54261, Taiwan

## 1.2 Manufacturer

Universal Scientific Industrial (Shanghai) Co., Ltd.

No. 1558, Zhang Dong Road, Zhangjiang Hi-Tech Park, Shanghai, P.R. China 201203

## 1.3 Feature of Equipment Under Test

Product Feature	
Equipment	Bluetooth Module
Brand Name	USI
Model Name	BM-GP-BR-65
FCC ID	COFBMGPBR65
EUT supports Radios application	Bluetooth 2.1/3.0/4.0
EUT Stage	Production Unit

Remark: The above EUT's information was declared by manufacturer. Please refer to the specifications or user's manual for more detailed description.

## 1.4 Product Specification of Equipment Under Test

Product Specification subjective to this standard	
Tx/Rx Frequency Range	2402 MHz ~ 2480 MHz
Number of Channels	40
Carrier Frequency of Each Channel	40 Channel(37 hopping + 3 advertising channel)
Maximum Output Power to Antenna	6.99 dBm (0.005 W)
99% Occupied Bandwidth	1.040MHz
Antenna Type	Chip Antenna with gain 2.50 dBi
Type of Modulation	Bluetooth 4.0 - LE : GFSK



### 1.5 Modification of EUT

No modifications are made to the EUT during all test items.

### 1.6 Testing Site

<b>Test Site</b>	SPORTON INTERNATIONAL INC.			
<b>Test Site Location</b>	No. 52, Hwa Ya 1 <sup>st</sup> Rd., Hwa Ya Technology Park, Kwei-Shan Hsiang, Tao Yuan Hsien, Taiwan, R.O.C. TEL: +886-3-3273456 / FAX: +886-3-3284978			
<b>Test Site No.</b>	<b>Sporton Site No.</b>			<b>FCC/IC Registration No.</b>
	TH02-HY	CO05-HY	03CH06-HY	722060/4086B-1

The test site complies with ANSI C63.4 2003 requirement.

### 1.7 Applied Standards

According to the specifications of the manufacturer, the EUT must comply with the requirements of the following standards:

- FCC Part 15 Subpart C §15.247
- FCC KDB Publication No. 558074 D01 DTS Meas. Guidance v03r01
- ANSI C63.10-2009

**Remark:**

1. All test items were verified and recorded according to the standards and without any deviation during the test.
2. This EUT has also been tested and complied with the requirements of FCC Part 15, Subpart B, recorded in a separate test report.

## 2 Test Configuration of Equipment Under Test

### 2.1 Descriptions of Test Mode

The RF output power was recorded in the following table:

Channel	Frequency	Bluetooth 4.0 – LE RF Output Power	
		Data Rate / Modulation	
		GFSK	
		1Mbps	
Ch00	2402MHz	6.75 dBm	
Ch19	2440MHz	6.96 dBm	
Ch39	2480MHz	6.99 dBm	

- a. The EUT has been associated with peripherals pursuant to ANSI C63.10-2009 and configuration operated in a manner tended to maximize its emission characteristics in a typical application. Frequency range investigated: conduction (150 kHz to 30 MHz), radiation (9 kHz to the 10th harmonic of the highest fundamental frequency or to 40 GHz, whichever is lower).
- b. AC power line Conducted Emission was tested under maximum output power.

### 2.2 Test Mode

The following summary table is showing all test modes to demonstrate in compliance with the standard.

Summary table of Test Cases	
Test Item	Data Rate / Modulation
	Bluetooth 4.0 – LE / GFSK
Conducted TCs	Mode 1: Bluetooth Tx CH00_2402 MHz_1Mbps Mode 2: Bluetooth Tx CH19_2440 MHz_1Mbps Mode 3: Bluetooth Tx CH39_2480 MHz_1Mbps
Radiated TCs	Mode 1: Bluetooth Tx CH00_2402 MHz_1Mbps Mode 2: Bluetooth Tx CH19_2440 MHz_1Mbps Mode 3: Bluetooth Tx CH39_2480 MHz_1Mbps
AC Conducted Emission	Mode 1 :Bluetooth Link + USB Cable (Connect with Notebook)

## 2.3 Connection Diagram of Test System

<Bluetooth 4.0 – LE Tx Mode>

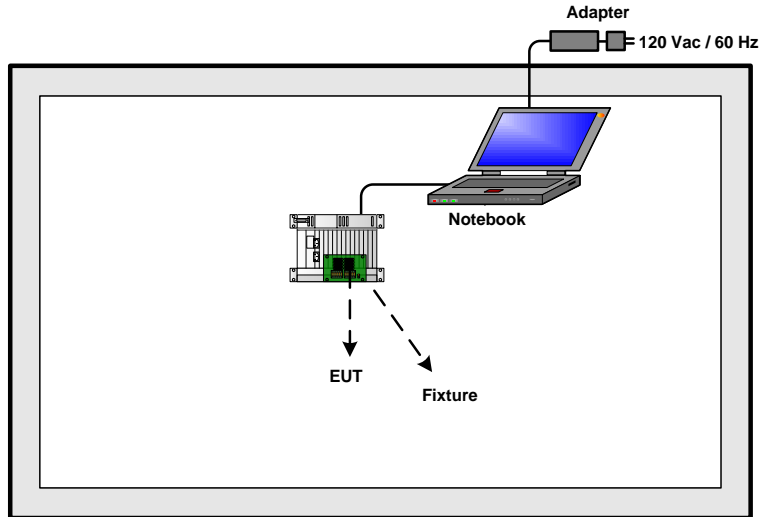

<AC Conducted Emission Mode>

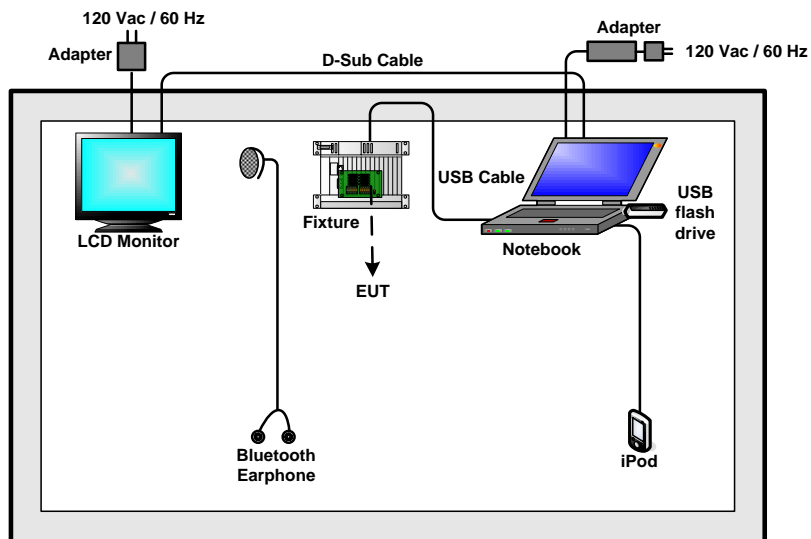



## 2.4 Support Unit used in test configuration and system

Item	Equipment	Trade Name	Model Name	FCC ID	Data Cable	Power Cord
1.	Notebook	DELL	P20G	FCC DoC	N/A	AC I/P: Unshielded, 1.2 m DC O/P: Shielded, 1.8 m
2.	USB Cable	Powersync	USM15K	FCC DoC	Shielded, 1.8 m	N/A
3.	USB flash drive	Transcend	JetFlash700	FCC DoC	N/A	N/A
4.	Bluetooth Earphone	Sony Ericsson	MW600	PY7DDA-2029	N/A	N/A
5.	iPod	Apple	A1285	FCC DoC	Shielded, 1.0 m	N/A
6.	LCD Monitor	DELL	U2410	FCC DoC	Shielded, 1.6 m	Unshielded, 1.8 m
7.	Fixture	USI	BM-GP-BR-65_E VB_V21	N/A	N/A	N/A

## 2.5 EUT Operation Test Setup

For Bluetooth function, programmed RF utility, “Blue Tool” installed in the notebook make the EUT provides functions like channel selection and power level for continuous transmitting and receiving signals.



## **2.6 Measurement Results Explanation Example**

**For all conducted test items:**

The offset level is set in the spectrum analyzer to compensate the RF cable loss and attenuator factor between EUT conducted output port and spectrum analyzer. With the offset compensation, the spectrum analyzer reading level is exactly the EUT RF output level.

The spectrum analyzer offset is derived from RF cable loss and attenuator factor.

*Offset = RF cable loss + attenuator factor.*

Following shows an offset computation example with cable loss 4.2 dB and 10dB attenuator.

Example :

$$\begin{aligned} \text{Offset(dB)} &= \text{RF cable loss(dB)} + \text{attenuator factor(dB)}. \\ &= 4.2 + 10 = 14.2 \text{ (dB)} \end{aligned}$$

### 3 Test Result

#### 3.1 6dB and 99% Bandwidth Measurement

##### 3.1.1 Limit of 6dB and 99% Bandwidth

The minimum 6 dB bandwidth shall be at least 500 kHz.

##### 3.1.2 Measuring Instruments

See list of measuring instruments of this test report.

##### 3.1.3 Test Procedures

1. The testing follows FCC KDB Publication No. 558074 D01 DTS Meas. Guidance v03r01.
2. The RF output of EUT was connected to the spectrum analyzer by RF cable and attenuator. The path loss was compensated to the results for each measurement.
3. Set to the maximum power setting and enable the EUT transmit continuously.
4. Make the measurement with the spectrum analyzer's resolution bandwidth (RBW) = 100 kHz. Set the Video bandwidth (VBW) = 300 kHz. In order to make an accurate measurement. The 6 dB bandwidth must be greater than 500 kHz.
5. For 99% Bandwidth Measurement, the spectrum analyzer's resolution bandwidth (RBW) is set 30kHz and set the Video bandwidth (VBW) = 100kHz.
6. Measure and record the results in the test report.

##### 3.1.4 Test Setup

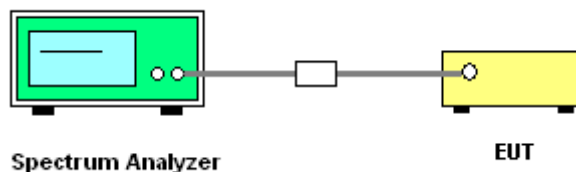



3.1.5 Test Result of 6dB Bandwidth

Test Mode :	Bluetooth 4.0 - LE	Temperature :	22~25°C
Test Engineer :	Coyote Lin	Relative Humidity :	51~55%

Channel	Frequency (MHz)	6dB Bandwidth (MHz)	6dB Bandwidth Min. Limit (MHz)	Pass/Fail
00	2402	0.7230	0.5	Pass
19	2440	0.7269	0.5	Pass
39	2480	0.7269	0.5	Pass

6 dB Bandwidth Plot on Channel 00

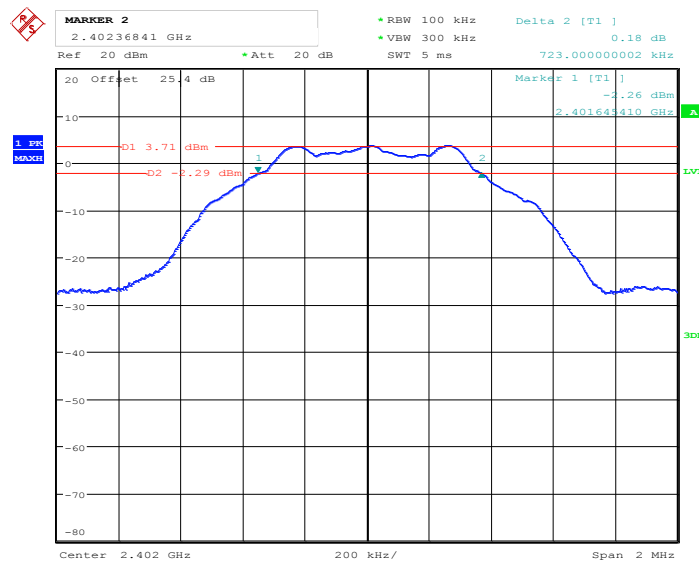

Date: 11.JUN.2013 13:43:17



### 6 dB Bandwidth Plot on Channel 19

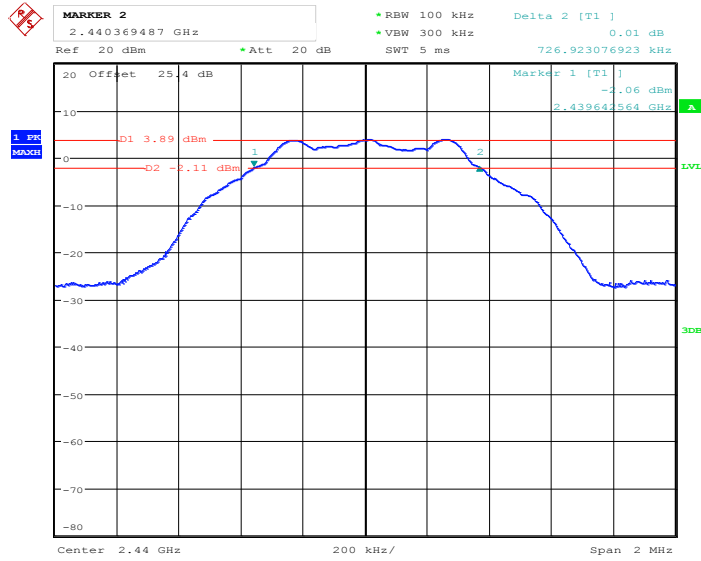

Date: 11.JUN.2013 13:48:32

### 6 dB Bandwidth Plot on Channel 39

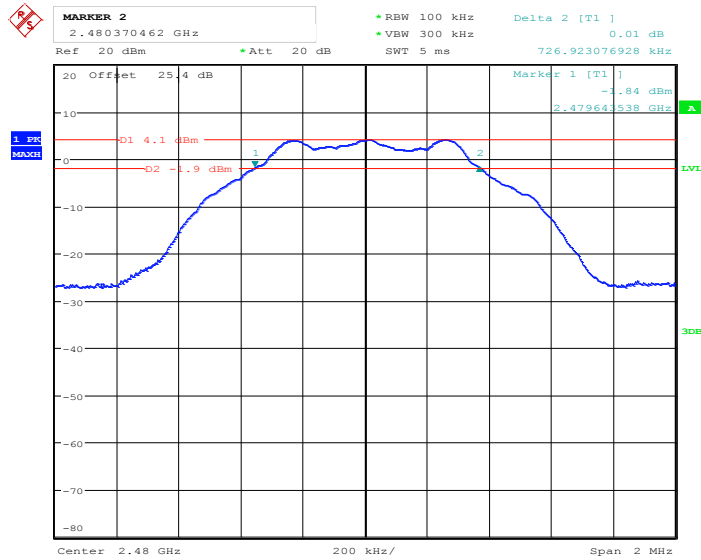

Date: 11.JUN.2013 13:56:24



3.1.6 Test Result of 99% Occupied Bandwidth

Test Mode :	Bluetooth 4.0 - LE	Temperature :	22~25°C
Test Engineer :	Coyote Lin	Relative Humidity :	51~55%

Channel	Frequency (MHz)	99% Occupied Bandwidth (MHz)
00	2402	1.038
19	2440	1.038
39	2480	1.040

99% Bandwidth Plot on Channel 00

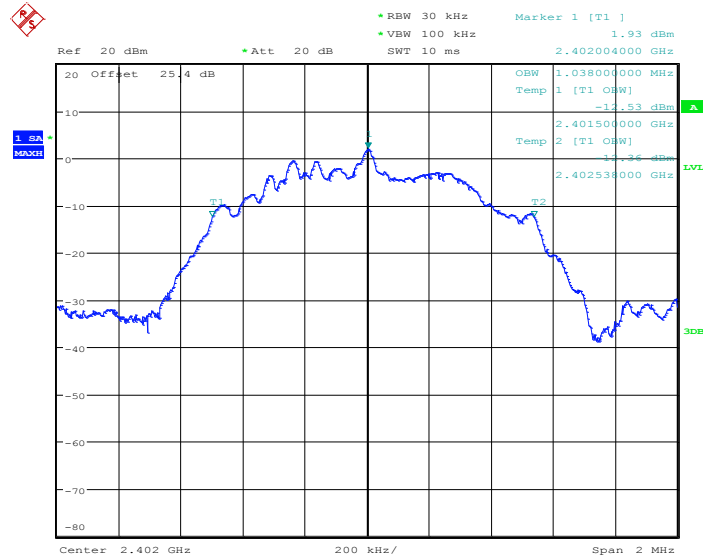

Date: 11.JUN.2013 13:46:31



99% Occupied Bandwidth Plot on Channel 19

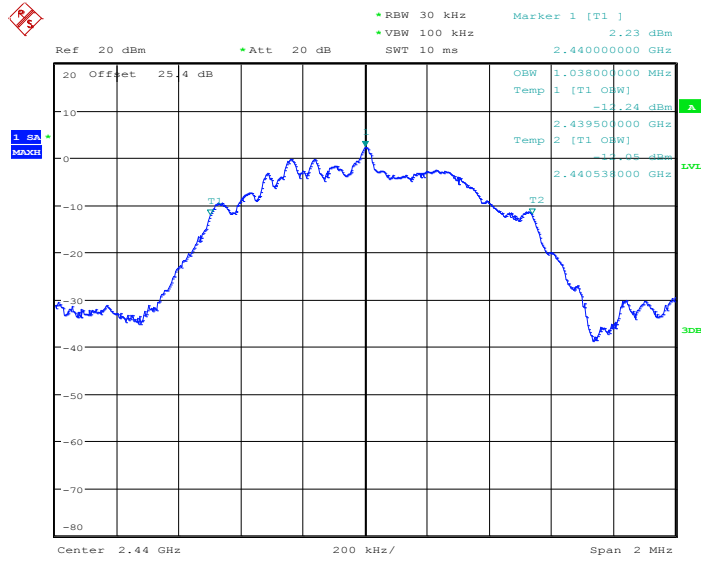

Date: 11.JUN.2013 13:52:37

99% Occupied Bandwidth Plot on Channel 39

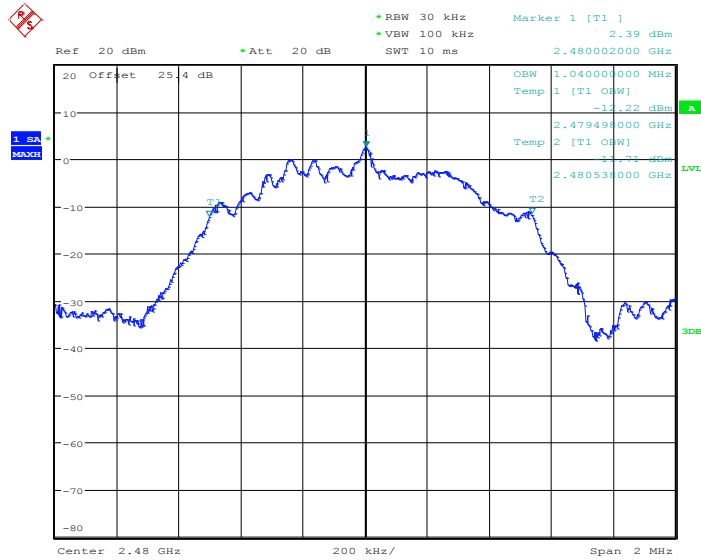

Date: 11.JUN.2013 14:04:52

## 3.2 Peak Output Power Measurement

### 3.2.1 Limit of Peak Output Power

For systems using digital modulation in the 2400-2483.5MHz, the limit for peak output power is 30dBm. If transmitting antenna of directional gain greater than 6dBi is used, the peak output power from the intentional radiator shall be reduced below the above stated value by the amount in dB that the directional gain of the antenna exceeds 6 dBi. In case of point-to-point operation, the limit has to be reduced by 1dB for every 3dB that the directional gain of the antenna exceeds 6dBi.

### 3.2.2 Measuring Instruments

See list of measuring instruments of this test report.

### 3.2.3 Test Procedures

1. The testing follows the Measurement Procedure of FCC KDB No. 558074 DTS D01 Meas. Guidance v03r01.
2. The RF output of EUT was connected to the power meter by RF cable and attenuator. The path loss was compensated to the results for each measurement.
3. Set to the maximum power setting and enable the EUT transmit continuously.
4. Measure the conducted output power and record the results in the test report.

### 3.2.4 Test Setup

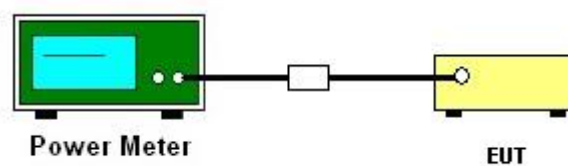





3.2.5 Test Result of Peak Output Power

Test Mode :	Bluetooth 4.0 - LE	Temperature :	22~25°C
Test Engineer :	Coyote Lin	Relative Humidity :	51~55%

Channel	Frequency (MHz)	RF Power (dBm)		
		GFSK	Max. Limits (dBm)	Pass/Fail
		1 Mbps		
00	2402	6.75	30.00	Pass
19	2440	6.96	30.00	Pass
39	2480	6.99	30.00	Pass

### 3.3 Power Spectral Density Measurement

#### 3.3.1 Limit of Power Spectral Density

The peak power spectral density shall not be greater than 8dBm in any 3kHz band at any time interval of continuous transmission.

#### 3.3.2 Measuring Instruments

See list of measuring instruments of this test report.

#### 3.3.3 Test Procedures

1. The testing follows Measurement Procedure 10.2 Method PKPSD of FCC KDB Publication No. 558074 D01 DTS Meas. Guidance v03r01
2. The RF output of EUT was connected to the spectrum analyzer by RF cable and attenuator. The path loss was compensated to the results for each measurement.
3. Set to the maximum power setting and enable the EUT transmit continuously.
4. Make the measurement with the spectrum analyzer's resolution bandwidth (RBW) = 3 kHz. Video bandwidth VBW = 10 kHz In order to make an accurate measurement, set the span to 1.5 times DTS Channel Bandwidth. (6dB BW)
5. Detector = peak, Sweep time = auto couple, Trace mode = max hold, Allow trace to fully stabilize. Use the peak marker function to determine the maximum power level.
6. Measure and record the results in the test report.
7. The Measured power density (dBm)/ 100kHz is a reference level and used as 20dBc down limit line for Conducted Band Edges and Conducted Spurious Emission.

#### 3.3.4 Test Setup

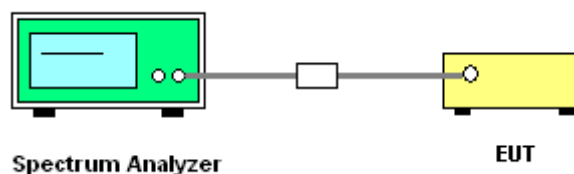



3.3.5 Test Result of Power Spectral Density

Test Mode :	Bluetooth 4.0 - LE	Temperature :	22~25°C
Test Engineer :	Coyote Lin	Relative Humidity :	51~55%

Channel	Frequency (MHz)	Power Density		Max. Limits (dBm/3kHz)	Pass/Fail
		PSD/100kHz (dBm)	PSD/3kHz (dBm)		
00	2402	3.60	-9.96	8	Pass
19	2440	3.89	-9.74	8	Pass
39	2480	4.09	-9.53	8	Pass

Note:

1. Measured power density (dBm) has offset with cable loss.
2. The Measured power density (dBm)/ 100kHz is reference level and used as 20dBc down for Conducted Band Edges and Conducted Spurious Emission limit line.



### 3.3.6 Test Result of Power Spectral Density Plots (100kHz)

PSD 100kHz Plot on Channel 00

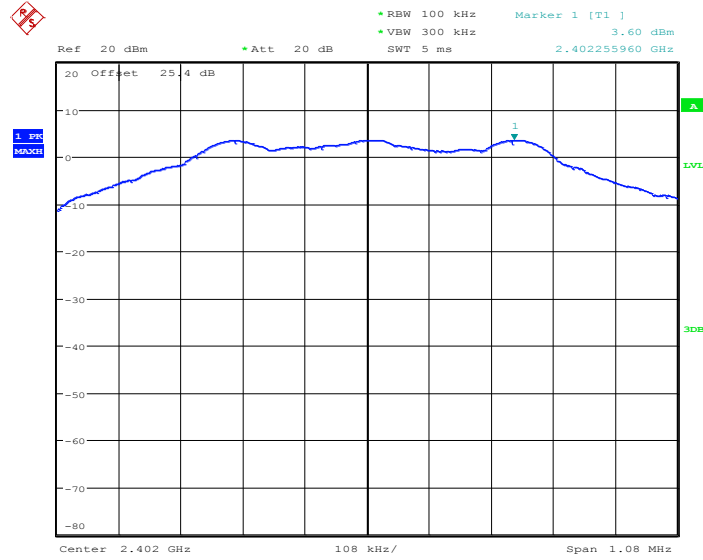

Date: 11.JUN.2013 13:44:45



PSD 100kHz Plot on Channel 19

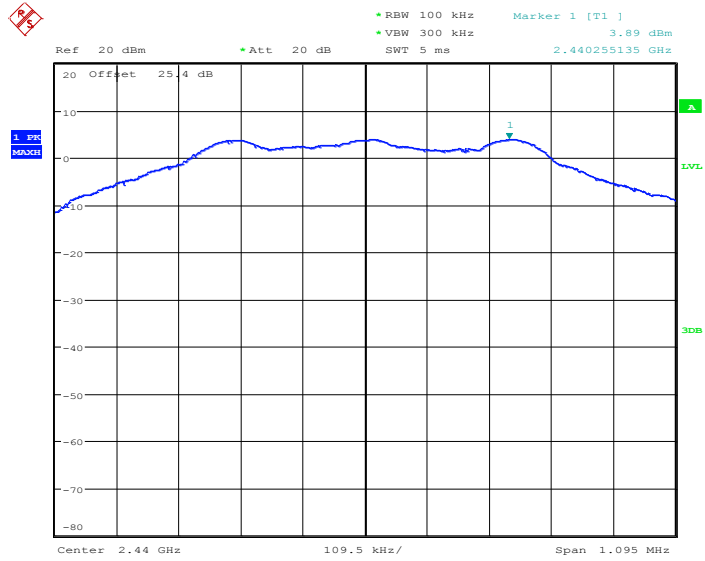

Date: 11.JUN.2013 13:49:34

PSD 100kHz Plot on Channel 39

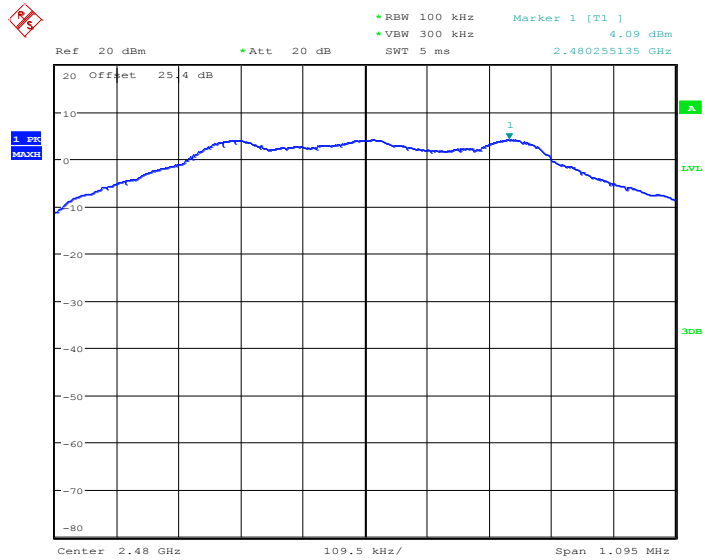

Date: 11.JUN.2013 14:03:03



### 3.3.7 Test Result of Power Spectral Density Plots (3kHz)

PSD 3kHz Plot on Channel 00

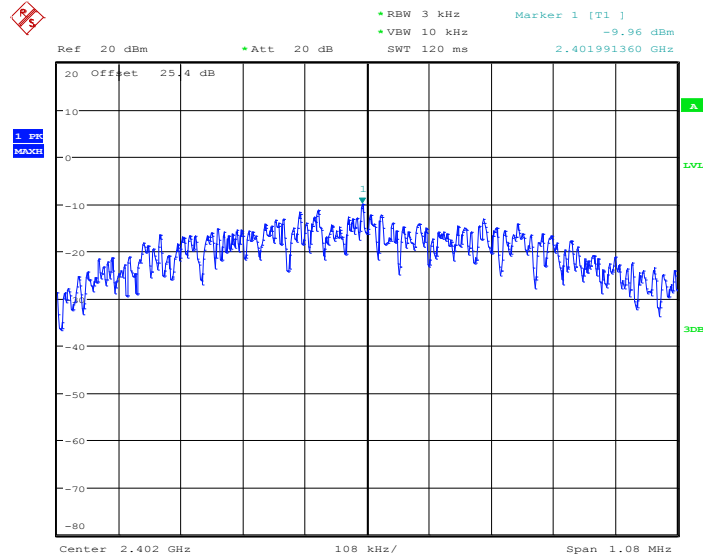

Date: 11.JUN.2013 13:44:35



PSD 3kHz Plot on Channel 19

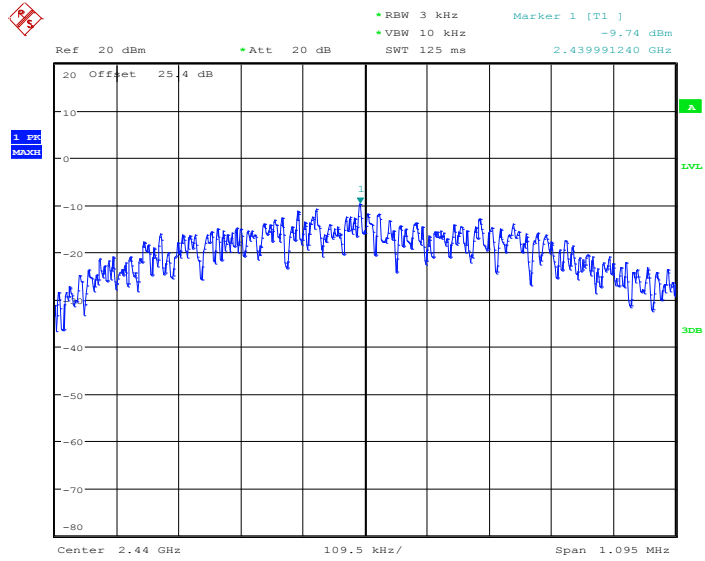

Date: 11.JUN.2013 13:48:56

PSD 3kHz Plot on Channel 39

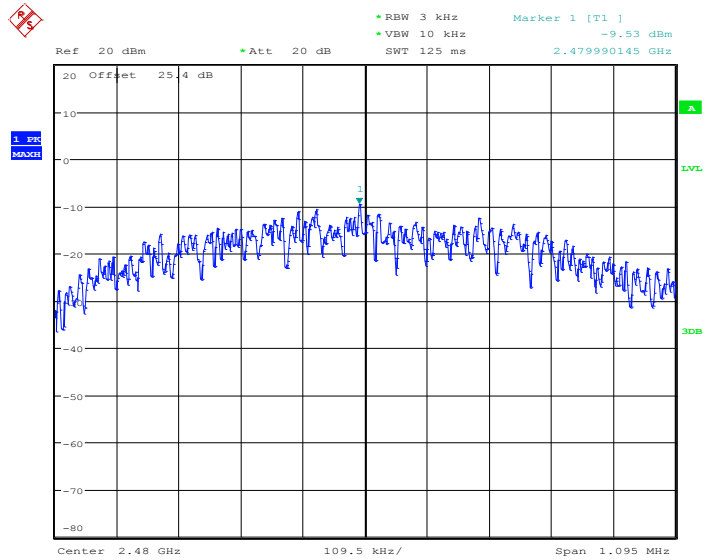

Date: 11.JUN.2013 14:02:21

### 3.4 Conducted Band Edges and Spurious Emission Measurement

#### 3.4.1 Limit of Conducted Band Edges and Spurious Emission

All harmonics/spurious must be at least 20 dB down from the highest emission level within the authorized band.

#### 3.4.2 Measuring Instruments

See list of measuring instruments of this test report.

#### 3.4.3 Test Procedure

1. The testing follows FCC KDB Publication No. 558074 D01 DTS Meas. Guidance v03r01.
2. The RF output of EUT was connected to the spectrum analyzer by RF cable and attenuator. The path loss was compensated to the results for each measurement.
3. Set to the maximum power setting and enable the EUT transmit continuously.
4. Set RBW = 100 kHz, VBW=300 kHz, Peak Detector. Unwanted Emissions measured in any 100 kHz bandwidth outside of the authorized frequency band shall be attenuated by at least 20 dB relative to the maximum in-band peak PSD level in 100 kHz when maximum peak conducted output power procedure is used. If the transmitter complies with the conducted power limits based on the use of RMS averaging over a time interval, the attenuation required under this paragraph shall be 30 dB instead of 20 dB per 15.247(d).
5. Measure and record the results in the test report.
6. The RF fundamental frequency should be excluded against the limit line in the operating frequency band.

#### 3.4.4 Test Setup

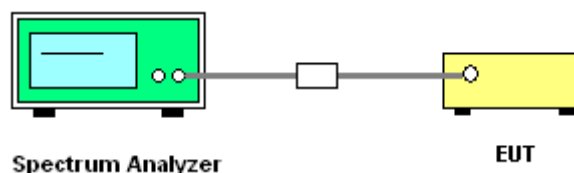





### 3.4.5 Test Result of Conducted Band Edges

Test Mode :	Bluetooth 4.0 - LE	Temperature :	22~25°C
Test Channel :	00 and 39	Relative Humidity :	51~55%
		Test Engineer :	Coyote Lin

Low Band Edge Plot on Channel 00

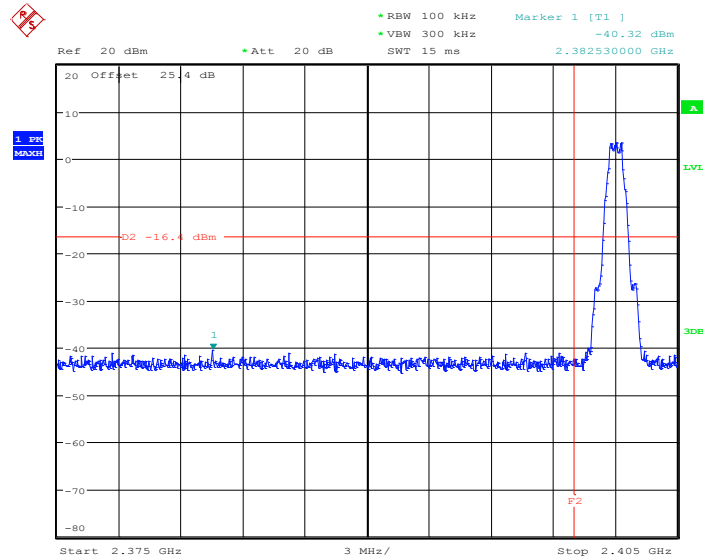

Date: 11.JUN.2013 13:45:08



High Band Edge Plot on Channel 39

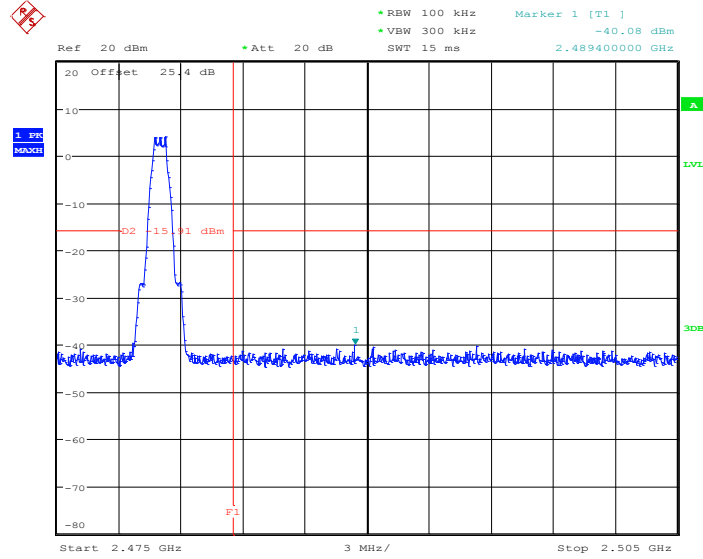

Date: 11.JUN.2013 14:03:30



### 3.4.6 Test Result of Conducted Spurious Emission

Test Mode :	Bluetooth 4.0 - LE	Temperature :	22~25°C
Test Channel :	00	Relative Humidity :	51~55%
		Test Engineer :	Coyote Lin

Conducted Spurious Emission Plot on Bluetooth LE 1Mbps GFSK Channel 00

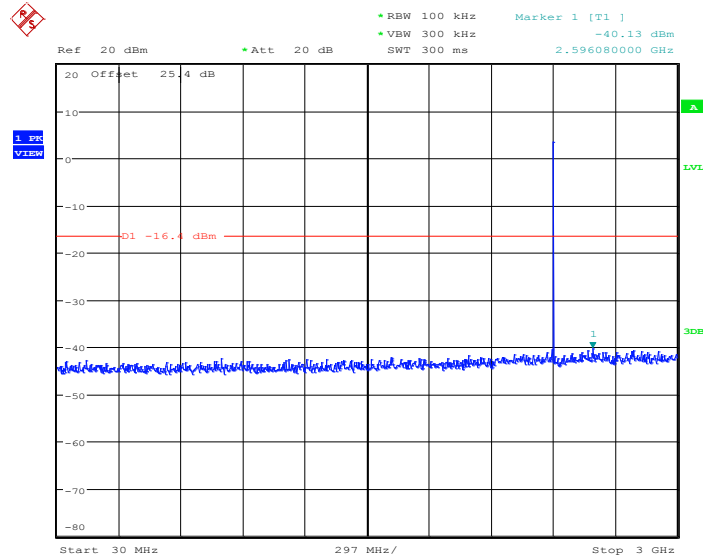

Date: 11.JUN.2013 13:45:49



Conducted Spurious Emission Plot on Bluetooth LE 1Mbps  
GFSK Channel 00

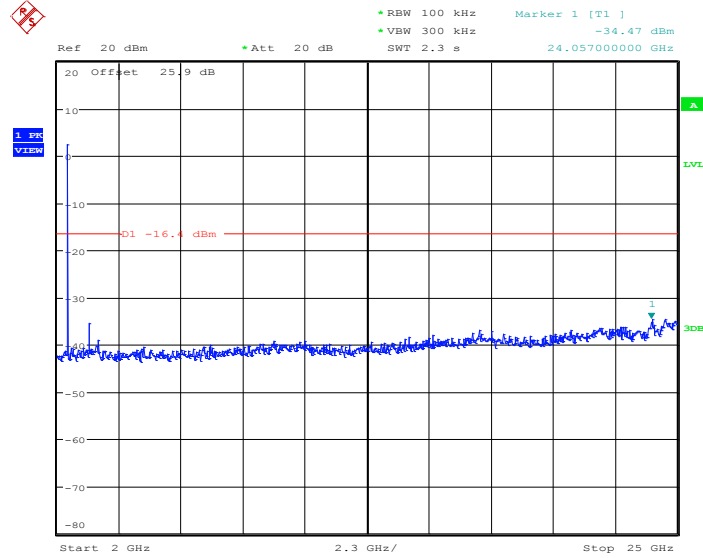

Date: 11.JUN.2013 13:46:07



Test Mode :	Bluetooth 4.0 - LE	Temperature :	22~25°C
Test Channel :	19	Relative Humidity :	51~55%
		Test Engineer :	Coyote Lin

Conducted Spurious Emission Plot on Bluetooth LE 1Mbps  
GFSK Channel 19

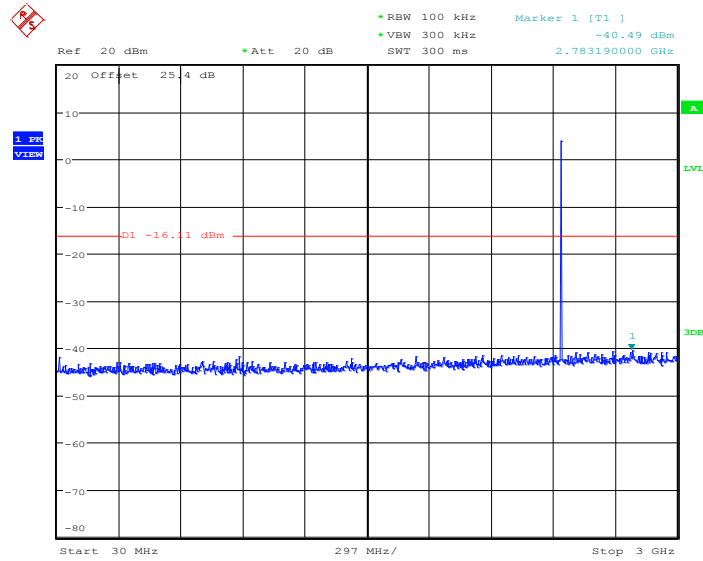

Date: 11.JUN.2013 13:50:07



Conducted Spurious Emission Plot on Bluetooth LE 1Mbps  
GFSK Channel 19

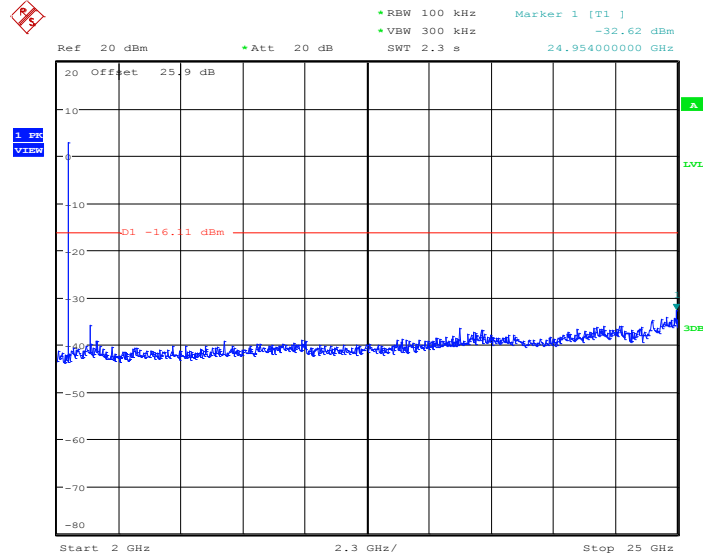

Date: 11.JUN.2013 13:50:25



Test Mode :	Bluetooth 4.0 - LE	Temperature :	22~25°C
Test Channel :	39	Relative Humidity :	51~55%
		Test Engineer :	Coyote Lin

Conducted Spurious Emission Plot on Bluetooth LE 1Mbps  
GFSK Channel 39

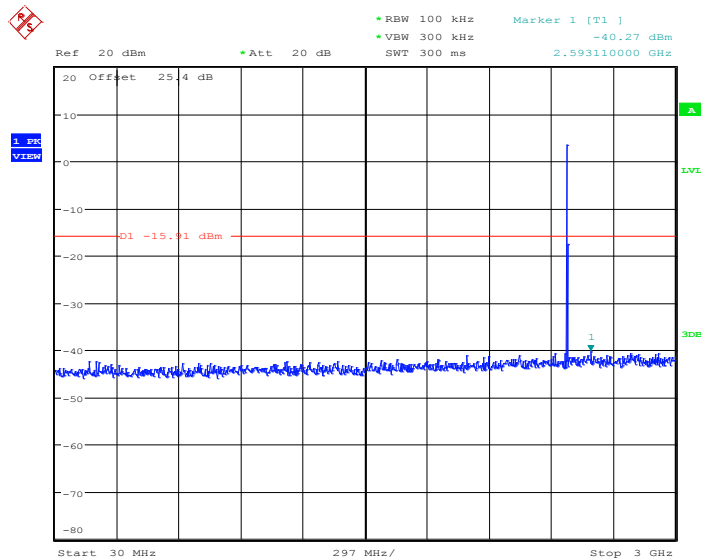

Date: 11.JUN.2013 14:03:57



Conducted Spurious Emission Plot on Bluetooth LE 1Mbps  
GFSK Channel 39

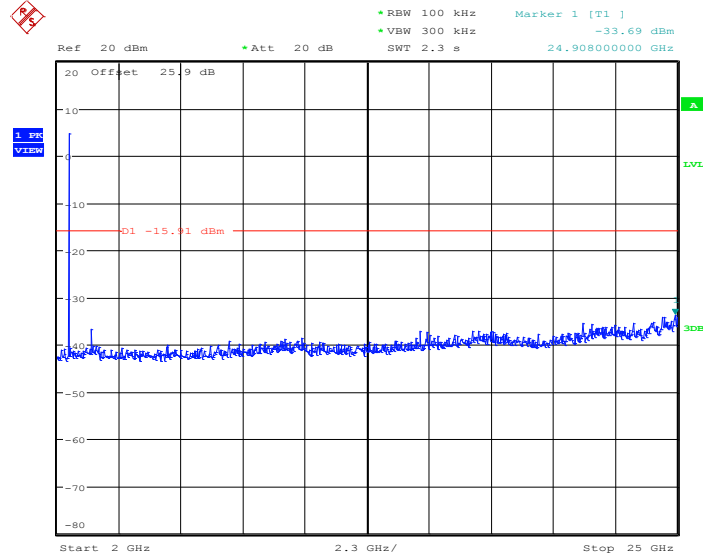

Date: 11.JUN.2013 14:04:15





### 3.5 Radiated Band Edges and Spurious Emission Measurement

#### 3.5.1 Limit of Radiated Band Edges and Spurious Emission

In any 100 kHz bandwidth outside the intentional radiator frequency band, all harmonics/spurious must be at least 20 dB below the highest emission level within the authorized band. If the output power of this device was measured by spectrum analyzer, the attenuation under this paragraph shall be 30 dB instead of 20 dB. In addition, radiated emissions which fall in the restricted bands must also comply with the FCC section 15.209 limits as below.

Frequency (MHz)	Field Strength (microvolts/meter)	Measurement Distance (meters)
0.009 – 0.490	2400/F(kHz)	300
0.490 – 1.705	24000/F(kHz)	30
1.705 – 30.0	30	30
30 – 88	100	3
88 – 216	150	3
216 - 960	200	3
Above 960	500	3

#### 3.5.2 Measuring Instruments

See list of measuring instruments of this test report.



### 3.5.3 Test Procedures

1. The testing follows the guidelines in ANSI C63.10-2009.
2. The EUT was arranged to its worst case and then tune the antenna tower (from 1 m to 4 m) and turntable (from 0 degree to 360 degrees) to find the maximum reading. A pre-amp and a high pass filter are used for the test in order to get better signal level.
3. The EUT was placed on a turntable with 0.8 meter above ground.
4. The EUT was set 3 meters from the interference receiving antenna, which was mounted on the top of a variable height antenna tower.
5. Corrected Reading: Antenna Factor + Cable Loss + Read Level - Preamp Factor = Level
6. For measurement below 1GHz, If the emission level of the EUT measured by the peak detector is 3 dB lower than the applicable limit, the peak emission level will be reported. Otherwise, the emission measurement will be repeated using the quasi-peak detector and reported.
7. Use the following spectrum analyzer settings:
  - (1) Span shall wide enough to fully capture the emission being measured;
  - (2) Set RBW=100 kHz for  $f < 1$  GHz;  $VBW \geq RBW$ ; Sweep = auto; Detector function = peak; Trace = max hold;
  - (3) Set RBW = 1 MHz, VBW= 3MHz for  $f \geq 1$  GHz for peak measurement.  
For average measurement:
    - $VBW = 10$  Hz, when duty cycle is no less than 98 percent.
    - $VBW \geq 1/T$ , when duty cycle is less than 98 percent where T is the minimum transmission duration over which the transmitter is on and is transmitting at its maximum power control level for the tested mode of operation.

Band	Duty Cycle(%)	T( $\mu$ s)	1/T(kHz)	VBW Setting
Bluetooth 4.0 - LE	64.32	404.487179	2.472	3kHz

**Note:** For average measurement with duty cycle < 98%, use reduced VBW measurement method 4.2.3.2.3 in ANSI C63.10.

### 3.5.4 Test Setup

For radiated emissions below 30MHz

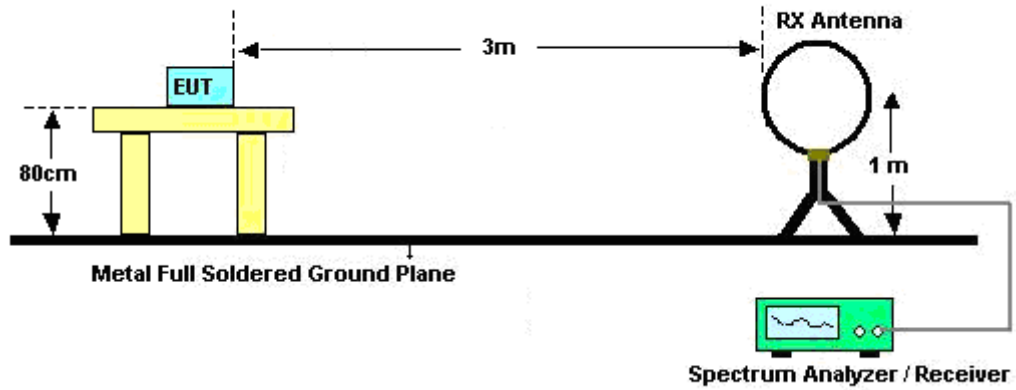

For radiated emissions from 30MHz to 1GHz

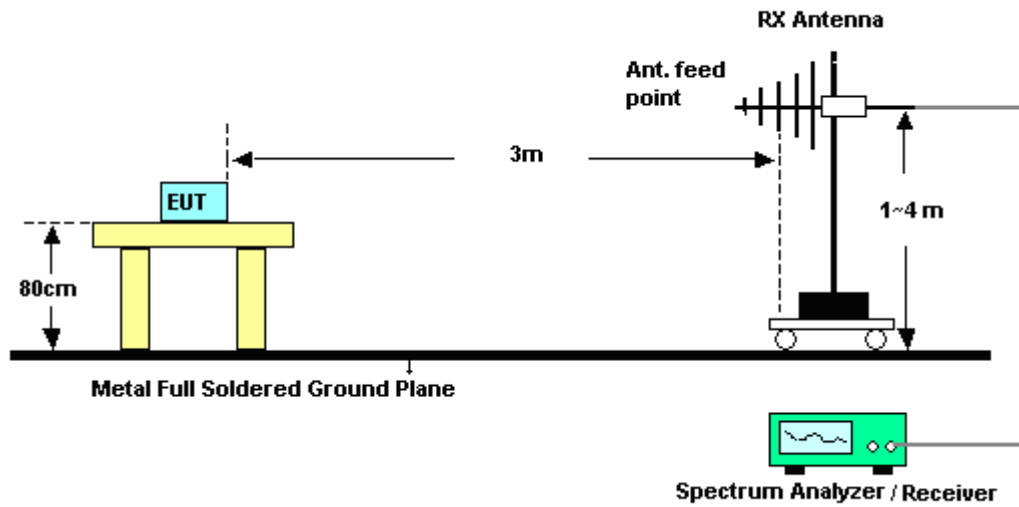

For radiated emissions above 1GHz

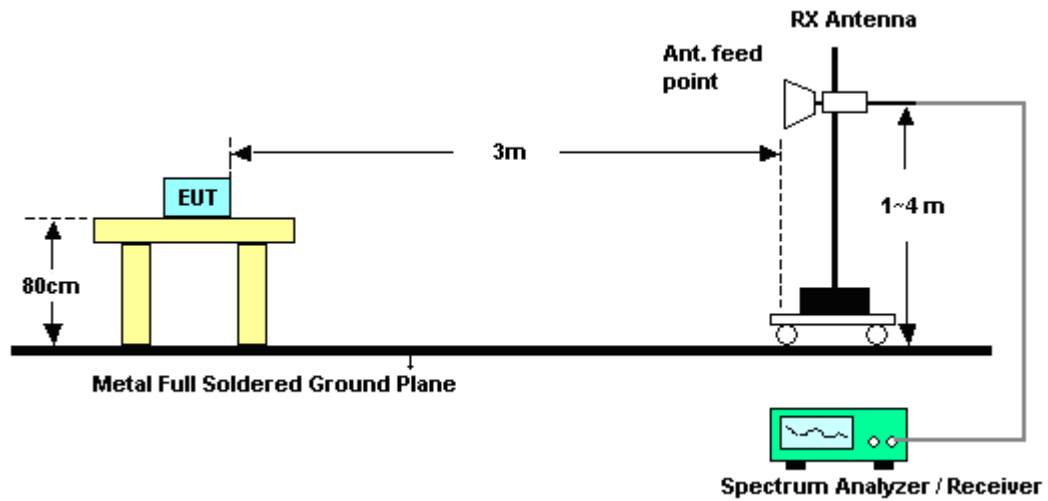

### 3.5.5 Test Results of Radiated Emissions (9 kHz ~ 30 MHz)

The low frequency, which started from 9 kHz to 30MHz, was pre-scanned and the result which was 20dB lower than the limit line per 15.31(o) was not reported.



3.5.6 Test Result of Radiated Band Edges

Test Mode :	Mode 1	Temperature :	21~23°C
Test Channel :	00	Relative Humidity :	47~49%
		Test Engineer :	Marlboro Hsu

ANTENNA POLARITY : HORIZONTAL										
Frequency ( MHz )	Level (dBµV /m )	Over Limit ( dB )	Limit Line (dBµV /m )	Read Level (dBµV)	Antenna Factor ( dB )	Cable Loss ( dB )	Preamp Factor ( dB )	Ant Pos ( cm )	Table Pos ( deg )	Remark
2329.08	49.43	-24.57	74	45.17	32.26	6.35	34.35	195	289	Peak
2381.73	38.38	-15.62	54	33.93	32.33	6.45	34.33	195	289	Average

ANTENNA POLARITY : VERTICAL										
Frequency ( MHz )	Level (dBµV /m )	Over Limit ( dB )	Limit Line (dBµV /m )	Read Level (dBµV)	Antenna Factor ( dB )	Cable Loss ( dB )	Preamp Factor ( dB )	Ant Pos ( cm )	Table Pos ( deg )	Remark
2387.76	49.44	-24.56	74	44.96	32.36	6.45	34.33	200	24	Peak
2382.27	38.31	-15.69	54	33.86	32.33	6.45	34.33	200	24	Average

Test Mode :	Mode 3	Temperature :	21~23°C
Test Channel :	39	Relative Humidity :	47~49%
		Test Engineer :	Marlboro Hsu

ANTENNA POLARITY : HORIZONTAL										
Frequency ( MHz )	Level (dBµV /m )	Over Limit ( dB )	Limit Line (dBµV /m )	Read Level (dBµV)	Antenna Factor ( dB )	Cable Loss ( dB )	Preamp Factor ( dB )	Ant Pos ( cm )	Table Pos ( deg )	Remark
2485.42	50.4	-23.6	74	45.63	32.48	6.59	34.3	106	309	Peak
2483.5	39.76	-14.24	54	34.99	32.48	6.59	34.3	106	309	Average

ANTENNA POLARITY : VERTICAL										
Frequency ( MHz )	Level (dBµV /m )	Over Limit ( dB )	Limit Line (dBµV /m )	Read Level (dBµV)	Antenna Factor ( dB )	Cable Loss ( dB )	Preamp Factor ( dB )	Ant Pos ( cm )	Table Pos ( deg )	Remark
2495.05	49.94	-24.06	74	45.14	32.5	6.59	34.29	195	26	Peak
2483.5	39.57	-14.43	54	34.8	32.48	6.59	34.3	195	26	Average

3.5.7 Test Result of Radiated Emission (30 MHz ~ 10<sup>th</sup> Harmonic)

Test Mode :	Mode 1	Temperature :	21~23°C
Test Channel :	00	Relative Humidity :	47~49%
Test Engineer :	Marlboro Hsu	Polarization :	Horizontal
Remark :	<ol style="list-style-type: none"> <li>1. 2402 MHz is fundamental signal which can be ignored.</li> <li>2. 7206 MHz is not within a restricted band, and its limit line is 20dB below the highest emission level. For example, 83.76dB <math>\mu</math> V/m - 20dB = 63.76dB <math>\mu</math> V/m.</li> <li>3. Average measurement was not performed if peak level went lower than the average limit.</li> </ol>		

Frequency ( MHz )	Level ( dB $\mu$ V/m )	Over Limit ( dB )	Limit Line ( dB $\mu$ V/m )	Read Level ( dB $\mu$ V )	Antenna Factor ( dB )	Cable Loss ( dB )	Preamp Factor ( dB )	Ant Pos ( cm )	Table Pos ( deg )	Remark
60.24	29.99	-10.01	40	54.99	5.9	0.87	31.77	100	93	Peak
192	29.48	-14.02	43.5	50.7	9.04	1.49	31.75	-	-	Peak
264.36	33.29	-12.71	46	49.92	13.3	1.8	31.73	-	-	Peak
335	33.47	-12.53	46	49.53	13.69	2	31.75	-	-	Peak
375.6	32.41	-13.59	46	47.24	14.85	2.12	31.8	-	-	Peak
443.5	29.91	-16.09	46	42.89	16.59	2.3	31.87	-	-	Peak
2402	82.72	-	-	78.24	32.36	6.45	34.33	195	289	Average
2402	83.76	-	-	79.28	32.36	6.45	34.33	195	289	Peak
4803	47.74	-26.26	74	58.26	34.88	10.16	55.56	100	0	Peak
7206	49.58	-14.18	63.76	58.94	36.16	10.97	56.49	100	0	Peak

Note: Other harmonics are lower than background noise.



<b>Test Mode :</b>	Mode 1	<b>Temperature :</b>	21~23°C
<b>Test Channel :</b>	00	<b>Relative Humidity :</b>	47~49%
<b>Test Engineer :</b>	Marlboro Hsu	<b>Polarization :</b>	Vertical
<b>Remark :</b>	1. 2402 MHz is fundamental signal which can be ignored. 2. 7206 MHz is not within a restricted band, and its limit line is 20dB below the highest emission level. 3. Average measurement was not performed if peak level went lower than the average limit.		

Frequency ( MHz )	Level ( dBμV/m )	Over Limit ( dB )	Limit Line (dBμV/m )	Read Level (dBμV)	Antenna Factor ( dB )	Cable Loss ( dB )	Preamp Factor ( dB )	Ant Pos ( cm )	Table Pos ( deg )	Remark
59.97	33.62	-6.38	40	58.62	5.9	0.87	31.77	100	135	Peak
108.3	28.71	-14.79	43.5	47.38	11.94	1.14	31.75	-	-	Peak
276.24	28.98	-17.02	46	46.04	12.84	1.83	31.73	-	-	Peak
480.6	27.92	-18.08	46	40.1	17.42	2.31	31.91	-	-	Peak
664	34.7	-11.3	46	44.75	19.15	2.83	32.03	-	-	Peak
699	31.14	-14.86	46	41.37	18.9	2.89	32.02	-	-	Peak
2402	80.11	-	-	75.63	32.36	6.45	34.33	200	24	Average
2402	81.13	-	-	76.65	32.36	6.45	34.33	200	24	Peak
4803	48.64	-25.36	74	59.16	34.88	10.16	55.56	100	0	Peak
7206	49.29	-11.84	61.13	58.65	36.16	10.97	56.49	100	0	Peak

**Note:** Other harmonics are lower than background noise.



<b>Test Mode :</b>	Mode 2	<b>Temperature :</b>	21~23°C
<b>Test Channel :</b>	19	<b>Relative Humidity :</b>	47~49%
<b>Test Engineer :</b>	Marlboro Hsu	<b>Polarization :</b>	Horizontal
<b>Remark :</b>	1. 2440 MHz is fundamental signal which can be ignored. 2. Average measurement was not performed if peak level went lower than the average limit.		

Frequency ( MHz )	Level ( dBμV/m )	Over Limit ( dB )	Limit Line ( dBμV/m )	Read Level ( dBμV )	Antenna Factor ( dB )	Cable Loss ( dB )	Preamp Factor ( dB )	Ant Pos ( cm )	Table Pos ( deg )	Remark
2440	81.66	-	-	77.03	32.43	6.52	34.32	200	338	Average
2440	82.59	-	-	77.96	32.43	6.52	34.32	200	338	Peak
4881	47.73	-26.27	74	58.37	34.85	10.19	55.68	100	0	Peak
7320	50.18	-23.82	74	59.35	36.13	10.94	56.24	100	0	Peak

**Note:** Other harmonics are lower than background noise.

<b>Test Mode :</b>	Mode 2	<b>Temperature :</b>	21~23°C
<b>Test Channel :</b>	19	<b>Relative Humidity :</b>	47~49%
<b>Test Engineer :</b>	Marlboro Hsu	<b>Polarization :</b>	Vertical
<b>Remark :</b>	1. 2440 MHz is fundamental signal which can be ignored. 2. Average measurement was not performed if peak level went lower than the average limit.		

Frequency ( MHz )	Level ( dBμV/m )	Over Limit ( dB )	Limit Line ( dBμV/m )	Read Level ( dBμV )	Antenna Factor ( dB )	Cable Loss ( dB )	Preamp Factor ( dB )	Ant Pos ( cm )	Table Pos ( deg )	Remark
2440	78.98	-	-	74.35	32.43	6.52	34.32	200	11	Average
2440	80	-	-	75.37	32.43	6.52	34.32	200	11	Peak
4881	48	-26	74	58.64	34.85	10.19	55.68	100	0	Peak
7320	49.14	-24.86	74	58.31	36.13	10.94	56.24	100	0	Peak

**Note:** Other harmonics are lower than background noise.





<b>Test Mode :</b>	Mode 3	<b>Temperature :</b>	21~23°C
<b>Test Channel :</b>	39	<b>Relative Humidity :</b>	47~49%
<b>Test Engineer :</b>	Marlboro Hsu	<b>Polarization :</b>	Horizontal
<b>Remark :</b>	1. 2480 MHz is fundamental signal which can be ignored. 2. Average measurement was not performed if peak level went lower than the average limit.		

Frequency ( MHz )	Level ( dBμV/m )	Over Limit ( dB )	Limit Line ( dBμV/m )	Read Level ( dBμV )	Antenna Factor ( dB )	Cable Loss ( dB )	Preamp Factor ( dB )	Ant Pos ( cm )	Table Pos ( deg )	Remark
2480	81.52	-	-	76.75	32.48	6.59	34.3	106	309	Average
2480	82.48	-	-	77.71	32.48	6.59	34.3	106	309	Peak
4959	47.51	-26.49	74	58.33	34.81	10.21	55.84	100	0	Peak
7440	48.76	-25.24	74	57.75	36.11	10.9	56	100	0	Peak

**Note:** Other harmonics are lower than background noise.

<b>Test Mode :</b>	Mode 3	<b>Temperature :</b>	21~23°C
<b>Test Channel :</b>	39	<b>Relative Humidity :</b>	47~49%
<b>Test Engineer :</b>	Marlboro Hsu	<b>Polarization :</b>	Vertical
<b>Remark :</b>	1. 2480 MHz is fundamental signal which can be ignored. 2. Average measurement was not performed if peak level went lower than the average limit.		

Frequency ( MHz )	Level ( dBμV/m )	Over Limit ( dB )	Limit Line ( dBμV/m )	Read Level ( dBμV )	Antenna Factor ( dB )	Cable Loss ( dB )	Preamp Factor ( dB )	Ant Pos ( cm )	Table Pos ( deg )	Remark
2480	81.26	-	-	76.49	32.48	6.59	34.3	195	26	Average
2480	82.17	-	-	77.4	32.48	6.59	34.3	195	26	Peak
4959	48.49	-25.51	74	59.31	34.81	10.21	55.84	100	0	Peak
7440	49.7	-24.3	74	58.69	36.11	10.9	56	100	0	Peak

**Note:** Other harmonics are lower than background noise.

## 3.6 AC Conducted Emission Measurement

### 3.6.1 Limit of AC Conducted Emission

For equipment that is designed to be connected to the public utility (AC) power line, the radio frequency voltage that is conducted back onto the AC power line on any frequency or frequencies within the band 150 kHz to 30 MHz shall not exceed the limits in the following table.

Frequency of emission (MHz)	Conducted limit (dB $\mu$ V)	
	Quasi-peak	Average
0.15-0.5	66 to 56*	56 to 46*
0.5-5	56	46
5-30	60	50

\*Decreases with the logarithm of the frequency.

### 3.6.2 Measuring Instruments

See list of measuring instruments of this test report.

### 3.6.3 Test Procedures

1. The testing follows the guidelines in ANSI C63.10-2009.
2. The EUT was placed 0.4 meter from the conducting wall of the shielding room was kept at least 80 centimeters from any other grounded conducting surface.
3. Connect EUT to the power mains through a line impedance stabilization network (LISN).
4. All the support units are connecting to the other LISN.
5. The LISN provides 50 ohm coupling impedance for the measuring instrument.
6. The FCC states that a 50 ohm, 50 microhenry LISN should be used.
7. Both sides of AC line were checked for maximum conducted interference.
8. The frequency range from 150 kHz to 30 MHz was searched.
9. Set the test-receiver system to Peak Detect Function and specified bandwidth with Maximum Hold Mode.

### 3.6.4 Test Setup

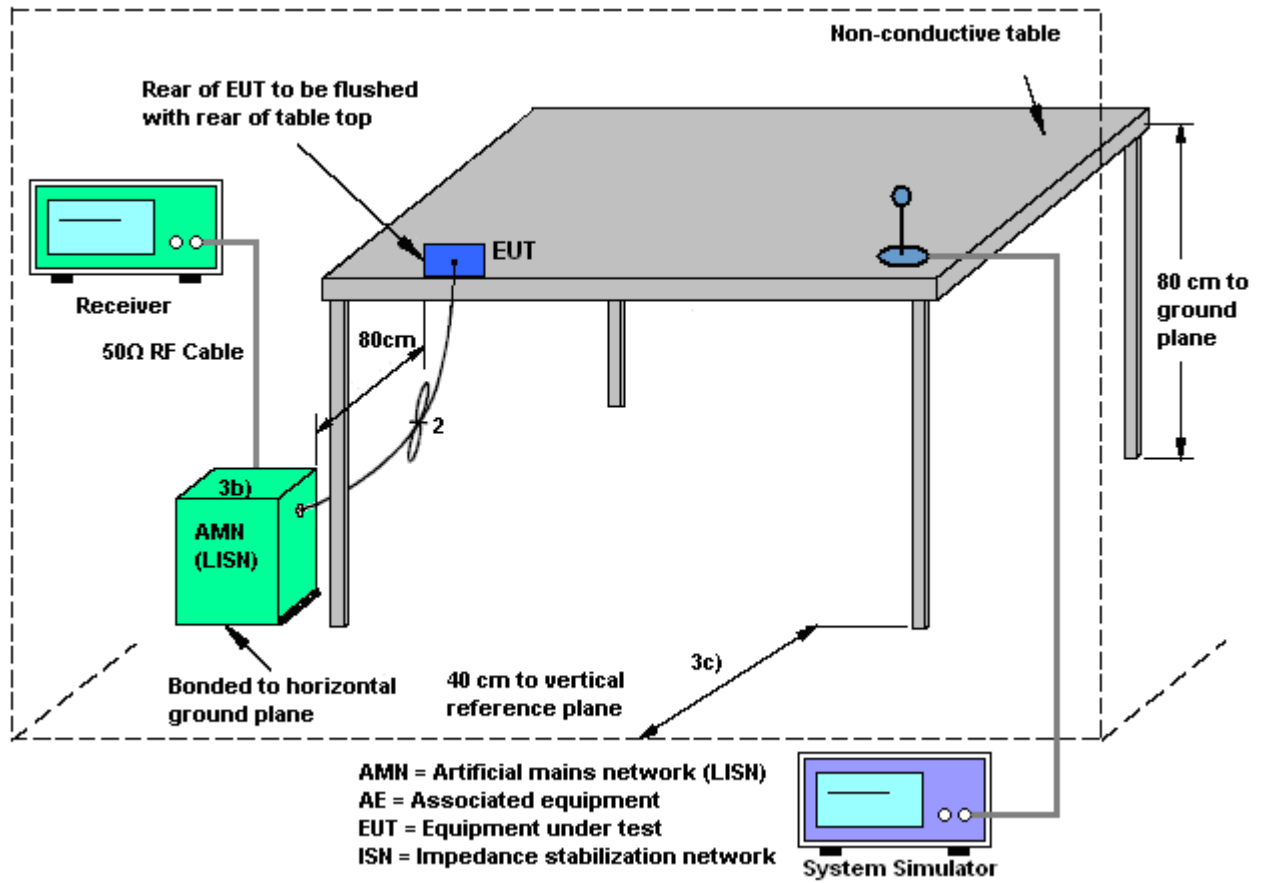

### 3.6.5 Test Result of AC Conducted Emission

Test Mode :	Mode 1	Temperature :	20~22°C
Test Engineer :	Kyle Jhuang	Relative Humidity :	46~47%
Test Voltage :	120Vac / 60Hz	Phase :	Line
Function Type :	Bluetooth Link + USB Cable (Connect with Notebook)		
Remark :	All emissions not reported here are more than 10 dB below the prescribed limit.		

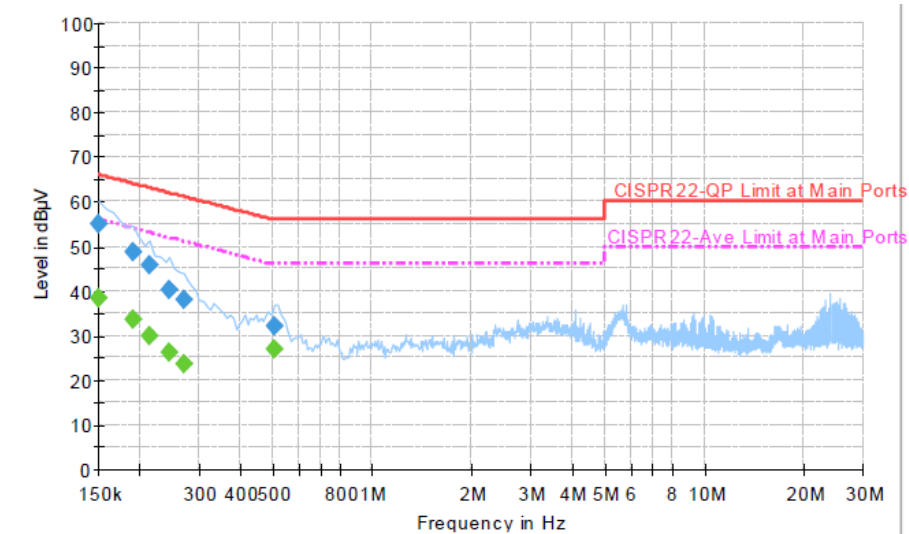

#### Final Result : Quasi-Peak

Frequency (MHz)	Quasi-Peak (dBµV)	Filter	Line	Corr. (dB)	Margin (dB)	Limit (dBµV)
0.150000	55.1	Off	L1	19.4	10.9	66.0
0.190000	48.8	Off	L1	19.4	15.2	64.0
0.214000	45.8	Off	L1	19.4	17.2	63.0
0.246000	40.0	Off	L1	19.4	21.9	61.9
0.270000	38.0	Off	L1	19.3	23.1	61.1
0.510000	32.1	Off	L1	19.4	23.9	56.0

#### Final Result : Average

Frequency (MHz)	Average (dBµV)	Filter	Line	Corr. (dB)	Margin (dB)	Limit (dBµV)
0.150000	38.4	Off	L1	19.4	17.6	56.0
0.190000	33.4	Off	L1	19.4	20.6	54.0
0.214000	29.7	Off	L1	19.4	23.3	53.0
0.246000	26.3	Off	L1	19.4	25.6	51.9
0.270000	23.6	Off	L1	19.3	27.5	51.1
0.510000	26.8	Off	L1	19.4	19.2	46.0

Test Mode :	Mode 1	Temperature :	20~22°C
Test Engineer :	Kyle Jhuang	Relative Humidity :	46~47%
Test Voltage :	120Vac / 60Hz	Phase :	Neutral
Function Type :	Bluetooth Link + USB Cable (Connect with Notebook)		
Remark :	All emissions not reported here are more than 10 dB below the prescribed limit.		

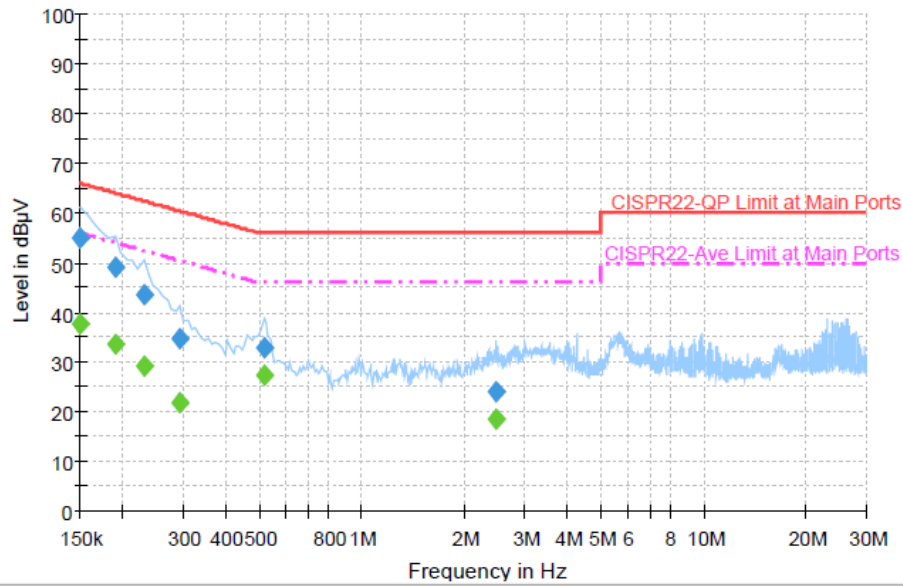

**Final Result : Quasi-Peak**

Frequency (MHz)	Quasi-Peak (dBµV)	Filter	Line	Corr. (dB)	Margin (dB)	Limit (dBµV)
0.150000	55.0	Off	N	19.4	11.0	66.0
0.190000	49.0	Off	N	19.4	15.0	64.0
0.230000	43.7	Off	N	19.4	18.7	62.4
0.294000	34.8	Off	N	19.4	25.6	60.4
0.518000	32.7	Off	N	19.4	23.3	56.0
2.478000	24.1	Off	N	19.6	31.9	56.0

**Final Result : Average**

Frequency (MHz)	Average (dBµV)	Filter	Line	Corr. (dB)	Margin (dB)	Limit (dBµV)
0.150000	37.7	Off	N	19.4	18.3	56.0
0.190000	33.7	Off	N	19.4	20.3	54.0
0.230000	29.3	Off	N	19.4	23.1	52.4
0.294000	21.7	Off	N	19.4	28.7	50.4
0.518000	27.5	Off	N	19.4	18.5	46.0
2.478000	18.4	Off	N	19.6	27.6	46.0



## **3.7 Antenna Requirements**

### **3.7.1 Standard Applicable**

If directional gain of transmitting antennas is greater than 6dBi, the power shall be reduced by the same level in dB comparing to gain minus 6dBi. The use of a permanently attached antenna or of an antenna that uses a unique coupling to the intentional radiator shall be considered sufficient to comply with the FCC rule.

### **3.7.2 Antenna Connected Construction**

Non-standard connector used.

### **3.7.3 Antenna Gain**

The antenna peak gain of EUT is less than 6 dBi. Therefore, it is not necessary to reduce maximum peak output power limit.



## 4 List of Measuring Equipment

Instrument	Manufacturer	Model No.	Serial No.	Characteristics	Calibration Date	Test Date	Due Date	Remark
Spectrum Analyzer	Rohde & Schwarz	FSP40	100055	9kHz~40GHz	Jun. 07, 2013	Jun. 11, 2013	Jun. 06, 2014	Conducted (TH02-HY)
Power Meter	Agilent	E4416A	GB412923 44	300MHz~40GHz	Feb. 05, 2013	Jun. 11, 2013	Feb. 04, 2014	Conducted (TH02-HY)
Power Sensor	Agilent	E9327A	US404415 48	300MHz~40GHz	Feb. 05, 2013	Jun. 11, 2013	Feb. 04, 2014	Conducted (TH02-HY)
Spectrum Analyzer	R&S	FSP30	101352	9kHz~30GHz	Nov. 07, 2012	Jun. 12, 2013	Nov. 06, 2013	Radiation (03CH06-HY)
Spectrum Analyzer	Agilent	E4408B	MY442110 30	9kHz ~ 26.5GHz	Nov. 26, 2012	Jun. 12, 2013	Nov. 25, 2013	Radiation (03CH06-HY)
EMI Test Receiver	R&S	ESVS10	834468/00 03	20MHz ~ 1000MHz	May 06, 2013	Jun. 12, 2013	May 05, 2014	Radiation (03CH06-HY)
Bilog Antenna	SCHAFFNER	CBL6112B	2885	30MHz ~ 2GHz	Oct. 06, 2012	Jun. 12, 2013	Oct. 05, 2013	Radiation (03CH06-HY)
Double Ridge Horn Antenna	EMCO	3117	00066583	1GHz ~ 18GHz	Aug. 01, 2012	Jun. 12, 2013	Jul. 31, 2013	Radiation (03CH06-HY)
SHF-EHF Horn Antenna	SCHWARZBE CK	BBHA 9170	BBHA9170 251	15GHz ~ 40GHz	Sep. 28, 2012	Jun. 12, 2013	Sep. 27, 2013	Radiation (03CH06-HY)
Amplifier	Agilent	310N	186713	9kHz ~ 1GHz	Apr. 12, 2013	Jun. 12, 2013	Apr. 11, 2014	Radiation (03CH06-HY)
Pre Amplifier	EMCI	EMC051845	SN980048	1GHz ~ 18GHz	Jul. 21, 2012	Jun. 12, 2013	Jul. 20, 2013	Radiation (03CH06-HY)
Preamplifier	Agilent	8449B	3008A019 17	1GHz ~ 26.5GHz	Apr. 12, 2013	Jun. 12, 2013	Apr. 11, 2014	Radiation (03CH06-HY)
Loop Antenna	R&S	HFH2-Z2	860004/00 1	9kHz ~ 30MHz	Jul. 03, 2012	Jun. 12, 2013	Jul. 02, 2013	Radiation (03CH06-HY)
Turn Table	INN-CO	DS2000	420/650/00	0 - 360 degree	N/A	Jun. 12, 2013	N/A	Radiation (03CH06-HY)
Antenna Mast	MF	MF-7802	MF780208 212	1 m ~ 4 m	N/A	Jun. 12, 2013	N/A	Radiation (03CH06-HY)
EMI Test Receiver	Rohde & Schwarz	ESCS 30	100356	9kHz ~ 2.75GHz	Nov. 13, 2012	Jun. 13, 2013	Nov. 12, 2013	Conduction (CO05-HY)
Two-LISN (for auxiliary equipment)	Rohde & Schwarz	ENV216	100081	9kHz ~ 30MHz	Dec. 12, 2012	Jun. 13, 2013	Dec. 11, 2013	Conduction (CO05-HY)
Two-LISN	Rohde & Schwarz	ENV216	100080	9kHz ~ 30MHz	Dec. 06, 2012	Jun. 13, 2013	Dec. 05, 2013	Conduction (CO05-HY)
AC Power Source	APC	APC-1000W	N/A	N/A	N/A	Jun. 13, 2013	N/A	Conduction (CO05-HY)



## 5 Uncertainty of Evaluation

### Uncertainty of Conducted Emission Measurement (150 kHz ~ 30 MHz)

Measuring Uncertainty for a Level of Confidence of 95% ( $U = 2Uc(y)$ )	2.26
---	------

### Uncertainty of Radiated Emission Measurement (30 MHz ~ 1000 MHz)

Measuring Uncertainty for a Level of Confidence of 95% ( $U = 2Uc(y)$ )	2.54
---	------

### Uncertainty of Radiated Emission Measurement (1 GHz ~ 40 GHz)

Measuring Uncertainty for a Level of Confidence of 95% ( $U = 2Uc(y)$ )	4.72
---	------





## **Appendix A. Photographs of EUT**

Please refer to Sporton report number EP360543 as below.;