

CMD\_R\_A

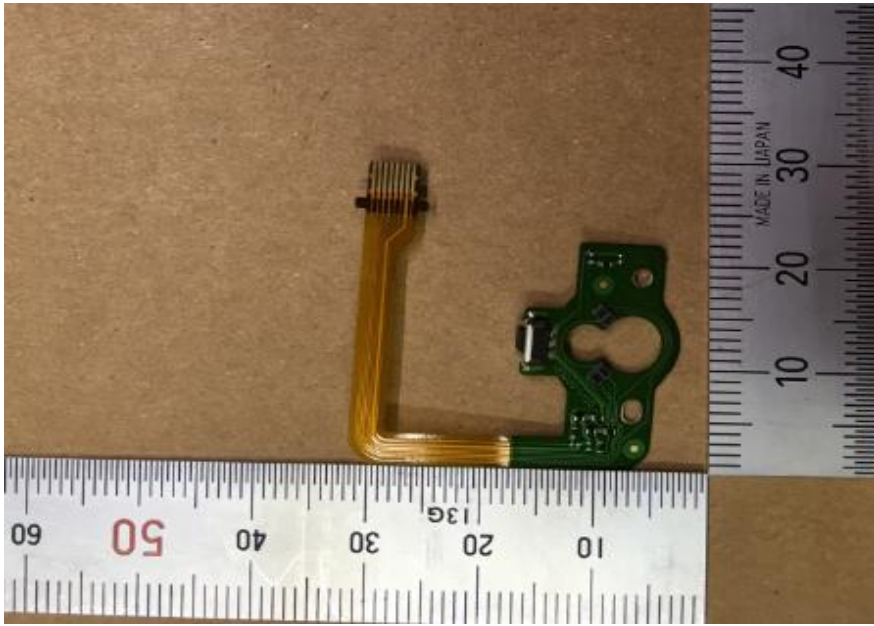

CMD\_R\_B



FPC\_AF\_A

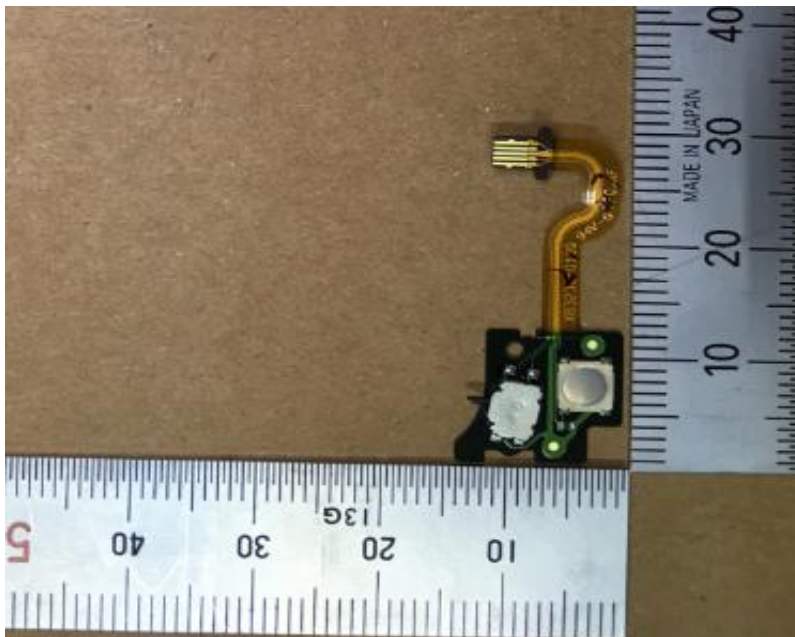

FPC\_AF\_B

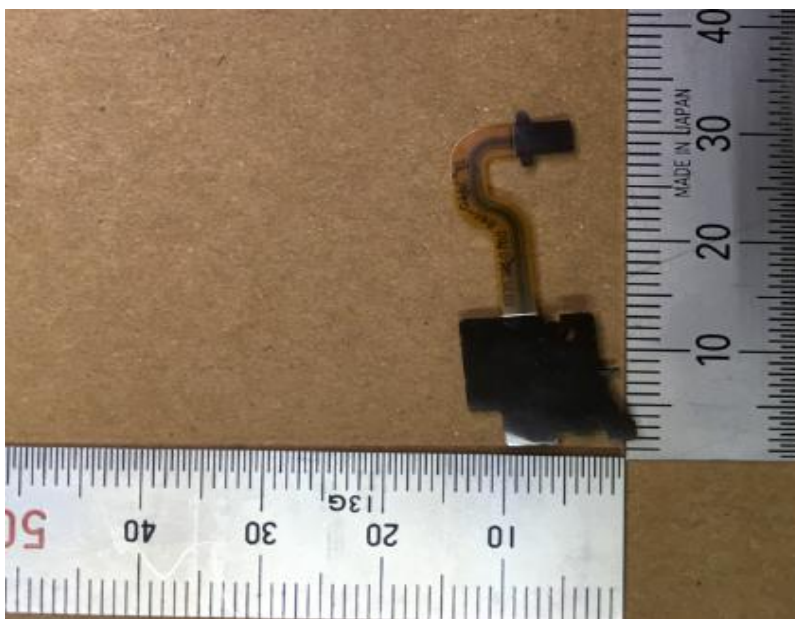

FPC\_JOINT\_LCD\_A

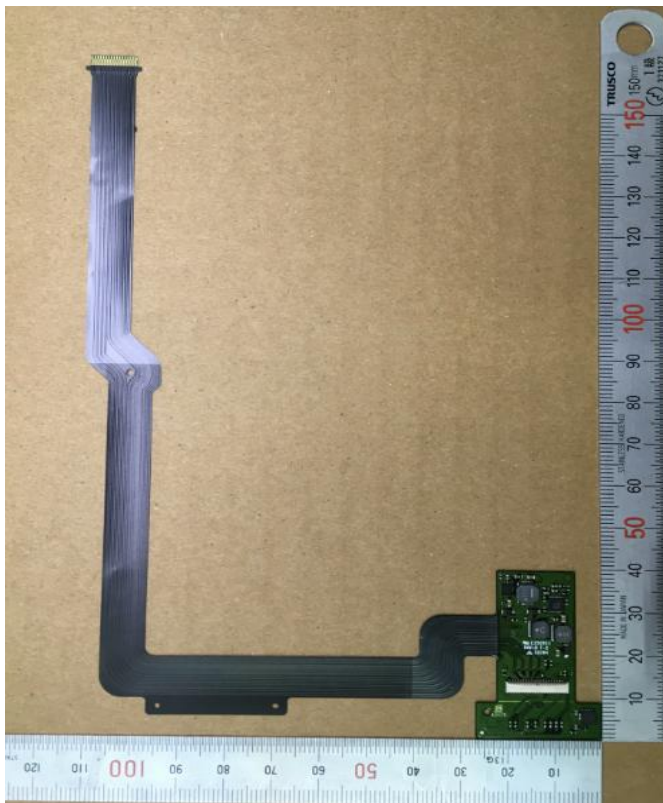

FPC\_JOINT\_LCD\_B

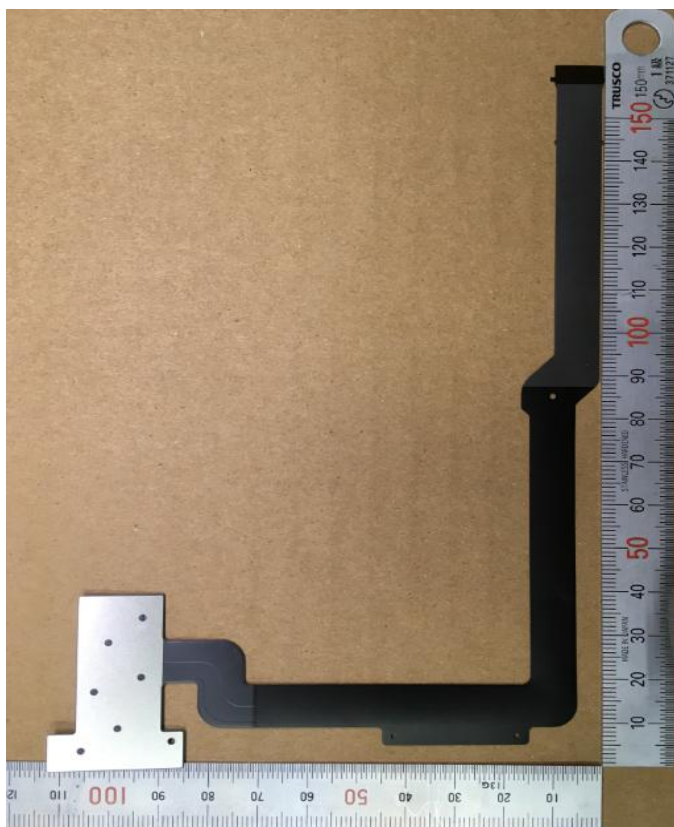

FPC\_PW\_A

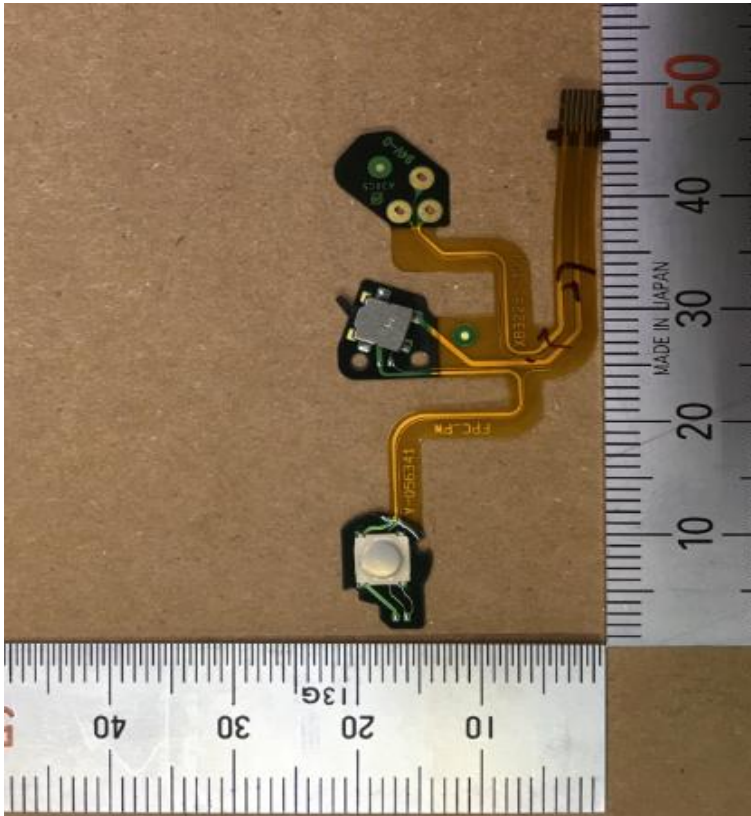

FPC\_PW\_B

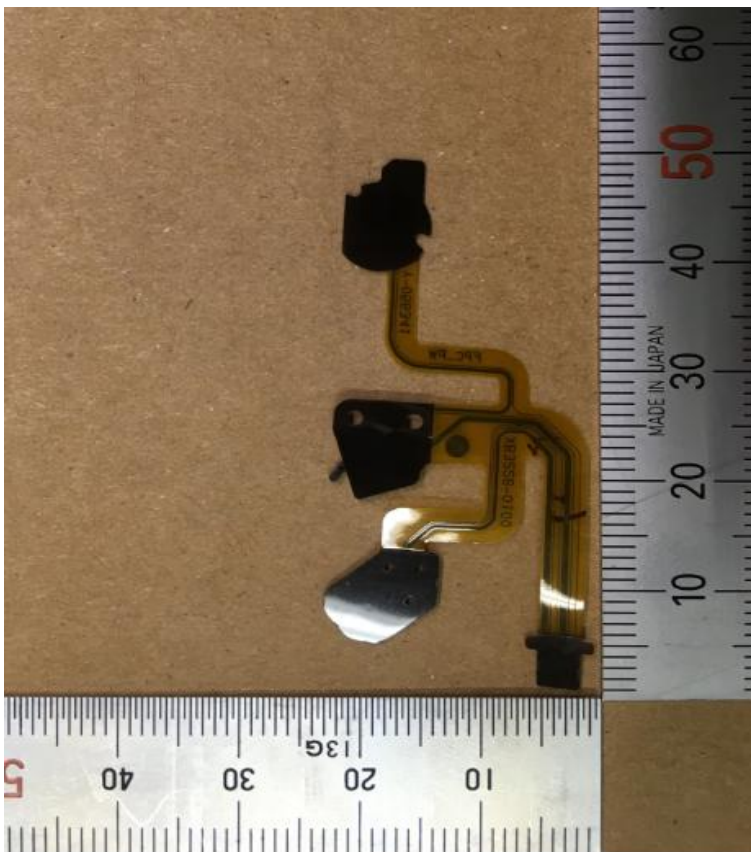

FPC\_Q\_A

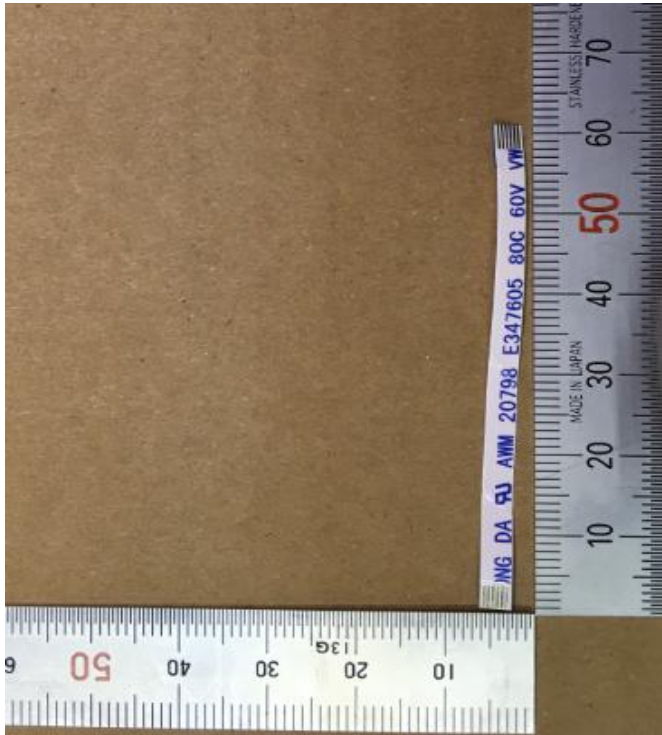

FPC\_Q\_B



FPC\_REAR\_A



FPC\_REAR\_B

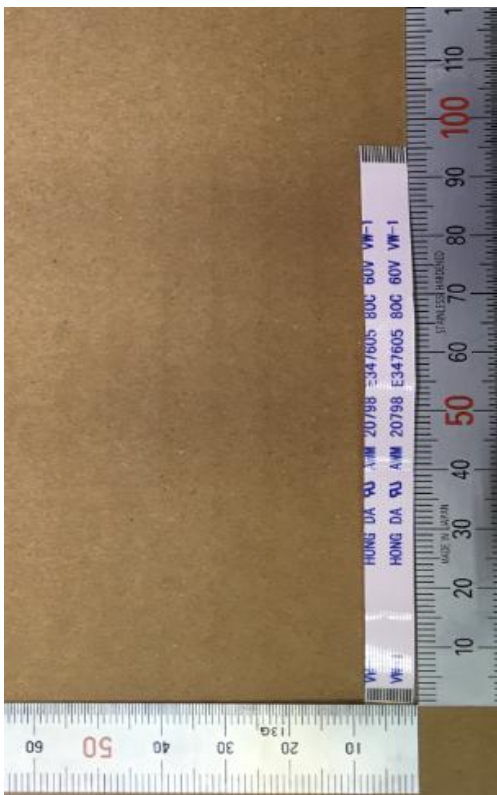

FPC\_TOP\_C\_A

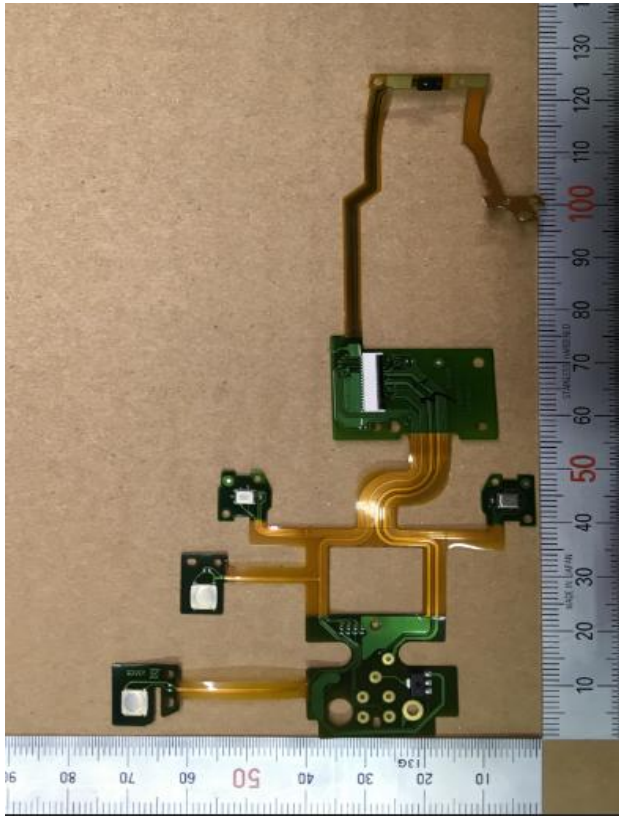

FPC\_TOP\_C\_B

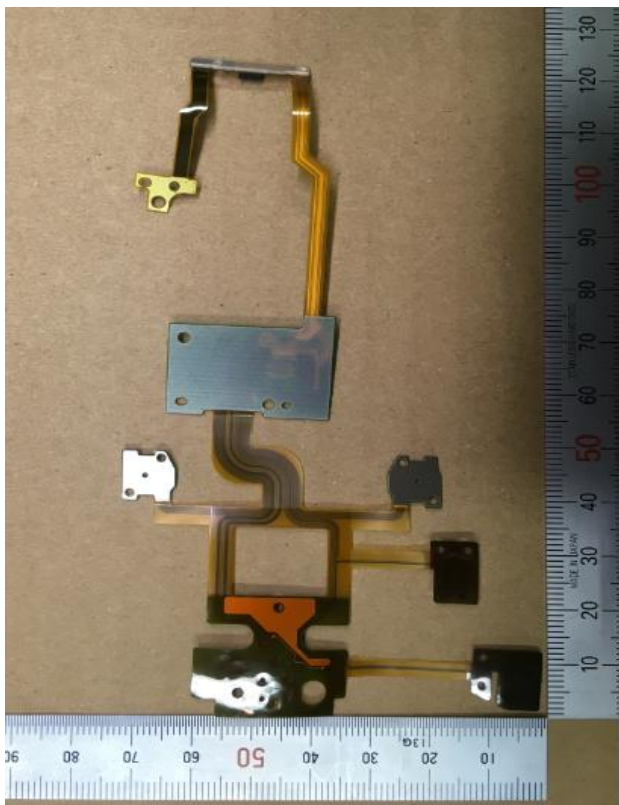

FPC\_TOP\_R\_A

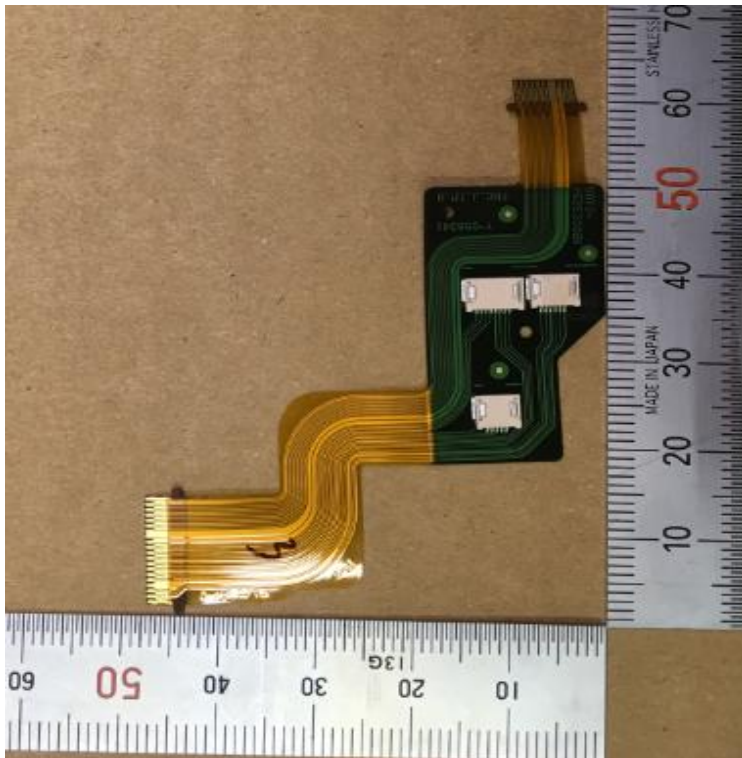

FPC\_TOP\_R\_B

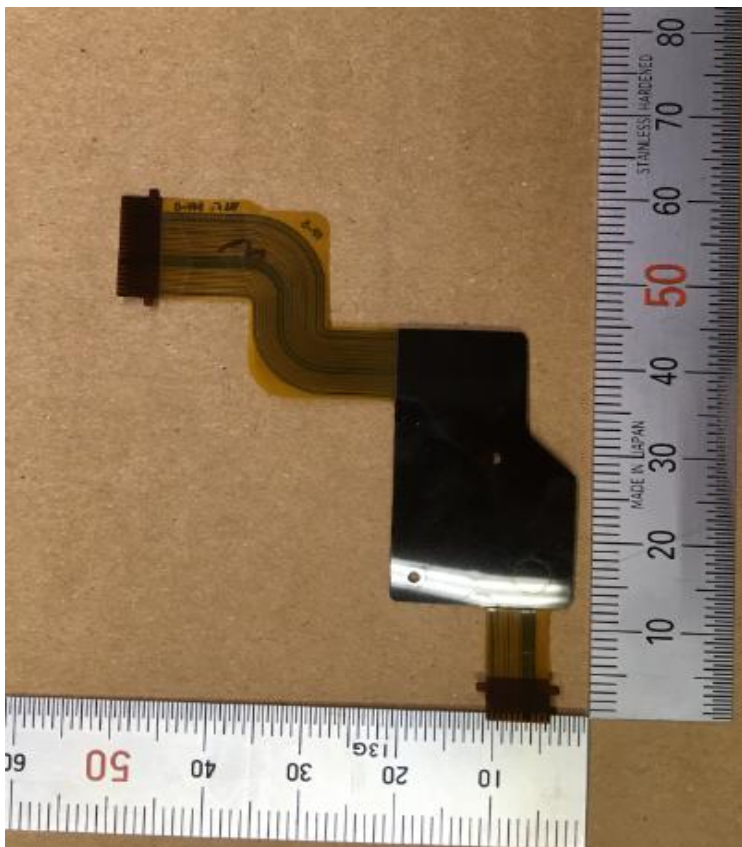



KNDB\_JOG\_A

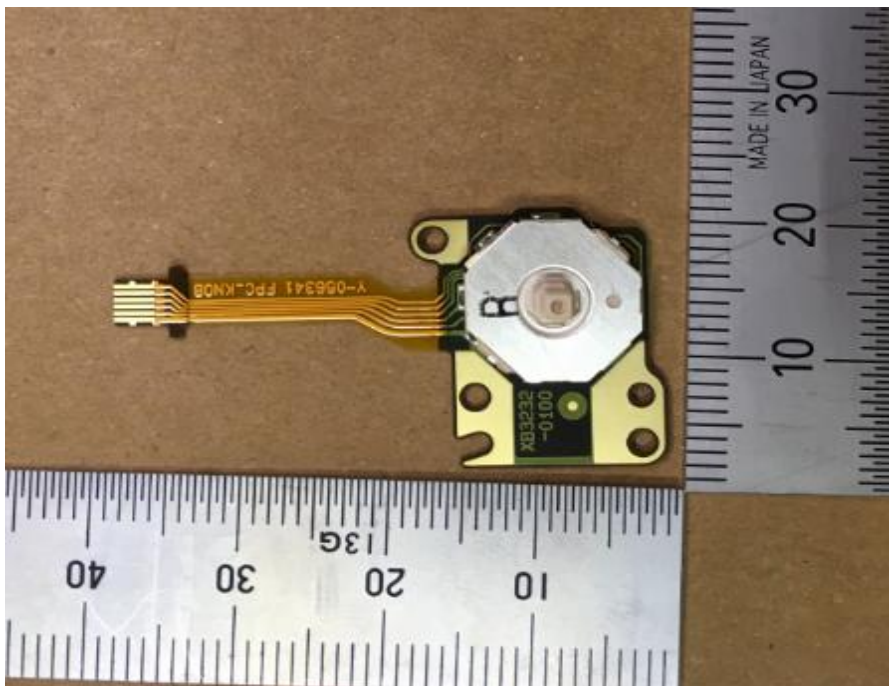

KNDB\_JOG\_B



TOP\_LA

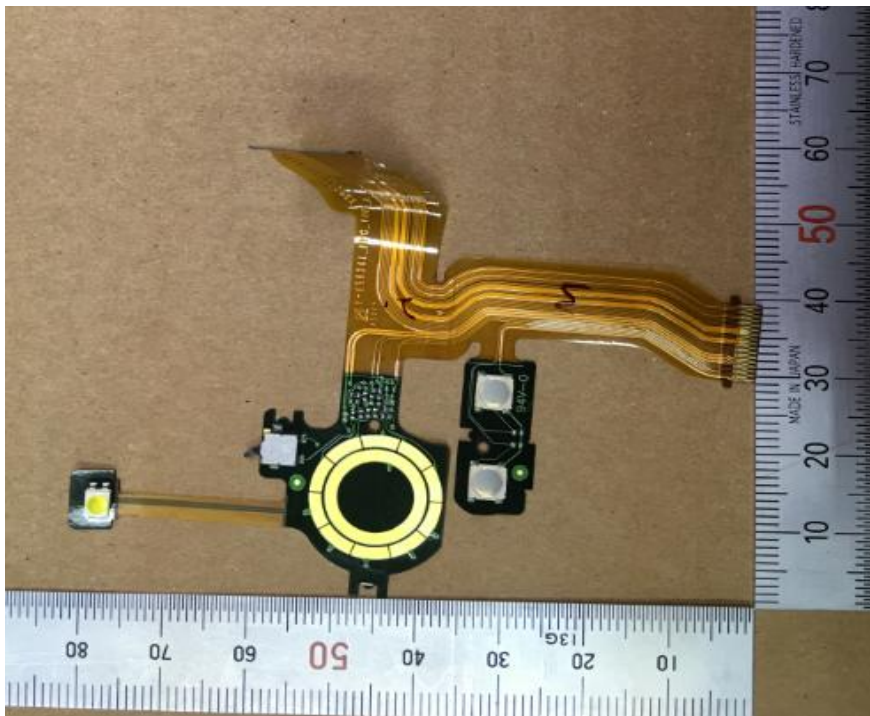

TOP\_LB

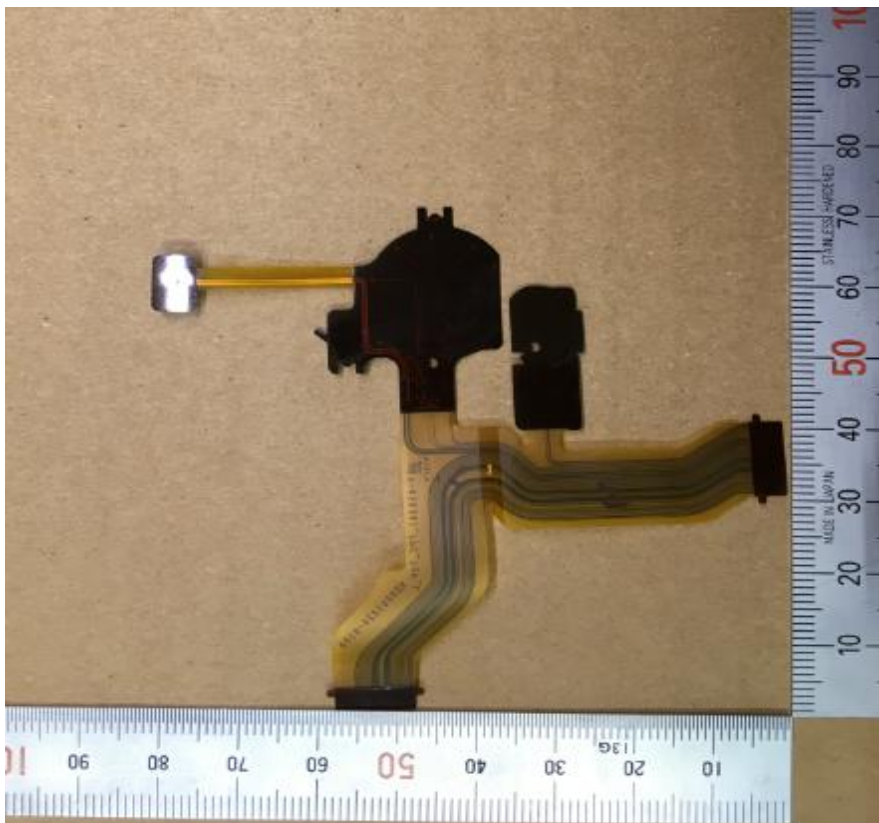

EVF\_A

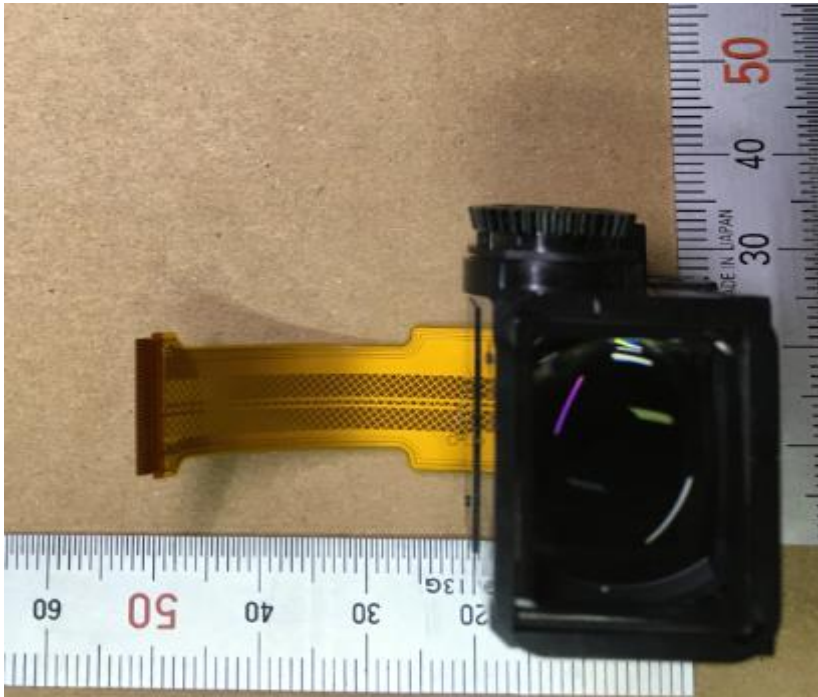

EVF\_B

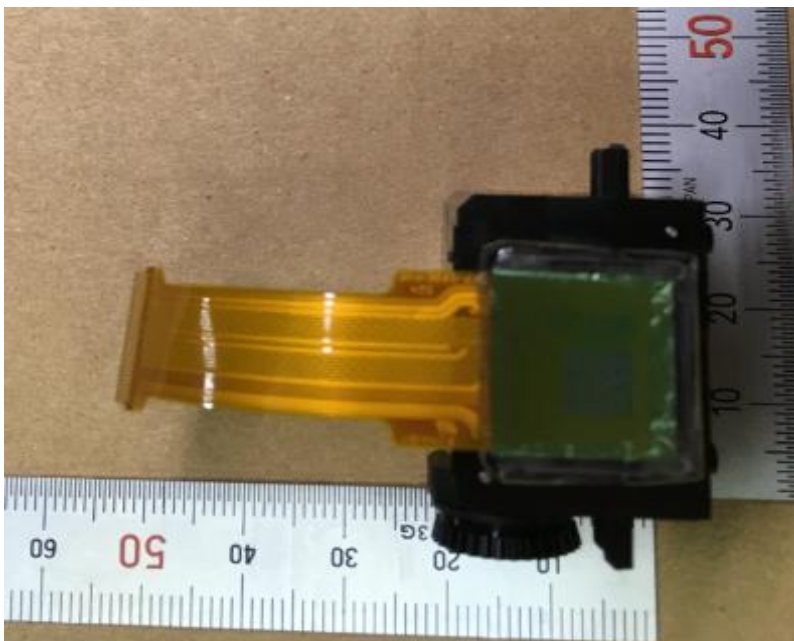

LCD\_A



LCD\_B

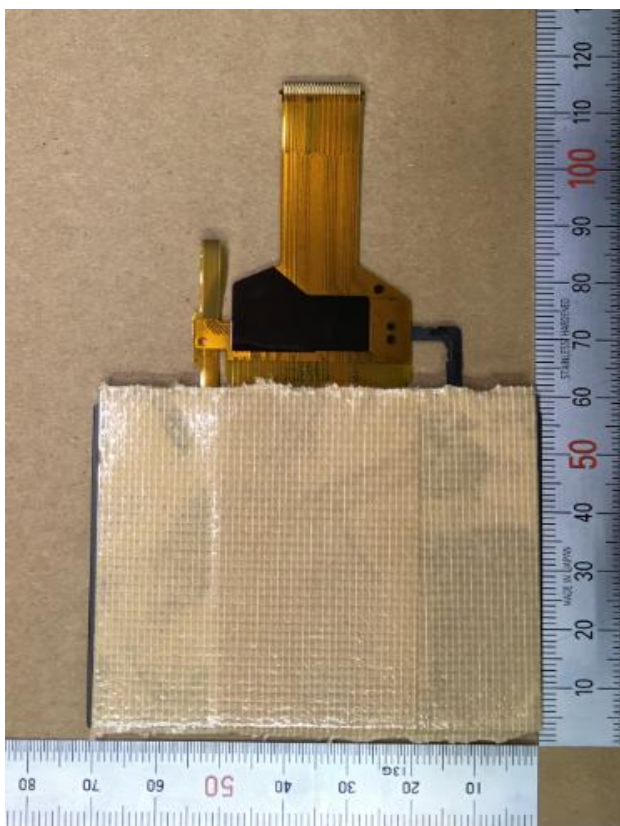

MIC\_PWB\_A

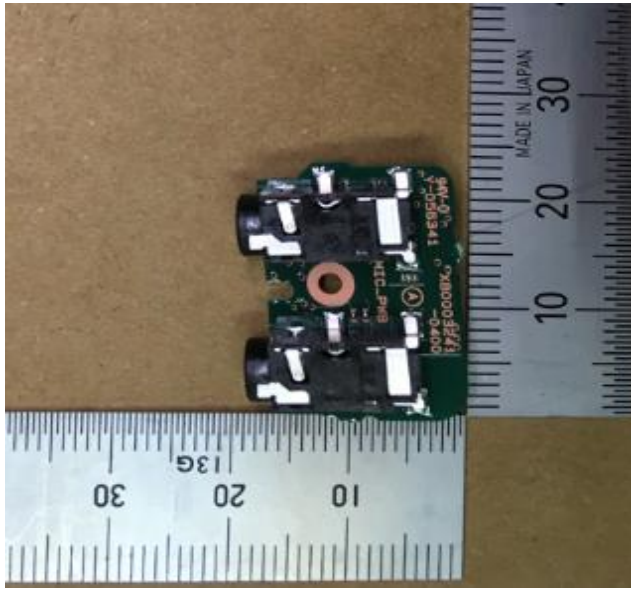

MIC\_PWB\_B

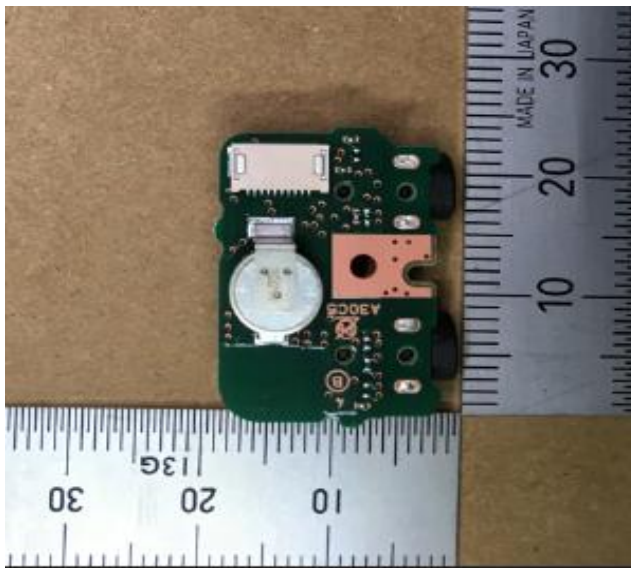

PWB\_REAR\_A

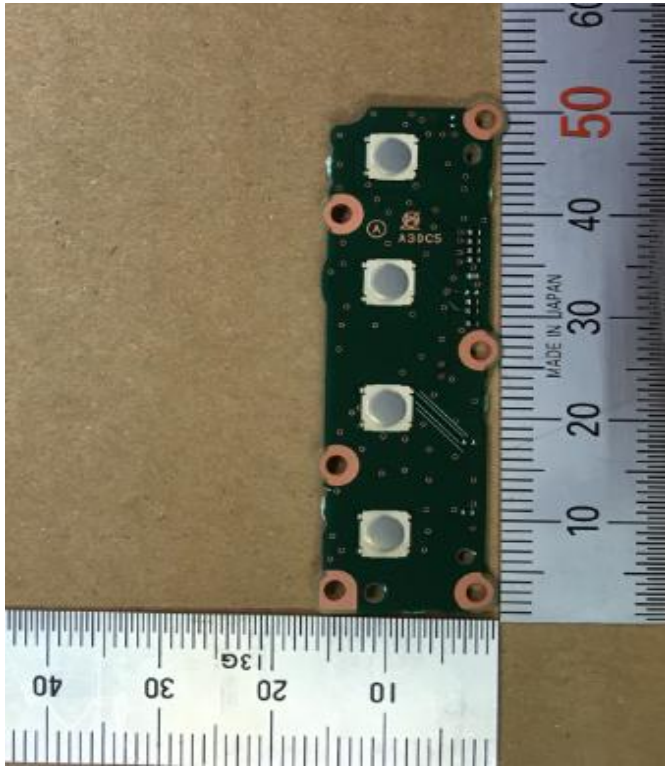

PWB\_REAR\_B

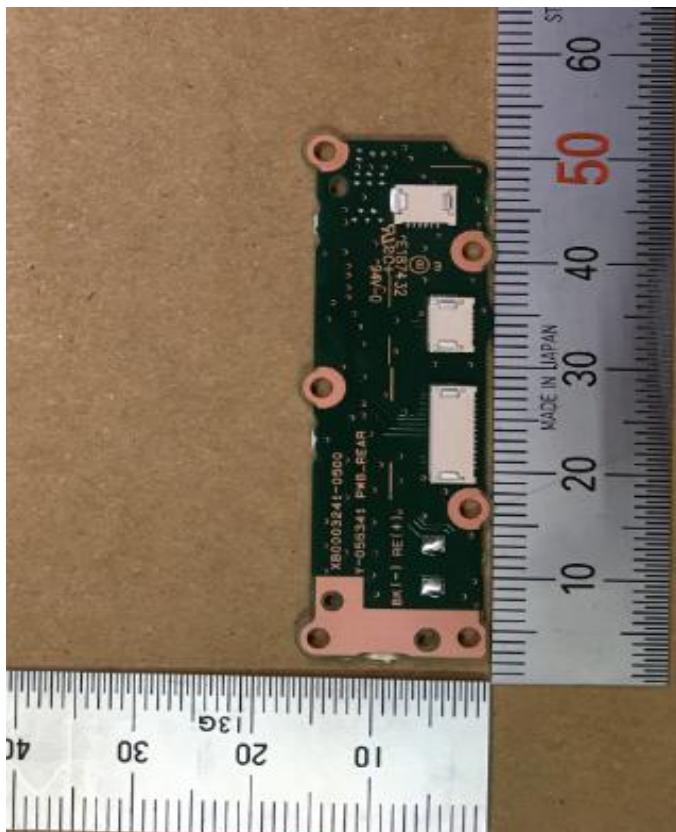

PWB\_SD\_A

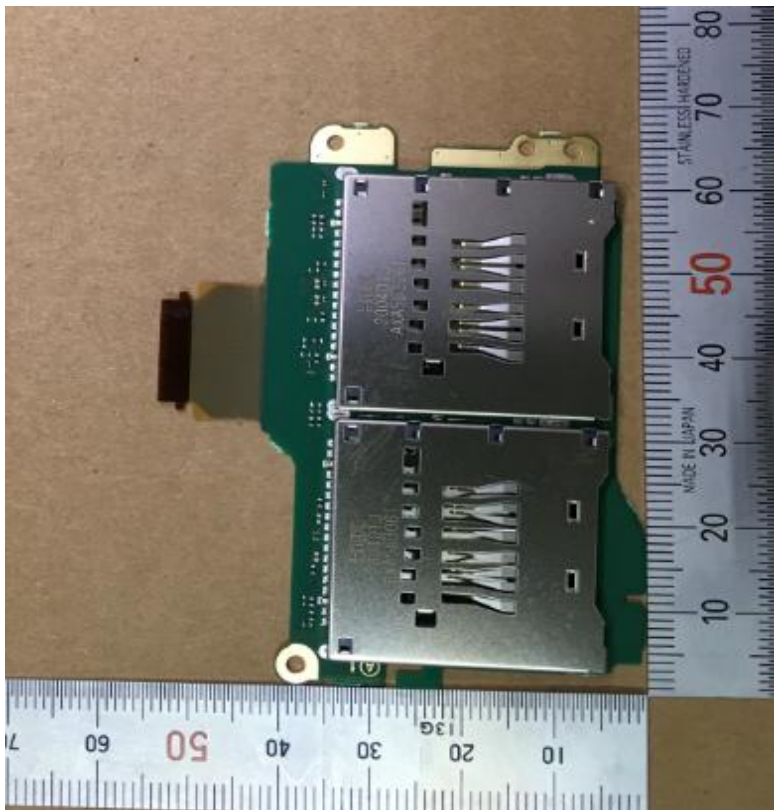

PWB\_SD\_B

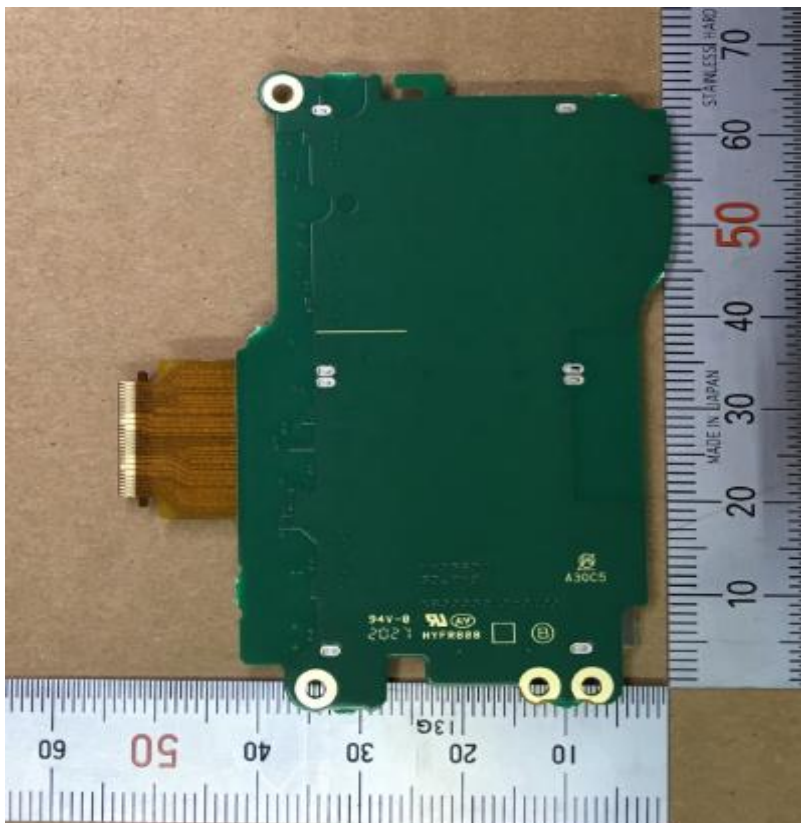

RR\_JACK\_A

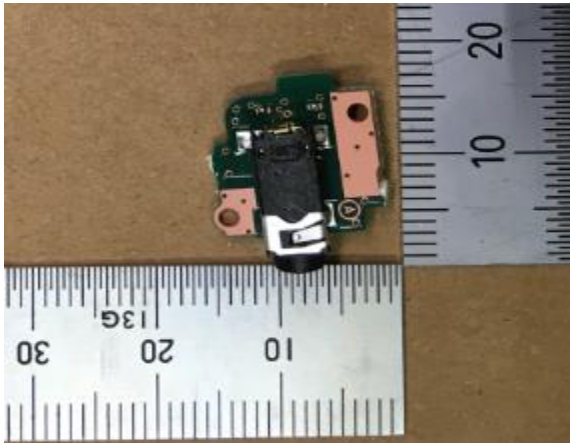

RR\_JACK\_B

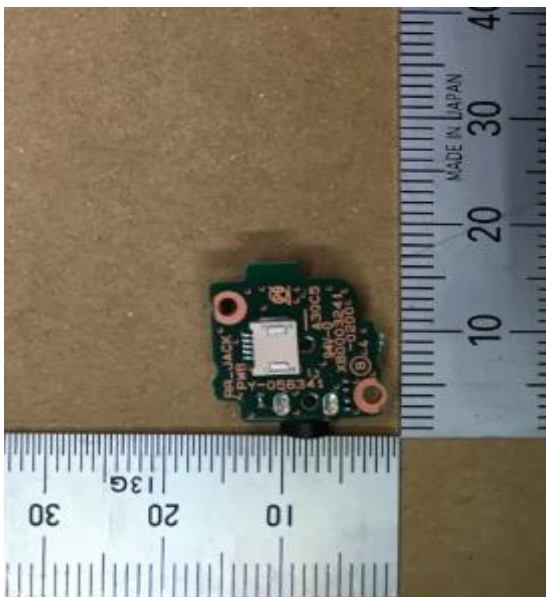



TOP\_BTN\_PWB\_A

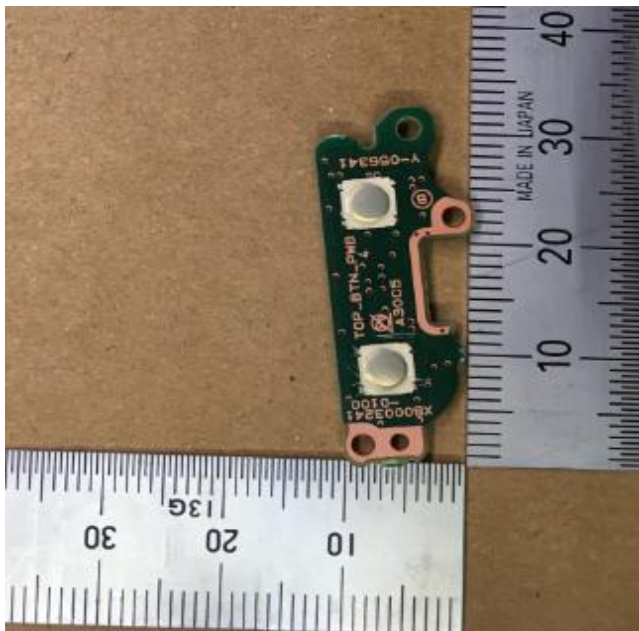

TOP\_BTN\_PWB\_B

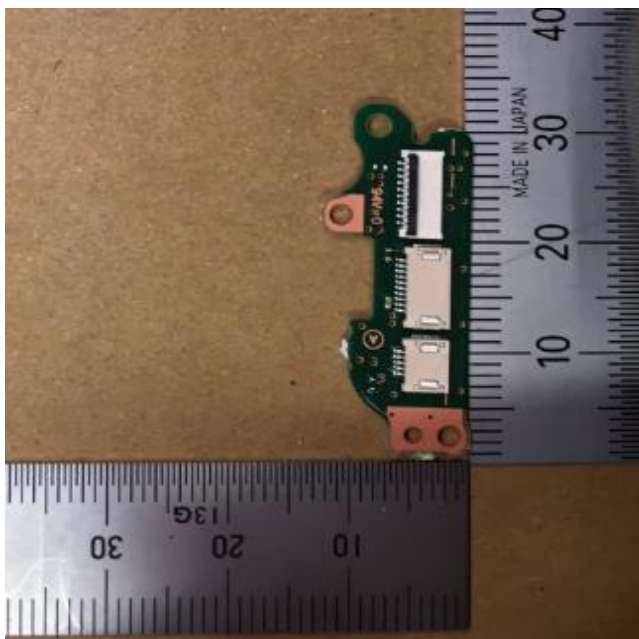

天面LCD\_A

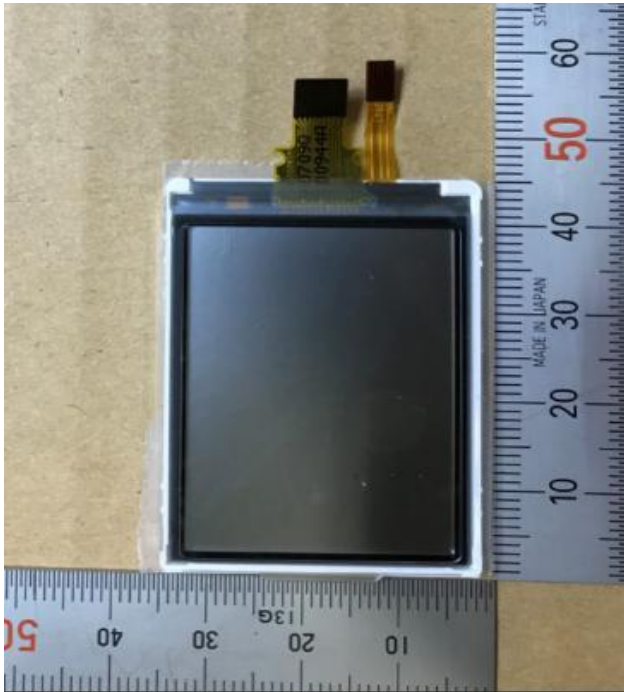

天面LCD\_B

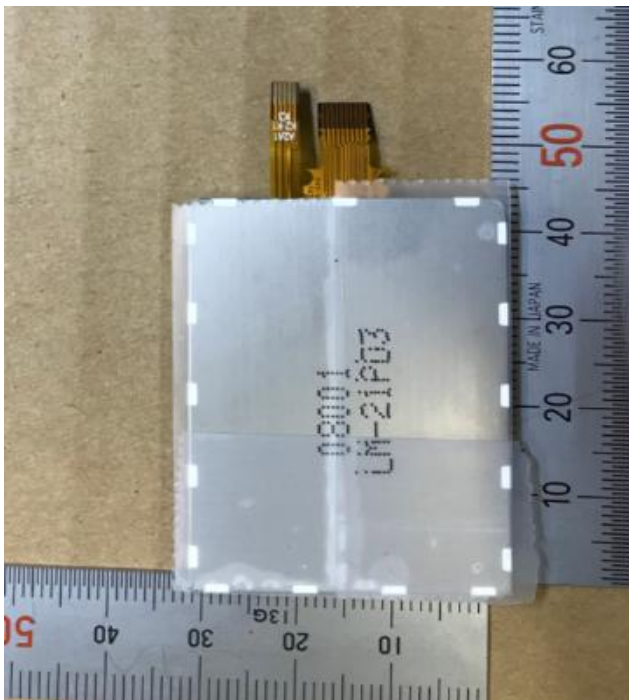

WLAN\_A

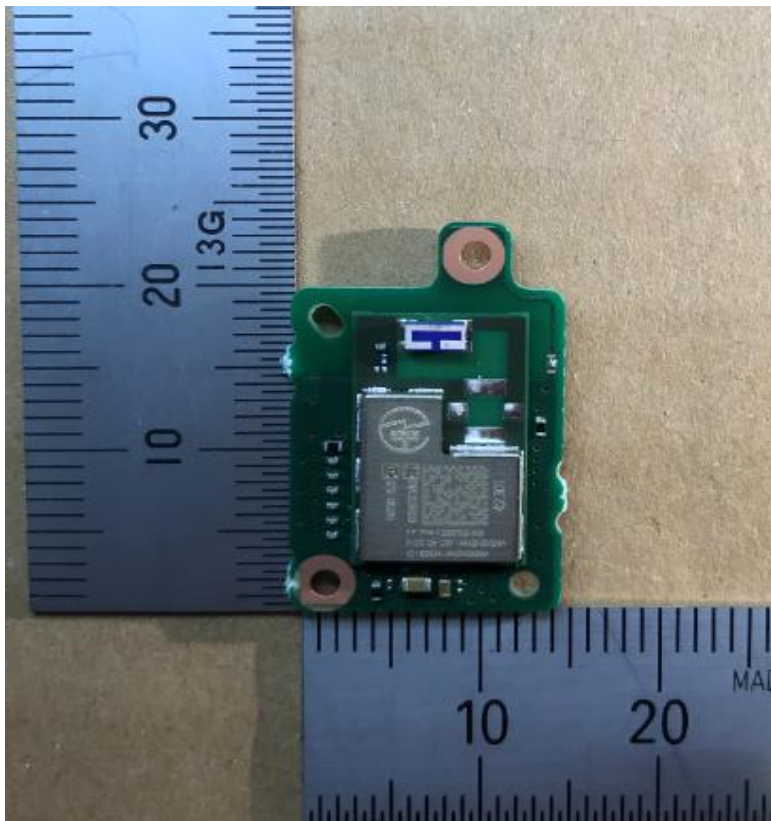

WLAN\_B

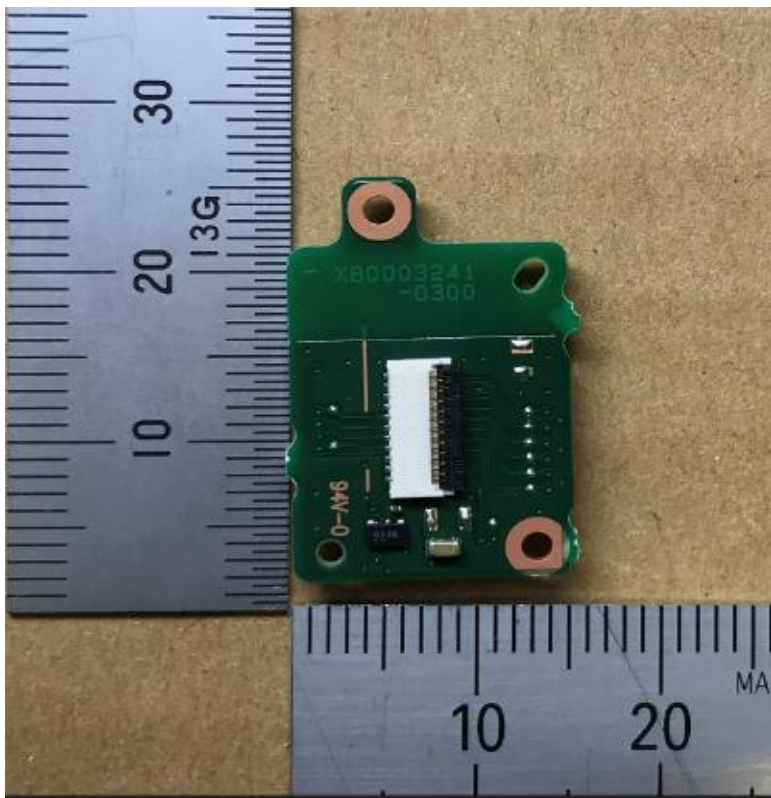

MAIN\_A



MAIN\_B

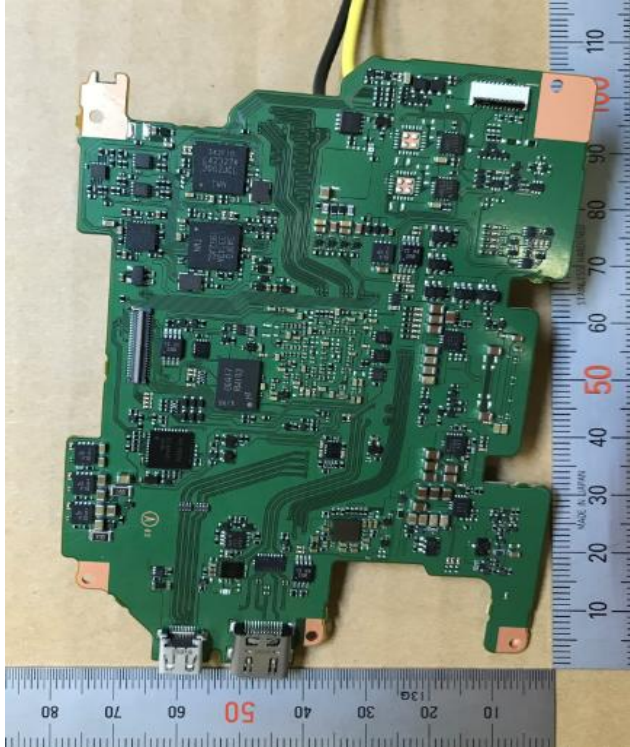

CMOS\_A

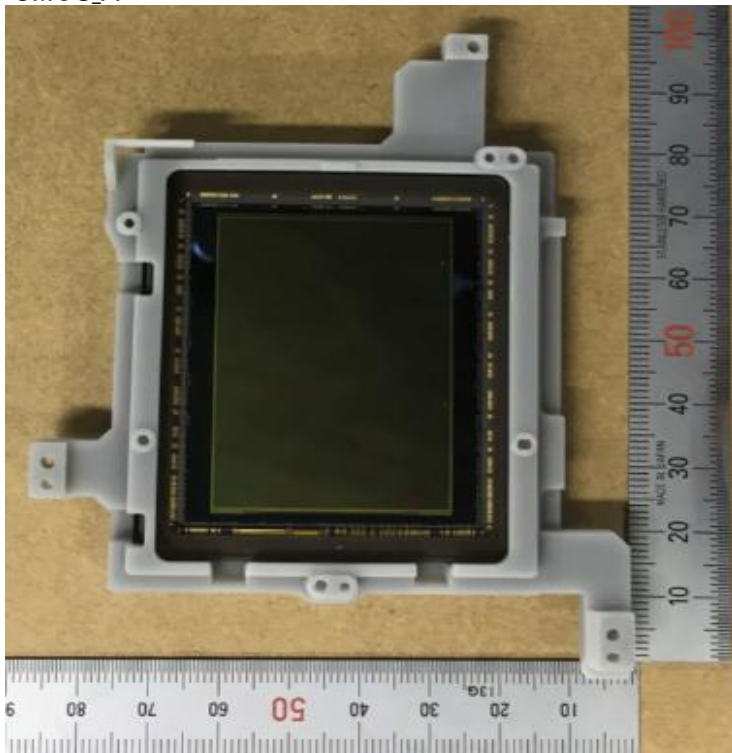

CMOS\_B

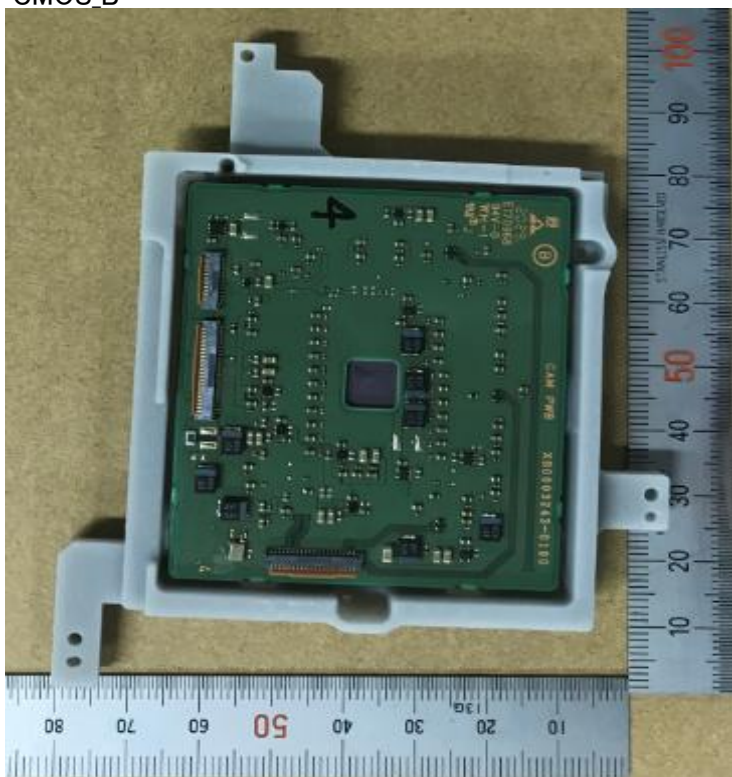

FPC\_CAM\_PW\_A



FPC\_CAM\_PW\_B



