

FCC Test Report

FCC ID : COF-WMBANMT41
Equipment : 802.11 a/b/g/n + BT 4.2 module
Brand Name : USI
Model Name : WM-BAN-MT-41
Applicant : Universal Global Scientific Industrial Co., Ltd
141, Lane 351, Sec. 1, Taiping Road., Tsaotuen,
Nantou 54261, Taiwan
Manufacturer : Universal Global Scientific Industrial Co., Ltd
141, Lane 351, Sec. 1, Taiping Road., Tsaotuen,
Nantou 54261, Taiwan
Standard : 47 CFR FCC Part 15.247

The product was received on May 20, 2019, and testing was started from May 22, 2019 and completed on May 31, 2019. We, SPORTON INTERNATIONAL INC. EMC & Wireless Communications Laboratory, would like to declare that the tested sample has been evaluated in accordance with the procedures given in ANSI C63.10-2013 and shown compliance with the applicable technical standards.

The report must not be used by the client to claim product certification, approval, or endorsement by TAF or any agency of government.

The test results in this report apply exclusively to the tested model / sample. Without written approval of SPORTON INTERNATIONAL INC. EMC & Wireless Communications Laboratory, the test report shall not be reproduced except in full.



Approved by: Allen Lin

SPORTON INTERNATIONAL INC. EMC & Wireless Communications Laboratory

No. 52, Huaya 1st Rd., Guishan Dist., Taoyuan City, Taiwan (R.O.C.)



Table of Contents

HISTORY OF THIS TEST REPORT3

SUMMARY OF TEST RESULT4

1 GENERAL DESCRIPTION5

1.1 Information.....5

1.2 Testing Applied Standards7

1.3 Testing Location Information7

1.4 Measurement Uncertainty7

2 TEST CONFIGURATION OF EUT.....8

2.1 Test Condition8

2.2 Test Channel Mode8

2.3 The Worst Case Measurement Configuration.....9

2.4 Support Equipment.....10

2.5 Test Setup Diagram11

3 TRANSMITTER TEST RESULT13

3.1 AC Power-line Conducted Emissions13

3.2 DTS Bandwidth.....14

3.3 Maximum Conducted Output Power15

3.4 Power Spectral Density17

3.5 Emissions in Non-restricted Frequency Bands18

3.6 Emissions in Restricted Frequency Bands.....19

4 TEST EQUIPMENT AND CALIBRATION DATA.....22

APPENDIX A. TEST RESULTS OF AC POWER-LINE CONDUCTED EMISSIONS

APPENDIX B. TEST RESULTS OF DTS BANDWIDTH

APPENDIX C. TEST RESULTS OF MAXIMUM CONDUCTED OUTPUT POWER

APPENDIX D. TEST RESULTS OF POWER SPECTRAL DENSITY

APPENDIX E. TEST RESULTS OF EMISSIONS IN NON-RESTRICTED FREQUENCY BANDS

APPENDIX F. TEST RESULTS OF EMISSIONS IN RESTRICTED FREQUENCY BANDS

APPENDIX G. TEST RESULTS OF RADIATED EMISSION CO-LOCATION

APPENDIX H. TEST PHOTOS

PHOTOGRAPHS OF EUT V01



History of this test report

Report No.	Version	Description	Issued Date
FR952001AL	01	Initial issue of report	Jun. 24, 2019
FR952001AL	02	Modified 1 1.1 RF General Information This report is the latest version replacing for the report issued on Jun. 24, 2019.	Jul. 05, 2019



Summary of Test Result

Report Clause	Ref. Std. Clause	Test Items	Result (PASS/FAIL)	Remark
1.1.2	15.203	Antenna Requirement	PASS	FCC 15.203
3.1	15.207	AC Power-line Conducted Emissions	PASS	FCC 15.207
3.2	15.247(a)	DTS Bandwidth	PASS	≥500kHz
3.3	15.247(b)	Maximum Conducted Output Power	PASS	Power [dBm]:30
3.4	15.247(e)	Power Spectral Density	PASS	PSD [dBm/3kHz]:8
3.5	15.247(d)	Emissions in Non-restricted Frequency Bands	PASS	Non-Restricted Bands: >30 dBc
3.6	15.247(d)	Emissions in Restricted Frequency Bands	PASS	Restricted Bands: FCC 15.209

Declaration of Conformity:
The test results with all measurement uncertainty excluded are presented in accordance with the regulation limits or requirements declared by manufacturers.
Comments and explanations:
None

Reviewed by: Sam Tsai

Report Producer: Amber Chiu

1 General Description

1.1 Information

1.1.1 RF General Information

Frequency Range (MHz)	Bluetooth Mode	Ch. Frequency (MHz)	Channel Number
2400-2483.5	LE	2402-2480	0-39 [40]
Note: ♦ Bluetooth LE uses a GFSK modulation for DSSS. ♦ BWch is the nominal channel bandwidth.			
Data Rate (MHz)	BT-LE mode : 1Mbps / 2Mbps		

Band	Mode	BWch (MHz)	Nant
2.4-2.4835GHz	BT-LE(1Mbps)	1.0	1TX
2.4-2.4835GHz	BT-LE(2Mbps)	2.0	1TX

1.1.2 Antenna Information

Ant.	Brand	Model Name	Antenna Type	Connector
1	-	-	Printed antenna	Murata

Ant.	Port	Gain (dBi)		
		2.4G	5G	BT
1	1	0	3	0

For 2.4GHz function:

For IEEE 802.11 b/g/n mode (1TX/1RX)

Ant. 1 could transmit/receive simultaneously.

For BT function:

For IEEE 802.15.1 Bluetooth mode (1TX/1RX)

Ant. 1 could transmit/receive simultaneously.

For 5GHz function:

For IEEE 802.11 a/n mode (1TX/1RX)

Ant. 1 could transmit/receive simultaneously.

1.1.3 EUT Information

Operational Condition	
EUT Power Type	From AC Adapter / DC power supply / Host System
EUT Function	<input checked="" type="checkbox"/> Point-to-multipoint <input type="checkbox"/> Point-to-point
Type of EUT	
<input checked="" type="checkbox"/>	Stand-alone
<input type="checkbox"/>	Combined (EUT where the radio part is fully integrated within another device)
	Combined Equipment - Brand Name / Model No.: ...
<input type="checkbox"/>	Plug-in radio (EUT intended for a variety of host systems)
	Host System - Brand Name / Model No.: ...
<input type="checkbox"/>	Other:

1.1.4 Mode Test Duty Cycle

Mode	DC	DCF(dB)	T(s)	VBW(Hz) ≥ 1/T
BT-LE(1Mbps)	0.608	2.16	379.688u	3k

Note. If DC < 0.98, the DCF was added while measuring Output power and PSD.

1.2 Testing Applied Standards

According to the specifications of the manufacturer, the EUT must comply with the requirements of the following standards:

- ◆ 47 CFR FCC Part 15
- ◆ ANSI C63.10-2013
- ◆ KDB 558074 D01 v05r02

1.3 Testing Location Information

Testing Location			
<input checked="" type="checkbox"/>	HWA YA	ADD : No. 52, Huaya 1st Rd., Guishan Dist., Taoyuan City, Taiwan (R.O.C.)	
		TEL : 886-3-327-3456	FAX : 886-3-327-0973
Test site Designation No. TW1190 with FCC.			
<input type="checkbox"/>	JHUBEI	ADD : No.8, Ln. 724, Bo'ai St., Zhubei City, Hsinchu County, Taiwan (R.O.C.)	
		TEL : 886-3-656-9065	FAX : 886-3-656-9085
Test site Designation No. TW0006 with FCC.			

Test Condition	Test Site No.	Test Engineer	Test Environment	Test Date
RF Conducted	TH01-HY	Tim	23-24°C / 61-64%	28/May/2019~ 31/May/2019
Radiated	03CH02-HY	Patrick	24.6-27.8°C / 52.5-56.9%	22/May/2019~ 31/May/2019
AC Conduction	CO01-HY	Edward	24.3-27.8°C / 52.4-63.1%	25/May/2019

1.4 Measurement Uncertainty

ISO/IEC 17025 requires that an estimate of the measurement uncertainties associated with the emissions test results be included in the report. The measurement uncertainties given below are based on a 95% confidence level (based on a coverage factor (k=2))

Test Items	Uncertainty	Remark
Conducted Emission (150kHz ~ 30MHz)	3.54 dB	Confidence levels of 95%
Radiated Emission (9kHz ~ 30MHz)	1.6 dB	Confidence levels of 95%
Radiated Emission (30MHz ~ 1,000MHz)	4.3 dB	Confidence levels of 95%
Radiated Emission (1GHz ~ 18GHz)	3.9 dB	Confidence levels of 95%
Radiated Emission (18GHz ~ 40GHz)	3.5 dB	Confidence levels of 95%
Conducted Emission	1.3 dB	Confidence levels of 95%
Temperature	0.7 °C	Confidence levels of 95%
Humidity	4 %	Confidence levels of 95%



2 Test Configuration of EUT

2.1 Test Condition

RF Conducted	Abbreviation	Remark
TnomVnom	Tnom	20°C
-	Vnom	5V

2.2 Test Channel Mode



Test Software Version	WCN_combo_Tool
-----------------------	----------------

Mode	PowerSetting
BT-LE(1Mbps)	-
2402MHz	Default
2440MHz	Default
2480MHz	Default

2.3 The Worst Case Measurement Configuration

The Worst Case Mode for Following Conformance Tests	
Tests Item	AC power-line conducted emissions
Condition	AC power-line conducted measurement for line and neutral
Operating Mode	CTX
1	DC Power Supply mode

The Worst Case Mode for Following Conformance Tests	
Tests Item	DTS Bandwidth Maximum Conducted Output Power Power Spectral Density Emissions in Non-restricted Frequency Bands
Test Condition	Conducted measurement at transmit chains

The Worst Case Mode for Following Conformance Tests			
Tests Item	Emissions in Restricted Frequency Bands		
Test Condition	Radiated measurement If EUT consist of multiple antenna assembly (multiple antenna are used in EUT regardless of spatial multiplexing MIMO configuration), the radiated test should be performed with highest antenna gain of each antenna type.		
Operating Mode < 1GHz	CTX		
1	DC Power Supply mode		
Operating Mode > 1GHz	CTX		
Orthogonal Planes of EUT	X Plane	Y Plane	Z Plane
			
Worst Planes of EUT			V

The Worst Case Mode for Following Conformance Tests	
Tests Item	Simultaneous Transmission Analysis
Test Condition	Radiated measurement
Operating Mode	Normal Link
1	Bluetooth+WLAN 2.4GHz
2	Bluetooth+WLAN 5GHz
Refer to Sporton Test Report No.: FA952001 for Co-location RF Exposure Evaluation and Appendix G for Radiated Emission Co-location.	



2.4 Support Equipment

Support Equipment – AC Conduction				
No.	Equipment	Brand Name	Model Name	FCC ID
1	DC Power Supply	GW	GPR-3510HD	N/A
2	Test Fixture	N/A	N/A	N/A

Support Equipment – RF Conducted				
No.	Equipment	Brand Name	Model Name	FCC ID
1	PC	ASUS	D302MT	N/A
2	Monitor	DELL	VCDTS21553-3P	DoC
3	Test Fixture	N/A	N/A	N/A

Note: Support equipment No.1 was provided by customer.

Support Equipment – Radiated Emission				
No.	Equipment	Brand Name	Model Name	FCC ID
1	DC Power Supply	GW	GPR-3510HD	N/A
2	Test Fixture	N/A	N/A	N/A

2.5 Test Setup Diagram

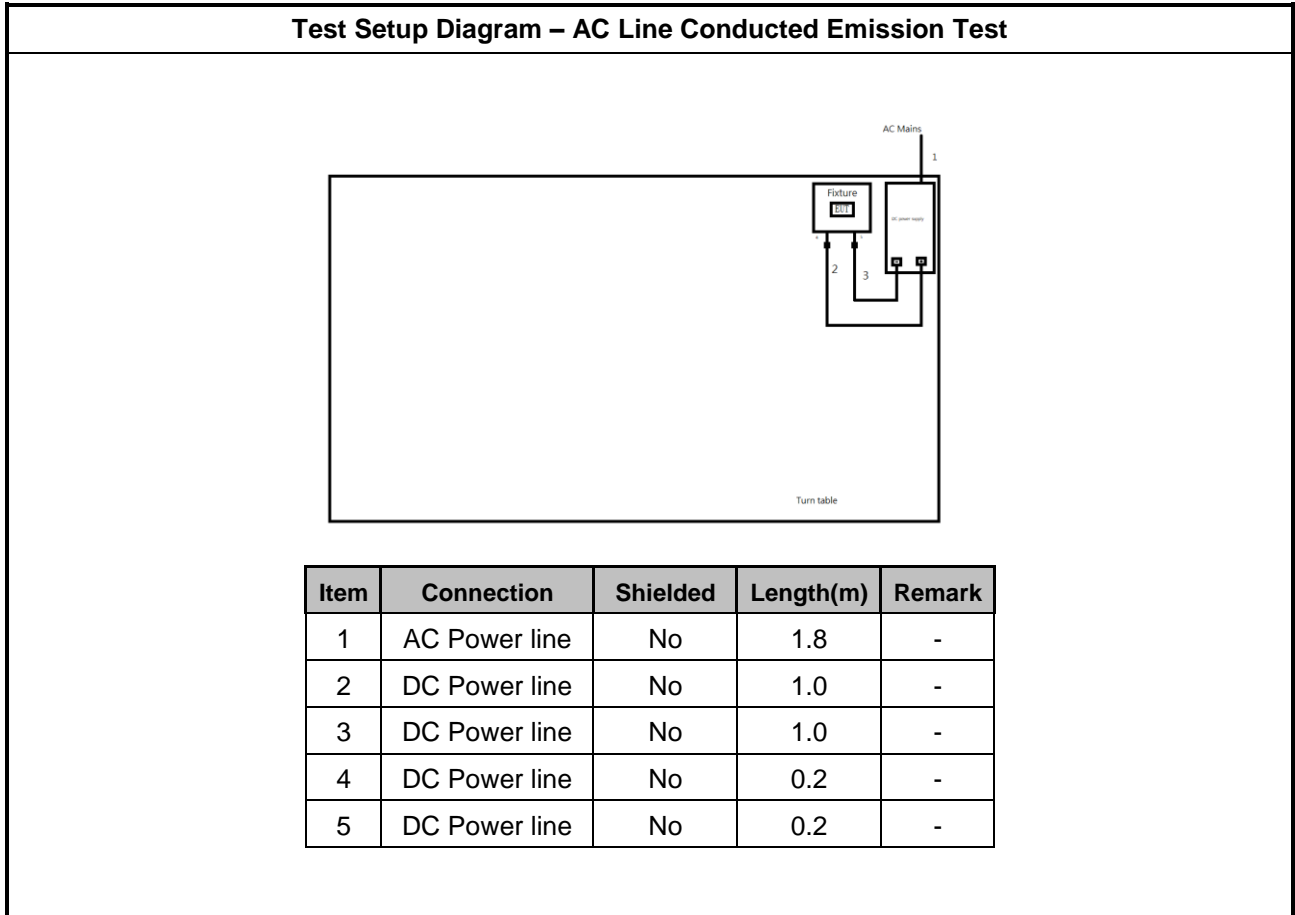

Test Setup Diagram - Radiated Test

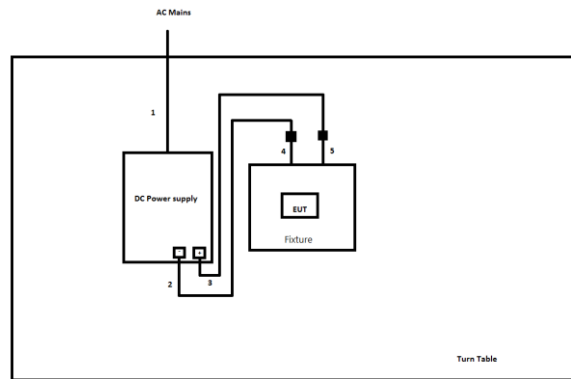

Item	Connection	Shielded	Length(m)	Remark
1	AC Power line	No	1.8	-
2	DC Power line	No	1.0	-
3	DC Power line	No	1.0	-
4	DC Power line	No	0.2	-
5	DC Power line	No	0.2	-

3 Transmitter Test Result

3.1 AC Power-line Conducted Emissions

3.1.1 AC Power-line Conducted Emissions Limit

AC Power-line Conducted Emissions Limit		
Frequency Emission (MHz)	Quasi-Peak	Average
0.15-0.5	66 - 56 *	56 - 46 *
0.5-5	56	46
5-30	60	50

Note 1: * Decreases with the logarithm of the frequency.

3.1.2 Measuring Instruments

Refer a test equipment and calibration data table in this test report.

3.1.3 Test Procedures

Test Method
<ul style="list-style-type: none"> Refer as ANSI C63.10-2013, clause 6.2 foray power-line conducted emissions.

3.1.4 Test Setup

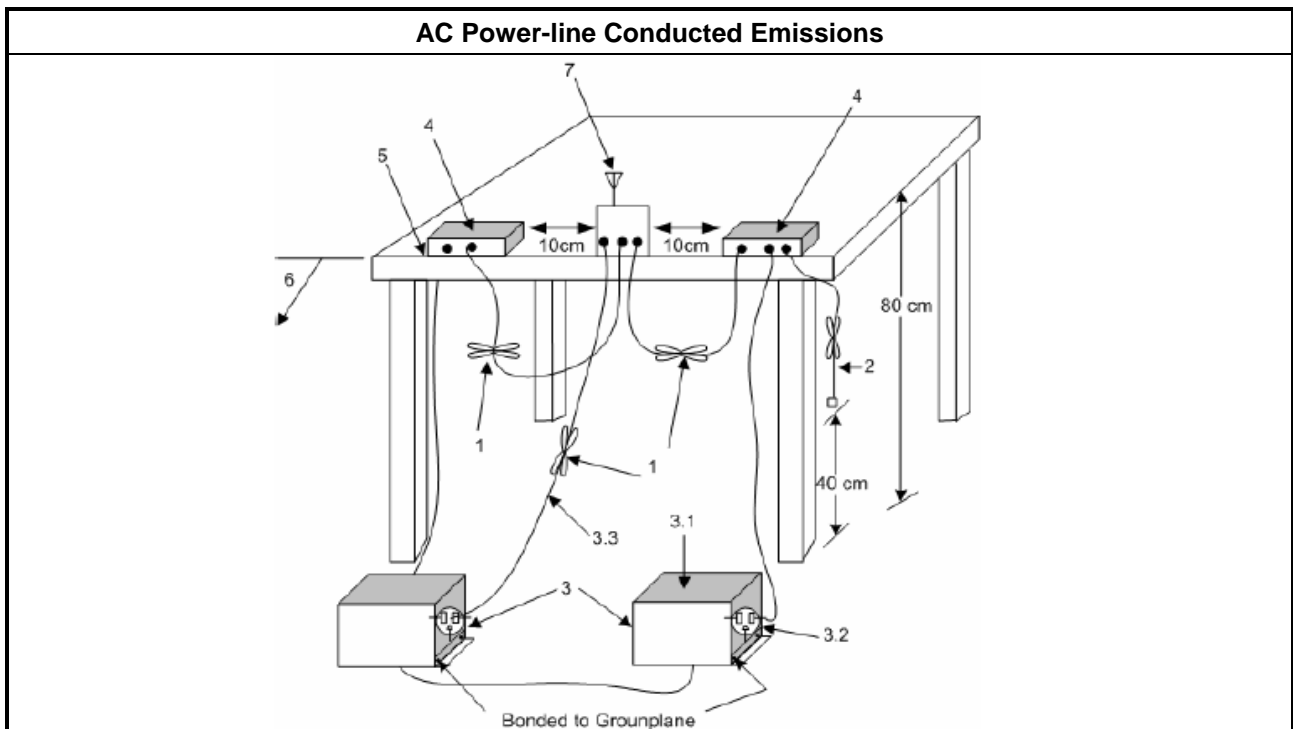

3.1.5 Test Result of AC Power-line Conducted Emissions

Refer as Appendix A

3.2 DTS Bandwidth

3.2.1 6dB Bandwidth Limit

6dB Bandwidth Limit
Systems using digital modulation techniques:
<ul style="list-style-type: none"> ▪ 6 dB bandwidth \geq 500 kHz.

3.2.2 Measuring Instruments

Refer a test equipment and calibration data table in this test report.

3.2.3 Test Procedures

Test Method
<ul style="list-style-type: none"> ▪ For the emission bandwidth shall be measured using one of the options below:
<input checked="" type="checkbox"/> Refer as KDB 558074, clause 8.2 (11.8 of ANSI C63.10) DTS bandwidth measurement.
<input type="checkbox"/> Refer as RSS-Gen, clause 6.7 for occupied bandwidth testing.
<input type="checkbox"/> Refer as ANSI C63.10, clause 6.9.3 for occupied bandwidth testing.

3.2.4 Test Setup

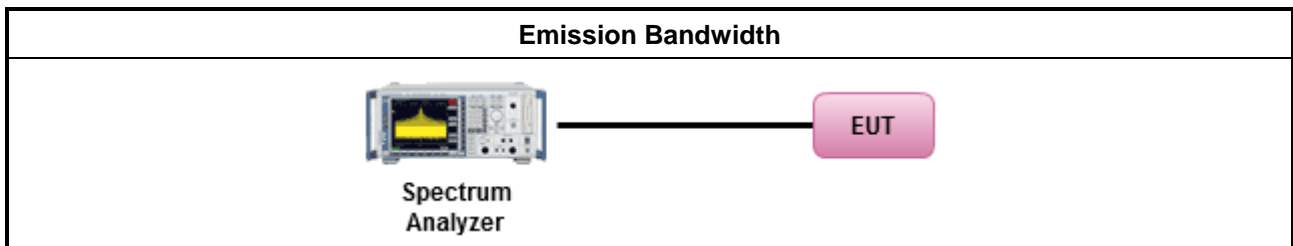

3.2.5 Test Result of Emission Bandwidth

Refer as Appendix B

3.3 Maximum Conducted Output Power

3.3.1 Maximum Conducted Output Power Limit

Maximum Conducted Output Power Limit	
	<ul style="list-style-type: none"> ▪ If $G_{TX} \leq 6$ dBi, then $P_{Out} \leq 30$ dBm (1 W)
	<ul style="list-style-type: none"> ▪ Point-to-multipoint systems (P2M): If $G_{TX} > 6$ dBi, then $P_{Out} = 30 - (G_{TX} - 6)$ dBm
	<ul style="list-style-type: none"> ▪ Point-to-point systems (P2P): If $G_{TX} > 6$ dBi, then $P_{Out} = 30 - (G_{TX} - 6)/3$ dBm
	<ul style="list-style-type: none"> ▪ Smart antenna system (SAS):
	<ul style="list-style-type: none"> - Single beam: If $G_{TX} > 6$ dBi, then $P_{Out} = 30 - (G_{TX} - 6)/3$ dBm
	<ul style="list-style-type: none"> - Overlap beam: If $G_{TX} > 6$ dBi, then $P_{Out} = 30 - (G_{TX} - 6)/3$ dBm
	<ul style="list-style-type: none"> - Aggregate power on all beams: If $G_{TX} > 6$ dBi, then $P_{Out} = 30 - (G_{TX} - 6)/3 + 8$ dB dBm
e.i.r.p. Power Limit:	
	<ul style="list-style-type: none"> ▪ 2400-2483.5 MHz Band
	<ul style="list-style-type: none"> ▪ Point-to-multipoint systems (P2M): $P_{eirp} \leq 36$ dBm (4 W)
	<ul style="list-style-type: none"> ▪ Point-to-point systems (P2P): $P_{eirp} \leq \text{MAX}(36, [P_{Out} + G_{TX}])$ dBm
	<ul style="list-style-type: none"> ▪ Smart antenna system (SAS)
	<ul style="list-style-type: none"> - Single beam: $P_{eirp} \leq \text{MAX}(36, P_{Out} + G_{TX})$ dBm
	<ul style="list-style-type: none"> - Overlap beam: $P_{eirp} \leq \text{MAX}(36, P_{Out} + G_{TX})$ dBm
	<ul style="list-style-type: none"> - Aggregate power on all beams: $P_{eirp} \leq \text{MAX}(36, [P_{Out} + G_{TX} + 8])$ dBm
P_{Out} = maximum peak conducted output power or maximum conducted output power in dBm, G_{TX} = the maximum transmitting antenna directional gain in dBi.	

3.3.2 Measuring Instruments

Refer a test equipment and calibration data table in this test report.

3.3.3 Test Procedures

Test Method	
<ul style="list-style-type: none"> ▪ Maximum Peak Conducted Output Power 	
<input type="checkbox"/>	Refer as KDB 558074, clause 8.3.1.1 (11.9.1.1 of ANSI C63.10) RBW ≥ EBW method.
<input type="checkbox"/>	Refer as KDB 558074, clause 8.3.1.2 (11.9.1.2 of ANSI C63.10) integrated band power method.
<input type="checkbox"/>	Refer as KDB 558074, clause 8.3.1.3 (11.9.1.3 of ANSI C63.10) peak power meter.
<ul style="list-style-type: none"> ▪ Maximum Average Conducted Output Power 	
<input type="checkbox"/>	Refer as KDB 558074, clause 8.3.2.2 (11.9.2.2 of ANSI C63.10) using a spectrum analyzer.
<input checked="" type="checkbox"/>	Refer as KDB 558074, clause 8.3.2.3 (11.9.2.3 of ANSI C63.10) using a power meter.
<ul style="list-style-type: none"> ▪ For conducted measurement. 	
<ul style="list-style-type: none"> ▪ If the EUT supports multiple transmit chains using options given below: Refer as KDB 662911, In-band power measurements. Using the measure-and-sum approach, measured all transmit ports individually. Sum the power (in linear power units e.g., mW) of all ports for each individual sample and save them. 	
<ul style="list-style-type: none"> ▪ If multiple transmit chains, EIRP calculation could be following as methods: $P_{total} = P_1 + P_2 + \dots + P_n$ (calculated in linear unit [mW] and transfer to log unit [dBm]) $EIRP_{total} = P_{total} + DG$ 	

3.3.4 Test Setup

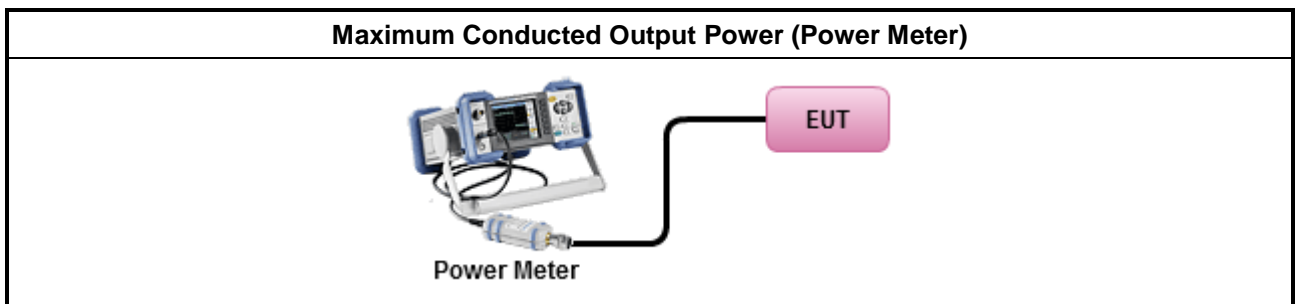

3.3.5 Test Result of Maximum Conducted Output Power

Refer as Appendix C

3.4 Power Spectral Density

3.4.1 Power Spectral Density Limit

Power Spectral Density Limit
<ul style="list-style-type: none"> ▪ Power Spectral Density (PSD) ≤ 8 dBm/3kHz

3.4.2 Measuring Instruments

Refer a test equipment and calibration data table in this test report.

3.4.3 Test Procedures

Test Method	
	<ul style="list-style-type: none"> ▪ Peak power spectral density procedures that the same method as used to determine the conducted output power. If maximum peak conducted output power was measured to demonstrate compliance to the output power limit, then the peak PSD procedure below (Method PKPSD) shall be used. If maximum conducted output power was measured to demonstrate compliance to the output power limit, then one of the average PSD procedures shall be used, as applicable based on the following criteria (the peak PSD procedure is also an acceptable option).
<input checked="" type="checkbox"/>	Refer as KDB 558074, clause 8.4 (11.10 of ANSI C63.10) Method PKPSD.
	<ul style="list-style-type: none"> ▪ For conducted measurement.
	<ul style="list-style-type: none"> ▪ If The EUT supports multiple transmit chains using options given below:
	<ul style="list-style-type: none"> ▪ Measure and sum the spectra across the outputs. Refer as KDB 662911, In-band power spectral density (PSD). Sample all transmit ports simultaneously using a spectrum analyzer for each transmit port. Where the trace bin-by-bin of each transmit port summing can be performed. (i.e., in the first spectral bin of output 1 is summed with that in the first spectral bin of output 2 and that from the first spectral bin of output 3, and so on up to the NTX output to obtain the value for the first frequency bin of the summed spectrum.). Add up the amplitude (power) values for the different transmit chains and use this as the new data trace.

3.4.4 Test Setup

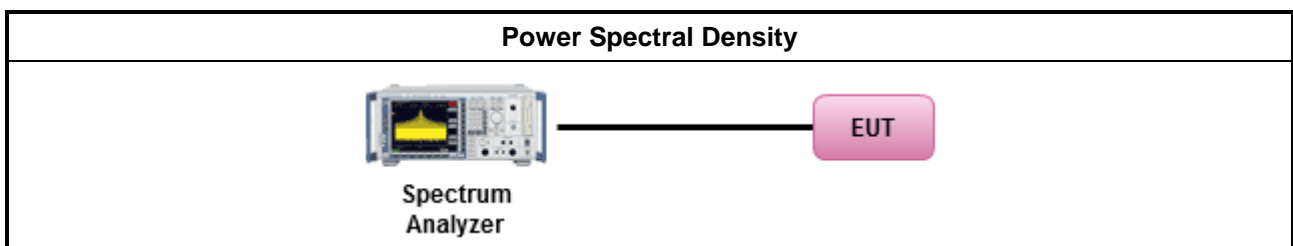

3.4.5 Test Result of Power Spectral Density

Refer as Appendix D

3.5 Emissions in Non-restricted Frequency Bands

3.5.1 Emissions in Non-restricted Frequency Bands Limit

Un-restricted Band Emissions Limit	
RF output power procedure	Limit (dB)
Peak output power procedure	20
Average output power procedure	30
<p>Note 1: If the peak output power procedure is used to measure the fundamental emission power to demonstrate compliance to requirements, then the peak conducted output power measured within any 100 kHz outside the authorized frequency band shall be attenuated by at least 20 dB relative to the maximum measured in-band peak PSD level.</p> <p>Note 2: If the average output power procedure is used to measure the fundamental emission power to demonstrate compliance to requirements, then the power in any 100 kHz outside of the authorized frequency band shall be attenuated by at least 30 dB relative to the maximum measured in-band average PSD level.</p>	

3.5.2 Measuring Instruments

Refer a test equipment and calibration data table in this test report.

3.5.3 Test Procedures

Test Method
<ul style="list-style-type: none"> Refer as KDB 558074, clause 8.5 (11.11 of ANSI C63.10) for non-restricted frequency bands.

3.5.4 Test Setup

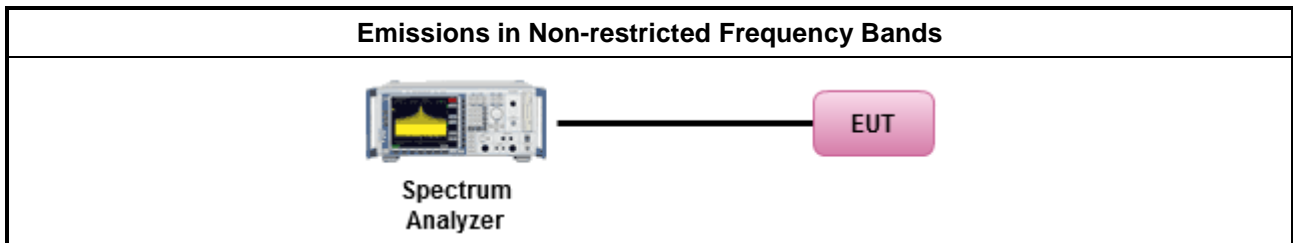

3.5.5 Test Result of Emissions in Non-restricted Frequency Bands

Refer as Appendix E

3.6 Emissions in Restricted Frequency Bands

3.6.1 Emissions in Restricted Frequency Bands Limit

Restricted Band Emissions Limit			
Frequency Range (MHz)	Field Strength (uV/m)	Field Strength (dBuV/m)	Measure Distance (m)
0.009~0.490	2400/F(kHz)	48.5 - 13.8	300
0.490~1.705	24000/F(kHz)	33.8 - 23	30
1.705~30.0	30	29	30
30~88	100	40	3
88~216	150	43.5	3
216~960	200	46	3
Above 960	500	54	3

Note 1: Test distance for frequencies at or above 30 MHz, measurements may be performed at a distance other than the limit distance provided they are not performed in the near field and the emissions to be measured can be detected by the measurement equipment. When performing measurements at a distance other than that specified, the results shall be extrapolated to the specified distance using an extrapolation factor of 20 dB/decade (inverse of linear distance for field-strength measurements, inverse of linear distance-squared for power-density measurements).

Note 2: Test distance for frequencies at below 30 MHz, measurements may be performed at a distance closer than the EUT limit distance; however, an attempt should be made to avoid making measurements in the near field. When performing measurements below 30 MHz at a closer distance than the limit distance, the results shall be extrapolated to the specified distance by either making measurements at a minimum of two or more distances on at least one radial to determine the proper extrapolation factor or by using the square of an inverse linear distance extrapolation factor (40 dB / decade). The test report shall specify the extrapolation method used to determine compliance of the EUT.

Note 3: Using the distance of 1m during the test for above 18 GHz, and the test value to correct for the distance factor at 3m.

3.6.2 Measuring Instruments

Refer a test equipment and calibration data table in this test report.

3.6.3 Test Procedures

Test Method	
	<ul style="list-style-type: none"> ▪ The average emission levels shall be measured in [duty cycle \geq 98 or duty factor].
	<ul style="list-style-type: none"> ▪ Refer as ANSI C63.10, clause 6.10.3 band-edge testing shall be performed at the lowest frequency channel and highest frequency channel within the allowed operating band.
	<ul style="list-style-type: none"> ▪ For the transmitter unwanted emissions shall be measured using following options below: <ul style="list-style-type: none"> ▪ Refer as KDB 558074, clause 8.6 (11.12 of ANSI C63.10) for restricted frequency bands.
	<ul style="list-style-type: none"> ▪ For the transmitter band-edge emissions shall be measured using following options below: <ul style="list-style-type: none"> ▪ Refer as KDB 558074 clause 8.7.1, When the performing peak or average radiated measurements, emissions within 2 MHz of the authorized band edge may be measured using the marker-delta method described below. ▪ Refer as KDB 558074, clause 8.7.2 (6.10.6 of ANSI C63.10) for marker-delta method for band-edge measurements. ▪ Refer as KDB 558074, clause 8.7.3 for narrower resolution bandwidth (100kHz) using the band power and summing the spectral levels (i.e., 1 MHz).
	<ul style="list-style-type: none"> ▪ Use the following spectrum analyzer settings: <ul style="list-style-type: none"> ▪ Set RBW=100 kHz for $f < 1$ GHz; VBW=3 * RBW; Sweep = auto; Detector function = peak; Trace = max hold. ▪ Set RBW = 1 MHz, VBW= 3MHz for $f \geq 1$ GHz for peak measurement. For average measurement, refer as 1.1.4.

3.6.4 Test Setup

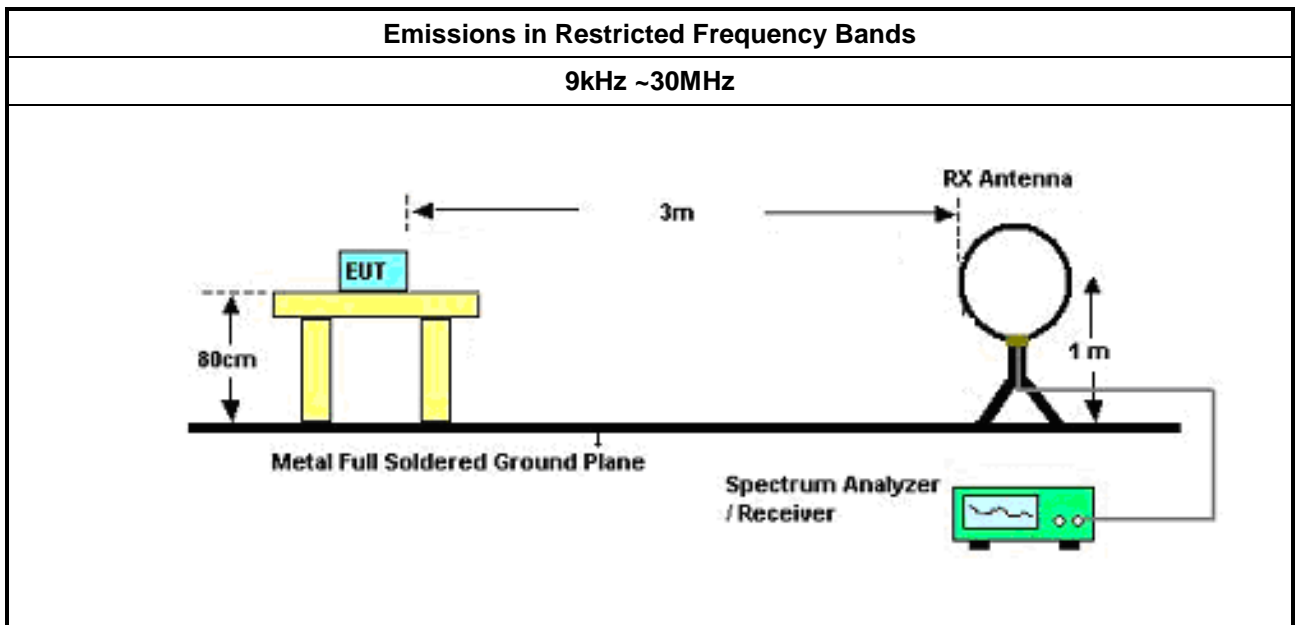

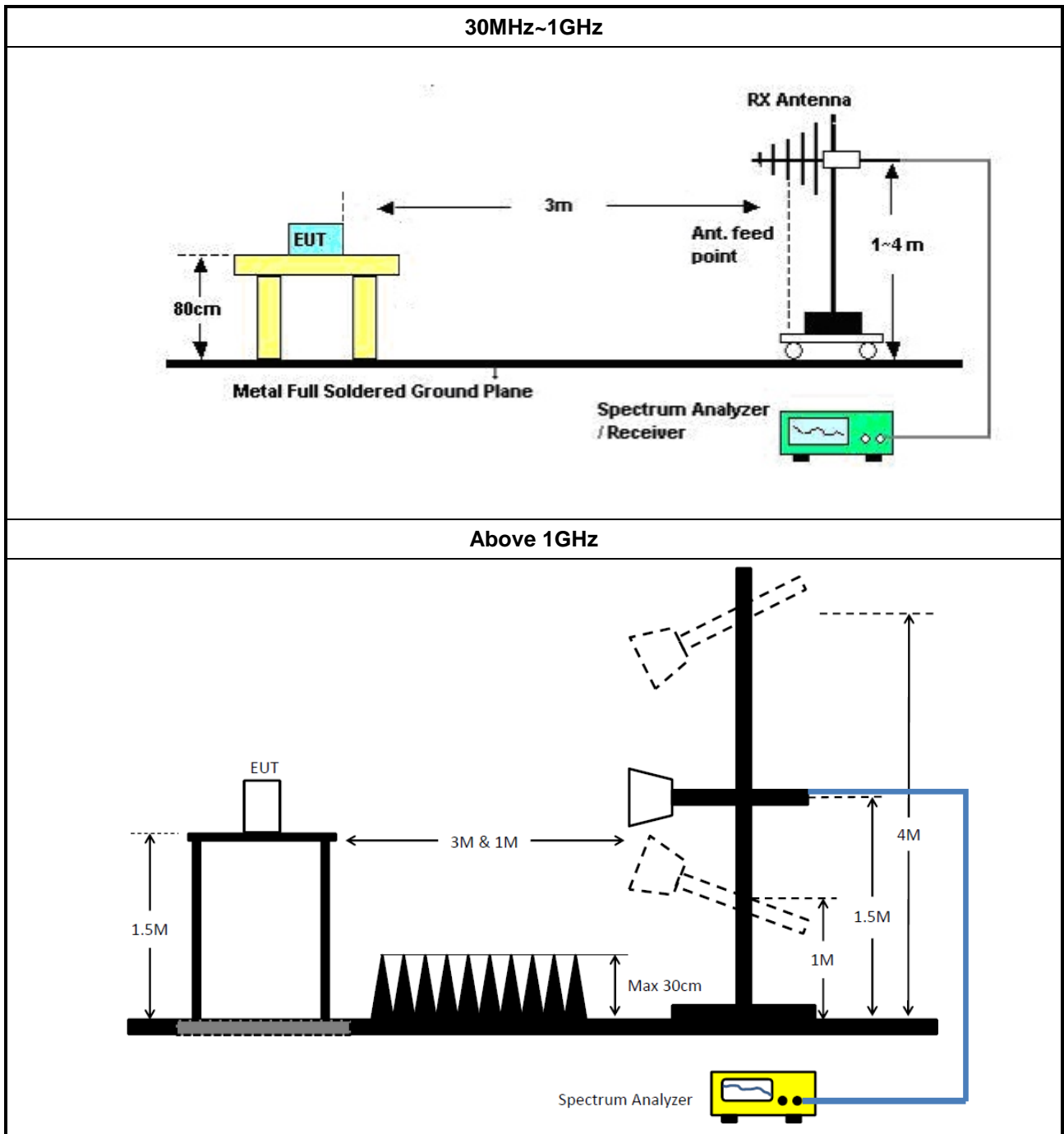

3.6.5 Test Result of Emissions in Restricted Frequency Bands (Below 30MHz)

The amplitude of spurious emissions which are attenuated by more than 20dB below the permissible value has no need to be reported.

3.6.6 Test Result of Emissions in Restricted Frequency Bands

Refer as Appendix F

4 Test Equipment and Calibration Data

Instrument for AC Conduction

Instrument	Manufacturer	Model No.	Serial No.	Spec.	Calibration Date	Calibration Due Date
EMC Receiver	R&S	ESR3	102052	9kHz ~ 3.6GHz	09/Apr/2019	08/Apr/2020
LISN	R&S	ENV 216	101274	9kHz ~ 30MHz	12/Jun/2018	11/Jun/2019
RF Cable-CON	MTJ	RG142	CB001-CO	9kHz ~ 30MHz	17/Sep/2018	16/Sep/2019
AC POWER	APC	AFC-11003G	F308010045	47Hz~63Hz 5~300V	NCR	NCR
Impuls Begrenzer Puls e Limiter	SCHWARZBECK	VTSD 9561F	9495	9kHz ~ 30MHz	11/Oct/2018	10/Oct/2019

NCR : Non-Calibration Require

Instrument for Conducted Test

Instrument	Manufacturer	Model No.	Serial No.	Spec.	Calibration Date	Calibration Due Date
Spectrum Analyzer	R&S	FSV 40	101500	10Hz~40GHz	18/Jul/2018	17/Jul/2019
Power Sensor	Anritsu	MA2411B	1339407	300MHz ~ 40GHz	17/Nov/2018	16/Nov/2019
Power Meter	Anritsu	ML2495A	1517010	300MHz ~ 40GHz	17/Nov/2018	16/Nov/2019
Cable 0.2m	HUBER	MY10710/4	RF Cable - 01	30MHz ~18G	10/Jan/2019	09/Jan/2020
Cable 0.2m	HUBER	MY10711/4	RF Cable - 02	30MHz ~18G	10/Jan/2019	09/Jan/2020
Cable 0.5m	HUBER	MY39470/4	RF Cable - 29	30MHz ~18G	10/Jan/2019	09/Jan/2020
SMB100A Signal Generator	R&S	SMB100A03	181147	100kHz~40GHz	12/Nov/2018	10/Nov/2020



Instrument for Radiated Test

Instrument	Manufacturer	Model No.	Serial No.	Spec.	Calibration Date	Calibration Due Date
3m Semi Anechoic Chamber	SIDT FRANKONIA	SAC-3M	03CH02-HY	30MHz ~ 1GHz 3m	19/Oct/2018	18/Oct/2019
3m Semi Anechoic Chamber	SIDT FRANKONIA	SAC-3M	03CH02-HY	1GHz ~ 18GHz 3m	17/Oct/2018	16/Oct/2019
Amplifier	Agilent	8447D	2944A11149	100kHz ~ 1.3GHz	27Jul/2018	02/Jul/2019
Microwave Preamplifier	Agilent	8449B	3008A02373	1GHz ~ 26.5GHz	23/Oct/2018	22/Oct/2019
Signal Analyzer	R&S	FSV40	101500	10Hz ~ 40GHz	18/Jul/2018	17/Jul/2019
RF Cable-R03m	Jye Bao	RG142	CB017	9kHz ~ 1GHz	18/Jan/2019	17/Jan/2020
RF Cable-high	SUHNER	SUCOFLEX104	MY34918/4	1GHz ~ 40GHz	18/Jan/2019	17/Jan/2020
Bilog Antenna & 5dB Attenuator	SCHAFFNER / MTJ	CBL 6112B / MTJ6102-05	2723 / 2	30MHz ~ 1GHz	08/Sep/2018	07/Sep/2019
EMI Test Receiver	R&S	ESR	102052	9kHz ~ 3.6GHz	09/Apr/2019	08/Apr/2020
Loop Antenna	TESEQ	HLA 6120	31244	9k-30MHz	15/Mar/2019	14/Mar/2020
Broadband Horn Antenna	SCHWARZBECK	BBHA 9170	BBHA 9170221	15GHz ~ 40GHz	22/Mar/2019	21/Mar/2020
Double Ridged Guide Horn Antenna	SCHWARZBECK	BBHA 9120 D	BBHA 9120 D 01543	1GHz ~ 18GHz	03/Jun/2019	02/Jun/2020



AC Power-line Conducted Emissions Result

Operating Mode	1	Power Phase	Neutral
Operating Function	DC power supply		

25/05/2019

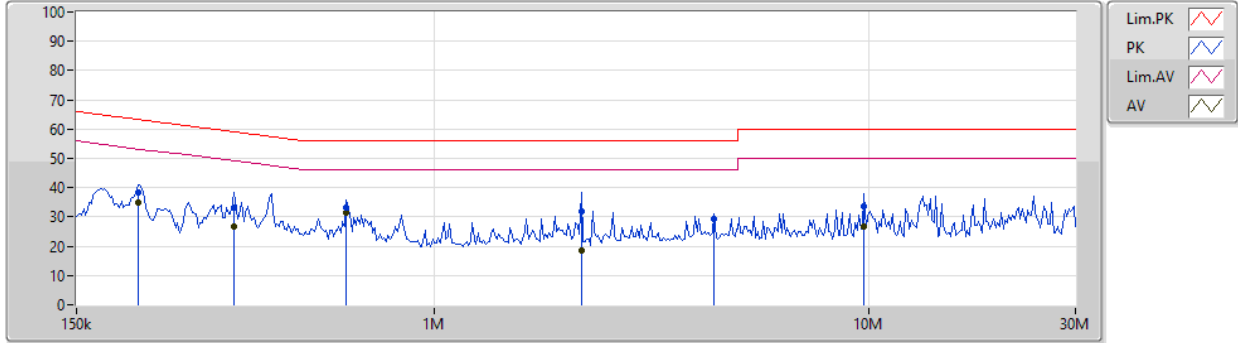

Type	Freq (Hz)	Level (dBuV)	Limit (dBuV)	Margin (dB)	Factor (dB)	Condition	Comment	Raw (dBuV)	LISN (dB)	CL (dB)	AT (dB)
QP	208.304k	38.45	63.27	-24.82	19.51	Neutral	-	18.94	9.64	0.01	9.86
AV	208.304k	34.93	53.27	-18.34	19.51	Neutral	-	15.42	9.64	0.01	9.86
QP	346.008k	33.13	59.06	-25.93	19.51	Neutral	-	13.62	9.64	0.01	9.86
AV	346.008k	26.81	49.06	-22.25	19.51	Neutral	-	7.30	9.64	0.01	9.86
QP	628.592k	33.08	56.00	-22.92	19.51	Neutral	-	13.57	9.64	0.01	9.86
AV	628.592k	31.66	46.00	-14.34	19.51	Neutral	"Worst"	12.15	9.64	0.01	9.86
QP	2.18M	31.94	56.00	-24.06	19.55	Neutral	-	12.39	9.65	0.03	9.87
AV	2.18M	18.35	46.00	-27.65	19.55	Neutral	-	-1.20	9.65	0.03	9.87
QP	4.419M	29.51	56.00	-26.49	19.59	Neutral	-	9.92	9.66	0.05	9.88
AV	4.419M	29.20	46.00	-16.80	19.59	Neutral	-	9.61	9.66	0.05	9.88
QP	9.796M	33.60	60.00	-26.40	19.68	Neutral	-	13.92	9.71	0.07	9.90
AV	9.796M	26.88	50.00	-23.12	19.68	Neutral	-	7.20	9.71	0.07	9.90



AC Power-line Conducted Emissions Result

Operating Mode	1	Power Phase	Line
Operating Function	DC power supply		

25/05/2019

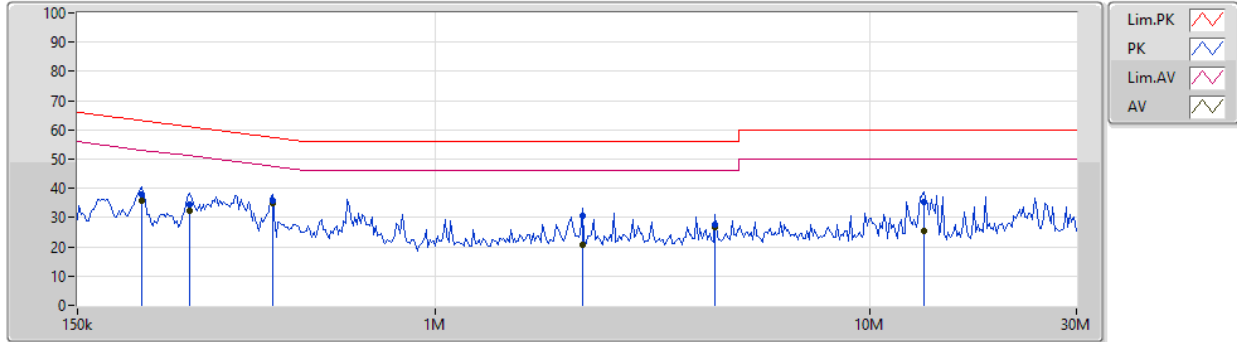

Type	Freq (Hz)	Level (dBuV)	Limit (dBuV)	Margin (dB)	Factor (dB)	Condition	Comment	Raw (dBuV)	LISN (dB)	CL (dB)	AT (dB)
QP	210.387k	37.91	63.19	-25.28	19.48	Line	-	18.43	9.61	0.01	9.86
AV	210.387k	35.73	53.19	-17.46	19.48	Line	-	16.25	9.61	0.01	9.86
QP	272.505k	34.69	61.05	-26.36	19.48	Line	-	15.21	9.61	0.01	9.86
AV	272.505k	32.32	51.05	-18.73	19.48	Line	-	12.84	9.61	0.01	9.86
QP	422.196k	35.75	57.40	-21.65	19.48	Line	-	16.27	9.61	0.01	9.86
AV	422.196k	34.83	47.40	-12.57	19.48	Line	"Worst"	15.35	9.61	0.01	9.86
QP	2.18M	30.47	56.00	-25.53	19.52	Line	-	10.95	9.62	0.03	9.87
AV	2.18M	20.54	46.00	-25.46	19.52	Line	-	1.02	9.62	0.03	9.87
QP	4.419M	27.56	56.00	-28.44	19.56	Line	-	8.00	9.63	0.05	9.88
AV	4.419M	26.82	46.00	-19.18	19.56	Line	-	7.26	9.63	0.05	9.88
QP	13.336M	35.48	60.00	-24.52	19.66	Line	-	15.82	9.65	0.08	9.93
AV	13.336M	25.33	50.00	-24.67	19.66	Line	-	5.67	9.65	0.08	9.93



Summary

Mode	Max-N dB (Hz)	Max-OBW (Hz)	ITU-Code	Min-N dB (Hz)	Min-OBW (Hz)
2.4-2.4835GHz	-	-	-	-	-
BT-LE(1Mbps)	701.25k	1.019M	1M02F1D	690k	1.017M

Max-N dB = Maximum 6dB down bandwidth; **Max-OBW** = Maximum 99% occupied bandwidth;
Min-N dB = Minimum 6dB down bandwidth; **Min-OBW** = Minimum 99% occupied bandwidth;



Result

Mode	Result	Limit (Hz)	Port 1-N dB (Hz)	Port 1-OBW (Hz)
BT-LE(1Mbps)	-	-	-	-
2402MHz_TnomVnom	Pass	500k	690k	1.018M
2440MHz_TnomVnom	Pass	500k	701.25k	1.017M
2480MHz_TnomVnom	Pass	500k	696.25k	1.019M

Port X-N dB = Port X 6dB down bandwidth; Port X-OBW = Port X 99% occupied bandwidth;

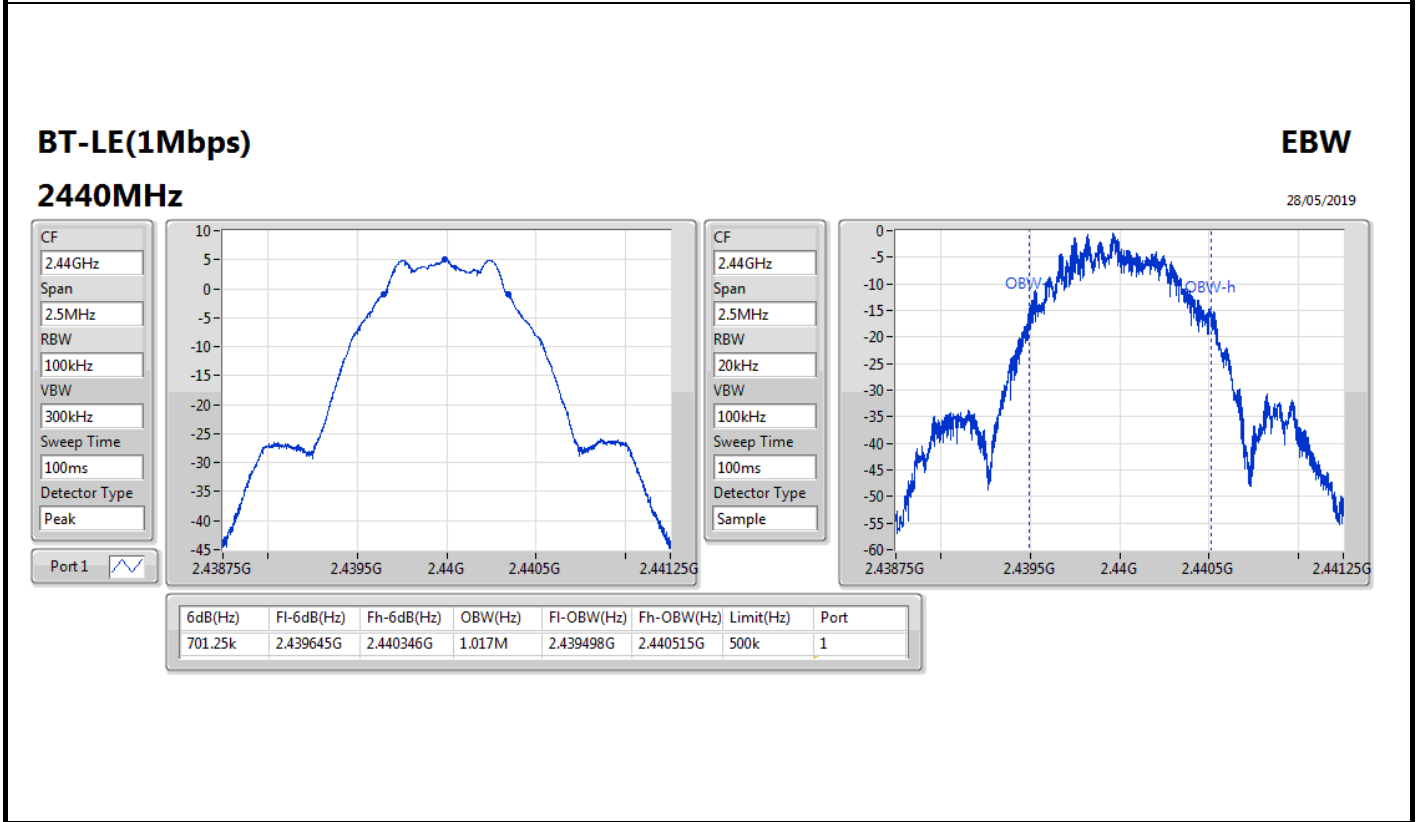
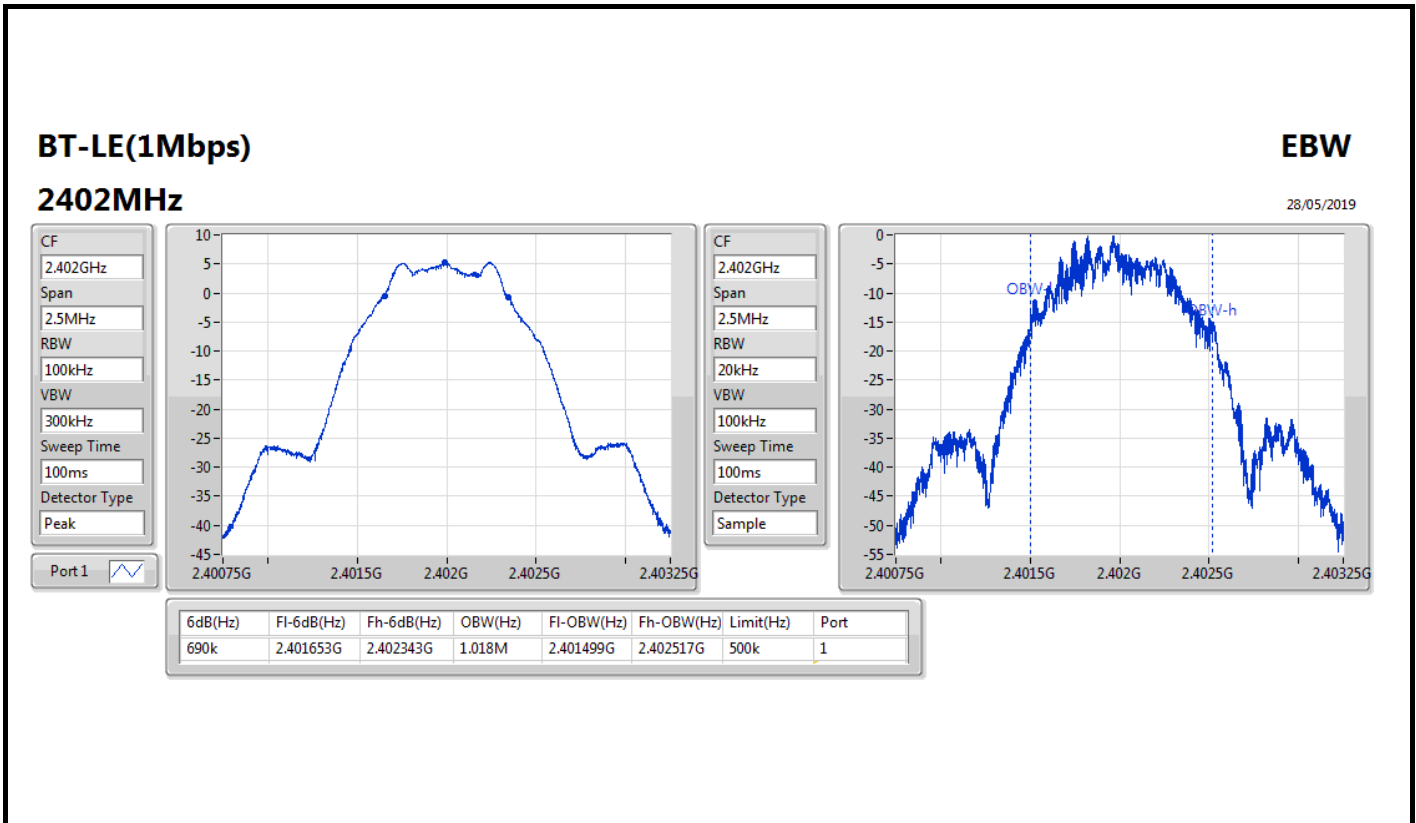

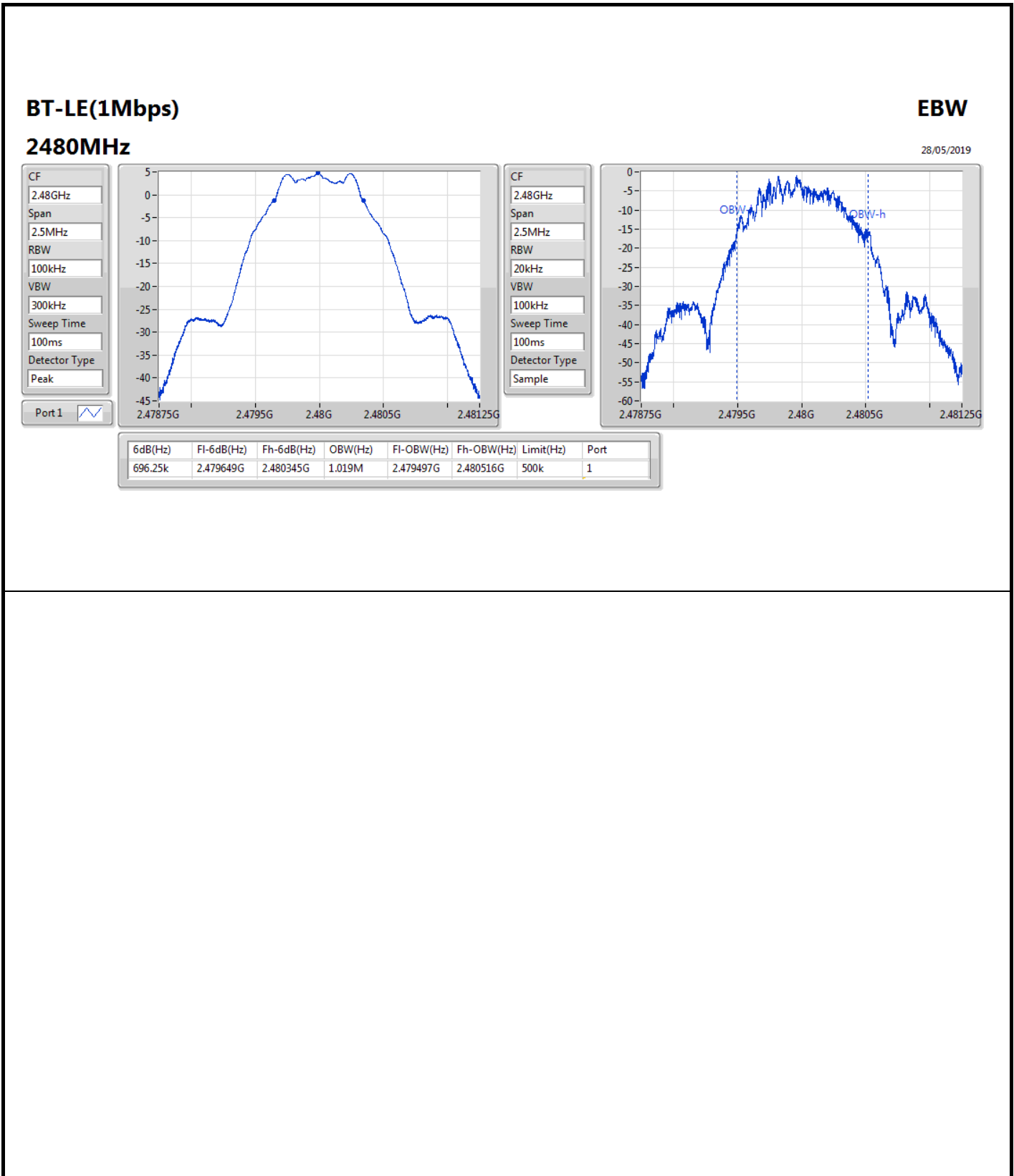



Summary

Mode	Power (dBm)	Power (W)
2.4-2.4835GHz	-	-
BT-LE(1Mbps)	6.23	0.00420



Result

Mode	Result	Gain (dBi)	Power (dBm)	Power Limit (dBm)
BT-LE(1Mbps)	-	-	-	-
2402MHz_TnomVnom	Pass	0.00	6.23	30.00
2440MHz_TnomVnom	Pass	0.00	6.06	30.00
2480MHz_TnomVnom	Pass	0.00	5.80	30.00

DG = Directional Gain; Port X = Port X output power



Summary

Mode	PD (dBm/RBW)
2.4-2.4835GHz	-
BT-LE(1Mbps)	-9.76

RBW=3 kHz.



Result

Mode	Result	Gain (dBi)	PD (dBm/RBW)	PD Limit (dBm/RBW)
BT-LE(1Mbps)	-	-	-	-
2402MHz_TnomVnom	Pass	0.00	-9.76	8.00
2440MHz_TnomVnom	Pass	0.00	-10.03	8.00
2480MHz_TnomVnom	Pass	0.00	-10.35	8.00

DG = Directional Gain; RBW=3 kHz;

PD = trace bin-by-bin of each transmits port summing can be performed maximum power density; Port X = Port X power density;

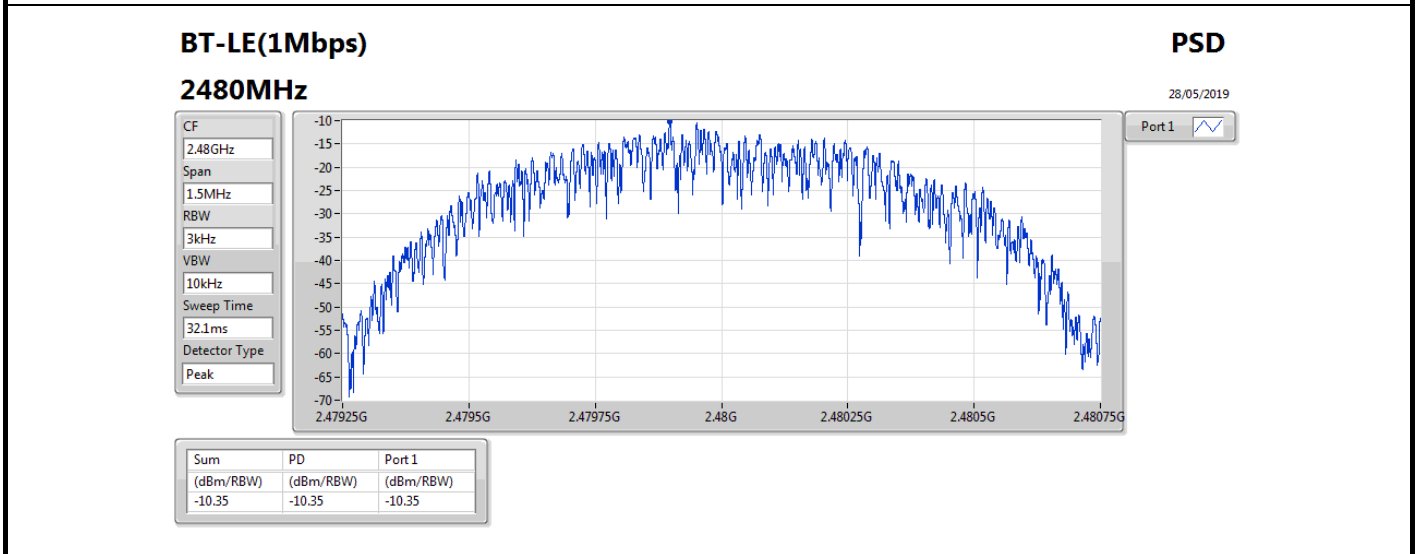
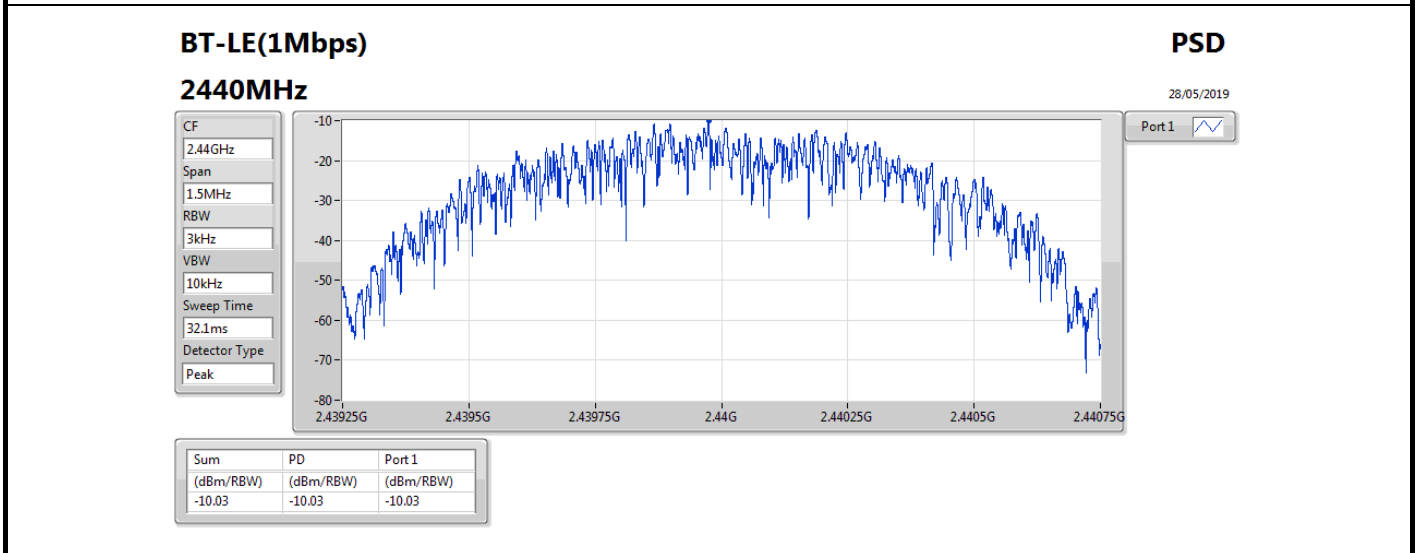
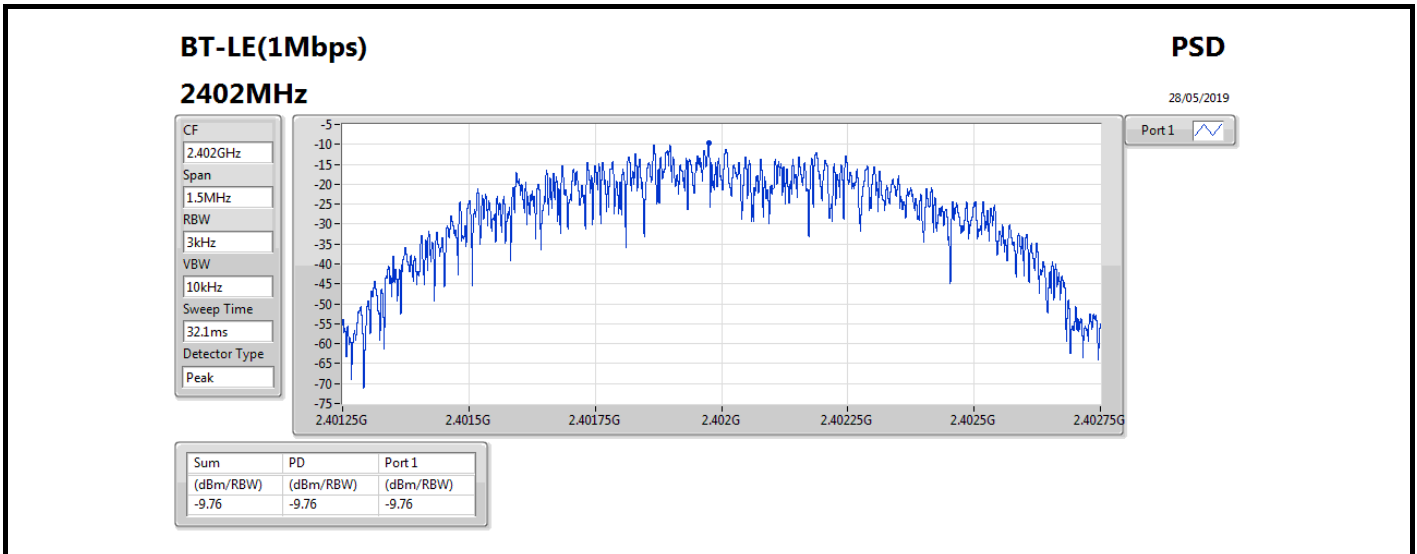



Summary

Mode	Result	Ref (Hz)	Ref (dBm)	Limit (dBm)	Freq (Hz)	Level (dBm)	Freq (Hz)	Level (dBm)	Freq (Hz)	Level (dBm)	Freq (Hz)	Level (dBm)	Port
2.4-2.4835GHz	-	-	-	-	-	-	-	-	-	-	-	-	-
BT-LE(1Mbps)	Pass	2.40196G	5.23	-24.77	2.11147G	-52.27	2.39887G	-53.24	2.48353G	-47.62	24.51594G	-39.65	1



Result

Mode	Result	Ref (Hz)	Ref (dBm)	Limit (dBm)	Freq (Hz)	Level (dBm)	Freq (Hz)	Level (dBm)	Freq (Hz)	Level (dBm)	Freq (Hz)	Level (dBm)	Port
BT-LE(1Mbps)	-	-	-	-	-	-	-	-	-	-	-	-	-
2402MHz_TnomVnom	Pass	2.40196G	5.23	-24.77	2.14344G	-53.90	2.39999G	-44.30	2.48508G	-52.71	23.41836G	-40.15	1
2440MHz_TnomVnom	Pass	2.40196G	5.23	-24.77	1.79002G	-54.37	2.39978G	-52.74	2.485G	-52.36	24.92964G	-40.28	1
2480MHz_TnomVnom	Pass	2.40196G	5.23	-24.77	2.11147G	-52.27	2.39887G	-53.24	2.48353G	-47.62	24.51594G	-39.65	1

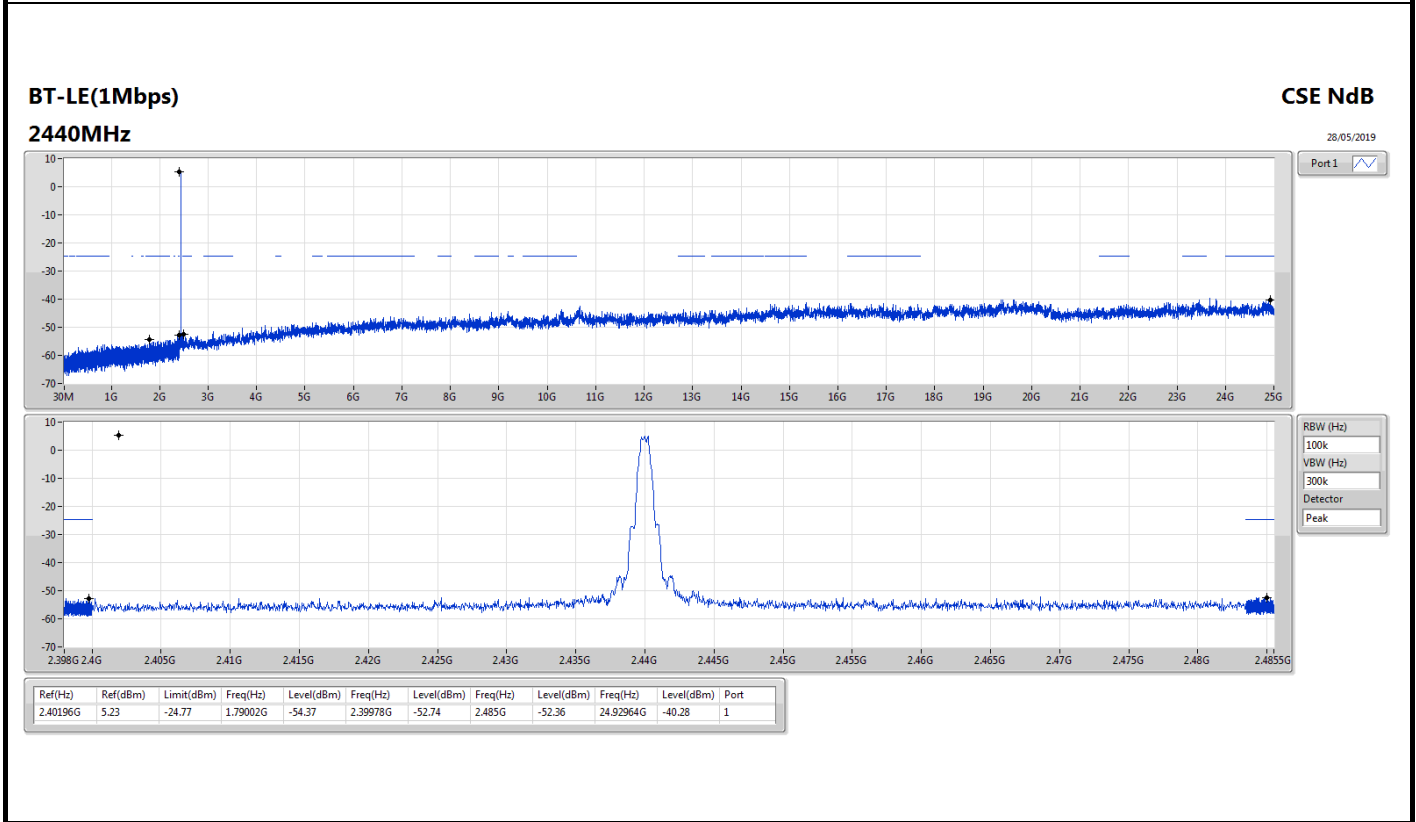
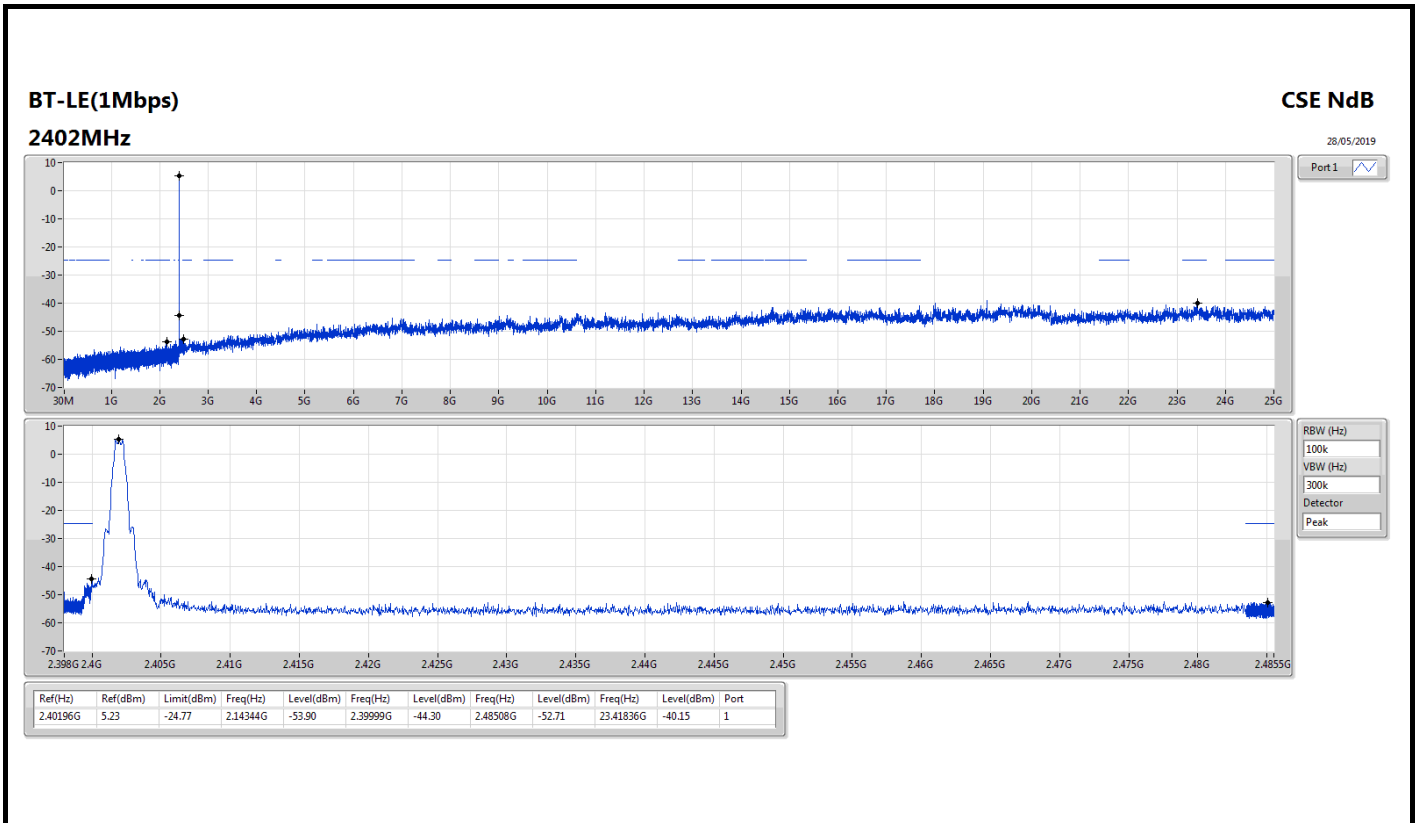

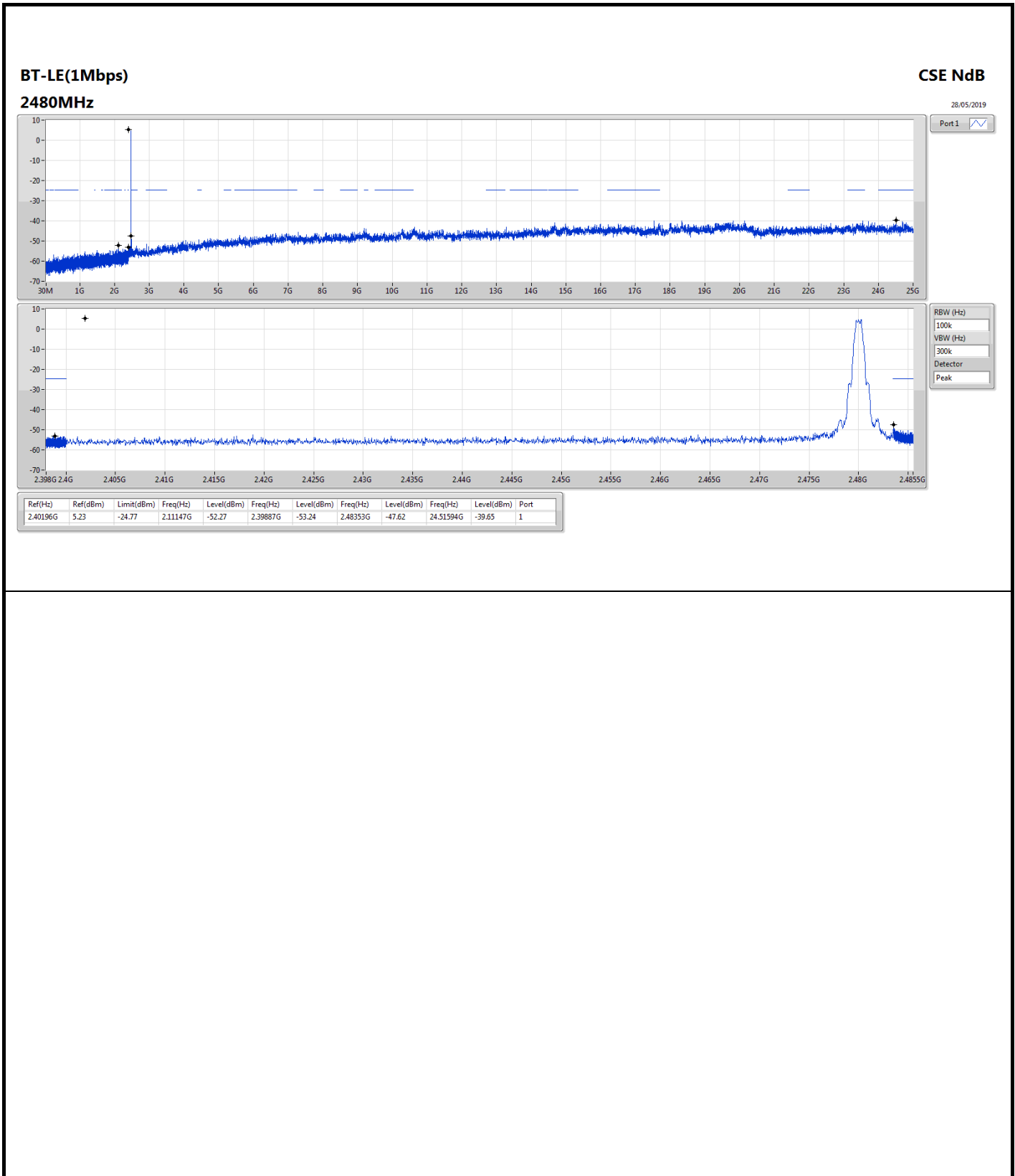



Summary

Mode	Result	Type	Freq (Hz)	Level (dBuV/m)	Limit (dBuV/m)	Margin (dB)	Factor (dB)	Dist (m)	Condition	Azimuth (°)	Height (m)	Comments
2.4-2.4835GHz	-	-	-	-	-	-	-	-	-	-	-	-
BT-LE(1Mbps)	Pass	PK	31.94M	34.76	40.00	-5.24	-3.92	3	Horizontal	0	1.00	-



Result

Mode	Result	Type	Freq (Hz)	Level (dBuV/m)	Limit (dBuV/m)	Margin (dB)	Factor (dB)	Dist (m)	Condition	Azimuth (°)	Height (m)	Comments
BT-LE(1Mbps)	-	-	-	-	-	-	-	-	-	-	-	-
2440MHz	Pass	PK	30M	33.31	40.00	-6.69	-2.85	3	Vertical	360	1.00	-
2440MHz	Pass	PK	107.6M	22.36	43.50	-21.14	-8.63	3	Vertical	360	1.00	-
2440MHz	Pass	PK	270.56M	21.71	46.00	-24.29	-6.22	3	Vertical	360	1.00	-
2440MHz	Pass	PK	352.04M	24.28	46.00	-21.72	-4.45	3	Vertical	360	1.00	-
2440MHz	Pass	PK	553.8M	27.83	46.00	-18.17	-0.27	3	Vertical	360	1.00	-
2440MHz	Pass	PK	728.4M	29.73	46.00	-16.27	1.02	3	Vertical	360	1.00	-
2440MHz	Pass	PK	31.94M	34.76	40.00	-5.24	-3.92	3	Horizontal	0	1.00	-
2440MHz	Pass	PK	127M	19.30	43.50	-24.20	-7.91	3	Horizontal	0	1.00	-
2440MHz	Pass	PK	299.66M	20.61	46.00	-25.39	-5.98	3	Horizontal	0	1.00	-
2440MHz	Pass	PK	419.94M	25.85	46.00	-20.15	-2.27	3	Horizontal	0	1.00	-
2440MHz	Pass	PK	561.56M	28.01	46.00	-17.99	-0.33	3	Horizontal	0	1.00	-
2440MHz	Pass	PK	714.82M	33.08	46.00	-12.92	0.58	3	Horizontal	0	1.00	-

BT-LE(1Mbps)

29/05/2019

2440MHz_DC Power supply

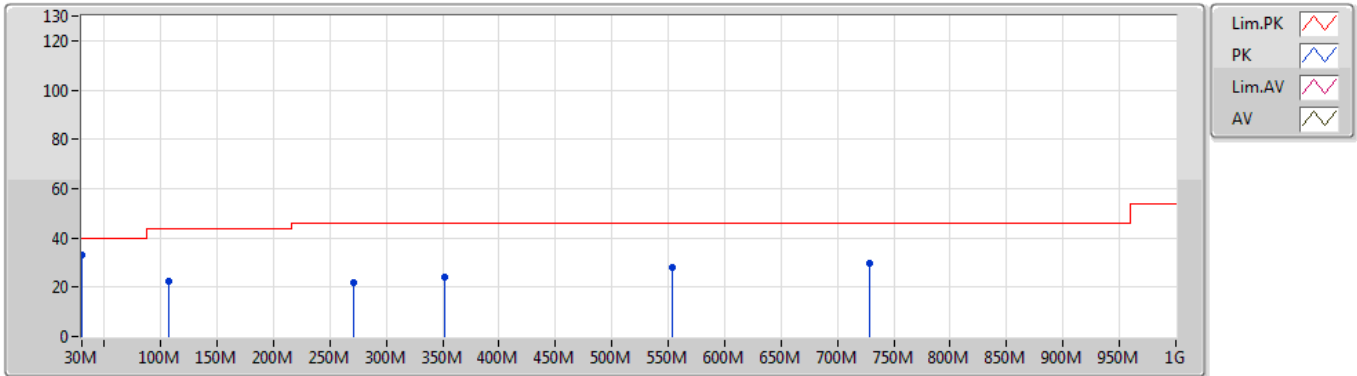

Type	Freq (Hz)	Level (dBuV/m)	Limit (dBuV/m)	Margin (dB)	Factor (dB)	Dist (m)	Condition	Azimuth (°)	Height (m)	Comment
PK	30M	33.31	40.00	-6.69	-2.85	3	Vertical	360	1.00	-
PK	107.6M	22.36	43.50	-21.14	-8.63	3	Vertical	360	1.00	-
PK	270.56M	21.71	46.00	-24.29	-6.22	3	Vertical	360	1.00	-
PK	352.04M	24.28	46.00	-21.72	-4.45	3	Vertical	360	1.00	-
PK	553.8M	27.83	46.00	-18.17	-0.27	3	Vertical	360	1.00	-
PK	728.4M	29.73	46.00	-16.27	1.02	3	Vertical	360	1.00	-

BT-LE(1Mbps)

29/05/2019

2440MHz_DC Power supply

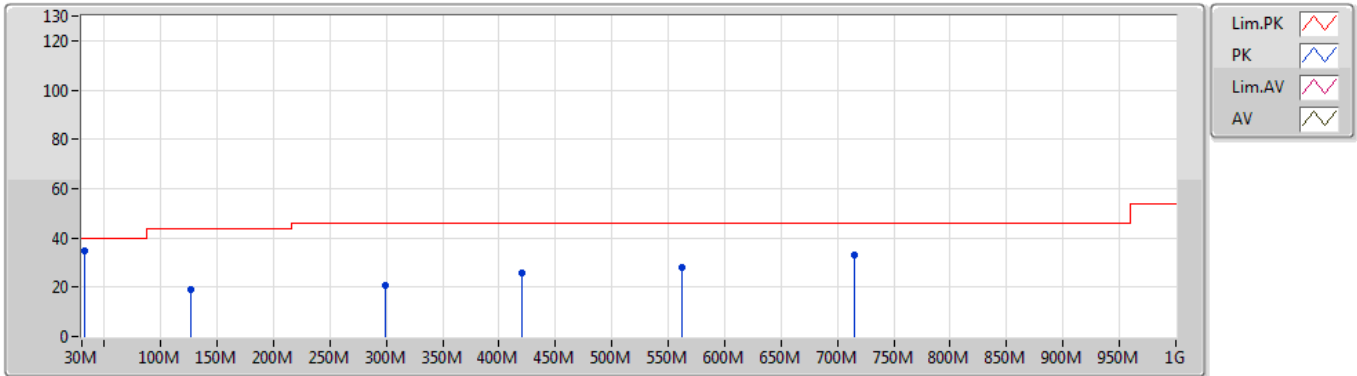

Type	Freq (Hz)	Level (dBuV/m)	Limit (dBuV/m)	Margin (dB)	Factor (dB)	Dist (m)	Condition	Azimuth (°)	Height (m)	Comment
PK	31.94M	34.76	40.00	-5.24	-3.92	3	Horizontal	0	1.00	-
PK	127M	19.30	43.50	-24.20	-7.91	3	Horizontal	0	1.00	-
PK	299.66M	20.61	46.00	-25.39	-5.98	3	Horizontal	0	1.00	-
PK	419.94M	25.85	46.00	-20.15	-2.27	3	Horizontal	0	1.00	-
PK	561.56M	28.01	46.00	-17.99	-0.33	3	Horizontal	0	1.00	-
PK	714.82M	33.08	46.00	-12.92	0.58	3	Horizontal	0	1.00	-



Summary

Mode	Result	Type	Freq (Hz)	Level (dBuV/m)	Limit (dBuV/m)	Margin (dB)	Factor (dB)	Dist (m)	Condition	Azimuth (°)	Height (m)	Comments
2.4-2.4835GHz	-	-	-	-	-	-	-	-	-	-	-	-
BT-LE(1Mbps)	Pass	AV	2.4835G	49.47	54.00	-4.53	32.10	3	Vertical	144	2.71	-



Result

Mode	Result	Type	Freq (Hz)	Level (dBuV/m)	Limit (dBuV/m)	Margin (dB)	Factor (dB)	Dist (m)	Condition	Azimuth (°)	Height (m)	Comments
BT-LE(1Mbps)	-	-	-	-	-	-	-	-	-	-	-	-
2402MHz_TX	Pass	AV	2.3534G	48.95	54.00	-5.05	32.32	3	Vertical	187	1.36	-
2402MHz_TX	Pass	AV	2.402G	93.45	Inf	-Inf	32.20	3	Vertical	187	1.36	-
2402MHz_TX	Pass	PK	2.387G	59.33	74.00	-14.67	32.23	3	Vertical	187	1.36	-
2402MHz_TX	Pass	PK	2.4022G	94.10	Inf	-Inf	32.20	3	Vertical	187	1.36	-
2402MHz_TX	Pass	AV	2.365G	48.87	54.00	-5.13	32.29	3	Horizontal	123	1.24	-
2402MHz_TX	Pass	AV	2.402G	99.30	Inf	-Inf	32.20	3	Horizontal	123	1.24	-
2402MHz_TX	Pass	PK	2.3792G	59.87	74.00	-14.13	32.25	3	Horizontal	123	1.24	-
2402MHz_TX	Pass	PK	2.4022G	99.88	Inf	-Inf	32.20	3	Horizontal	123	1.24	-
2402MHz_TX	Pass	AV	4.80004G	35.81	54.00	-18.19	8.12	3	Vertical	179	1.08	-
2402MHz_TX	Pass	PK	4.81672G	46.06	74.00	-27.94	8.15	3	Vertical	179	1.08	-
2402MHz_TX	Pass	AV	4.79452G	35.38	54.00	-18.62	8.12	3	Horizontal	228	1.50	-
2402MHz_TX	Pass	PK	4.79578G	46.11	74.00	-27.89	8.12	3	Horizontal	228	1.50	-
2440MHz_TX	Pass	AV	2.3592G	48.88	54.00	-5.12	32.30	3	Vertical	171	1.79	-
2440MHz_TX	Pass	AV	2.44G	89.75	Inf	-Inf	32.15	3	Vertical	171	1.79	-
2440MHz_TX	Pass	AV	2.4924G	49.21	54.00	-4.79	32.09	3	Vertical	171	1.79	-
2440MHz_TX	Pass	PK	2.362G	59.16	74.00	-14.84	32.30	3	Vertical	171	1.79	-
2440MHz_TX	Pass	PK	2.4404G	90.44	Inf	-Inf	32.15	3	Vertical	171	1.79	-
2440MHz_TX	Pass	PK	2.4835G	59.97	74.00	-14.03	32.10	3	Vertical	171	1.79	-
2440MHz_TX	Pass	AV	2.3444G	48.79	54.00	-5.21	32.34	3	Horizontal	128	1.26	-
2440MHz_TX	Pass	AV	2.44G	97.53	Inf	-Inf	32.15	3	Horizontal	128	1.26	-
2440MHz_TX	Pass	AV	2.4864G	49.22	54.00	-4.78	32.10	3	Horizontal	128	1.26	-
2440MHz_TX	Pass	PK	2.3628G	59.72	74.00	-14.28	32.30	3	Horizontal	128	1.26	-
2440MHz_TX	Pass	PK	2.4404G	98.14	Inf	-Inf	32.15	3	Horizontal	128	1.26	-
2440MHz_TX	Pass	PK	2.488G	59.74	74.00	-14.26	32.09	3	Horizontal	128	1.26	-
2440MHz_TX	Pass	AV	4.88156G	34.93	54.00	-19.07	8.27	3	Vertical	243	2.39	-
2440MHz_TX	Pass	AV	7.32702G	41.21	54.00	-12.79	14.41	3	Vertical	136	1.50	-
2440MHz_TX	Pass	PK	4.87094G	46.08	74.00	-27.92	8.25	3	Vertical	243	2.39	-
2440MHz_TX	Pass	PK	7.3326G	52.25	74.00	-21.75	14.39	3	Vertical	136	1.50	-
2440MHz_TX	Pass	AV	4.88228G	35.16	54.00	-18.84	8.27	3	Horizontal	83	1.50	-
2440MHz_TX	Pass	AV	7.3302G	41.40	54.00	-12.60	14.41	3	Horizontal	165	2.90	-
2440MHz_TX	Pass	PK	4.89464G	46.95	74.00	-27.05	8.29	3	Horizontal	83	1.50	-
2440MHz_TX	Pass	PK	7.32084G	52.65	74.00	-21.35	14.43	3	Horizontal	165	2.90	-
2480MHz_TX	Pass	AV	2.48G	90.66	Inf	-Inf	32.10	3	Vertical	144	2.71	-
2480MHz_TX	Pass	AV	2.4835G	49.47	54.00	-4.53	32.10	3	Vertical	144	2.71	-
2480MHz_TX	Pass	PK	2.4802G	91.32	Inf	-Inf	32.10	3	Vertical	144	2.71	-
2480MHz_TX	Pass	PK	2.4934G	60.02	74.00	-13.98	32.08	3	Vertical	144	2.71	-
2480MHz_TX	Pass	AV	2.48G	96.51	Inf	-Inf	32.10	3	Horizontal	128	1.44	-
2480MHz_TX	Pass	AV	2.4835G	49.47	54.00	-4.53	32.10	3	Horizontal	128	1.44	-
2480MHz_TX	Pass	PK	2.4802G	97.16	Inf	-Inf	32.10	3	Horizontal	128	1.44	-
2480MHz_TX	Pass	PK	2.4864G	59.75	74.00	-14.25	32.10	3	Horizontal	128	1.44	-
2480MHz_TX	Pass	AV	4.9615G	35.29	54.00	-18.71	8.53	3	Vertical	321	1.66	-
2480MHz_TX	Pass	AV	7.44714G	40.36	54.00	-13.64	14.36	3	Vertical	285	1.95	-
2480MHz_TX	Pass	PK	4.94662G	46.87	74.00	-27.13	8.47	3	Vertical	321	1.66	-
2480MHz_TX	Pass	PK	7.45128G	51.45	74.00	-22.55	14.38	3	Vertical	285	1.95	-
2480MHz_TX	Pass	AV	4.96438G	35.18	54.00	-18.82	8.55	3	Horizontal	38	2.03	-
2480MHz_TX	Pass	AV	7.45062G	40.51	54.00	-13.49	14.38	3	Horizontal	205	1.93	-
2480MHz_TX	Pass	PK	4.94554G	46.26	74.00	-27.74	8.47	3	Horizontal	38	2.03	-



RSE TX above 1GHz

Appendix F.2

Mode	Result	Type	Freq (Hz)	Level (dBuV/m)	Limit (dBuV/m)	Margin (dB)	Factor (dB)	Dist (m)	Condition	Azimuth (°)	Height (m)	Comments
2480MHz_TX	Pass	PK	7.44192G	51.17	74.00	-22.83	14.34	3	Horizontal	205	1.93	-

BT-LE(1Mbps)

24/05/2019

2402MHz_TX

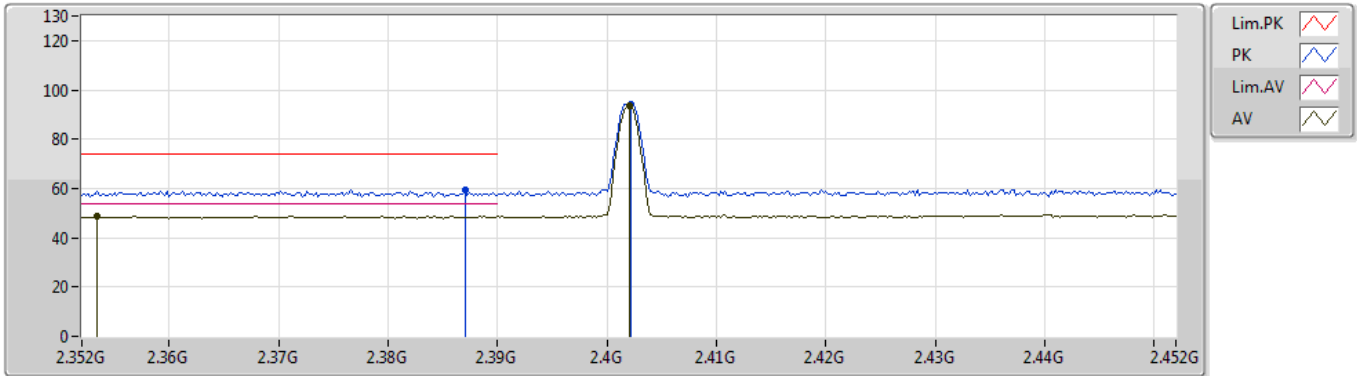

Type	Freq (Hz)	Level (dBuV/m)	Limit (dBuV/m)	Margin (dB)	Factor (dB)	Dist (m)	Condition	Azimuth (°)	Height (m)	Comment
AV	2.3534G	48.95	54.00	-5.05	32.32	3	Vertical	187	1.36	-
AV	2.402G	93.45	Inf	-Inf	32.20	3	Vertical	187	1.36	-
PK	2.387G	59.33	74.00	-14.67	32.23	3	Vertical	187	1.36	-
PK	2.4022G	94.10	Inf	-Inf	32.20	3	Vertical	187	1.36	-

BT-LE(1Mbps)

24/05/2019

2402MHz_TX

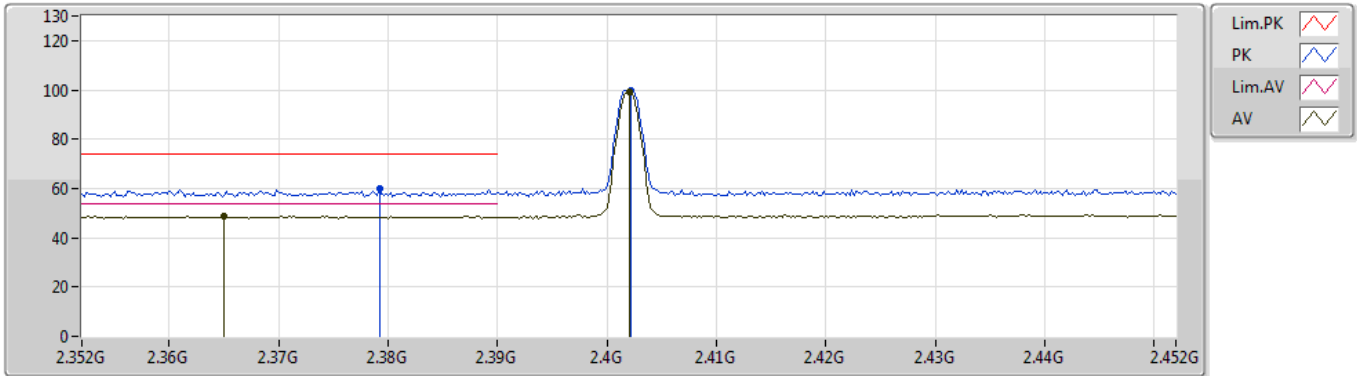

Type	Freq (Hz)	Level (dBuV/m)	Limit (dBuV/m)	Margin (dB)	Factor (dB)	Dist (m)	Condition	Azimuth (°)	Height (m)	Comment
AV	2.365G	48.87	54.00	-5.13	32.29	3	Horizontal	123	1.24	-
AV	2.402G	99.30	Inf	-Inf	32.20	3	Horizontal	123	1.24	-
PK	2.3792G	59.87	74.00	-14.13	32.25	3	Horizontal	123	1.24	-
PK	2.4022G	99.88	Inf	-Inf	32.20	3	Horizontal	123	1.24	-

BT-LE(1Mbps)

24/05/2019

2402MHz_TX

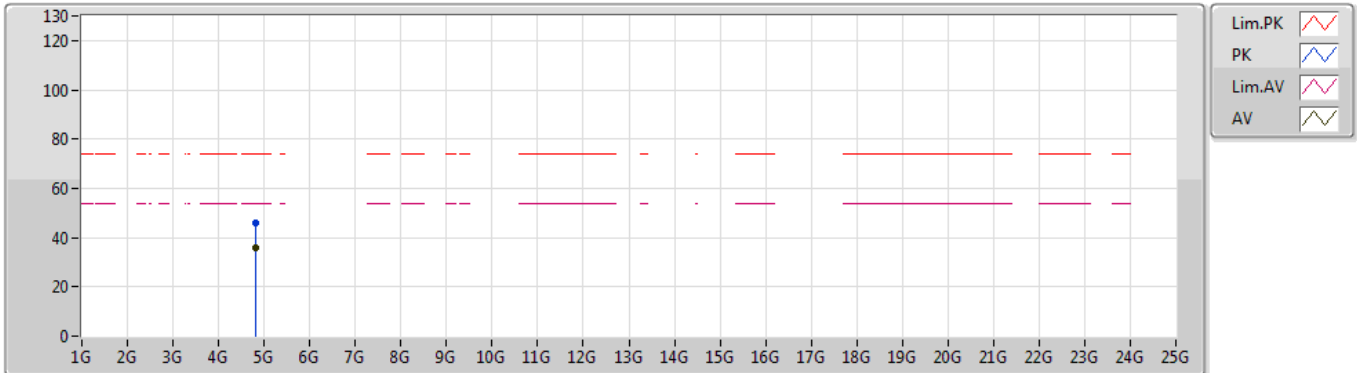

Type	Freq (Hz)	Level (dBuV/m)	Limit (dBuV/m)	Margin (dB)	Factor (dB)	Dist (m)	Condition	Azimuth (°)	Height (m)	Comment
AV	4.80004G	35.81	54.00	-18.19	8.12	3	Vertical	179	1.08	-
PK	4.81672G	46.06	74.00	-27.94	8.15	3	Vertical	179	1.08	-

BT-LE(1Mbps)

24/05/2019

2402MHz_TX

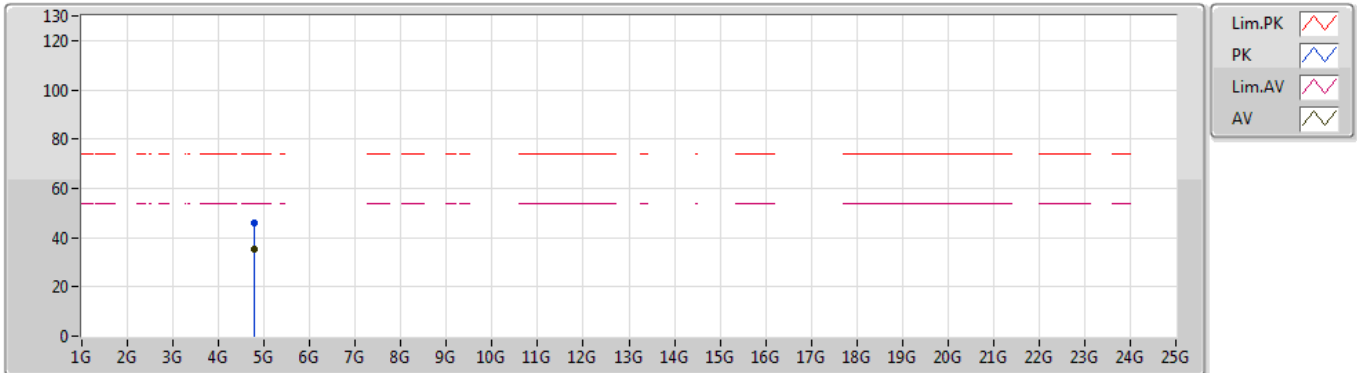

Type	Freq (Hz)	Level (dBuV/m)	Limit (dBuV/m)	Margin (dB)	Factor (dB)	Dist (m)	Condition	Azimuth (°)	Height (m)	Comment
AV	4.79452G	35.38	54.00	-18.62	8.12	3	Horizontal	228	1.50	-
PK	4.79578G	46.11	74.00	-27.89	8.12	3	Horizontal	228	1.50	-

BT-LE(1Mbps)

24/05/2019

2440MHz_TX

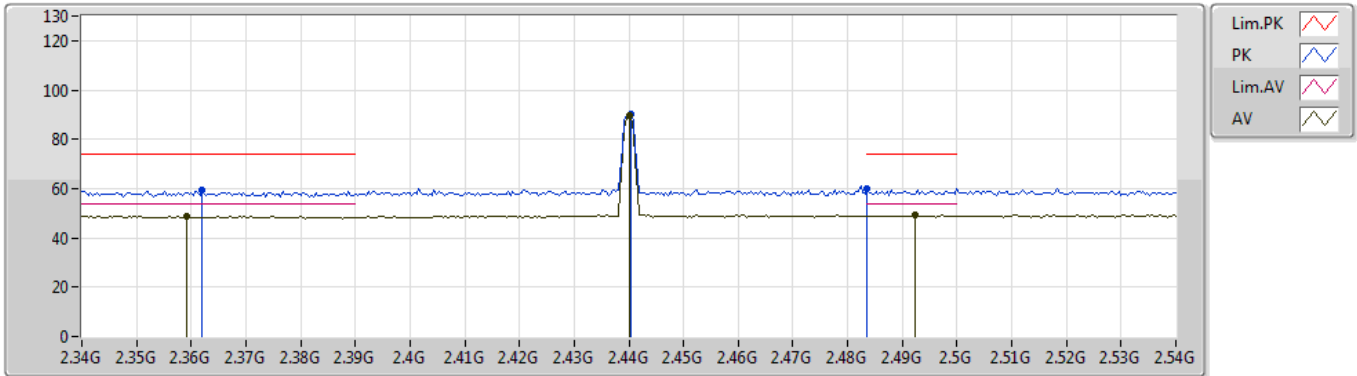

Type	Freq (Hz)	Level (dBuV/m)	Limit (dBuV/m)	Margin (dB)	Factor (dB)	Dist (m)	Condition	Azimuth (°)	Height (m)	Comment
AV	2.3592G	48.88	54.00	-5.12	32.30	3	Vertical	171	1.79	-
AV	2.44G	89.75	Inf	-Inf	32.15	3	Vertical	171	1.79	-
AV	2.4924G	49.21	54.00	-4.79	32.09	3	Vertical	171	1.79	-
PK	2.362G	59.16	74.00	-14.84	32.30	3	Vertical	171	1.79	-
PK	2.4404G	90.44	Inf	-Inf	32.15	3	Vertical	171	1.79	-
PK	2.4835G	59.97	74.00	-14.03	32.10	3	Vertical	171	1.79	-

BT-LE(1Mbps)

24/05/2019

2440MHz_TX

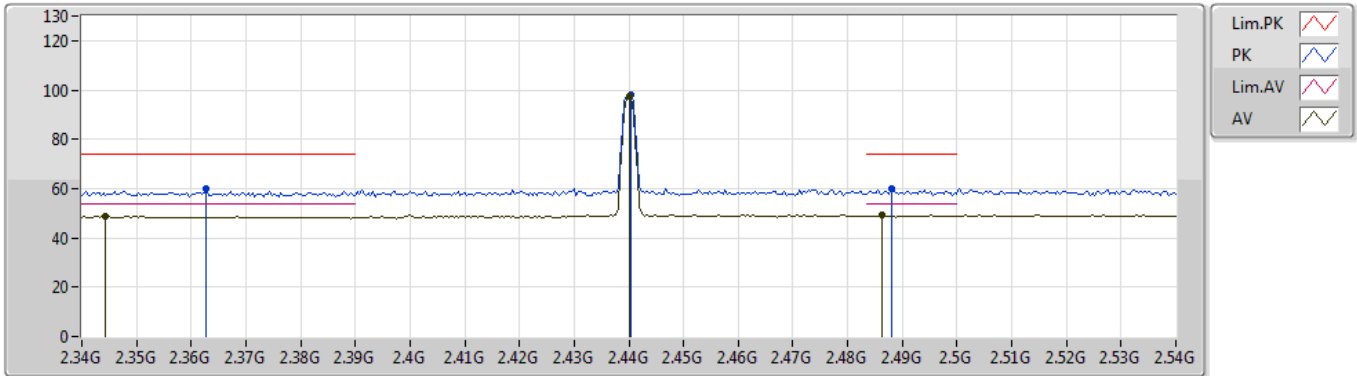

Type	Freq (Hz)	Level (dBuV/m)	Limit (dBuV/m)	Margin (dB)	Factor (dB)	Dist (m)	Condition	Azimuth (°)	Height (m)	Comment
AV	2.3444G	48.79	54.00	-5.21	32.34	3	Horizontal	128	1.26	-
AV	2.44G	97.53	Inf	-Inf	32.15	3	Horizontal	128	1.26	-
AV	2.4864G	49.22	54.00	-4.78	32.10	3	Horizontal	128	1.26	-
PK	2.3628G	59.72	74.00	-14.28	32.30	3	Horizontal	128	1.26	-
PK	2.4404G	98.14	Inf	-Inf	32.15	3	Horizontal	128	1.26	-
PK	2.488G	59.74	74.00	-14.26	32.09	3	Horizontal	128	1.26	-

BT-LE(1Mbps)

24/05/2019

2440MHz_TX

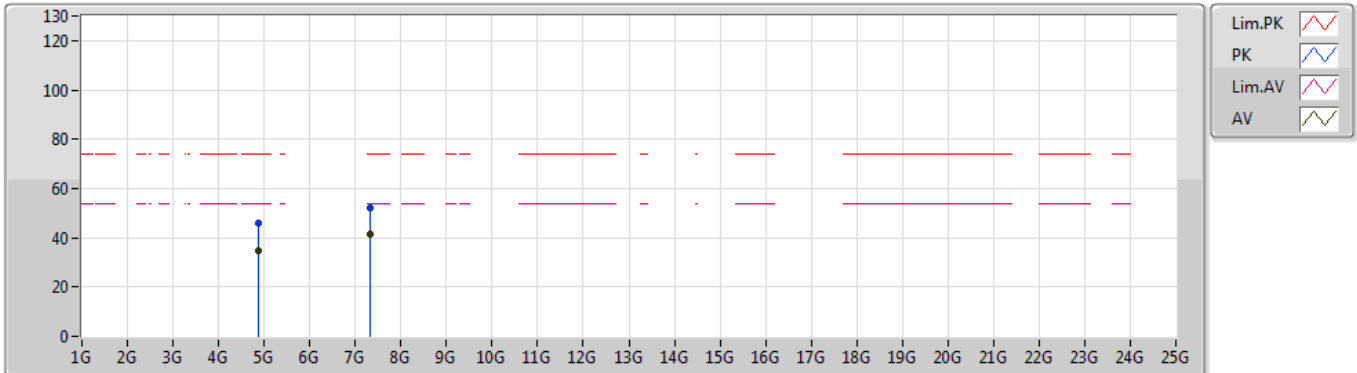

Type	Freq (Hz)	Level (dBuV/m)	Limit (dBuV/m)	Margin (dB)	Factor (dB)	Dist (m)	Condition	Azimuth (°)	Height (m)	Comment
AV	4.88156G	34.93	54.00	-19.07	8.27	3	Vertical	243	2.39	-
AV	7.32702G	41.21	54.00	-12.79	14.41	3	Vertical	136	1.50	-
PK	4.87094G	46.08	74.00	-27.92	8.25	3	Vertical	243	2.39	-
PK	7.3326G	52.25	74.00	-21.75	14.39	3	Vertical	136	1.50	-

BT-LE(1Mbps)

24/05/2019

2440MHz_TX

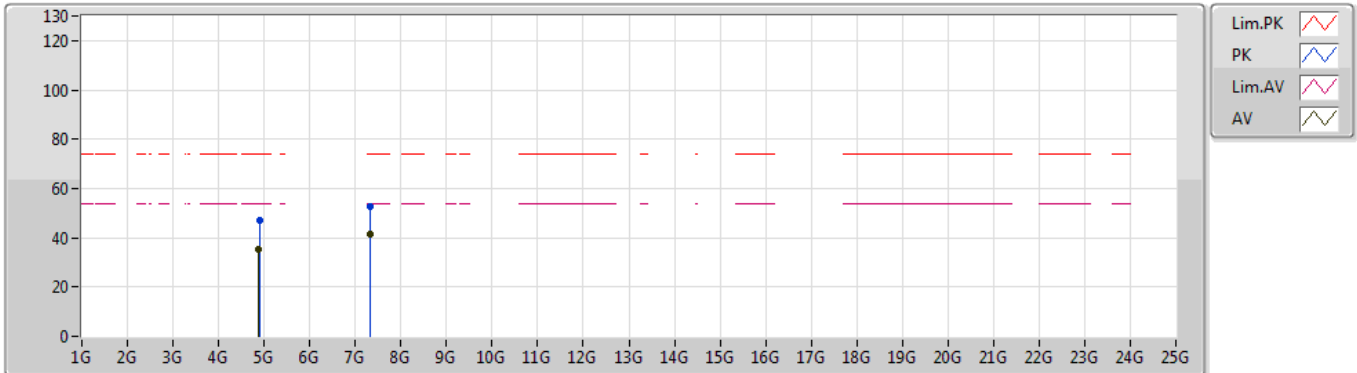

Type	Freq (Hz)	Level (dBuV/m)	Limit (dBuV/m)	Margin (dB)	Factor (dB)	Dist (m)	Condition	Azimuth (°)	Height (m)	Comment
AV	4.88228G	35.16	54.00	-18.84	8.27	3	Horizontal	83	1.50	-
AV	7.3302G	41.40	54.00	-12.60	14.41	3	Horizontal	165	2.90	-
PK	4.89464G	46.95	74.00	-27.05	8.29	3	Horizontal	83	1.50	-
PK	7.32084G	52.65	74.00	-21.35	14.43	3	Horizontal	165	2.90	-

BT-LE(1Mbps)

24/05/2019

2480MHz_TX

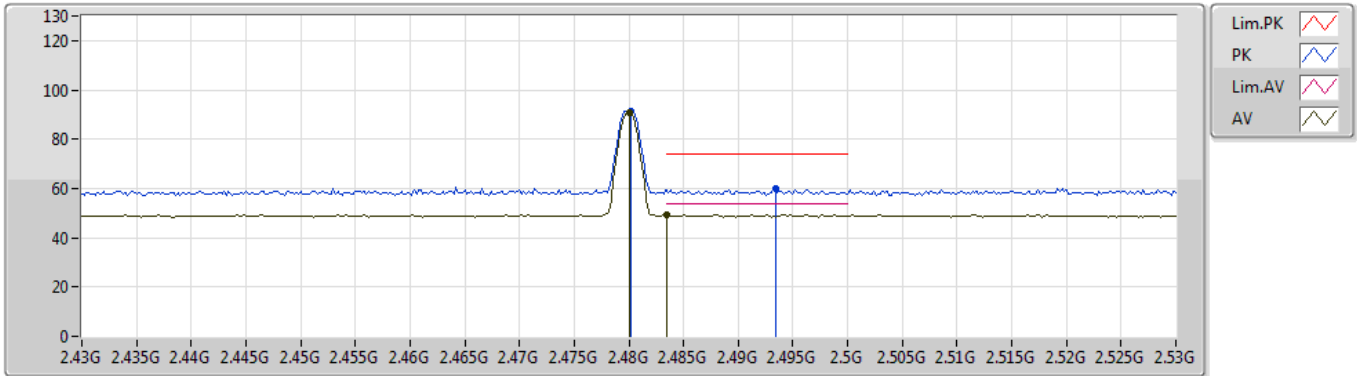

Type	Freq (Hz)	Level (dBuV/m)	Limit (dBuV/m)	Margin (dB)	Factor (dB)	Dist (m)	Condition	Azimuth (°)	Height (m)	Comment
AV	2.48G	90.66	Inf	-Inf	32.10	3	Vertical	144	2.71	-
AV	2.4835G	49.47	54.00	-4.53	32.10	3	Vertical	144	2.71	-
PK	2.4802G	91.32	Inf	-Inf	32.10	3	Vertical	144	2.71	-
PK	2.4934G	60.02	74.00	-13.98	32.08	3	Vertical	144	2.71	-

BT-LE(1Mbps)

24/05/2019

2480MHz_TX

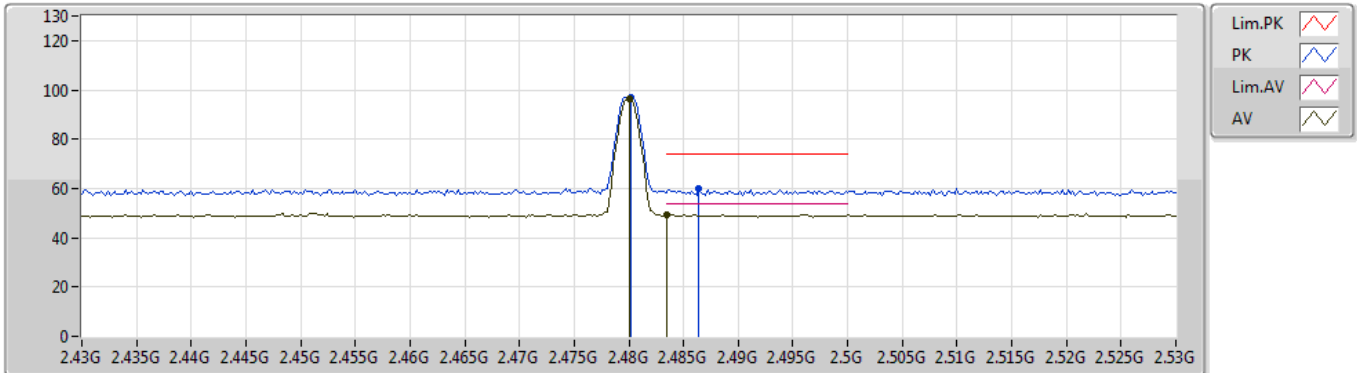

Type	Freq (Hz)	Level (dBuV/m)	Limit (dBuV/m)	Margin (dB)	Factor (dB)	Dist (m)	Condition	Azimuth (°)	Height (m)	Comment
AV	2.48G	96.51	Inf	-Inf	32.10	3	Horizontal	128	1.44	-
AV	2.4835G	49.47	54.00	-4.53	32.10	3	Horizontal	128	1.44	-
PK	2.4802G	97.16	Inf	-Inf	32.10	3	Horizontal	128	1.44	-
PK	2.4864G	59.75	74.00	-14.25	32.10	3	Horizontal	128	1.44	-

BT-LE(1Mbps)

24/05/2019

2480MHz_TX

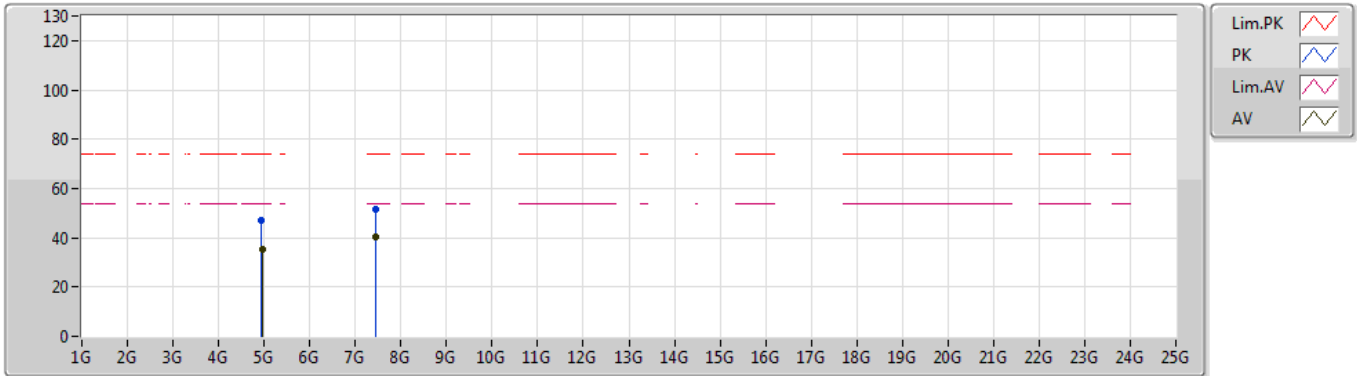

Type	Freq (Hz)	Level (dBuV/m)	Limit (dBuV/m)	Margin (dB)	Factor (dB)	Dist (m)	Condition	Azimuth (°)	Height (m)	Comment
AV	4.9615G	35.29	54.00	-18.71	8.53	3	Vertical	321	1.66	-
AV	7.44714G	40.36	54.00	-13.64	14.36	3	Vertical	285	1.95	-
PK	4.94662G	46.87	74.00	-27.13	8.47	3	Vertical	321	1.66	-
PK	7.45128G	51.45	74.00	-22.55	14.38	3	Vertical	285	1.95	-

BT-LE(1Mbps)

24/05/2019

2480MHz_TX

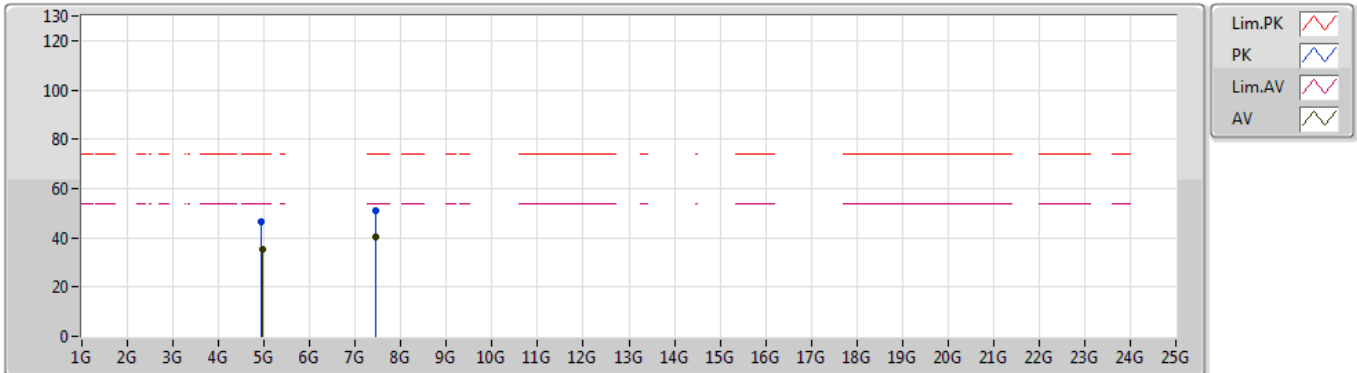

Type	Freq (Hz)	Level (dBuV/m)	Limit (dBuV/m)	Margin (dB)	Factor (dB)	Dist (m)	Condition	Azimuth (°)	Height (m)	Comment
AV	4.96438G	35.18	54.00	-18.82	8.55	3	Horizontal	38	2.03	-
AV	7.45062G	40.51	54.00	-13.49	14.38	3	Horizontal	205	1.93	-
PK	4.94554G	46.26	74.00	-27.74	8.47	3	Horizontal	38	2.03	-
PK	7.44192G	51.17	74.00	-22.83	14.34	3	Horizontal	205	1.93	-



Summary

Mode	Result	Type	Freq (Hz)	Level (dBuV/m)	Limit (dBuV/m)	Margin (dB)	Factor (dB)	Condition
Mode 1	Pass	AV	1.765G	37.78	54.00	-16.22	-1.83	Vertical
Mode 2	Pass	AV	2.503G	49.42	54.00	-4.58	1.71	Horizontal

Mode Configure

Mode	Configure
Mode 1	2.4G+BT
Mode 2	5G+BT

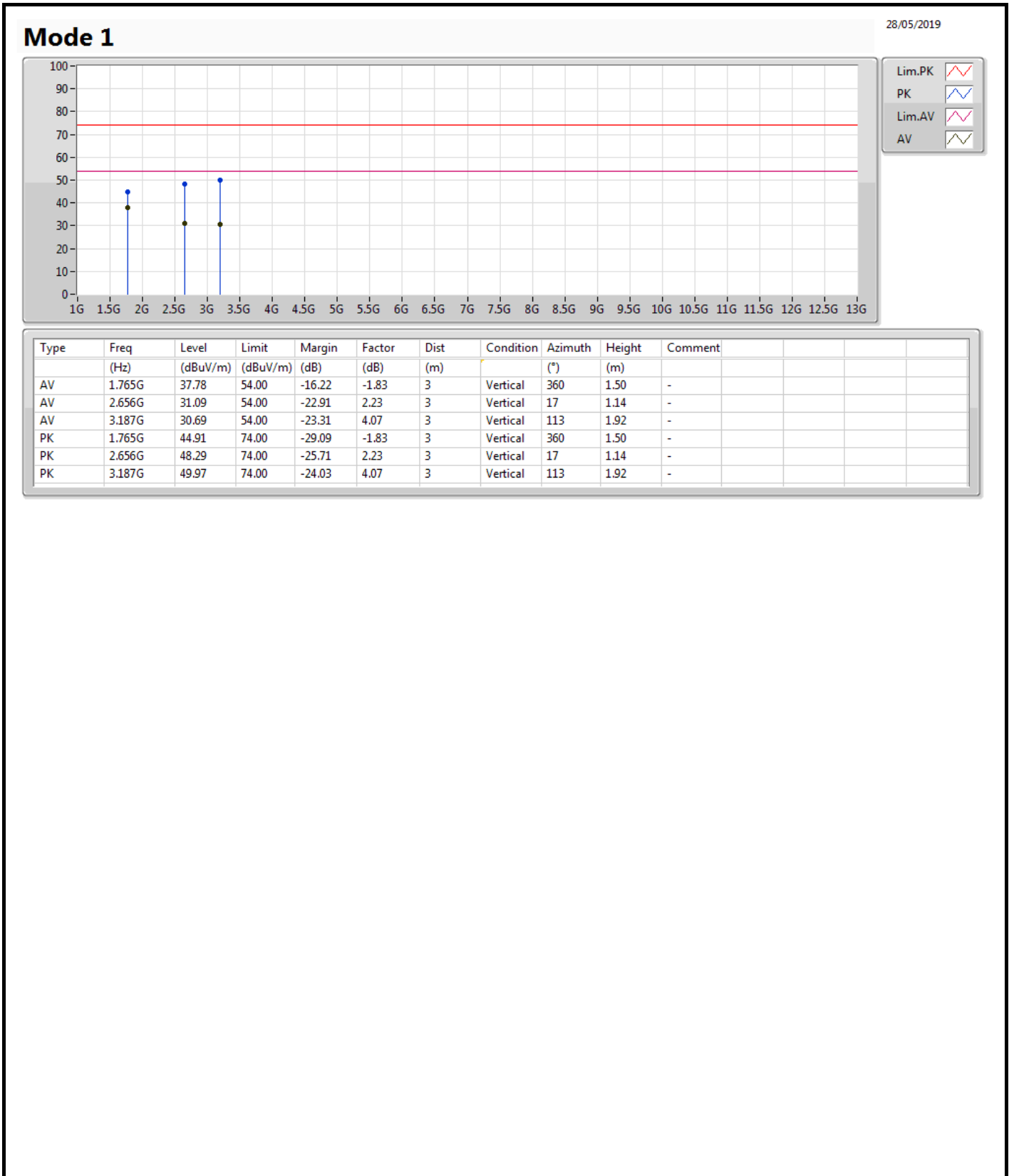

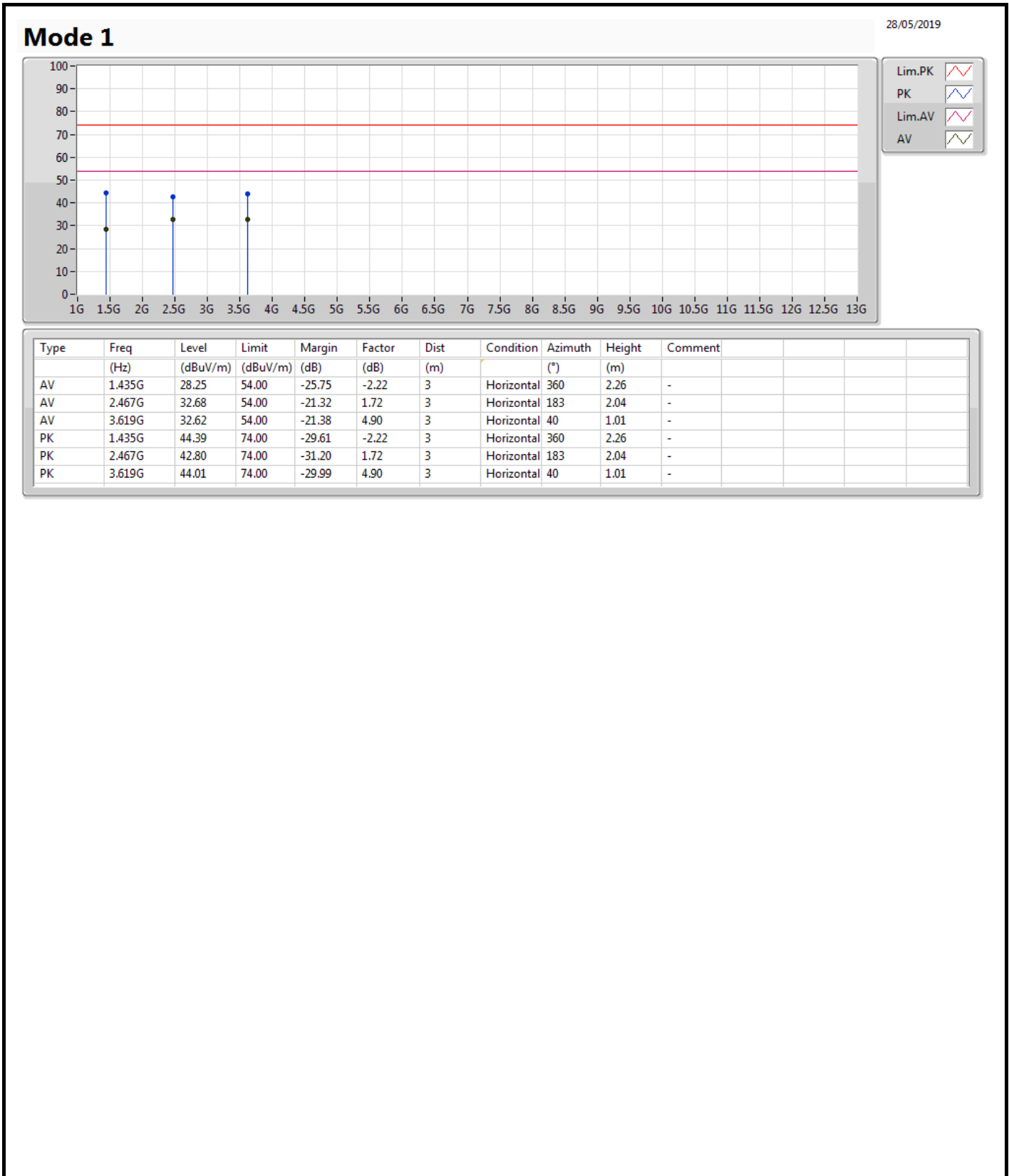



Mode 2

28/05/2019

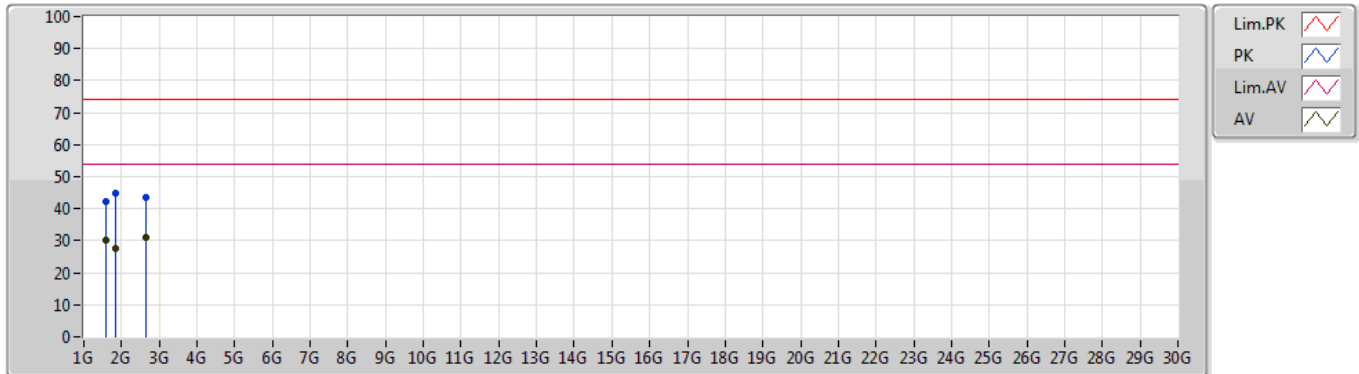

Type	Freq (Hz)	Level (dBuV/m)	Limit (dBuV/m)	Margin (dB)	Factor (dB)	Dist (m)	Condition	Azimuth (°)	Height (m)	Comment
AV	1.594G	30.19	54.00	-23.81	-2.29	3	Vertical	240	1.79	-
AV	1.855G	27.76	54.00	-26.24	-1.34	3	Vertical	70	1.18	-
AV	2.656G	31.03	54.00	-22.97	2.23	3	Vertical	358	1.20	-
PK	1.594G	42.34	74.00	-31.66	-2.29	3	Vertical	240	1.79	-
PK	1.855G	44.81	74.00	-29.19	-1.34	3	Vertical	70	1.18	-
PK	2.656G	43.57	74.00	-30.43	2.23	3	Vertical	358	1.20	-

