

FCC Test Report

Report No.: RFBERD-WTW-P20110669-3

FCC ID: COF-WMBACAT49

Test Model: WM-BAC-AT-49

Received Date: Nov. 21, 2020

Test Date: Dec. 04, 2020 ~ Dec. 19, 2020

Issued Date: Dec. 31, 2020

Applicant: Universal Global Scientific Industrial Co., Ltd.

Address: 141, Lane 351, Sec. 1, Taiping Road., Tsautuen, Nantou 54261, Taiwan

Issued By: Bureau Veritas Consumer Products Services (H.K.) Ltd., Taoyuan Branch
Lin Kou Laboratories

Lab Address: No. 47-2, 14th Ling, Chia Pau Vil., Lin Kou Dist., New Taipei City, Taiwan

Test Location: No.19, Hwa Ya 2nd Rd., Wen Hwa Vil., Kwei Shan Dist., Taoyuan City
33383, Taiwan

**FCC Registration /
Designation Number:** 788550 / TW0003



This report is for your exclusive use. Any copying or replication of this report to or for any other person or entity, or use of our name or trademark, is permitted only with our prior written permission. This report sets forth our findings solely with respect to the test samples identified herein. The results set forth in this report are not indicative or representative of the quality or characteristics of the lot from which a test sample was taken or any similar or identical product unless specifically and expressly noted. Our report includes all of the tests requested by you and the results thereof based upon the information that you provided to us. You have 60 days from date of issuance of this report to notify us of any material error or omission caused by our negligence, provided, however, that such notice shall be in writing and shall specifically address the issue you wish to raise. A failure to raise such issue within the prescribed time shall constitute your unqualified acceptance of the completeness of this report, the tests conducted and the correctness of the report contents. Unless specific mention, the uncertainty of measurement has been explicitly taken into account to declare the compliance or non-compliance to the specification.

Table of Contents

Release Control Record	4
1 Certificate of Conformity	5
2 Summary of Test Results.....	6
2.1 Measurement Uncertainty.....	6
2.2 Modification Record	6
3 General Information	7
3.1 General Description of EUT	7
3.2 Description of Test Modes.....	9
3.2.1 Test Mode Applicability and Tested Channel Detail.....	11
3.3 Duty Cycle of Test Signal	13
3.4 Description of Support Units	14
3.4.1 Configuration of System under Test	14
3.5 General Description of Applied Standards and References	14
4 Test Types and Results	15
4.1 Radiated Emission and Bandedge Measurement	15
4.1.1 Limits of Radiated Emission and Bandedge Measurement	15
4.1.2 Test Instruments	17
4.1.3 Test Procedures.....	18
4.1.4 Deviation from Test Standard	18
4.1.5 Test Setup.....	19
4.1.6 EUT Operating Conditions.....	20
4.1.7 Test Results	21
4.2 Conducted Emission Measurement.....	109
4.2.1 Limits of Conducted Emission Measurement	109
4.2.2 Test Instruments	109
4.2.3 Test Procedures.....	110
4.2.4 Deviation from Test Standard	110
4.2.5 Test Setup.....	110
4.2.6 EUT Operating Conditions.....	110
4.2.7 Test Results	111
4.3 Transmit Power Measurement.....	115
4.3.1 Limits of Transmit Power Measurement	115
4.3.2 Test Setup.....	115
4.3.3 Test Instruments	116
4.3.4 Test Procedure	116
4.3.5 Deviation from Test Standard	116
4.3.6 EUT Operating Conditions.....	116
4.3.7 Test Results	117
4.4 Occupied Bandwidth Measurement.....	136
4.4.1 Test Setup.....	136
4.4.2 Test Instruments	136
4.4.3 Test Procedure	136
4.4.4 Test Results	137
4.5 Peak Power Spectral Density Measurement	144
4.5.1 Limits of Peak Power Spectral Density Measurement	144
4.5.2 Test Setup.....	144
4.5.3 Test Instruments	144
4.5.4 Test Procedures.....	144
4.5.5 Deviation from Test Standard	145
4.5.6 EUT Operating Conditions.....	145
4.5.7 Test Results	146
4.6 Frequency Stability	153
4.6.1 Limit of Frequency Stability Measurement	153

4.6.2	Test Setup	153
4.6.3	Test Instruments	153
4.6.4	Test Procedure	153
4.6.5	Deviation from Test Standard	153
4.6.6	EUT Operating Condition	153
4.6.7	Test Results	154
4.7	6 dB Bandwidth Measurement.....	155
4.7.1	Limits of 6 dB Bandwidth Measurement.....	155
4.7.2	Test Setup.....	155
4.7.3	Test Instruments	155
4.7.4	Test Procedure	155
4.7.5	Deviation from Test Standard	155
4.7.6	EUT Operating Condition	155
4.7.7	Test Results	156
5	Pictures of Test Arrangements.....	159
	Annex A- Radiated Out of Band Emission (OOBE) Measurement (For U-NII-3 band)	160
	Annex B- Band Edge Measurement.....	166
	Appendix – Information of the Testing Laboratories	188

Release Control Record

Issue No.	Description	Date Issued
RFBERD-WTW-P20110669-3	Original Release	Dec. 31, 2020

2 Summary of Test Results

47 CFR FCC Part 15, Subpart E (Section 15.407)			
FCC Clause	Test Item	Result	Remarks
15.407(b)(6)	AC Power Conducted Emissions	Pass	Meet the requirement of limit. Minimum passing margin is -5.34 dB at 0.15000 MHz.
15.407(b) (1/2/3/4(i/ii)/6)	Radiated Emissions & Band Edge Measurement	Pass	Meet the requirement of limit. Minimum passing margin is -1.6 dB at 5150.00 MHz, 5470.00 MHz.
15.407(a)(1/2/3)	Max Average Transmit Power	Pass	Meet the requirement of limit.
---	Occupied Bandwidth Measurement	-	Reference only
15.407(a)(1/2/3)	Peak Power Spectral Density	Pass	Meet the requirement of limit.
15.407(e)	6 dB Bandwidth	Pass	Meet the requirement of limit. (U-NII-3 Band only)
15.407(g)	Frequency Stability	Pass	Meet the requirement of limit.
15.203	Antenna Requirement	Pass	Antenna connector is i-pex(MHF).

Note:

- For U-NII-3 band compliance with rule part 15.407(b)(4)(i), the OOB test plots were recorded in Annex A.
- For U-NII-1, U-NII-2A, U-NII-2C band compliance with rule 15.407(b) of the band-edge items, the test plots were recorded in Annex B. Test Procedures refer to report 4.1.3.
- Determining compliance based on the results of the compliance measurement, not taking into account measurement instrumentation uncertainty.

2.1 Measurement Uncertainty

Where relevant, the following measurement uncertainty levels have been estimated for tests performed on the EUT as specified in CISPR 16-4-2:

Measurement	Frequency	Expanded Uncertainty (k=2) (\pm)
Conducted Emissions at mains ports	150 kHz ~ 30 MHz	2.79 dB
Radiated Emissions up to 1 GHz	9 kHz ~ 30 MHz	3.04 dB
	30 MHz ~ 200 MHz	2.93 dB
	200 MHz ~ 1000 MHz	2.95 dB
Radiated Emissions above 1 GHz	1 GHz ~ 18 GHz	2.26 dB
	18 GHz ~ 40 GHz	1.94 dB

2.2 Modification Record

There were no modifications required for compliance.

3 General Information

3.1 General Description of EUT

Product	802.11a/b/g/n/ac 2x2 MIMO + BT 5.1 Combo Module
Brand	USI
Test Model	WM-BAC-AT-49
Status of EUT	Engineering Sample
Power Supply Rating	3.6 Vdc (Power Supply) 5 Vdc (host equipment)
Modulation Type	256QAM, 64QAM, 16QAM, QPSK, BPSK
Modulation Technology	OFDM
Transfer Rate	802.11a: 54.0/ 48.0/ 36.0/ 24.0/ 18.0/ 12.0/ 9.0/ 6.0 Mbps 802.11n: up to 300.0 Mbps 802.11ac: up to 866.7 Mbps
Operating Frequency	5180 ~ 5240 MHz, 5260 ~ 5320 MHz, 5500 ~ 5720 MHz, 5745 ~ 5825 MHz
Number of Channel	5180 ~ 5240 MHz: 4 for 802.11a, 802.11n (HT20), 802.11ac (VHT20) 2 for 802.11n (HT40), 802.11ac (VHT40) 1 for 802.11ac (VHT80) 5260 ~ 5320 MHz: 4 for 802.11a, 802.11n (HT20), 802.11ac (VHT20) 2 for 802.11n (HT40), 802.11ac (VHT40) 1 for 802.11ac (VHT80) 5500 ~ 5720 MHz: 12 for 802.11a, 802.11n (HT20), 802.11ac (VHT20) 6 for 802.11n (HT40), 802.11ac (VHT40) 3 for 802.11ac (VHT80) 5745 ~ 5825 MHz: 5 for 802.11a, 802.11n (HT20), 802.11ac (VHT20) 2 for 802.11n (HT40), 802.11ac (VHT40) 1 for 802.11ac (VHT80)
Output Power	<WLAN Ant. A> 49.494 mW for 5180 ~ 5240 MHz (16.95 dBm) 49.268 mW for 5260 ~ 5320 MHz (16.93 dBm) 48.829 mW for 5500 ~ 5720 MHz (16.89 dBm) 49.208 mW for 5745 ~ 5825 MHz (16.92 dBm) <WLAN Ant. B> 49.494 mW for 5180 ~ 5240 MHz (16.95 dBm) 49.268 mW for 5260 ~ 5320 MHz (16.93 dBm) 48.829 mW for 5500 ~ 5720 MHz (16.89 dBm) 49.208 mW for 5745 ~ 5825 MHz (16.92 dBm)
Antenna Type	Refer to Note as below
Antenna Connector	i-pex(MHF)
Accessory Device	N/A
Data Cable Supplied	N/A

Note:

1. The EUT incorporates a MIMO function. Physically, the EUT provides two completed transmitters and two receivers.

Modulation Mode	Tx Function
802.11a	2TX
802.11n (HT20)	2TX
802.11n (HT40)	2TX
802.11ac (VHT20)	2TX
802.11ac (VHT40)	2TX
802.11ac (VHT80)	2TX

* The modulation and bandwidth are similar for 802.11n mode for HT20 / HT40 and 802.11ac mode for VHT20 / VHT40, therefore investigated worst case to representative mode in test report. (Final test mode refer section 3.2.1)

2. The antenna information is listed as below.

WLAN Antenna	Antenna Type	Cable Length	Gain (dBi)			
			5180 ~ 5240 MHz	5260 ~ 5320 MHz	5500 ~ 5720 MHz	5745 ~ 5825 MHz
A	PCB	150mm	1.11	1.11	0.68	0.5
		1280mm	-4.18	-4.18	-4.77	-5.08
B	Dipole	60mm	2.67	2.27	2.07	1.78
		700mm	0.11	-0.32	-0.54	-0.94

3. The above Antenna information is declared by manufacturer and for more detailed features description, please refer to the manufacturer's specifications, the laboratory shall not be held responsible.
4. The above EUT information is declared by manufacturer and for more detailed features description, please refers to the manufacturer's specifications or user's manual.
5. The product WiFi 2.4G and WiFi 5G will not simultaneous transmissions , but 2.4G + BT & 5G + BT can operate at the simultaneous transmissions. The emission of the simultaneous operation has been evaluated and no non-compliance was found.

3.2 Description of Test Modes

For 5180 ~ 5240 MHz

4 channels are provided for 802.11a, 802.11n (HT20), 802.11ac (VHT20):

Channel	Frequency (MHz)	Channel	Frequency (MHz)
36	5180	44	5220
40	5200	48	5240

2 channels are provided for 802.11n (HT40), 802.11ac (VHT40):

Channel	Frequency (MHz)	Channel	Frequency (MHz)
38	5190	46	5230

1 channel is provided for 802.11ac (VHT80):

Channel	Frequency (MHz)
42	5210

For 5260 ~ 5320 MHz

4 channels are provided for 802.11a, 802.11n (HT20), 802.11ac (VHT20):

Channel	Frequency (MHz)	Channel	Frequency (MHz)
52	5260	60	5300
56	5280	64	5320

2 channels are provided for 802.11n (HT40), 802.11ac (VHT40):

Channel	Frequency (MHz)	Channel	Frequency (MHz)
54	5270	62	5310

1 channel is provided for 802.11ac (VHT80):

Channel	Frequency (MHz)
58	5290

For 5500 ~ 5720 MHz

12 channels are provided for 802.11a, 802.11n (HT20), 802.11ac (VHT20):

Channel	Frequency (MHz)	Channel	Frequency (MHz)
100	5500	124	5620
104	5520	128	5640
108	5540	132	5660
112	5560	136	5680
116	5580	140	5700
120	5600	144	5720

6 channels are provided for 802.11n (HT40), 802.11ac (VHT40):

Channel	Frequency (MHz)	Channel	Frequency (MHz)
102	5510	126	5630
110	5550	134	5670
118	5590	142	5710

3 channels are provided for 802.11ac (VHT80):

Channel	Frequency (MHz)	Channel	Frequency (MHz)
106	5530	138	5690
122	5610		

For 5745 ~ 5825 MHz:

5 channels are provided for 802.11a, 802.11n (HT20), 802.11ac (VHT20):

Channel	Frequency (MHz)	Channel	Frequency (MHz)
149	5745	161	5805
153	5765	165	5825
157	5785		

2 channels are provided for 802.11n (HT40), 802.11ac (VHT40):

Channel	Frequency (MHz)	Channel	Frequency (MHz)
151	5755	159	5795

1 channel is provided for 802.11ac (VHT80):

Channel	Frequency (MHz)
155	5775

3.2.1 Test Mode Applicability and Tested Channel Detail

EUT Configure Mode	Applicable To				Description
	RE≥1G	RE<1G	PLC	APCM	
A	√	√	√	√	WLAN Ant. A (PCB Antenna)
B	√	√	√	√	WLAN Ant. B (Dipole Antenna)

Where **RE≥1G**: Radiated Emission above 1 GHz **RE<1G**: Radiated Emission below 1 GHz
PLC: Power Line Conducted Emission **APCM**: Antenna Port Conducted Measurement

Note:

1. The EUT had been pre-tested on the positioned of each 3 axis. The worst case was found when positioned on **Z-plane**.
2. “-” means no effect.

Radiated Emission Test (Above 1 GHz):

- Pre-Scan has been conducted to determine the worst-case mode from all possible combinations between available modulations, data rates and antenna ports (if EUT with antenna diversity architecture).
- Following channel(s) was (were) selected for the final test as listed below.

EUT Configure Mode	Frequency Band (MHz)	Mode	Available Channel	Tested Channel	Modulation Technology	Modulation Type	Data Rate (Mbps)
A, B	5180-5240	802.11a	36 to 48	36, 40, 48	OFDM	BPSK	6.0
A, B		802.11ac (VHT20)	36 to 48	36, 40, 48	OFDM	BPSK	7.2
A, B		802.11ac (VHT40)	38 to 46	38, 46	OFDM	BPSK	15.0
A, B		802.11ac (VHT80)	42	42	OFDM	BPSK	29.3
A, B	5260-5320	802.11a	52 to 64	52, 60, 64	OFDM	BPSK	6.0
A, B		802.11ac (VHT20)	52 to 64	52, 60, 64	OFDM	BPSK	7.2
A, B		802.11ac (VHT40)	54 to 62	54, 62	OFDM	BPSK	15.0
A, B		802.11ac (VHT80)	58	58	OFDM	BPSK	29.3
A, B	5500-5720	802.11a	100 to 144	100, 116, 140, 144	OFDM	BPSK	6.0
A, B		802.11ac (VHT20)	100 to 144	100, 116, 140, 144	OFDM	BPSK	7.2
A, B		802.11ac (VHT40)	102 to 142	102, 110, 134	OFDM	BPSK	15.0
A, B		802.11ac (VHT80)	106 to 138	106, 122	OFDM	BPSK	29.3
A, B	5745-5825	802.11a	149 to 165	149, 157, 165	OFDM	BPSK	6.0
A, B		802.11ac (VHT20)	149 to 165	149, 157, 165	OFDM	BPSK	7.2
A, B		802.11ac (VHT40)	151 to 159	151, 159	OFDM	BPSK	15.0
A, B		802.11ac (VHT80)	155	155	OFDM	BPSK	29.3

Radiated Emission Test (Below 1 GHz):

- Pre-Scan has been conducted to determine the worst-case mode from all possible combinations between available modulations, data rates and antenna ports (if EUT with antenna diversity architecture).
- Following channel(s) was (were) selected for the final test as listed below.

EUT Configure Mode	Frequency Band (MHz)	Mode	Available Channel	Tested Channel	Modulation Technology	Modulation Type	Data Rate (Mbps)
A, B	5180-5240	802.11ac (VHT80)	42	42	OFDM	BPSK	29.3

Power Line Conducted Emission Test:

- Pre-Scan has been conducted to determine the worst-case mode from all possible combinations between available modulations, data rates and antenna ports (if EUT with antenna diversity architecture).
- Following channel(s) was (were) selected for the final test as listed below.

EUT Configure Mode	Frequency Band (MHz)	Mode	Available Channel	Tested Channel	Modulation Technology	Modulation Type	Data Rate (Mbps)
A, B	5180-5240	802.11ac (VHT80)	42	42	OFDM	BPSK	29.3

Antenna Port Conducted Measurement:

- This item includes all test value of each mode, but only includes spectrum plot of worst value of each mode.
- Pre-Scan has been conducted to determine the worst-case mode from all possible combinations between available modulations, data rates and antenna ports (if EUT with antenna diversity architecture).
- Following channel(s) was (were) selected for the final test as listed below.

EUT Configure Mode	Frequency Band (MHz)	Mode	Available Channel	Tested Channel	Modulation Technology	Modulation Type	Data Rate (Mbps)
A, B	5180-5240	802.11a	36 to 48	36, 40, 48	OFDM	BPSK	6.0
A, B		802.11ac (VHT20)	36 to 48	36, 40, 48	OFDM	BPSK	7.2
A, B		802.11ac (VHT40)	38 to 46	38, 46	OFDM	BPSK	15.0
A, B		802.11ac (VHT80)	42	42	OFDM	BPSK	29.3
A, B	5260-5320	802.11a	52 to 64	52, 60, 64	OFDM	BPSK	6.0
A, B		802.11ac (VHT20)	52 to 64	52, 60, 64	OFDM	BPSK	7.2
A, B		802.11ac (VHT40)	54 to 62	54, 62	OFDM	BPSK	15.0
A, B		802.11ac (VHT80)	58	58	OFDM	BPSK	29.3
A, B	5500-5720	802.11a	100 to 144	100, 116, 140, 144	OFDM	BPSK	6.0
A, B		802.11ac (VHT20)	100 to 144	100, 116, 140, 144	OFDM	BPSK	7.2
A, B		802.11ac (VHT40)	102 to 142	102, 110, 134	OFDM	BPSK	15.0
A, B		802.11ac (VHT80)	106 to 138	106, 122	OFDM	BPSK	29.3
A, B	5745-5825	802.11a	149 to 165	149, 157, 165	OFDM	BPSK	6.0
A, B		802.11ac (VHT20)	149 to 165	149, 157, 165	OFDM	BPSK	7.2
A, B		802.11ac (VHT40)	151 to 159	151, 159	OFDM	BPSK	15.0
A, B		802.11ac (VHT80)	155	155	OFDM	BPSK	29.3

Test Condition:

Applicable To	Environmental Conditions	Input Power	Tested by
RE \geq 1G	22 deg. C, 70 % RH	120 Vac, 60 Hz	Adair Peng
RE $<$ 1G	23 deg. C, 67 % RH	120 Vac, 60 Hz	Adair Peng
PLC	24 deg. C, 70 % RH	120 Vac, 60 Hz	Willy Cheng
APCM	23 deg. C, 66 % RH	3.6 Vdc	Vincent Huang

3.3 Duty Cycle of Test Signal

MODULATION TYPE: BPSK

Duty cycle of test signal is < 98 %, duty factor is required.

802.11a: Duty cycle = $2.027/2.215 = 0.915$, Duty factor = $10 * \log(1/0.915) = 0.39$

802.11ac (VHT20): Duty cycle = $1.886/2.066 = 0.913$, Duty factor = $10 * \log(1/0.913) = 0.40$

802.11ac (VHT40): Duty cycle = $0.925/1.111 = 0.833$, Duty factor = $10 * \log(1/0.833) = 0.80$

802.11ac (VHT80): Duty cycle = $0.454/0.670 = 0.678$, Duty factor = $10 * \log(1/0.678) = 1.69$

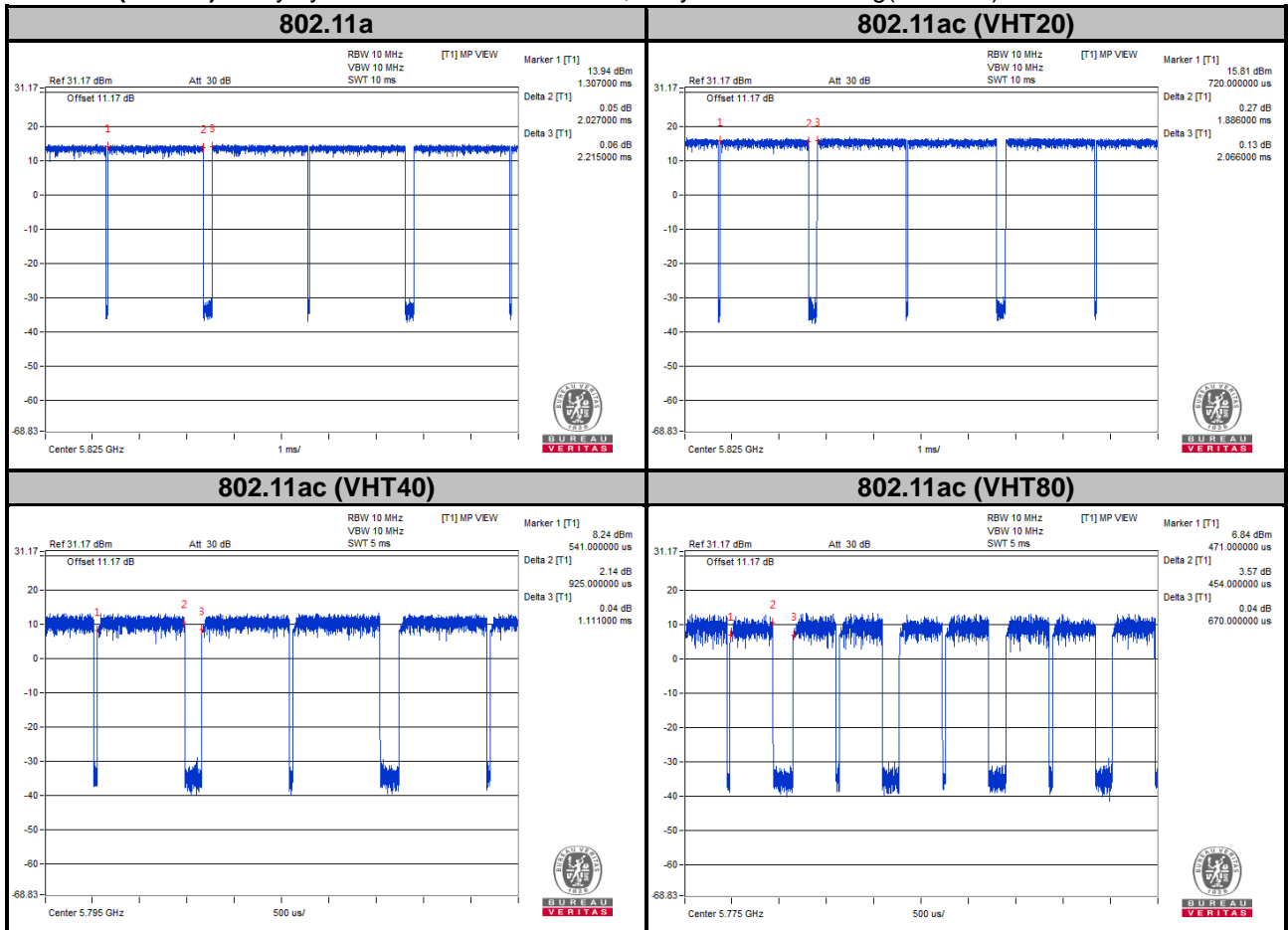

3.4 Description of Support Units

The EUT has been tested as an independent unit together with other necessary accessories or support units. The following support units or accessories were used to form a representative test configuration during the tests.

ID	Product	Brand	Model No.	Serial No.	FCC ID	Remarks
A	Notebook	Acer	TMP238-G2-M-56S6	NA	NA	Provided by client

Note:

- All power cords of the above support units are non-shielded (1.8m).

ID	Descriptions	Qty.	Length (m)	Shielding (Yes/No)	Cores (Qty.)	Remarks
1.	Micro USB Cable	1	1	N	1	Provided by client
2.	Micro USB Cable	1	1.5	N	0	-

3.4.1 Configuration of System under Test

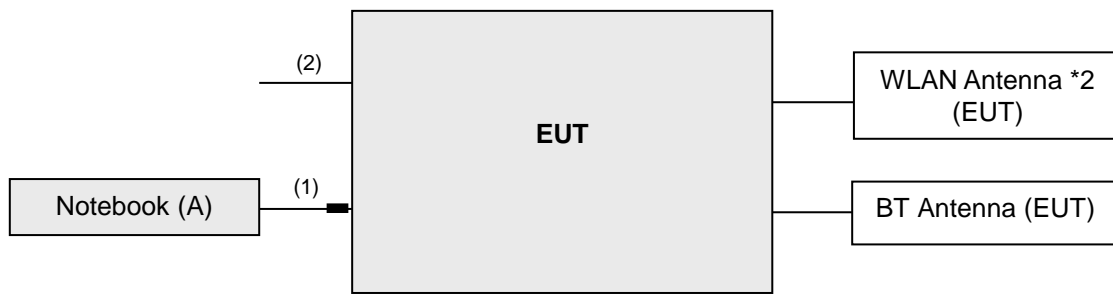

Remote site

3.5 General Description of Applied Standards and References

The EUT is a RF Product. According to the specifications of the manufacturer, it must comply with the requirements of the following standards and references:

Test Standard:

FCC Part 15, Subpart E (15.407)

ANSI C63.10-2013

All test items have been performed and recorded as per the above standards.

References Test Guidance:

KDB 789033 D02 General UNII Test Procedures New Rules v02r01

KDB 662911 D01 Multiple Transmitter Output v02r01

All test items have been performed as a reference to the above KDB test guidance.

4 Test Types and Results

4.1 Radiated Emission and Bandedge Measurement

4.1.1 Limits of Radiated Emission and Bandedge Measurement

Radiated emissions which fall in the restricted bands must comply with the radiated emission limits specified as below table.

Frequencies (MHz)	Field Strength (microvolts/meter)	Measurement Distance (meters)
0.009 ~ 0.490	2400/F (kHz)	300
0.490 ~ 1.705	24000/F (kHz)	30
1.705 ~ 30.0	30	30
30 ~ 88	100	3
88 ~ 216	150	3
216 ~ 960	200	3
Above 960	500	3

Note:

1. The lower limit shall apply at the transition frequencies.
2. Emission level (dBuV/m) = 20 log Emission level (uV/m).
3. For frequencies above 1000 MHz, the field strength limits are based on average detector, however, the peak field strength of any emission shall not exceed the maximum permitted average limits, specified above by more than 20 dB under any condition of modulation.

Limits of Unwanted Emission Out of the Restricted Bands

Applicable To		Limit	
789033 D02 General UNII Test Procedures New Rules v02r01		Field Strength at 3 m	
		PK: 74 (dBµV/m)	AV: 54 (dBµV/m)
Frequency Band	Applicable To	EIRP Limit	Equivalent Field Strength at 3 m
5150~5250 MHz	15.407(b)(1)	PK: -27 (dBm/MHz)	PK: 68.2 (dBµV/m)
5250~5350 MHz	15.407(b)(2)		
5470~5725 MHz	15.407(b)(3)		
5725~5850 MHz	<input checked="" type="checkbox"/> 15.407(b)(4)(i)	PK:-27 (dBm/MHz) ^{*1} PK:10 (dBm/MHz) ^{*2} PK:15.6 (dBm/MHz) ^{*3} PK:27 (dBm/MHz) ^{*4}	PK: 68.2 (dBµV/m) ^{*1} PK:105.2 (dBµV/m) ^{*2} PK: 110.8 (dBµV/m) ^{*3} PK:122.2 (dBµV/m) ^{*4}
	<input type="checkbox"/> 15.407(b)(4)(ii)	Emission limits in section 15.247(d)	
^{*1} beyond 75 MHz or more above of the band edge. ^{*2} below the band edge increasing linearly to 10 dBm/MHz at 25 MHz above. ^{*3} below the band edge increasing linearly to a level of 15.6 dBm/MHz at 5 MHz above. ^{*4} from 5 MHz above or below the band edge increasing linearly to a level of 27 dBm/MHz at the band edge.			

Note:

The following formula is used to convert the equipment isotropic radiated power (eirp) to field strength:

$$E = \frac{1000000\sqrt{30P}}{3} \quad \mu\text{V/m, where } P \text{ is the eirp (Watts).}$$

4.1.2 Test Instruments

Description & Manufacturer	Model No.	Serial No.	Date of Calibration	Due Date of Calibration
Test Receiver ROHDE & SCHWARZ	ESR3	102579	Jul. 07, 2020	Jul. 06, 2021
Spectrum Analyzer ROHDE & SCHWARZ	FSP40	100269	Jun. 09, 2020	Jun. 08, 2021
Spectrum Analyzer ROHDE & SCHWARZ	FSV40	100979	Mar. 18, 2020	Mar. 17, 2021
BILOG Antenna SCHWARZBECK	VULB9168	9168-171	Nov. 04, 2020	Nov. 03, 2021
HORN Antenna SCHWARZBECK	9120D	209	Nov. 22, 2020	Nov. 21, 2021
HORN Antenna SCHWARZBECK	BBHA 9170	BBHA9170241	Nov. 22, 2020	Nov. 21, 2021
Loop Antenna EMCI	EM-6879	269	Sep. 17, 2020	Sep. 16, 2021
Preamplifier Agilent (Below 1GHz)	8447D	2944A10738	Aug. 16, 2020	Aug. 15, 2021
Preamplifier Agilent (Above 1GHz)	8449B	3008A02465	Mar. 23, 2020	Mar. 22, 2021
RF Coaxial Cable WOKEN With 5dB PAD	8D-FB	Cable-CH3-01	Aug. 16, 2020	Aug. 15, 2021
RF signal cable HUBER+SUHNER	SUCOFLEX 104	Cable-CH3-03 (223653/4)	Aug. 16, 2020	Aug. 15, 2021
RF signal cable HUBER+SUHNER& EMCI	SUCOFLEX 104&EMC104-SM- SM-8000	Cable-CH3-03 (309224+170907)	Aug. 16, 2020	Aug. 15, 2021
Software BV ADT	ADT_Radiated_ V7.6.15.9.5	NA	NA	NA
Antenna Tower inn-co GmbH	MA 4000	013303	NA	NA
Antenna Tower Controller BV ADT	AT100	AT93021702	NA	NA
Turn Table BV ADT	TT100	TT93021702	NA	NA
Turn Table Controller BV ADT	SC100	SC93021702	NA	NA
Boresight Antenna Fixture	FBA-01	FBA-SIP01	NA	NA
Pre-amplifier (18GHz- 40GHz) EMC	EMC184045B	980175	Sep. 04, 2020	Sep. 03, 2021
USB Wideband Power Sensor KEYSIGHT	U2021XA	MY55050005/MY55 190004/MY551900 07/MY55210005	Jul. 13, 2020	Jul. 12, 2021
Temperature & Humidity Chamber GIANT FORCE	GTH-120-40-CP- AR	MAA1306-01	Sep. 09, 2020	Sep. 08, 2021
DC power supply Keysight	U8002A	MY56330015	NA	NA
Digital Multimeter Fluke	87-III	70360742	Jun. 23, 2020	Jun. 22, 2021

Note: 1. The calibration interval of the above test instruments is 12 months and the calibrations are traceable to NML/ROC and NIST/USA.

2. The test was performed in HwaYa Chamber 3.

4.1.3 Test Procedures

For Radiated Emission below 30 MHz

- a. The EUT was placed on the top of a rotating table 0.8 meters above the ground at a 3 meter chamber room. The table was rotated 360 degrees to determine the position of the highest radiation.
- b. The EUT was set 3 meters away from the interference-receiving antenna, which was mounted on the top of a variable-height antenna tower.
- c. Parallel, perpendicular, and ground-parallel orientations of the antenna are set to make the measurement.
- d. For each suspected emission, the EUT was arranged to its worst case and the rotatable table was turned from 0 degrees to 360 degrees to find the maximum reading.
- e. The test-receiver system was set to Quasi-Peak Detect Function and Specified Bandwidth with Maximum Hold Mode.

Note:

1. The resolution bandwidth and video bandwidth of test receiver/spectrum analyzer is 9 kHz at frequency below 30 MHz.

For Radiated Emission above 30 MHz

- a. The EUT was placed on the top of a rotating table 0.8 meters (for 30 MHz ~ 1 GHz) / 1.5 meters (for above 1 GHz) above the ground at 3 meter chamber room for test. The table was rotated 360 degrees to determine the position of the highest radiation.
- b. The EUT was set 3 meters away from the interference-receiving antenna, which was mounted on the top of a variable-height antenna tower.
- c. The height of antenna is varied from one meter to four meters above the ground to determine the maximum value of the field strength. Both horizontal and vertical polarizations of the antenna are set to make the measurement.
- d. For each suspected emission, the EUT was arranged to its worst case and then the antenna was tuned to heights from 1 meter to 4 meters and the rotatable table was turned from 0 degrees to 360 degrees to find the maximum reading.
- e. The test-receiver system was set to quasi-peak detect function and specified bandwidth with maximum hold mode when the test frequency is below 1 GHz.
- f. The test-receiver system was set to peak and average detected function and specified bandwidth with maximum hold mode when the test frequency is above 1 GHz. If the peak reading value also meets average limit, measurement with the average detector is unnecessary.

Note:

1. The resolution bandwidth and video bandwidth of test receiver/spectrum analyzer is 120 kHz for Quasi-peak detection (QP) or Peak detection (PK) at frequency below 1 GHz.
2. The resolution bandwidth of test receiver/spectrum analyzer is 1 MHz and the video bandwidth is 3 MHz for Peak detection (PK) at frequency above 1 GHz.
3. The resolution bandwidth of test receiver/spectrum analyzer is 1 MHz and the video bandwidth is $\geq 1/T$ (Duty cycle < 98 %) or 10 Hz (Duty cycle ≥ 98 %) for Average detection (AV) at frequency above 1 GHz.
(11a: RBW = 1 MHz, VBW = 1 kHz ; 11ac (VHT20): RBW = 1 MHz, VBW = 1 kHz ;
11ac (VHT40): RBW = 1 MHz, VBW = 2 kHz ; 11ac (VHT80): RBW = 1 MHz, VBW = 3 kHz)
4. All modes of operation were investigated and the worst-case emissions are reported.

4.1.4 Deviation from Test Standard

No deviation.

4.1.5 Test Setup

<Radiated Emission below 30 MHz>

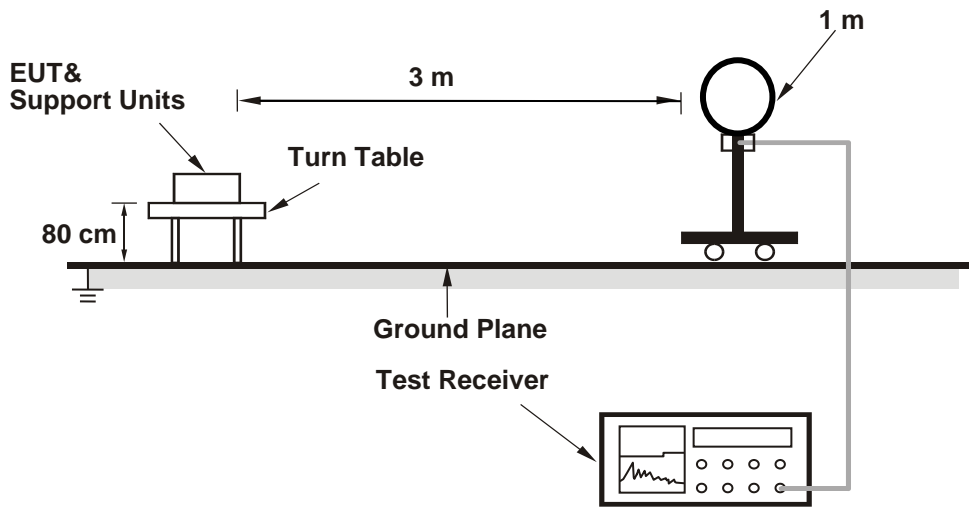

<Radiated Emission 30 MHz to 1 GHz>

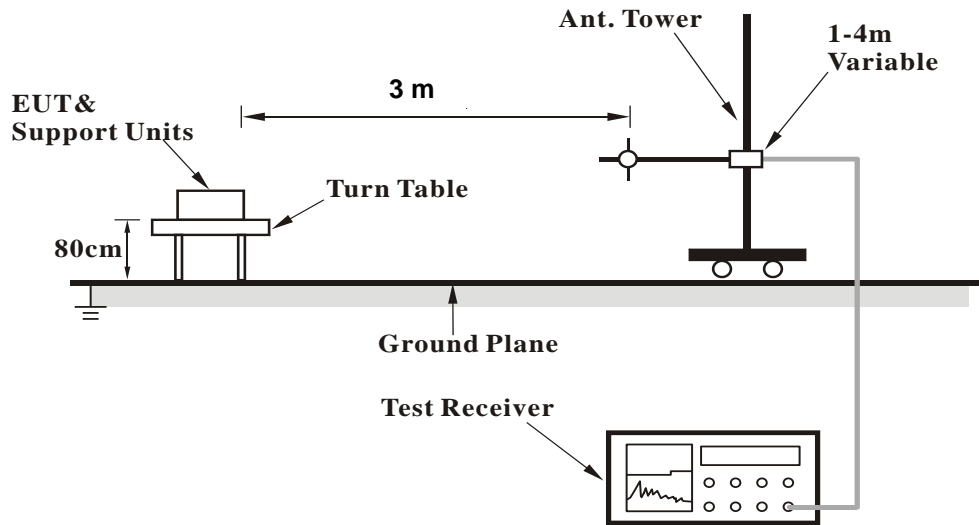

<Radiated Emission above 1 GHz>

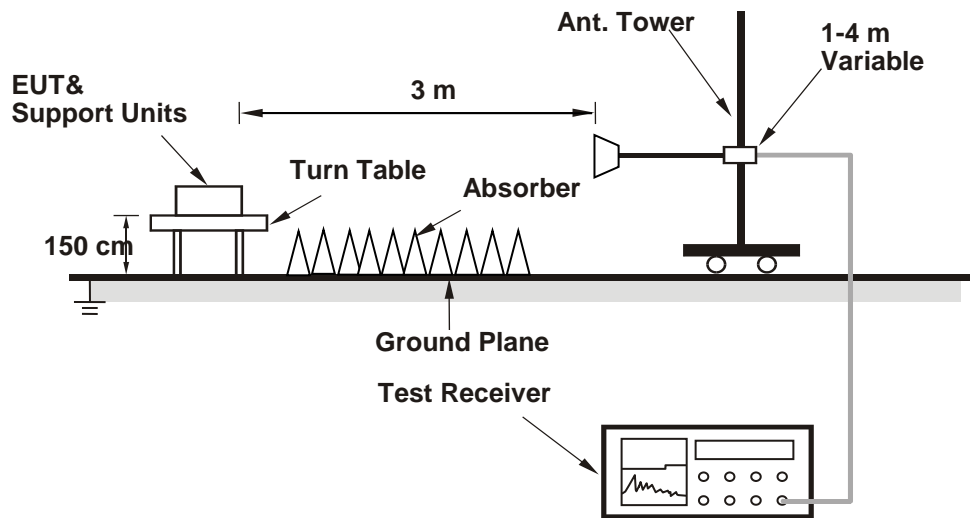

For the actual test configuration, please refer to the attached file (Test Setup Photo).

4.1.6 EUT Operating Conditions

- a. Placed the EUT on a testing table.
- b. Use the software to control the EUT under transmission condition continuously at specific channel frequency.

4.1.7 Test Results

Mode A

Above 1 GHz Data :

802.11a

CHANNEL	TX Channel 36	DETECTOR FUNCTION	Peak (PK)
FREQUENCY RANGE	1GHz ~ 40GHz		Average (AV)

Antenna Polarity & Test Distance : Horizontal at 3 m

No	Frequency (MHz)	Emission Level (dBuV/m)	Limit (dBuV/m)	Margin (dB)	Antenna Height (m)	Table Angle (Degree)	Raw Value (dBuV)	Correction Factor (dB/m)
1	5082.00	58.5 PK	74.0	-15.5	1.12 H	201	51.9	6.6
2	5082.00	45.6 AV	54.0	-8.4	1.12 H	201	39.0	6.6
3	*5180.00	103.5 PK	-	-	1.12 H	201	61.3	42.2
4	*5180.00	93.6 AV	-	-	1.12 H	201	51.4	42.2
5	#10360.00	58.5 PK	68.2	-9.7	1.97 H	280	41.8	16.7

Antenna Polarity & Test Distance : Vertical at 3 m

No	Frequency (MHz)	Emission Level (dBuV/m)	Limit (dBuV/m)	Margin (dB)	Antenna Height (m)	Table Angle (Degree)	Raw Value (dBuV)	Correction Factor (dB/m)
1	5082.00	60.1 PK	74.0	-13.9	1.44 V	162	53.5	6.6
2	5082.00	48.8 AV	54.0	-5.2	1.44 V	162	42.2	6.6
3	*5180.00	112.1 PK	-	-	1.44 V	162	69.9	42.2
4	*5180.00	101.7 AV	-	-	1.44 V	162	59.5	42.2
5	#10360.00	59.4 PK	68.2	-8.8	1.07 V	74	42.7	16.7

Remarks:

1. Emission Level(dBuV/m) = Raw Value(dBuV) + Correction Factor(dB/m)
2. Correction Factor(dB/m) = Antenna Factor(dB/m) + Cable Factor(dB) – Pre-Amplifier Factor(dB)
3. Margin value = Emission Level – Limit value
4. The other emission levels were very low against the limit.
5. " * " : Fundamental frequency.
6. " # " : The radiated frequency is out of the restricted band.

CHANNEL	TX Channel 40	DETECTOR FUNCTION	Peak (PK)
FREQUENCY RANGE	1GHz ~ 40GHz		Average (AV)

Antenna Polarity & Test Distance : Horizontal at 3 m								
No	Frequency (MHz)	Emission Level (dBuV/m)	Limit (dBuV/m)	Margin (dB)	Antenna Height (m)	Table Angle (Degree)	Raw Value (dBuV)	Correction Factor (dB/m)
1	*5200.00	104.3 PK	-	-	1.21 H	209	62.2	42.1
2	*5200.00	94.3 AV	-	-	1.21 H	209	52.2	42.1
3	#10400.00	59.4 PK	68.2	-8.8	2.03 H	288	42.5	16.9
Antenna Polarity & Test Distance : Vertical at 3 m								
No	Frequency (MHz)	Emission Level (dBuV/m)	Limit (dBuV/m)	Margin (dB)	Antenna Height (m)	Table Angle (Degree)	Raw Value (dBuV)	Correction Factor (dB/m)
1	*5200.00	112.7 PK	-	-	1.13 V	160	70.6	42.1
2	*5200.00	102.5 AV	-	-	1.13 V	160	60.4	42.1
3	#10400.00	59.9 PK	68.2	-8.3	1.19 V	79	43.0	16.9

Remarks:

1. Emission Level(dBuV/m) = Raw Value(dBuV) + Correction Factor(dB/m)
2. Correction Factor(dB/m) = Antenna Factor(dB/m) + Cable Factor(dB) – Pre-Amplifier Factor(dB)
3. Margin value = Emission Level – Limit value
4. The other emission levels were very low against the limit.
5. " * " : Fundamental frequency.
6. " # " : The radiated frequency is out of the restricted band.

CHANNEL	TX Channel 48	DETECTOR FUNCTION	Peak (PK)
FREQUENCY RANGE	1GHz ~ 40GHz		Average (AV)

Antenna Polarity & Test Distance : Horizontal at 3 m

No	Frequency (MHz)	Emission Level (dBuV/m)	Limit (dBuV/m)	Margin (dB)	Antenna Height (m)	Table Angle (Degree)	Raw Value (dBuV)	Correction Factor (dB/m)
1	5142.00	58.6 PK	74.0	-15.4	1.17 H	205	52.0	6.6
2	5142.00	44.6 AV	54.0	-9.4	1.17 H	205	38.0	6.6
3	*5240.00	103.8 PK	-	-	1.17 H	205	61.8	42.0
4	*5240.00	93.7 AV	-	-	1.17 H	205	51.7	42.0
5	#10480.00	60.0 PK	68.2	-8.2	1.92 H	277	42.3	17.7

Antenna Polarity & Test Distance : Vertical at 3 m

No	Frequency (MHz)	Emission Level (dBuV/m)	Limit (dBuV/m)	Margin (dB)	Antenna Height (m)	Table Angle (Degree)	Raw Value (dBuV)	Correction Factor (dB/m)
1	5142.00	59.6 PK	74.0	-14.4	1.21 V	163	53.0	6.6
2	5142.00	47.9 AV	54.0	-6.1	1.21 V	163	41.3	6.6
3	*5240.00	112.3 PK	-	-	1.21 V	163	70.3	42.0
4	*5240.00	101.8 AV	-	-	1.21 V	163	59.8	42.0
5	#10480.00	60.6 PK	68.2	-7.6	1.20 V	71	42.9	17.7

Remarks:

1. Emission Level(dBuV/m) = Raw Value(dBuV) + Correction Factor(dB/m)
2. Correction Factor(dB/m) = Antenna Factor(dB/m) + Cable Factor(dB) – Pre-Amplifier Factor(dB)
3. Margin value = Emission Level – Limit value
4. The other emission levels were very low against the limit.
5. " * ": Fundamental frequency.
6. " # ": The radiated frequency is out of the restricted band.

CHANNEL	TX Channel 52	DETECTOR FUNCTION	Peak (PK)
FREQUENCY RANGE	1GHz ~ 40GHz		Average (AV)

Antenna Polarity & Test Distance : Horizontal at 3 m

No	Frequency (MHz)	Emission Level (dBuV/m)	Limit (dBuV/m)	Margin (dB)	Antenna Height (m)	Table Angle (Degree)	Raw Value (dBuV)	Correction Factor (dB/m)
1	*5260.00	104.7 PK	-	-	1.19 H	211	62.8	41.9
2	*5260.00	100.1 AV	-	-	1.19 H	211	58.2	41.9
3	5356.00	56.6 PK	74.0	-17.4	1.19 H	211	50.2	6.4
4	5356.00	44.4 AV	54.0	-9.6	1.19 H	211	38.0	6.4
5	#10520.00	59.1 PK	68.2	-9.1	2.11 H	271	41.5	17.6

Antenna Polarity & Test Distance : Vertical at 3 m

No	Frequency (MHz)	Emission Level (dBuV/m)	Limit (dBuV/m)	Margin (dB)	Antenna Height (m)	Table Angle (Degree)	Raw Value (dBuV)	Correction Factor (dB/m)
1	*5260.00	112.7 PK	-	-	1.41 V	162	70.8	41.9
2	*5260.00	102.1 AV	-	-	1.41 V	162	60.2	41.9
3	5356.00	58.7 PK	74.0	-15.3	1.41 V	162	52.3	6.4
4	5356.00	47.1 AV	54.0	-6.9	1.41 V	162	40.7	6.4
5	#10520.00	59.6 PK	68.2	-8.6	1.37 V	74	42.0	17.6

Remarks:

1. Emission Level(dBuV/m) = Raw Value(dBuV) + Correction Factor(dB/m)
2. Correction Factor(dB/m) = Antenna Factor(dB/m) + Cable Factor(dB) – Pre-Amplifier Factor(dB)
3. Margin value = Emission Level – Limit value
4. The other emission levels were very low against the limit.
5. " * ": Fundamental frequency.
6. " # ": The radiated frequency is out of the restricted band.

CHANNEL	TX Channel 60	DETECTOR FUNCTION	Peak (PK)
FREQUENCY RANGE	1GHz ~ 40GHz		Average (AV)

Antenna Polarity & Test Distance : Horizontal at 3 m

No	Frequency (MHz)	Emission Level (dBuV/m)	Limit (dBuV/m)	Margin (dB)	Antenna Height (m)	Table Angle (Degree)	Raw Value (dBuV)	Correction Factor (dB/m)
1	*5300.00	104.1 PK	-	-	1.28 H	220	62.2	41.9
2	*5300.00	94.0 AV	-	-	1.28 H	220	52.1	41.9
3	10600.00	58.5 PK	74.0	-15.5	1.85 H	293	41.3	17.2
4	10600.00	44.8 AV	54.0	-9.2	1.85 H	293	27.6	17.2

Antenna Polarity & Test Distance : Vertical at 3 m

No	Frequency (MHz)	Emission Level (dBuV/m)	Limit (dBuV/m)	Margin (dB)	Antenna Height (m)	Table Angle (Degree)	Raw Value (dBuV)	Correction Factor (dB/m)
1	*5300.00	112.2 PK	-	-	1.58 V	163	70.3	41.9
2	*5300.00	102.2 AV	-	-	1.58 V	163	60.3	41.9
3	10600.00	59.1 PK	74.0	-14.9	1.28 V	79	41.9	17.2
4	10600.00	45.2 AV	54.0	-8.8	1.28 V	79	28.0	17.2

Remarks:

1. Emission Level(dBuV/m) = Raw Value(dBuV) + Correction Factor(dB/m)
2. Correction Factor(dB/m) = Antenna Factor(dB/m) + Cable Factor(dB) – Pre-Amplifier Factor(dB)
3. Margin value = Emission Level – Limit value
4. The other emission levels were very low against the limit.
5. " * ": Fundamental frequency.

CHANNEL	TX Channel 64	DETECTOR FUNCTION	Peak (PK)
FREQUENCY RANGE	1GHz ~ 40GHz		Average (AV)

Antenna Polarity & Test Distance : Horizontal at 3 m

No	Frequency (MHz)	Emission Level (dBuV/m)	Limit (dBuV/m)	Margin (dB)	Antenna Height (m)	Table Angle (Degree)	Raw Value (dBuV)	Correction Factor (dB/m)
1	*5320.00	103.1 PK	-	-	1.22 H	199	61.1	42.0
2	*5320.00	93.3 AV	-	-	1.22 H	199	51.3	42.0
3	5417.00	57.2 PK	74.0	-16.8	1.22 H	199	50.7	6.5
4	5417.00	44.0 AV	54.0	-10.0	1.22 H	199	37.5	6.5
5	10640.00	58.9 PK	74.0	-15.1	1.92 H	293	41.5	17.4
6	10640.00	45.1 AV	54.0	-8.9	1.92 H	293	27.7	17.4

Antenna Polarity & Test Distance : Vertical at 3 m

No	Frequency (MHz)	Emission Level (dBuV/m)	Limit (dBuV/m)	Margin (dB)	Antenna Height (m)	Table Angle (Degree)	Raw Value (dBuV)	Correction Factor (dB/m)
1	*5320.00	111.4 PK	-	-	1.30 V	160	69.4	42.0
2	*5320.00	101.5 AV	-	-	1.30 V	160	59.5	42.0
3	5417.00	58.7 PK	74.0	-15.3	1.30 V	160	52.2	6.5
4	5417.00	46.0 AV	54.0	-8.0	1.30 V	160	39.5	6.5
5	10640.00	59.1 PK	74.0	-14.9	1.31 V	80	41.7	17.4
6	10640.00	45.4 AV	54.0	-8.6	1.31 V	80	28.0	17.4

Remarks:

1. Emission Level(dBuV/m) = Raw Value(dBuV) + Correction Factor(dB/m)
2. Correction Factor(dB/m) = Antenna Factor(dB/m) + Cable Factor(dB) – Pre-Amplifier Factor(dB)
3. Margin value = Emission Level – Limit value
4. The other emission levels were very low against the limit.
5. " * ": Fundamental frequency.

CHANNEL	TX Channel 100	DETECTOR FUNCTION	Peak (PK)
FREQUENCY RANGE	1GHz ~ 40GHz		Average (AV)

Antenna Polarity & Test Distance : Horizontal at 3 m								
No	Frequency (MHz)	Emission Level (dBuV/m)	Limit (dBuV/m)	Margin (dB)	Antenna Height (m)	Table Angle (Degree)	Raw Value (dBuV)	Correction Factor (dB/m)
1	5460.00	57.4 PK	74.0	-16.6	3.86 H	151	51.1	6.3
2	5460.00	44.5 AV	54.0	-9.5	3.86 H	151	38.2	6.3
3	#5470.00	57.9 PK	68.2	-10.3	3.86 H	151	51.6	6.3
4	*5500.00	101.7 PK	-	-	3.86 H	151	59.6	42.1
5	*5500.00	91.5 AV	-	-	3.86 H	151	49.4	42.1
6	11000.00	60.6 PK	74.0	-13.4	2.25 H	264	42.0	18.6
7	11000.00	46.7 AV	54.0	-7.3	2.25 H	264	28.1	18.6

Antenna Polarity & Test Distance : Vertical at 3 m								
No	Frequency (MHz)	Emission Level (dBuV/m)	Limit (dBuV/m)	Margin (dB)	Antenna Height (m)	Table Angle (Degree)	Raw Value (dBuV)	Correction Factor (dB/m)
1	5460.00	61.4 PK	74.0	-12.6	1.23 V	240	55.1	6.3
2	5460.00	49.5 AV	54.0	-4.5	1.23 V	240	43.2	6.3
3	#5470.00	62.5 PK	68.2	-5.7	1.23 V	240	56.2	6.3
4	*5500.00	114.0 PK	-	-	1.23 V	240	71.9	42.1
5	*5500.00	103.7 AV	-	-	1.23 V	240	61.6	42.1
6	11000.00	60.8 PK	74.0	-13.2	2.48 V	251	42.2	18.6
7	11000.00	47.4 AV	54.0	-6.6	2.48 V	251	28.8	18.6

Remarks:

1. Emission Level(dBuV/m) = Raw Value(dBuV) + Correction Factor(dB/m)
2. Correction Factor(dB/m) = Antenna Factor(dB/m) + Cable Factor(dB) – Pre-Amplifier Factor(dB)
3. Margin value = Emission Level – Limit value
4. The other emission levels were very low against the limit.
5. " * ": Fundamental frequency.
6. " # ": The radiated frequency is out of the restricted band.

CHANNEL	TX Channel 116	DETECTOR FUNCTION	Peak (PK)
FREQUENCY RANGE	1GHz ~ 40GHz		Average (AV)

Antenna Polarity & Test Distance : Horizontal at 3 m								
No	Frequency (MHz)	Emission Level (dBuV/m)	Limit (dBuV/m)	Margin (dB)	Antenna Height (m)	Table Angle (Degree)	Raw Value (dBuV)	Correction Factor (dB/m)
1	*5580.00	101.4 PK	-	-	3.39 H	152	59.3	42.1
2	*5580.00	90.9 AV	-	-	3.39 H	152	48.8	42.1
3	11160.00	60.6 PK	74.0	-13.4	2.28 H	236	42.1	18.5
4	11160.00	46.2 AV	54.0	-7.8	2.28 H	236	27.7	18.5

Antenna Polarity & Test Distance : Vertical at 3 m								
No	Frequency (MHz)	Emission Level (dBuV/m)	Limit (dBuV/m)	Margin (dB)	Antenna Height (m)	Table Angle (Degree)	Raw Value (dBuV)	Correction Factor (dB/m)
1	*5580.00	114.6 PK	-	-	2.37 V	246	72.5	42.1
2	*5580.00	103.8 AV	-	-	2.37 V	246	61.7	42.1
3	11160.00	60.6 PK	74.0	-13.4	2.45 V	251	42.1	18.5
4	11160.00	47.7 AV	54.0	-6.3	2.45 V	251	29.2	18.5

Remarks:

1. Emission Level(dBuV/m) = Raw Value(dBuV) + Correction Factor(dB/m)
2. Correction Factor(dB/m) = Antenna Factor(dB/m) + Cable Factor(dB) – Pre-Amplifier Factor(dB)
3. Margin value = Emission Level – Limit value
4. The other emission levels were very low against the limit.
5. " * ": Fundamental frequency.

CHANNEL	TX Channel 140	DETECTOR FUNCTION	Peak (PK)
FREQUENCY RANGE	1GHz ~ 40GHz		Average (AV)

Antenna Polarity & Test Distance : Horizontal at 3 m

No	Frequency (MHz)	Emission Level (dBuV/m)	Limit (dBuV/m)	Margin (dB)	Antenna Height (m)	Table Angle (Degree)	Raw Value (dBuV)	Correction Factor (dB/m)
1	*5700.00	102.6 PK	-	-	3.57 H	153	60.3	42.3
2	*5700.00	92.3 AV	-	-	3.57 H	153	50.0	42.3
3	#5725.00	58.2 PK	68.2	-10.0	3.57 H	153	51.7	6.5
4	11400.00	60.2 PK	74.0	-13.8	2.82 H	216	42.3	17.9
5	11400.00	46.0 AV	54.0	-8.0	2.82 H	216	28.1	17.9

Antenna Polarity & Test Distance : Vertical at 3 m

No	Frequency (MHz)	Emission Level (dBuV/m)	Limit (dBuV/m)	Margin (dB)	Antenna Height (m)	Table Angle (Degree)	Raw Value (dBuV)	Correction Factor (dB/m)
1	*5700.00	115.2 PK	-	-	2.34 V	245	72.9	42.3
2	*5700.00	104.7 AV	-	-	2.34 V	245	62.4	42.3
3	#5725.00	60.5 PK	68.2	-7.7	2.34 V	245	54.0	6.5
4	11400.00	61.9 PK	74.0	-12.1	1.00 V	97	44.0	17.9
5	11400.00	48.6 AV	54.0	-5.4	1.00 V	97	30.7	17.9

Remarks:

1. Emission Level(dBuV/m) = Raw Value(dBuV) + Correction Factor(dB/m)
2. Correction Factor(dB/m) = Antenna Factor(dB/m) + Cable Factor(dB) – Pre-Amplifier Factor(dB)
3. Margin value = Emission Level – Limit value
4. The other emission levels were very low against the limit.
5. " * ": Fundamental frequency.
6. " # ": The radiated frequency is out of the restricted band.

CHANNEL	TX Channel 144	DETECTOR FUNCTION	Peak (PK) Average (AV)
FREQUENCY RANGE	1GHz ~ 40GHz		

Antenna Polarity & Test Distance : Horizontal at 3 m

No	Frequency (MHz)	Emission Level (dBuV/m)	Limit (dBuV/m)	Margin (dB)	Antenna Height (m)	Table Angle (Degree)	Raw Value (dBuV)	Correction Factor (dB/m)
1	#5470.00	58.7 PK	68.2	-9.5	3.62 H	145	52.4	6.3
2	*5720.00	102.7 PK	-	-	3.62 H	145	60.5	42.2
3	*5720.00	92.3 AV	-	-	3.62 H	145	50.1	42.2
4	#5850.00	58.6 PK	68.2	-9.6	3.62 H	145	51.8	6.8
5	11440.00	60.3 PK	74.0	-13.7	2.16 H	267	42.3	18.0
6	11440.00	46.0 AV	54.0	-8.0	2.16 H	267	28.0	18.0

Antenna Polarity & Test Distance : Vertical at 3 m

No	Frequency (MHz)	Emission Level (dBuV/m)	Limit (dBuV/m)	Margin (dB)	Antenna Height (m)	Table Angle (Degree)	Raw Value (dBuV)	Correction Factor (dB/m)
1	#5470.00	58.1 PK	68.2	-10.1	1.19 V	276	51.8	6.3
2	*5720.00	113.8 PK	-	-	1.19 V	276	71.6	42.2
3	*5720.00	103.0 AV	-	-	1.19 V	276	60.8	42.2
4	#5850.00	58.2 PK	68.2	-10.0	1.19 V	276	51.4	6.8
5	11440.00	60.8 PK	74.0	-13.2	1.01 V	91	42.8	18.0
6	11440.00	48.2 AV	54.0	-5.8	1.01 V	91	30.2	18.0

Remarks:

1. Emission Level(dBuV/m) = Raw Value(dBuV) + Correction Factor(dB/m)
2. Correction Factor(dB/m) = Antenna Factor(dB/m) + Cable Factor(dB) – Pre-Amplifier Factor(dB)
3. Margin value = Emission Level – Limit value
4. The other emission levels were very low against the limit.
5. " * ": Fundamental frequency.
6. " # ": The radiated frequency is out of the restricted band.

CHANNEL	TX Channel 149	DETECTOR FUNCTION	Peak (PK) Average (AV)
FREQUENCY RANGE	1GHz ~ 40GHz		

Antenna Polarity & Test Distance : Horizontal at 3 m								
No	Frequency (MHz)	Emission Level (dBuV/m)	Limit (dBuV/m)	Margin (dB)	Antenna Height (m)	Table Angle (Degree)	Raw Value (dBuV)	Correction Factor (dB/m)
1	*5745.00	103.5 PK	-	-	1.39 H	270	61.3	42.2
2	*5745.00	93.1 AV	-	-	1.39 H	270	50.9	42.2
3	11490.00	60.3 PK	74.0	-13.7	2.57 H	233	42.0	18.3
4	11490.00	46.5 AV	54.0	-7.5	2.57 H	233	28.2	18.3

Antenna Polarity & Test Distance : Vertical at 3 m								
No	Frequency (MHz)	Emission Level (dBuV/m)	Limit (dBuV/m)	Margin (dB)	Antenna Height (m)	Table Angle (Degree)	Raw Value (dBuV)	Correction Factor (dB/m)
1	*5745.00	114.7 PK	-	-	1.40 V	244	72.5	42.2
2	*5745.00	104.2 AV	-	-	1.40 V	244	62.0	42.2
3	11490.00	61.7 PK	74.0	-12.3	1.04 V	90	43.4	18.3
4	11490.00	48.1 AV	54.0	-5.9	1.04 V	90	29.8	18.3

<Out of Band Emission (OOBE)>

Antenna Polarity & Test Distance : Horizontal at 3 m								
No	Frequency (MHz)	Emission Level (dBuV/m)	Limit (dBuV/m)	Margin (dB)	Antenna Height (m)	Table Angle (Degree)	Raw Value (dBuV)	Correction Factor (dB/m)
1	#5623.72	57.5 PK	68.2	-10.7	1.39 H	270	51.3	6.2
2	#5989.10	59.1 PK	68.2	-9.1	1.39 H	270	51.9	7.2

Antenna Polarity & Test Distance : Vertical at 3 m								
No	Frequency (MHz)	Emission Level (dBuV/m)	Limit (dBuV/m)	Margin (dB)	Antenna Height (m)	Table Angle (Degree)	Raw Value (dBuV)	Correction Factor (dB/m)
1	#5646.79	59.9 PK	68.2	-8.3	1.40 V	244	53.6	6.3
2	#5932.05	58.6 PK	68.2	-9.6	1.40 V	244	51.3	7.3

Remarks:

1. Emission Level(dBuV/m) = Raw Value(dBuV) + Correction Factor(dB/m)
2. Correction Factor(dB/m) = Antenna Factor(dB/m) + Cable Factor(dB) – Pre-Amplifier Factor(dB)
3. Margin value = Emission Level – Limit value
4. The other emission levels were very low against the limit.
5. " * " : Fundamental frequency.
6. " # " : The radiated frequency is out of the restricted band.

CHANNEL	TX Channel 157	DETECTOR FUNCTION	Peak (PK) Average (AV)
FREQUENCY RANGE	1GHz ~ 40GHz		

Antenna Polarity & Test Distance : Horizontal at 3 m								
No	Frequency (MHz)	Emission Level (dBuV/m)	Limit (dBuV/m)	Margin (dB)	Antenna Height (m)	Table Angle (Degree)	Raw Value (dBuV)	Correction Factor (dB/m)
1	*5785.00	104.4 PK	-	-	1.45 H	239	62.2	42.2
2	*5785.00	94.0 AV	-	-	1.45 H	239	51.8	42.2
3	11570.00	61.1 PK	74.0	-12.9	2.53 H	255	43.1	18.0
4	11570.00	48.5 AV	54.0	-5.5	2.53 H	255	30.5	18.0

Antenna Polarity & Test Distance : Vertical at 3 m								
No	Frequency (MHz)	Emission Level (dBuV/m)	Limit (dBuV/m)	Margin (dB)	Antenna Height (m)	Table Angle (Degree)	Raw Value (dBuV)	Correction Factor (dB/m)
1	*5785.00	114.2 PK	-	-	1.58 V	226	72.0	42.2
2	*5785.00	103.7 AV	-	-	1.58 V	226	61.5	42.2
3	11570.00	62.5 PK	74.0	-11.5	1.01 V	102	44.5	18.0
4	11570.00	50.0 AV	54.0	-4.0	1.01 V	102	32.0	18.0

<Out of Band Emission (OOBE)>

Antenna Polarity & Test Distance : Horizontal at 3 m								
No	Frequency (MHz)	Emission Level (dBuV/m)	Limit (dBuV/m)	Margin (dB)	Antenna Height (m)	Table Angle (Degree)	Raw Value (dBuV)	Correction Factor (dB/m)
1	#5650.00	59.8 PK	68.2	-8.4	1.45 H	239	53.5	6.3
2	#5941.03	61.9 PK	68.2	-6.3	1.45 H	239	54.6	7.3

Antenna Polarity & Test Distance : Vertical at 3 m								
No	Frequency (MHz)	Emission Level (dBuV/m)	Limit (dBuV/m)	Margin (dB)	Antenna Height (m)	Table Angle (Degree)	Raw Value (dBuV)	Correction Factor (dB/m)
1	#5625.00	59.1 PK	68.2	-9.1	1.58 V	226	52.9	6.2
2	#5984.62	61.7 PK	68.2	-6.5	1.58 V	226	54.5	7.2

Remarks:

1. Emission Level(dBuV/m) = Raw Value(dBuV) + Correction Factor(dB/m)
2. Correction Factor(dB/m) = Antenna Factor(dB/m) + Cable Factor(dB) – Pre-Amplifier Factor(dB)
3. Margin value = Emission Level – Limit value
4. The other emission levels were very low against the limit.
5. " * ": Fundamental frequency.
6. " # ": The radiated frequency is out of the restricted band.

CHANNEL	TX Channel 165	DETECTOR FUNCTION	Peak (PK) Average (AV)
FREQUENCY RANGE	1GHz ~ 40GHz		

Antenna Polarity & Test Distance : Horizontal at 3 m								
No	Frequency (MHz)	Emission Level (dBuV/m)	Limit (dBuV/m)	Margin (dB)	Antenna Height (m)	Table Angle (Degree)	Raw Value (dBuV)	Correction Factor (dB/m)
1	*5825.00	105.7 PK	-	-	1.51 H	242	63.4	42.3
2	*5825.00	94.7 AV	-	-	1.51 H	242	52.4	42.3
3	11650.00	62.3 PK	74.0	-11.7	2.69 H	249	44.3	18.0
4	11650.00	48.2 AV	54.0	-5.8	2.69 H	249	30.2	18.0

Antenna Polarity & Test Distance : Vertical at 3 m								
No	Frequency (MHz)	Emission Level (dBuV/m)	Limit (dBuV/m)	Margin (dB)	Antenna Height (m)	Table Angle (Degree)	Raw Value (dBuV)	Correction Factor (dB/m)
1	*5825.00	115.5 PK	-	-	1.33 V	261	73.2	42.3
2	*5825.00	104.4 AV	-	-	1.33 V	261	62.1	42.3
3	11650.00	63.9 PK	74.0	-10.1	1.01 V	90	45.9	18.0
4	11650.00	50.0 AV	54.0	-4.0	1.01 V	90	32.0	18.0

<Out of Band Emission (OOBE)>

Antenna Polarity & Test Distance : Horizontal at 3 m								
No	Frequency (MHz)	Emission Level (dBuV/m)	Limit (dBuV/m)	Margin (dB)	Antenna Height (m)	Table Angle (Degree)	Raw Value (dBuV)	Correction Factor (dB/m)
1	#5623.08	60.2 PK	68.2	-8.0	1.51 H	242	54.0	6.2
2	#5992.95	61.7 PK	68.2	-6.5	1.51 H	242	54.5	7.2

Antenna Polarity & Test Distance : Vertical at 3 m								
No	Frequency (MHz)	Emission Level (dBuV/m)	Limit (dBuV/m)	Margin (dB)	Antenna Height (m)	Table Angle (Degree)	Raw Value (dBuV)	Correction Factor (dB/m)
1	#5607.69	59.8 PK	68.2	-8.4	1.33 V	261	53.6	6.2
2	#5925.64	62.7 PK	68.2	-5.5	1.33 V	261	55.4	7.3

Remarks:

1. Emission Level(dBuV/m) = Raw Value(dBuV) + Correction Factor(dB/m)
2. Correction Factor(dB/m) = Antenna Factor(dB/m) + Cable Factor(dB) – Pre-Amplifier Factor(dB)
3. Margin value = Emission Level – Limit value
4. The other emission levels were very low against the limit.
5. " * ": Fundamental frequency.
6. " # ": The radiated frequency is out of the restricted band.

802.11ac (VHT20)

CHANNEL	TX Channel 36	DETECTOR FUNCTION	Peak (PK)
FREQUENCY RANGE	1GHz ~ 40GHz		Average (AV)

Antenna Polarity & Test Distance : Horizontal at 3 m								
No	Frequency (MHz)	Emission Level (dBuV/m)	Limit (dBuV/m)	Margin (dB)	Antenna Height (m)	Table Angle (Degree)	Raw Value (dBuV)	Correction Factor (dB/m)
1	5082.00	57.7 PK	74.0	-16.3	1.17 H	208	51.1	6.6
2	5082.00	44.4 AV	54.0	-9.6	1.17 H	208	37.8	6.6
3	*5180.00	101.8 PK	-	-	1.17 H	208	59.6	42.2
4	*5180.00	91.9 AV	-	-	1.17 H	208	49.7	42.2
5	#10360.00	58.5 PK	68.2	-9.7	1.88 H	286	41.8	16.7

Antenna Polarity & Test Distance : Vertical at 3 m								
No	Frequency (MHz)	Emission Level (dBuV/m)	Limit (dBuV/m)	Margin (dB)	Antenna Height (m)	Table Angle (Degree)	Raw Value (dBuV)	Correction Factor (dB/m)
1	5082.00	59.2 PK	74.0	-14.8	1.44 V	157	52.6	6.6
2	5082.00	47.4 AV	54.0	-6.6	1.44 V	157	40.8	6.6
3	*5180.00	110.4 PK	-	-	1.44 V	157	68.2	42.2
4	*5180.00	99.8 AV	-	-	1.44 V	157	57.6	42.2
5	#10360.00	59.1 PK	68.2	-9.1	1.27 V	79	42.4	16.7

Remarks:

1. Emission Level(dBuV/m) = Raw Value(dBuV) + Correction Factor(dB/m)
2. Correction Factor(dB/m) = Antenna Factor(dB/m) + Cable Factor(dB) – Pre-Amplifier Factor(dB)
3. Margin value = Emission Level – Limit value
4. The other emission levels were very low against the limit.
5. " * ": Fundamental frequency.
6. " # ": The radiated frequency is out of the restricted band.

CHANNEL	TX Channel 40	DETECTOR FUNCTION	Peak (PK)
FREQUENCY RANGE	1GHz ~ 40GHz		Average (AV)

Antenna Polarity & Test Distance : Horizontal at 3 m								
No	Frequency (MHz)	Emission Level (dBuV/m)	Limit (dBuV/m)	Margin (dB)	Antenna Height (m)	Table Angle (Degree)	Raw Value (dBuV)	Correction Factor (dB/m)
1	*5200.00	102.1 PK	-	-	1.21 H	220	60.0	42.1
2	*5200.00	92.2 AV	-	-	1.21 H	220	50.1	42.1
3	#10400.00	58.9 PK	68.2	-9.3	2.06 H	281	42.0	16.9
Antenna Polarity & Test Distance : Vertical at 3 m								
No	Frequency (MHz)	Emission Level (dBuV/m)	Limit (dBuV/m)	Margin (dB)	Antenna Height (m)	Table Angle (Degree)	Raw Value (dBuV)	Correction Factor (dB/m)
1	*5200.00	110.6 PK	-	-	1.06 V	163	68.5	42.1
2	*5200.00	100.3 AV	-	-	1.06 V	163	58.2	42.1
3	#10400.00	59.4 PK	68.2	-8.8	1.33 V	72	42.5	16.9

Remarks:

1. Emission Level(dBuV/m) = Raw Value(dBuV) + Correction Factor(dB/m)
2. Correction Factor(dB/m) = Antenna Factor(dB/m) + Cable Factor(dB) – Pre-Amplifier Factor(dB)
3. Margin value = Emission Level – Limit value
4. The other emission levels were very low against the limit.
5. " * " : Fundamental frequency.
6. " # " : The radiated frequency is out of the restricted band.

CHANNEL	TX Channel 48	DETECTOR FUNCTION	Peak (PK)
FREQUENCY RANGE	1GHz ~ 40GHz		Average (AV)

Antenna Polarity & Test Distance : Horizontal at 3 m

No	Frequency (MHz)	Emission Level (dBuV/m)	Limit (dBuV/m)	Margin (dB)	Antenna Height (m)	Table Angle (Degree)	Raw Value (dBuV)	Correction Factor (dB/m)
1	5142.00	58.6 PK	74.0	-15.4	1.22 H	220	52.0	6.6
2	5142.00	45.0 AV	54.0	-9.0	1.22 H	220	38.4	6.6
3	*5240.00	101.3 PK	-	-	1.22 H	220	59.3	42.0
4	*5240.00	91.5 AV	-	-	1.22 H	220	49.5	42.0
5	#10480.00	59.6 PK	68.2	-8.6	1.89 H	279	41.9	17.7

Antenna Polarity & Test Distance : Vertical at 3 m

No	Frequency (MHz)	Emission Level (dBuV/m)	Limit (dBuV/m)	Margin (dB)	Antenna Height (m)	Table Angle (Degree)	Raw Value (dBuV)	Correction Factor (dB/m)
1	5142.00	60.2 PK	74.0	-13.8	1.52 V	156	53.6	6.6
2	5142.00	48.1 AV	54.0	-5.9	1.52 V	156	41.5	6.6
3	*5240.00	109.8 PK	-	-	1.52 V	156	67.8	42.0
4	*5240.00	99.5 AV	-	-	1.52 V	156	57.5	42.0
5	#10480.00	60.2 PK	68.2	-8.0	1.22 V	80	42.5	17.7

Remarks:

1. Emission Level(dBuV/m) = Raw Value(dBuV) + Correction Factor(dB/m)
2. Correction Factor(dB/m) = Antenna Factor(dB/m) + Cable Factor(dB) – Pre-Amplifier Factor(dB)
3. Margin value = Emission Level – Limit value
4. The other emission levels were very low against the limit.
5. " * ": Fundamental frequency.
6. " # ": The radiated frequency is out of the restricted band.

CHANNEL	TX Channel 52	DETECTOR FUNCTION	Peak (PK)
FREQUENCY RANGE	1GHz ~ 40GHz		Average (AV)

Antenna Polarity & Test Distance : Horizontal at 3 m

No	Frequency (MHz)	Emission Level (dBuV/m)	Limit (dBuV/m)	Margin (dB)	Antenna Height (m)	Table Angle (Degree)	Raw Value (dBuV)	Correction Factor (dB/m)
1	*5260.00	102.4 PK	-	-	1.17 H	195	60.5	41.9
2	*5260.00	92.1 AV	-	-	1.17 H	195	50.2	41.9
3	5356.00	57.1 PK	74.0	-16.9	1.17 H	195	50.7	6.4
4	5356.00	43.8 AV	54.0	-10.2	1.17 H	195	37.4	6.4
5	#10520.00	59.2 PK	68.2	-9.0	1.87 H	274	41.6	17.6

Antenna Polarity & Test Distance : Vertical at 3 m

No	Frequency (MHz)	Emission Level (dBuV/m)	Limit (dBuV/m)	Margin (dB)	Antenna Height (m)	Table Angle (Degree)	Raw Value (dBuV)	Correction Factor (dB/m)
1	*5260.00	110.4 PK	-	-	1.46 V	162	68.5	41.9
2	*5260.00	100.2 AV	-	-	1.46 V	162	58.3	41.9
3	5356.00	58.6 PK	74.0	-15.4	1.46 V	162	52.2	6.4
4	5356.00	46.3 AV	54.0	-7.7	1.46 V	162	39.9	6.4
5	#10520.00	59.4 PK	68.2	-8.8	1.40 V	82	41.8	17.6

Remarks:

1. Emission Level(dBuV/m) = Raw Value(dBuV) + Correction Factor(dB/m)
2. Correction Factor(dB/m) = Antenna Factor(dB/m) + Cable Factor(dB) – Pre-Amplifier Factor(dB)
3. Margin value = Emission Level – Limit value
4. The other emission levels were very low against the limit.
5. " * ": Fundamental frequency.
6. " # ": The radiated frequency is out of the restricted band.

CHANNEL	TX Channel 60	DETECTOR FUNCTION	Peak (PK)
FREQUENCY RANGE	1GHz ~ 40GHz		Average (AV)

Antenna Polarity & Test Distance : Horizontal at 3 m

No	Frequency (MHz)	Emission Level (dBuV/m)	Limit (dBuV/m)	Margin (dB)	Antenna Height (m)	Table Angle (Degree)	Raw Value (dBuV)	Correction Factor (dB/m)
1	*5300.00	67.4 PK	-	-	1.27 H	207	61.3	6.1
2	*5300.00	56.4 AV	-	-	1.27 H	207	50.3	6.1
3	10600.00	58.9 PK	74.0	-15.1	1.99 H	297	41.7	17.2
4	10600.00	44.9 AV	54.0	-9.1	1.99 H	297	27.7	17.2

Antenna Polarity & Test Distance : Vertical at 3 m

No	Frequency (MHz)	Emission Level (dBuV/m)	Limit (dBuV/m)	Margin (dB)	Antenna Height (m)	Table Angle (Degree)	Raw Value (dBuV)	Correction Factor (dB/m)
1	*5300.00	111.1 PK	-	-	1.49 V	162	69.2	41.9
2	*5300.00	100.4 AV	-	-	1.49 V	162	58.5	41.9
3	10600.00	59.2 PK	74.0	-14.8	1.37 V	74	42.0	17.2
4	10600.00	45.3 AV	54.0	-8.7	1.37 V	74	28.1	17.2

Remarks:

1. Emission Level(dBuV/m) = Raw Value(dBuV) + Correction Factor(dB/m)
2. Correction Factor(dB/m) = Antenna Factor(dB/m) + Cable Factor(dB) – Pre-Amplifier Factor(dB)
3. Margin value = Emission Level – Limit value
4. The other emission levels were very low against the limit.
5. " * ": Fundamental frequency.

CHANNEL	TX Channel 64	DETECTOR FUNCTION	Peak (PK) Average (AV)
FREQUENCY RANGE	1GHz ~ 40GHz		

Antenna Polarity & Test Distance : Horizontal at 3 m

No	Frequency (MHz)	Emission Level (dBuV/m)	Limit (dBuV/m)	Margin (dB)	Antenna Height (m)	Table Angle (Degree)	Raw Value (dBuV)	Correction Factor (dB/m)
1	*5320.00	103.1 PK	-	-	1.30 H	210	61.1	42.0
2	*5320.00	93.2 AV	-	-	1.30 H	210	51.2	42.0
3	5417.00	57.2 PK	74.0	-16.8	1.30 H	210	50.7	6.5
4	5417.00	43.8 AV	54.0	-10.2	1.30 H	210	37.3	6.5
5	10640.00	58.9 PK	74.0	-15.1	2.12 H	292	41.5	17.4
6	10640.00	45.1 AV	54.0	-8.9	2.12 H	292	27.7	17.4

Antenna Polarity & Test Distance : Vertical at 3 m

No	Frequency (MHz)	Emission Level (dBuV/m)	Limit (dBuV/m)	Margin (dB)	Antenna Height (m)	Table Angle (Degree)	Raw Value (dBuV)	Correction Factor (dB/m)
1	*5320.00	110.0 PK	-	-	1.34 V	181	68.0	42.0
2	*5320.00	99.9 AV	-	-	1.34 V	181	57.9	42.0
3	5417.00	58.8 PK	74.0	-15.2	1.34 V	181	52.3	6.5
4	5417.00	46.0 AV	54.0	-8.0	1.34 V	181	39.5	6.5
5	10640.00	59.5 PK	74.0	-14.5	1.27 V	79	42.1	17.4
6	10640.00	45.4 AV	54.0	-8.6	1.27 V	79	28.0	17.4

Remarks:

1. Emission Level(dBuV/m) = Raw Value(dBuV) + Correction Factor(dB/m)
2. Correction Factor(dB/m) = Antenna Factor(dB/m) + Cable Factor(dB) – Pre-Amplifier Factor(dB)
3. Margin value = Emission Level – Limit value
4. The other emission levels were very low against the limit.
5. " * ": Fundamental frequency.

CHANNEL	TX Channel 100	DETECTOR FUNCTION	Peak (PK)
FREQUENCY RANGE	1GHz ~ 40GHz		Average (AV)

Antenna Polarity & Test Distance : Horizontal at 3 m

No	Frequency (MHz)	Emission Level (dBuV/m)	Limit (dBuV/m)	Margin (dB)	Antenna Height (m)	Table Angle (Degree)	Raw Value (dBuV)	Correction Factor (dB/m)
1	5460.00	57.7 PK	74.0	-16.3	3.64 H	154	51.4	6.3
2	5460.00	44.8 AV	54.0	-9.2	3.64 H	154	38.5	6.3
3	#5470.00	57.9 PK	68.2	-10.3	3.64 H	154	51.6	6.3
4	*5500.00	100.6 PK	-	-	3.64 H	154	58.5	42.1
5	*5500.00	90.4 AV	-	-	3.64 H	154	48.3	42.1
6	11000.00	60.4 PK	74.0	-13.6	2.18 H	263	41.8	18.6
7	11000.00	46.5 AV	54.0	-7.5	2.18 H	263	27.9	18.6

Antenna Polarity & Test Distance : Vertical at 3 m

No	Frequency (MHz)	Emission Level (dBuV/m)	Limit (dBuV/m)	Margin (dB)	Antenna Height (m)	Table Angle (Degree)	Raw Value (dBuV)	Correction Factor (dB/m)
1	5350.00	60.6 PK	74.0	-13.4	1.12 V	91	54.2	6.4
2	5350.00	48.4 AV	54.0	-5.6	1.12 V	91	42.0	6.4
3	#5470.00	59.0 PK	68.2	-9.2	1.12 V	91	52.7	6.3
4	*5500.00	112.5 PK	-	-	1.12 V	91	70.4	42.1
5	*5500.00	102.3 AV	-	-	1.12 V	91	60.2	42.1
6	11000.00	61.9 PK	74.0	-12.1	2.34 V	249	43.3	18.6
7	11000.00	47.3 AV	54.0	-6.7	2.34 V	249	28.7	18.6

Remarks:

1. Emission Level(dBuV/m) = Raw Value(dBuV) + Correction Factor(dB/m)
2. Correction Factor(dB/m) = Antenna Factor(dB/m) + Cable Factor(dB) – Pre-Amplifier Factor(dB)
3. Margin value = Emission Level – Limit value
4. The other emission levels were very low against the limit.
5. " * ": Fundamental frequency.
6. " # ": The radiated frequency is out of the restricted band.

CHANNEL	TX Channel 116	DETECTOR FUNCTION	Peak (PK)
FREQUENCY RANGE	1GHz ~ 40GHz		Average (AV)

Antenna Polarity & Test Distance : Horizontal at 3 m								
No	Frequency (MHz)	Emission Level (dBuV/m)	Limit (dBuV/m)	Margin (dB)	Antenna Height (m)	Table Angle (Degree)	Raw Value (dBuV)	Correction Factor (dB/m)
1	*5580.00	100.7 PK	-	-	3.93 H	165	58.6	42.1
2	*5580.00	90.5 AV	-	-	3.93 H	165	48.4	42.1
3	11160.00	60.4 PK	74.0	-13.6	2.28 H	283	41.9	18.5
4	11160.00	46.6 AV	54.0	-7.4	2.28 H	283	28.1	18.5

Antenna Polarity & Test Distance : Vertical at 3 m								
No	Frequency (MHz)	Emission Level (dBuV/m)	Limit (dBuV/m)	Margin (dB)	Antenna Height (m)	Table Angle (Degree)	Raw Value (dBuV)	Correction Factor (dB/m)
1	*5580.00	111.8 PK	-	-	1.13 V	72	69.7	42.1
2	*5580.00	101.6 AV	-	-	1.13 V	72	59.5	42.1
3	11160.00	60.6 PK	74.0	-13.4	1.89 V	98	42.1	18.5
4	11160.00	47.0 AV	54.0	-7.0	1.89 V	98	28.5	18.5

Remarks:

1. Emission Level(dBuV/m) = Raw Value(dBuV) + Correction Factor(dB/m)
2. Correction Factor(dB/m) = Antenna Factor(dB/m) + Cable Factor(dB) – Pre-Amplifier Factor(dB)
3. Margin value = Emission Level – Limit value
4. The other emission levels were very low against the limit.
5. " * ": Fundamental frequency.

CHANNEL	TX Channel 140	DETECTOR FUNCTION	Peak (PK)
FREQUENCY RANGE	1GHz ~ 40GHz		Average (AV)

Antenna Polarity & Test Distance : Horizontal at 3 m								
No	Frequency (MHz)	Emission Level (dBuV/m)	Limit (dBuV/m)	Margin (dB)	Antenna Height (m)	Table Angle (Degree)	Raw Value (dBuV)	Correction Factor (dB/m)
1	*5700.00	101.3 PK	-	-	3.19 H	161	59.0	42.3
2	*5700.00	91.1 AV	-	-	3.19 H	161	48.8	42.3
3	#5725.00	58.0 PK	68.2	-10.2	3.19 H	161	51.5	6.5
4	11400.00	59.9 PK	74.0	-14.1	2.83 H	263	42.0	17.9
5	11400.00	45.7 AV	54.0	-8.3	2.83 H	263	27.8	17.9

Antenna Polarity & Test Distance : Vertical at 3 m								
No	Frequency (MHz)	Emission Level (dBuV/m)	Limit (dBuV/m)	Margin (dB)	Antenna Height (m)	Table Angle (Degree)	Raw Value (dBuV)	Correction Factor (dB/m)
1	*5700.00	112.2 PK	-	-	1.35 V	277	69.9	42.3
2	*5700.00	101.8 AV	-	-	1.35 V	277	59.5	42.3
3	#5725.00	58.1 PK	68.2	-10.1	1.35 V	277	51.6	6.5
4	11400.00	62.9 PK	74.0	-11.1	1.00 V	99	45.0	17.9
5	11400.00	48.9 AV	54.0	-5.1	1.00 V	99	31.0	17.9

Remarks:

1. Emission Level(dBuV/m) = Raw Value(dBuV) + Correction Factor(dB/m)
2. Correction Factor(dB/m) = Antenna Factor(dB/m) + Cable Factor(dB) – Pre-Amplifier Factor(dB)
3. Margin value = Emission Level – Limit value
4. The other emission levels were very low against the limit.
5. " * ": Fundamental frequency.
6. " # ": The radiated frequency is out of the restricted band.

CHANNEL	TX Channel 144	DETECTOR FUNCTION	Peak (PK) Average (AV)
FREQUENCY RANGE	1GHz ~ 40GHz		

Antenna Polarity & Test Distance : Horizontal at 3 m

No	Frequency (MHz)	Emission Level (dBuV/m)	Limit (dBuV/m)	Margin (dB)	Antenna Height (m)	Table Angle (Degree)	Raw Value (dBuV)	Correction Factor (dB/m)
1	#5470.00	58.1 PK	68.2	-10.1	3.34 H	156	51.8	6.3
2	*5720.00	101.6 PK	-	-	3.34 H	156	59.4	42.2
3	*5720.00	91.5 AV	-	-	3.34 H	156	49.3	42.2
4	#5850.00	58.8 PK	68.2	-9.4	3.34 H	156	52.0	6.8
5	11440.00	60.1 PK	74.0	-13.9	2.83 H	231	42.1	18.0
6	11440.00	45.9 AV	54.0	-8.1	2.83 H	231	27.9	18.0

Antenna Polarity & Test Distance : Vertical at 3 m

No	Frequency (MHz)	Emission Level (dBuV/m)	Limit (dBuV/m)	Margin (dB)	Antenna Height (m)	Table Angle (Degree)	Raw Value (dBuV)	Correction Factor (dB/m)
1	#5470.00	57.6 PK	68.2	-10.6	1.21 V	97	51.3	6.3
2	*5720.00	112.0 PK	-	-	1.21 V	97	69.8	42.2
3	*5720.00	101.8 AV	-	-	1.21 V	97	59.6	42.2
4	#5850.00	58.8 PK	68.2	-9.4	1.21 V	97	52.0	6.8
5	11440.00	61.4 PK	74.0	-12.6	1.01 V	96	43.4	18.0
6	11440.00	47.9 AV	54.0	-6.1	1.01 V	96	29.9	18.0

Remarks:

1. Emission Level(dBuV/m) = Raw Value(dBuV) + Correction Factor(dB/m)
2. Correction Factor(dB/m) = Antenna Factor(dB/m) + Cable Factor(dB) – Pre-Amplifier Factor(dB)
3. Margin value = Emission Level – Limit value
4. The other emission levels were very low against the limit.
5. " * ": Fundamental frequency.
6. " # ": The radiated frequency is out of the restricted band.

CHANNEL	TX Channel 149	DETECTOR FUNCTION	Peak (PK) Average (AV)
FREQUENCY RANGE	1GHz ~ 40GHz		

Antenna Polarity & Test Distance : Horizontal at 3 m								
No	Frequency (MHz)	Emission Level (dBuV/m)	Limit (dBuV/m)	Margin (dB)	Antenna Height (m)	Table Angle (Degree)	Raw Value (dBuV)	Correction Factor (dB/m)
1	*5745.00	101.5 PK	-	-	1.41 H	279	59.3	42.2
2	*5745.00	90.7 AV	-	-	1.41 H	279	48.5	42.2
3	11490.00	60.3 PK	74.0	-13.7	2.51 H	230	42.0	18.3
4	11490.00	45.7 AV	54.0	-8.3	2.51 H	230	27.4	18.3

Antenna Polarity & Test Distance : Vertical at 3 m								
No	Frequency (MHz)	Emission Level (dBuV/m)	Limit (dBuV/m)	Margin (dB)	Antenna Height (m)	Table Angle (Degree)	Raw Value (dBuV)	Correction Factor (dB/m)
1	*5745.00	112.7 PK	-	-	1.43 V	240	70.5	42.2
2	*5745.00	101.9 AV	-	-	1.43 V	240	59.7	42.2
3	11490.00	61.7 PK	74.0	-12.3	1.05 V	91	43.4	18.3
4	11490.00	47.1 AV	54.0	-6.9	1.05 V	91	28.8	18.3

<Out of Band Emission (OOBE)>

Antenna Polarity & Test Distance : Horizontal at 3 m								
No	Frequency (MHz)	Emission Level (dBuV/m)	Limit (dBuV/m)	Margin (dB)	Antenna Height (m)	Table Angle (Degree)	Raw Value (dBuV)	Correction Factor (dB/m)
1	#5619.23	57.2 PK	68.2	-11.0	1.41 H	279	51.0	6.2
2	#5970.51	59.2 PK	68.2	-9.0	1.41 H	279	52.0	7.2

Antenna Polarity & Test Distance : Vertical at 3 m								
No	Frequency (MHz)	Emission Level (dBuV/m)	Limit (dBuV/m)	Margin (dB)	Antenna Height (m)	Table Angle (Degree)	Raw Value (dBuV)	Correction Factor (dB/m)
1	#5648.08	58.8 PK	68.2	-9.4	1.43 V	240	52.5	6.3
2	#5936.54	58.8 PK	68.2	-9.4	1.43 V	240	51.5	7.3

Remarks:

1. Emission Level(dBuV/m) = Raw Value(dBuV) + Correction Factor(dB/m)
2. Correction Factor(dB/m) = Antenna Factor(dB/m) + Cable Factor(dB) – Pre-Amplifier Factor(dB)
3. Margin value = Emission Level – Limit value
4. The other emission levels were very low against the limit.
5. " * " : Fundamental frequency.
6. " # " : The radiated frequency is out of the restricted band.

CHANNEL	TX Channel 157	DETECTOR FUNCTION	Peak (PK) Average (AV)
FREQUENCY RANGE	1GHz ~ 40GHz		

Antenna Polarity & Test Distance : Horizontal at 3 m								
No	Frequency (MHz)	Emission Level (dBuV/m)	Limit (dBuV/m)	Margin (dB)	Antenna Height (m)	Table Angle (Degree)	Raw Value (dBuV)	Correction Factor (dB/m)
1	*5785.00	102.7 PK	-	-	1.44 H	233	60.5	42.2
2	*5785.00	92.4 AV	-	-	1.44 H	233	50.2	42.2
3	11570.00	62.5 PK	74.0	-11.5	2.47 H	253	44.5	18.0
4	11570.00	48.0 AV	54.0	-6.0	2.47 H	253	30.0	18.0

Antenna Polarity & Test Distance : Vertical at 3 m								
No	Frequency (MHz)	Emission Level (dBuV/m)	Limit (dBuV/m)	Margin (dB)	Antenna Height (m)	Table Angle (Degree)	Raw Value (dBuV)	Correction Factor (dB/m)
1	*5785.00	113.0 PK	-	-	1.65 V	315	70.8	42.2
2	*5785.00	102.2 AV	-	-	1.65 V	315	60.0	42.2
3	11570.00	64.1 PK	74.0	-9.9	1.05 V	82	46.1	18.0
4	11570.00	49.5 AV	54.0	-4.5	1.05 V	82	31.5	18.0

<Out of Band Emission (OOBE)>

Antenna Polarity & Test Distance : Horizontal at 3 m								
No	Frequency (MHz)	Emission Level (dBuV/m)	Limit (dBuV/m)	Margin (dB)	Antenna Height (m)	Table Angle (Degree)	Raw Value (dBuV)	Correction Factor (dB/m)
1	#5641.67	60.2 PK	68.2	-8.0	1.44 H	233	53.9	6.3
2	#5948.08	61.2 PK	68.2	-7.0	1.44 H	233	53.9	7.3

Antenna Polarity & Test Distance : Vertical at 3 m								
No	Frequency (MHz)	Emission Level (dBuV/m)	Limit (dBuV/m)	Margin (dB)	Antenna Height (m)	Table Angle (Degree)	Raw Value (dBuV)	Correction Factor (dB/m)
1	#5617.95	59.4 PK	68.2	-8.8	1.65 V	315	53.2	6.2
2	#5999.36	61.6 PK	68.2	-6.6	1.65 V	315	54.4	7.2

Remarks:

1. Emission Level(dBuV/m) = Raw Value(dBuV) + Correction Factor(dB/m)
2. Correction Factor(dB/m) = Antenna Factor(dB/m) + Cable Factor(dB) – Pre-Amplifier Factor(dB)
3. Margin value = Emission Level – Limit value
4. The other emission levels were very low against the limit.
5. " * ": Fundamental frequency.
6. " # ": The radiated frequency is out of the restricted band.

CHANNEL	TX Channel 165	DETECTOR FUNCTION	Peak (PK)
FREQUENCY RANGE	1GHz ~ 40GHz		Average (AV)

Antenna Polarity & Test Distance : Horizontal at 3 m								
No	Frequency (MHz)	Emission Level (dBuV/m)	Limit (dBuV/m)	Margin (dB)	Antenna Height (m)	Table Angle (Degree)	Raw Value (dBuV)	Correction Factor (dB/m)
1	*5825.00	101.3 PK	-	-	1.43 H	278	59.0	42.3
2	*5825.00	90.6 AV	-	-	1.43 H	278	48.3	42.3
3	11650.00	61.5 PK	74.0	-12.5	2.70 H	240	43.5	18.0
4	11650.00	47.5 AV	54.0	-6.5	2.70 H	240	29.5	18.0

Antenna Polarity & Test Distance : Vertical at 3 m								
No	Frequency (MHz)	Emission Level (dBuV/m)	Limit (dBuV/m)	Margin (dB)	Antenna Height (m)	Table Angle (Degree)	Raw Value (dBuV)	Correction Factor (dB/m)
1	*5825.00	112.5 PK	-	-	1.33 V	243	70.2	42.3
2	*5825.00	101.8 AV	-	-	1.33 V	243	59.5	42.3
3	11650.00	63.0 PK	74.0	-11.0	1.00 V	91	45.0	18.0
4	11650.00	49.0 AV	54.0	-5.0	1.00 V	91	31.0	18.0

<Out of Band Emission (OOBE)>

Antenna Polarity & Test Distance : Horizontal at 3 m								
No	Frequency (MHz)	Emission Level (dBuV/m)	Limit (dBuV/m)	Margin (dB)	Antenna Height (m)	Table Angle (Degree)	Raw Value (dBuV)	Correction Factor (dB/m)
1	#5637.82	57.8 PK	68.2	-10.4	1.43 H	278	51.5	6.3
2	#5999.36	59.3 PK	68.2	-8.9	1.43 H	278	52.1	7.2

Antenna Polarity & Test Distance : Vertical at 3 m								
No	Frequency (MHz)	Emission Level (dBuV/m)	Limit (dBuV/m)	Margin (dB)	Antenna Height (m)	Table Angle (Degree)	Raw Value (dBuV)	Correction Factor (dB/m)
1	#5610.26	57.6 PK	68.2	-10.6	1.33 V	243	51.4	6.2
2	#5950.00	59.2 PK	68.2	-9.0	1.33 V	243	51.9	7.3

Remarks:

1. Emission Level(dBuV/m) = Raw Value(dBuV) + Correction Factor(dB/m)
2. Correction Factor(dB/m) = Antenna Factor(dB/m) + Cable Factor(dB) – Pre-Amplifier Factor(dB)
3. Margin value = Emission Level – Limit value
4. The other emission levels were very low against the limit.
5. " * ": Fundamental frequency.
6. " # ": The radiated frequency is out of the restricted band.

802.11ac (VHT40)

CHANNEL	TX Channel 38	DETECTOR FUNCTION	Peak (PK) Average (AV)
FREQUENCY RANGE	1GHz ~ 40GHz		

Antenna Polarity & Test Distance : Horizontal at 3 m								
No	Frequency (MHz)	Emission Level (dBuV/m)	Limit (dBuV/m)	Margin (dB)	Antenna Height (m)	Table Angle (Degree)	Raw Value (dBuV)	Correction Factor (dB/m)
1	5150.00	59.3 PK	74.0	-14.7	1.28 H	221	52.7	6.6
2	5150.00	44.8 AV	54.0	-9.2	1.28 H	221	38.2	6.6
3	*5190.00	95.8 PK	-	-	1.28 H	221	53.7	42.1
4	*5190.00	86.5 AV	-	-	1.28 H	221	44.4	42.1
5	#10380.00	58.6 PK	68.2	-9.6	2.15 H	277	41.8	16.8

Antenna Polarity & Test Distance : Vertical at 3 m								
No	Frequency (MHz)	Emission Level (dBuV/m)	Limit (dBuV/m)	Margin (dB)	Antenna Height (m)	Table Angle (Degree)	Raw Value (dBuV)	Correction Factor (dB/m)
1	5150.00	65.3 PK	74.0	-8.7	2.22 V	91	58.7	6.6
2	5150.00	52.2 AV	54.0	-1.8	2.22 V	91	45.6	6.6
3	*5190.00	104.3 PK	-	-	2.22 V	91	62.2	42.1
4	*5190.00	94.6 AV	-	-	2.22 V	91	52.5	42.1
5	#10380.00	59.1 PK	68.2	-9.1	1.31 V	75	42.3	16.8

Remarks:

1. Emission Level(dBuV/m) = Raw Value(dBuV) + Correction Factor(dB/m)
2. Correction Factor(dB/m) = Antenna Factor(dB/m) + Cable Factor(dB) – Pre-Amplifier Factor(dB)
3. Margin value = Emission Level – Limit value
4. The other emission levels were very low against the limit.
5. " * ": Fundamental frequency.
6. " # ": The radiated frequency is out of the restricted band.

CHANNEL	TX Channel 46	DETECTOR FUNCTION	Peak (PK)
FREQUENCY RANGE	1GHz ~ 40GHz		Average (AV)

Antenna Polarity & Test Distance : Horizontal at 3 m

No	Frequency (MHz)	Emission Level (dBuV/m)	Limit (dBuV/m)	Margin (dB)	Antenna Height (m)	Table Angle (Degree)	Raw Value (dBuV)	Correction Factor (dB/m)
1	*5230.00	98.0 PK	-	-	1.25 H	211	56.0	42.0
2	*5230.00	88.2 AV	-	-	1.25 H	211	46.2	42.0
3	5350.00	57.2 PK	74.0	-16.8	1.25 H	211	50.8	6.4
4	5350.00	44.1 AV	54.0	-9.9	1.25 H	211	37.7	6.4
5	#10460.00	59.2 PK	68.2	-9.0	1.99 H	291	41.8	17.4

Antenna Polarity & Test Distance : Vertical at 3 m

No	Frequency (MHz)	Emission Level (dBuV/m)	Limit (dBuV/m)	Margin (dB)	Antenna Height (m)	Table Angle (Degree)	Raw Value (dBuV)	Correction Factor (dB/m)
1	*5230.00	106.0 PK	-	-	1.15 V	163	64.0	42.0
2	*5230.00	96.2 AV	-	-	1.15 V	163	54.2	42.0
3	5350.00	57.4 PK	74.0	-16.6	1.15 V	163	51.0	6.4
4	5350.00	44.2 AV	54.0	-9.8	1.15 V	163	37.8	6.4
5	#10460.00	59.8 PK	68.2	-8.4	1.27 V	79	42.4	17.4

Remarks:

1. Emission Level(dBuV/m) = Raw Value(dBuV) + Correction Factor(dB/m)
2. Correction Factor(dB/m) = Antenna Factor(dB/m) + Cable Factor(dB) – Pre-Amplifier Factor(dB)
3. Margin value = Emission Level – Limit value
4. The other emission levels were very low against the limit.
5. " * ": Fundamental frequency.
6. " # ": The radiated frequency is out of the restricted band.

CHANNEL	TX Channel 54	DETECTOR FUNCTION	Peak (PK)
FREQUENCY RANGE	1GHz ~ 40GHz		Average (AV)

Antenna Polarity & Test Distance : Horizontal at 3 m

No	Frequency (MHz)	Emission Level (dBuV/m)	Limit (dBuV/m)	Margin (dB)	Antenna Height (m)	Table Angle (Degree)	Raw Value (dBuV)	Correction Factor (dB/m)
1	5150.00	59.1 PK	74.0	-14.9	1.05 H	207	52.5	6.6
2	5150.00	46.1 AV	54.0	-7.9	1.05 H	207	39.5	6.6
3	*5270.00	95.0 PK	-	-	1.05 H	207	53.1	41.9
4	*5270.00	85.1 AV	-	-	1.05 H	207	43.2	41.9
5	#10540.00	59.9 PK	68.2	-8.3	2.55 H	189	42.3	17.6

Antenna Polarity & Test Distance : Vertical at 3 m

No	Frequency (MHz)	Emission Level (dBuV/m)	Limit (dBuV/m)	Margin (dB)	Antenna Height (m)	Table Angle (Degree)	Raw Value (dBuV)	Correction Factor (dB/m)
1	5150.00	48.8 PK	74.0	-25.2	1.05 V	178	42.2	6.6
2	5150.00	46.0 AV	54.0	-8.0	1.05 V	178	39.4	6.6
3	*5270.00	107.7 PK	-	-	1.05 V	178	65.8	41.9
4	*5270.00	98.3 AV	-	-	1.05 V	178	56.4	41.9
5	#10540.00	59.8 PK	68.2	-8.4	1.55 V	274	42.2	17.6

Remarks:

1. Emission Level(dBuV/m) = Raw Value(dBuV) + Correction Factor(dB/m)
2. Correction Factor(dB/m) = Antenna Factor(dB/m) + Cable Factor(dB) – Pre-Amplifier Factor(dB)
3. Margin value = Emission Level – Limit value
4. The other emission levels were very low against the limit.
5. " * ": Fundamental frequency.
6. " # ": The radiated frequency is out of the restricted band.

CHANNEL	TX Channel 62	DETECTOR FUNCTION	Peak (PK)
FREQUENCY RANGE	1GHz ~ 40GHz		Average (AV)

Antenna Polarity & Test Distance : Horizontal at 3 m

No	Frequency (MHz)	Emission Level (dBuV/m)	Limit (dBuV/m)	Margin (dB)	Antenna Height (m)	Table Angle (Degree)	Raw Value (dBuV)	Correction Factor (dB/m)
1	*5310.00	97.1 PK	-	-	1.05 H	338	55.1	42.0
2	*5310.00	87.5 AV	-	-	1.05 H	338	45.5	42.0
3	5350.00	58.2 PK	74.0	-15.8	1.05 H	338	51.8	6.4
4	5350.00	44.9 AV	54.0	-9.1	1.05 H	338	38.5	6.4
5	10620.00	59.6 PK	74.0	-14.4	1.89 H	108	42.2	17.4
6	10620.00	45.7 AV	54.0	-8.3	1.89 H	108	28.3	17.4

Antenna Polarity & Test Distance : Vertical at 3 m

No	Frequency (MHz)	Emission Level (dBuV/m)	Limit (dBuV/m)	Margin (dB)	Antenna Height (m)	Table Angle (Degree)	Raw Value (dBuV)	Correction Factor (dB/m)
1	*5310.00	109.0 PK	-	-	1.25 V	240	67.0	42.0
2	*5310.00	99.1 AV	-	-	1.25 V	240	57.1	42.0
3	5350.00	63.0 PK	74.0	-11.0	1.25 V	240	56.6	6.4
4	5350.00	49.3 AV	54.0	-4.7	1.25 V	240	42.9	6.4
5	10620.00	60.6 PK	74.0	-13.4	1.62 V	193	43.2	17.4
6	10620.00	46.0 AV	54.0	-8.0	1.62 V	193	28.6	17.4

Remarks:

1. Emission Level(dBuV/m) = Raw Value(dBuV) + Correction Factor(dB/m)
2. Correction Factor(dB/m) = Antenna Factor(dB/m) + Cable Factor(dB) – Pre-Amplifier Factor(dB)
3. Margin value = Emission Level – Limit value
4. The other emission levels were very low against the limit.
5. " * ": Fundamental frequency.

CHANNEL	TX Channel 102	DETECTOR FUNCTION	Peak (PK)
FREQUENCY RANGE	1GHz ~ 40GHz		Average (AV)

Antenna Polarity & Test Distance : Horizontal at 3 m								
No	Frequency (MHz)	Emission Level (dBuV/m)	Limit (dBuV/m)	Margin (dB)	Antenna Height (m)	Table Angle (Degree)	Raw Value (dBuV)	Correction Factor (dB/m)
1	5460.00	57.7 PK	74.0	-16.3	3.75 H	201	51.4	6.3
2	5460.00	45.1 AV	54.0	-8.9	3.75 H	201	38.8	6.3
3	#5470.00	58.9 PK	68.2	-9.3	3.75 H	201	52.6	6.3
4	*5510.00	92.8 PK	-	-	3.75 H	201	50.7	42.1
5	*5510.00	83.2 AV	-	-	3.75 H	201	41.1	42.1
6	11020.00	60.7 PK	74.0	-13.3	2.74 H	263	42.1	18.6
7	11020.00	46.9 AV	54.0	-7.1	2.74 H	263	28.3	18.6

Antenna Polarity & Test Distance : Vertical at 3 m								
No	Frequency (MHz)	Emission Level (dBuV/m)	Limit (dBuV/m)	Margin (dB)	Antenna Height (m)	Table Angle (Degree)	Raw Value (dBuV)	Correction Factor (dB/m)
1	5350.00	58.0 PK	74.0	-16.0	1.37 V	278	51.6	6.4
2	5350.00	46.0 AV	54.0	-8.0	1.37 V	278	39.6	6.4
3	#5470.00	66.6 PK	68.2	-1.6	1.37 V	278	60.3	6.3
4	*5510.00	107.3 PK	-	-	1.37 V	278	65.2	42.1
5	*5510.00	97.1 AV	-	-	1.37 V	278	55.0	42.1
6	11020.00	60.7 PK	74.0	-13.3	1.03 V	98	42.1	18.6
7	11020.00	46.6 AV	54.0	-7.4	1.03 V	98	28.0	18.6

Remarks:

1. Emission Level(dBuV/m) = Raw Value(dBuV) + Correction Factor(dB/m)
2. Correction Factor(dB/m) = Antenna Factor(dB/m) + Cable Factor(dB) – Pre-Amplifier Factor(dB)
3. Margin value = Emission Level – Limit value
4. The other emission levels were very low against the limit.
5. " * ": Fundamental frequency.
6. " # ": The radiated frequency is out of the restricted band.

CHANNEL	TX Channel 110	DETECTOR FUNCTION	Peak (PK)
FREQUENCY RANGE	1GHz ~ 40GHz		Average (AV)

Antenna Polarity & Test Distance : Horizontal at 3 m								
No	Frequency (MHz)	Emission Level (dBuV/m)	Limit (dBuV/m)	Margin (dB)	Antenna Height (m)	Table Angle (Degree)	Raw Value (dBuV)	Correction Factor (dB/m)
1	*5550.00	96.9 PK	-	-	3.73 H	152	54.8	42.1
2	*5550.00	87.0 AV	-	-	3.73 H	152	44.9	42.1
3	11100.00	60.6 PK	74.0	-13.4	2.64 H	216	42.3	18.3
4	11100.00	46.8 AV	54.0	-7.2	2.64 H	216	28.5	18.3

Antenna Polarity & Test Distance : Vertical at 3 m								
No	Frequency (MHz)	Emission Level (dBuV/m)	Limit (dBuV/m)	Margin (dB)	Antenna Height (m)	Table Angle (Degree)	Raw Value (dBuV)	Correction Factor (dB/m)
1	*5550.00	107.3 PK	-	-	1.28 V	240	65.2	42.1
2	*5550.00	97.7 AV	-	-	1.28 V	240	55.6	42.1
3	11100.00	60.5 PK	74.0	-13.5	1.05 V	94	42.2	18.3
4	11100.00	46.4 AV	54.0	-7.6	1.05 V	94	28.1	18.3

Remarks:

1. Emission Level(dBuV/m) = Raw Value(dBuV) + Correction Factor(dB/m)
2. Correction Factor(dB/m) = Antenna Factor(dB/m) + Cable Factor(dB) – Pre-Amplifier Factor(dB)
3. Margin value = Emission Level – Limit value
4. The other emission levels were very low against the limit.
5. " * ": Fundamental frequency.

CHANNEL	TX Channel 134	DETECTOR FUNCTION	Peak (PK)
FREQUENCY RANGE	1GHz ~ 40GHz		Average (AV)

Antenna Polarity & Test Distance : Horizontal at 3 m								
No	Frequency (MHz)	Emission Level (dBuV/m)	Limit (dBuV/m)	Margin (dB)	Antenna Height (m)	Table Angle (Degree)	Raw Value (dBuV)	Correction Factor (dB/m)
1	*5670.00	97.2 PK	-	-	3.52 H	145	55.0	42.2
2	*5670.00	86.9 AV	-	-	3.52 H	145	44.7	42.2
3	#5725.00	58.1 PK	68.2	-10.1	3.52 H	145	51.6	6.5
4	11340.00	60.5 PK	74.0	-13.5	2.64 H	248	42.4	18.1
5	11340.00	46.6 AV	54.0	-7.4	2.64 H	248	28.5	18.1

Antenna Polarity & Test Distance : Vertical at 3 m								
No	Frequency (MHz)	Emission Level (dBuV/m)	Limit (dBuV/m)	Margin (dB)	Antenna Height (m)	Table Angle (Degree)	Raw Value (dBuV)	Correction Factor (dB/m)
1	*5670.00	107.6 PK	-	-	1.20 V	277	65.4	42.2
2	*5670.00	98.0 AV	-	-	1.20 V	277	55.8	42.2
3	#5725.00	58.1 PK	68.2	-10.1	1.20 V	277	51.6	6.5
4	11340.00	60.3 PK	74.0	-13.7	1.02 V	94	42.2	18.1
5	11340.00	46.6 AV	54.0	-7.4	1.02 V	94	28.5	18.1

Remarks:

1. Emission Level(dBuV/m) = Raw Value(dBuV) + Correction Factor(dB/m)
2. Correction Factor(dB/m) = Antenna Factor(dB/m) + Cable Factor(dB) – Pre-Amplifier Factor(dB)
3. Margin value = Emission Level – Limit value
4. The other emission levels were very low against the limit.
5. " * ": Fundamental frequency.
6. " # ": The radiated frequency is out of the restricted band.

CHANNEL	TX Channel 142	DETECTOR FUNCTION	Peak (PK) Average (AV)
FREQUENCY RANGE	1GHz ~ 40GHz		

Antenna Polarity & Test Distance : Horizontal at 3 m

No	Frequency (MHz)	Emission Level (dBuV/m)	Limit (dBuV/m)	Margin (dB)	Antenna Height (m)	Table Angle (Degree)	Raw Value (dBuV)	Correction Factor (dB/m)
1	#5470.00	58.3 PK	68.2	-9.9	3.51 H	155	52.0	6.3
2	*5710.00	97.9 PK	-	-	3.51 H	155	55.6	42.3
3	*5710.00	88.5 AV	-	-	3.51 H	155	46.2	42.3
4	#5850.00	58.4 PK	68.2	-9.8	3.51 H	155	51.6	6.8
5	11420.00	60.2 PK	74.0	-13.8	2.89 H	198	42.3	17.9
6	11420.00	46.3 AV	54.0	-7.7	2.89 H	198	28.4	17.9

Antenna Polarity & Test Distance : Vertical at 3 m

No	Frequency (MHz)	Emission Level (dBuV/m)	Limit (dBuV/m)	Margin (dB)	Antenna Height (m)	Table Angle (Degree)	Raw Value (dBuV)	Correction Factor (dB/m)
1	#5470.00	58.7 PK	68.2	-9.5	1.09 V	273	52.4	6.3
2	*5710.00	107.6 PK	-	-	1.09 V	273	65.3	42.3
3	*5710.00	98.6 AV	-	-	1.09 V	273	56.3	42.3
4	#5850.00	58.7 PK	68.2	-9.5	1.09 V	273	51.9	6.8
5	11420.00	60.0 PK	74.0	-14.0	1.02 V	91	42.1	17.9
6	11420.00	46.5 AV	54.0	-7.5	1.02 V	91	28.6	17.9

Remarks:

1. Emission Level(dBuV/m) = Raw Value(dBuV) + Correction Factor(dB/m)
2. Correction Factor(dB/m) = Antenna Factor(dB/m) + Cable Factor(dB) – Pre-Amplifier Factor(dB)
3. Margin value = Emission Level – Limit value
4. The other emission levels were very low against the limit.
5. " * ": Fundamental frequency.
6. " # ": The radiated frequency is out of the restricted band.

CHANNEL	TX Channel 151	DETECTOR FUNCTION	Peak (PK) Average (AV)
FREQUENCY RANGE	1GHz ~ 40GHz		

Antenna Polarity & Test Distance : Horizontal at 3 m								
No	Frequency (MHz)	Emission Level (dBuV/m)	Limit (dBuV/m)	Margin (dB)	Antenna Height (m)	Table Angle (Degree)	Raw Value (dBuV)	Correction Factor (dB/m)
1	*5755.00	98.0 PK	-	-	1.42 H	280	55.7	42.3
2	*5755.00	88.3 AV	-	-	1.42 H	280	46.0	42.3
3	11510.00	59.6 PK	74.0	-14.4	2.50 H	231	41.4	18.2
4	11510.00	46.0 AV	54.0	-8.0	2.50 H	231	27.8	18.2
Antenna Polarity & Test Distance : Vertical at 3 m								
No	Frequency (MHz)	Emission Level (dBuV/m)	Limit (dBuV/m)	Margin (dB)	Antenna Height (m)	Table Angle (Degree)	Raw Value (dBuV)	Correction Factor (dB/m)
1	*5755.00	109.1 PK	-	-	1.39 V	241	66.8	42.3
2	*5755.00	99.5 AV	-	-	1.39 V	241	57.2	42.3
3	11510.00	60.6 PK	74.0	-13.4	1.06 V	92	42.4	18.2
4	11510.00	47.6 AV	54.0	-6.4	1.06 V	92	29.4	18.2

<Out of Band Emission (OOBE)>

Antenna Polarity & Test Distance : Horizontal at 3 m								
No	Frequency (MHz)	Emission Level (dBuV/m)	Limit (dBuV/m)	Margin (dB)	Antenna Height (m)	Table Angle (Degree)	Raw Value (dBuV)	Correction Factor (dB/m)
1	#5606.41	57.9 PK	68.2	-10.3	1.42 H	280	51.7	6.2
2	#5955.13	58.9 PK	68.2	-9.3	1.42 H	280	51.6	7.3
Antenna Polarity & Test Distance : Vertical at 3 m								
No	Frequency (MHz)	Emission Level (dBuV/m)	Limit (dBuV/m)	Margin (dB)	Antenna Height (m)	Table Angle (Degree)	Raw Value (dBuV)	Correction Factor (dB/m)
1	#5611.54	57.3 PK	68.2	-10.9	1.39 V	241	51.1	6.2
2	#5988.46	58.3 PK	68.2	-9.9	1.39 V	241	51.1	7.2

Remarks:

1. Emission Level(dBuV/m) = Raw Value(dBuV) + Correction Factor(dB/m)
2. Correction Factor(dB/m) = Antenna Factor(dB/m) + Cable Factor(dB) – Pre-Amplifier Factor(dB)
3. Margin value = Emission Level – Limit value
4. The other emission levels were very low against the limit.
5. " * ": Fundamental frequency.
6. " # ": The radiated frequency is out of the restricted band.

CHANNEL	TX Channel 159	DETECTOR FUNCTION	Peak (PK) Average (AV)
FREQUENCY RANGE	1GHz ~ 40GHz		

Antenna Polarity & Test Distance : Horizontal at 3 m								
No	Frequency (MHz)	Emission Level (dBuV/m)	Limit (dBuV/m)	Margin (dB)	Antenna Height (m)	Table Angle (Degree)	Raw Value (dBuV)	Correction Factor (dB/m)
1	*5795.00	97.9 PK	-	-	1.37 H	275	55.7	42.2
2	*5795.00	87.9 AV	-	-	1.37 H	275	45.7	42.2
3	11590.00	58.8 PK	74.0	-15.2	2.43 H	235	41.0	17.8
4	11590.00	45.6 AV	54.0	-8.4	2.43 H	235	27.8	17.8

Antenna Polarity & Test Distance : Vertical at 3 m								
No	Frequency (MHz)	Emission Level (dBuV/m)	Limit (dBuV/m)	Margin (dB)	Antenna Height (m)	Table Angle (Degree)	Raw Value (dBuV)	Correction Factor (dB/m)
1	*5795.00	109.1 PK	-	-	1.37 V	240	66.9	42.2
2	*5795.00	99.1 AV	-	-	1.37 V	240	56.9	42.2
3	11590.00	60.2 PK	74.0	-13.8	1.05 V	91	42.4	17.8
4	11590.00	47.2 AV	54.0	-6.8	1.05 V	91	29.4	17.8

<Out of Band Emission (OOBE)>

Antenna Polarity & Test Distance : Horizontal at 3 m								
No	Frequency (MHz)	Emission Level (dBuV/m)	Limit (dBuV/m)	Margin (dB)	Antenna Height (m)	Table Angle (Degree)	Raw Value (dBuV)	Correction Factor (dB/m)
1	#5625.00	57.9 PK	68.2	-10.3	1.37 H	275	51.7	6.2
2	#5973.08	59.8 PK	68.2	-8.4	1.37 H	275	52.6	7.2

Antenna Polarity & Test Distance : Vertical at 3 m								
No	Frequency (MHz)	Emission Level (dBuV/m)	Limit (dBuV/m)	Margin (dB)	Antenna Height (m)	Table Angle (Degree)	Raw Value (dBuV)	Correction Factor (dB/m)
1	#5641.67	57.1 PK	68.2	-11.1	1.37 V	240	50.8	6.3
2	#5977.56	58.4 PK	68.2	-9.8	1.37 V	240	51.2	7.2

Remarks:

1. Emission Level(dBuV/m) = Raw Value(dBuV) + Correction Factor(dB/m)
2. Correction Factor(dB/m) = Antenna Factor(dB/m) + Cable Factor(dB) – Pre-Amplifier Factor(dB)
3. Margin value = Emission Level – Limit value
4. The other emission levels were very low against the limit.
5. " * " : Fundamental frequency.
6. " # " : The radiated frequency is out of the restricted band.

802.11ac (VHT80)

CHANNEL	TX Channel 42	DETECTOR FUNCTION	Peak (PK) Average (AV)
FREQUENCY RANGE	1GHz ~ 40GHz		

Antenna Polarity & Test Distance : Horizontal at 3 m								
No	Frequency (MHz)	Emission Level (dBuV/m)	Limit (dBuV/m)	Margin (dB)	Antenna Height (m)	Table Angle (Degree)	Raw Value (dBuV)	Correction Factor (dB/m)
1	5150.00	57.7 PK	74.0	-16.3	1.31 H	218	51.1	6.6
2	5150.00	44.6 AV	54.0	-9.4	1.31 H	218	38.0	6.6
3	*5210.00	94.3 PK	-	-	1.31 H	218	52.3	42.0
4	*5210.00	84.8 AV	-	-	1.31 H	218	42.8	42.0
5	5350.00	56.9 PK	74.0	-17.1	1.31 H	218	50.5	6.4
6	5350.00	44.3 AV	54.0	-9.7	1.31 H	218	37.9	6.4
7	#10420.00	59.2 PK	68.2	-9.0	1.88 H	272	42.0	17.2
Antenna Polarity & Test Distance : Vertical at 3 m								
No	Frequency (MHz)	Emission Level (dBuV/m)	Limit (dBuV/m)	Margin (dB)	Antenna Height (m)	Table Angle (Degree)	Raw Value (dBuV)	Correction Factor (dB/m)
1	5150.00	63.8 PK	74.0	-10.2	1.29 V	165	57.2	6.6
2	5150.00	52.4 AV	54.0	-1.6	1.29 V	165	45.8	6.6
3	*5210.00	102.3 PK	-	-	1.29 V	165	60.3	42.0
4	*5210.00	92.7 AV	-	-	1.29 V	165	50.7	42.0
5	5350.00	57.2 PK	74.0	-16.8	1.29 V	165	50.8	6.4
6	5350.00	44.7 AV	54.0	-9.3	1.29 V	165	38.3	6.4
7	#10420.00	59.7 PK	68.2	-8.5	1.22 V	82	42.5	17.2

Remarks:

1. Emission Level(dBuV/m) = Raw Value(dBuV) + Correction Factor(dB/m)
2. Correction Factor(dB/m) = Antenna Factor(dB/m) + Cable Factor(dB) – Pre-Amplifier Factor(dB)
3. Margin value = Emission Level – Limit value
4. The other emission levels were very low against the limit.
5. " * ": Fundamental frequency.
6. " # ": The radiated frequency is out of the restricted band.

CHANNEL	TX Channel 58	DETECTOR FUNCTION	Peak (PK)
FREQUENCY RANGE	1GHz ~ 40GHz		Average (AV)

Antenna Polarity & Test Distance : Horizontal at 3 m

No	Frequency (MHz)	Emission Level (dBuV/m)	Limit (dBuV/m)	Margin (dB)	Antenna Height (m)	Table Angle (Degree)	Raw Value (dBuV)	Correction Factor (dB/m)
1	5150.00	59.0 PK	74.0	-15.0	1.50 H	329	52.4	6.6
2	5150.00	46.5 AV	54.0	-7.5	1.50 H	329	39.9	6.6
3	*5290.00	94.6 PK	-	-	1.50 H	329	52.7	41.9
4	*5290.00	85.2 AV	-	-	1.50 H	329	43.3	41.9
5	5350.00	58.9 PK	74.0	-15.1	1.50 H	329	52.5	6.4
6	5350.00	45.4 AV	54.0	-8.6	1.50 H	329	39.0	6.4
7	#10580.00	59.2 PK	68.2	-9.0	2.28 H	216	41.8	17.4

Antenna Polarity & Test Distance : Vertical at 3 m

No	Frequency (MHz)	Emission Level (dBuV/m)	Limit (dBuV/m)	Margin (dB)	Antenna Height (m)	Table Angle (Degree)	Raw Value (dBuV)	Correction Factor (dB/m)
1	5150.00	59.1 PK	74.0	-14.9	1.30 V	242	52.5	6.6
2	5150.00	48.9 AV	54.0	-5.1	1.30 V	242	42.3	6.6
3	*5290.00	107.8 PK	-	-	1.30 V	242	65.9	41.9
4	*5290.00	98.2 AV	-	-	1.30 V	242	56.3	41.9
5	5350.00	61.0 PK	74.0	-13.0	1.30 V	242	54.6	6.4
6	5350.00	48.4 AV	54.0	-5.6	1.30 V	242	42.0	6.4
7	#10580.00	59.8 PK	68.2	-8.4	1.98 V	137	42.4	17.4

Remarks:

1. Emission Level(dBuV/m) = Raw Value(dBuV) + Correction Factor(dB/m)
2. Correction Factor(dB/m) = Antenna Factor(dB/m) + Cable Factor(dB) – Pre-Amplifier Factor(dB)
3. Margin value = Emission Level – Limit value
4. The other emission levels were very low against the limit.
5. " * ": Fundamental frequency.
6. " # ": The radiated frequency is out of the restricted band.

CHANNEL	TX Channel 106	DETECTOR FUNCTION	Peak (PK)
FREQUENCY RANGE	1GHz ~ 40GHz		Average (AV)

Antenna Polarity & Test Distance : Horizontal at 3 m								
No	Frequency (MHz)	Emission Level (dBuV/m)	Limit (dBuV/m)	Margin (dB)	Antenna Height (m)	Table Angle (Degree)	Raw Value (dBuV)	Correction Factor (dB/m)
1	5460.00	58.0 PK	74.0	-16.0	3.77 H	140	51.7	6.3
2	5460.00	45.5 AV	54.0	-8.5	3.77 H	140	39.2	6.3
3	#5470.00	58.9 PK	68.2	-9.3	3.77 H	140	52.6	6.3
4	*5530.00	92.1 PK	-	-	3.77 H	140	50.0	42.1
5	*5530.00	82.8 AV	-	-	3.77 H	140	40.7	42.1
6	#5725.00	57.8 PK	68.2	-10.4	3.77 H	140	51.3	6.5
7	11060.00	60.7 PK	74.0	-13.3	2.27 H	271	42.3	18.4
8	11060.00	46.8 AV	54.0	-7.2	2.27 H	271	28.4	18.4

Antenna Polarity & Test Distance : Vertical at 3 m								
No	Frequency (MHz)	Emission Level (dBuV/m)	Limit (dBuV/m)	Margin (dB)	Antenna Height (m)	Table Angle (Degree)	Raw Value (dBuV)	Correction Factor (dB/m)
1	5460.00	65.7 PK	74.0	-8.3	1.26 V	239	59.4	6.3
2	5460.00	51.3 AV	54.0	-2.7	1.26 V	239	45.0	6.3
3	#5470.00	66.6 PK	68.2	-1.6	1.26 V	239	60.3	6.3
4	*5530.00	103.6 PK	-	-	1.26 V	239	61.5	42.1
5	*5530.00	94.2 AV	-	-	1.26 V	239	52.1	42.1
6	#5725.00	57.8 PK	68.2	-10.4	1.26 V	239	51.3	6.5
7	11060.00	60.6 PK	74.0	-13.4	1.03 V	91	42.2	18.4
8	11060.00	46.8 AV	54.0	-7.2	1.03 V	91	28.4	18.4

Remarks:

1. Emission Level(dBuV/m) = Raw Value(dBuV) + Correction Factor(dB/m)
2. Correction Factor(dB/m) = Antenna Factor(dB/m) + Cable Factor(dB) – Pre-Amplifier Factor(dB)
3. Margin value = Emission Level – Limit value
4. The other emission levels were very low against the limit.
5. " * ": Fundamental frequency.
6. " # ": The radiated frequency is out of the restricted band.

CHANNEL	TX Channel 122	DETECTOR FUNCTION	Peak (PK) Average (AV)
FREQUENCY RANGE	1GHz ~ 40GHz		

Antenna Polarity & Test Distance : Horizontal at 3 m								
No	Frequency (MHz)	Emission Level (dBuV/m)	Limit (dBuV/m)	Margin (dB)	Antenna Height (m)	Table Angle (Degree)	Raw Value (dBuV)	Correction Factor (dB/m)
1	5460.00	58.0 PK	74.0	-16.0	3.47 H	171	51.7	6.3
2	5460.00	45.3 AV	54.0	-8.7	3.47 H	171	39.0	6.3
3	#5470.00	57.8 PK	68.2	-10.4	3.47 H	171	51.5	6.3
4	*5610.00	94.4 PK	-	-	3.47 H	171	52.3	42.1
5	*5610.00	85.2 AV	-	-	3.47 H	171	43.1	42.1
6	#5725.00	57.8 PK	68.2	-10.4	3.47 H	171	51.3	6.5
7	11220.00	60.8 PK	74.0	-13.2	2.16 H	262	42.3	18.5
8	11220.00	47.0 AV	54.0	-7.0	2.16 H	262	28.5	18.5

Antenna Polarity & Test Distance : Vertical at 3 m								
No	Frequency (MHz)	Emission Level (dBuV/m)	Limit (dBuV/m)	Margin (dB)	Antenna Height (m)	Table Angle (Degree)	Raw Value (dBuV)	Correction Factor (dB/m)
1	5460.00	58.5 PK	74.0	-15.5	1.37 V	242	52.2	6.3
2	5460.00	45.8 AV	54.0	-8.2	1.37 V	242	39.5	6.3
3	#5470.00	58.5 PK	68.2	-9.7	1.37 V	242	52.2	6.3
4	*5610.00	104.4 PK	-	-	1.37 V	242	62.3	42.1
5	*5610.00	95.0 AV	-	-	1.37 V	242	52.9	42.1
6	#5725.00	58.1 PK	68.2	-10.1	1.37 V	242	51.6	6.5
7	11220.00	60.5 PK	74.0	-13.5	1.03 V	97	42.0	18.5
8	11220.00	46.9 AV	54.0	-7.1	1.03 V	97	28.4	18.5

Remarks:

1. Emission Level(dBuV/m) = Raw Value(dBuV) + Correction Factor(dB/m)
2. Correction Factor(dB/m) = Antenna Factor(dB/m) + Cable Factor(dB) – Pre-Amplifier Factor(dB)
3. Margin value = Emission Level – Limit value
4. The other emission levels were very low against the limit.
5. " * ": Fundamental frequency.
6. " # ": The radiated frequency is out of the restricted band.

CHANNEL	TX Channel 138	DETECTOR FUNCTION	Peak (PK) Average (AV)
FREQUENCY RANGE	1GHz ~ 40GHz		

Antenna Polarity & Test Distance : Horizontal at 3 m

No	Frequency (MHz)	Emission Level (dBuV/m)	Limit (dBuV/m)	Margin (dB)	Antenna Height (m)	Table Angle (Degree)	Raw Value (dBuV)	Correction Factor (dB/m)
1	#5470.00	58.1 PK	68.2	-10.1	3.40 H	153	51.8	6.3
2	*5690.00	95.0 PK	-	-	3.40 H	153	52.7	42.3
3	*5690.00	85.5 AV	-	-	3.40 H	153	43.2	42.3
4	#5850.00	58.8 PK	68.2	-9.4	3.40 H	153	52.0	6.8
5	11380.00	60.2 PK	74.0	-13.8	2.65 H	256	42.4	17.8
6	11380.00	46.4 AV	54.0	-7.6	2.65 H	256	28.6	17.8

Antenna Polarity & Test Distance : Vertical at 3 m

No	Frequency (MHz)	Emission Level (dBuV/m)	Limit (dBuV/m)	Margin (dB)	Antenna Height (m)	Table Angle (Degree)	Raw Value (dBuV)	Correction Factor (dB/m)
1	#5470.00	58.2 PK	68.2	-10.0	1.44 V	246	51.9	6.3
2	*5690.00	105.8 PK	-	-	1.44 V	246	63.5	42.3
3	*5690.00	96.6 AV	-	-	1.44 V	246	54.3	42.3
4	#5850.00	58.8 PK	68.2	-9.4	1.44 V	246	52.0	6.8
5	11380.00	60.1 PK	74.0	-13.9	1.00 V	99	42.3	17.8
6	11380.00	46.6 AV	54.0	-7.4	1.00 V	99	28.8	17.8

Remarks:

1. Emission Level(dBuV/m) = Raw Value(dBuV) + Correction Factor(dB/m)
2. Correction Factor(dB/m) = Antenna Factor(dB/m) + Cable Factor(dB) – Pre-Amplifier Factor(dB)
3. Margin value = Emission Level – Limit value
4. The other emission levels were very low against the limit.
5. " * ": Fundamental frequency.
6. " # ": The radiated frequency is out of the restricted band.

CHANNEL	TX Channel 155	DETECTOR FUNCTION	Peak (PK) Average (AV)
FREQUENCY RANGE	1GHz ~ 40GHz		

Antenna Polarity & Test Distance : Horizontal at 3 m								
No	Frequency (MHz)	Emission Level (dBuV/m)	Limit (dBuV/m)	Margin (dB)	Antenna Height (m)	Table Angle (Degree)	Raw Value (dBuV)	Correction Factor (dB/m)
1	#5650.00	56.9 PK	68.2	-11.3	1.40 H	276	50.6	6.3
2	*5775.00	95.8 PK	-	-	1.40 H	276	53.6	42.2
3	*5775.00	86.4 AV	-	-	1.40 H	276	44.2	42.2
4	#5925.00	57.8 PK	68.2	-10.4	1.40 H	276	50.5	7.3
5	11550.00	59.3 PK	74.0	-14.7	2.47 H	228	41.2	18.1
6	11550.00	46.8 AV	54.0	-7.2	2.47 H	228	28.7	18.1

Antenna Polarity & Test Distance : Vertical at 3 m								
No	Frequency (MHz)	Emission Level (dBuV/m)	Limit (dBuV/m)	Margin (dB)	Antenna Height (m)	Table Angle (Degree)	Raw Value (dBuV)	Correction Factor (dB/m)
1	#5650.00	57.6 PK	68.2	-10.6	1.39 V	242	51.3	6.3
2	*5775.00	106.9 PK	-	-	1.39 V	242	64.7	42.2
3	*5775.00	97.5 AV	-	-	1.39 V	242	55.3	42.2
4	#5925.00	59.4 PK	68.2	-8.8	1.39 V	242	52.1	7.3
5	11550.00	60.7 PK	74.0	-13.3	1.07 V	90	42.6	18.1
6	11550.00	48.2 AV	54.0	-5.8	1.07 V	90	30.1	18.1

<Out of Band Emission (OOBE)>

Antenna Polarity & Test Distance : Horizontal at 3 m								
No	Frequency (MHz)	Emission Level (dBuV/m)	Limit (dBuV/m)	Margin (dB)	Antenna Height (m)	Table Angle (Degree)	Raw Value (dBuV)	Correction Factor (dB/m)
1	#5624.36	57.4 PK	68.2	-10.8	1.40 H	276	51.2	6.2
2	#5939.10	58.6 PK	68.2	-9.6	1.40 H	276	51.3	7.3

Antenna Polarity & Test Distance : Vertical at 3 m								
No	Frequency (MHz)	Emission Level (dBuV/m)	Limit (dBuV/m)	Margin (dB)	Antenna Height (m)	Table Angle (Degree)	Raw Value (dBuV)	Correction Factor (dB/m)
1	#5649.36	57.7 PK	68.2	-10.5	1.39 V	242	51.4	6.3
2	#5980.77	58.7 PK	68.2	-9.5	1.39 V	242	51.5	7.2

Remarks:

1. Emission Level(dBuV/m) = Raw Value(dBuV) + Correction Factor(dB/m)
2. Correction Factor(dB/m) = Antenna Factor(dB/m) + Cable Factor(dB) – Pre-Amplifier Factor(dB)
3. Margin value = Emission Level – Limit value
4. The other emission levels were very low against the limit.
5. " * ": Fundamental frequency.
6. " # ": The radiated frequency is out of the restricted band.

9 kHz ~ 30 MHz Data:

The amplitude of spurious emissions attenuated more than 20 dB below the permissible value is not required to be report.

30 MHz ~ 1 GHz Worst-Case Data:

802.11ac (VHT80)

CHANNEL	TX Channel 42	DETECTOR FUNCTION	Quasi-Peak (QP)
FREQUENCY RANGE	30MHz ~ 1GHz		

Antenna Polarity & Test Distance : Horizontal at 3 m								
No	Frequency (MHz)	Emission Level (dBuV/m)	Limit (dBuV/m)	Margin (dB)	Antenna Height (m)	Table Angle (Degree)	Raw Value (dBuV)	Correction Factor (dB/m)
1	46.87	20.9 QP	40.0	-19.1	1.00 H	271	30.1	-9.2
2	218.38	24.8 QP	46.0	-21.2	1.50 H	238	35.4	-10.6
3	263.36	31.8 QP	46.0	-14.2	1.50 H	275	39.6	-7.8
4	311.16	27.5 QP	46.0	-18.5	1.00 H	143	33.8	-6.3
5	509.38	33.5 QP	46.0	-12.5	2.00 H	254	35.7	-2.2
6	641.52	31.1 QP	46.0	-14.9	1.50 H	63	30.0	1.1

Remarks:

1. Emission Level(dBuV/m) = Raw Value(dBuV) + Correction Factor(dB/m)
2. Correction Factor(dB/m) = Antenna Factor(dB/m) + Cable Factor(dB) – Pre-Amplifier Factor(dB)
3. Margin value = Emission Level – Limit value
4. The other emission levels were very low against the limit of frequency range 30MHz~1000MHz.
5. The emission levels were very low against the limit of frequency range 9kHz~30MHz: the amplitude of spurious emissions attenuated more than 20 dB below the permissible value to be report.

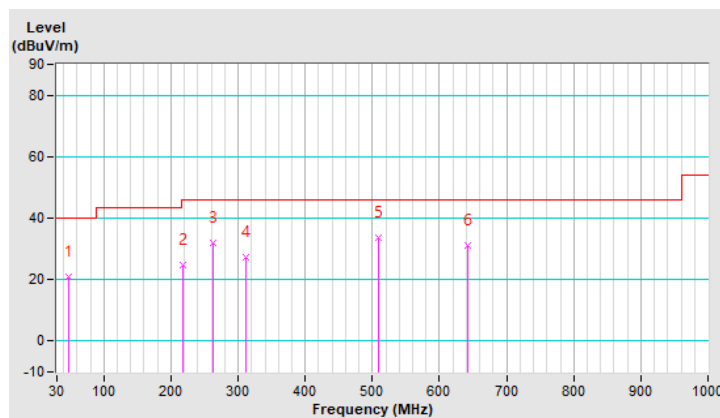

CHANNEL	TX Channel 42	DETECTOR FUNCTION	Quasi-Peak (QP)
FREQUENCY RANGE	30MHz ~ 1GHz		

Antenna Polarity & Test Distance : Vertical at 3 m								
No	Frequency (MHz)	Emission Level (dBuV/m)	Limit (dBuV/m)	Margin (dB)	Antenna Height (m)	Table Angle (Degree)	Raw Value (dBuV)	Correction Factor (dB/m)
1	49.68	32.0 QP	40.0	-8.0	2.00 V	38	41.1	-9.1
2	134.03	26.0 QP	43.5	-17.5	1.50 V	102	35.5	-9.5
3	263.36	30.2 QP	46.0	-15.8	1.50 V	168	38.0	-7.8
4	318.19	35.1 QP	46.0	-10.9	1.00 V	131	41.2	-6.1
5	360.36	33.5 QP	46.0	-12.5	1.50 V	15	38.9	-5.4
6	478.45	31.0 QP	46.0	-15.0	1.00 V	345	33.6	-2.6

Remarks:

1. Emission Level(dBuV/m) = Raw Value(dBuV) + Correction Factor(dB/m)
2. Correction Factor(dB/m) = Antenna Factor(dB/m) + Cable Factor(dB) – Pre-Amplifier Factor(dB)
3. Margin value = Emission Level – Limit value
4. The other emission levels were very low against the limit of frequency range 30MHz~1000MHz.
5. The emission levels were very low against the limit of frequency range 9kHz~30MHz: the amplitude of spurious emissions attenuated more than 20 dB below the permissible value to be report.

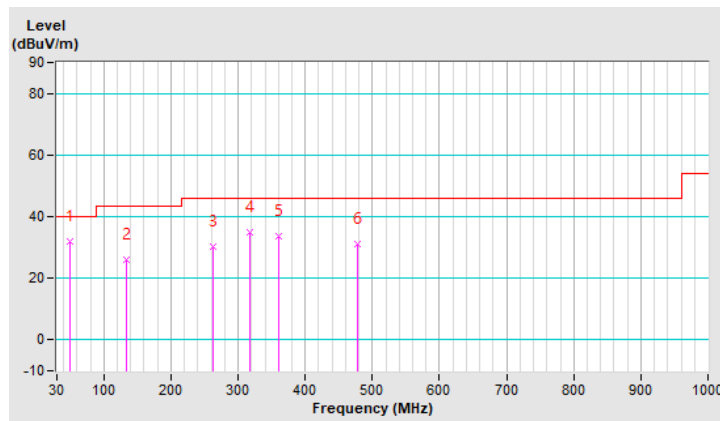

Mode B
802.11a

CHANNEL	TX Channel 36	DETECTOR FUNCTION	Peak (PK)
FREQUENCY RANGE	1GHz ~ 40GHz		Average (AV)

Antenna Polarity & Test Distance : Horizontal at 3 m

No	Frequency (MHz)	Emission Level (dBuV/m)	Limit (dBuV/m)	Margin (dB)	Antenna Height (m)	Table Angle (Degree)	Raw Value (dBuV)	Correction Factor (dB/m)
1	5083.00	58.4 PK	74.0	-15.6	1.12 H	272	51.8	6.6
2	5083.00	45.5 AV	54.0	-8.5	1.12 H	272	38.9	6.6
3	*5180.00	105.4 PK	-	-	1.12 H	272	63.2	42.2
4	*5180.00	95.2 AV	-	-	1.12 H	272	53.0	42.2
5	#10360.00	58.1 PK	68.2	-10.1	1.93 H	152	41.4	16.7

Antenna Polarity & Test Distance : Vertical at 3 m

No	Frequency (MHz)	Emission Level (dBuV/m)	Limit (dBuV/m)	Margin (dB)	Antenna Height (m)	Table Angle (Degree)	Raw Value (dBuV)	Correction Factor (dB/m)
1	5083.00	60.3 PK	74.0	-13.7	1.86 V	325	53.7	6.6
2	5083.00	49.0 AV	54.0	-5.0	1.86 V	325	42.4	6.6
3	*5180.00	111.7 PK	-	-	1.86 V	325	69.5	42.2
4	*5180.00	101.5 AV	-	-	1.86 V	325	59.3	42.2
5	#10360.00	58.3 PK	68.2	-9.9	1.63 V	25	41.6	16.7

Remarks:

1. Emission Level(dBuV/m) = Raw Value(dBuV) + Correction Factor(dB/m)
2. Correction Factor(dB/m) = Antenna Factor(dB/m) + Cable Factor(dB) – Pre-Amplifier Factor(dB)
3. Margin value = Emission Level – Limit value
4. The other emission levels were very low against the limit.
5. " * ": Fundamental frequency.
6. " # ": The radiated frequency is out of the restricted band.

CHANNEL	TX Channel 40	DETECTOR FUNCTION	Peak (PK)
FREQUENCY RANGE	1GHz ~ 40GHz		Average (AV)

Antenna Polarity & Test Distance : Horizontal at 3 m								
No	Frequency (MHz)	Emission Level (dBuV/m)	Limit (dBuV/m)	Margin (dB)	Antenna Height (m)	Table Angle (Degree)	Raw Value (dBuV)	Correction Factor (dB/m)
1	*5200.00	105.2 PK	-	-	1.20 H	277	63.1	42.1
2	*5200.00	95.0 AV	-	-	1.20 H	277	52.9	42.1
3	#10400.00	58.6 PK	68.2	-9.6	1.99 H	160	41.7	16.9

Antenna Polarity & Test Distance : Vertical at 3 m								
No	Frequency (MHz)	Emission Level (dBuV/m)	Limit (dBuV/m)	Margin (dB)	Antenna Height (m)	Table Angle (Degree)	Raw Value (dBuV)	Correction Factor (dB/m)
1	*5200.00	111.5 PK	-	-	1.92 V	324	69.4	42.1
2	*5200.00	101.5 AV	-	-	1.92 V	324	59.4	42.1
3	#10400.00	58.9 PK	68.2	-9.3	1.58 V	30	42.0	16.9

Remarks:

1. Emission Level(dBuV/m) = Raw Value(dBuV) + Correction Factor(dB/m)
2. Correction Factor(dB/m) = Antenna Factor(dB/m) + Cable Factor(dB) – Pre-Amplifier Factor(dB)
3. Margin value = Emission Level – Limit value
4. The other emission levels were very low against the limit.
5. " * " : Fundamental frequency.
6. " # " : The radiated frequency is out of the restricted band.

CHANNEL	TX Channel 48	DETECTOR FUNCTION	Peak (PK)
FREQUENCY RANGE	1GHz ~ 40GHz		Average (AV)

Antenna Polarity & Test Distance : Horizontal at 3 m

No	Frequency (MHz)	Emission Level (dBuV/m)	Limit (dBuV/m)	Margin (dB)	Antenna Height (m)	Table Angle (Degree)	Raw Value (dBuV)	Correction Factor (dB/m)
1	5141.00	58.2 PK	74.0	-15.8	1.18 H	274	51.6	6.6
2	5141.00	44.8 AV	54.0	-9.2	1.18 H	274	38.2	6.6
3	*5240.00	105.5 PK	-	-	1.18 H	274	63.5	42.0
4	*5240.00	95.1 AV	-	-	1.18 H	274	53.1	42.0
5	#10480.00	59.5 PK	68.2	-8.7	2.01 H	160	41.8	17.7

Antenna Polarity & Test Distance : Vertical at 3 m

No	Frequency (MHz)	Emission Level (dBuV/m)	Limit (dBuV/m)	Margin (dB)	Antenna Height (m)	Table Angle (Degree)	Raw Value (dBuV)	Correction Factor (dB/m)
1	5141.00	60.2 PK	74.0	-13.8	1.71 V	327	53.6	6.6
2	5141.00	48.4 AV	54.0	-5.6	1.71 V	327	41.8	6.6
3	*5240.00	111.6 PK	-	-	1.71 V	327	69.6	42.0
4	*5240.00	101.2 AV	-	-	1.71 V	327	59.2	42.0
5	#10480.00	59.8 PK	68.2	-8.4	1.69 V	31	42.1	17.7

Remarks:

1. Emission Level(dBuV/m) = Raw Value(dBuV) + Correction Factor(dB/m)
2. Correction Factor(dB/m) = Antenna Factor(dB/m) + Cable Factor(dB) – Pre-Amplifier Factor(dB)
3. Margin value = Emission Level – Limit value
4. The other emission levels were very low against the limit.
5. " * ": Fundamental frequency.
6. " # ": The radiated frequency is out of the restricted band.

CHANNEL	TX Channel 52	DETECTOR FUNCTION	Peak (PK)
FREQUENCY RANGE	1GHz ~ 40GHz		Average (AV)

Antenna Polarity & Test Distance : Horizontal at 3 m

No	Frequency (MHz)	Emission Level (dBuV/m)	Limit (dBuV/m)	Margin (dB)	Antenna Height (m)	Table Angle (Degree)	Raw Value (dBuV)	Correction Factor (dB/m)
1	5150.00	58.6 PK	74.0	-15.4	1.18 H	190	52.0	6.6
2	5150.00	45.7 AV	54.0	-8.3	1.18 H	190	39.1	6.6
3	*5260.00	104.2 PK	-	-	1.18 H	190	62.3	41.9
4	*5260.00	93.9 AV	-	-	1.18 H	190	52.0	41.9
5	#10520.00	60.1 PK	68.2	-8.1	2.69 H	287	42.5	17.6

Antenna Polarity & Test Distance : Vertical at 3 m

No	Frequency (MHz)	Emission Level (dBuV/m)	Limit (dBuV/m)	Margin (dB)	Antenna Height (m)	Table Angle (Degree)	Raw Value (dBuV)	Correction Factor (dB/m)
1	5150.00	58.6 PK	74.0	-15.4	1.76 V	351	52.0	6.6
2	5150.00	45.9 AV	54.0	-8.1	1.76 V	351	39.3	6.6
3	*5260.00	111.3 PK	-	-	1.76 V	351	69.4	41.9
4	*5260.00	101.3 AV	-	-	1.76 V	351	59.4	41.9
5	#10520.00	60.4 PK	68.2	-7.8	3.93 V	248	42.8	17.6

Remarks:

1. Emission Level(dBuV/m) = Raw Value(dBuV) + Correction Factor(dB/m)
2. Correction Factor(dB/m) = Antenna Factor(dB/m) + Cable Factor(dB) – Pre-Amplifier Factor(dB)
3. Margin value = Emission Level – Limit value
4. The other emission levels were very low against the limit.
5. " * ": Fundamental frequency.
6. " # ": The radiated frequency is out of the restricted band.

CHANNEL	TX Channel 60	DETECTOR FUNCTION	Peak (PK)
FREQUENCY RANGE	1GHz ~ 40GHz		Average (AV)

Antenna Polarity & Test Distance : Horizontal at 3 m

No	Frequency (MHz)	Emission Level (dBuV/m)	Limit (dBuV/m)	Margin (dB)	Antenna Height (m)	Table Angle (Degree)	Raw Value (dBuV)	Correction Factor (dB/m)
1	*5300.00	105.4 PK	-	-	1.17 H	276	63.5	41.9
2	*5300.00	95.4 AV	-	-	1.17 H	276	53.5	41.9
3	10600.00	59.6 PK	74.0	-14.4	2.83 H	197	42.4	17.2
4	10600.00	45.5 AV	54.0	-8.5	2.83 H	197	28.3	17.2

Antenna Polarity & Test Distance : Vertical at 3 m

No	Frequency (MHz)	Emission Level (dBuV/m)	Limit (dBuV/m)	Margin (dB)	Antenna Height (m)	Table Angle (Degree)	Raw Value (dBuV)	Correction Factor (dB/m)
1	*5300.00	112.3 PK	-	-	1.98 V	298	70.4	41.9
2	*5300.00	102.2 AV	-	-	1.98 V	298	60.3	41.9
3	10600.00	60.2 PK	74.0	-13.8	2.48 V	114	43.0	17.2
4	10600.00	46.4 AV	54.0	-7.6	2.48 V	114	29.2	17.2

Remarks:

1. Emission Level(dBuV/m) = Raw Value(dBuV) + Correction Factor(dB/m)
2. Correction Factor(dB/m) = Antenna Factor(dB/m) + Cable Factor(dB) – Pre-Amplifier Factor(dB)
3. Margin value = Emission Level – Limit value
4. The other emission levels were very low against the limit.
5. " * ": Fundamental frequency.

CHANNEL	TX Channel 64	DETECTOR FUNCTION	Peak (PK) Average (AV)
FREQUENCY RANGE	1GHz ~ 40GHz		

Antenna Polarity & Test Distance : Horizontal at 3 m

No	Frequency (MHz)	Emission Level (dBuV/m)	Limit (dBuV/m)	Margin (dB)	Antenna Height (m)	Table Angle (Degree)	Raw Value (dBuV)	Correction Factor (dB/m)
1	*5320.00	103.4 PK	-	-	1.25 H	276	61.4	42.0
2	*5320.00	93.0 AV	-	-	1.25 H	276	51.0	42.0
3	5350.00	58.4 PK	74.0	-15.6	1.25 H	276	52.0	6.4
4	5350.00	44.8 AV	54.0	-9.2	1.25 H	276	38.4	6.4
5	10640.00	59.5 PK	74.0	-14.5	2.69 H	113	42.1	17.4
6	10640.00	46.1 AV	54.0	-7.9	2.69 H	113	28.7	17.4

Antenna Polarity & Test Distance : Vertical at 3 m

No	Frequency (MHz)	Emission Level (dBuV/m)	Limit (dBuV/m)	Margin (dB)	Antenna Height (m)	Table Angle (Degree)	Raw Value (dBuV)	Correction Factor (dB/m)
1	*5320.00	112.7 PK	-	-	2.36 V	273	70.7	42.0
2	*5320.00	101.5 AV	-	-	2.36 V	273	59.5	42.0
3	5350.00	58.8 PK	74.0	-15.2	2.36 V	273	52.4	6.4
4	5350.00	47.1 AV	54.0	-6.9	2.36 V	273	40.7	6.4
5	10640.00	59.4 PK	74.0	-14.6	2.18 V	99	42.0	17.4
6	10640.00	46.4 AV	54.0	-7.6	2.18 V	99	29.0	17.4

Remarks:

1. Emission Level(dBuV/m) = Raw Value(dBuV) + Correction Factor(dB/m)
2. Correction Factor(dB/m) = Antenna Factor(dB/m) + Cable Factor(dB) – Pre-Amplifier Factor(dB)
3. Margin value = Emission Level – Limit value
4. The other emission levels were very low against the limit.
5. " * ": Fundamental frequency.

CHANNEL	TX Channel 100	DETECTOR FUNCTION	Peak (PK)
FREQUENCY RANGE	1GHz ~ 40GHz		Average (AV)

Antenna Polarity & Test Distance : Horizontal at 3 m								
No	Frequency (MHz)	Emission Level (dBuV/m)	Limit (dBuV/m)	Margin (dB)	Antenna Height (m)	Table Angle (Degree)	Raw Value (dBuV)	Correction Factor (dB/m)
1	5350.00	57.8 PK	74.0	-16.2	1.14 H	276	51.4	6.4
2	5350.00	45.0 AV	54.0	-9.0	1.14 H	276	38.6	6.4
3	#5470.00	58.1 PK	68.2	-10.1	1.14 H	276	51.8	6.3
4	*5500.00	106.6 PK	-	-	1.14 H	276	64.5	42.1
5	*5500.00	96.5 AV	-	-	1.14 H	276	54.4	42.1
6	11000.00	61.1 PK	74.0	-12.9	2.88 H	151	42.5	18.6
7	11000.00	46.9 AV	54.0	-7.1	2.88 H	151	28.3	18.6

Antenna Polarity & Test Distance : Vertical at 3 m								
No	Frequency (MHz)	Emission Level (dBuV/m)	Limit (dBuV/m)	Margin (dB)	Antenna Height (m)	Table Angle (Degree)	Raw Value (dBuV)	Correction Factor (dB/m)
1	5460.00	58.9 PK	74.0	-15.1	2.76 V	255	52.6	6.3
2	5460.00	47.3 AV	54.0	-6.7	2.76 V	255	41.0	6.3
3	#5470.00	61.1 PK	68.2	-7.1	2.76 V	255	54.8	6.3
4	*5500.00	114.5 PK	-	-	2.76 V	255	72.4	42.1
5	*5500.00	104.0 AV	-	-	2.76 V	255	61.9	42.1
6	11000.00	62.4 PK	74.0	-11.6	1.20 V	64	43.8	18.6
7	11000.00	48.5 AV	54.0	-5.5	1.20 V	64	29.9	18.6

Remarks:

1. Emission Level(dBuV/m) = Raw Value(dBuV) + Correction Factor(dB/m)
2. Correction Factor(dB/m) = Antenna Factor(dB/m) + Cable Factor(dB) – Pre-Amplifier Factor(dB)
3. Margin value = Emission Level – Limit value
4. The other emission levels were very low against the limit.
5. " * ": Fundamental frequency.
6. " # ": The radiated frequency is out of the restricted band.

CHANNEL	TX Channel 116	DETECTOR FUNCTION	Peak (PK)
FREQUENCY RANGE	1GHz ~ 40GHz		Average (AV)

Antenna Polarity & Test Distance : Horizontal at 3 m

No	Frequency (MHz)	Emission Level (dBuV/m)	Limit (dBuV/m)	Margin (dB)	Antenna Height (m)	Table Angle (Degree)	Raw Value (dBuV)	Correction Factor (dB/m)
1	*5580.00	106.4 PK	-	-	1.09 H	277	64.3	42.1
2	*5580.00	96.3 AV	-	-	1.09 H	277	54.2	42.1
3	11160.00	60.6 PK	74.0	-13.4	2.96 H	174	42.1	18.5
4	11160.00	46.9 AV	54.0	-7.1	2.96 H	174	28.4	18.5

Antenna Polarity & Test Distance : Vertical at 3 m

No	Frequency (MHz)	Emission Level (dBuV/m)	Limit (dBuV/m)	Margin (dB)	Antenna Height (m)	Table Angle (Degree)	Raw Value (dBuV)	Correction Factor (dB/m)
1	*5580.00	112.8 PK	-	-	2.24 V	196	70.7	42.1
2	*5580.00	102.5 AV	-	-	2.24 V	196	60.4	42.1
3	11160.00	61.7 PK	74.0	-12.3	1.09 V	104	43.2	18.5
4	11160.00	48.9 AV	54.0	-5.1	1.09 V	104	30.4	18.5

Remarks:

1. Emission Level(dBuV/m) = Raw Value(dBuV) + Correction Factor(dB/m)
2. Correction Factor(dB/m) = Antenna Factor(dB/m) + Cable Factor(dB) – Pre-Amplifier Factor(dB)
3. Margin value = Emission Level – Limit value
4. The other emission levels were very low against the limit.
5. " * ": Fundamental frequency.

CHANNEL	TX Channel 140	DETECTOR FUNCTION	Peak (PK) Average (AV)
FREQUENCY RANGE	1GHz ~ 40GHz		

Antenna Polarity & Test Distance : Horizontal at 3 m								
No	Frequency (MHz)	Emission Level (dBuV/m)	Limit (dBuV/m)	Margin (dB)	Antenna Height (m)	Table Angle (Degree)	Raw Value (dBuV)	Correction Factor (dB/m)
1	*5700.00	108.4 PK	-	-	1.28 H	291	66.1	42.3
2	*5700.00	98.6 AV	-	-	1.28 H	291	56.3	42.3
3	#5725.00	56.3 PK	68.2	-11.9	1.28 H	291	49.8	6.5
4	11400.00	61.1 PK	74.0	-12.9	2.61 H	188	43.2	17.9
5	11400.00	47.9 AV	54.0	-6.1	2.61 H	188	30.0	17.9

Antenna Polarity & Test Distance : Vertical at 3 m								
No	Frequency (MHz)	Emission Level (dBuV/m)	Limit (dBuV/m)	Margin (dB)	Antenna Height (m)	Table Angle (Degree)	Raw Value (dBuV)	Correction Factor (dB/m)
1	*5700.00	114.6 PK	-	-	2.49 V	195	72.3	42.3
2	*5700.00	104.6 AV	-	-	2.49 V	195	62.3	42.3
3	#5725.00	60.3 PK	68.2	-7.9	2.49 V	195	53.8	6.5
4	11400.00	63.8 PK	74.0	-10.2	1.06 V	99	45.9	17.9
5	11400.00	49.9 AV	54.0	-4.1	1.06 V	99	32.0	17.9

Remarks:

1. Emission Level(dBuV/m) = Raw Value(dBuV) + Correction Factor(dB/m)
2. Correction Factor(dB/m) = Antenna Factor(dB/m) + Cable Factor(dB) – Pre-Amplifier Factor(dB)
3. Margin value = Emission Level – Limit value
4. The other emission levels were very low against the limit.
5. " * ": Fundamental frequency.
6. " # ": The radiated frequency is out of the restricted band.

CHANNEL	TX Channel 144	DETECTOR FUNCTION	Peak (PK)
FREQUENCY RANGE	1GHz ~ 40GHz		Average (AV)

Antenna Polarity & Test Distance : Horizontal at 3 m								
No	Frequency (MHz)	Emission Level (dBuV/m)	Limit (dBuV/m)	Margin (dB)	Antenna Height (m)	Table Angle (Degree)	Raw Value (dBuV)	Correction Factor (dB/m)
1	#5470.00	56.4 PK	68.2	-11.8	1.35 H	299	50.1	6.3
2	*5720.00	108.2 PK	-	-	1.35 H	299	66.0	42.2
3	*5720.00	97.5 AV	-	-	1.35 H	299	55.3	42.2
4	#5850.00	57.1 PK	68.2	-11.1	1.35 H	299	50.3	6.8
5	11440.00	62.0 PK	74.0	-12.0	2.43 H	178	44.0	18.0
6	11440.00	47.3 AV	54.0	-6.7	2.43 H	178	29.3	18.0

Antenna Polarity & Test Distance : Vertical at 3 m								
No	Frequency (MHz)	Emission Level (dBuV/m)	Limit (dBuV/m)	Margin (dB)	Antenna Height (m)	Table Angle (Degree)	Raw Value (dBuV)	Correction Factor (dB/m)
1	#5470.00	57.8 PK	68.2	-10.4	2.64 V	311	51.5	6.3
2	*5720.00	114.3 PK	-	-	2.64 V	311	72.1	42.2
3	*5720.00	103.6 AV	-	-	2.64 V	311	61.4	42.2
4	#5850.00	59.3 PK	68.2	-8.9	2.64 V	311	52.5	6.8
5	11440.00	64.0 PK	74.0	-10.0	1.05 V	100	46.0	18.0
6	11440.00	49.4 AV	54.0	-4.6	1.05 V	100	31.4	18.0

Remarks:

1. Emission Level(dBuV/m) = Raw Value(dBuV) + Correction Factor(dB/m)
2. Correction Factor(dB/m) = Antenna Factor(dB/m) + Cable Factor(dB) – Pre-Amplifier Factor(dB)
3. Margin value = Emission Level – Limit value
4. The other emission levels were very low against the limit.
5. " * ": Fundamental frequency.
6. " # ": The radiated frequency is out of the restricted band.

CHANNEL	TX Channel 149	DETECTOR FUNCTION	Peak (PK) Average (AV)
FREQUENCY RANGE	1GHz ~ 40GHz		

Antenna Polarity & Test Distance : Horizontal at 3 m								
No	Frequency (MHz)	Emission Level (dBuV/m)	Limit (dBuV/m)	Margin (dB)	Antenna Height (m)	Table Angle (Degree)	Raw Value (dBuV)	Correction Factor (dB/m)
1	*5745.00	105.8 PK	-	-	1.15 H	276	63.6	42.2
2	*5745.00	95.4 AV	-	-	1.15 H	276	53.2	42.2
3	11490.00	60.6 PK	74.0	-13.4	2.07 H	142	42.3	18.3
4	11490.00	46.5 AV	54.0	-7.5	2.07 H	142	28.2	18.3

Antenna Polarity & Test Distance : Vertical at 3 m								
No	Frequency (MHz)	Emission Level (dBuV/m)	Limit (dBuV/m)	Margin (dB)	Antenna Height (m)	Table Angle (Degree)	Raw Value (dBuV)	Correction Factor (dB/m)
1	*5745.00	113.6 PK	-	-	2.59 V	167	71.4	42.2
2	*5745.00	103.2 AV	-	-	2.59 V	167	61.0	42.2
3	11490.00	62.1 PK	74.0	-11.9	1.00 V	97	43.8	18.3
4	11490.00	48.9 AV	54.0	-5.1	1.00 V	97	30.6	18.3

<Out of Band Emission (OOBE)>

Antenna Polarity & Test Distance : Horizontal at 3 m								
No	Frequency (MHz)	Emission Level (dBuV/m)	Limit (dBuV/m)	Margin (dB)	Antenna Height (m)	Table Angle (Degree)	Raw Value (dBuV)	Correction Factor (dB/m)
1	#5647.44	56.1 PK	68.2	-12.1	1.15 H	276	49.8	6.3
2	#5947.44	58.3 PK	68.2	-9.9	1.15 H	276	51.0	7.3

Antenna Polarity & Test Distance : Vertical at 3 m								
No	Frequency (MHz)	Emission Level (dBuV/m)	Limit (dBuV/m)	Margin (dB)	Antenna Height (m)	Table Angle (Degree)	Raw Value (dBuV)	Correction Factor (dB/m)
1	#5648.08	58.4 PK	68.2	-9.8	2.59 V	167	52.1	6.3
2	#5940.38	59.1 PK	68.2	-9.1	2.59 V	167	51.8	7.3

Remarks:

1. Emission Level(dBuV/m) = Raw Value(dBuV) + Correction Factor(dB/m)
2. Correction Factor(dB/m) = Antenna Factor(dB/m) + Cable Factor(dB) – Pre-Amplifier Factor(dB)
3. Margin value = Emission Level – Limit value
4. The other emission levels were very low against the limit.
5. " * ": Fundamental frequency.
6. " # ": The radiated frequency is out of the restricted band.

CHANNEL	TX Channel 157	DETECTOR FUNCTION	Peak (PK) Average (AV)
FREQUENCY RANGE	1GHz ~ 40GHz		

Antenna Polarity & Test Distance : Horizontal at 3 m								
No	Frequency (MHz)	Emission Level (dBuV/m)	Limit (dBuV/m)	Margin (dB)	Antenna Height (m)	Table Angle (Degree)	Raw Value (dBuV)	Correction Factor (dB/m)
1	*5785.00	105.8 PK	-	-	1.19 H	275	63.6	42.2
2	*5785.00	95.4 AV	-	-	1.19 H	275	53.2	42.2
3	11570.00	60.3 PK	74.0	-13.7	2.36 H	188	42.3	18.0
4	11570.00	46.5 AV	54.0	-7.5	2.36 H	188	28.5	18.0

Antenna Polarity & Test Distance : Vertical at 3 m								
No	Frequency (MHz)	Emission Level (dBuV/m)	Limit (dBuV/m)	Margin (dB)	Antenna Height (m)	Table Angle (Degree)	Raw Value (dBuV)	Correction Factor (dB/m)
1	*5785.00	112.8 PK	-	-	2.29 V	194	70.6	42.2
2	*5785.00	102.8 AV	-	-	2.29 V	194	60.6	42.2
3	11570.00	61.4 PK	74.0	-12.6	1.28 V	104	43.4	18.0
4	11570.00	48.2 AV	54.0	-5.8	1.28 V	104	30.2	18.0

<Out of Band Emission (OOBE)>

Antenna Polarity & Test Distance : Horizontal at 3 m								
No	Frequency (MHz)	Emission Level (dBuV/m)	Limit (dBuV/m)	Margin (dB)	Antenna Height (m)	Table Angle (Degree)	Raw Value (dBuV)	Correction Factor (dB/m)
1	#5628.21	56.0 PK	68.2	-12.2	1.19 H	275	49.8	6.2
2	#5956.41	58.4 PK	68.2	-9.8	1.19 H	275	51.1	7.3

Antenna Polarity & Test Distance : Vertical at 3 m								
No	Frequency (MHz)	Emission Level (dBuV/m)	Limit (dBuV/m)	Margin (dB)	Antenna Height (m)	Table Angle (Degree)	Raw Value (dBuV)	Correction Factor (dB/m)
1	#5603.85	57.0 PK	68.2	-11.2	2.29 V	194	50.8	6.2
2	#5955.13	58.6 PK	68.2	-9.6	2.29 V	194	51.3	7.3

Remarks:

1. Emission Level(dBuV/m) = Raw Value(dBuV) + Correction Factor(dB/m)
2. Correction Factor(dB/m) = Antenna Factor(dB/m) + Cable Factor(dB) – Pre-Amplifier Factor(dB)
3. Margin value = Emission Level – Limit value
4. The other emission levels were very low against the limit.
5. " * ": Fundamental frequency.
6. " # ": The radiated frequency is out of the restricted band.

CHANNEL	TX Channel 165	DETECTOR FUNCTION	Peak (PK)
FREQUENCY RANGE	1GHz ~ 40GHz		Average (AV)

Antenna Polarity & Test Distance : Horizontal at 3 m								
No	Frequency (MHz)	Emission Level (dBuV/m)	Limit (dBuV/m)	Margin (dB)	Antenna Height (m)	Table Angle (Degree)	Raw Value (dBuV)	Correction Factor (dB/m)
1	*5825.00	106.3 PK	-	-	1.13 H	275	64.0	42.3
2	*5825.00	96.0 AV	-	-	1.13 H	275	53.7	42.3
3	11650.00	60.6 PK	74.0	-13.4	2.31 H	168	42.6	18.0
4	11650.00	46.8 AV	54.0	-7.2	2.31 H	168	28.8	18.0

Antenna Polarity & Test Distance : Vertical at 3 m								
No	Frequency (MHz)	Emission Level (dBuV/m)	Limit (dBuV/m)	Margin (dB)	Antenna Height (m)	Table Angle (Degree)	Raw Value (dBuV)	Correction Factor (dB/m)
1	*5825.00	114.4 PK	-	-	2.73 V	257	72.1	42.3
2	*5825.00	103.8 AV	-	-	2.73 V	257	61.5	42.3
3	11650.00	62.0 PK	74.0	-12.0	1.01 V	97	44.0	18.0
4	11650.00	49.0 AV	54.0	-5.0	1.01 V	97	31.0	18.0

<Out of Band Emission (OOBE)>

Antenna Polarity & Test Distance : Horizontal at 3 m								
No	Frequency (MHz)	Emission Level (dBuV/m)	Limit (dBuV/m)	Margin (dB)	Antenna Height (m)	Table Angle (Degree)	Raw Value (dBuV)	Correction Factor (dB/m)
1	#5645.51	56.1 PK	68.2	-12.1	1.13 H	275	49.8	6.3
2	#5982.69	58.3 PK	68.2	-9.9	1.13 H	275	51.1	7.2

Antenna Polarity & Test Distance : Vertical at 3 m								
No	Frequency (MHz)	Emission Level (dBuV/m)	Limit (dBuV/m)	Margin (dB)	Antenna Height (m)	Table Angle (Degree)	Raw Value (dBuV)	Correction Factor (dB/m)
1	#5621.79	56.0 PK	68.2	-12.2	2.73 V	257	49.8	6.2
2	#5925.64	58.8 PK	68.2	-9.4	2.73 V	257	51.5	7.3

Remarks:

1. Emission Level(dBuV/m) = Raw Value(dBuV) + Correction Factor(dB/m)
2. Correction Factor(dB/m) = Antenna Factor(dB/m) + Cable Factor(dB) – Pre-Amplifier Factor(dB)
3. Margin value = Emission Level – Limit value
4. The other emission levels were very low against the limit.
5. " * ": Fundamental frequency.
6. " # ": The radiated frequency is out of the restricted band.

802.11ac (VHT20)

CHANNEL	TX Channel 36	DETECTOR FUNCTION	Peak (PK)
FREQUENCY RANGE	1GHz ~ 40GHz		Average (AV)

Antenna Polarity & Test Distance : Horizontal at 3 m								
No	Frequency (MHz)	Emission Level (dBuV/m)	Limit (dBuV/m)	Margin (dB)	Antenna Height (m)	Table Angle (Degree)	Raw Value (dBuV)	Correction Factor (dB/m)
1	5083.00	59.2 PK	74.0	-14.8	1.17 H	278	52.6	6.6
2	5083.00	45.5 AV	54.0	-8.5	1.17 H	278	38.9	6.6
3	*5180.00	104.2 PK	-	-	1.17 H	278	62.0	42.2
4	*5180.00	94.0 AV	-	-	1.17 H	278	51.8	42.2
5	#10360.00	58.3 PK	68.2	-9.9	1.98 H	154	41.6	16.7

Antenna Polarity & Test Distance : Vertical at 3 m								
No	Frequency (MHz)	Emission Level (dBuV/m)	Limit (dBuV/m)	Margin (dB)	Antenna Height (m)	Table Angle (Degree)	Raw Value (dBuV)	Correction Factor (dB/m)
1	5083.00	61.3 PK	74.0	-12.7	2.12 V	328	54.7	6.6
2	5083.00	48.9 AV	54.0	-5.1	2.12 V	328	42.3	6.6
3	*5180.00	110.5 PK	-	-	2.12 V	328	68.3	42.2
4	*5180.00	100.4 AV	-	-	2.12 V	328	58.2	42.2
5	#10360.00	58.6 PK	68.2	-9.6	1.75 V	22	41.9	16.7

Remarks:

1. Emission Level(dBuV/m) = Raw Value(dBuV) + Correction Factor(dB/m)
2. Correction Factor(dB/m) = Antenna Factor(dB/m) + Cable Factor(dB) – Pre-Amplifier Factor(dB)
3. Margin value = Emission Level – Limit value
4. The other emission levels were very low against the limit.
5. " * ": Fundamental frequency.
6. " # ": The radiated frequency is out of the restricted band.

CHANNEL	TX Channel 40	DETECTOR FUNCTION	Peak (PK)
FREQUENCY RANGE	1GHz ~ 40GHz		Average (AV)

Antenna Polarity & Test Distance : Horizontal at 3 m								
No	Frequency (MHz)	Emission Level (dBuV/m)	Limit (dBuV/m)	Margin (dB)	Antenna Height (m)	Table Angle (Degree)	Raw Value (dBuV)	Correction Factor (dB/m)
1	*5200.00	104.9 PK	-	-	1.28 H	280	62.8	42.1
2	*5200.00	94.8 AV	-	-	1.28 H	280	52.7	42.1
3	#10400.00	58.5 PK	68.2	-9.7	2.05 H	161	41.6	16.9

Antenna Polarity & Test Distance : Vertical at 3 m								
No	Frequency (MHz)	Emission Level (dBuV/m)	Limit (dBuV/m)	Margin (dB)	Antenna Height (m)	Table Angle (Degree)	Raw Value (dBuV)	Correction Factor (dB/m)
1	*5200.00	111.3 PK	-	-	1.84 V	350	69.2	42.1
2	*5200.00	101.1 AV	-	-	1.84 V	350	59.0	42.1
3	#10400.00	58.9 PK	68.2	-9.3	1.66 V	25	42.0	16.9

Remarks:

1. Emission Level(dBuV/m) = Raw Value(dBuV) + Correction Factor(dB/m)
2. Correction Factor(dB/m) = Antenna Factor(dB/m) + Cable Factor(dB) – Pre-Amplifier Factor(dB)
3. Margin value = Emission Level – Limit value
4. The other emission levels were very low against the limit.
5. " * ": Fundamental frequency.
6. " # ": The radiated frequency is out of the restricted band.

CHANNEL	TX Channel 48	DETECTOR FUNCTION	Peak (PK)
FREQUENCY RANGE	1GHz ~ 40GHz		Average (AV)

Antenna Polarity & Test Distance : Horizontal at 3 m								
No	Frequency (MHz)	Emission Level (dBuV/m)	Limit (dBuV/m)	Margin (dB)	Antenna Height (m)	Table Angle (Degree)	Raw Value (dBuV)	Correction Factor (dB/m)
1	5141.00	57.6 PK	74.0	-16.4	1.25 H	277	51.0	6.6
2	5141.00	44.6 AV	54.0	-9.4	1.25 H	277	38.0	6.6
3	*5240.00	104.2 PK	-	-	1.25 H	277	62.2	42.0
4	*5240.00	94.0 AV	-	-	1.25 H	277	52.0	42.0
5	#10400.00	58.5 PK	68.2	-9.7	2.05 H	159	41.6	16.9
Antenna Polarity & Test Distance : Vertical at 3 m								
No	Frequency (MHz)	Emission Level (dBuV/m)	Limit (dBuV/m)	Margin (dB)	Antenna Height (m)	Table Angle (Degree)	Raw Value (dBuV)	Correction Factor (dB/m)
1	5141.00	59.1 PK	74.0	-14.9	2.13 V	298	52.5	6.6
2	5141.00	46.6 AV	54.0	-7.4	2.13 V	298	40.0	6.6
3	*5240.00	110.5 PK	-	-	2.13 V	298	68.5	42.0
4	*5240.00	100.2 AV	-	-	2.13 V	298	58.2	42.0
5	#10480.00	59.6 PK	68.2	-8.6	1.55 V	19	41.9	17.7

Remarks:

1. Emission Level(dBuV/m) = Raw Value(dBuV) + Correction Factor(dB/m)
2. Correction Factor(dB/m) = Antenna Factor(dB/m) + Cable Factor(dB) – Pre-Amplifier Factor(dB)
3. Margin value = Emission Level – Limit value
4. The other emission levels were very low against the limit.
5. " * ": Fundamental frequency.
6. " # ": The radiated frequency is out of the restricted band.

CHANNEL	TX Channel 52	DETECTOR FUNCTION	Peak (PK)
FREQUENCY RANGE	1GHz ~ 40GHz		Average (AV)

Antenna Polarity & Test Distance : Horizontal at 3 m

No	Frequency (MHz)	Emission Level (dBuV/m)	Limit (dBuV/m)	Margin (dB)	Antenna Height (m)	Table Angle (Degree)	Raw Value (dBuV)	Correction Factor (dB/m)
1	5150.00	58.6 PK	74.0	-15.4	1.17 H	194	52.0	6.6
2	5150.00	45.5 AV	54.0	-8.5	1.17 H	194	38.9	6.6
3	*5260.00	103.4 PK	-	-	1.17 H	194	61.5	41.9
4	*5260.00	93.4 AV	-	-	1.17 H	194	51.5	41.9
5	#10520.00	59.7 PK	68.2	-8.5	2.88 H	269	42.1	17.6

Antenna Polarity & Test Distance : Vertical at 3 m

No	Frequency (MHz)	Emission Level (dBuV/m)	Limit (dBuV/m)	Margin (dB)	Antenna Height (m)	Table Angle (Degree)	Raw Value (dBuV)	Correction Factor (dB/m)
1	5150.00	58.6 PK	74.0	-15.4	1.46 V	332	52.0	6.6
2	5150.00	45.6 AV	54.0	-8.4	1.46 V	332	39.0	6.6
3	*5260.00	110.5 PK	-	-	1.46 V	332	68.6	41.9
4	*5260.00	100.2 AV	-	-	1.46 V	332	58.3	41.9
5	#10520.00	60.2 PK	68.2	-8.0	1.64 V	113	42.6	17.6

Remarks:

1. Emission Level(dBuV/m) = Raw Value(dBuV) + Correction Factor(dB/m)
2. Correction Factor(dB/m) = Antenna Factor(dB/m) + Cable Factor(dB) – Pre-Amplifier Factor(dB)
3. Margin value = Emission Level – Limit value
4. The other emission levels were very low against the limit.
5. " * ": Fundamental frequency.
6. " # ": The radiated frequency is out of the restricted band.

CHANNEL	TX Channel 60	DETECTOR FUNCTION	Peak (PK)
FREQUENCY RANGE	1GHz ~ 40GHz		Average (AV)

Antenna Polarity & Test Distance : Horizontal at 3 m								
No	Frequency (MHz)	Emission Level (dBuV/m)	Limit (dBuV/m)	Margin (dB)	Antenna Height (m)	Table Angle (Degree)	Raw Value (dBuV)	Correction Factor (dB/m)
1	*5300.00	104.1 PK	-	-	1.17 H	183	62.2	41.9
2	*5300.00	93.0 AV	-	-	1.17 H	183	51.1	41.9
3	10600.00	59.4 PK	74.0	-14.6	2.46 H	184	42.2	17.2
4	10600.00	45.5 AV	54.0	-8.5	2.46 H	184	28.3	17.2

Antenna Polarity & Test Distance : Vertical at 3 m								
No	Frequency (MHz)	Emission Level (dBuV/m)	Limit (dBuV/m)	Margin (dB)	Antenna Height (m)	Table Angle (Degree)	Raw Value (dBuV)	Correction Factor (dB/m)
1	*5300.00	111.9 PK	-	-	1.77 V	357	70.0	41.9
2	*5300.00	100.8 AV	-	-	1.77 V	357	58.9	41.9
3	10600.00	59.6 PK	74.0	-14.4	2.13 V	110	42.4	17.2
4	10600.00	45.7 AV	54.0	-8.3	2.13 V	110	28.5	17.2

Remarks:

1. Emission Level(dBuV/m) = Raw Value(dBuV) + Correction Factor(dB/m)
2. Correction Factor(dB/m) = Antenna Factor(dB/m) + Cable Factor(dB) – Pre-Amplifier Factor(dB)
3. Margin value = Emission Level – Limit value
4. The other emission levels were very low against the limit.
5. " * ": Fundamental frequency.

CHANNEL	TX Channel 64	DETECTOR FUNCTION	Peak (PK)
FREQUENCY RANGE	1GHz ~ 40GHz		Average (AV)

Antenna Polarity & Test Distance : Horizontal at 3 m

No	Frequency (MHz)	Emission Level (dBuV/m)	Limit (dBuV/m)	Margin (dB)	Antenna Height (m)	Table Angle (Degree)	Raw Value (dBuV)	Correction Factor (dB/m)
1	*5320.00	101.9 PK	-	-	1.26 H	276	59.9	42.0
2	*5320.00	91.1 AV	-	-	1.26 H	276	49.1	42.0
3	5350.00	58.3 PK	74.0	-15.7	1.26 H	276	51.9	6.4
4	5350.00	44.6 AV	54.0	-9.4	1.26 H	276	38.2	6.4
5	10640.00	59.5 PK	74.0	-14.5	2.18 H	199	42.1	17.4
6	10640.00	45.9 AV	54.0	-8.1	2.18 H	199	28.5	17.4

Antenna Polarity & Test Distance : Vertical at 3 m

No	Frequency (MHz)	Emission Level (dBuV/m)	Limit (dBuV/m)	Margin (dB)	Antenna Height (m)	Table Angle (Degree)	Raw Value (dBuV)	Correction Factor (dB/m)
1	*5320.00	109.2 PK	-	-	1.19 V	346	67.2	42.0
2	*5320.00	99.1 AV	-	-	1.19 V	346	57.1	42.0
3	5350.00	58.2 PK	74.0	-15.8	1.19 V	346	51.8	6.4
4	5350.00	45.4 AV	54.0	-8.6	1.19 V	346	39.0	6.4
5	10640.00	59.7 PK	74.0	-14.3	1.86 V	79	42.3	17.4
6	10640.00	45.8 AV	54.0	-8.2	1.86 V	79	28.4	17.4

Remarks:

1. Emission Level(dBuV/m) = Raw Value(dBuV) + Correction Factor(dB/m)
2. Correction Factor(dB/m) = Antenna Factor(dB/m) + Cable Factor(dB) – Pre-Amplifier Factor(dB)
3. Margin value = Emission Level – Limit value
4. The other emission levels were very low against the limit.
5. " * ": Fundamental frequency.

CHANNEL	TX Channel 100	DETECTOR FUNCTION	Peak (PK) Average (AV)
FREQUENCY RANGE	1GHz ~ 40GHz		

Antenna Polarity & Test Distance : Horizontal at 3 m								
No	Frequency (MHz)	Emission Level (dBuV/m)	Limit (dBuV/m)	Margin (dB)	Antenna Height (m)	Table Angle (Degree)	Raw Value (dBuV)	Correction Factor (dB/m)
1	5350.00	57.7 PK	74.0	-16.3	1.15 H	274	51.3	6.4
2	5350.00	44.8 AV	54.0	-9.2	1.15 H	274	38.4	6.4
3	#5470.00	58.4 PK	68.2	-9.8	1.15 H	274	52.1	6.3
4	*5500.00	105.3 PK	-	-	1.15 H	274	63.2	42.1
5	*5500.00	94.6 AV	-	-	1.15 H	274	52.5	42.1
6	11000.00	60.8 PK	74.0	-13.2	2.12 H	158	42.2	18.6
7	11000.00	47.1 AV	54.0	-6.9	2.12 H	158	28.5	18.6

Antenna Polarity & Test Distance : Vertical at 3 m								
No	Frequency (MHz)	Emission Level (dBuV/m)	Limit (dBuV/m)	Margin (dB)	Antenna Height (m)	Table Angle (Degree)	Raw Value (dBuV)	Correction Factor (dB/m)
1	5460.00	60.5 PK	74.0	-13.5	2.32 V	204	54.2	6.3
2	5460.00	48.1 AV	54.0	-5.9	2.32 V	204	41.8	6.3
3	#5470.00	58.9 PK	68.2	-9.3	2.32 V	204	52.6	6.3
4	*5500.00	113.3 PK	-	-	2.32 V	204	71.2	42.1
5	*5500.00	103.1 AV	-	-	2.32 V	204	61.0	42.1
6	11000.00	61.3 PK	74.0	-12.7	1.21 V	294	42.7	18.6
7	11000.00	48.0 AV	54.0	-6.0	1.21 V	294	29.4	18.6

Remarks:

1. Emission Level(dBuV/m) = Raw Value(dBuV) + Correction Factor(dB/m)
2. Correction Factor(dB/m) = Antenna Factor(dB/m) + Cable Factor(dB) – Pre-Amplifier Factor(dB)
3. Margin value = Emission Level – Limit value
4. The other emission levels were very low against the limit.
5. " * ": Fundamental frequency.
6. " # ": The radiated frequency is out of the restricted band.

CHANNEL	TX Channel 116	DETECTOR FUNCTION	Peak (PK)
FREQUENCY RANGE	1GHz ~ 40GHz		Average (AV)

Antenna Polarity & Test Distance : Horizontal at 3 m

No	Frequency (MHz)	Emission Level (dBuV/m)	Limit (dBuV/m)	Margin (dB)	Antenna Height (m)	Table Angle (Degree)	Raw Value (dBuV)	Correction Factor (dB/m)
1	*5580.00	104.4 PK	-	-	1.22 H	278	62.3	42.1
2	*5580.00	94.1 AV	-	-	1.22 H	278	52.0	42.1
3	11160.00	60.5 PK	74.0	-13.5	2.88 H	156	42.0	18.5
4	11160.00	46.9 AV	54.0	-7.1	2.88 H	156	28.4	18.5

Antenna Polarity & Test Distance : Vertical at 3 m

No	Frequency (MHz)	Emission Level (dBuV/m)	Limit (dBuV/m)	Margin (dB)	Antenna Height (m)	Table Angle (Degree)	Raw Value (dBuV)	Correction Factor (dB/m)
1	*5580.00	112.8 PK	-	-	2.42 V	192	70.7	42.1
2	*5580.00	102.3 AV	-	-	2.42 V	192	60.2	42.1
3	11160.00	60.5 PK	74.0	-13.5	1.38 V	133	42.0	18.5
4	11160.00	47.5 AV	54.0	-6.5	1.38 V	133	29.0	18.5

Remarks:

1. Emission Level(dBuV/m) = Raw Value(dBuV) + Correction Factor(dB/m)
2. Correction Factor(dB/m) = Antenna Factor(dB/m) + Cable Factor(dB) – Pre-Amplifier Factor(dB)
3. Margin value = Emission Level – Limit value
4. The other emission levels were very low against the limit.
5. " * ": Fundamental frequency.

CHANNEL	TX Channel 140	DETECTOR FUNCTION	Peak (PK)
FREQUENCY RANGE	1GHz ~ 40GHz		Average (AV)

Antenna Polarity & Test Distance : Horizontal at 3 m

No	Frequency (MHz)	Emission Level (dBuV/m)	Limit (dBuV/m)	Margin (dB)	Antenna Height (m)	Table Angle (Degree)	Raw Value (dBuV)	Correction Factor (dB/m)
1	*5700.00	106.6 PK	-	-	1.41 H	302	64.3	42.3
2	*5700.00	96.4 AV	-	-	1.41 H	302	54.1	42.3
3	#5725.00	56.6 PK	68.2	-11.6	1.41 H	302	50.1	6.5
4	11400.00	61.2 PK	74.0	-12.8	2.45 H	200	43.3	17.9
5	11400.00	47.5 AV	54.0	-6.5	2.45 H	200	29.6	17.9

Antenna Polarity & Test Distance : Vertical at 3 m

No	Frequency (MHz)	Emission Level (dBuV/m)	Limit (dBuV/m)	Margin (dB)	Antenna Height (m)	Table Angle (Degree)	Raw Value (dBuV)	Correction Factor (dB/m)
1	*5700.00	112.8 PK	-	-	2.80 V	333	70.5	42.3
2	*5700.00	102.6 AV	-	-	2.80 V	333	60.3	42.3
3	#5725.00	57.8 PK	68.2	-10.4	2.80 V	333	51.3	6.5
4	11400.00	63.7 PK	74.0	-10.3	1.00 V	100	45.8	17.9
5	11400.00	49.8 AV	54.0	-4.2	1.00 V	100	31.9	17.9

Remarks:

1. Emission Level(dBuV/m) = Raw Value(dBuV) + Correction Factor(dB/m)
2. Correction Factor(dB/m) = Antenna Factor(dB/m) + Cable Factor(dB) – Pre-Amplifier Factor(dB)
3. Margin value = Emission Level – Limit value
4. The other emission levels were very low against the limit.
5. " * ": Fundamental frequency.
6. " # ": The radiated frequency is out of the restricted band.

CHANNEL	TX Channel 144	DETECTOR FUNCTION	Peak (PK)
FREQUENCY RANGE	1GHz ~ 40GHz		Average (AV)

Antenna Polarity & Test Distance : Horizontal at 3 m

No	Frequency (MHz)	Emission Level (dBuV/m)	Limit (dBuV/m)	Margin (dB)	Antenna Height (m)	Table Angle (Degree)	Raw Value (dBuV)	Correction Factor (dB/m)
1	#5470.00	57.6 PK	68.2	-10.6	1.18 H	274	51.3	6.3
2	*5720.00	105.0 PK	-	-	1.18 H	274	62.8	42.2
3	*5720.00	94.8 AV	-	-	1.18 H	274	52.6	42.2
4	#5850.00	58.7 PK	68.2	-9.5	1.18 H	274	51.9	6.8
5	11440.00	60.5 PK	74.0	-13.5	2.69 H	113	42.5	18.0
6	11440.00	46.3 AV	54.0	-7.7	2.69 H	113	28.3	18.0

Antenna Polarity & Test Distance : Vertical at 3 m

No	Frequency (MHz)	Emission Level (dBuV/m)	Limit (dBuV/m)	Margin (dB)	Antenna Height (m)	Table Angle (Degree)	Raw Value (dBuV)	Correction Factor (dB/m)
1	#5470.00	57.3 PK	68.2	-10.9	2.34 V	235	51.0	6.3
2	*5720.00	111.8 PK	-	-	2.34 V	235	69.6	42.2
3	*5720.00	101.5 AV	-	-	2.34 V	235	59.3	42.2
4	#5850.00	57.8 PK	68.2	-10.4	2.34 V	235	51.0	6.8
5	11440.00	61.2 PK	74.0	-12.8	1.02 V	97	43.2	18.0
6	11440.00	48.0 AV	54.0	-6.0	1.02 V	97	30.0	18.0

Remarks:

1. Emission Level(dBuV/m) = Raw Value(dBuV) + Correction Factor(dB/m)
2. Correction Factor(dB/m) = Antenna Factor(dB/m) + Cable Factor(dB) – Pre-Amplifier Factor(dB)
3. Margin value = Emission Level – Limit value
4. The other emission levels were very low against the limit.
5. " * ": Fundamental frequency.
6. " # ": The radiated frequency is out of the restricted band.

CHANNEL	TX Channel 149	DETECTOR FUNCTION	Peak (PK)
FREQUENCY RANGE	1GHz ~ 40GHz		Average (AV)

Antenna Polarity & Test Distance : Horizontal at 3 m								
No	Frequency (MHz)	Emission Level (dBuV/m)	Limit (dBuV/m)	Margin (dB)	Antenna Height (m)	Table Angle (Degree)	Raw Value (dBuV)	Correction Factor (dB/m)
1	*5745.00	104.6 PK	-	-	1.18 H	274	62.4	42.2
2	*5745.00	94.3 AV	-	-	1.18 H	274	52.1	42.2
3	11490.00	60.5 PK	74.0	-13.5	2.09 H	173	42.2	18.3
4	11490.00	46.3 AV	54.0	-7.7	2.09 H	173	28.0	18.3

Antenna Polarity & Test Distance : Vertical at 3 m								
No	Frequency (MHz)	Emission Level (dBuV/m)	Limit (dBuV/m)	Margin (dB)	Antenna Height (m)	Table Angle (Degree)	Raw Value (dBuV)	Correction Factor (dB/m)
1	*5745.00	112.7 PK	-	-	2.94 V	249	70.5	42.2
2	*5745.00	101.7 AV	-	-	2.94 V	249	59.5	42.2
3	11490.00	61.7 PK	74.0	-12.3	1.01 V	92	43.4	18.3
4	11490.00	48.1 AV	54.0	-5.9	1.01 V	92	29.8	18.3

<Out of Band Emission (OOBE)>

Antenna Polarity & Test Distance : Horizontal at 3 m								
No	Frequency (MHz)	Emission Level (dBuV/m)	Limit (dBuV/m)	Margin (dB)	Antenna Height (m)	Table Angle (Degree)	Raw Value (dBuV)	Correction Factor (dB/m)
1	#5623.08	56.6 PK	68.2	-11.6	1.18 H	274	50.4	6.2
2	#5964.10	57.9 PK	68.2	-10.3	1.18 H	274	50.6	7.3

Antenna Polarity & Test Distance : Vertical at 3 m								
No	Frequency (MHz)	Emission Level (dBuV/m)	Limit (dBuV/m)	Margin (dB)	Antenna Height (m)	Table Angle (Degree)	Raw Value (dBuV)	Correction Factor (dB/m)
1	#5648.72	58.5 PK	68.2	-9.7	2.94 V	249	52.2	6.3
2	#5982.69	58.9 PK	68.2	-9.3	2.94 V	249	51.7	7.2

Remarks:

1. Emission Level(dBuV/m) = Raw Value(dBuV) + Correction Factor(dB/m)
2. Correction Factor(dB/m) = Antenna Factor(dB/m) + Cable Factor(dB) – Pre-Amplifier Factor(dB)
3. Margin value = Emission Level – Limit value
4. The other emission levels were very low against the limit.
5. " * ": Fundamental frequency.
6. " # ": The radiated frequency is out of the restricted band.

CHANNEL	TX Channel 157	DETECTOR FUNCTION	Peak (PK) Average (AV)
FREQUENCY RANGE	1GHz ~ 40GHz		

Antenna Polarity & Test Distance : Horizontal at 3 m								
No	Frequency (MHz)	Emission Level (dBuV/m)	Limit (dBuV/m)	Margin (dB)	Antenna Height (m)	Table Angle (Degree)	Raw Value (dBuV)	Correction Factor (dB/m)
1	*5785.00	104.8 PK	-	-	1.18 H	275	62.6	42.2
2	*5785.00	94.7 AV	-	-	1.18 H	275	52.5	42.2
3	11570.00	60.2 PK	74.0	-13.8	2.64 H	139	42.2	18.0
4	11570.00	46.4 AV	54.0	-7.6	2.64 H	139	28.4	18.0

Antenna Polarity & Test Distance : Vertical at 3 m								
No	Frequency (MHz)	Emission Level (dBuV/m)	Limit (dBuV/m)	Margin (dB)	Antenna Height (m)	Table Angle (Degree)	Raw Value (dBuV)	Correction Factor (dB/m)
1	*5785.00	112.4 PK	-	-	2.65 V	178	70.2	42.2
2	*5785.00	101.7 AV	-	-	2.65 V	178	59.5	42.2
3	11570.00	62.3 PK	74.0	-11.7	1.02 V	95	44.3	18.0
4	11570.00	48.8 AV	54.0	-5.2	1.02 V	95	30.8	18.0

<Out of Band Emission (OOBE)>

Antenna Polarity & Test Distance : Horizontal at 3 m								
No	Frequency (MHz)	Emission Level (dBuV/m)	Limit (dBuV/m)	Margin (dB)	Antenna Height (m)	Table Angle (Degree)	Raw Value (dBuV)	Correction Factor (dB/m)
1	#5639.74	56.5 PK	68.2	-11.7	1.18 H	275	50.2	6.3
2	#5964.10	58.1 PK	68.2	-10.1	1.18 H	275	50.8	7.3

Antenna Polarity & Test Distance : Vertical at 3 m								
No	Frequency (MHz)	Emission Level (dBuV/m)	Limit (dBuV/m)	Margin (dB)	Antenna Height (m)	Table Angle (Degree)	Raw Value (dBuV)	Correction Factor (dB/m)
1	#5603.21	56.6 PK	68.2	-11.6	2.65 V	178	50.4	6.2
2	#5966.67	59.2 PK	68.2	-9.0	2.65 V	178	52.0	7.2

Remarks:

1. Emission Level(dBuV/m) = Raw Value(dBuV) + Correction Factor(dB/m)
2. Correction Factor(dB/m) = Antenna Factor(dB/m) + Cable Factor(dB) – Pre-Amplifier Factor(dB)
3. Margin value = Emission Level – Limit value
4. The other emission levels were very low against the limit.
5. " * ": Fundamental frequency.
6. " # ": The radiated frequency is out of the restricted band.

CHANNEL	TX Channel 165	DETECTOR FUNCTION	Peak (PK) Average (AV)
FREQUENCY RANGE	1GHz ~ 40GHz		

Antenna Polarity & Test Distance : Horizontal at 3 m								
No	Frequency (MHz)	Emission Level (dBuV/m)	Limit (dBuV/m)	Margin (dB)	Antenna Height (m)	Table Angle (Degree)	Raw Value (dBuV)	Correction Factor (dB/m)
1	*5825.00	104.0 PK	-	-	1.13 H	285	61.7	42.3
2	*5825.00	93.3 AV	-	-	1.13 H	285	51.0	42.3
3	11650.00	60.2 PK	74.0	-13.8	2.54 H	167	42.2	18.0
4	11650.00	46.4 AV	54.0	-7.6	2.54 H	167	28.4	18.0

Antenna Polarity & Test Distance : Vertical at 3 m								
No	Frequency (MHz)	Emission Level (dBuV/m)	Limit (dBuV/m)	Margin (dB)	Antenna Height (m)	Table Angle (Degree)	Raw Value (dBuV)	Correction Factor (dB/m)
1	*5825.00	113.0 PK	-	-	2.64 V	177	70.7	42.3
2	*5825.00	101.7 AV	-	-	2.64 V	177	59.4	42.3
3	11650.00	62.2 PK	74.0	-11.8	1.13 V	97	44.2	18.0
4	11650.00	48.6 AV	54.0	-5.4	1.13 V	97	30.6	18.0

<Out of Band Emission (OOBE)>

Antenna Polarity & Test Distance : Horizontal at 3 m								
No	Frequency (MHz)	Emission Level (dBuV/m)	Limit (dBuV/m)	Margin (dB)	Antenna Height (m)	Table Angle (Degree)	Raw Value (dBuV)	Correction Factor (dB/m)
1	#5632.05	56.5 PK	68.2	-11.7	1.13 H	285	50.2	6.3
2	#5947.44	58.7 PK	68.2	-9.5	1.13 H	285	51.4	7.3

Antenna Polarity & Test Distance : Vertical at 3 m								
No	Frequency (MHz)	Emission Level (dBuV/m)	Limit (dBuV/m)	Margin (dB)	Antenna Height (m)	Table Angle (Degree)	Raw Value (dBuV)	Correction Factor (dB/m)
1	#5643.59	56.6 PK	68.2	-11.6	2.64 V	177	50.3	6.3
2	#5986.54	58.3 PK	68.2	-9.9	2.64 V	177	51.1	7.2

Remarks:

1. Emission Level(dBuV/m) = Raw Value(dBuV) + Correction Factor(dB/m)
2. Correction Factor(dB/m) = Antenna Factor(dB/m) + Cable Factor(dB) – Pre-Amplifier Factor(dB)
3. Margin value = Emission Level – Limit value
4. The other emission levels were very low against the limit.
5. " * ": Fundamental frequency.
6. " # ": The radiated frequency is out of the restricted band.

802.11ac (VHT40)

CHANNEL	TX Channel 38	DETECTOR FUNCTION	Peak (PK) Average (AV)
FREQUENCY RANGE	1GHz ~ 40GHz		

Antenna Polarity & Test Distance : Horizontal at 3 m								
No	Frequency (MHz)	Emission Level (dBuV/m)	Limit (dBuV/m)	Margin (dB)	Antenna Height (m)	Table Angle (Degree)	Raw Value (dBuV)	Correction Factor (dB/m)
1	5150.00	58.2 PK	74.0	-15.8	1.09 H	272	51.6	6.6
2	5150.00	46.1 AV	54.0	-7.9	1.09 H	272	39.5	6.6
3	*5190.00	96.9 PK	-	-	1.09 H	272	54.8	42.1
4	*5190.00	87.8 AV	-	-	1.09 H	272	45.7	42.1
5	#10380.00	58.6 PK	68.2	-9.6	1.91 H	166	41.8	16.8

Antenna Polarity & Test Distance : Vertical at 3 m								
No	Frequency (MHz)	Emission Level (dBuV/m)	Limit (dBuV/m)	Margin (dB)	Antenna Height (m)	Table Angle (Degree)	Raw Value (dBuV)	Correction Factor (dB/m)
1	5150.00	65.7 PK	74.0	-8.3	2.16 V	315	59.1	6.6
2	5150.00	52.3 AV	54.0	-1.7	2.16 V	315	45.7	6.6
3	*5190.00	105.4 PK	-	-	2.16 V	315	63.3	42.1
4	*5190.00	95.7 AV	-	-	2.16 V	315	53.6	42.1
5	#10380.00	59.0 PK	68.2	-9.2	1.68 V	22	42.2	16.8

Remarks:

1. Emission Level(dBuV/m) = Raw Value(dBuV) + Correction Factor(dB/m)
2. Correction Factor(dB/m) = Antenna Factor(dB/m) + Cable Factor(dB) – Pre-Amplifier Factor(dB)
3. Margin value = Emission Level – Limit value
4. The other emission levels were very low against the limit.
5. " * ": Fundamental frequency.
6. " # ": The radiated frequency is out of the restricted band.

CHANNEL	TX Channel 46	DETECTOR FUNCTION	Peak (PK)
FREQUENCY RANGE	1GHz ~ 40GHz		Average (AV)

Antenna Polarity & Test Distance : Horizontal at 3 m

No	Frequency (MHz)	Emission Level (dBuV/m)	Limit (dBuV/m)	Margin (dB)	Antenna Height (m)	Table Angle (Degree)	Raw Value (dBuV)	Correction Factor (dB/m)
1	*5230.00	99.9 PK	-	-	1.05 H	283	57.9	42.0
2	*5230.00	90.0 AV	-	-	1.05 H	283	48.0	42.0
3	5350.00	57.3 PK	74.0	-16.7	1.05 H	283	50.9	6.4
4	5350.00	44.4 AV	54.0	-9.6	1.05 H	283	38.0	6.4
5	#10460.00	59.2 PK	68.2	-9.0	1.92 H	155	41.8	17.4

Antenna Polarity & Test Distance : Vertical at 3 m

No	Frequency (MHz)	Emission Level (dBuV/m)	Limit (dBuV/m)	Margin (dB)	Antenna Height (m)	Table Angle (Degree)	Raw Value (dBuV)	Correction Factor (dB/m)
1	*5230.00	106.4 PK	-	-	1.77 V	329	64.4	42.0
2	*5230.00	96.6 AV	-	-	1.77 V	329	54.6	42.0
3	5350.00	58.0 PK	74.0	-16.0	1.77 V	329	51.6	6.4
4	5350.00	44.7 AV	54.0	-9.3	1.77 V	329	38.3	6.4
5	#10460.00	59.5 PK	68.2	-8.7	1.69 V	26	42.1	17.4

Remarks:

1. Emission Level(dBuV/m) = Raw Value(dBuV) + Correction Factor(dB/m)
2. Correction Factor(dB/m) = Antenna Factor(dB/m) + Cable Factor(dB) – Pre-Amplifier Factor(dB)
3. Margin value = Emission Level – Limit value
4. The other emission levels were very low against the limit.
5. " * ": Fundamental frequency.
6. " # ": The radiated frequency is out of the restricted band.

CHANNEL	TX Channel 54	DETECTOR FUNCTION	Peak (PK)
FREQUENCY RANGE	1GHz ~ 40GHz		Average (AV)

Antenna Polarity & Test Distance : Horizontal at 3 m

No	Frequency (MHz)	Emission Level (dBuV/m)	Limit (dBuV/m)	Margin (dB)	Antenna Height (m)	Table Angle (Degree)	Raw Value (dBuV)	Correction Factor (dB/m)
1	5150.00	59.2 PK	74.0	-14.8	1.40 H	189	52.6	6.6
2	5150.00	46.1 AV	54.0	-7.9	1.40 H	189	39.5	6.6
3	*5270.00	99.3 PK	-	-	1.40 H	189	57.4	41.9
4	*5270.00	89.5 AV	-	-	1.40 H	189	47.6	41.9
5	#10540.00	59.9 PK	68.2	-8.3	2.22 H	189	42.3	17.6

Antenna Polarity & Test Distance : Vertical at 3 m

No	Frequency (MHz)	Emission Level (dBuV/m)	Limit (dBuV/m)	Margin (dB)	Antenna Height (m)	Table Angle (Degree)	Raw Value (dBuV)	Correction Factor (dB/m)
1	5150.00	58.6 PK	74.0	-15.4	1.77 V	328	52.0	6.6
2	5150.00	46.6 AV	54.0	-7.4	1.77 V	328	40.0	6.6
3	*5270.00	108.0 PK	-	-	1.77 V	328	66.1	41.9
4	*5270.00	98.2 AV	-	-	1.77 V	328	56.3	41.9
5	#10540.00	59.8 PK	68.2	-8.4	3.24 V	77	42.2	17.6

Remarks:

1. Emission Level(dBuV/m) = Raw Value(dBuV) + Correction Factor(dB/m)
2. Correction Factor(dB/m) = Antenna Factor(dB/m) + Cable Factor(dB) – Pre-Amplifier Factor(dB)
3. Margin value = Emission Level – Limit value
4. The other emission levels were very low against the limit.
5. " * ": Fundamental frequency.
6. " # ": The radiated frequency is out of the restricted band.

CHANNEL	TX Channel 62	DETECTOR FUNCTION	Peak (PK)
FREQUENCY RANGE	1GHz ~ 40GHz		Average (AV)

Antenna Polarity & Test Distance : Horizontal at 3 m

No	Frequency (MHz)	Emission Level (dBuV/m)	Limit (dBuV/m)	Margin (dB)	Antenna Height (m)	Table Angle (Degree)	Raw Value (dBuV)	Correction Factor (dB/m)
1	*5310.00	98.8 PK	-	-	1.28 H	182	56.8	42.0
2	*5310.00	88.9 AV	-	-	1.28 H	182	46.9	42.0
3	5350.00	57.6 PK	74.0	-16.4	1.28 H	182	51.2	6.4
4	5350.00	45.1 AV	54.0	-8.9	1.28 H	182	38.7	6.4
5	10620.00	59.6 PK	74.0	-14.4	1.85 H	192	42.2	17.4
6	10620.00	45.8 AV	54.0	-8.2	1.85 H	192	28.4	17.4

Antenna Polarity & Test Distance : Vertical at 3 m

No	Frequency (MHz)	Emission Level (dBuV/m)	Limit (dBuV/m)	Margin (dB)	Antenna Height (m)	Table Angle (Degree)	Raw Value (dBuV)	Correction Factor (dB/m)
1	*5310.00	107.1 PK	-	-	1.75 V	354	65.1	42.0
2	*5310.00	97.4 AV	-	-	1.75 V	354	55.4	42.0
3	5350.00	57.8 PK	74.0	-16.2	1.75 V	354	51.4	6.4
4	5350.00	46.4 AV	54.0	-7.6	1.75 V	354	40.0	6.4
5	10620.00	59.6 PK	74.0	-14.4	2.96 V	113	42.2	17.4
6	10620.00	45.4 AV	54.0	-8.6	2.96 V	113	28.0	17.4

Remarks:

1. Emission Level(dBuV/m) = Raw Value(dBuV) + Correction Factor(dB/m)
2. Correction Factor(dB/m) = Antenna Factor(dB/m) + Cable Factor(dB) – Pre-Amplifier Factor(dB)
3. Margin value = Emission Level – Limit value
4. The other emission levels were very low against the limit.
5. " * ": Fundamental frequency.

CHANNEL	TX Channel 102	DETECTOR FUNCTION	Peak (PK)
FREQUENCY RANGE	1GHz ~ 40GHz		Average (AV)

Antenna Polarity & Test Distance : Horizontal at 3 m								
No	Frequency (MHz)	Emission Level (dBuV/m)	Limit (dBuV/m)	Margin (dB)	Antenna Height (m)	Table Angle (Degree)	Raw Value (dBuV)	Correction Factor (dB/m)
1	5460.00	57.8 PK	74.0	-16.2	1.00 H	277	51.5	6.3
2	5460.00	45.3 AV	54.0	-8.7	1.00 H	277	39.0	6.3
3	#5470.00	59.3 PK	68.2	-8.9	1.00 H	277	53.0	6.3
4	*5510.00	98.5 PK	-	-	1.00 H	277	56.4	42.1
5	*5510.00	89.0 AV	-	-	1.00 H	277	46.9	42.1
6	11020.00	60.8 PK	74.0	-13.2	2.88 H	156	42.2	18.6
7	11020.00	47.0 AV	54.0	-7.0	2.88 H	156	28.4	18.6

Antenna Polarity & Test Distance : Vertical at 3 m								
No	Frequency (MHz)	Emission Level (dBuV/m)	Limit (dBuV/m)	Margin (dB)	Antenna Height (m)	Table Angle (Degree)	Raw Value (dBuV)	Correction Factor (dB/m)
1	5460.00	58.5 PK	74.0	-15.5	2.31 V	205	52.2	6.3
2	5460.00	45.8 AV	54.0	-8.2	2.31 V	205	39.5	6.3
3	#5470.00	66.4 PK	68.2	-1.8	2.31 V	205	60.1	6.3
4	*5510.00	107.7 PK	-	-	2.31 V	205	65.6	42.1
5	*5510.00	98.2 AV	-	-	2.31 V	205	56.1	42.1
6	11020.00	59.8 PK	74.0	-14.2	1.37 V	107	41.2	18.6
7	11020.00	46.6 AV	54.0	-7.4	1.37 V	107	28.0	18.6

Remarks:

1. Emission Level(dBuV/m) = Raw Value(dBuV) + Correction Factor(dB/m)
2. Correction Factor(dB/m) = Antenna Factor(dB/m) + Cable Factor(dB) – Pre-Amplifier Factor(dB)
3. Margin value = Emission Level – Limit value
4. The other emission levels were very low against the limit.
5. " * ": Fundamental frequency.
6. " # ": The radiated frequency is out of the restricted band.

CHANNEL	TX Channel 110	DETECTOR FUNCTION	Peak (PK)
FREQUENCY RANGE	1GHz ~ 40GHz		Average (AV)

Antenna Polarity & Test Distance : Horizontal at 3 m

No	Frequency (MHz)	Emission Level (dBuV/m)	Limit (dBuV/m)	Margin (dB)	Antenna Height (m)	Table Angle (Degree)	Raw Value (dBuV)	Correction Factor (dB/m)
1	*5550.00	101.3 PK	-	-	1.05 H	275	59.2	42.1
2	*5550.00	91.9 AV	-	-	1.05 H	275	49.8	42.1
3	11100.00	60.6 PK	74.0	-13.4	2.55 H	186	42.3	18.3
4	11100.00	46.6 AV	54.0	-7.4	2.55 H	186	28.3	18.3

Antenna Polarity & Test Distance : Vertical at 3 m

No	Frequency (MHz)	Emission Level (dBuV/m)	Limit (dBuV/m)	Margin (dB)	Antenna Height (m)	Table Angle (Degree)	Raw Value (dBuV)	Correction Factor (dB/m)
1	*5550.00	107.7 PK	-	-	2.51 V	201	65.6	42.1
2	*5550.00	98.3 AV	-	-	2.51 V	201	56.2	42.1
3	11100.00	60.5 PK	74.0	-13.5	1.32 V	79	42.2	18.3
4	11100.00	46.6 AV	54.0	-7.4	1.32 V	79	28.3	18.3

Remarks:

1. Emission Level(dBuV/m) = Raw Value(dBuV) + Correction Factor(dB/m)
2. Correction Factor(dB/m) = Antenna Factor(dB/m) + Cable Factor(dB) – Pre-Amplifier Factor(dB)
3. Margin value = Emission Level – Limit value
4. The other emission levels were very low against the limit.
5. " * ": Fundamental frequency.

CHANNEL	TX Channel 134	DETECTOR FUNCTION	Peak (PK)
FREQUENCY RANGE	1GHz ~ 40GHz		Average (AV)

Antenna Polarity & Test Distance : Horizontal at 3 m								
No	Frequency (MHz)	Emission Level (dBuV/m)	Limit (dBuV/m)	Margin (dB)	Antenna Height (m)	Table Angle (Degree)	Raw Value (dBuV)	Correction Factor (dB/m)
1	*5670.00	100.6 PK	-	-	1.16 H	277	58.4	42.2
2	*5670.00	91.0 AV	-	-	1.16 H	277	48.8	42.2
3	#5725.00	58.0 PK	68.2	-10.2	1.16 H	277	51.5	6.5
4	11340.00	60.2 PK	74.0	-13.8	2.64 H	192	42.1	18.1
5	11340.00	46.7 AV	54.0	-7.3	2.64 H	192	28.6	18.1

Antenna Polarity & Test Distance : Vertical at 3 m								
No	Frequency (MHz)	Emission Level (dBuV/m)	Limit (dBuV/m)	Margin (dB)	Antenna Height (m)	Table Angle (Degree)	Raw Value (dBuV)	Correction Factor (dB/m)
1	*5670.00	107.4 PK	-	-	2.34 V	198	65.2	42.2
2	*5670.00	97.8 AV	-	-	2.34 V	198	55.6	42.2
3	#5725.00	58.0 PK	68.2	-10.2	2.34 V	198	51.5	6.5
4	11340.00	60.3 PK	74.0	-13.7	1.24 V	78	42.2	18.1
5	11340.00	47.0 AV	54.0	-7.0	1.24 V	78	28.9	18.1

Remarks:

1. Emission Level(dBuV/m) = Raw Value(dBuV) + Correction Factor(dB/m)
2. Correction Factor(dB/m) = Antenna Factor(dB/m) + Cable Factor(dB) – Pre-Amplifier Factor(dB)
3. Margin value = Emission Level – Limit value
4. The other emission levels were very low against the limit.
5. " * ": Fundamental frequency.
6. " # ": The radiated frequency is out of the restricted band.

CHANNEL	TX Channel 142	DETECTOR FUNCTION	Peak (PK) Average (AV)
FREQUENCY RANGE	1GHz ~ 40GHz		

Antenna Polarity & Test Distance : Horizontal at 3 m

No	Frequency (MHz)	Emission Level (dBuV/m)	Limit (dBuV/m)	Margin (dB)	Antenna Height (m)	Table Angle (Degree)	Raw Value (dBuV)	Correction Factor (dB/m)
1	#5470.00	57.8 PK	68.2	-10.4	1.21 H	275	51.5	6.3
2	*5710.00	101.7 PK	-	-	1.21 H	275	59.4	42.3
3	*5710.00	92.0 AV	-	-	1.21 H	275	49.7	42.3
4	#5850.00	58.1 PK	68.2	-10.1	1.21 H	275	51.3	6.8
5	11420.00	60.5 PK	74.0	-13.5	2.55 H	169	42.6	17.9
6	11420.00	46.1 AV	54.0	-7.9	2.55 H	169	28.2	17.9

Antenna Polarity & Test Distance : Vertical at 3 m

No	Frequency (MHz)	Emission Level (dBuV/m)	Limit (dBuV/m)	Margin (dB)	Antenna Height (m)	Table Angle (Degree)	Raw Value (dBuV)	Correction Factor (dB/m)
1	#5470.00	58.6 PK	68.2	-9.6	2.58 V	257	52.3	6.3
2	*5710.00	107.9 PK	-	-	2.58 V	257	65.6	42.3
3	*5710.00	98.3 AV	-	-	2.58 V	257	56.0	42.3
4	#5850.00	58.4 PK	68.2	-9.8	2.58 V	257	51.6	6.8
5	11420.00	60.7 PK	74.0	-13.3	1.05 V	97	42.8	17.9
6	11420.00	46.6 AV	54.0	-7.4	1.05 V	97	28.7	17.9

Remarks:

1. Emission Level(dBuV/m) = Raw Value(dBuV) + Correction Factor(dB/m)
2. Correction Factor(dB/m) = Antenna Factor(dB/m) + Cable Factor(dB) – Pre-Amplifier Factor(dB)
3. Margin value = Emission Level – Limit value
4. The other emission levels were very low against the limit.
5. " * ": Fundamental frequency.
6. " # ": The radiated frequency is out of the restricted band.

CHANNEL	TX Channel 151	DETECTOR FUNCTION	Peak (PK) Average (AV)
FREQUENCY RANGE	1GHz ~ 40GHz		

Antenna Polarity & Test Distance : Horizontal at 3 m								
No	Frequency (MHz)	Emission Level (dBuV/m)	Limit (dBuV/m)	Margin (dB)	Antenna Height (m)	Table Angle (Degree)	Raw Value (dBuV)	Correction Factor (dB/m)
1	*5755.00	100.8 PK	-	-	1.25 H	273	58.5	42.3
2	*5755.00	91.4 AV	-	-	1.25 H	273	49.1	42.3
3	11510.00	60.1 PK	74.0	-13.9	2.46 H	178	41.9	18.2
4	11510.00	46.5 AV	54.0	-7.5	2.46 H	178	28.3	18.2
Antenna Polarity & Test Distance : Vertical at 3 m								
No	Frequency (MHz)	Emission Level (dBuV/m)	Limit (dBuV/m)	Margin (dB)	Antenna Height (m)	Table Angle (Degree)	Raw Value (dBuV)	Correction Factor (dB/m)
1	*5755.00	108.7 PK	-	-	2.66 V	163	66.4	42.3
2	*5755.00	98.3 AV	-	-	2.66 V	163	56.0	42.3
3	11510.00	60.2 PK	74.0	-13.8	1.12 V	97	42.0	18.2
4	11510.00	47.9 AV	54.0	-6.1	1.12 V	97	29.7	18.2

<Out of Band Emission (OOBE)>

Antenna Polarity & Test Distance : Horizontal at 3 m								
No	Frequency (MHz)	Emission Level (dBuV/m)	Limit (dBuV/m)	Margin (dB)	Antenna Height (m)	Table Angle (Degree)	Raw Value (dBuV)	Correction Factor (dB/m)
1	#5601.28	55.9 PK	68.2	-12.3	1.25 H	273	49.7	6.2
2	#5935.26	58.0 PK	68.2	-10.2	1.25 H	273	50.7	7.3
Antenna Polarity & Test Distance : Vertical at 3 m								
No	Frequency (MHz)	Emission Level (dBuV/m)	Limit (dBuV/m)	Margin (dB)	Antenna Height (m)	Table Angle (Degree)	Raw Value (dBuV)	Correction Factor (dB/m)
1	#5642.95	57.2 PK	68.2	-11.0	2.66 V	163	50.9	6.3
2	#5932.05	58.6 PK	68.2	-9.6	2.66 V	163	51.3	7.3

Remarks:

1. Emission Level(dBuV/m) = Raw Value(dBuV) + Correction Factor(dB/m)
2. Correction Factor(dB/m) = Antenna Factor(dB/m) + Cable Factor(dB) – Pre-Amplifier Factor(dB)
3. Margin value = Emission Level – Limit value
4. The other emission levels were very low against the limit.
5. " * ": Fundamental frequency.
6. " # ": The radiated frequency is out of the restricted band.

CHANNEL	TX Channel 159	DETECTOR FUNCTION	Peak (PK) Average (AV)
FREQUENCY RANGE	1GHz ~ 40GHz		

Antenna Polarity & Test Distance : Horizontal at 3 m								
No	Frequency (MHz)	Emission Level (dBuV/m)	Limit (dBuV/m)	Margin (dB)	Antenna Height (m)	Table Angle (Degree)	Raw Value (dBuV)	Correction Factor (dB/m)
1	*5795.00	100.5 PK	-	-	1.30 H	287	58.3	42.2
2	*5795.00	90.5 AV	-	-	1.30 H	287	48.3	42.2
3	11590.00	59.7 PK	74.0	-14.3	2.28 H	177	41.9	17.8
4	11590.00	46.1 AV	54.0	-7.9	2.28 H	177	28.3	17.8

Antenna Polarity & Test Distance : Vertical at 3 m								
No	Frequency (MHz)	Emission Level (dBuV/m)	Limit (dBuV/m)	Margin (dB)	Antenna Height (m)	Table Angle (Degree)	Raw Value (dBuV)	Correction Factor (dB/m)
1	*5795.00	109.1 PK	-	-	2.76 V	257	66.9	42.2
2	*5795.00	99.3 AV	-	-	2.76 V	257	57.1	42.2
3	11590.00	59.3 PK	74.0	-14.7	1.02 V	99	41.5	17.8
4	11590.00	46.4 AV	54.0	-7.6	1.02 V	99	28.6	17.8

<Out of Band Emission (OOBE)>

Antenna Polarity & Test Distance : Horizontal at 3 m								
No	Frequency (MHz)	Emission Level (dBuV/m)	Limit (dBuV/m)	Margin (dB)	Antenna Height (m)	Table Angle (Degree)	Raw Value (dBuV)	Correction Factor (dB/m)
1	#5632.05	56.0 PK	68.2	-12.2	1.30 H	287	49.7	6.3
2	#5980.77	57.8 PK	68.2	-10.4	1.30 H	287	50.6	7.2

Antenna Polarity & Test Distance : Vertical at 3 m								
No	Frequency (MHz)	Emission Level (dBuV/m)	Limit (dBuV/m)	Margin (dB)	Antenna Height (m)	Table Angle (Degree)	Raw Value (dBuV)	Correction Factor (dB/m)
1	#5627.56	56.0 PK	68.2	-12.2	2.76 V	257	49.8	6.2
2	#5972.44	59.2 PK	68.2	-9.0	2.76 V	257	52.0	7.2

Remarks:

1. Emission Level(dBuV/m) = Raw Value(dBuV) + Correction Factor(dB/m)
2. Correction Factor(dB/m) = Antenna Factor(dB/m) + Cable Factor(dB) – Pre-Amplifier Factor(dB)
3. Margin value = Emission Level – Limit value
4. The other emission levels were very low against the limit.
5. " * " : Fundamental frequency.
6. " # " : The radiated frequency is out of the restricted band.

802.11ac (VHT80)

CHANNEL	TX Channel 42	DETECTOR FUNCTION	Peak (PK)
FREQUENCY RANGE	1GHz ~ 40GHz		Average (AV)

Antenna Polarity & Test Distance : Horizontal at 3 m								
No	Frequency (MHz)	Emission Level (dBuV/m)	Limit (dBuV/m)	Margin (dB)	Antenna Height (m)	Table Angle (Degree)	Raw Value (dBuV)	Correction Factor (dB/m)
1	5150.00	59.1 PK	74.0	-14.9	1.07 H	280	52.5	6.6
2	5150.00	46.8 AV	54.0	-7.2	1.07 H	280	40.2	6.6
3	*5210.00	96.6 PK	-	-	1.07 H	280	54.6	42.0
4	*5210.00	87.3 AV	-	-	1.07 H	280	45.3	42.0
5	5350.00	57.1 PK	74.0	-16.9	1.07 H	280	50.7	6.4
6	5350.00	45.0 AV	54.0	-9.0	1.07 H	280	38.6	6.4
7	#10420.00	59.2 PK	68.2	-9.0	2.05 H	163	42.0	17.2
Antenna Polarity & Test Distance : Vertical at 3 m								
No	Frequency (MHz)	Emission Level (dBuV/m)	Limit (dBuV/m)	Margin (dB)	Antenna Height (m)	Table Angle (Degree)	Raw Value (dBuV)	Correction Factor (dB/m)
1	5150.00	64.6 PK	74.0	-9.4	2.16 V	276	58.0	6.6
2	5150.00	52.4 AV	54.0	-1.6	2.16 V	276	45.8	6.6
3	*5210.00	103.8 PK	-	-	2.16 V	276	61.8	42.0
4	*5210.00	94.0 AV	-	-	2.16 V	276	52.0	42.0
5	5350.00	57.4 PK	74.0	-16.6	2.16 V	276	51.0	6.4
6	5350.00	45.0 AV	54.0	-9.0	2.16 V	276	38.6	6.4
7	#10420.00	59.4 PK	68.2	-8.8	1.66 V	25	42.2	17.2

Remarks:

1. Emission Level(dBuV/m) = Raw Value(dBuV) + Correction Factor(dB/m)
2. Correction Factor(dB/m) = Antenna Factor(dB/m) + Cable Factor(dB) – Pre-Amplifier Factor(dB)
3. Margin value = Emission Level – Limit value
4. The other emission levels were very low against the limit.
5. " * ": Fundamental frequency.
6. " # ": The radiated frequency is out of the restricted band.

CHANNEL	TX Channel 58	DETECTOR FUNCTION	Peak (PK) Average (AV)
FREQUENCY RANGE	1GHz ~ 40GHz		

Antenna Polarity & Test Distance : Horizontal at 3 m								
No	Frequency (MHz)	Emission Level (dBuV/m)	Limit (dBuV/m)	Margin (dB)	Antenna Height (m)	Table Angle (Degree)	Raw Value (dBuV)	Correction Factor (dB/m)
1	5150.00	58.6 PK	74.0	-15.4	1.19 H	276	52.0	6.6
2	5150.00	46.4 AV	54.0	-7.6	1.19 H	276	39.8	6.6
3	*5290.00	97.7 PK	-	-	1.19 H	276	55.8	41.9
4	*5290.00	88.1 AV	-	-	1.19 H	276	46.2	41.9
5	5350.00	57.6 PK	74.0	-16.4	1.19 H	276	51.2	6.4
6	5350.00	45.9 AV	54.0	-8.1	1.19 H	276	39.5	6.4
7	#10580.00	59.6 PK	68.2	-8.6	2.64 H	199	42.2	17.4

Antenna Polarity & Test Distance : Vertical at 3 m								
No	Frequency (MHz)	Emission Level (dBuV/m)	Limit (dBuV/m)	Margin (dB)	Antenna Height (m)	Table Angle (Degree)	Raw Value (dBuV)	Correction Factor (dB/m)
1	5150.00	59.4 PK	74.0	-14.6	2.45 V	154	52.8	6.6
2	5150.00	46.8 AV	54.0	-7.2	2.45 V	154	40.2	6.6
3	*5290.00	105.7 PK	-	-	2.45 V	154	63.8	41.9
4	*5290.00	96.1 AV	-	-	2.45 V	154	54.2	41.9
5	5350.00	61.2 PK	74.0	-12.8	2.45 V	154	54.8	6.4
6	5350.00	48.4 AV	54.0	-5.6	2.45 V	154	42.0	6.4
7	#10580.00	59.7 PK	68.2	-8.5	2.96 V	113	42.3	17.4

Remarks:

1. Emission Level(dBuV/m) = Raw Value(dBuV) + Correction Factor(dB/m)
2. Correction Factor(dB/m) = Antenna Factor(dB/m) + Cable Factor(dB) – Pre-Amplifier Factor(dB)
3. Margin value = Emission Level – Limit value
4. The other emission levels were very low against the limit.
5. " * ": Fundamental frequency.
6. " # ": The radiated frequency is out of the restricted band.

CHANNEL	TX Channel 106	DETECTOR FUNCTION	Peak (PK) Average (AV)
FREQUENCY RANGE	1GHz ~ 40GHz		

Antenna Polarity & Test Distance : Horizontal at 3 m								
No	Frequency (MHz)	Emission Level (dBuV/m)	Limit (dBuV/m)	Margin (dB)	Antenna Height (m)	Table Angle (Degree)	Raw Value (dBuV)	Correction Factor (dB/m)
1	5460.00	58.3 PK	74.0	-15.7	1.18 H	278	52.0	6.3
2	5460.00	46.2 AV	54.0	-7.8	1.18 H	278	39.9	6.3
3	#5470.00	58.9 PK	68.2	-9.3	1.18 H	278	52.6	6.3
4	*5530.00	95.5 PK	-	-	1.18 H	278	53.4	42.1
5	*5530.00	86.1 AV	-	-	1.18 H	278	44.0	42.1
6	#5725.00	57.7 PK	68.2	-10.5	1.18 H	278	51.2	6.5
7	11060.00	60.9 PK	74.0	-13.1	2.89 H	176	42.5	18.4
8	11060.00	47.9 AV	54.0	-6.1	2.89 H	176	29.5	18.4

Antenna Polarity & Test Distance : Vertical at 3 m								
No	Frequency (MHz)	Emission Level (dBuV/m)	Limit (dBuV/m)	Margin (dB)	Antenna Height (m)	Table Angle (Degree)	Raw Value (dBuV)	Correction Factor (dB/m)
1	5460.00	61.9 PK	74.0	-12.1	2.78 V	259	55.6	6.3
2	5460.00	49.3 AV	54.0	-4.7	2.78 V	259	43.0	6.3
3	#5470.00	66.5 PK	68.2	-1.7	2.78 V	259	60.2	6.3
4	*5530.00	102.9 PK	-	-	2.78 V	259	60.8	42.1
5	*5530.00	93.0 AV	-	-	2.78 V	259	50.9	42.1
6	#5725.00	58.0 PK	68.2	-10.2	2.78 V	259	51.5	6.5
7	11060.00	60.6 PK	74.0	-13.4	1.27 V	103	42.2	18.4
8	11060.00	47.2 AV	54.0	-6.8	1.27 V	103	28.8	18.4

Remarks:

1. Emission Level(dBuV/m) = Raw Value(dBuV) + Correction Factor(dB/m)
2. Correction Factor(dB/m) = Antenna Factor(dB/m) + Cable Factor(dB) – Pre-Amplifier Factor(dB)
3. Margin value = Emission Level – Limit value
4. The other emission levels were very low against the limit.
5. " * ": Fundamental frequency.
6. " # ": The radiated frequency is out of the restricted band.

CHANNEL	TX Channel 122	DETECTOR FUNCTION	Peak (PK) Average (AV)
FREQUENCY RANGE	1GHz ~ 40GHz		

Antenna Polarity & Test Distance : Horizontal at 3 m

No	Frequency (MHz)	Emission Level (dBuV/m)	Limit (dBuV/m)	Margin (dB)	Antenna Height (m)	Table Angle (Degree)	Raw Value (dBuV)	Correction Factor (dB/m)
1	#5470.00	57.7 PK	68.2	-10.5	1.44 H	279	51.4	6.3
2	*5610.00	97.5 PK	-	-	1.44 H	279	55.4	42.1
3	*5610.00	88.5 AV	-	-	1.44 H	279	46.4	42.1
4	#5725.00	57.5 PK	68.2	-10.7	1.44 H	279	51.0	6.5
5	11220.00	60.9 PK	74.0	-13.1	1.88 H	274	42.4	18.5
6	11220.00	48.0 AV	54.0	-6.0	1.88 H	274	29.5	18.5

Antenna Polarity & Test Distance : Vertical at 3 m

No	Frequency (MHz)	Emission Level (dBuV/m)	Limit (dBuV/m)	Margin (dB)	Antenna Height (m)	Table Angle (Degree)	Raw Value (dBuV)	Correction Factor (dB/m)
1	#5470.00	58.1 PK	68.2	-10.1	2.80 V	259	51.8	6.3
2	*5610.00	104.6 PK	-	-	2.80 V	259	62.5	42.1
3	*5610.00	94.9 AV	-	-	2.80 V	259	52.8	42.1
4	#5725.00	58.3 PK	68.2	-9.9	2.80 V	259	51.8	6.5
5	11220.00	60.3 PK	74.0	-13.7	1.38 V	124	41.8	18.5
6	11220.00	47.5 AV	54.0	-6.5	1.38 V	124	29.0	18.5

Remarks:

1. Emission Level(dBuV/m) = Raw Value(dBuV) + Correction Factor(dB/m)
2. Correction Factor(dB/m) = Antenna Factor(dB/m) + Cable Factor(dB) – Pre-Amplifier Factor(dB)
3. Margin value = Emission Level – Limit value
4. The other emission levels were very low against the limit.
5. " * ": Fundamental frequency.
6. " # ": The radiated frequency is out of the restricted band.

CHANNEL	TX Channel 138	DETECTOR FUNCTION	Peak (PK) Average (AV)
FREQUENCY RANGE	1GHz ~ 40GHz		

Antenna Polarity & Test Distance : Horizontal at 3 m

No	Frequency (MHz)	Emission Level (dBuV/m)	Limit (dBuV/m)	Margin (dB)	Antenna Height (m)	Table Angle (Degree)	Raw Value (dBuV)	Correction Factor (dB/m)
1	#5470.00	57.8 PK	68.2	-10.4	1.26 H	275	51.5	6.3
2	*5690.00	97.7 PK	-	-	1.26 H	275	55.4	42.3
3	*5690.00	89.0 AV	-	-	1.26 H	275	46.7	42.3
4	#5850.00	58.4 PK	68.2	-9.8	1.26 H	275	51.6	6.8
5	11380.00	60.1 PK	74.0	-13.9	2.18 H	156	42.3	17.8
6	11380.00	46.0 AV	54.0	-8.0	2.18 H	156	28.2	17.8

Antenna Polarity & Test Distance : Vertical at 3 m

No	Frequency (MHz)	Emission Level (dBuV/m)	Limit (dBuV/m)	Margin (dB)	Antenna Height (m)	Table Angle (Degree)	Raw Value (dBuV)	Correction Factor (dB/m)
1	#5470.00	58.3 PK	68.2	-9.9	2.74 V	257	52.0	6.3
2	*5690.00	105.7 PK	-	-	2.74 V	257	63.4	42.3
3	*5690.00	96.5 AV	-	-	2.74 V	257	54.2	42.3
4	#5850.00	58.6 PK	68.2	-9.6	2.74 V	257	51.8	6.8
5	11380.00	60.5 PK	74.0	-13.5	1.02 V	99	42.7	17.8
6	11380.00	46.2 AV	54.0	-7.8	1.02 V	99	28.4	17.8

Remarks:

1. Emission Level(dBuV/m) = Raw Value(dBuV) + Correction Factor(dB/m)
2. Correction Factor(dB/m) = Antenna Factor(dB/m) + Cable Factor(dB) – Pre-Amplifier Factor(dB)
3. Margin value = Emission Level – Limit value
4. The other emission levels were very low against the limit.
5. " * ": Fundamental frequency.
6. " # ": The radiated frequency is out of the restricted band.

CHANNEL	TX Channel 155	DETECTOR FUNCTION	Peak (PK) Average (AV)
FREQUENCY RANGE	1GHz ~ 40GHz		

Antenna Polarity & Test Distance : Horizontal at 3 m								
No	Frequency (MHz)	Emission Level (dBuV/m)	Limit (dBuV/m)	Margin (dB)	Antenna Height (m)	Table Angle (Degree)	Raw Value (dBuV)	Correction Factor (dB/m)
1	#5650.00	57.5 PK	68.2	-10.7	1.11 H	278	51.2	6.3
2	*5775.00	98.2 PK	-	-	1.11 H	278	56.0	42.2
3	*5775.00	88.3 AV	-	-	1.11 H	278	46.1	42.2
4	#5925.00	58.9 PK	68.2	-9.3	1.11 H	278	51.6	7.3
5	11550.00	59.6 PK	74.0	-14.4	2.64 H	183	41.5	18.1
6	11550.00	46.2 AV	54.0	-7.8	2.64 H	183	28.1	18.1

Antenna Polarity & Test Distance : Vertical at 3 m								
No	Frequency (MHz)	Emission Level (dBuV/m)	Limit (dBuV/m)	Margin (dB)	Antenna Height (m)	Table Angle (Degree)	Raw Value (dBuV)	Correction Factor (dB/m)
1	#5650.00	57.5 PK	68.2	-10.7	2.22 V	342	51.2	6.3
2	*5775.00	105.5 PK	-	-	2.22 V	342	63.3	42.2
3	*5775.00	95.8 AV	-	-	2.22 V	342	53.6	42.2
4	#5925.00	60.5 PK	68.2	-7.7	2.22 V	342	53.2	7.3
5	11550.00	59.8 PK	74.0	-14.2	1.06 V	99	41.7	18.1
6	11550.00	46.7 AV	54.0	-7.3	1.06 V	99	28.6	18.1

<Out of Band Emission (OOBE)>

Antenna Polarity & Test Distance : Horizontal at 3 m								
No	Frequency (MHz)	Emission Level (dBuV/m)	Limit (dBuV/m)	Margin (dB)	Antenna Height (m)	Table Angle (Degree)	Raw Value (dBuV)	Correction Factor (dB/m)
1	#5647.44	57.2 PK	68.2	-11.0	1.11 H	278	50.9	6.3
2	#5957.69	59.0 PK	68.2	-9.2	1.11 H	278	51.7	7.3

Antenna Polarity & Test Distance : Vertical at 3 m								
No	Frequency (MHz)	Emission Level (dBuV/m)	Limit (dBuV/m)	Margin (dB)	Antenna Height (m)	Table Angle (Degree)	Raw Value (dBuV)	Correction Factor (dB/m)
1	#5630.77	57.9 PK	68.2	-10.3	2.22 V	342	51.6	6.3
2	#5966.67	58.4 PK	68.2	-9.8	2.22 V	342	51.2	7.2

Remarks:

1. Emission Level(dBuV/m) = Raw Value(dBuV) + Correction Factor(dB/m)
2. Correction Factor(dB/m) = Antenna Factor(dB/m) + Cable Factor(dB) – Pre-Amplifier Factor(dB)
3. Margin value = Emission Level – Limit value
4. The other emission levels were very low against the limit.
5. " * " : Fundamental frequency.
6. " # " : The radiated frequency is out of the restricted band.

9 kHz ~ 30 MHz Data:

The amplitude of spurious emissions attenuated more than 20 dB below the permissible value is not required to be report.

30 MHz ~ 1 GHz Worst-Case Data:

802.11ac (VHT80)

CHANNEL	TX Channel 42	DETECTOR FUNCTION	Quasi-Peak (QP)
FREQUENCY RANGE	30MHz ~ 1GHz		

Antenna Polarity & Test Distance : Horizontal at 3 m								
No	Frequency (MHz)	Emission Level (dBuV/m)	Limit (dBuV/m)	Margin (dB)	Antenna Height (m)	Table Angle (Degree)	Raw Value (dBuV)	Correction Factor (dB/m)
1	48.28	21.8 QP	40.0	-18.2	1.00 H	289	30.9	-9.1
2	226.81	28.0 QP	46.0	-18.0	1.50 H	286	38.5	-10.5
3	263.36	33.3 QP	46.0	-12.7	1.50 H	282	41.1	-7.8
4	318.19	28.2 QP	46.0	-17.8	1.50 H	245	34.3	-6.1
5	460.17	30.4 QP	46.0	-15.6	2.00 H	233	33.4	-3.0
6	493.91	31.6 QP	46.0	-14.4	1.00 H	240	34.1	-2.5

Remarks:

1. Emission Level(dBuV/m) = Raw Value(dBuV) + Correction Factor(dB/m)
2. Correction Factor(dB/m) = Antenna Factor(dB/m) + Cable Factor(dB) – Pre-Amplifier Factor(dB)
3. Margin value = Emission Level – Limit value
4. The other emission levels were very low against the limit of frequency range 30MHz~1000MHz.
5. The emission levels were very low against the limit of frequency range 9kHz~30MHz: the amplitude of spurious emissions attenuated more than 20 dB below the permissible value to be report.

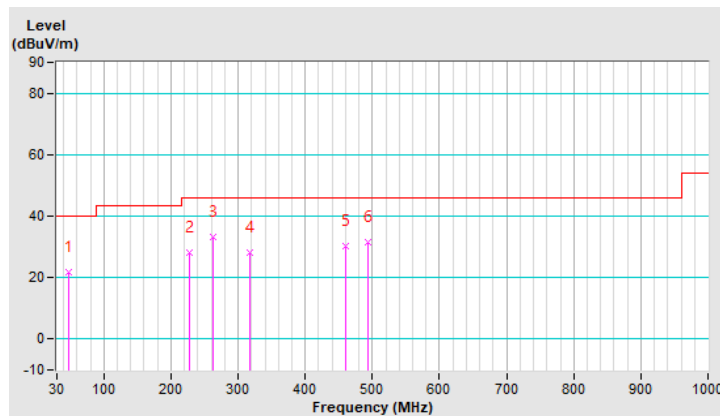

CHANNEL	TX Channel 42	DETECTOR FUNCTION	Quasi-Peak (QP)
FREQUENCY RANGE	30MHz ~ 1GHz		

Antenna Polarity & Test Distance : Vertical at 3 m								
No	Frequency (MHz)	Emission Level (dBuV/m)	Limit (dBuV/m)	Margin (dB)	Antenna Height (m)	Table Angle (Degree)	Raw Value (dBuV)	Correction Factor (dB/m)
1	49.68	32.2 QP	40.0	-7.8	1.49 V	288	41.3	-9.1
2	134.03	27.4 QP	43.5	-16.1	1.00 V	79	36.9	-9.5
3	162.14	26.4 QP	43.5	-17.1	1.00 V	204	34.8	-8.4
4	261.96	34.2 QP	46.0	-11.8	1.49 V	165	42.2	-8.0
5	318.19	34.9 QP	46.0	-11.1	2.00 V	2	41.0	-6.1
6	360.36	36.1 QP	46.0	-9.9	1.00 V	156	41.5	-5.4

Remarks:

1. Emission Level(dBuV/m) = Raw Value(dBuV) + Correction Factor(dB/m)
2. Correction Factor(dB/m) = Antenna Factor(dB/m) + Cable Factor(dB) – Pre-Amplifier Factor(dB)
3. Margin value = Emission Level – Limit value
4. The other emission levels were very low against the limit of frequency range 30MHz~1000MHz.
5. The emission levels were very low against the limit of frequency range 9kHz~30MHz: the amplitude of spurious emissions attenuated more than 20 dB below the permissible value to be report.

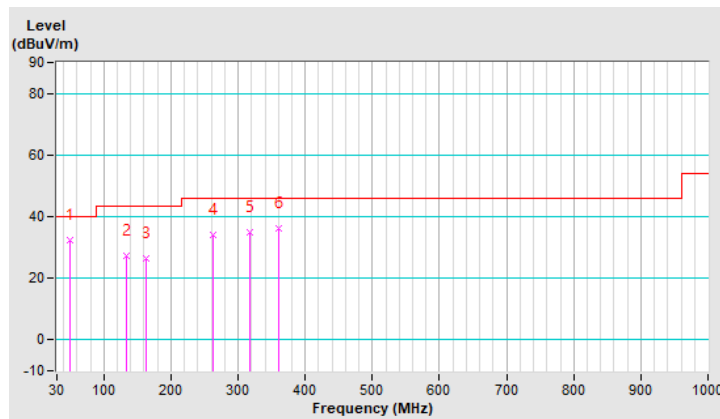

4.2 Conducted Emission Measurement

4.2.1 Limits of Conducted Emission Measurement

Frequency (MHz)	Conducted Limit (dBuV)	
	Quasi-Peak	Average
0.15 - 0.5	66 - 56	56 - 46
0.50 - 5.0	56	46
5.0 - 30.0	60	50

- Note: 1. The lower limit shall apply at the transition frequencies.
 2. The limit decreases in line with the logarithm of the frequency in the range of 0.15 to 0.50 MHz.

4.2.2 Test Instruments

Description & Manufacturer	Model No.	Serial No.	Date of Calibration	Due Date of Calibration
Test Receiver ROHDE & SCHWARZ	ESR3	102412	Feb. 17, 2020	Feb. 16, 2021
RF signal cable (with 10dB PAD) Woken	5D-FB	Cable-cond2-01	Sep. 04, 2020	Sep. 03, 2021
LISN/AMN ROHDE & SCHWARZ (EUT)	ESH2-Z5	100100	Jan. 20, 2020	Jan. 19, 2021
LISN/AMN ROHDE & SCHWARZ (Peripheral)	ESH3-Z5	100312	Aug. 18, 2020	Aug. 17, 2021
Software ADT	BV ADT_Cond_ V7.3.7.4	NA	NA	NA

- Note: 1. The calibration interval of the above test instruments is 12 months and the calibrations are traceable to NML/ROC and NIST/USA.
 2. The test was performed in HwaYa Shielded Room 2 (Conduction 2).
 3. The VCCI Site Registration No. is C-12047.

4.2.3 Test Procedures

- a. The EUT was placed 0.4 meters from the conducting wall of the shielded room with EUT being connected to the power mains through a line impedance stabilization network (LISN). Other support units were connected to the power mains through another LISN. The two LISNs provide 50 ohm/ 50uH of coupling impedance for the measuring instrument.
- b. Both lines of the power mains connected to the EUT were checked for maximum conducted interference.
- c. The frequency range from 150 kHz to 30 MHz was searched. Emission levels under (Limit -20 dB) was not recorded.

Note: All modes of operation were investigated and the worst-case emissions are reported.

4.2.4 Deviation from Test Standard

No deviation.

4.2.5 Test Setup

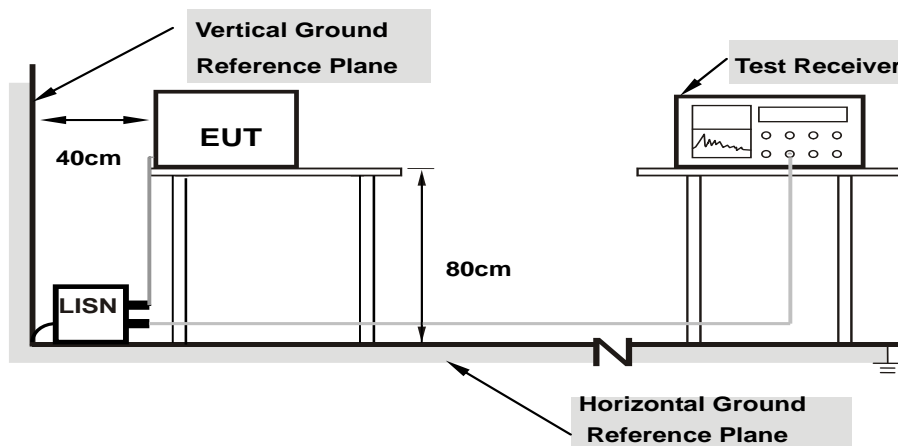

- Note:**
1. Support units were connected to second LISN.
 2. Both of LISNs (AMN) are 80 cm from EUT and at least 80 from other units and other metal planes

For the actual test configuration, please refer to the attached file (Test Setup Photo).

4.2.6 EUT Operating Conditions

- a. Placed the EUT on a testing table.
- b. Use the software to control the EUT under transmission condition continuously at specific channel frequency.

4.2.7 Test Results

Mode A

Frequency Range	150kHz ~ 30MHz	Detector Function & Resolution Bandwidth	Quasi-Peak (QP) / Average (AV), 9kHz
Input Power	120Vac, 60Hz	Environmental Conditions	24°C, 70%RH
Tested by	Willy Cheng	Test Date	2020/12/19

Phase Of Power : Line (L)										
No	Frequency (MHz)	Correction Factor (dB)	Reading Value (dBuV)		Emission Level (dBuV)		Limit (dBuV)		Margin (dB)	
			Q.P.	AV.	Q.P.	AV.	Q.P.	AV.	Q.P.	AV.
1	0.15000	10.09	50.57	38.75	60.66	48.84	66.00	56.00	-5.34	-7.16
2	0.52575	10.11	38.20	29.17	48.31	39.28	56.00	46.00	-7.69	-6.72
3	0.59550	10.12	28.18	18.99	38.30	29.11	56.00	46.00	-17.70	-16.89
4	4.91550	10.24	32.95	26.66	43.19	36.90	56.00	46.00	-12.81	-9.10
5	5.25750	10.24	32.63	26.60	42.87	36.84	60.00	50.00	-17.13	-13.16
6	8.58750	10.28	28.85	20.07	39.13	30.35	60.00	50.00	-20.87	-19.65

Remarks:

1. Q.P. and AV. are abbreviations of quasi-peak and average individually.
2. The emission levels of other frequencies were very low against the limit.
3. Margin value = Emission level – Limit value
4. Correction factor = Insertion loss + Cable loss
5. Emission Level = Correction Factor + Reading Value

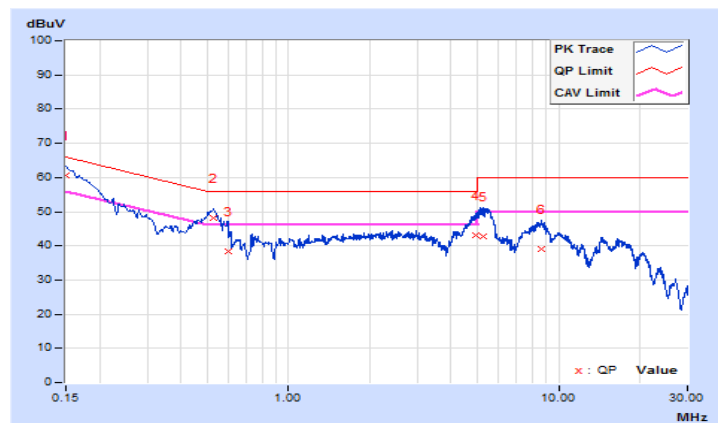

Frequency Range	150kHz ~ 30MHz	Detector Function & Resolution Bandwidth	Quasi-Peak (QP) / Average (AV), 9kHz
Input Power	120Vac, 60Hz	Environmental Conditions	24°C, 70%RH
Tested by	Willy Cheng	Test Date	2020/12/19

Phase Of Power : Neutral (N)										
No	Frequency (MHz)	Correction Factor (dB)	Reading Value (dBuV)		Emission Level (dBuV)		Limit (dBuV)		Margin (dB)	
			Q.P.	AV.	Q.P.	AV.	Q.P.	AV.	Q.P.	AV.
1	0.15225	10.06	49.96	34.87	60.02	44.93	65.88	55.88	-5.86	-10.95
2	0.18559	10.06	44.89	30.16	54.95	40.22	64.23	54.23	-9.28	-14.01
3	0.23290	10.06	38.20	24.98	48.26	35.04	62.35	52.35	-14.09	-17.31
4	0.51675	10.09	37.97	28.40	48.06	38.49	56.00	46.00	-7.94	-7.51
5	4.22925	10.24	31.01	23.51	41.25	33.75	56.00	46.00	-14.75	-12.25
6	5.13150	10.26	32.35	26.42	42.61	36.68	60.00	50.00	-17.39	-13.32

Remarks:

1. Q.P. and AV. are abbreviations of quasi-peak and average individually.
2. The emission levels of other frequencies were very low against the limit.
3. Margin value = Emission level – Limit value
4. Correction factor = Insertion loss + Cable loss
5. Emission Level = Correction Factor + Reading Value

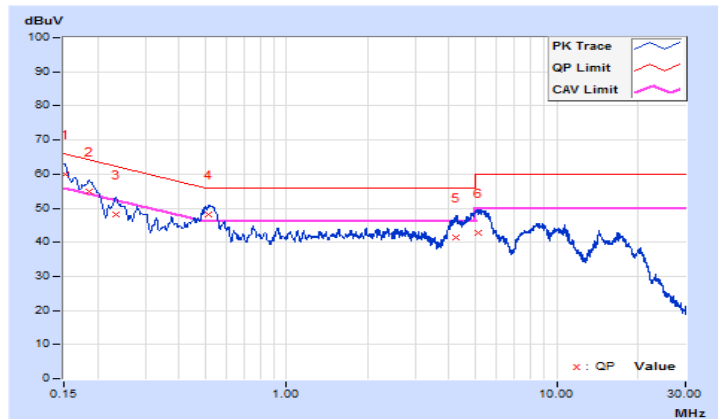

Mode B

Frequency Range	150kHz ~ 30MHz	Detector Function & Resolution Bandwidth	Quasi-Peak (QP) / Average (AV), 9kHz
Input Power	120Vac, 60Hz	Environmental Conditions	24°C, 70%RH
Tested by	Willy Cheng	Test Date	2020/12/19

Phase Of Power : Line (L)										
No	Frequency (MHz)	Correction Factor (dB)	Reading Value (dBuV)		Emission Level (dBuV)		Limit (dBuV)		Margin (dB)	
			Q.P.	AV.	Q.P.	AV.	Q.P.	AV.	Q.P.	AV.
1	0.15225	10.09	50.12	39.11	60.21	49.20	65.88	55.88	-5.67	-6.68
2	0.16524	10.09	44.04	26.47	54.13	36.56	65.20	55.20	-11.07	-18.64
3	0.19500	10.10	42.81	28.86	52.91	38.96	63.82	53.82	-10.91	-14.86
4	0.51900	10.11	37.71	27.40	47.82	37.51	56.00	46.00	-8.18	-8.49
5	4.77375	10.24	32.31	26.11	42.55	36.35	56.00	46.00	-13.45	-9.65
6	5.29800	10.25	32.93	26.83	43.18	37.08	60.00	50.00	-16.82	-12.92

Remarks:

1. Q.P. and AV. are abbreviations of quasi-peak and average individually.
2. The emission levels of other frequencies were very low against the limit.
3. Margin value = Emission level – Limit value
4. Correction factor = Insertion loss + Cable loss
5. Emission Level = Correction Factor + Reading Value

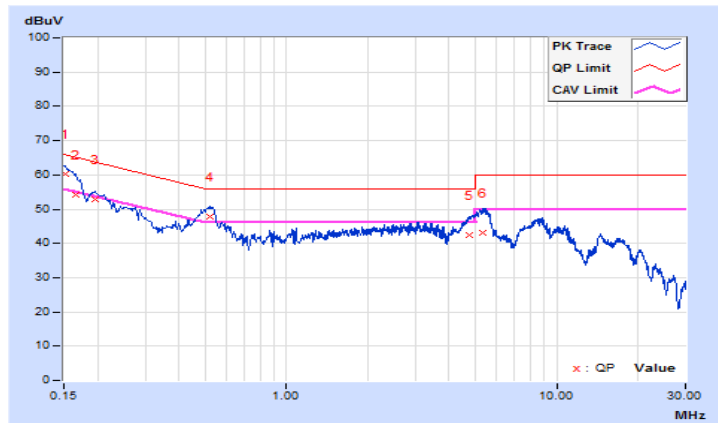

Frequency Range	150kHz ~ 30MHz	Detector Function & Resolution Bandwidth	Quasi-Peak (QP) / Average (AV), 9kHz
Input Power	120Vac, 60Hz	Environmental Conditions	24°C, 70%RH
Tested by	Willy Cheng	Test Date	2020/12/19

Phase Of Power : Neutral (N)										
No	Frequency (MHz)	Correction Factor (dB)	Reading Value (dBuV)		Emission Level (dBuV)		Limit (dBuV)		Margin (dB)	
			Q.P.	AV.	Q.P.	AV.	Q.P.	AV.	Q.P.	AV.
1	0.15225	10.06	49.92	39.32	59.98	49.38	65.88	55.88	-5.90	-6.50
2	0.19725	10.06	42.61	30.48	52.67	40.54	63.73	53.73	-11.06	-13.19
3	0.51425	10.09	38.83	29.02	48.92	39.11	56.00	46.00	-7.08	-6.89
4	4.16850	10.23	31.20	23.61	41.43	33.84	56.00	46.00	-14.57	-12.16
5	4.96500	10.26	33.14	26.96	43.40	37.22	56.00	46.00	-12.60	-8.78
6	5.48925	10.27	32.28	25.04	42.55	35.31	60.00	50.00	-17.45	-14.69

Remarks:

1. Q.P. and AV. are abbreviations of quasi-peak and average individually.
2. The emission levels of other frequencies were very low against the limit.
3. Margin value = Emission level – Limit value
4. Correction factor = Insertion loss + Cable loss
5. Emission Level = Correction Factor + Reading Value

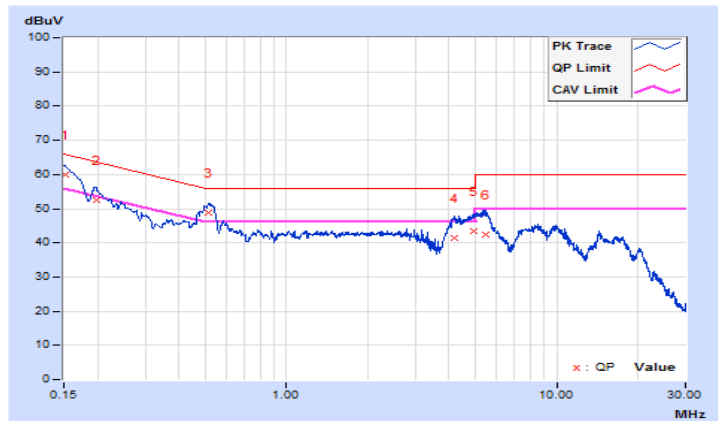

4.3 Transmit Power Measurement

4.3.1 Limits of Transmit Power Measurement

Operation Band	EUT Category		Limit
U-NII-1		Outdoor Access Point	1 Watt (30 dBm) (Max. e.i.r.p \leq 125 mW (21 dBm) at any elevation angle above 30 degrees as measured from the horizon)
		Fixed point-to-point Access Point	1 Watt (30 dBm)
		Indoor Access Point	1 Watt (30 dBm)
	√	Mobile and Portable client device	250 mW (24 dBm)
U-NII-2A		√	250 mW (24 dBm) or 11 dBm + 10 log B*
U-NII-2C		√	250 mW (24 dBm) or 11 dBm + 10 log B*
U-NII-3		√	1 Watt (30 dBm)

*B is the 26 dB emission bandwidth in megahertz

Per KDB 662911 Method of conducted output power measurement on IEEE 802.11 devices,

Array Gain = 0 dB (i.e., no array gain) for $N_{ANT} \leq 4$;

Array Gain = 0 dB (i.e., no array gain) for channel widths ≥ 40 MHz for any N_{ANT} ;

Array Gain = $5 \log(N_{ANT}/N_{SS})$ dB or 3 dB, whichever is less for 20 MHz channel widths with $N_{ANT} \geq 5$.

For power measurements on all other devices: Array Gain = $10 \log(N_{ANT}/N_{SS})$ dB.

4.3.2 Test Setup

<Power Output Measurement>

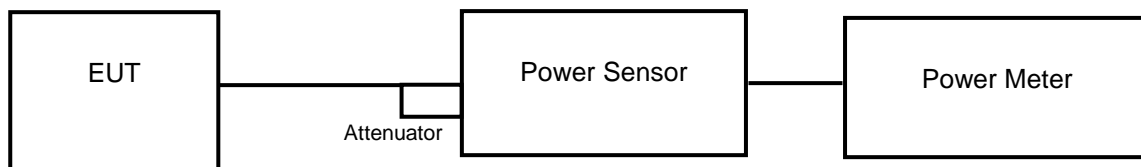

or

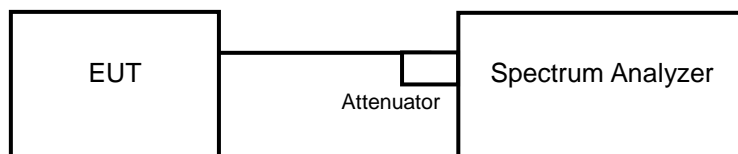

<26 dB Bandwidth>

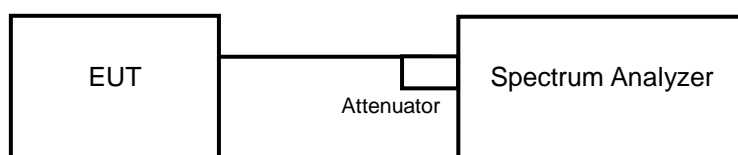

4.3.3 Test Instruments

Refer to section 4.1.2 to get information of above instrument.

4.3.4 Test Procedure

Average Power Measurement

<802.11a, 802.11ac (VHT20), 802.11ac (VHT40)>

Method PM is used to perform output power measurement, trigger and gating function of wide band power meter is enabled to measure max output power of TX on burst. Duty factor is not added to measured value.

<802.11ac (VHT80 and straddle channels)>

- a. Set span to encompass the entire 26 dB EBW (or, alternatively, the entire 99 % occupied bandwidth) of the signal.
- b. Set sweep trigger to “free run”.
- c. Set RBW = 1 MHz.
- d. Set VBW \geq 3 MHz
- e. Number of points in sweep \geq 2 Span / RBW.
- f. Sweep time \leq (number of points in sweep) * T
- g. Using emission bandwidth to determine the frequency span for integration the channel bandwidth.
- h. Detector = RMS.
- i. Trace mode = max hold.
- j. Allow max hold to run for at least 60 seconds, or longer as needed to allow the trace to stabilize.
- k. Compute power by integrating the spectrum across the EBW (or, alternatively, the entire 99% occupied bandwidth) of the signal using the instrument’s band power measurement function with band limits set equal to the EBW (or occupied bandwidth) band edges. If the instrument does not have a band power function, sum the spectrum levels (in power units) at 1 MHz intervals extending across the EBW (or, alternatively, the entire 99% occupied bandwidth) of the spectrum

26 dB Bandwidth

- a. Set RBW = approximately 1 % of the emission bandwidth.
- b. Set the VBW \geq 3 x RBW.
- c. Detector = Peak.
- d. Trace mode = max hold.
- e. Measure the maximum width of the emission that is 26 dB down from the peak of the emission. Compare this with the RBW setting of the analyzer. Readjust RBW and repeat measurement as needed until the RBW/EBW ratio is approximately 1 %.

4.3.5 Deviation from Test Standard

No deviation.

4.3.6 EUT Operating Conditions

The software provided by client to enable the EUT under transmission condition continuously at lowest, middle and highest channel frequencies individually.

4.3.7 Test Results

Power Output:
Mode A
802.11a

Channel	Frequency (MHz)	Maximum Conducted Power (dBm)		Total Power (mW)	Total Power (dBm)	Power Limit (dBm)	Pass / Fail
		Chain 0	Chain 1				
36	5180	13.87	13.94	49.152	16.92	24	Pass
40	5200	13.71	13.92	48.157	16.83	24	Pass
48	5240	13.89	13.98	49.494	16.95	24	Pass
52	5260	13.81	13.93	48.761	16.88	24	Pass
60	5300	13.82	13.95	48.93	16.90	24	Pass
64	5320	13.86	13.97	49.268	16.93	24	Pass
100	5500	13.76	13.99	48.829	16.89	24	Pass
116	5580	13.78	13.93	48.595	16.87	24	Pass
140	5700	13.75	13.97	48.66	16.87	24	Pass
144	5720 (U-NII-2C)	11.35	11.28	29.584	14.71	22.92	Pass
144	5720 (U-NII-3)	5.24	5.50	7.529	8.77	30	Pass
149	5745	13.69	13.96	48.277	16.84	30	Pass
157	5785	13.82	13.91	48.703	16.88	30	Pass
165	5825	13.89	13.93	49.208	16.92	30	Pass

Note:
For U-NII-2A, U-NII-2C Band:
Chain 0

1. $11 \text{ dBm} + 10\log(21.59) = 24.34 \text{ dBm} > 24 \text{ dBm}$.
2. $11 \text{ dBm} + 10\log(21.62) = 24.35 \text{ dBm} > 24 \text{ dBm}$.
3. $11 \text{ dBm} + 10\log(21.79) = 24.38 \text{ dBm} > 24 \text{ dBm}$.
4. $11 \text{ dBm} + 10\log(21.37) = 24.30 \text{ dBm} > 24 \text{ dBm}$.
5. $11 \text{ dBm} + 10\log(21.72) = 24.37 \text{ dBm} > 24 \text{ dBm}$.
6. $11 \text{ dBm} + 10\log(21.72) = 24.37 \text{ dBm} > 24 \text{ dBm}$.
7. $11 \text{ dBm} + 10\log(15.72) = 22.96 \text{ dBm} < 24 \text{ dBm}$.

Chain 1

1. $11 \text{ dBm} + 10\log(21.49) = 24.32 \text{ dBm} > 24 \text{ dBm}$.
2. $11 \text{ dBm} + 10\log(21.60) = 24.34 \text{ dBm} > 24 \text{ dBm}$.
3. $11 \text{ dBm} + 10\log(21.73) = 24.37 \text{ dBm} > 24 \text{ dBm}$.
4. $11 \text{ dBm} + 10\log(21.54) = 24.33 \text{ dBm} > 24 \text{ dBm}$.
5. $11 \text{ dBm} + 10\log(21.50) = 24.32 \text{ dBm} > 24 \text{ dBm}$.
6. $11 \text{ dBm} + 10\log(21.86) = 24.40 \text{ dBm} > 24 \text{ dBm}$.
7. $11 \text{ dBm} + 10\log(15.55) = 22.92 \text{ dBm} < 24 \text{ dBm}$.

Spectrum Plot of Worst Value

5720 MHz (U-NII-2C)

Chain 0

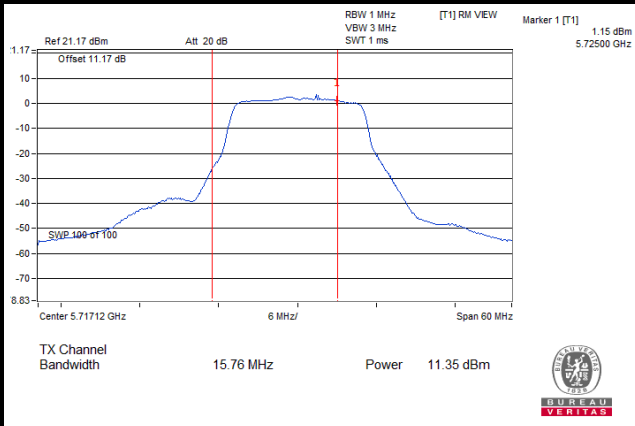

Chain 1

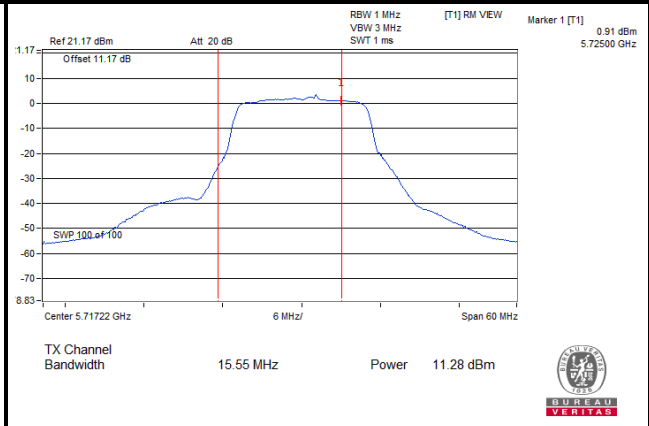

5720 MHz (U-NII-3)

Chain 0

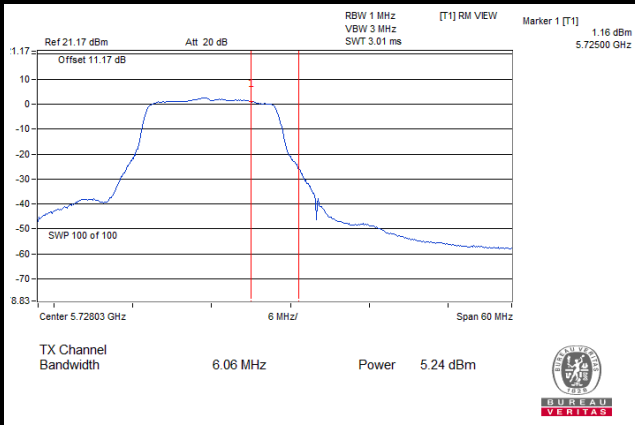

Chain 1

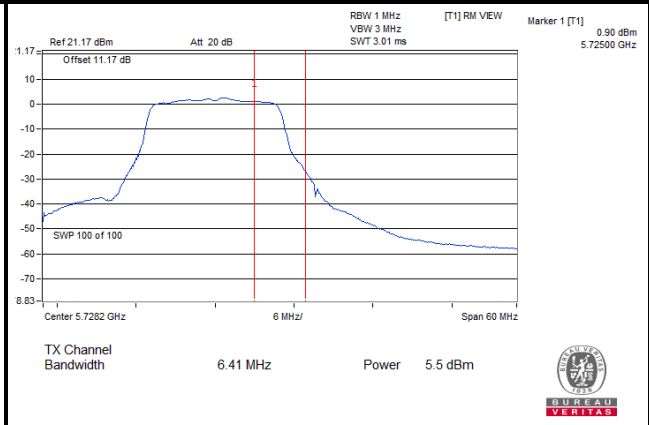

802.11ac (VHT20)

Channel	Frequency (MHz)	Maximum Conducted Power (dBm)		Total Power (mW)	Total Power (dBm)	Power Limit (dBm)	Pass / Fail
		Chain 0	Chain 1				
36	5180	12.82	12.98	39.004	15.91	24	Pass
40	5200	12.68	12.96	38.305	15.83	24	Pass
48	5240	12.92	12.98	39.449	15.96	24	Pass
52	5260	12.55	12.89	37.442	15.73	24	Pass
60	5300	12.52	12.92	37.453	15.73	24	Pass
64	5320	12.54	12.96	37.717	15.77	24	Pass
100	5500	12.68	12.99	38.442	15.85	24	Pass
116	5580	12.52	12.95	37.589	15.75	24	Pass
140	5700	12.72	12.87	38.071	15.81	24	Pass
144	5720 (U-NII-2C)	11.67	10.95	29.724	14.73	23.05	Pass
144	5720 (U-NII-3)	5.74	3.43	6.521	8.14	30	Pass
149	5745	12.61	12.93	37.873	15.78	30	Pass
157	5785	12.65	12.89	37.861	15.78	30	Pass
165	5825	12.69	12.86	37.898	15.79	30	Pass

Note:

For U-NII-2A, U-NII-2C Band:

Chain 0

1. $11 \text{ dBm} + 10\log (22.28) = 24.48 \text{ dBm} > 24 \text{ dBm}$.
2. $11 \text{ dBm} + 10\log (22.58) = 24.54 \text{ dBm} > 24 \text{ dBm}$.
3. $11 \text{ dBm} + 10\log (22.17) = 24.46 \text{ dBm} > 24 \text{ dBm}$.
4. $11 \text{ dBm} + 10\log (22.26) = 24.48 \text{ dBm} > 24 \text{ dBm}$.
5. $11 \text{ dBm} + 10\log (22.19) = 24.46 \text{ dBm} > 24 \text{ dBm}$.
6. $11 \text{ dBm} + 10\log (22.63) = 24.55 \text{ dBm} > 24 \text{ dBm}$.
7. $11 \text{ dBm} + 10\log (16.30) = 23.12 \text{ dBm} < 24 \text{ dBm}$.

Chain 1

1. $11 \text{ dBm} + 10\log (22.52) = 24.53 \text{ dBm} > 24 \text{ dBm}$.
2. $11 \text{ dBm} + 10\log (22.37) = 24.50 \text{ dBm} > 24 \text{ dBm}$.
3. $11 \text{ dBm} + 10\log (22.72) = 24.56 \text{ dBm} > 24 \text{ dBm}$.
4. $11 \text{ dBm} + 10\log (22.09) = 24.44 \text{ dBm} > 24 \text{ dBm}$.
5. $11 \text{ dBm} + 10\log (22.45) = 24.51 \text{ dBm} > 24 \text{ dBm}$.
6. $11 \text{ dBm} + 10\log (22.46) = 24.51 \text{ dBm} > 24 \text{ dBm}$.
7. $11 \text{ dBm} + 10\log (16.02) = 23.05 \text{ dBm} < 24 \text{ dBm}$.

Spectrum Plot of Worst Value 5720 MHz (U-NII-2C)

Chain 0

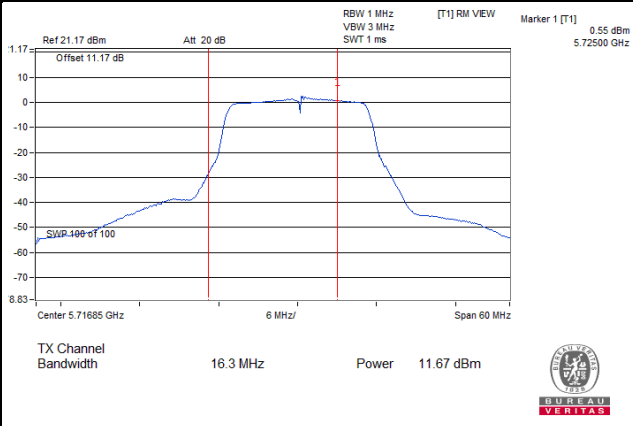

Chain 1

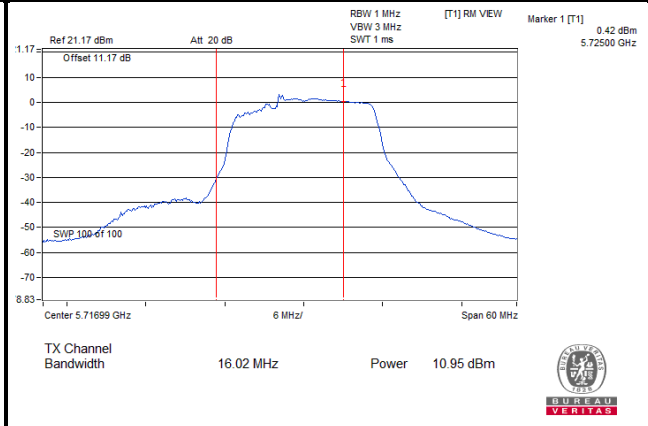

5720 MHz (U-NII-3)

Chain 0

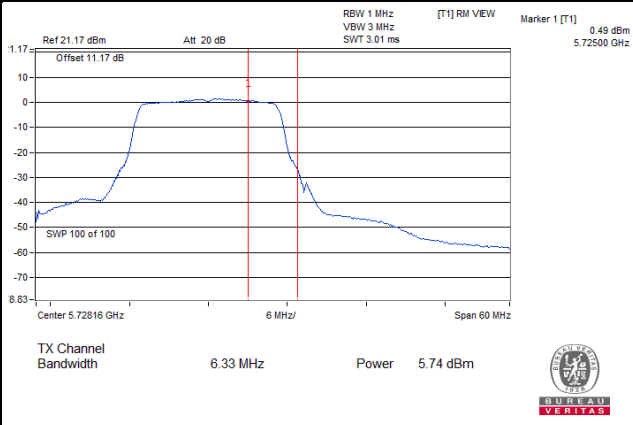

Chain 1

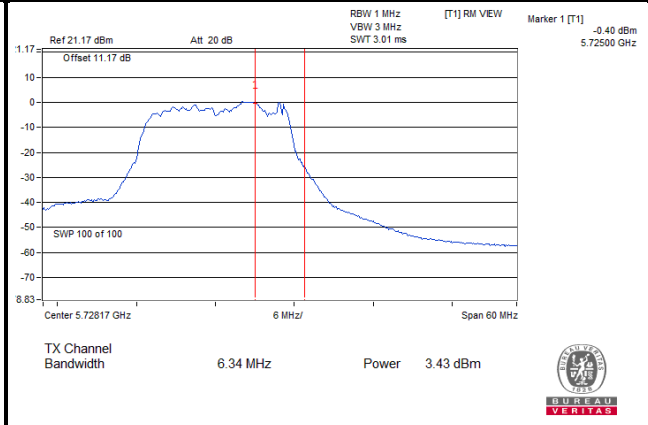

802.11ac (VHT40)

Channel	Frequency (MHz)	Maximum Conducted Power (dBm)		Total Power (mW)	Total Power (dBm)	Power Limit (dBm)	Pass / Fail
		Chain 0	Chain 1				
38	5190	10.11	10.29	20.947	13.21	24	Pass
46	5230	11.73	11.84	30.169	14.80	24	Pass
54	5270	11.57	11.74	29.283	14.67	24	Pass
62	5310	11.61	11.73	29.381	14.68	24	Pass
102	5510	9.79	10.13	19.832	12.97	24	Pass
110	5550	12.05	11.87	31.414	14.97	24	Pass
134	5670	11.88	11.56	29.739	14.73	24	Pass
142	5710 (U-NII-2C)	9.16	9.22	19.935	13.00	24	Pass
142	5710 (U-NII-3)	0.56	0.61	2.749	4.39	30	Pass
151	5755	11.81	11.53	29.394	14.68	30	Pass
159	5795	11.86	11.73	30.24	14.81	30	Pass

Note:

For U-NII-2A, U-NII-2C Band:

Chain 0

1. $11 \text{ dBm} + 10\log (42.40) = 27.27 \text{ dBm} > 24 \text{ dBm}$.
2. $11 \text{ dBm} + 10\log (42.24) = 27.26 \text{ dBm} > 24 \text{ dBm}$.
3. $11 \text{ dBm} + 10\log (42.24) = 27.26 \text{ dBm} > 24 \text{ dBm}$.
4. $11 \text{ dBm} + 10\log (42.28) = 27.26 \text{ dBm} > 24 \text{ dBm}$.
5. $11 \text{ dBm} + 10\log (42.37) = 27.27 \text{ dBm} > 24 \text{ dBm}$.
6. $11 \text{ dBm} + 10\log (36.10) = 26.58 \text{ dBm} > 24 \text{ dBm}$.

Chain 1

1. $11 \text{ dBm} + 10\log (42.60) = 27.29 \text{ dBm} > 24 \text{ dBm}$.
2. $11 \text{ dBm} + 10\log (42.40) = 27.27 \text{ dBm} > 24 \text{ dBm}$.
3. $11 \text{ dBm} + 10\log (42.46) = 27.28 \text{ dBm} > 24 \text{ dBm}$.
4. $11 \text{ dBm} + 10\log (42.71) = 27.31 \text{ dBm} > 24 \text{ dBm}$.
5. $11 \text{ dBm} + 10\log (42.75) = 27.31 \text{ dBm} > 24 \text{ dBm}$.
6. $11 \text{ dBm} + 10\log (36.26) = 26.59 \text{ dBm} > 24 \text{ dBm}$.

Spectrum Plot of Worst Value

5710 MHz (U-NII-2C)

Chain 0

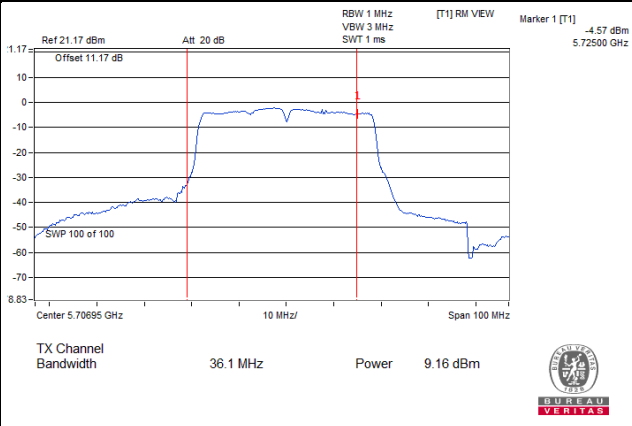

Chain 1

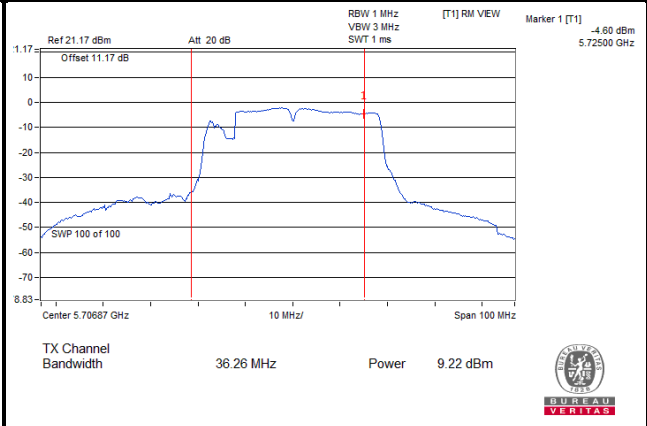

5710 MHz (U-NII-3)

Chain 0

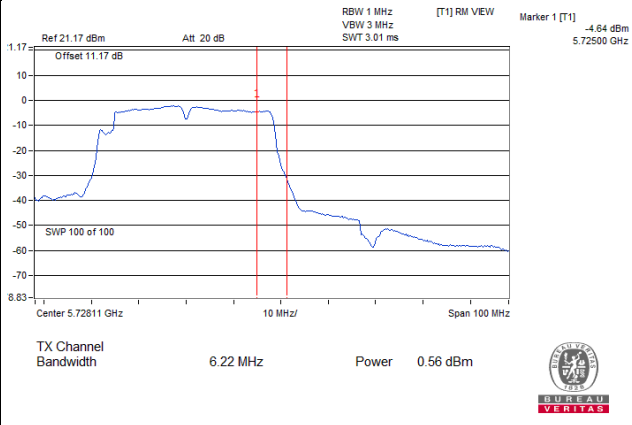

Chain 1

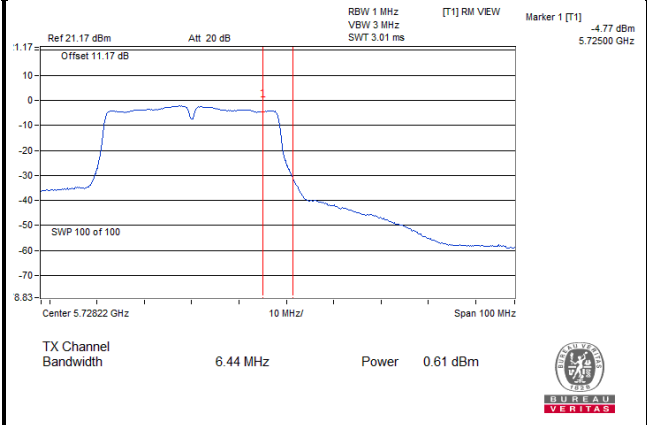

802.11ac (VHT80)

Channel	Frequency (MHz)	Maximum Conducted Power (dBm)		Total Power (mW)	Total Power (dBm)	Power Limit (dBm)	Pass / Fail
		Chain 0	Chain 1				
42	5210	9.32	9.41	17.28	12.38	24	Pass
58	5290	10.72	10.89	24.078	13.82	24	Pass
106	5530	10.53	10.55	22.648	13.55	24	Pass
122	5610	10.89	10.86	24.464	13.89	24	Pass
138	5690 (U-NII-2C)	8.86	8.43	21.631	13.35	24	Pass
138	5690 (U-NII-3)	-4.72	-4.46	1.0262	0.11	30	Pass
155	5775	10.87	10.53	23.516	13.71	30	Pass

Note:

For U-NII-2A, U-NII-2C Band:

Chain 0

1. $11 \text{ dBm} + 10\log(82.77) = 30.18 \text{ dBm} > 24 \text{ dBm}$.
2. $11 \text{ dBm} + 10\log(82.27) = 30.15 \text{ dBm} > 24 \text{ dBm}$.
3. $11 \text{ dBm} + 10\log(82.35) = 30.16 \text{ dBm} > 24 \text{ dBm}$.
4. $11 \text{ dBm} + 10\log(76.29) = 29.82 \text{ dBm} > 24 \text{ dBm}$.

Chain 1

1. $11 \text{ dBm} + 10\log(82.07) = 30.14 \text{ dBm} > 24 \text{ dBm}$.
2. $11 \text{ dBm} + 10\log(82.88) = 30.18 \text{ dBm} > 24 \text{ dBm}$.
3. $11 \text{ dBm} + 10\log(81.77) = 30.13 \text{ dBm} > 24 \text{ dBm}$.
4. $11 \text{ dBm} + 10\log(75.99) = 29.81 \text{ dBm} > 24 \text{ dBm}$.

Spectrum Plot of Worst Value

5690 MHz (U-NII-2C)

Chain 0

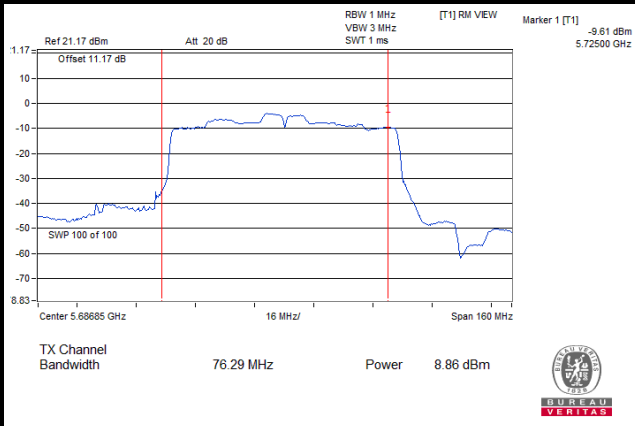

Chain 1

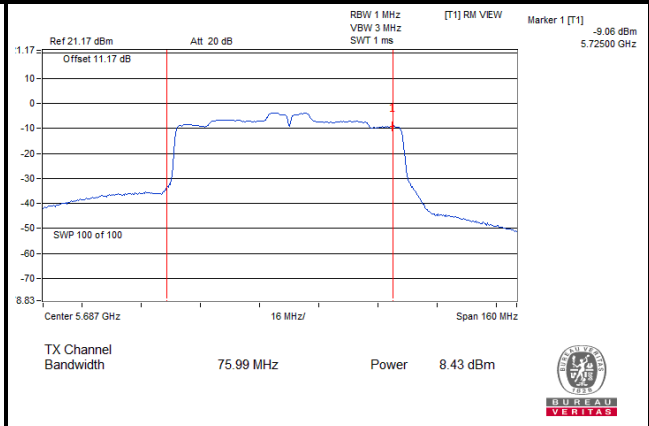

5690 MHz (U-NII-3)

Chain 0

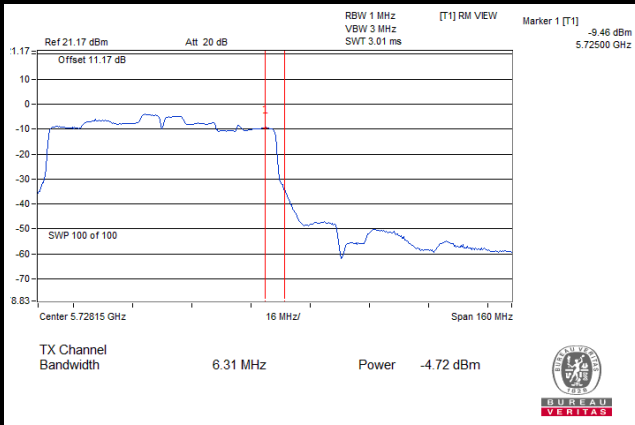

Chain 1

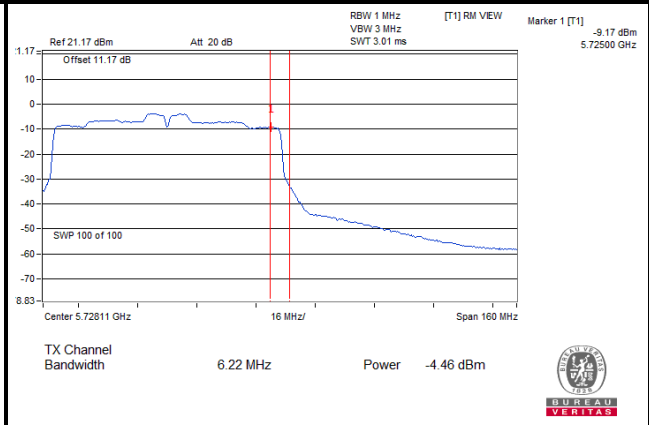

Mode B
802.11a

Channel	Frequency (MHz)	Maximum Conducted Power (dBm)		Total Power (mW)	Total Power (dBm)	Power Limit (dBm)	Pass / Fail
		Chain 0	Chain 1				
36	5180	13.87	13.94	49.152	16.92	24	Pass
40	5200	13.71	13.92	48.157	16.83	24	Pass
48	5240	13.89	13.98	49.494	16.95	24	Pass
52	5260	13.81	13.93	48.761	16.88	24	Pass
60	5300	13.82	13.95	48.93	16.90	24	Pass
64	5320	13.86	13.97	49.268	16.93	24	Pass
100	5500	13.76	13.99	48.829	16.89	24	Pass
116	5580	13.78	13.93	48.595	16.87	24	Pass
140	5700	13.75	13.97	48.66	16.87	24	Pass
144	5720 (U-NII-2C)	11.35	11.28	29.584	14.71	22.92	Pass
144	5720 (U-NII-3)	5.24	5.50	7.529	8.77	30	Pass
149	5745	13.69	13.96	48.277	16.84	30	Pass
157	5785	13.82	13.91	48.703	16.88	30	Pass
165	5825	13.89	13.93	49.208	16.92	30	Pass

Note:
For U-NII-2A, U-NII-2C Band:
Chain 0

1. $11 \text{ dBm} + 10\log(21.59) = 24.34 \text{ dBm} > 24 \text{ dBm}$.
2. $11 \text{ dBm} + 10\log(21.62) = 24.35 \text{ dBm} > 24 \text{ dBm}$.
3. $11 \text{ dBm} + 10\log(21.79) = 24.38 \text{ dBm} > 24 \text{ dBm}$.
4. $11 \text{ dBm} + 10\log(21.37) = 24.30 \text{ dBm} > 24 \text{ dBm}$.
5. $11 \text{ dBm} + 10\log(21.72) = 24.37 \text{ dBm} > 24 \text{ dBm}$.
6. $11 \text{ dBm} + 10\log(21.72) = 24.37 \text{ dBm} > 24 \text{ dBm}$.
7. $11 \text{ dBm} + 10\log(15.72) = 22.96 \text{ dBm} < 24 \text{ dBm}$.

Chain 1

1. $11 \text{ dBm} + 10\log(21.49) = 24.32 \text{ dBm} > 24 \text{ dBm}$.
2. $11 \text{ dBm} + 10\log(21.60) = 24.34 \text{ dBm} > 24 \text{ dBm}$.
3. $11 \text{ dBm} + 10\log(21.73) = 24.37 \text{ dBm} > 24 \text{ dBm}$.
4. $11 \text{ dBm} + 10\log(21.54) = 24.33 \text{ dBm} > 24 \text{ dBm}$.
5. $11 \text{ dBm} + 10\log(21.50) = 24.32 \text{ dBm} > 24 \text{ dBm}$.
6. $11 \text{ dBm} + 10\log(21.86) = 24.40 \text{ dBm} > 24 \text{ dBm}$.
7. $11 \text{ dBm} + 10\log(15.55) = 22.92 \text{ dBm} < 24 \text{ dBm}$.

Spectrum Plot of Worst Value

5720 MHz (U-NII-2C)

Chain 0

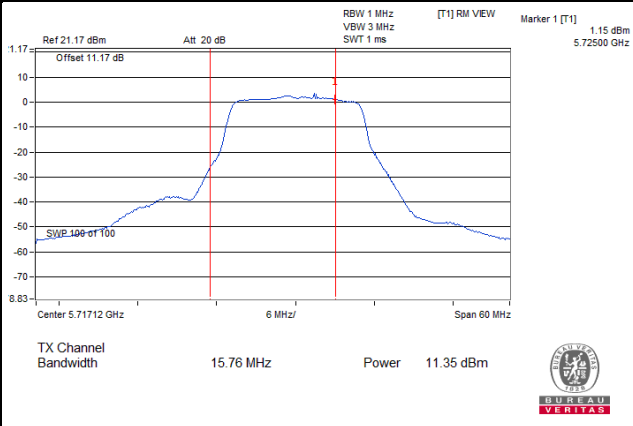

Chain 1

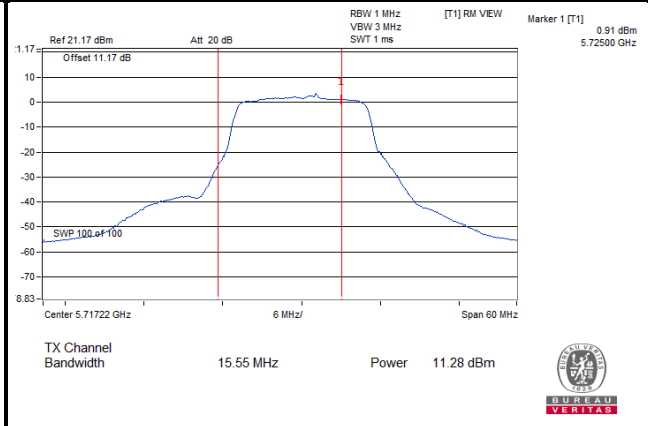

5720 MHz (U-NII-3)

Chain 0

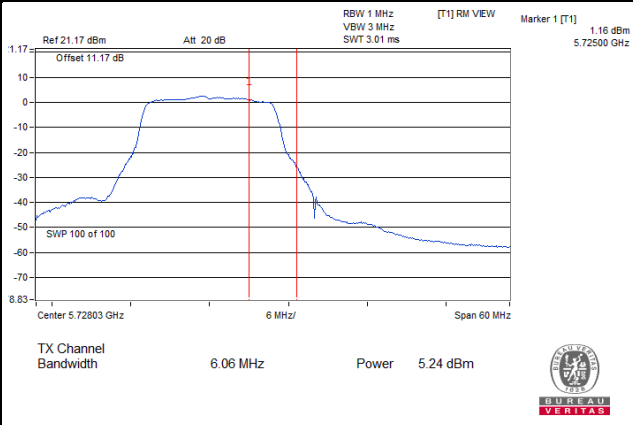

Chain 1

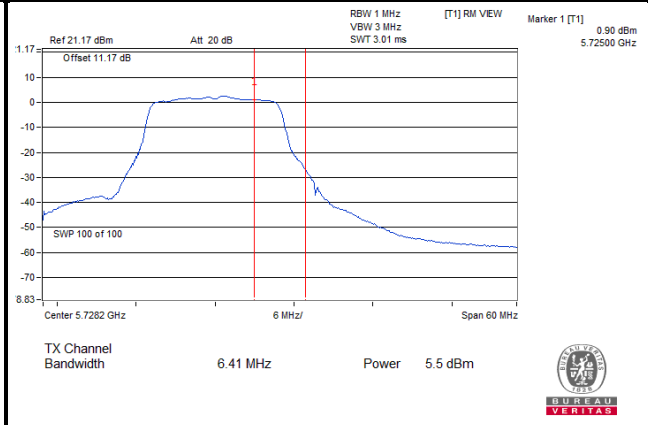

802.11ac (VHT20)

Channel	Frequency (MHz)	Maximum Conducted Power (dBm)		Total Power (mW)	Total Power (dBm)	Power Limit (dBm)	Pass / Fail
		Chain 0	Chain 1				
36	5180	12.82	12.98	39.004	15.91	24	Pass
40	5200	12.68	12.96	38.305	15.83	24	Pass
48	5240	12.92	12.98	39.449	15.96	24	Pass
52	5260	12.55	12.89	37.442	15.73	24	Pass
60	5300	12.52	12.92	37.453	15.73	24	Pass
64	5320	12.54	12.96	37.717	15.77	24	Pass
100	5500	12.68	12.99	38.442	15.85	24	Pass
116	5580	12.52	12.95	37.589	15.75	24	Pass
140	5700	12.72	12.87	38.071	15.81	24	Pass
144	5720 (U-NII-2C)	11.67	10.95	29.724	14.73	23.05	Pass
144	5720 (U-NII-3)	5.74	3.43	6.521	8.14	30	Pass
149	5745	12.61	12.93	37.873	15.78	30	Pass
157	5785	12.65	12.89	37.861	15.78	30	Pass
165	5825	12.69	12.86	37.898	15.79	30	Pass

Note:

For U-NII-2A, U-NII-2C Band:

Chain 0

1. $11 \text{ dBm} + 10\log(22.28) = 24.48 \text{ dBm} > 24 \text{ dBm}$.
2. $11 \text{ dBm} + 10\log(22.58) = 24.54 \text{ dBm} > 24 \text{ dBm}$.
3. $11 \text{ dBm} + 10\log(22.17) = 24.46 \text{ dBm} > 24 \text{ dBm}$.
4. $11 \text{ dBm} + 10\log(22.26) = 24.48 \text{ dBm} > 24 \text{ dBm}$.
5. $11 \text{ dBm} + 10\log(22.19) = 24.46 \text{ dBm} > 24 \text{ dBm}$.
6. $11 \text{ dBm} + 10\log(22.63) = 24.55 \text{ dBm} > 24 \text{ dBm}$.
7. $11 \text{ dBm} + 10\log(16.30) = 23.12 \text{ dBm} < 24 \text{ dBm}$.

Chain 1

1. $11 \text{ dBm} + 10\log(22.52) = 24.53 \text{ dBm} > 24 \text{ dBm}$.
2. $11 \text{ dBm} + 10\log(22.37) = 24.50 \text{ dBm} > 24 \text{ dBm}$.
3. $11 \text{ dBm} + 10\log(22.72) = 24.56 \text{ dBm} > 24 \text{ dBm}$.
4. $11 \text{ dBm} + 10\log(22.09) = 24.44 \text{ dBm} > 24 \text{ dBm}$.
5. $11 \text{ dBm} + 10\log(22.45) = 24.51 \text{ dBm} > 24 \text{ dBm}$.
6. $11 \text{ dBm} + 10\log(22.46) = 24.51 \text{ dBm} > 24 \text{ dBm}$.
7. $11 \text{ dBm} + 10\log(16.02) = 23.05 \text{ dBm} < 24 \text{ dBm}$.

Spectrum Plot of Worst Value 5720 MHz (U-NII-2C)

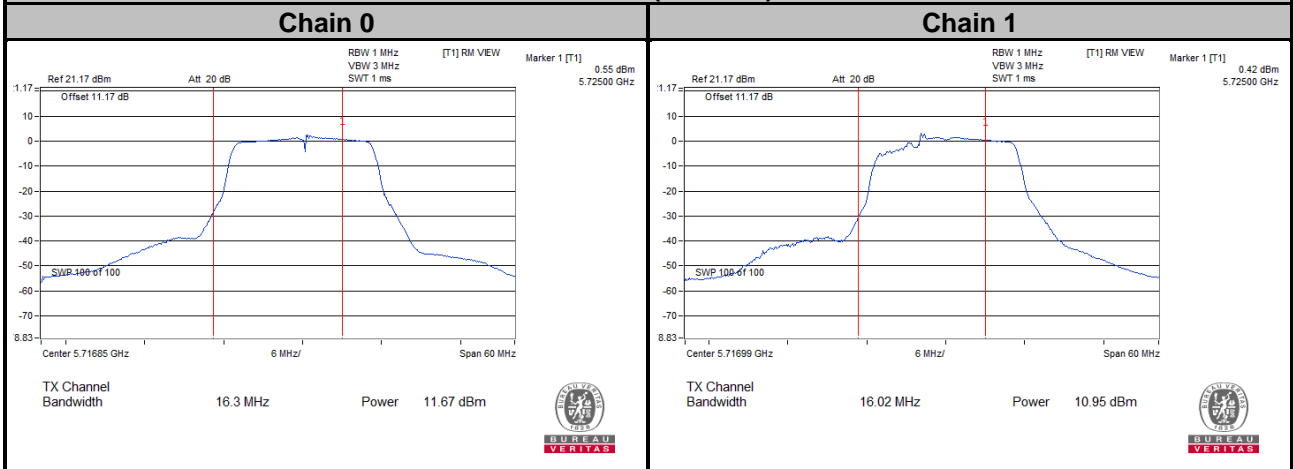

5720 MHz (U-NII-3)

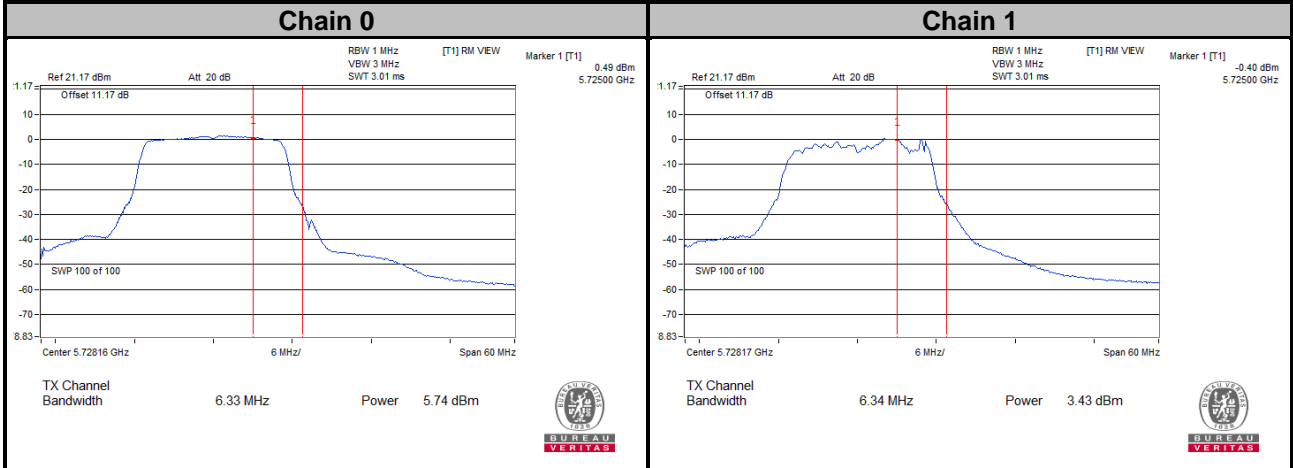

802.11ac (VHT40)

Channel	Frequency (MHz)	Maximum Conducted Power (dBm)		Total Power (mW)	Total Power (dBm)	Power Limit (dBm)	Pass / Fail
		Chain 0	Chain 1				
38	5190	10.56	10.73	23.207	13.66	24	Pass
46	5230	11.73	11.84	30.169	14.80	24	Pass
54	5270	11.57	11.74	29.283	14.67	24	Pass
62	5310	11.61	11.73	29.381	14.68	24	Pass
102	5510	10.54	10.50	22.544	13.53	24	Pass
110	5550	11.98	11.87	31.158	14.94	24	Pass
134	5670	11.88	11.56	29.739	14.73	24	Pass
142	5710 (U-NII-2C)	9.16	9.22	19.935	13.00	24	Pass
142	5710 (U-NII-3)	0.56	0.61	2.749	4.39	30	Pass
151	5755	11.81	11.53	29.394	14.68	30	Pass
159	5795	11.86	11.73	30.24	14.81	30	Pass

Note:

For U-NII-2A, U-NII-2C Band:

Chain 0

1. $11 \text{ dBm} + 10\log (42.40) = 27.27 \text{ dBm} > 24 \text{ dBm}$.
2. $11 \text{ dBm} + 10\log (42.24) = 27.26 \text{ dBm} > 24 \text{ dBm}$.
3. $11 \text{ dBm} + 10\log (42.24) = 27.26 \text{ dBm} > 24 \text{ dBm}$.
4. $11 \text{ dBm} + 10\log (42.28) = 27.26 \text{ dBm} > 24 \text{ dBm}$.
5. $11 \text{ dBm} + 10\log (42.37) = 27.27 \text{ dBm} > 24 \text{ dBm}$.
6. $11 \text{ dBm} + 10\log (36.10) = 26.58 \text{ dBm} > 24 \text{ dBm}$.

Chain 1

1. $11 \text{ dBm} + 10\log (42.60) = 27.29 \text{ dBm} > 24 \text{ dBm}$.
2. $11 \text{ dBm} + 10\log (42.40) = 27.27 \text{ dBm} > 24 \text{ dBm}$.
3. $11 \text{ dBm} + 10\log (42.46) = 27.28 \text{ dBm} > 24 \text{ dBm}$.
4. $11 \text{ dBm} + 10\log (42.71) = 27.31 \text{ dBm} > 24 \text{ dBm}$.
5. $11 \text{ dBm} + 10\log (42.75) = 27.31 \text{ dBm} > 24 \text{ dBm}$.
6. $11 \text{ dBm} + 10\log (36.26) = 26.59 \text{ dBm} > 24 \text{ dBm}$.

Spectrum Plot of Worst Value 5710 MHz (U-NII-2C)

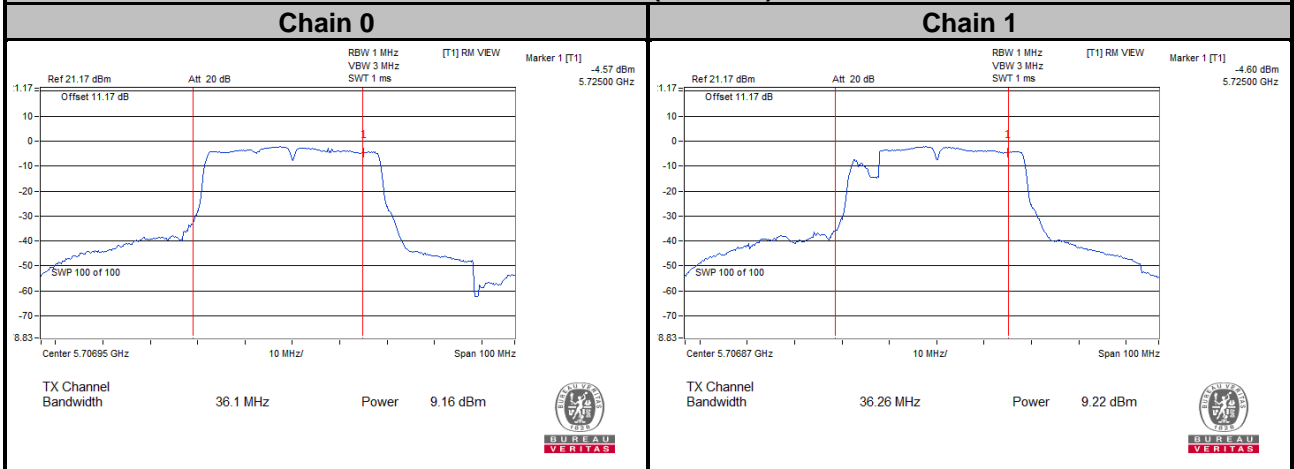

5710 MHz (U-NII-3)

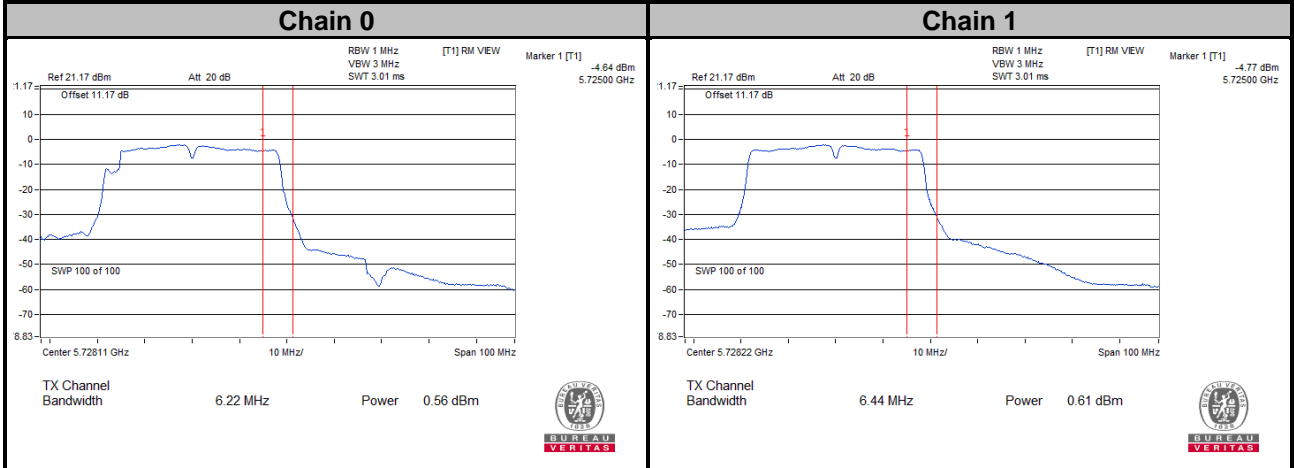

802.11ac (VHT80)

Channel	Frequency (MHz)	Maximum Conducted Power (dBm)		Total Power (mW)	Total Power (dBm)	Power Limit (dBm)	Pass / Fail
		Chain 0	Chain 1				
42	5210	9.32	9.41	17.28	12.38	24	Pass
58	5290	10.72	10.89	24.078	13.82	24	Pass
106	5530	9.44	9.49	17.682	12.48	24	Pass
122	5610	10.89	10.86	24.464	13.89	24	Pass
138	5690 (U-NII-2C)	8.86	8.43	21.631	13.35	24	Pass
138	5690 (U-NII-3)	-4.72	-4.46	1.0262	0.11	30	Pass
155	5775	10.87	10.53	23.516	13.71	30	Pass

Note:

For U-NII-2A, U-NII-2C Band:

Chain 0

1. $11 \text{ dBm} + 10\log (82.77) = 30.18 \text{ dBm} > 24 \text{ dBm}$.
2. $11 \text{ dBm} + 10\log (82.27) = 30.15 \text{ dBm} > 24 \text{ dBm}$.
3. $11 \text{ dBm} + 10\log (82.35) = 30.16 \text{ dBm} > 24 \text{ dBm}$.
4. $11 \text{ dBm} + 10\log (76.29) = 29.82 \text{ dBm} > 24 \text{ dBm}$.

Chain 1

1. $11 \text{ dBm} + 10\log (82.07) = 30.14 \text{ dBm} > 24 \text{ dBm}$.
2. $11 \text{ dBm} + 10\log (82.88) = 30.18 \text{ dBm} > 24 \text{ dBm}$.
3. $11 \text{ dBm} + 10\log (81.77) = 30.13 \text{ dBm} > 24 \text{ dBm}$.
4. $11 \text{ dBm} + 10\log (75.99) = 29.81 \text{ dBm} > 24 \text{ dBm}$.

Spectrum Plot of Worst Value

5690 MHz (U-NII-2C)

Chain 0

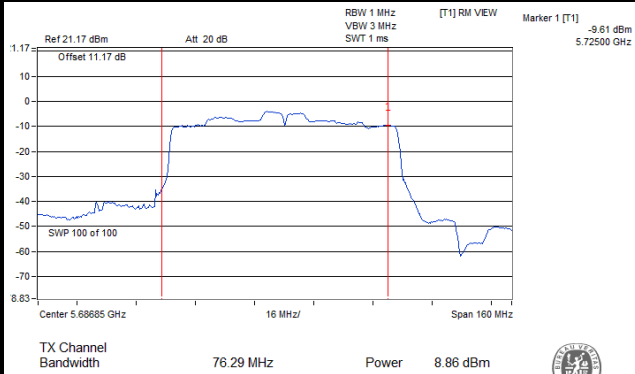

Chain 1

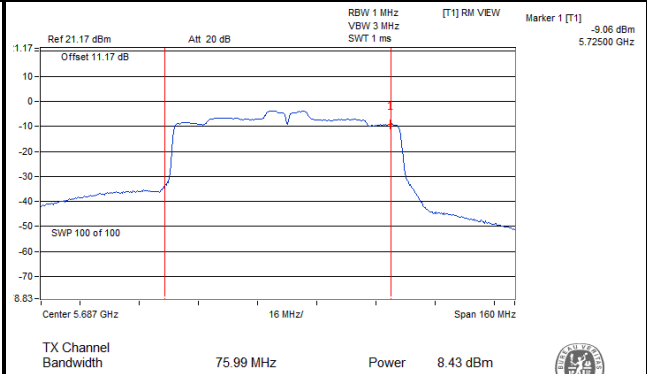

5690 MHz (U-NII-3)

Chain 0

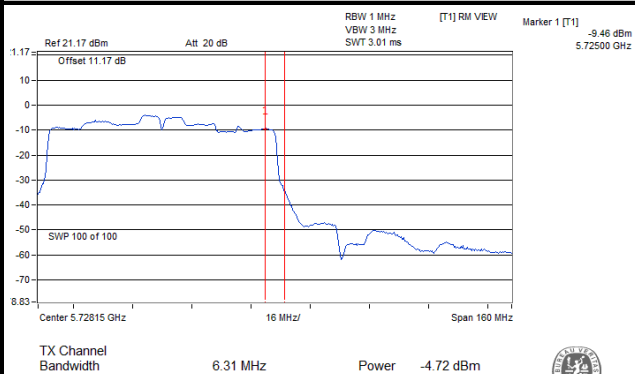

Chain 1

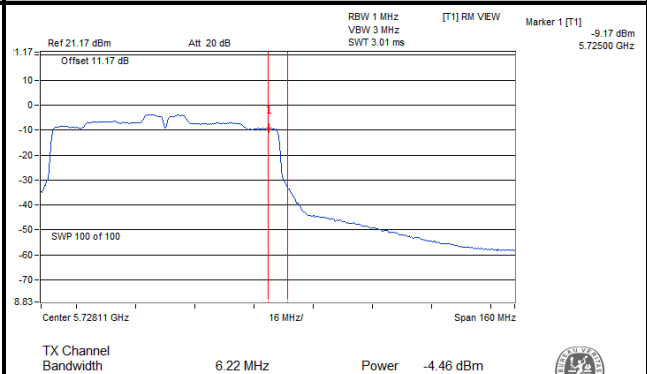

26 dB Bandwidth:
802.11a

Channel	Frequency (MHz)	26 dBc Bandwidth (MHz)	
		Chain 0	Chain 1
36	5180	21.52	21.97
40	5200	21.91	21.59
48	5240	21.96	21.68
52	5260	21.59	21.49
60	5300	21.62	21.60
64	5320	21.79	21.73
100	5500	21.37	21.54
116	5580	21.72	21.50
140	5700	21.72	21.86
144	5720 (U-NII-2C)	15.72	15.55
144	5720 (U-NII-3)	5.99	6.41

802.11ac (VHT20)

Channel	Frequency (MHz)	26 dBc Bandwidth (MHz)	
		Chain 0	Chain 1
36	5180	22.19	22.26
40	5200	22.83	22.23
48	5240	22.24	22.26
52	5260	22.28	22.52
60	5300	22.58	22.37
64	5320	22.17	22.72
100	5500	22.26	22.09
116	5580	22.19	22.45
140	5700	22.63	22.46
144	5720 (U-NII-2C)	16.30	16.02
144	5720 (U-NII-3)	6.33	6.34

802.11ac (VHT40)

Channel	Frequency (MHz)	26 dBc Bandwidth (MHz)	
		Chain 0	Chain 1
38	5190	42.44	42.24
46	5230	42.37	42.72
54	5270	42.40	42.60
62	5310	42.24	42.40
102	5510	42.24	42.46
110	5550	42.28	42.71
134	5670	42.37	42.75
142	5710 (U-NII-2C)	36.10	36.26
142	5710 (U-NII-3)	6.22	6.44

802.11ac (VHT80)

Channel	Frequency (MHz)	26 dBc Bandwidth (MHz)	
		Chain 0	Chain 1
42	5210	82.75	82.41
58	5290	82.77	82.07
106	5530	82.27	82.88
122	5610	82.35	81.77
138	5690 (U-NII-2C)	76.29	75.99
138	5690 (U-NII-3)	6.31	6.22

Spectrum Plot of Worst Value

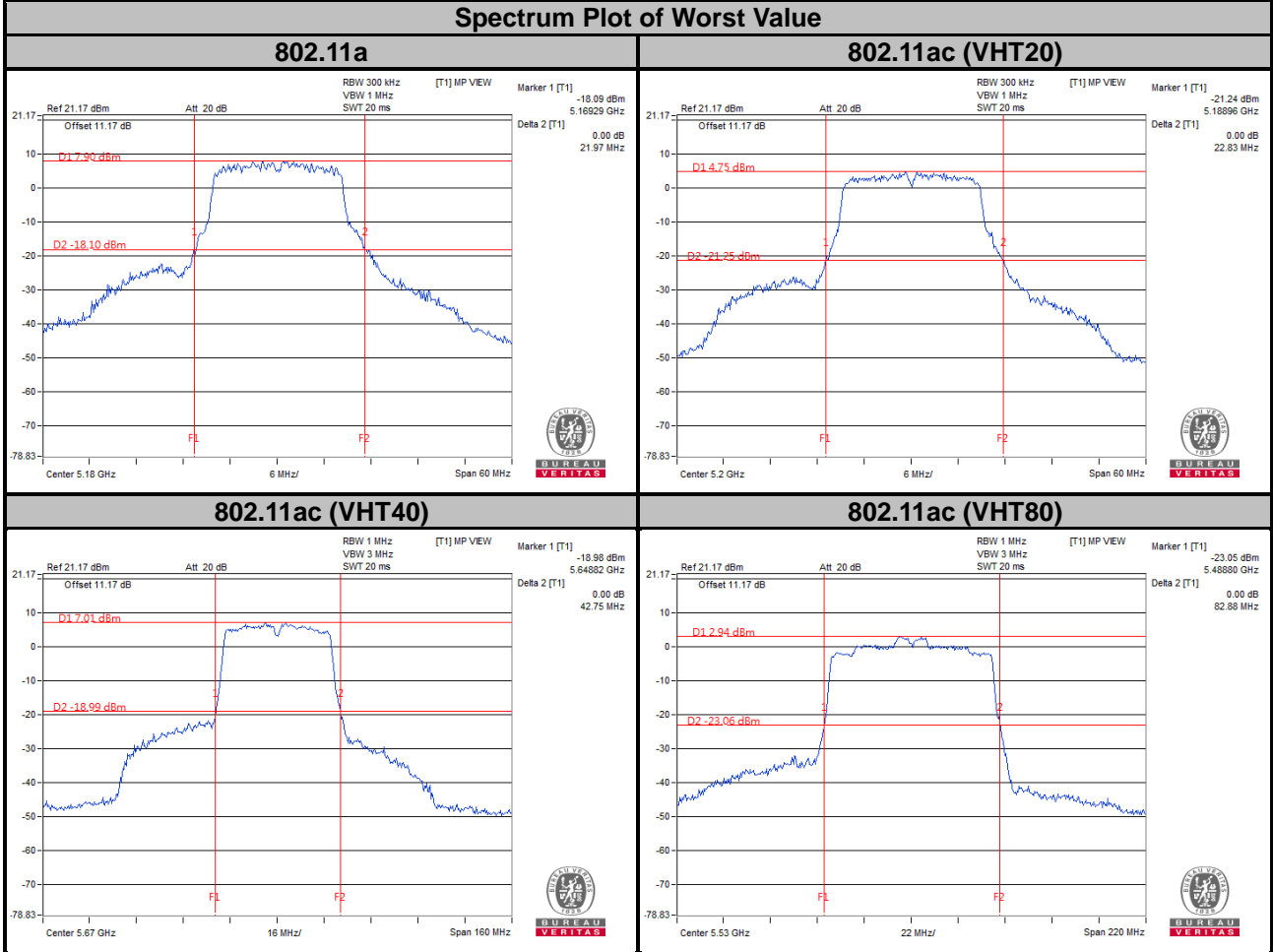

4.4 Occupied Bandwidth Measurement

4.4.1 Test Setup

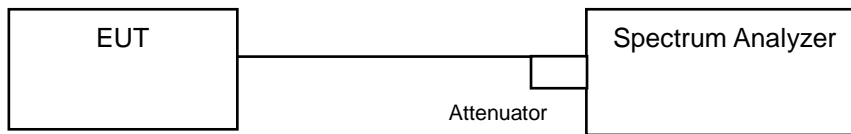

4.4.2 Test Instruments

Refer to section 4.1.2 to get information of above instrument.

4.4.3 Test Procedure

The transmitter output was connected to the spectrum analyzer through an attenuator. The bandwidth of the fundamental frequency was measured by spectrum analyzer with resolution bandwidth in the range of 1 % to 5 % of the anticipated emission bandwidth, and a video bandwidth at least 3x the resolution bandwidth and set the detector to SAMPLE. The width of a frequency band such that, below the lower and above the upper frequency limits, the mean powers emitted are each equal to a specified percentage 0.5 % of the total mean power of a given emission.

4.4.4 Test Results

802.11a

Channel	Channel Frequency (MHz)	Occupied Bandwidth (MHz)	
		Chain 0	Chain 1
36	5180	16.80	16.56
40	5200	16.68	16.68
48	5240	16.56	16.68
52	5260	16.56	16.56
60	5300	16.68	16.56
64	5320	16.56	16.68
100	5500	16.56	16.56
116	5580	16.68	16.56
140	5700	16.68	16.68
144	5720 (U-NII-2C)	13.28	13.28
144	5720 (U-NII-3)	3.16	3.40
149	5745	16.56	16.56
157	5785	16.68	16.56
165	5825	16.68	16.56

802.11ac (VHT20)

Channel	Channel Frequency (MHz)	Occupied Bandwidth (MHz)	
		Chain 0	Chain 1
36	5180	17.64	17.76
40	5200	17.76	17.76
48	5240	17.64	17.76
52	5260	17.64	17.64
60	5300	17.64	17.64
64	5320	17.64	17.76
100	5500	17.64	17.64
116	5580	17.64	17.88
140	5700	17.64	17.76
144	5720 (U-NII-2C)	13.88	13.88
144	5720 (U-NII-3)	3.88	3.76
149	5745	17.76	17.64
157	5785	17.76	17.76
165	5825	17.76	17.64

802.11ac (VHT40)

Channel	Channel Frequency (MHz)	Occupied Bandwidth (MHz)	
		Chain 0	Chain 1
38	5190	36.48	36.72
46	5230	36.48	36.72
54	5270	36.24	36.72
62	5310	36.72	36.72
102	5510	36.72	36.72
110	5550	36.72	36.48
134	5670	36.48	36.72
142	5710 (U-NII-2C)	33.24	33.24
142	5710 (U-NII-3)	3.24	3.24
151	5755	36.48	36.24
159	5795	36.72	36.48

802.11ac (VHT80)

Channel	Channel Frequency (MHz)	Occupied Bandwidth (MHz)	
		Chain 0	Chain 1
42	5210	75.36	75.36
58	5290	75.84	75.84
106	5530	75.36	75.36
122	5610	75.36	75.36
138	5690 (U-NII-2C)	72.92	72.92
138	5690 (U-NII-3)	2.44	2.44
155	5775	75.36	75.36

Spectrum Plot of Worst Value

802.11a

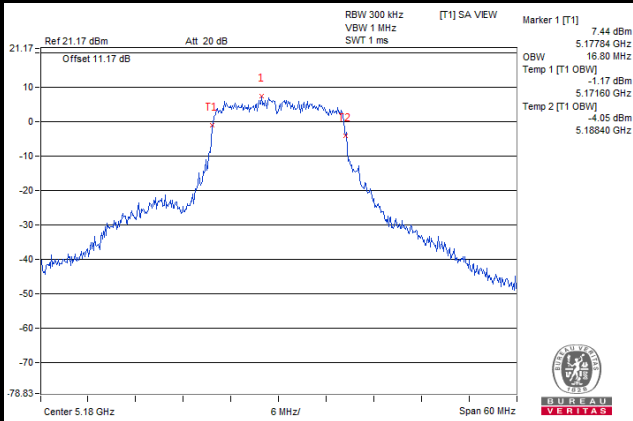

802.11ac (VHT20)

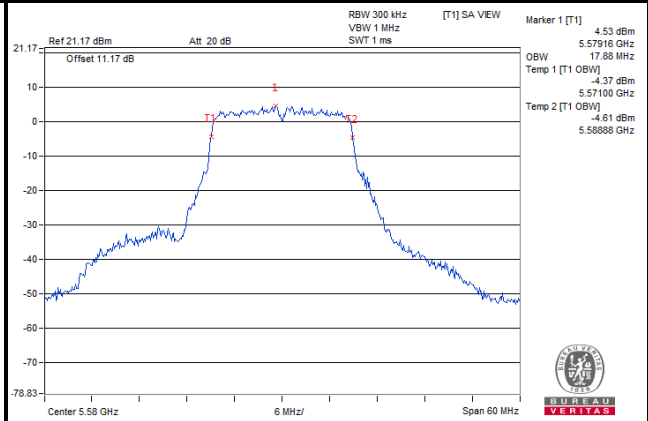

802.11ac (VHT40)

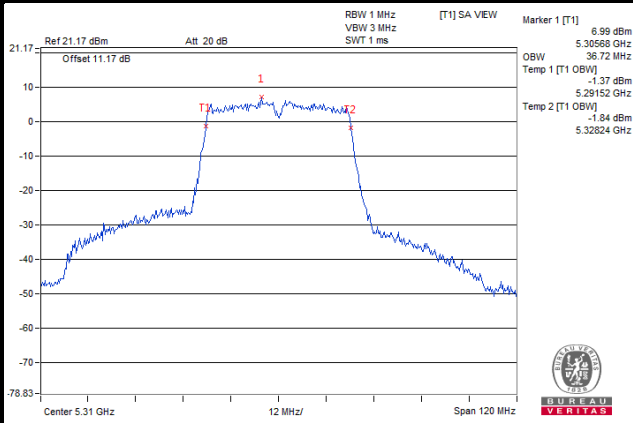

802.11ac (VHT80)

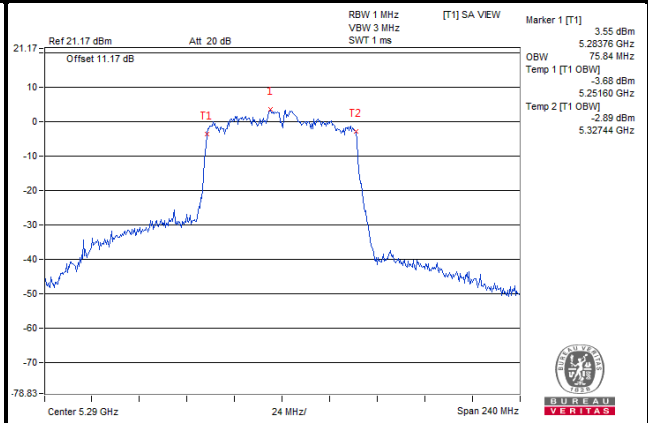

Chain 0

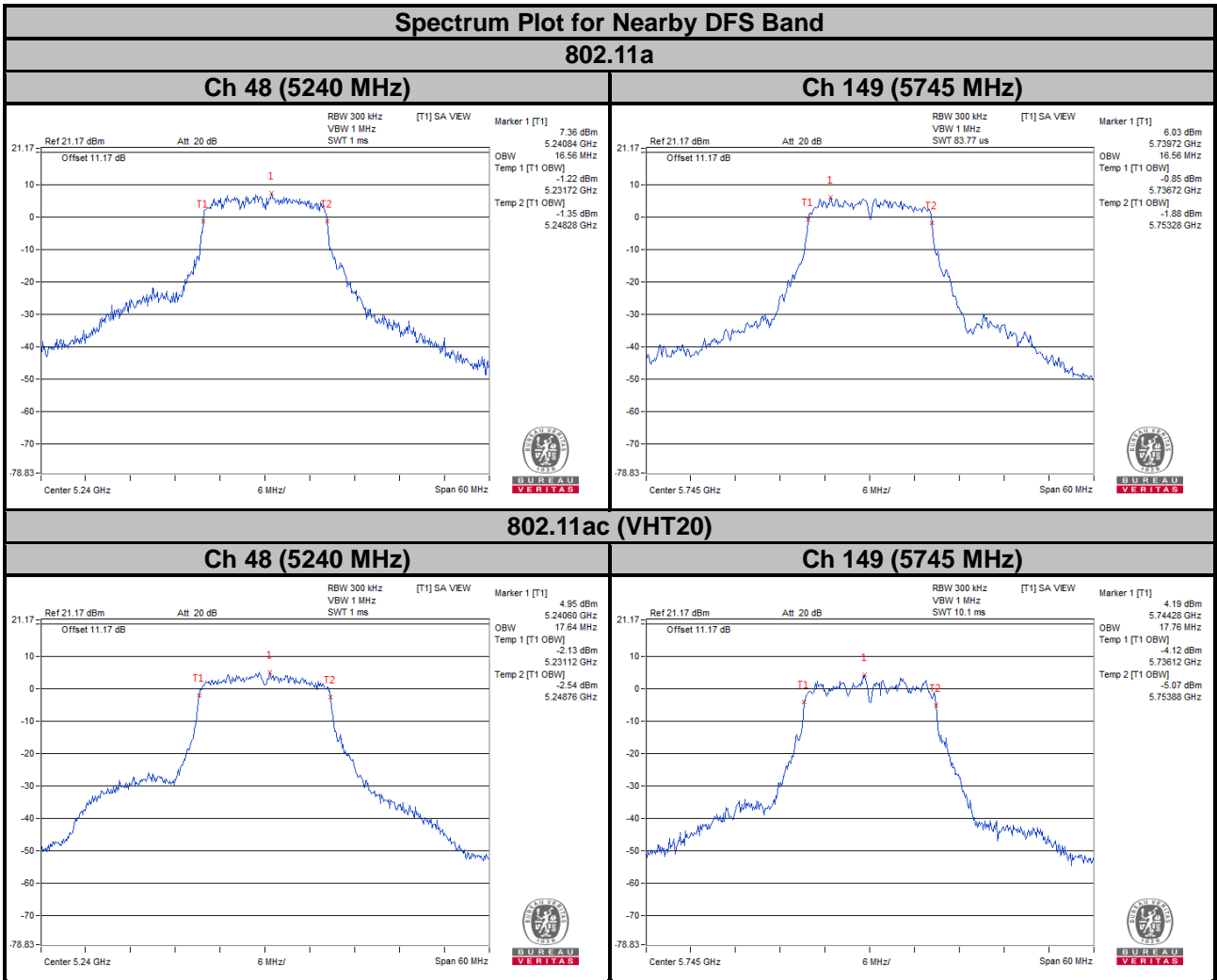

802.11ac (VHT40)

Ch 46 (5230 MHz)

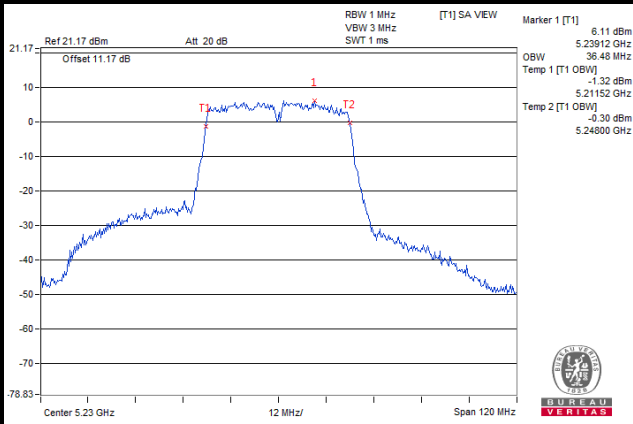

Ch 151 (5755 MHz)

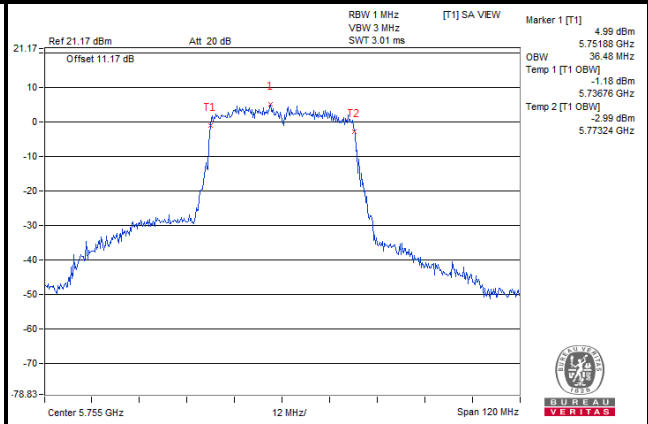

802.11ac (VHT80)

Ch 42 (5210 MHz)

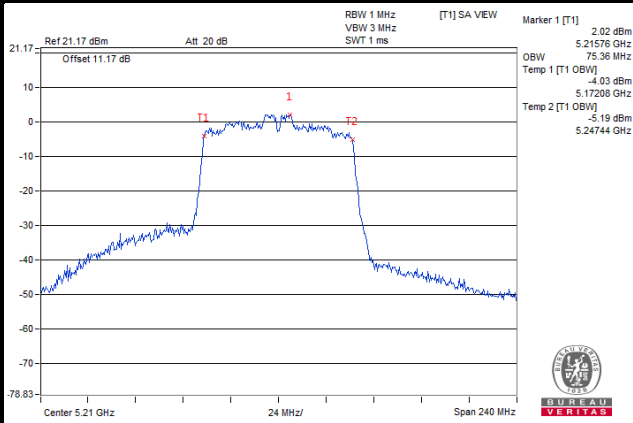

Ch 155 (5775 MHz)

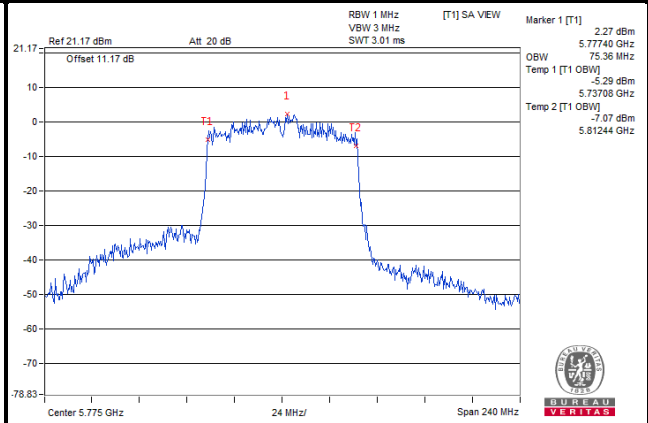

Chain 1

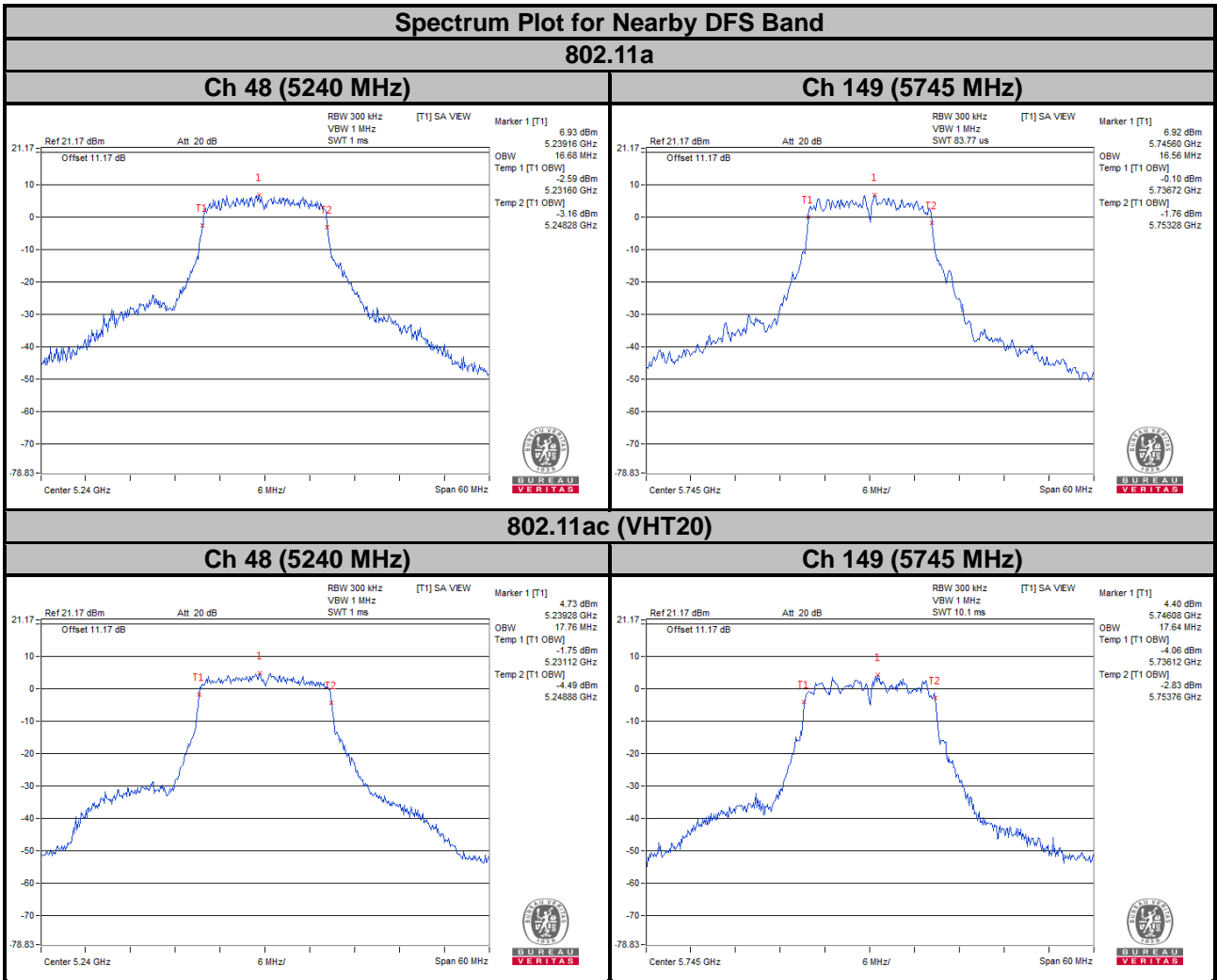

802.11ac (VHT40)

Ch 46 (5230 MHz)

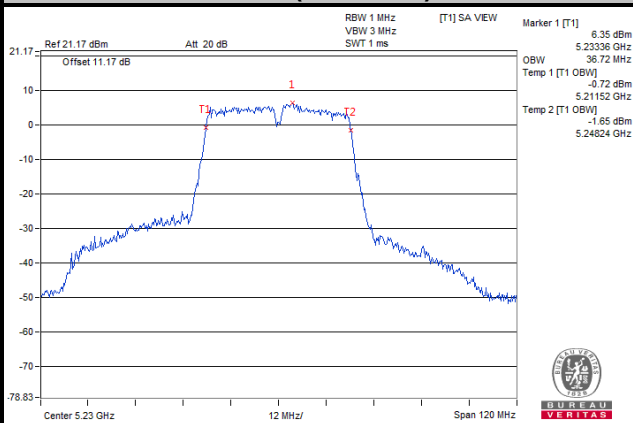

Ch 151 (5755 MHz)

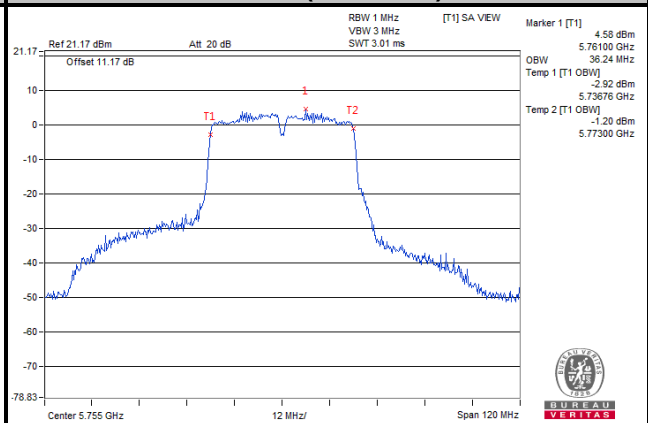

802.11ac (VHT80)

Ch 42 (5210 MHz)

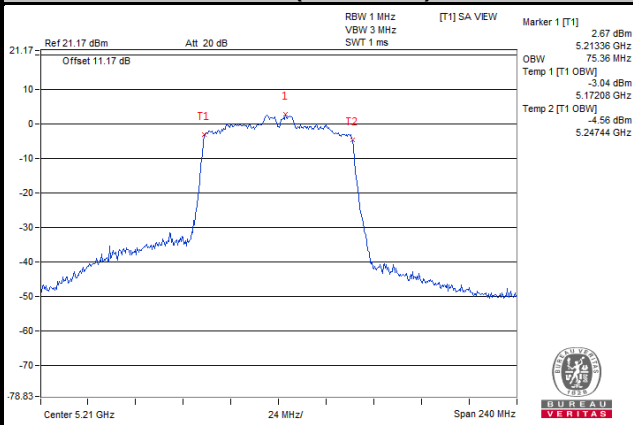

Ch 155 (5775 MHz)

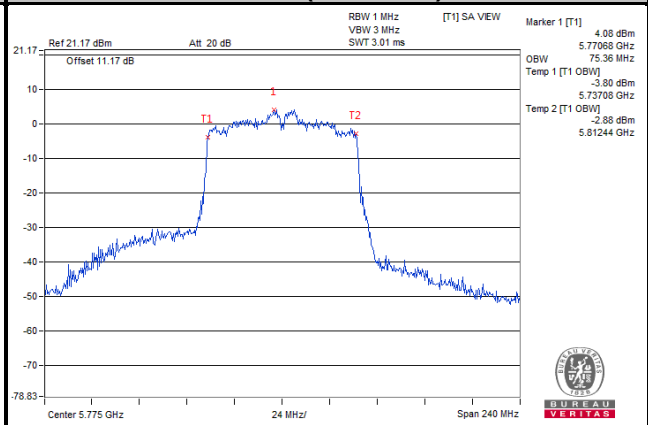

4.5 Peak Power Spectral Density Measurement

4.5.1 Limits of Peak Power Spectral Density Measurement

Operation Band	EUT Category		Limit
U-NII-1		Outdoor Access Point	17 dBm/MHz
		Fixed point-to-point Access Point	
		Indoor Access Point	
	√	Mobile and Portable client device	11 dBm/MHz
U-NII-2A		√	11 dBm/MHz
U-NII-2C		√	11 dBm/MHz
U-NII-3		√	30 dBm/500 kHz

4.5.2 Test Setup

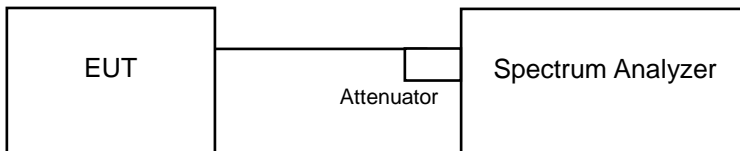

4.5.3 Test Instruments

Refer to section 4.1.2 to get information of above instrument.

4.5.4 Test Procedures

For U-NII-1, U-NII-2A, U-NII-2C band:

Using method SA-2

1. Set span to encompass the entire emission bandwidth (EBW) of the signal.
2. Set RBW = 1 MHz, Set VBW \geq 3 RBW, Detector = RMS
3. Sweep time = auto, trigger set to "free run".
4. Trace average at least 100 traces in power averaging mode.
5. Record the max value and add $10 \log(1/\text{duty cycle})$

※ For U-NII-3:

1. Set span to encompass the entire emission bandwidth (EBW) of the signal.
2. Set RBW = 300 kHz, Set VBW \geq 1 RBW, Detector = RMS
3. Use the peak marker function to determine the maximum power level in any 300 kHz band segment within the fundamental EBW.
4. Scale the observed power level to an equivalent value in 500 kHz by adjusting (raising) the measured power by a bandwidth correction factor (BWCF) where $BWCF = 10\log(500 \text{ kHz} / 300 \text{ kHz})$.
5. Sweep time = auto, trigger set to "free run".
6. Trace average at least 100 traces in power averaging mode.
7. Record the max value and add $10 \log (1/\text{duty cycle})$

4.5.5 Deviation from Test Standard

No deviation.

4.5.6 EUT Operating Conditions

The software provided by client to enable the EUT under transmission condition continuously at lowest, middle and highest channel frequencies individually.

4.5.7 Test Results

For U-NII-1, U-NII-2A, U-NII-2C Band

802.11a

Channel	Frequency (MHz)	PSD (dBm/MHz)		Duty Factor (dB)	Total PSD with Duty Factor (dBm/MHz)	Max. Limit (dBm/MHz)	Pass / Fail
		Chain 0	Chain 1				
36	5180	3.22	2.96	0.39	6.49	11	Pass
40	5200	3.03	2.99	0.39	6.41	11	Pass
48	5240	3.67	2.82	0.39	6.66	11	Pass
52	5260	3.29	3.03	0.39	6.56	11	Pass
60	5300	3.07	2.96	0.39	6.41	11	Pass
64	5320	3.21	3.01	0.39	6.51	11	Pass
100	5500	3.05	3.27	0.39	6.56	11	Pass
116	5580	2.72	3.13	0.39	6.33	11	Pass
140	5700	1.22	0.71	0.39	4.37	11	Pass
144	5720 (U-NII-2C)	1.80	2.06	0.39	5.33	11	Pass

Note:

- Method E) 2) a) of power density measurement of KDB 662911 is using for calculating total power density. Total power density is summing entire spectra across corresponding frequency bins on the various outputs by computer.
- For U-NII-1 Band:**
Directional gain = 2.67 dBi + 10log(2) = 5.68 dBi < 6 dBi , so the limit no need to be reduced.
For U-NII-2A Band:
Directional gain = 2.27 dBi + 10log(2) = 5.28 dBi < 6 dBi , so the limit no need to be reduced.
For U-NII-2C Band:
Directional gain = 2.07 dBi + 10log(2) = 5.08 dBi < 6 dBi , so the limit no need to be reduced.
- Refer to section 3.3 for duty cycle spectrum plot.

802.11ac (VHT20)

Channel	Frequency (MHz)	PSD (dBm/MHz)		Duty Factor (dB)	Total PSD with Duty Factor (dBm/MHz)	Max. Limit (dBm/MHz)	Pass / Fail
		Chain 0	Chain 1				
36	5180	1.75	2.04	0.40	5.30	11	Pass
40	5200	1.00	1.87	0.40	4.86	11	Pass
48	5240	1.78	1.68	0.40	5.14	11	Pass
52	5260	1.53	1.65	0.40	5.00	11	Pass
60	5300	1.91	1.79	0.40	5.26	11	Pass
64	5320	1.75	1.61	0.40	5.09	11	Pass
100	5500	1.73	2.11	0.40	5.33	11	Pass
116	5580	1.66	1.54	0.40	5.01	11	Pass
140	5700	-0.05	-0.17	0.40	3.30	11	Pass
144	5720 (U-NII-2C)	1.22	1.24	0.40	4.64	11	Pass

Note:

- Method E) 2) a) of power density measurement of KDB 662911 is using for calculating total power density. Total power density is summing entire spectra across corresponding frequency bins on the various outputs by computer.
- For U-NII-1 Band:**
 Directional gain = $2.67 \text{ dBi} + 10\log(2) = 5.68 \text{ dBi} < 6 \text{ dBi}$, so the limit no need to be reduced.
For U-NII-2A Band:
 Directional gain = $2.27 \text{ dBi} + 10\log(2) = 5.28 \text{ dBi} < 6 \text{ dBi}$, so the limit no need to be reduced.
For U-NII-2C Band:
 Directional gain = $2.07 \text{ dBi} + 10\log(2) = 5.08 \text{ dBi} < 6 \text{ dBi}$, so the limit no need to be reduced.
- Refer to section 3.3 for duty cycle spectrum plot.

802.11ac (VHT40)

Channel	Frequency (MHz)	PSD (dBm/MHz)		Duty Factor (dB)	Total PSD with Duty Factor (dBm/MHz)	Max. Limit (dBm/MHz)	Pass / Fail
		Chain 0	Chain 1				
38	5190	-4.21	-4.30	0.80	-0.45	11	Pass
46	5230	-2.88	-2.89	0.80	0.92	11	Pass
54	5270	-3.73	-2.96	0.80	0.48	11	Pass
62	5310	-2.70	-3.05	0.80	0.93	11	Pass
102	5510	-3.83	-4.39	0.80	-0.30	11	Pass
110	5550	-2.44	-3.11	0.80	1.04	11	Pass
134	5670	-3.29	-2.92	0.80	0.70	11	Pass
142	5710 (U-NII-2C)	-2.93	-2.95	0.80	0.87	11	Pass

Note:

- Method E) 2) a) of power density measurement of KDB 662911 is using for calculating total power density. Total power density is summing entire spectra across corresponding frequency bins on the various outputs by computer.
- For U-NII-1 Band:**
Directional gain = $2.67 \text{ dBi} + 10\log(2) = 5.68 \text{ dBi} < 6 \text{ dBi}$, so the limit no need to be reduced.
For U-NII-2A Band:
Directional gain = $2.27 \text{ dBi} + 10\log(2) = 5.28 \text{ dBi} < 6 \text{ dBi}$, so the limit no need to be reduced.
For U-NII-2C Band:
Directional gain = $2.07 \text{ dBi} + 10\log(2) = 5.08 \text{ dBi} < 6 \text{ dBi}$, so the limit no need to be reduced.
- Refer to section 3.3 for duty cycle spectrum plot.

802.11ac (VHT80)

Channel	Frequency (MHz)	PSD (dBm/MHz)		Duty Factor (dB)	Total PSD with Duty Factor (dBm/MHz)	Max. Limit (dBm/MHz)	Pass / Fail
		Chain 0	Chain 1				
42	5210	-6.82	-6.74	1.69	-2.08	11	Pass
58	5290	-5.78	-5.80	1.69	-1.09	11	Pass
106	5530	-6.62	-7.00	1.69	-2.11	11	Pass
122	5610	-4.89	-5.47	1.69	-0.47	11	Pass
138	5690 (U-NII-2C)	-4.98	-5.49	1.69	-0.53	11	Pass

Note:

- Method E) 2) a) of power density measurement of KDB 662911 is using for calculating total power density. Total power density is summing entire spectra across corresponding frequency bins on the various outputs by computer.
- For U-NII-1 Band:**
Directional gain = $2.67 \text{ dBi} + 10\log(2) = 5.68 \text{ dBi} < 6 \text{ dBi}$, so the limit no need to be reduced.
For U-NII-2A Band:
Directional gain = $2.27 \text{ dBi} + 10\log(2) = 5.28 \text{ dBi} < 6 \text{ dBi}$, so the limit no need to be reduced.
For U-NII-2C Band:
Directional gain = $2.07 \text{ dBi} + 10\log(2) = 5.08 \text{ dBi} < 6 \text{ dBi}$, so the limit no need to be reduced.
- Refer to section 3.3 for duty cycle spectrum plot.

Spectrum Plot of Worst Value

802.11a

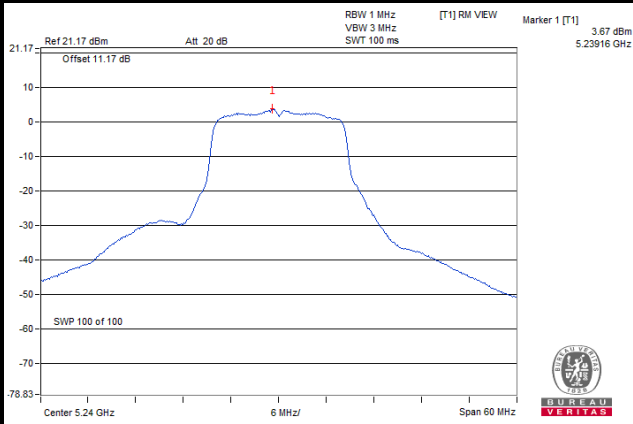

802.11ac (VHT20)

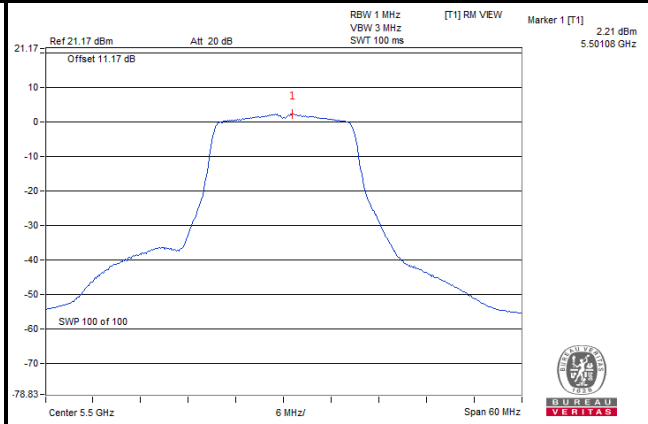

802.11ac (VHT40)

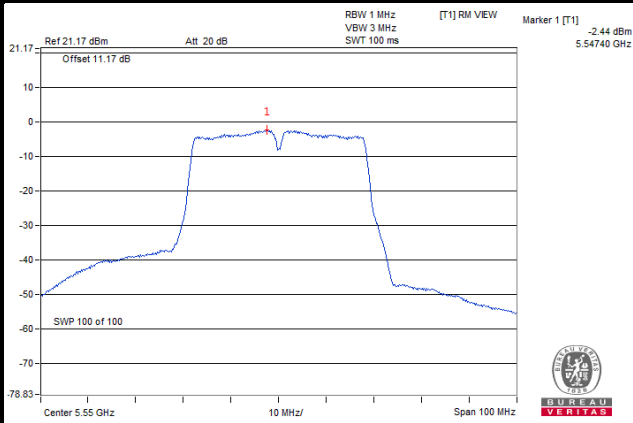

802.11ac (VHT80)

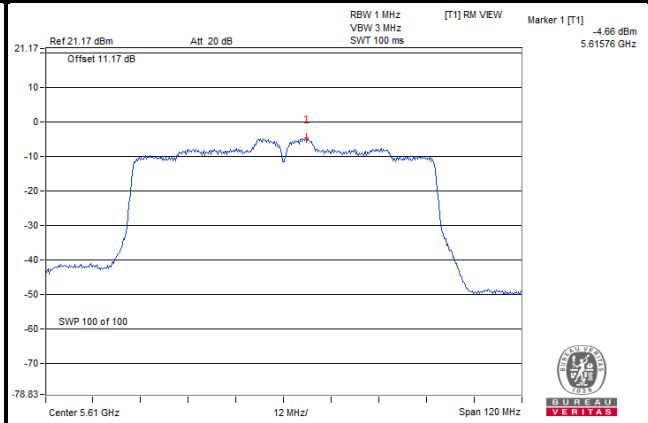

For U-NII-3 Band
802.11a

TX Chain	Channel	Frequency (MHz)	PSD w/o Duty Factor		10 log (N=2) dB	Duty Factor (dB)	Total PSD with Duty Factor (dBm/500 kHz)	Limit (dBm/500 kHz)	Pass / Fail
			(dBm/300 kHz)	(dBm/500 kHz)					
0	144	5720 (U-NII-3)	-9.5	-7.28	3.01	0.39	-3.88	30	Pass
	149	5745	-6.33	-4.11	3.01	0.39	-0.71	30	Pass
	157	5785	-5.41	-3.19	3.01	0.39	0.21	30	Pass
	165	5825	-6.21	-3.99	3.01	0.39	-0.59	30	Pass
1	144	5720 (U-NII-3)	-8.82	-6.6	3.01	0.39	-3.2	30	Pass
	149	5745	-6.86	-4.64	3.01	0.39	-1.24	30	Pass
	157	5785	-5.75	-3.53	3.01	0.39	-0.13	30	Pass
	165	5825	-6.07	-3.85	3.01	0.39	-0.45	30	Pass

Note:

- Method E) 2) c) of power density measurement of KDB 662911 is using for calculating total power density. Total power density is measure value add 10 log (N_{ANT}) dB.
- Directional gain = 1.78 dBi + 10log(2) = 4.79 dBi < 6 dBi , so the limit does not need to reduced.
- Refer to section 3.3 for duty cycle spectrum plot.

802.11ac (VHT20)

TX Chain	Channel	Frequency (MHz)	PSD		10 log (N=2) dB	Duty Factor (dB)	Total PSD with Duty Factor (dBm/500 kHz)	Limit (dBm/500 kHz)	Pass / Fail
			(dBm/300 kHz)	(dBm/500 kHz)					
0	144	5720 (U-NII-3)	-4.8	-2.58	3.01	0.40	0.83	30	Pass
	149	5745	-4.37	-2.15	3.01	0.40	1.26	30	Pass
	157	5785	-4.3	-2.08	3.01	0.40	1.33	30	Pass
	165	5825	-4.49	-2.27	3.01	0.40	1.14	30	Pass
1	144	5720 (U-NII-3)	-5.13	-2.91	3.01	0.40	0.5	30	Pass
	149	5745	-4.27	-2.05	3.01	0.40	1.36	30	Pass
	157	5785	-3.98	-1.76	3.01	0.40	1.65	30	Pass
	165	5825	-3.83	-1.61	3.01	0.40	1.8	30	Pass

Note:

- Method E) 2) c) of power density measurement of KDB 662911 is using for calculating total power density. Total power density is measure value add 10 log (N_{ANT}) dB.
- Directional gain = 1.78 dBi + 10log(2) = 4.79 dBi < 6 dBi , so the limit does not need to reduced.
- Refer to section 3.3 for duty cycle spectrum plot.

802.11ac (VHT40)

TX Chain	Channel	Frequency (MHz)	PSD		10 log (N=2) dB	Duty Factor (dB)	Total PSD with Duty Factor (dBm/500 kHz)	Limit (dBm/500 kHz)	Pass / Fail
			(dBm/300 kHz)	(dBm/500 kHz)					
0	142	5710 (U-NII-3)	-9.93	-7.71	3.01	0.80	-3.9	30	Pass
	151	5755	-10.06	-7.84	3.01	0.80	-4.03	30	Pass
	159	5795	-9.95	-7.73	3.01	0.80	-3.92	30	Pass
1	142	5710 (U-NII-3)	-9.84	-7.62	3.01	0.80	-3.81	30	Pass
	151	5755	-9.46	-7.24	3.01	0.80	-3.43	30	Pass
	159	5795	-10.09	-7.87	3.01	0.80	-4.06	30	Pass

Note:

- Method E) 2) c) of power density measurement of KDB 662911 is using for calculating total power density. Total power density is measure value add $10 \log (N_{ANT})$ dB.
- Directional gain = $1.78 \text{ dBi} + 10\log(2) = 4.79 \text{ dBi} < 6 \text{ dBi}$, so the limit does not need to reduced.
- Refer to section 3.3 for duty cycle spectrum plot.

802.11ac (VHT80)

TX Chain	Channel	Frequency (MHz)	PSD		10 log (N=2) dB	Duty Factor (dB)	Total PSD with Duty Factor (dBm/500 kHz)	Limit (dBm/500 kHz)	Pass / Fail
			(dBm/300 kHz)	(dBm/500 kHz)					
0	138	5690 (U-NII-3)	-18.24	-16.02	3.01	1.69	-11.32	30	Pass
	155	5775	-13.27	-11.05	3.01	1.69	-6.35	30	Pass
1	138	5690 (U-NII-3)	-19.31	-17.09	3.01	1.69	-12.39	30	Pass
	155	5775	-13.95	-11.73	3.01	1.69	-7.03	30	Pass

Note:

- Method E) 2) c) of power density measurement of KDB 662911 is using for calculating total power density. Total power density is measure value add $10 \log (N_{ANT})$ dB.
- Directional gain = $1.78 \text{ dBi} + 10\log(2) = 4.79 \text{ dBi} < 6 \text{ dBi}$, so the limit does not need to reduced.
- Refer to section 3.3 for duty cycle spectrum plot.

Spectrum Plot of Worst Value

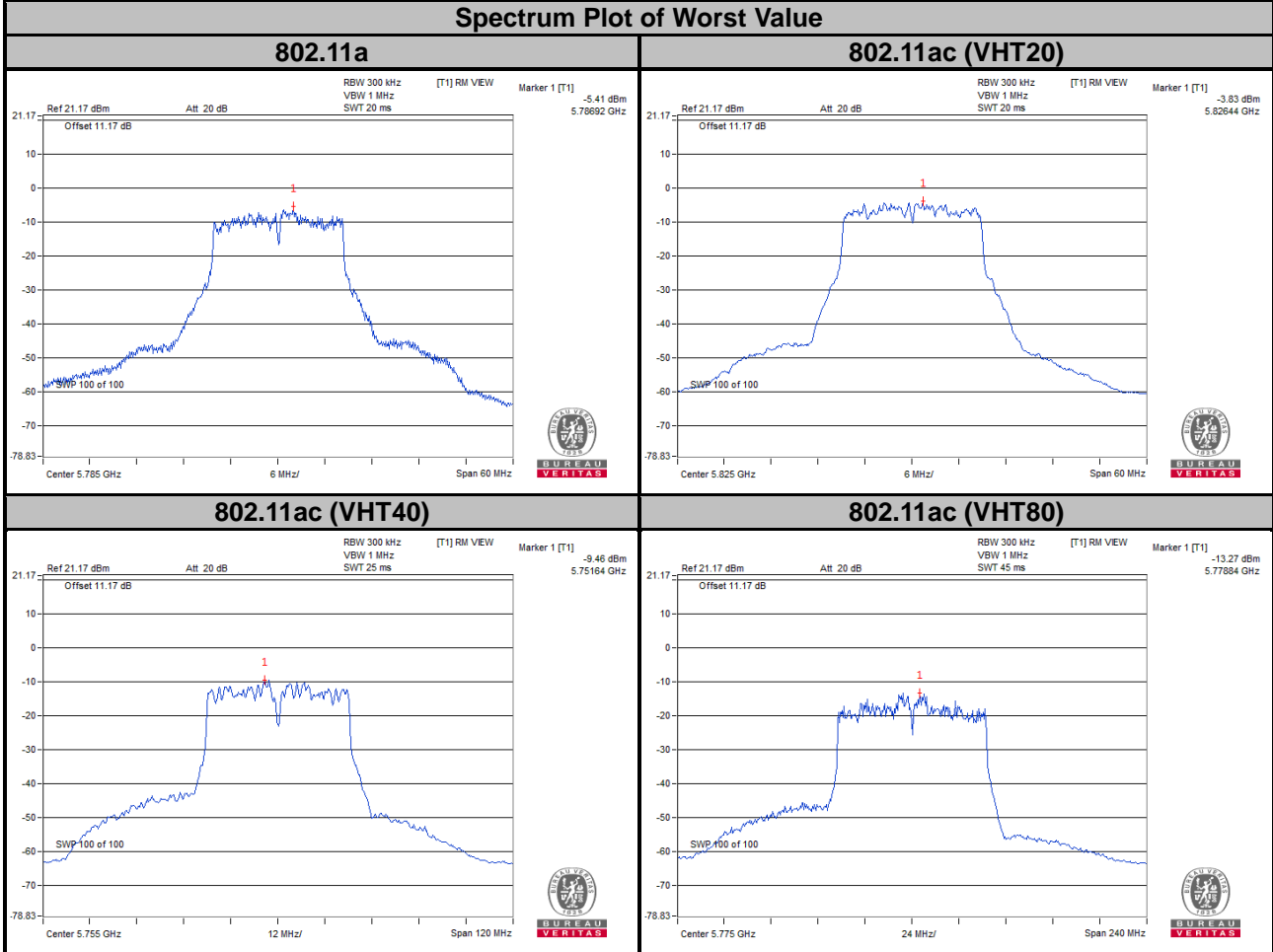

4.6 Frequency Stability

4.6.1 Limit of Frequency Stability Measurement

The frequency of the carrier signal shall be maintained within band of operation.

4.6.2 Test Setup

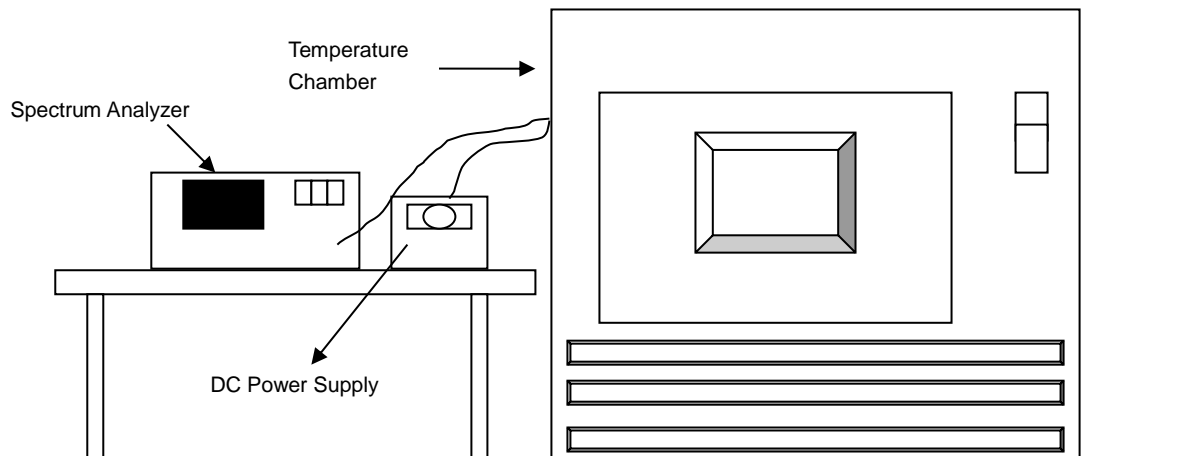

4.6.3 Test Instruments

Refer to section 4.1.2 to get information of above instrument.

4.6.4 Test Procedure

- The EUT was placed inside the environmental test chamber and powered by nominal DC voltage.
- Turn the EUT on and couple its output to a spectrum analyzer.
- Turn the EUT off and set the chamber to the highest temperature specified.
- Allow sufficient time (approximately 30 min) for the temperature of the chamber to stabilize, turn the EUT on and measure the operating frequency after 2, 5, and 10 Minutes.
- Repeat step (d) with the temperature chamber set to the next desired temperature until measurements down to the lowest specified temperature have been completed.
- The test chamber was allowed to stabilize at +20 degree C for a minimum of 30 Minutes. The supply voltage was then adjusted on the EUT from 85% to 115% and the frequency record.

4.6.5 Deviation from Test Standard

No deviation.

4.6.6 EUT Operating Condition

Set the EUT transmit at un-modulation mode to test frequency stability.

4.6.7 Test Results

Frequency Stability Versus Temp.									
Operating Frequency: 5180 MHz									
Temp. (°C)	Power Supply (Vdc)	0 Minute		2 Minute		5 Minute		10 Minute	
		Measured Frequency (MHz)	Result)	Measured Frequency (MHz)	Result)	Measured Frequency (MHz)	Result)	Measured Frequency (MHz)	Result)
85	3.6	5180.0133	PASS	5180.0135	PASS	5180.0127	PASS	5180.0139	PASS
80	3.6	5180.0047	PASS	5180.0023	PASS	5180.004	PASS	5180.0049	PASS
70	3.6	5179.9753	PASS	5179.9783	PASS	5179.9765	PASS	5179.9767	PASS
60	3.6	5180.0178	PASS	5180.0205	PASS	5180.0182	PASS	5180.0211	PASS
50	3.6	5179.9774	PASS	5179.9732	PASS	5179.9781	PASS	5179.9743	PASS
40	3.6	5179.9748	PASS	5179.9754	PASS	5179.9753	PASS	5179.9756	PASS
30	3.6	5179.9891	PASS	5179.9859	PASS	5179.9894	PASS	5179.9881	PASS
20	3.6	5180.0109	PASS	5180.0079	PASS	5180.0103	PASS	5180.0095	PASS
10	3.6	5179.9767	PASS	5179.9807	PASS	5179.9765	PASS	5179.9798	PASS
0	3.6	5179.9801	PASS	5179.984	PASS	5179.9838	PASS	5179.981	PASS
-10	3.6	5179.9806	PASS	5179.9783	PASS	5179.9775	PASS	5179.9776	PASS
-20	3.6	5180.021	PASS	5180.0198	PASS	5180.0198	PASS	5180.0177	PASS

Frequency Stability Versus Voltage									
Operating Frequency: 5180 MHz									
Temp. (°C)	Power Supply (Vdc)	0 Minute		2 Minute		5 Minute		10 Minute	
		Measured Frequency (MHz)	Result)	Measured Frequency (MHz)	Result)	Measured Frequency (MHz)	Result)	Measured Frequency (MHz)	Result)
20	4.14	5180.0104	PASS	5180.0086	PASS	5180.0103	PASS	5180.0092	PASS
	3.6	5180.0109	PASS	5180.0079	PASS	5180.0103	PASS	5180.0095	PASS
	3.06	5180.0108	PASS	5180.0076	PASS	5180.0108	PASS	5180.0104	PASS

4.7 6 dB Bandwidth Measurement

4.7.1 Limits of 6 dB Bandwidth Measurement

The minimum of 6 dB Bandwidth Measurement is 0.5 MHz.

4.7.2 Test Setup

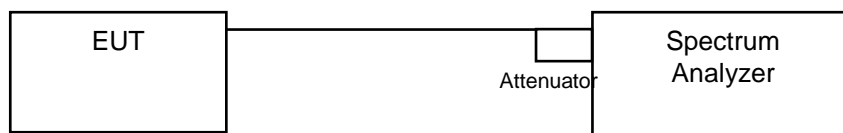

4.7.3 Test Instruments

Refer to section 4.1.2 to get information of above instrument.

4.7.4 Test Procedure

MEASUREMENT PROCEDURE REF

- Set resolution bandwidth (RBW) = 100 kHz
- Set the video bandwidth (VBW) $\geq 3 \times$ RBW, Detector = Peak.
- Trace mode = max hold.
- Sweep = auto couple.
- Measure the maximum width of the emission that is constrained by the frequencies associated with the two amplitude points (upper and lower) that are attenuated by 6 dB relative to the maximum level measured in the fundamental emission

4.7.5 Deviation from Test Standard

No deviation.

4.7.6 EUT Operating Condition

The software provided by client to enable the EUT under transmission condition continuously at lowest, middle and highest channel frequencies individually.

4.7.7 Test Results

802.11a

Channel	Frequency (MHz)	6 dB Bandwidth (MHz)		Minimum Limit (MHz)	Pass / Fail
		Chain 0	Chain 1		
144	5720 (U-NII-3)	3.15	3.20	0.5	Pass
149	5745	15.78	16.38	0.5	Pass
157	5785	15.98	16.39	0.5	Pass
165	5825	15.51	16.37	0.5	Pass

802.11ac (VHT20)

Channel	Frequency (MHz)	6 dB Bandwidth (MHz)		Minimum Limit (MHz)	Pass / Fail
		Chain 0	Chain 1		
144	5720 (U-NII-3)	3.15	3.16	0.5	Pass
149	5745	16.81	16.86	0.5	Pass
157	5785	16.96	16.76	0.5	Pass
165	5825	16.83	16.83	0.5	Pass

802.11ac (VHT40)

Channel	Frequency (MHz)	6 dB Bandwidth (MHz)		Minimum Limit (MHz)	Pass / Fail
		Chain 0	Chain 1		
142	5710 (U-NII-3)	2.82	2.66	0.5	Pass
151	5755	35.64	35.96	0.5	Pass
159	5795	36.12	35.36	0.5	Pass

802.11ac (VHT80)

Channel	Frequency (MHz)	6 dB Bandwidth (MHz)		Minimum Limit (MHz)	Pass / Fail
		Chain 0	Chain 1		
138	5690 (U-NII-3)	2.55	2.50	0.5	Pass
155	5775	72.85	70.26	0.5	Pass

Spectrum Plot of Worst Value

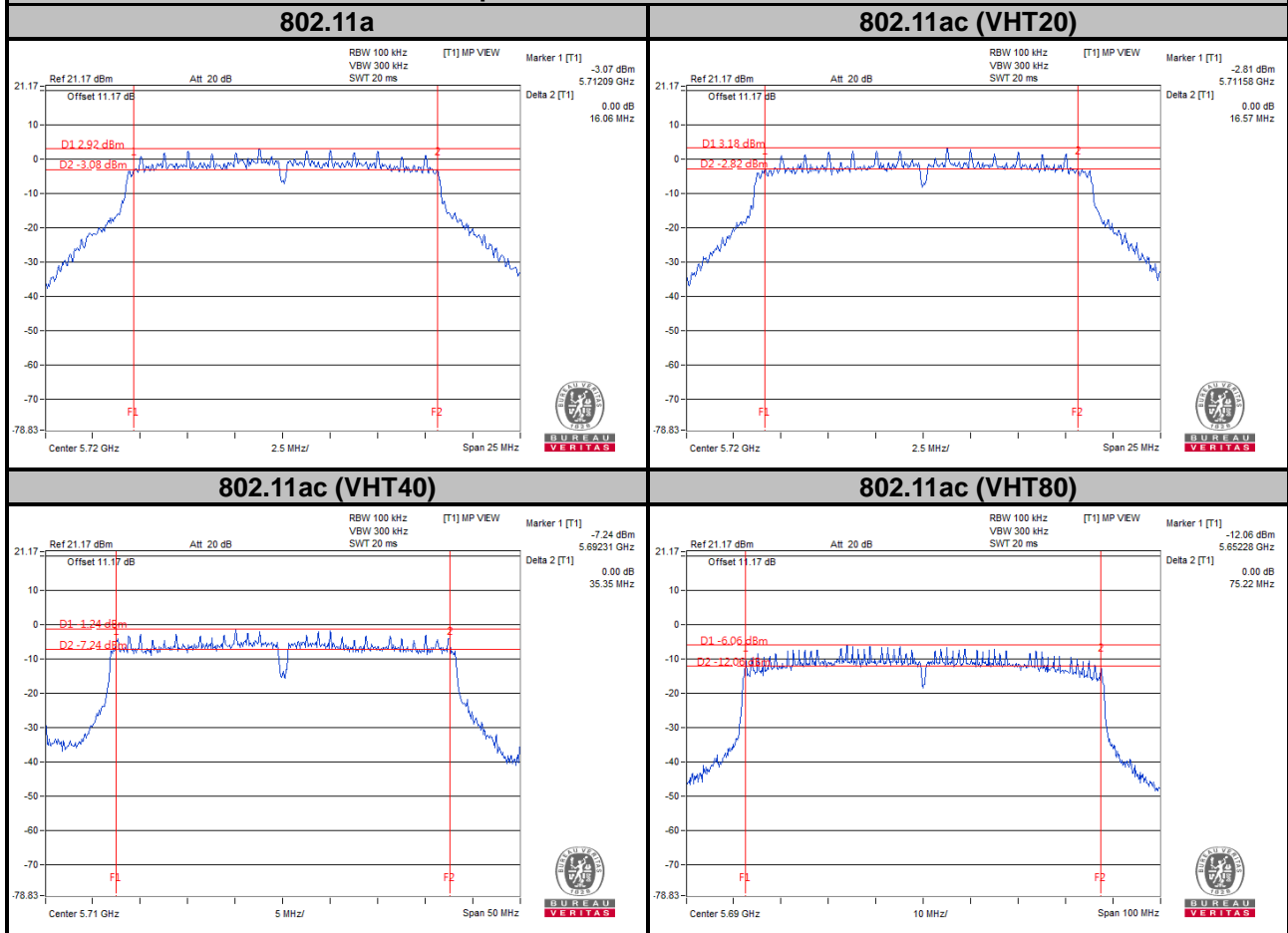

Note:

For Ch144 (UNII-3 Band): The 6 dB bandwidth above 5725 MHz = Marker 1 + Delta 2 – 5725 MHz
 For Ch142 (UNII-3 Band): The 6 dB bandwidth above 5725 MHz = Marker 1 + Delta 2 – 5725 MHz
 For Ch138 (UNII-3 Band): The 6 dB bandwidth above 5725 MHz = Marker 1 + Delta 2 – 5725 MHz

Spectrum Plot of Worst Value (non-straddle channels)

802.11a

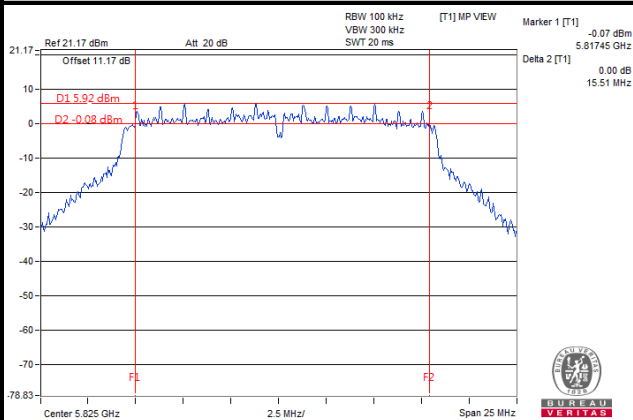

802.11ac (VHT20)

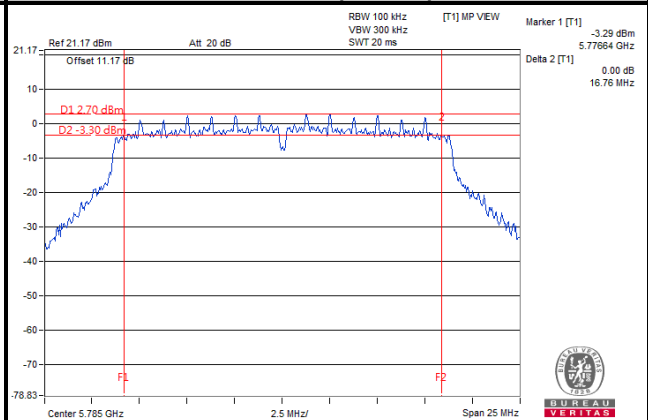

802.11ac (VHT40)

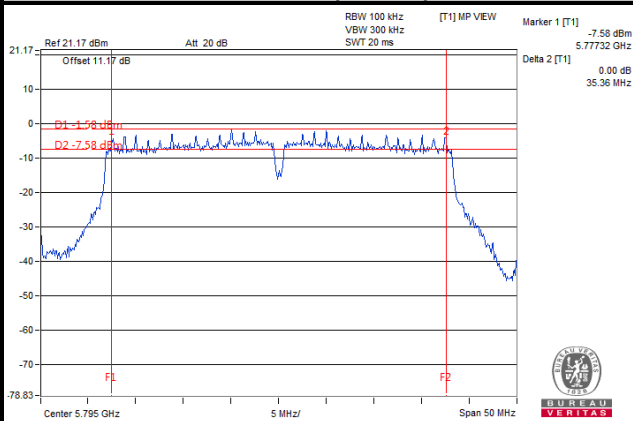

802.11ac (VHT80)

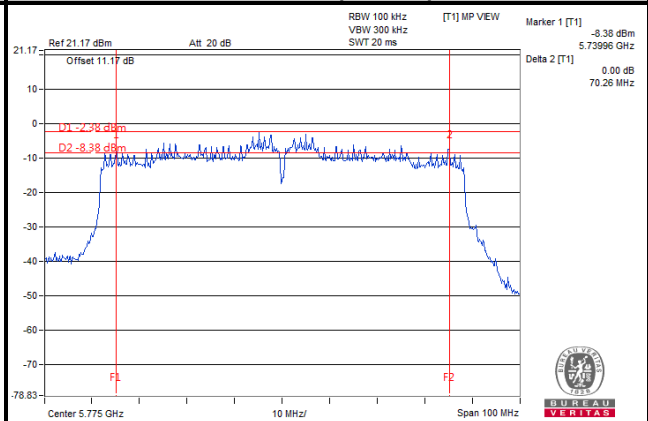

5 Pictures of Test Arrangements

Please refer to the attached file (Test Setup Photo).

Annex A- Radiated Out of Band Emission (OOBE) Measurement (For U-NII-3 band)

Mode A

802.11a

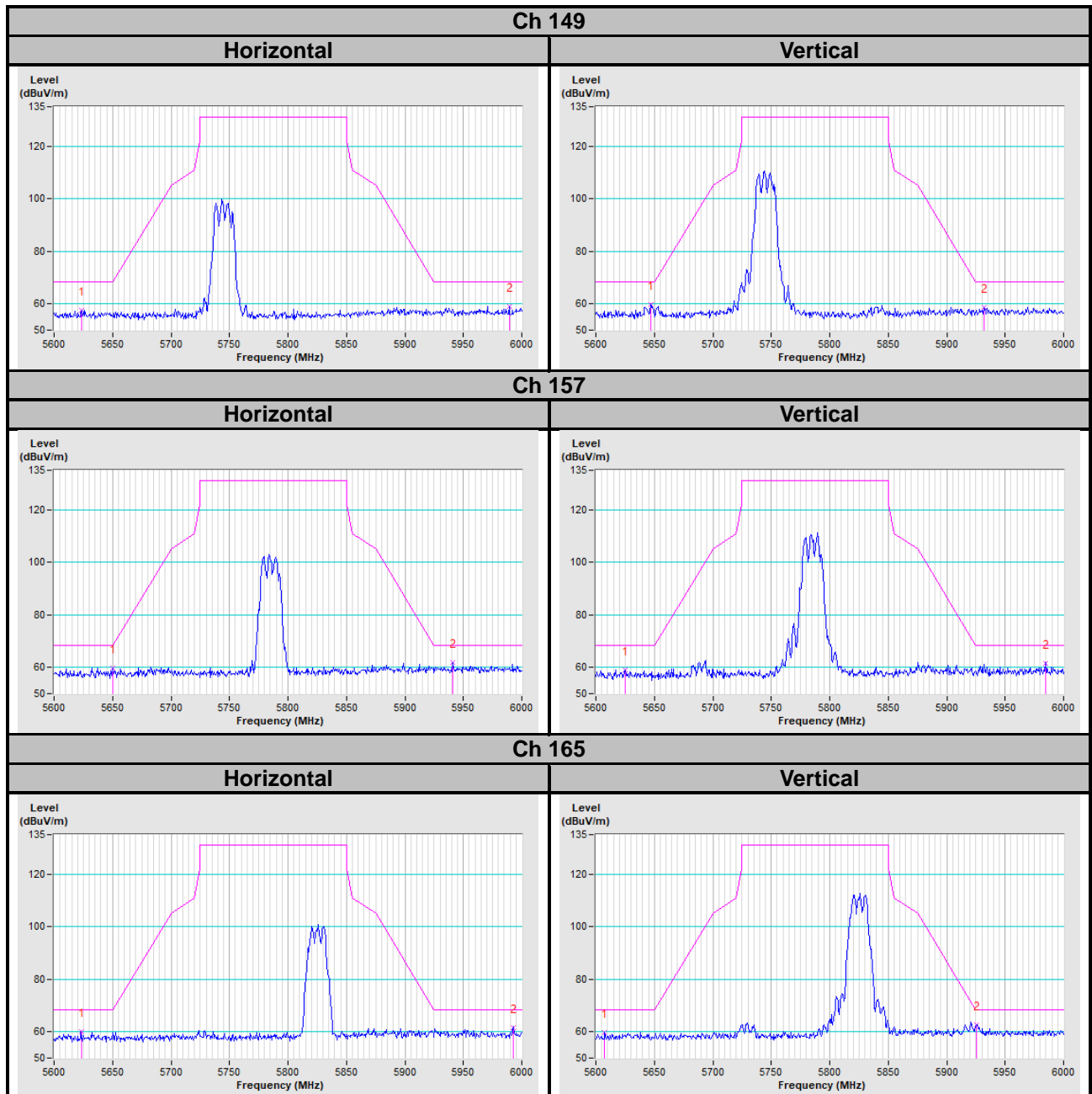

802.11ac (VHT20)

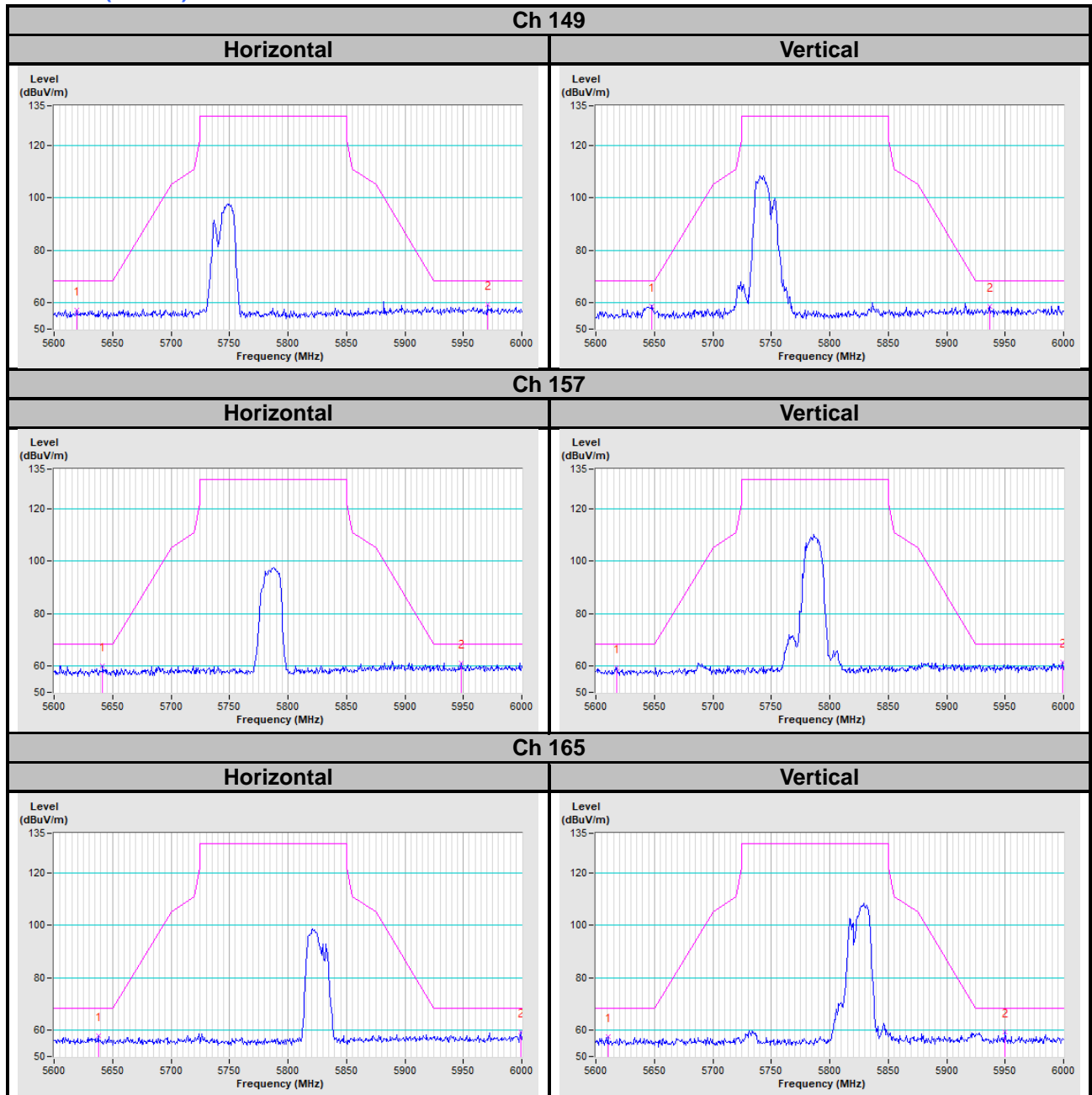

802.11ac (VHT40)

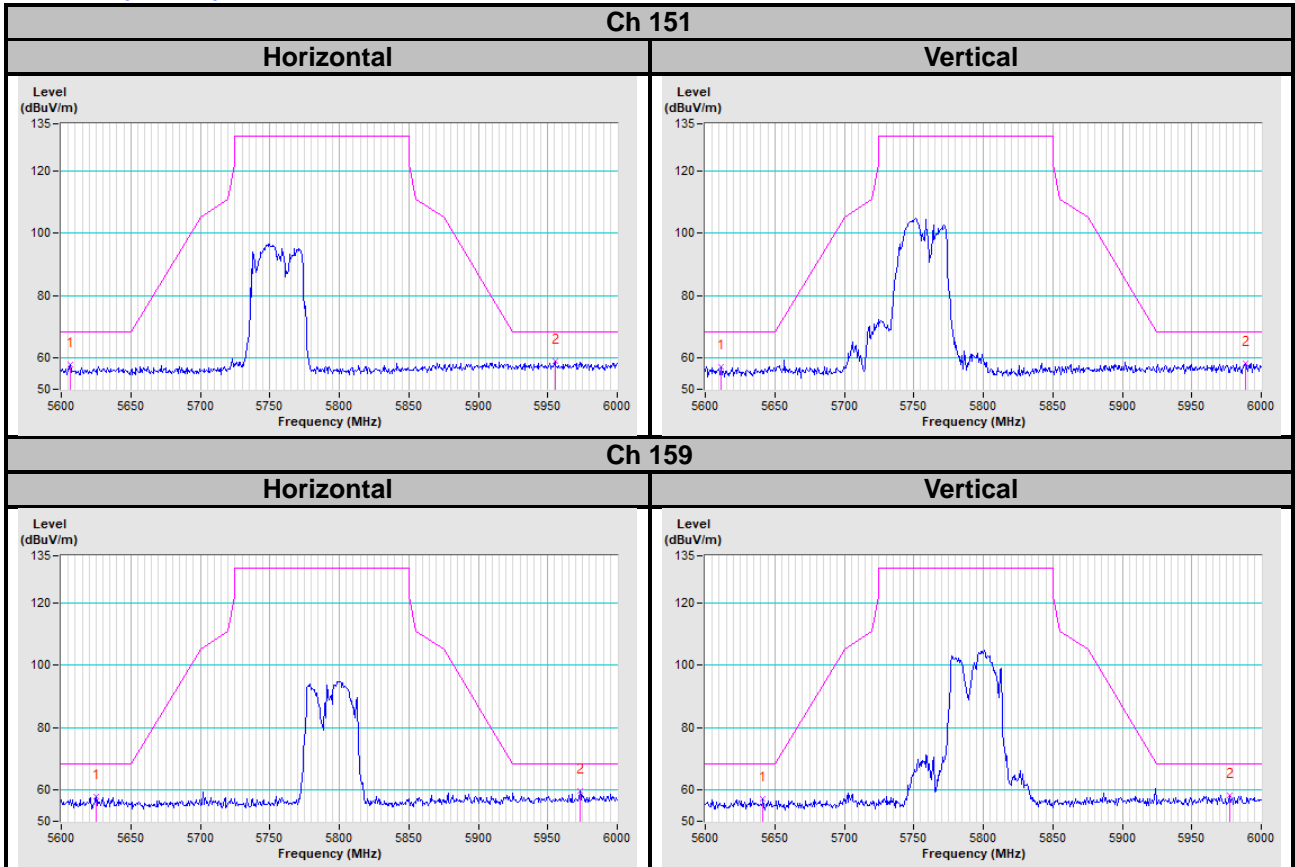

802.11ac (VHT80)

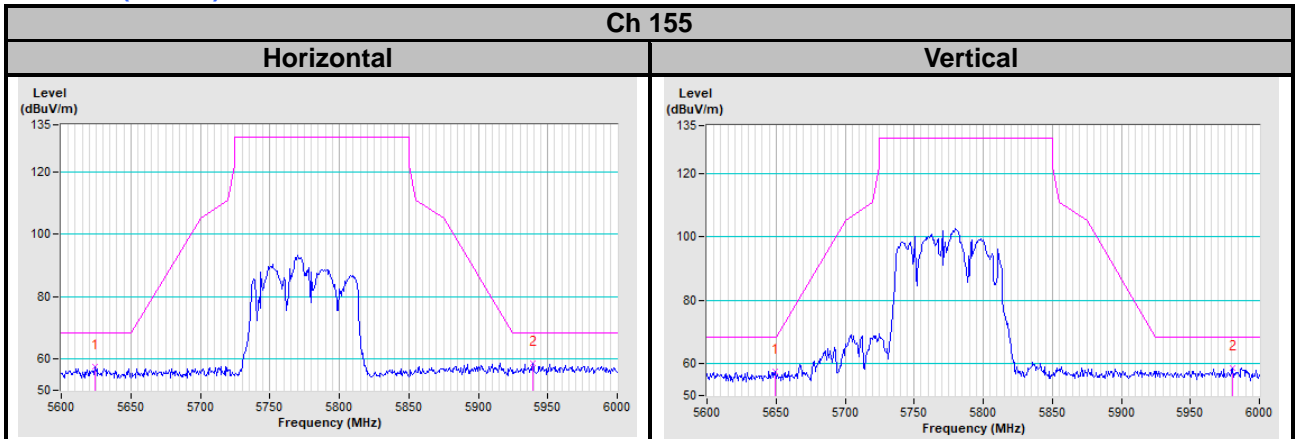

Mode B
802.11a

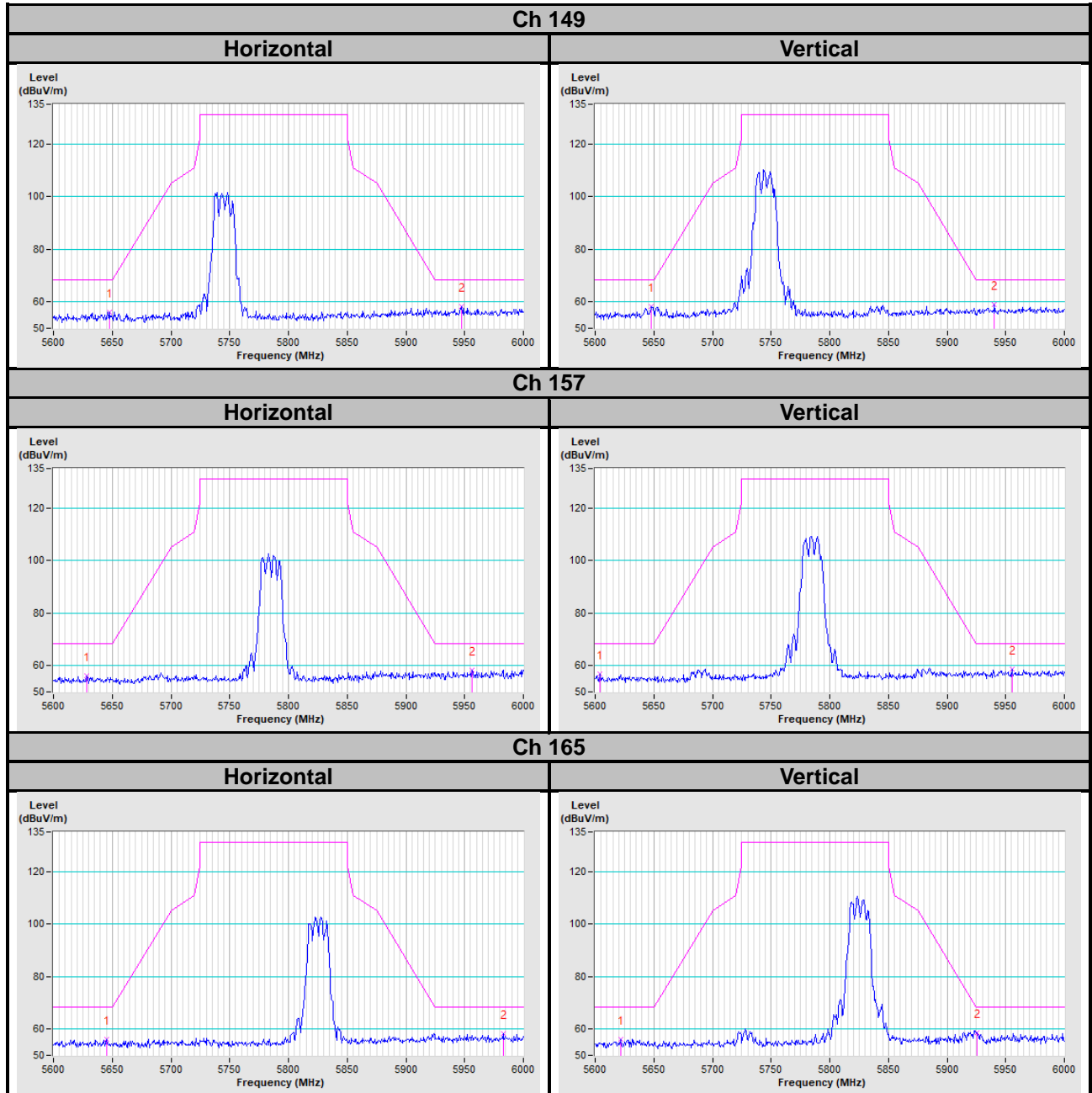

802.11ac (VHT20)

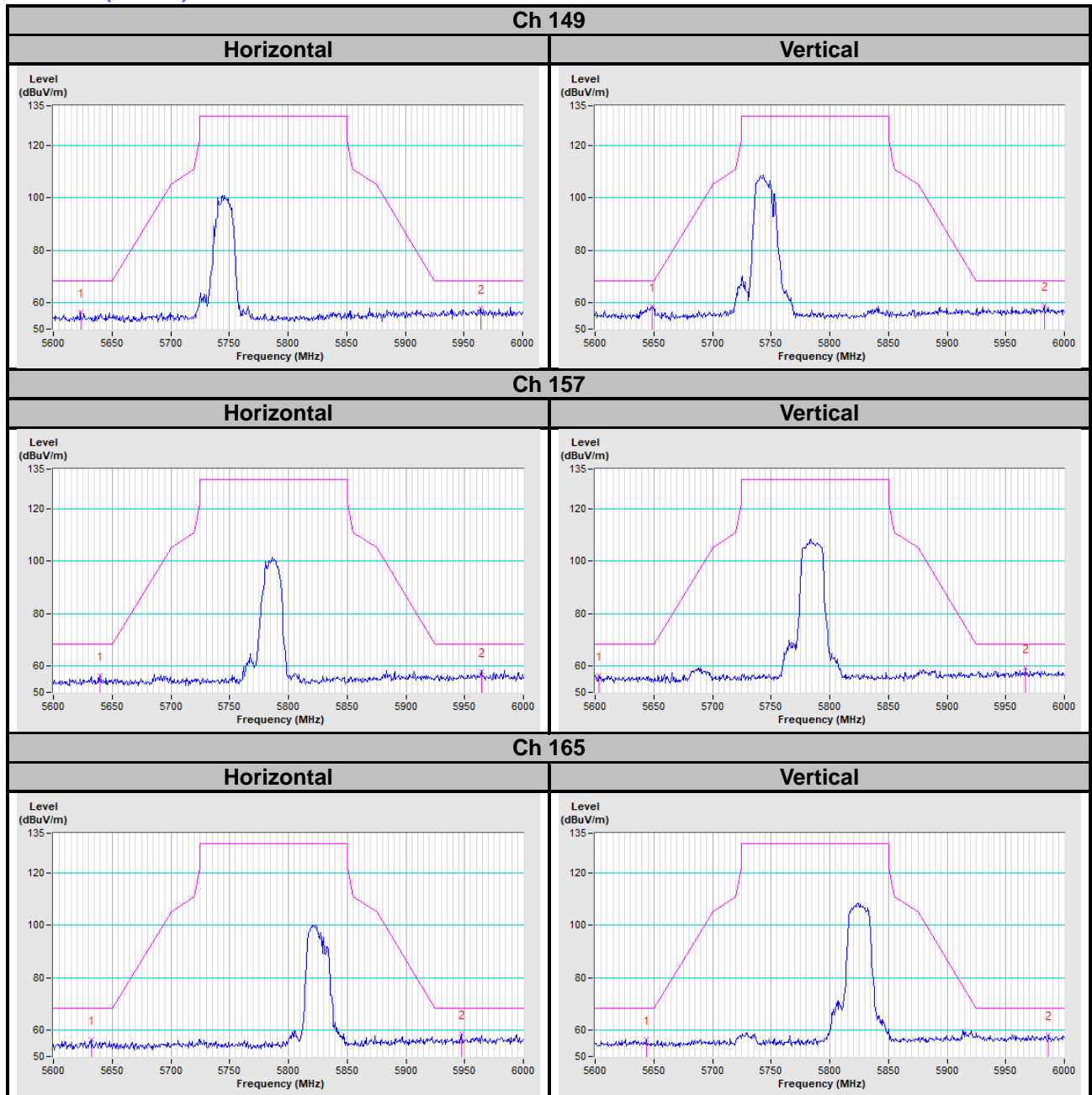

802.11ac (VHT40)

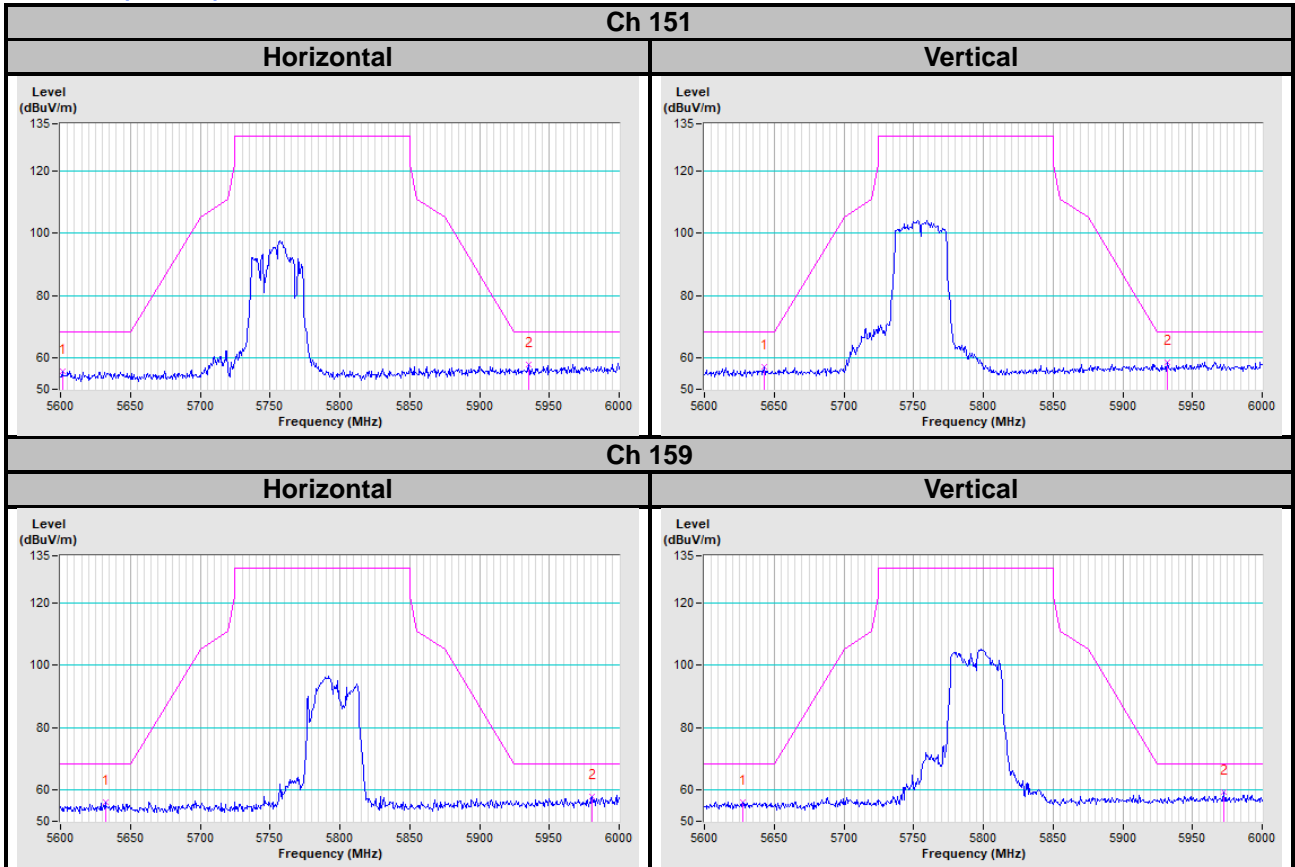

802.11ac (VHT80)

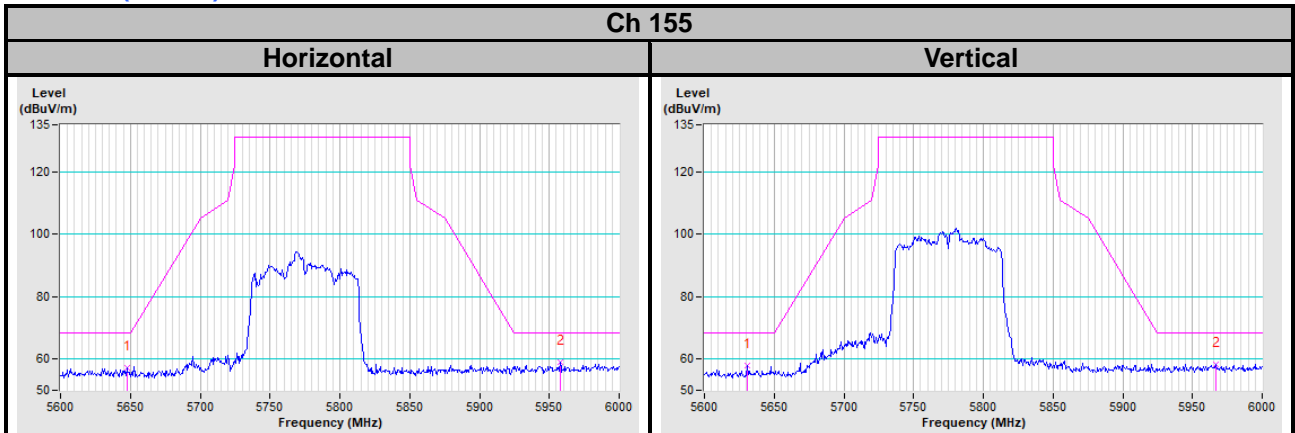

Annex B- Band Edge Measurement

Mode A

802.11a

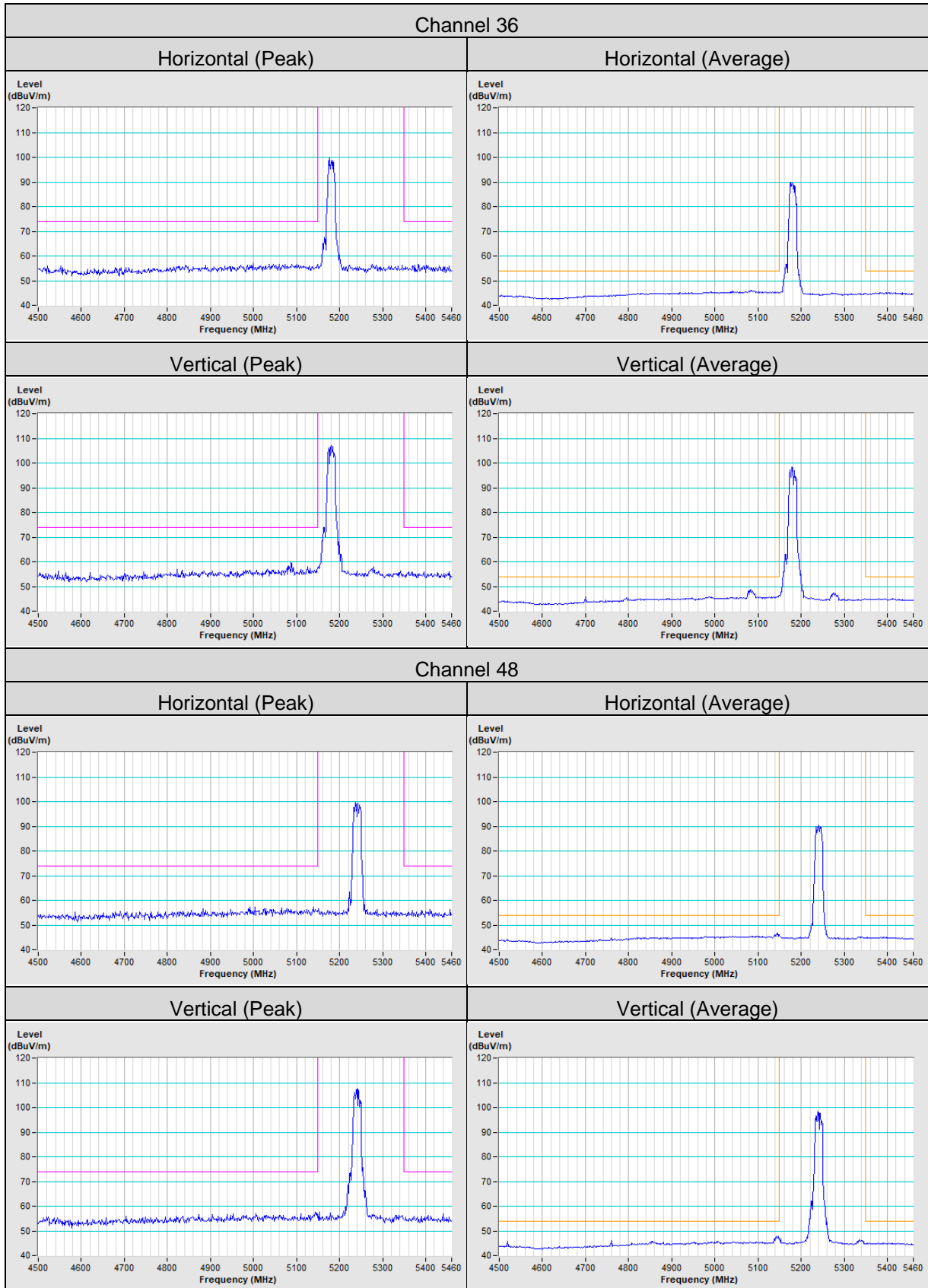

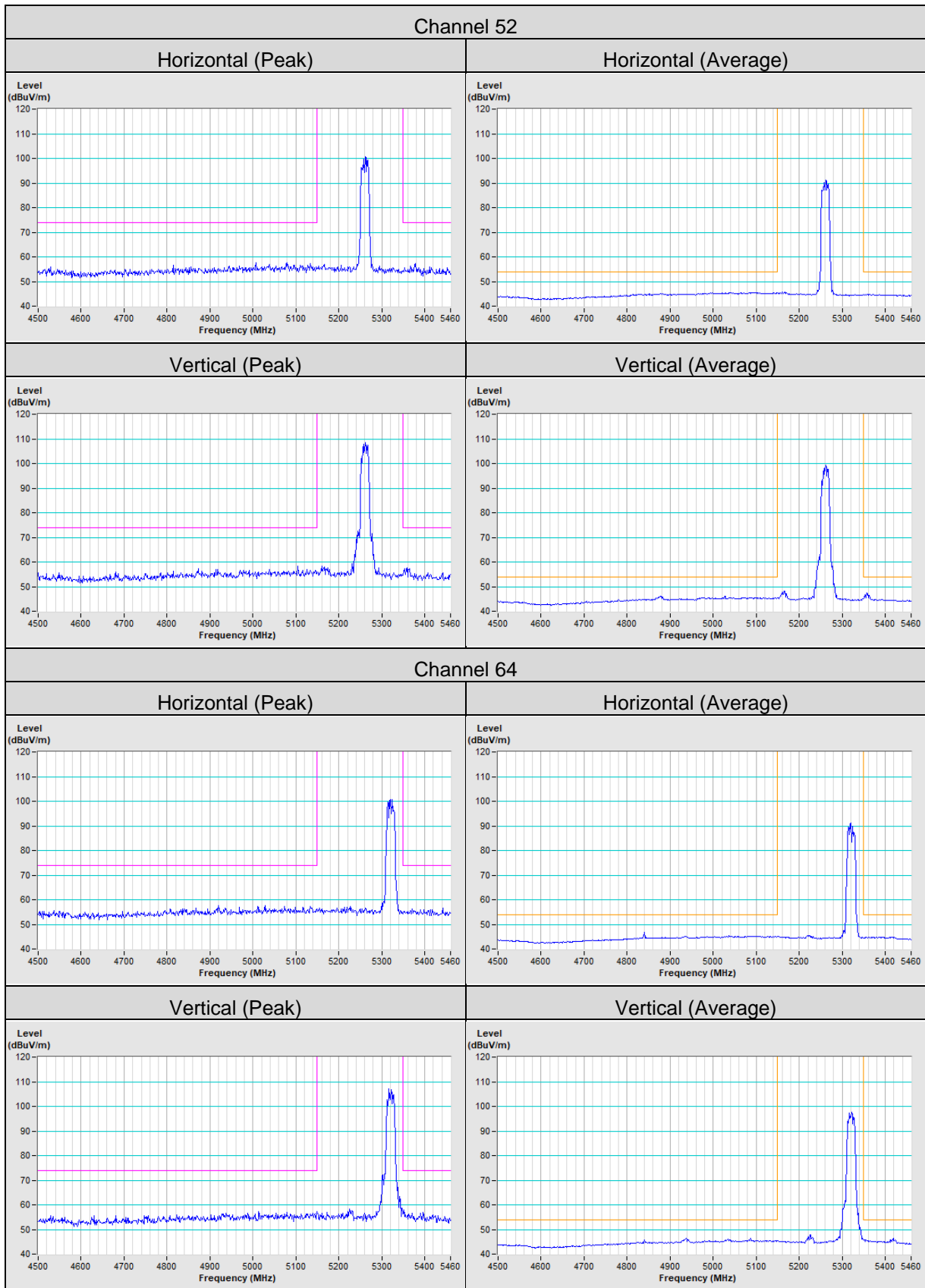

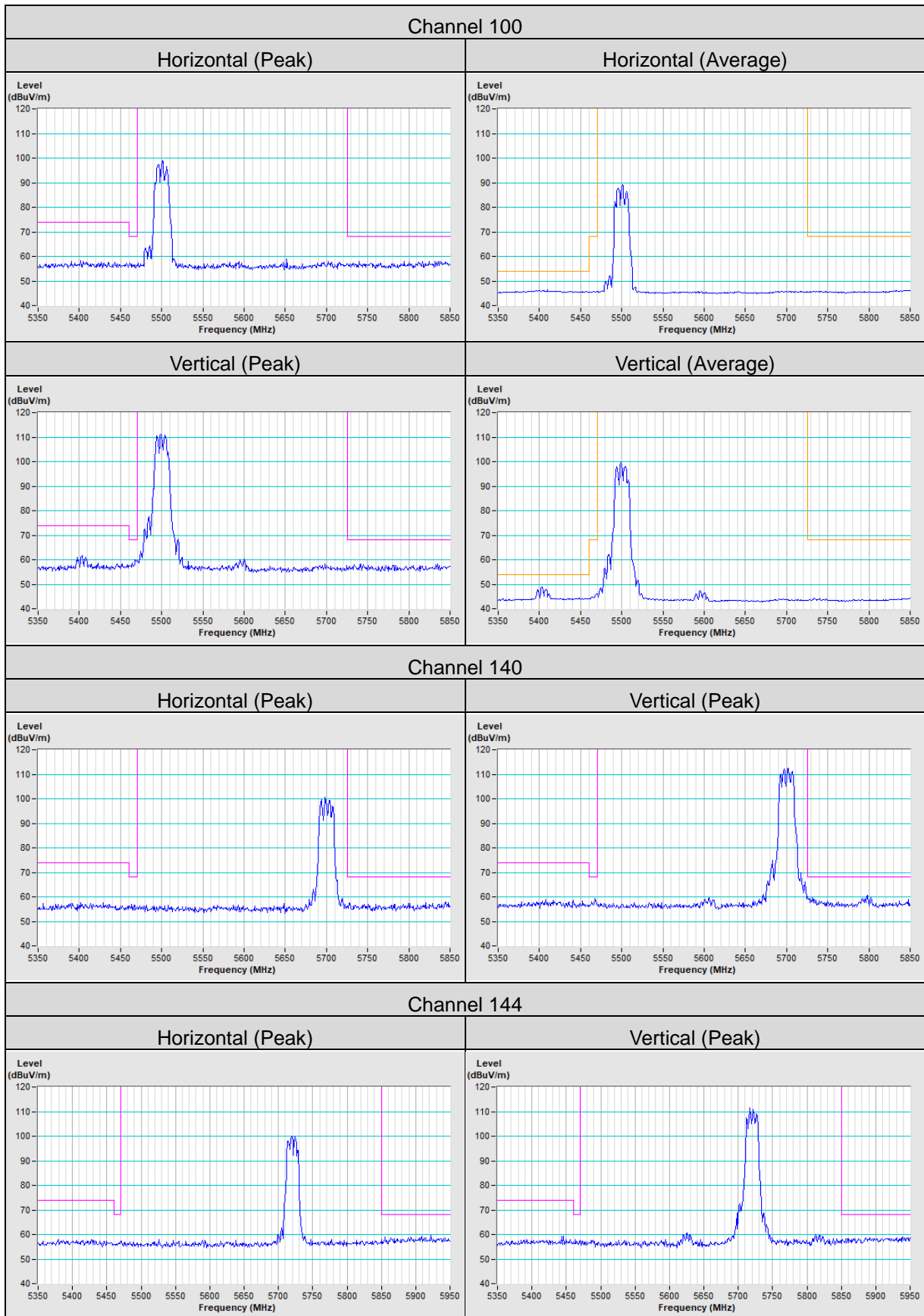

802.11ac (VHT20)

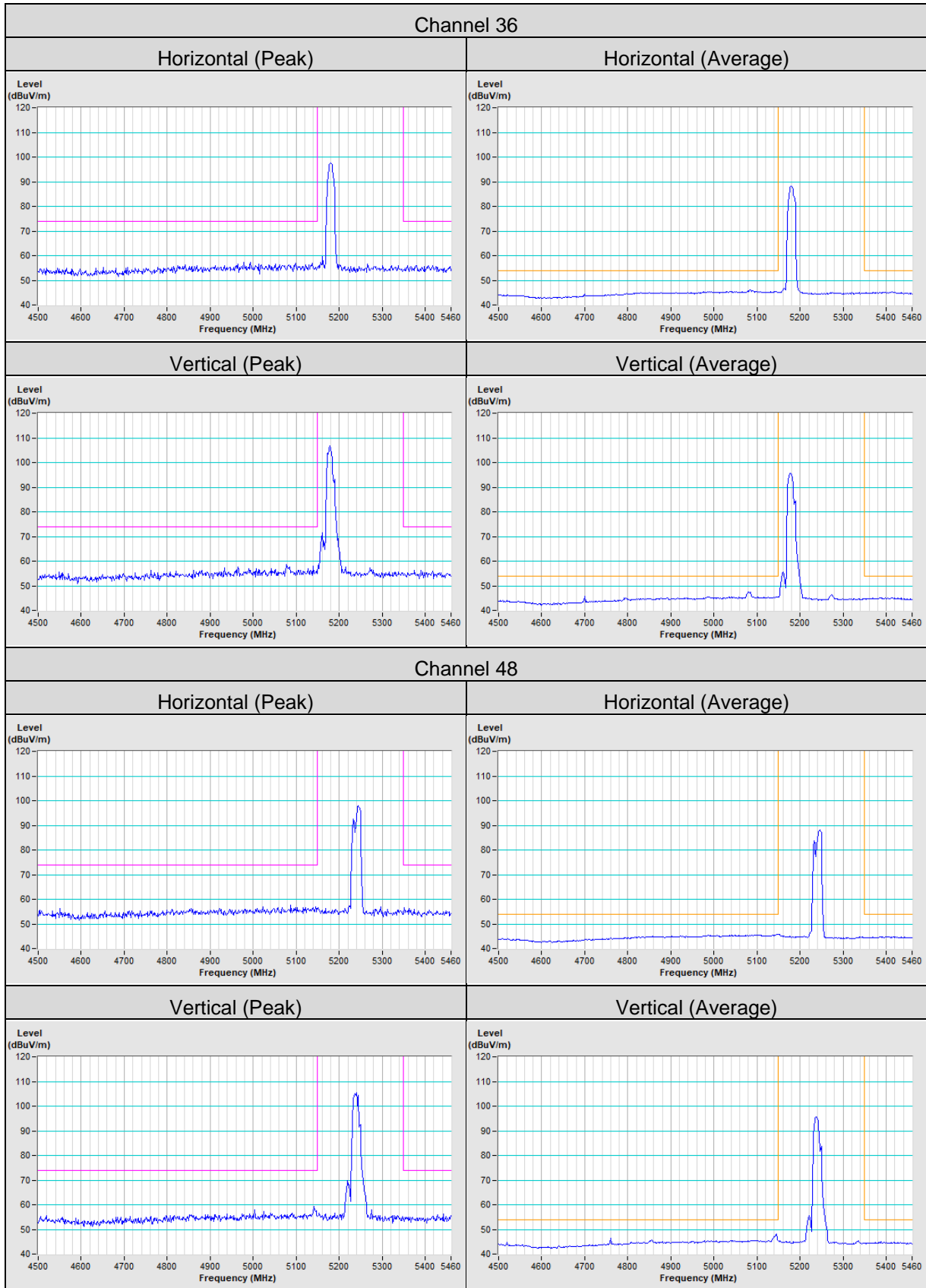

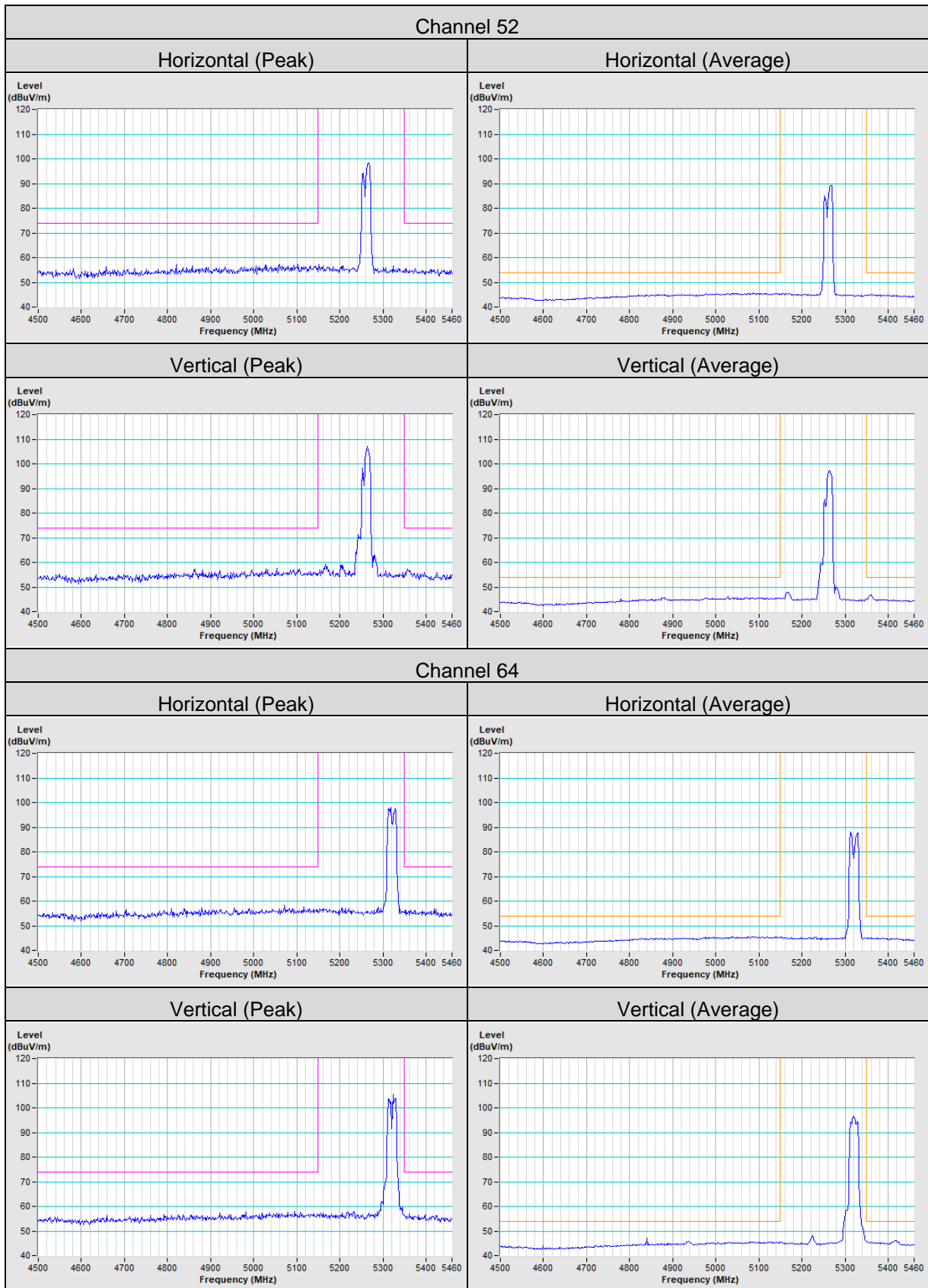

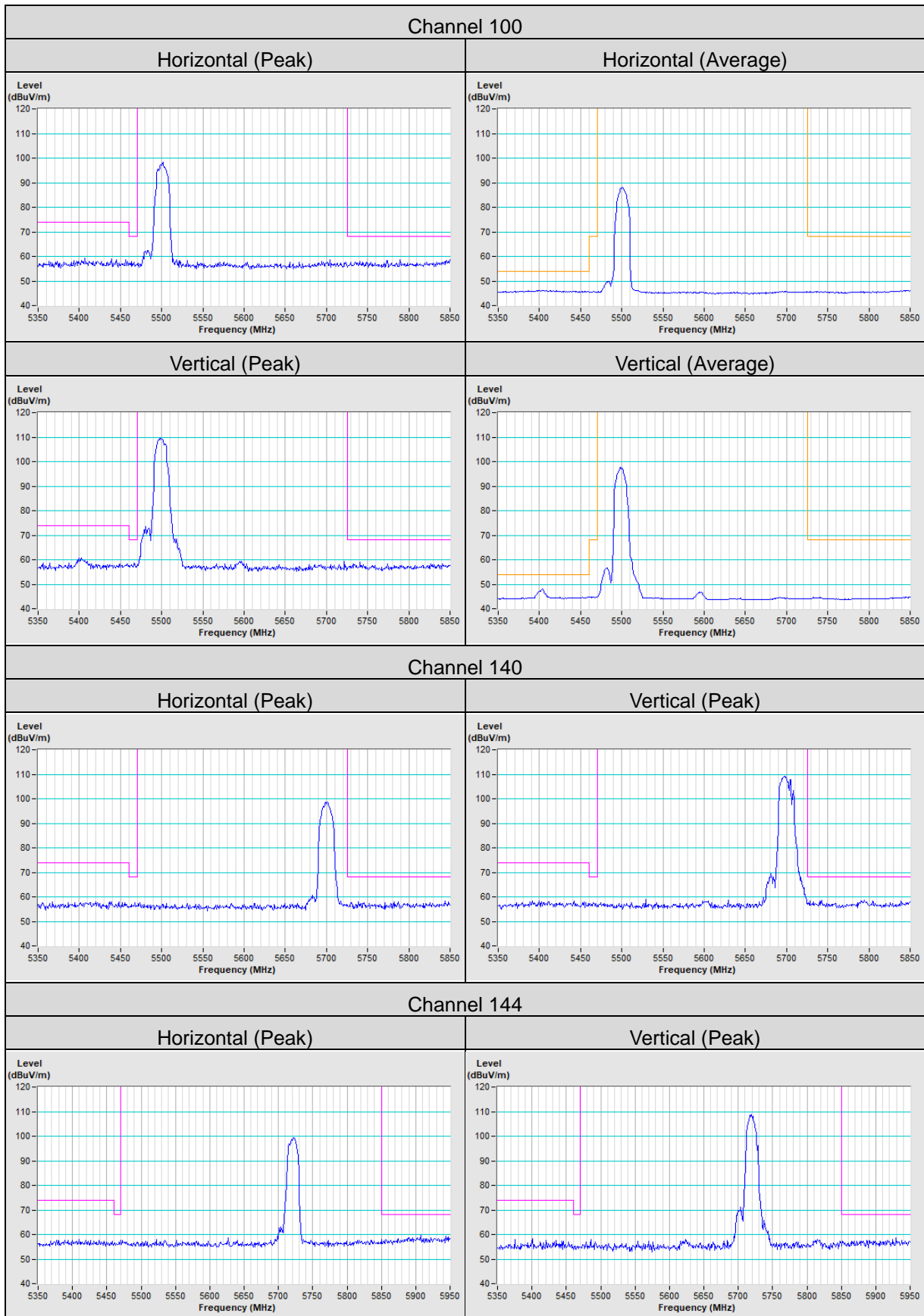

802.11ac (VHT40)

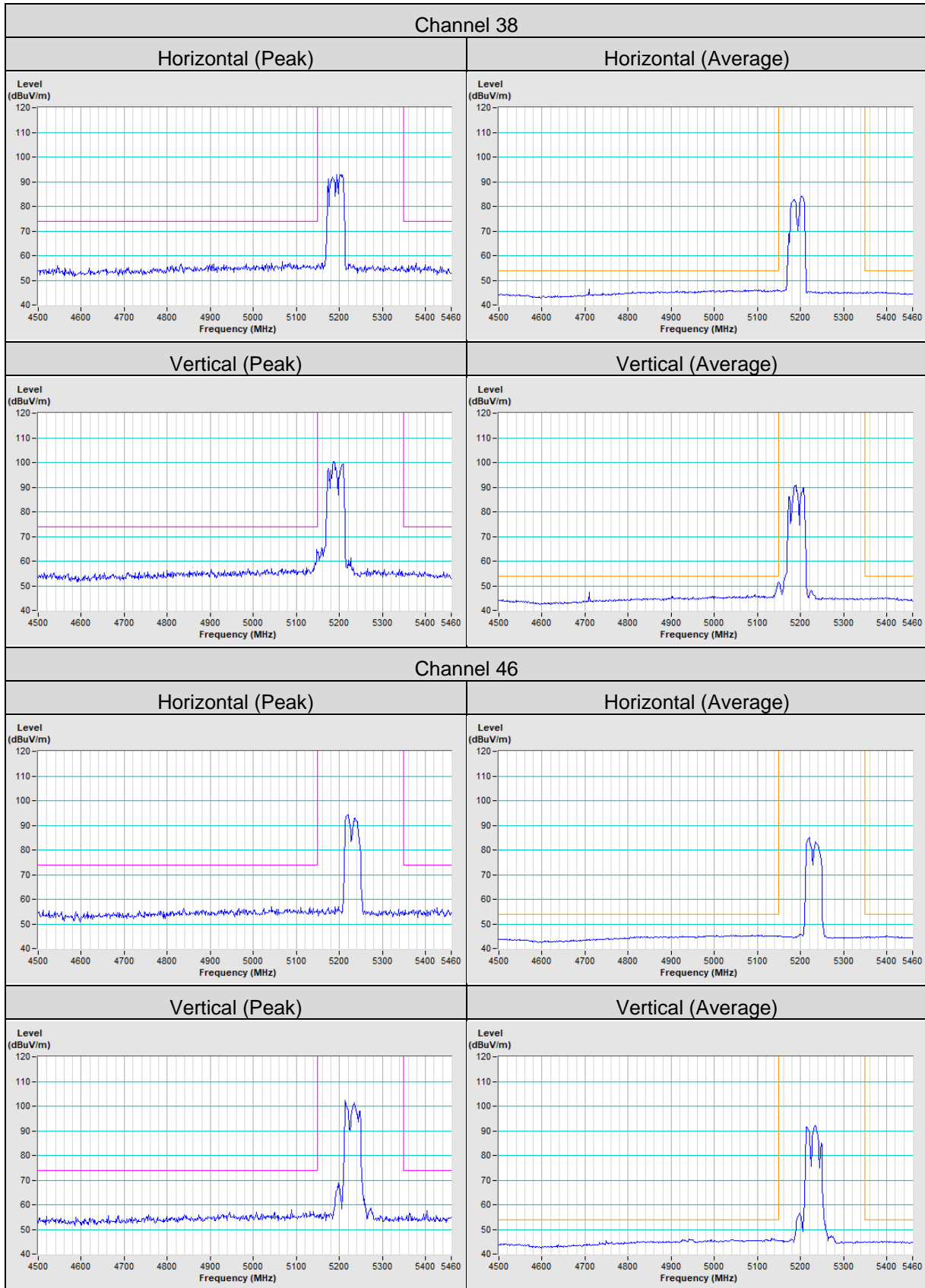

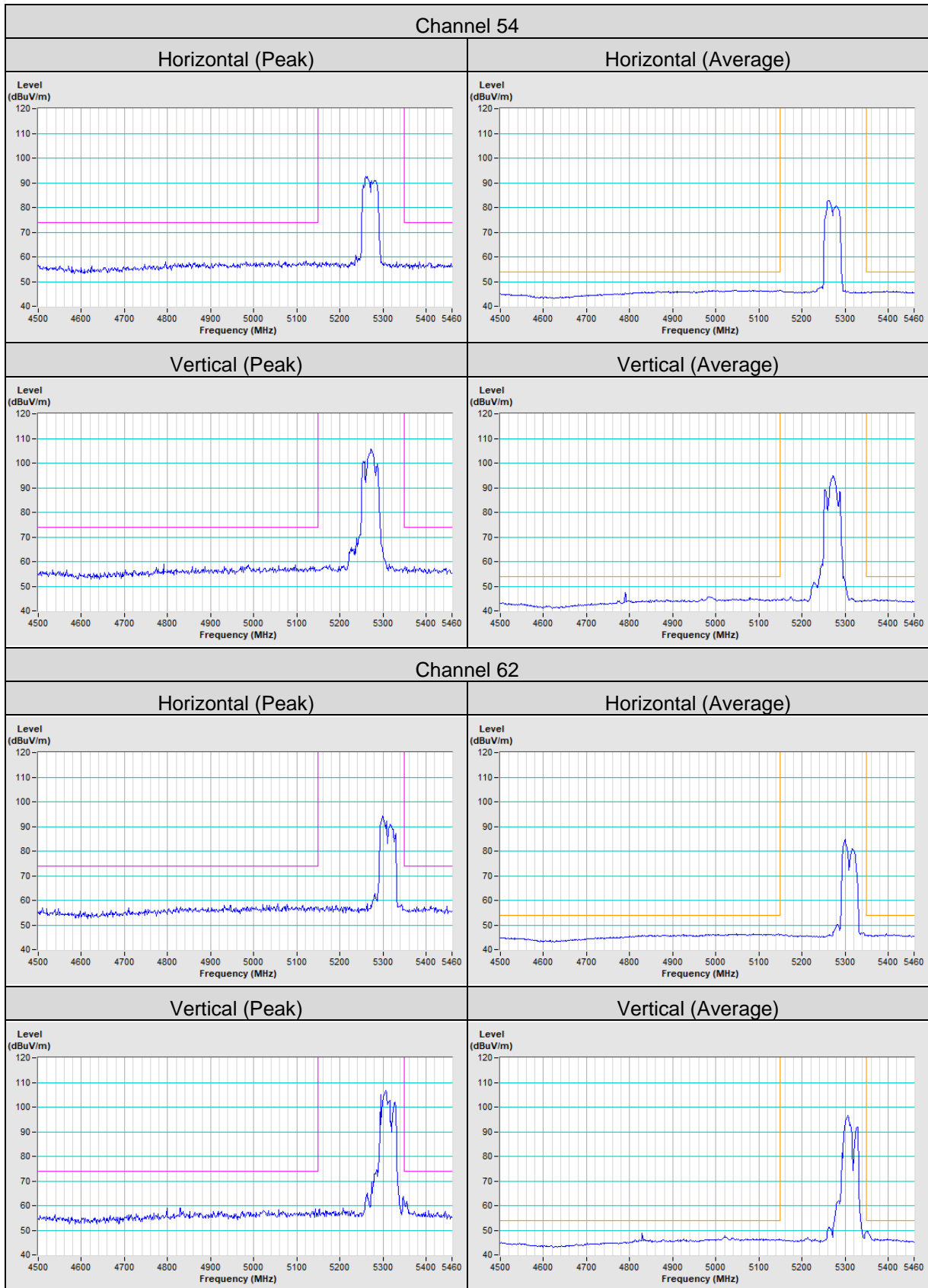

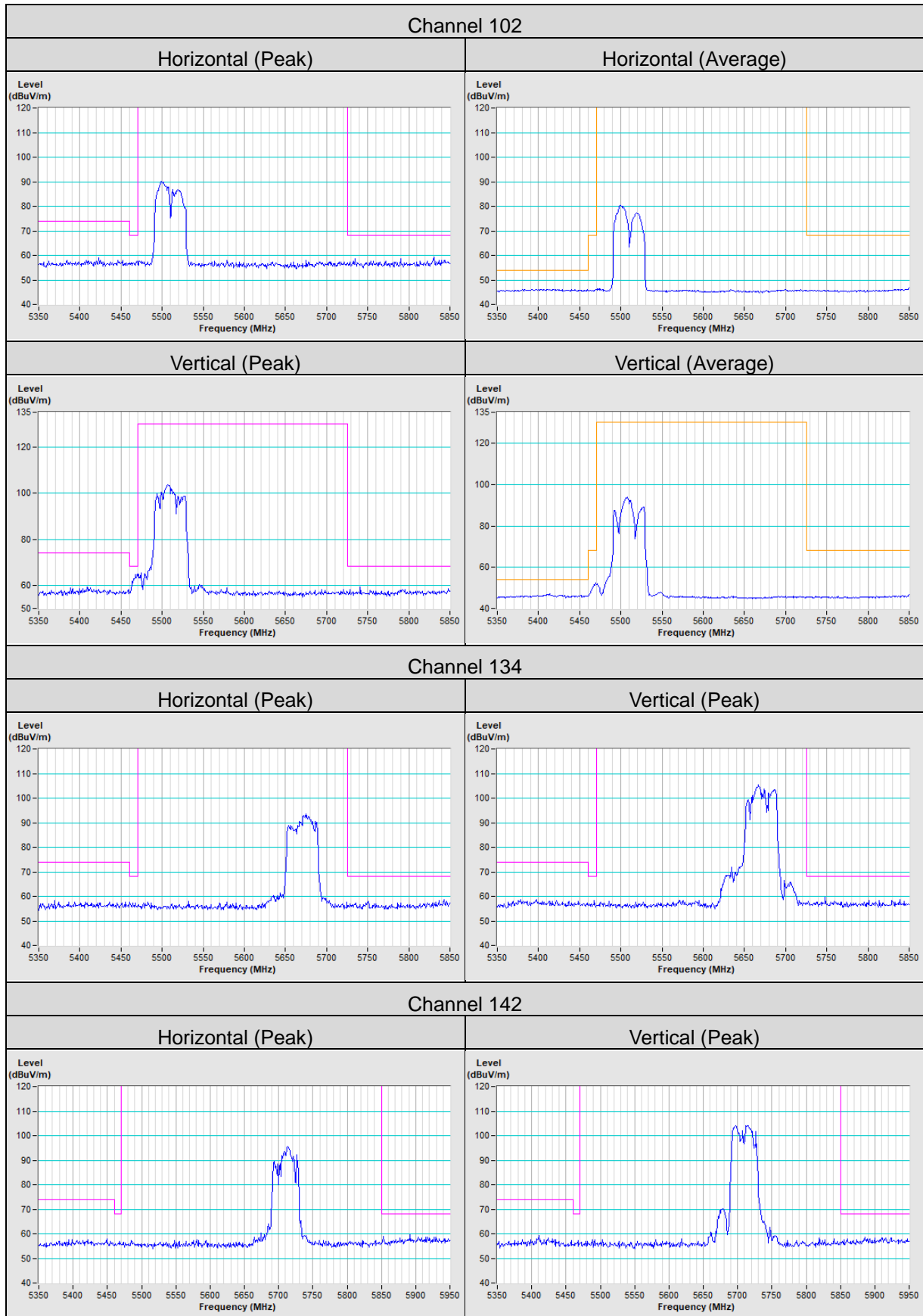

802.11ac (VHT80)

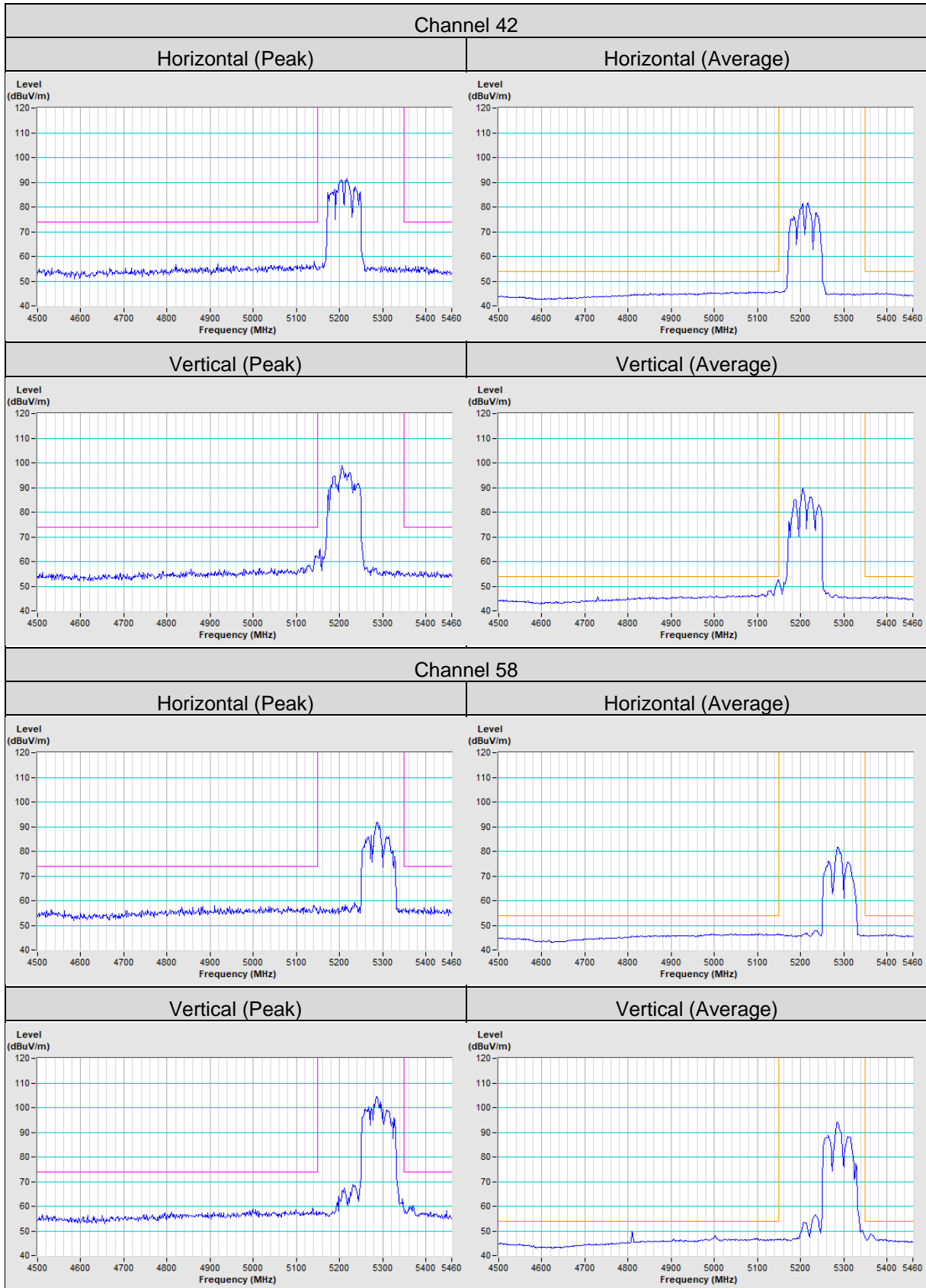

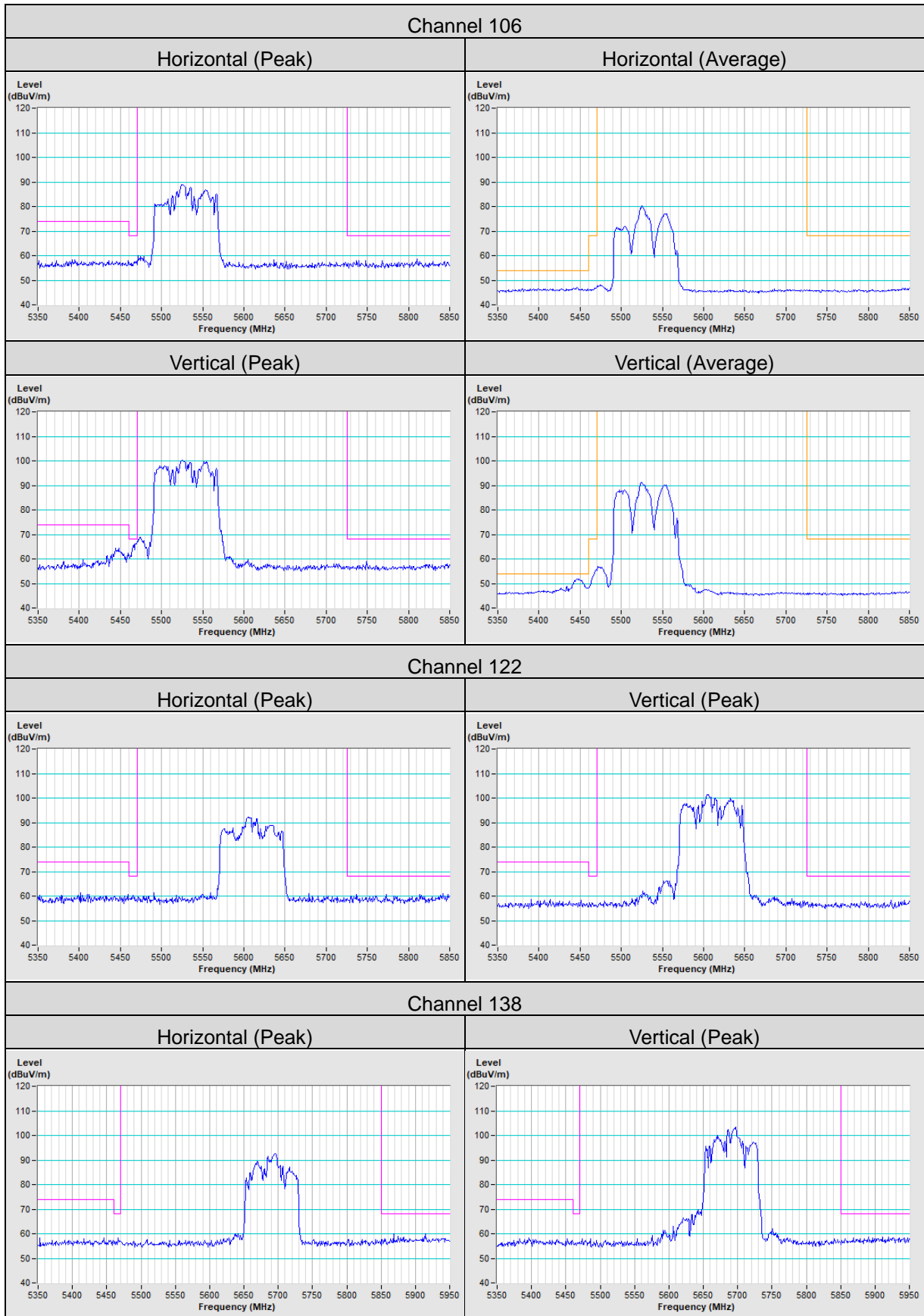

Mode B

802.11a

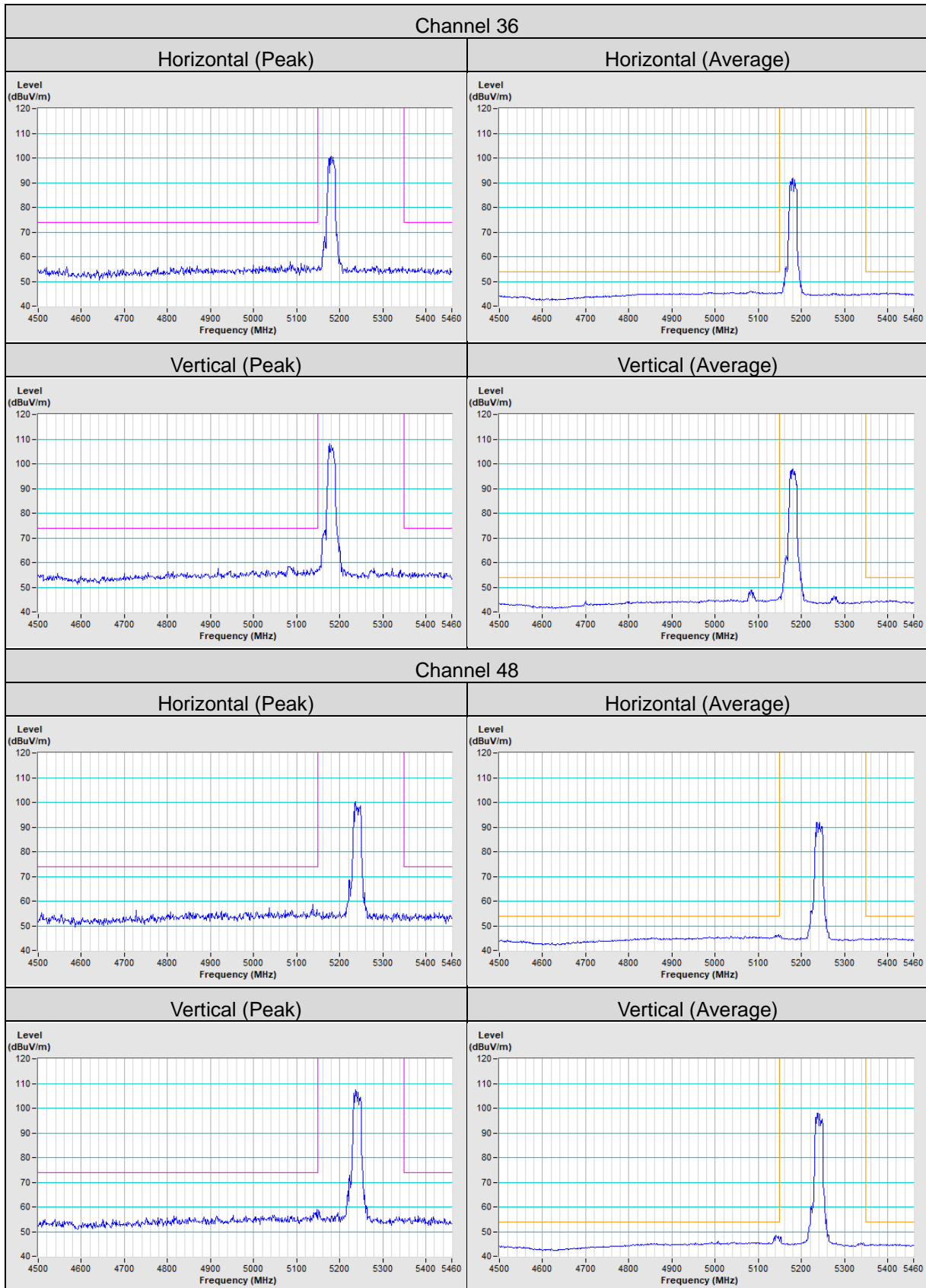

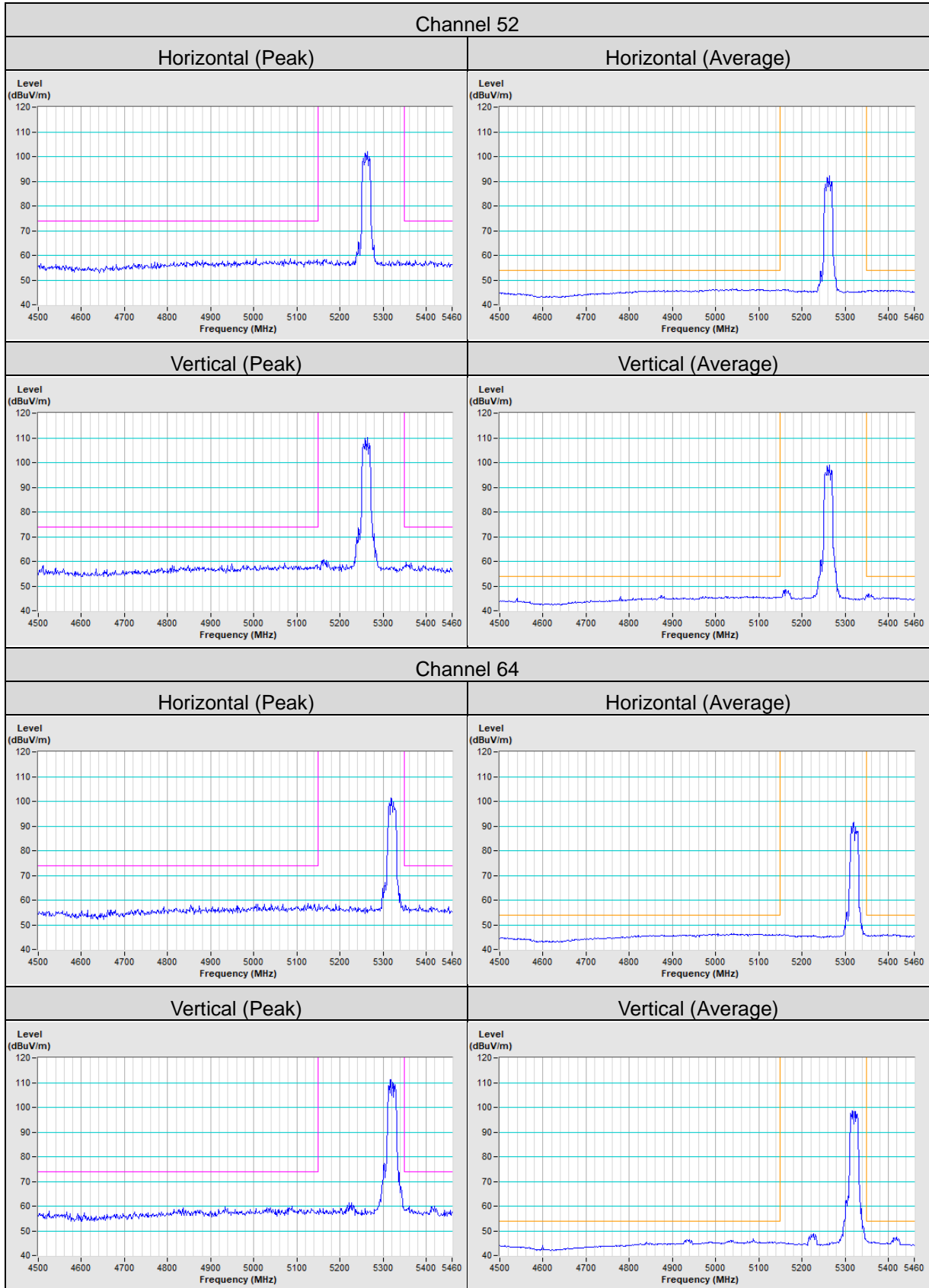

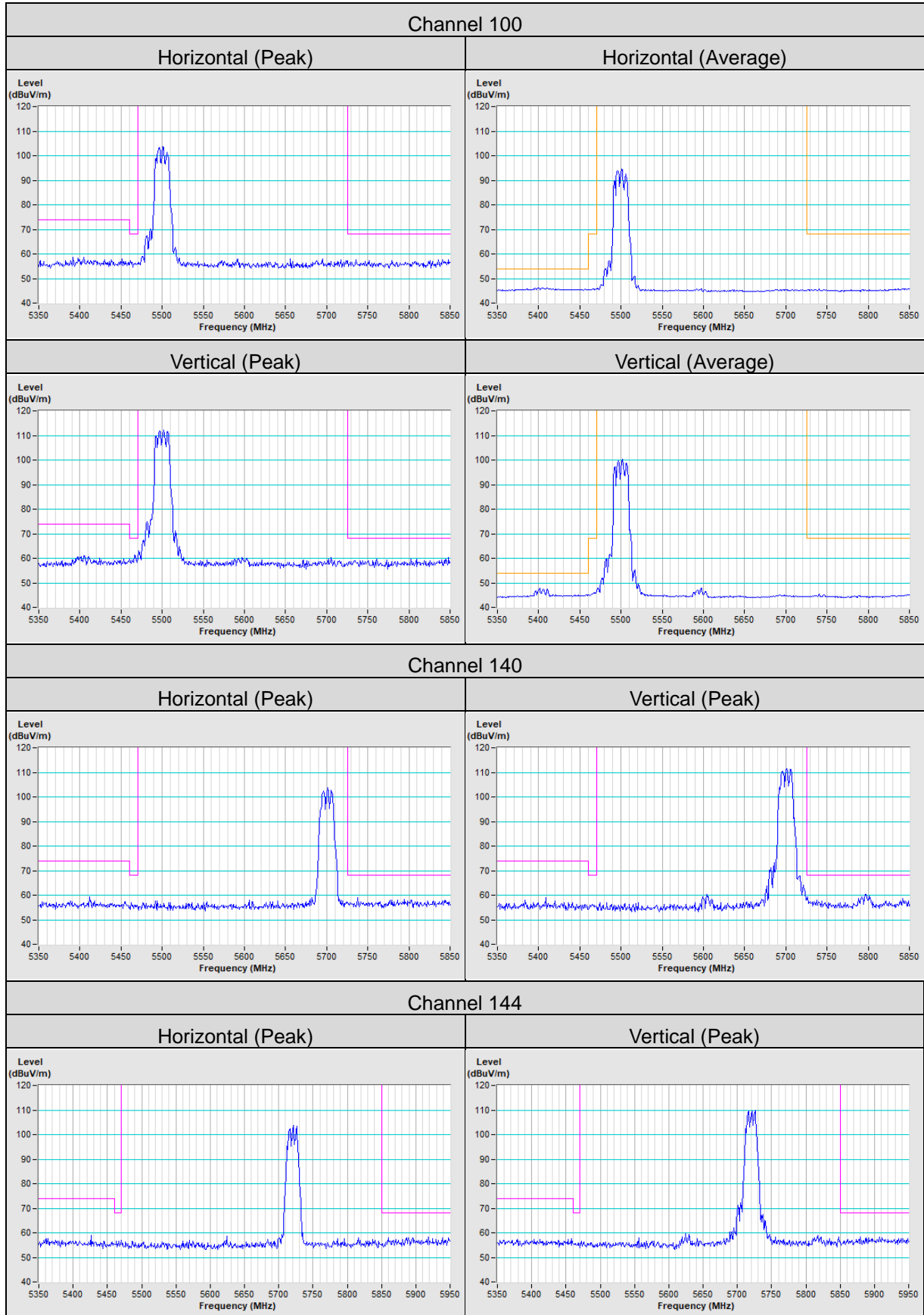

802.11ac (VHT20)

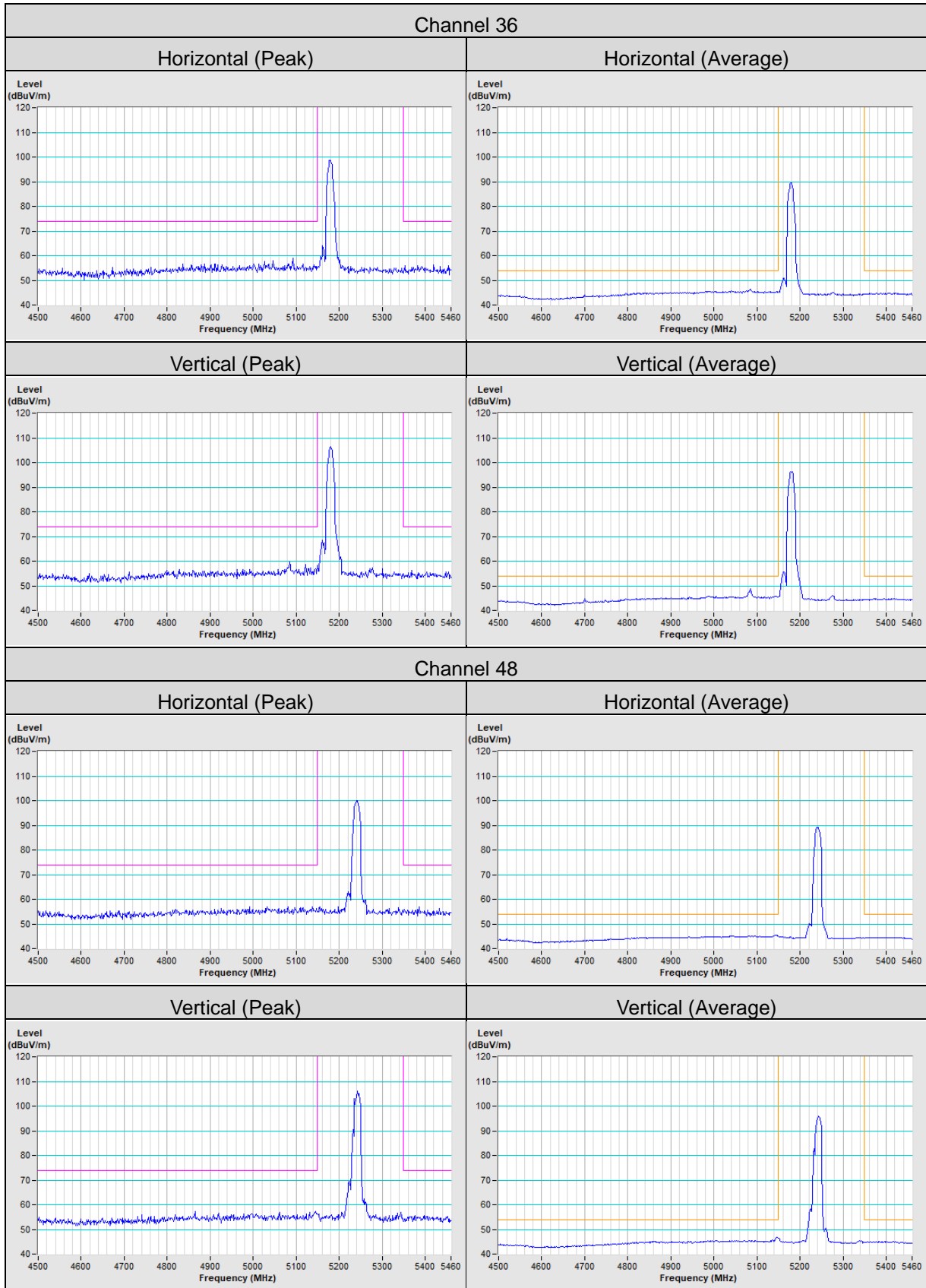

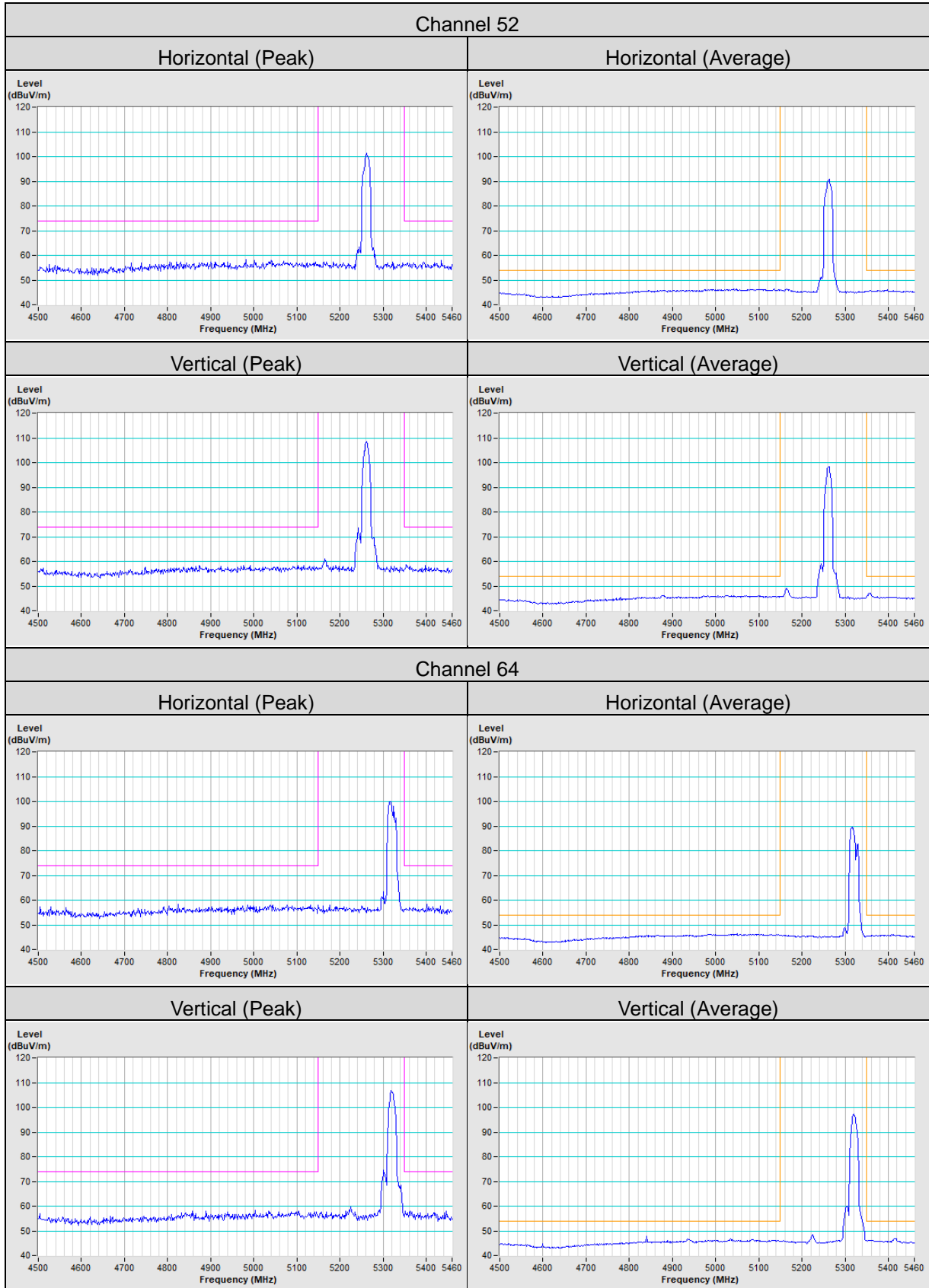

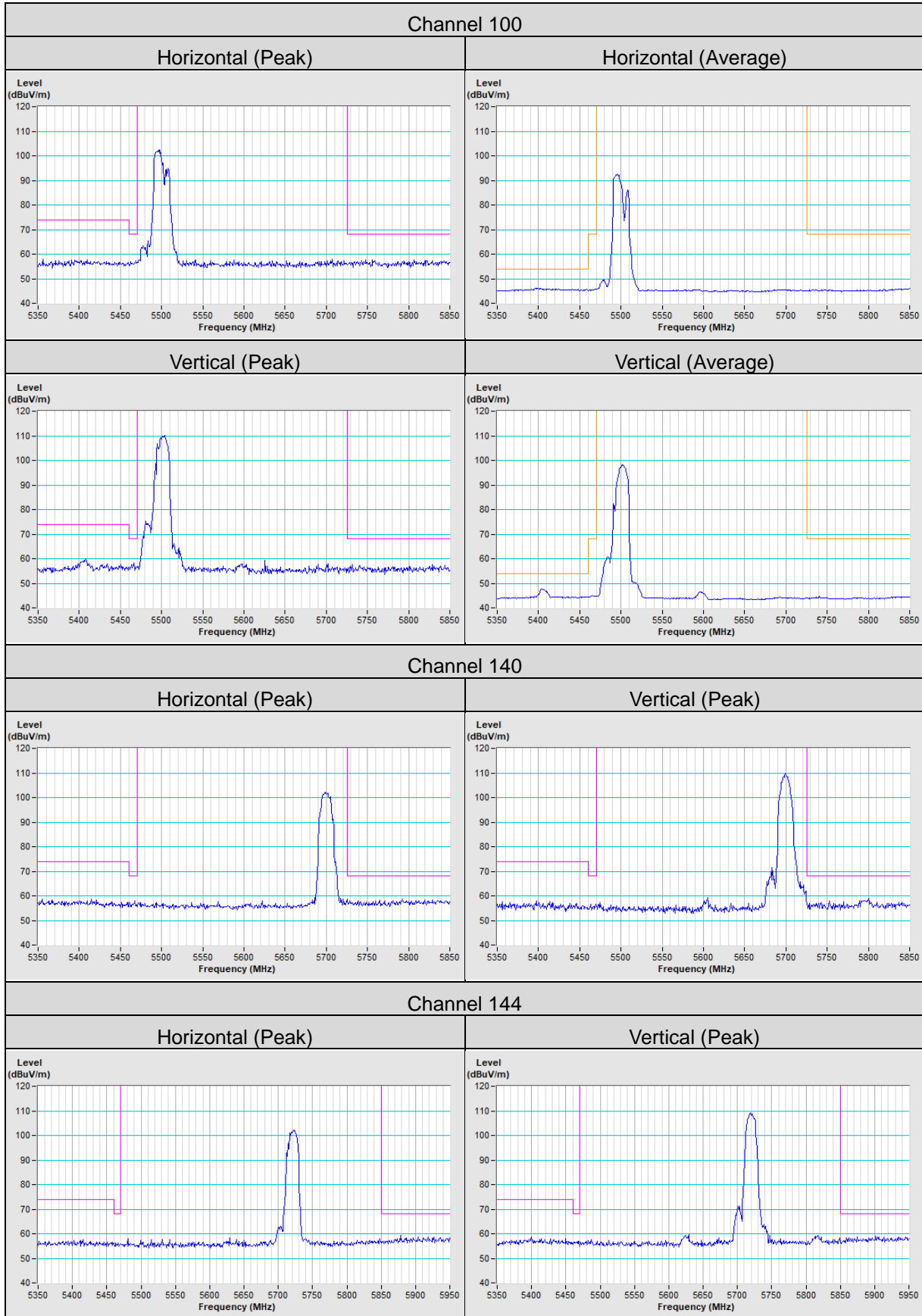

802.11ac (VHT40)

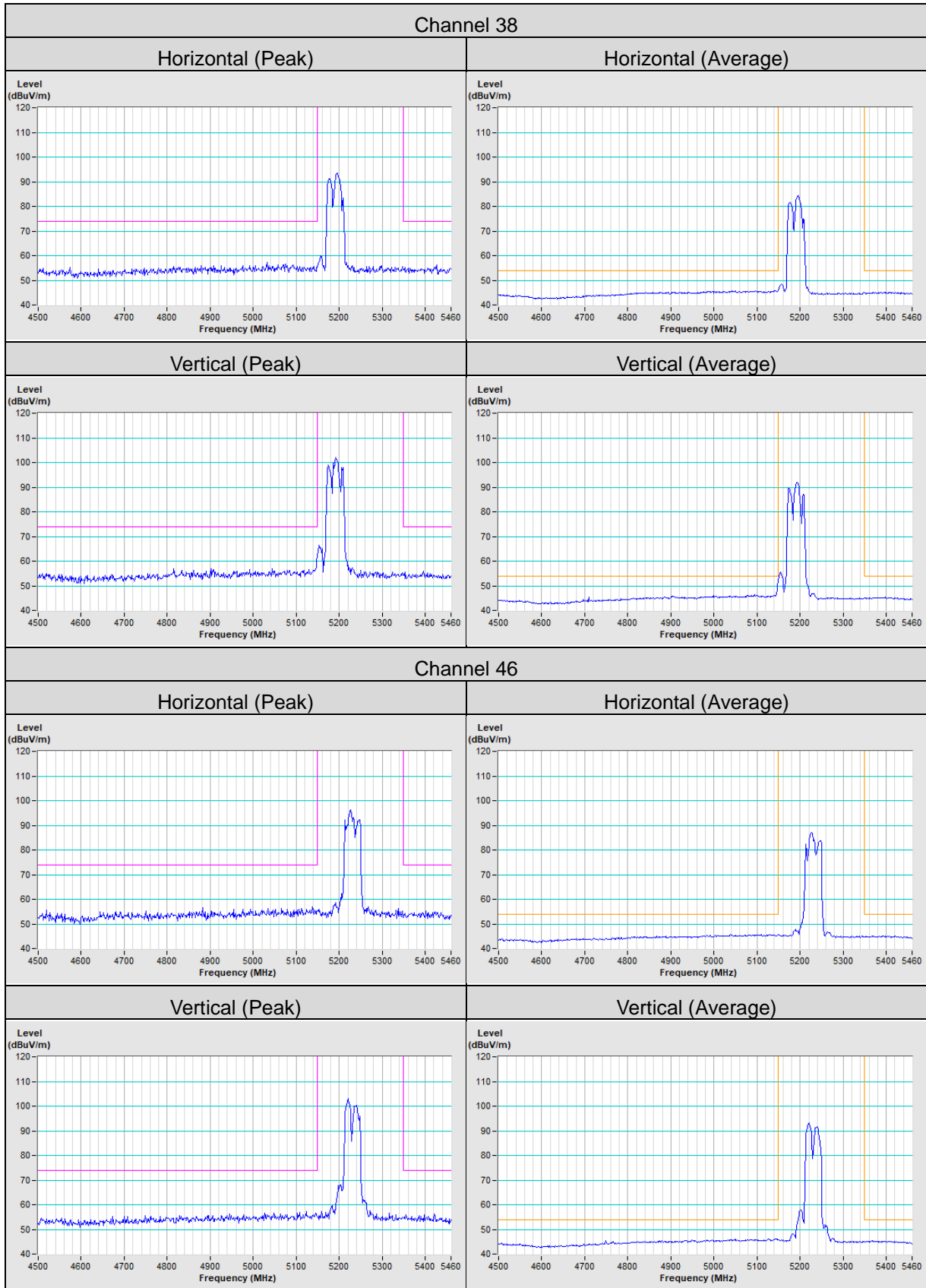

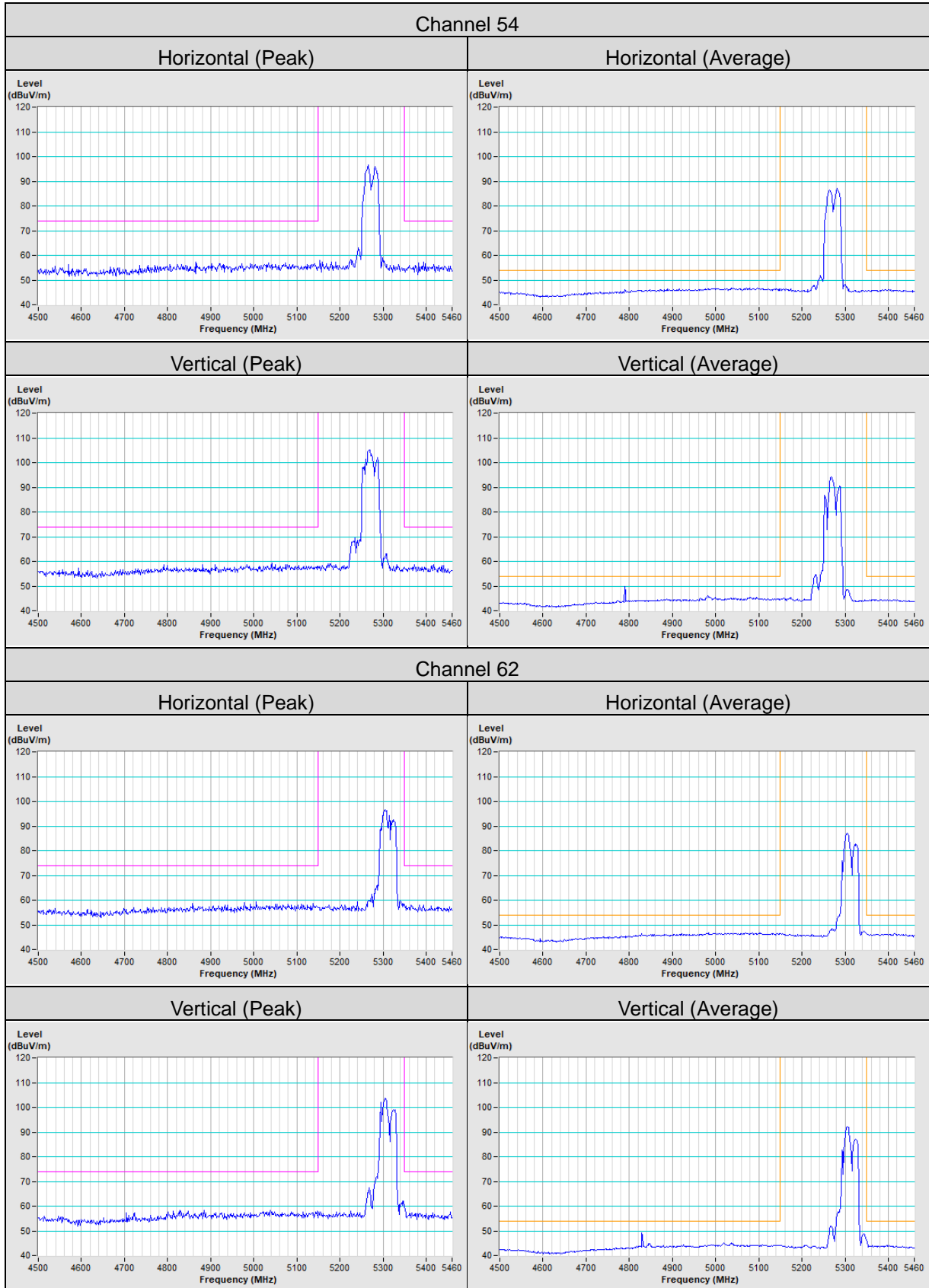

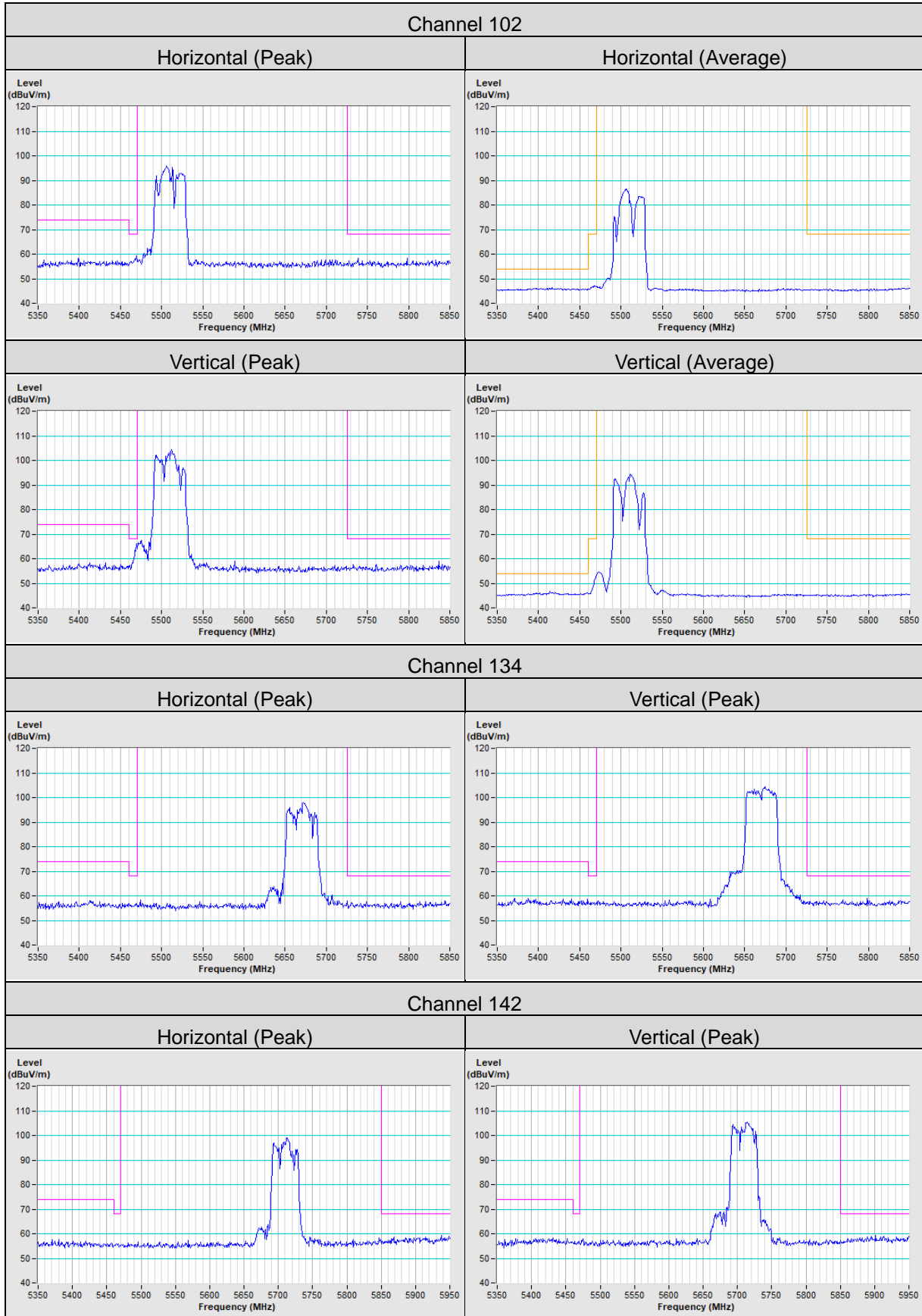

802.11ac (VHT80)

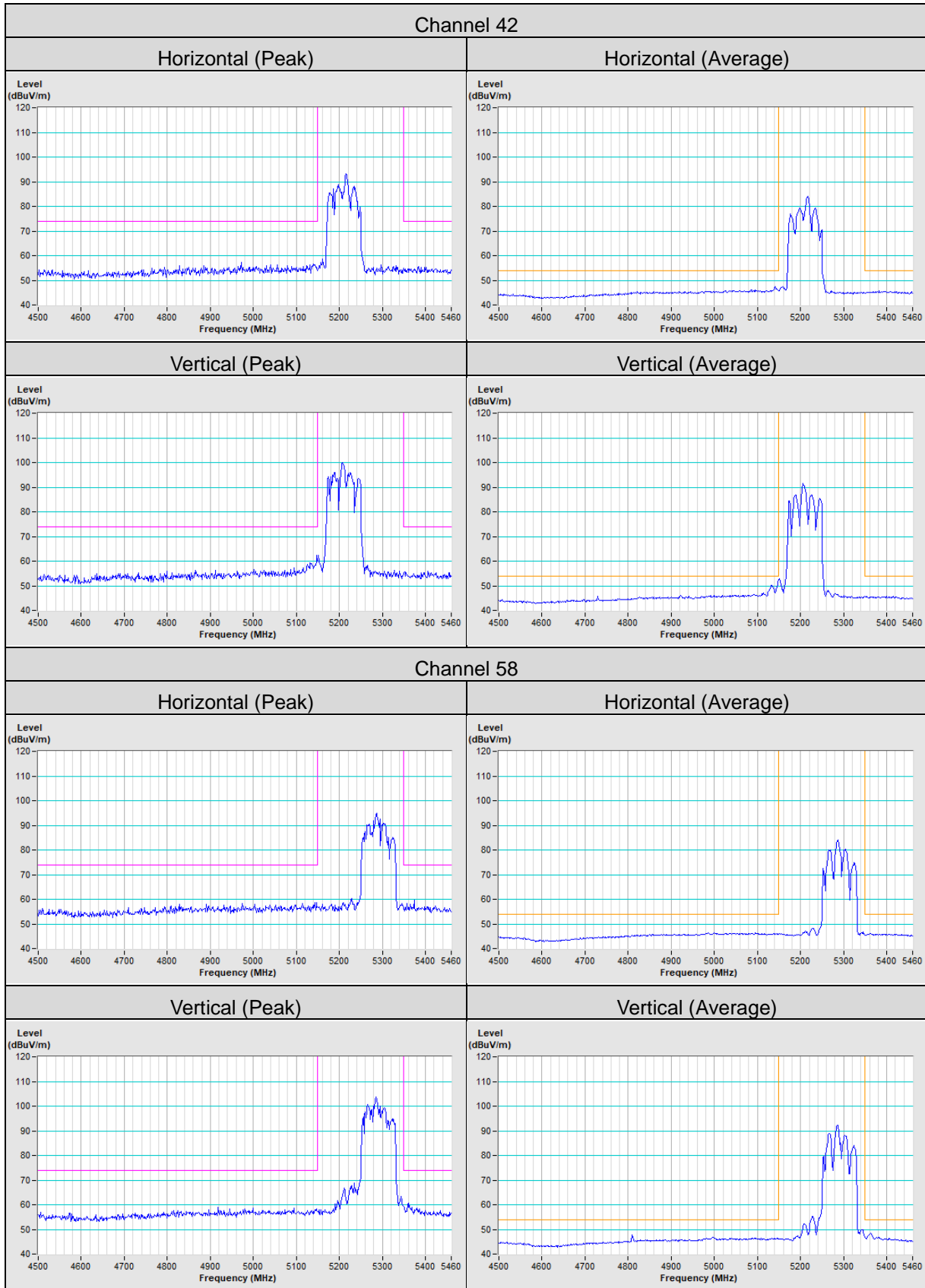

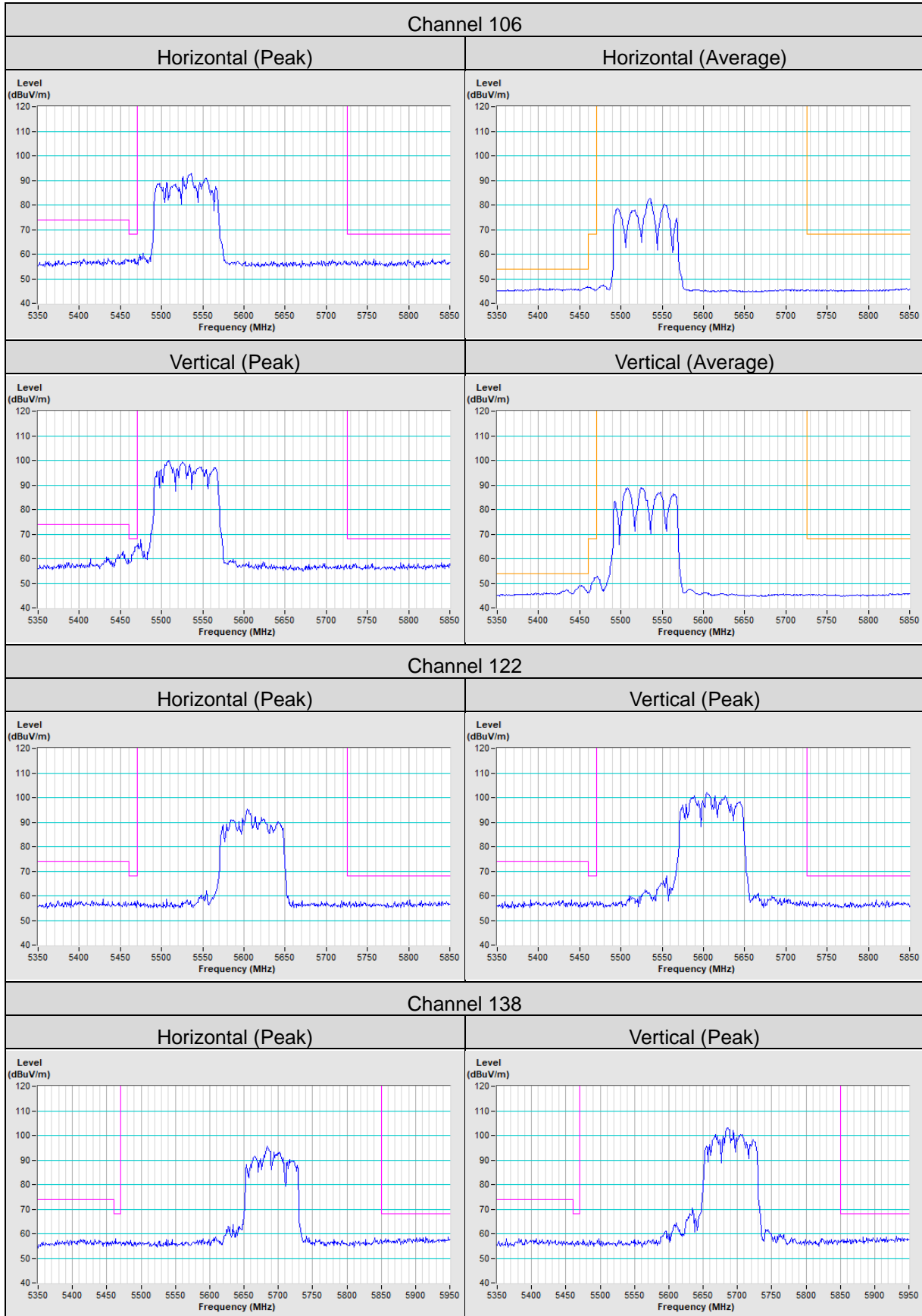

Appendix – Information of the Testing Laboratories

We, Bureau Veritas Consumer Products Services (H.K.) Ltd., Taoyuan Branch, were founded in 1988 to provide our best service in EMC, Radio, Telecom and Safety consultation. Our laboratories are FCC recognized accredited test firms and accredited according to ISO/IEC 17025.

If you have any comments, please feel free to contact us at the following:

Lin Kou EMC/RF Lab

Tel: 886-2-26052180

Fax: 886-2-26051924

Hsin Chu EMC/RF/Telecom Lab

Tel: 886-3-6668565

Fax: 886-3-6668323

Hwa Ya EMC/RF/Safety Lab

Tel: 886-3-3183232

Fax: 886-3-3270892

Email: service.adt@tw.bureauveritas.com

Web Site: www.bureauveritas-adt.com

The address and road map of all our labs can be found in our web site also.

--- END ---