

Installation and Operations Manual

7GHz Truck Coder II System

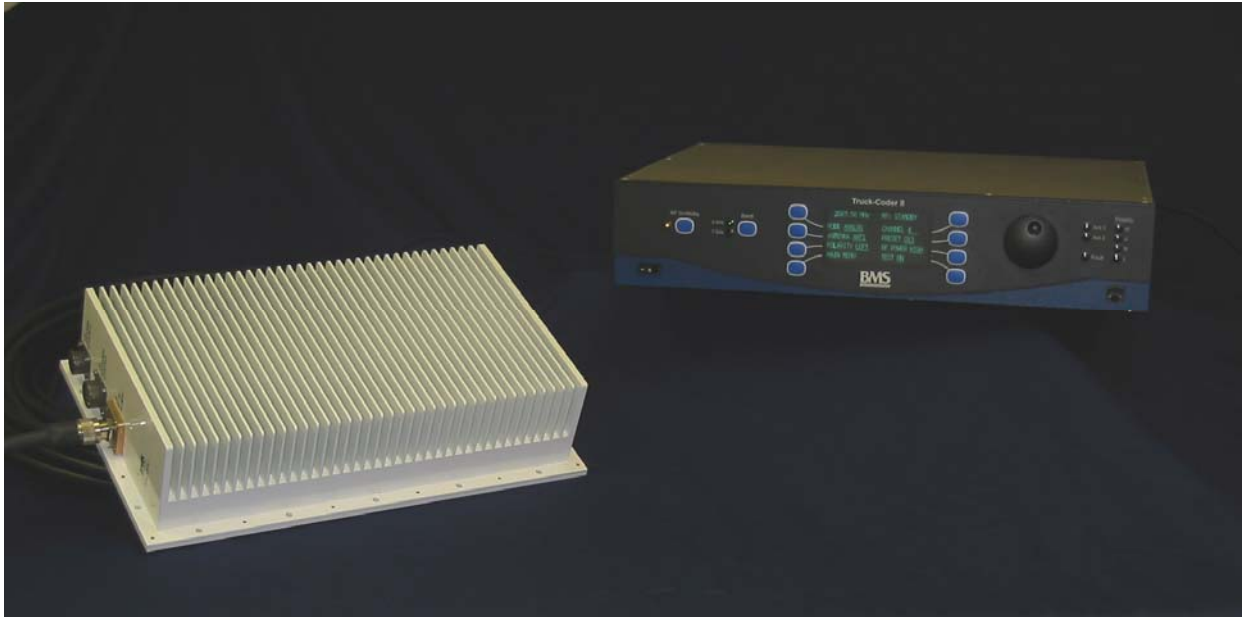

DOC# 6051419100X3

July 2006



Broadcast Microwave Services, Inc.
12367 Crosthwaite Circle
Poway, CA 92064

800-669-9667, 858-391-3050
858-391-3049 FAX

This Page Intentionally Left Blank

INTRODUCTION

The BMS Truck-Coder II (TCII) is an ENG transmitter that operates in both digital (COFDM) and legacy analog (FM) transmission modes. It features a DVB-T compliant (COFDM) modulator MPEG2 video encoder. The system is designed to support both 12 MHz and 17 MHz BAS channel plans (in both Digital and FM transmission modes). The two-unit system consists of an Indoor rack-mounted exciter Unit (IDU) and an Outdoor mast-mounted RF Transmitter Unit (ODU). An optional second RF unit can be added to support dual band operation. The system integrates support for mast mounted antenna relay, feed controls and other accessories. The indoor unit provides support for multiple analog and video signal formats and provides an industry standard 70MHz IF output.

The Truck-Coder II is designed to meet the rugged environmental needs of ENG news vehicles. It blends our field proven technology with a rich feature set and the simple operation needed for ENG/OB operations.

Applications:

- ENG News Vehicles
- Law Enforcement Command Posts

Key Features:

- Digital (COFDM) and Analog (FM) Transmission
- Ease of installation – a single coax cable interconnects the IDU and ODU
- Simple Set-up and Operation – menu driven user interface
- Up to 999 easily configurable user Presets (each capable of storing all system parameters)
- Front panel Ethernet Port simplifies firmware upgrades and supports web based management
- Fully configurable FM, COFDM and MPEG parameters (including PID's) ensure product compatibility
- Optional Dual Band Capability

This document provides instructions for the installation, operation and maintenance of the Truck Coder II system.

Broadcast Microwave Services (BMS) is a leader in wireless digital microwave technology providing innovative products for the television broadcast, video, telemetry and surveillance industries. A wholly owned subsidiary of Cohu, Inc., BMS designs and manufactures a comprehensive line of microwave communications equipment for broadcasting sports venues, law enforcement and military applications. BMS also builds and integrates command and control centers to provide fully functioning, complex, end to end digital systems.

For the latest product and system information please visit www.bms-inc.com.

Broadcast Microwave Services, Inc.
12367 Crosthwaite Circle
Poway, CA 92064

Tel: +1 (858) 391-3050
Toll free (US): 800-669-9667
Fax: +1 (858) 391-3049
Email: sales@bms-inc.com
Web: www.bms-inc.com

This Page Intentionally Left Blank

Table of Contents

INTRODUCTION.....	i
SYSTEM DESCRIPTION.....	1
Overview.....	1
Indoor Unit.....	2
Outdoor Unit.....	4
Technical Specifications.....	5
UNPACKING.....	9
Parts List.....	9
Manuals.....	9
Components.....	9
Cables.....	9
INSTALLATION.....	11
Equipment Installation.....	11
Installing the Indoor Unit (IDU).....	15
Indoor Unit (IDU) Connections.....	17
Installing the Outdoor Unit (ODU).....	18
OPERATION.....	22
Initialization.....	22
WARRANTY.....	25
Customer Service Information.....	25
TROUBLE SHOOTING.....	27
Diagnostics.....	28
PIN OUTS.....	30
IDU.....	30
ODU.....	32
US Broadcast Frequency Assignments.....	34
Coded Orthogonal Frequency Division Multiplex (COFDM) Modulation.....	36
Glossary.....	40

List of Figures

Figure 1 TCII System Overview.....	1
Figure 2 TCII IDU (Indoor Unit) Block Diagram.....	2
Figure 3 TCII Outdoor Unit (ODU) Block Diagram.....	4

Figure 4 IDU Footprint.....	13
Figure 5 ODU Footprint	14
Figure 6 TCII Indoor Unit	15
Figure 7 TCII Indoor Unit Rear Panel Connections	17
Figure 8 TCII Outdoor Unit.....	18
Figure 9 ODU Mounting Footprint	19
Figure 10 ODU Mounting Orientation	20
Figure 11 ODU Connections	21
Figure 34 The HOME Menu	22
Figure 36 Product Label	25
Figure 37 IDU REAR PANEL CONNECTORS.....	30
Figure 38 ODU CONNECTORS	32

List of Tables

Table 1 General Specifications.....	5
Table 2 Analog (FM).....	6
Table 3 Digital (COFDM)	6
Table 4 TCII Input/Output.....	7
Table 5 Component Mounting Requirement Reference	11
Table 6 ODU Connections	21
Table 7 AUXILIARY INPUT PINOUTS	30
Table 8 SUMMARY ALARM PINOUTS	30
Table 9 AUDIO 1 IN PINOUTS	31
Table 10 AUDIO 2 IN PINOUTS	31
Table 11 J1 EXTERNAL DATA IN	32
Table 12 J2 EXTERNAL DC IN PIN OUTS (Optional)	32
Table 13 J4 ANTENNA CONTROL PIN OUTS.....	33
Table 14 ODU J5 EXTERNAL CONTROL PIN OUT.....	33

WARNING!

RF RADIATION EXPOSURE HAZARD

This warning is provided by Broadcast Microwave Services (BMS) Inc. for safety purpose. The following information help to reduce the risk of RF exposure hazard.

FCC Limit of RF Exposure

According to Federal Communication Commission (FCC), the Maximum Permissible Exposure (MPE) for FR radiation has been set to 1.0 mW/cm^2 for the 7GHz Truck-Coder II equipment (OET Bulletin 65).

The 7GHz Truck-Coder II is a non-broadcast transmitter and without an antenna it will not create RF exposure (power density) exceeding the 1.0 W/cm^2 FCC limit.

However a high-gain antenna such as a parabolic dish will greatly enhance the Field-Coder II output power density beyond the MPE limit of 1.0 mW/cm^2 .

In this situation a minimum distance from the antenna needs to be calculated in order to keep the MPE always below the safety limit. The calculation has been done for Field-Coder II based on the formula mentioned in OET Bulletin 56.

The calculations have been done for different commonly used antenna in Electronic New Gathering (ENG) systems.

Transmission

Figure 1 shows the plot of the minimum exposure distance for 0dBi, 5dBi, 16dBi, and 30dBi antennas. The 7GHz Truck-Coder II transmits the maximum power of 4 Watts. The minimum exposure distances are found from the cross points of the exposure graphs (for various antennas) with the line of maximum permissible exposure (i.e. 1 W/cm^2). Notice that the numbers in Figure 1 predict the worse case scenario, which is straight in front of the antenna (exposing to the antenna main-lobe). Obviously the side-lobe exposures are well below these numbers as the radiation intensity dramatically reduces on the side lobes. The antenna used for this transmitter must not be co-located or operating in conjunction with any other antenna or transmitter.

Antenna Specifications

The antenna for Truck-Coder II is customer's furnished equipment. The customer has a choice of using, for instance, a 0dBi Omni antenna or a 30dBi dish antenna. The plots of Figure 1 provide the exposure distance for 0dBi and 5dBi Omni antennas as well as 16dBi and 30dBi dish antennas.

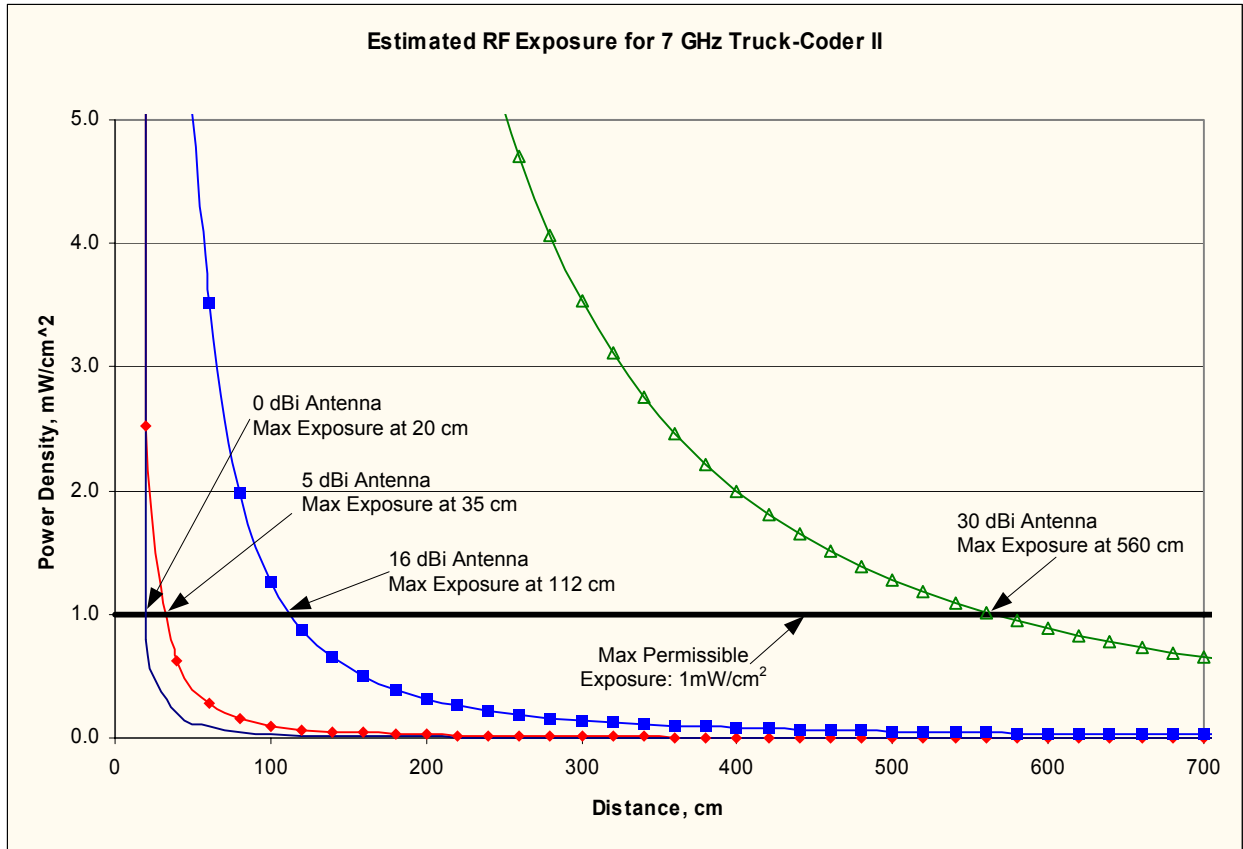

Figure 1

Summary

In order to keep the RF exposure within the FCC limit, it is necessary to maintain the safe distance from the antenna. The results shown in Figures 1 can be summarized in the following table:

Antenna Gain (dBi)	Minimum permissible distance from antenna (cm)
0	20
5	35
16	112
30	560

Notice the above table indicates worst-case situation (straight in front of the antenna).

SYSTEM DESCRIPTION

Overview

The Truck-Coder II (TCII) is an ENG transmitter that will operate in both Digital (COFDM) and Analog (FM) modes. The system comprises of an indoor unit (Exciter) and a mast mounted outdoor unit (RF transmitter).

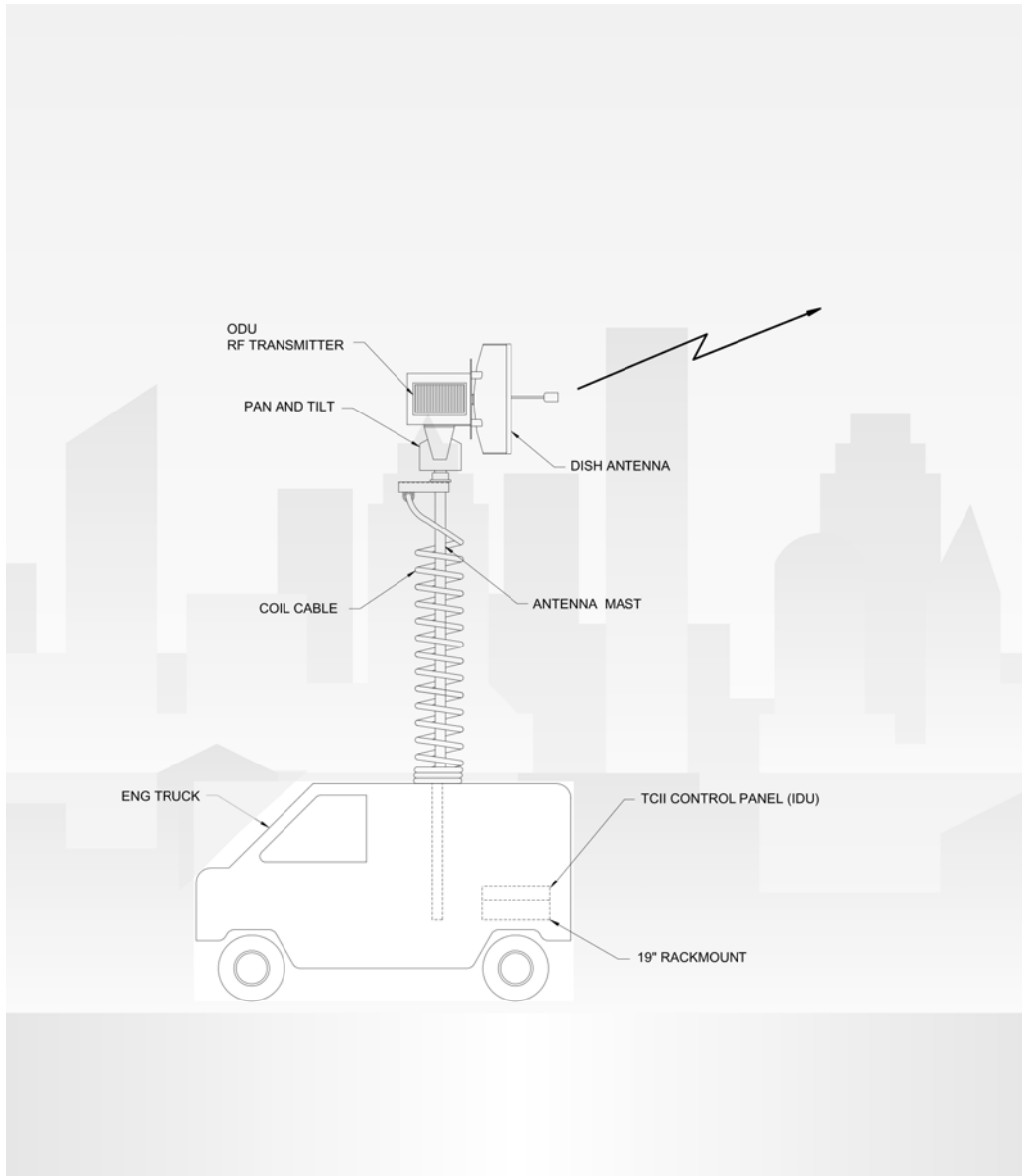

Figure 1 TCII System Overview

The indoor unit is designed to be rack mounted within an ENG van. It is housed in a 2RU 19-inch rack mount enclosure and powered from a conventional 120V AC source. The indoor unit contains full featured DVB-T compliant Digital (COFDM) and Analog (FM) exciters and associated power supplies. The IDU provides the necessary DC voltage to power the ODU.

To simplify installation, only a single coaxial cable is required to interconnect the IDU to the ODU; DC power, 70MHz IF and telemetry signals are all multiplexed onto this single cable. The system also supports legacy cable systems that feed DC power on separate conductors.

The indoor unit features a menu driven front panel display (vacuum fluorescent) that is used to configure the equipment and monitor its performance. The system is also designed to support remote control by 3rd party equipment using either web based or simple RS232 protocol.

The outdoor RF unit (ODU) is designed to be mounted outdoors adjacent to the antenna. The ODU translates the 70MHz IF signal from the IDU (exciter) to the desired operating frequency and amplifies the signal to the desired level. The RF unit employs automatic level control circuits that keep the system operating optimally and eliminate the need for any user adjustments.

The ODU uses a common signal path for both Analog (FM) and digital (COFDM) operation. Performance is automatically optimized for both methods. BMS transmitters feature superior COFDM performance that is adequate to support split channel operation in a 12MHz channel (*see BMS white paper*).

The ODU provides signals to control an antenna relay and feed polarity. Additional contact closures are also provided for user specific applications.

A more detailed description follows:

Indoor Unit

A simplified block diagram of the IDU is shown below:

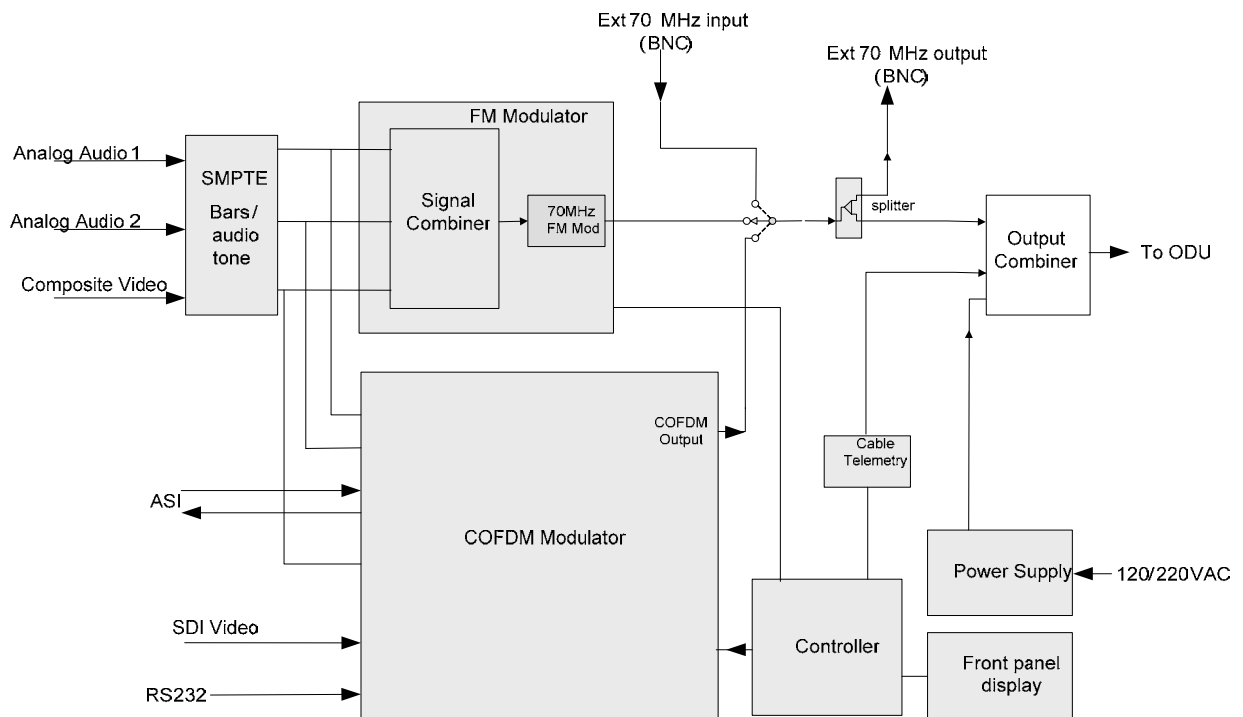

TruckCoder II (Indoor Unit)

Figure 2 TCII IDU (Indoor Unit) Block Diagram

The FM modulator is designed to accept analog audio and video inputs. Support for 2 audio channels is provided via frequency programmable sub carriers that ride above the video signal. The frequency deviation is user configurable to support operation in either a 17 MHz or 12 MHz channel allowing Analog operation to continue after the channel plan transition is complete. Analog transmission offers a more graceful degradation in performance and might be preferred under certain conditions.

The Digital (COFDM) modulator also supports 2 analog audio and one analog video input but also supports advanced digital interfaces (ASI, SDI) as well. The digital modulator includes an MPEG2 encoder and a DVB-T compliant COFDM modulator. Both MPEG and COFDM parameters are fully configurable by the system controller in support of optimum performance and compatibility with other vendors equipment. For those users less familiar with detailed COFDM and MPEG settings, the equipment provides 3 preset robustness settings (low, mid and high) that each optimize video performance at the expense of modulation complexity. High robustness provides the lowest quality video but is able to operate in severely compromised locations. Low robustness provides the best quality video but may require a clear line of sight shot.

An integrated SMPTE color bar generator with programmable text overlay is included. The indoor unit features a menu driven VFD front panel display. Two levels of user access are supported; Operator and Engineer. Operator is designed for non-technical users and assumes that the equipment has been preconfigured by a station engineer. Engineer has full access to all menus and the ability to set up the equipment for a less qualified operator.

The system accommodates up to 999 user programmable presets. These can be uniquely named and configured; each preset records all of the configurable variables within the system. Presets 1 thru 6 are conveniently displayed on their own screen for quick and easy recall. All presets can be uniquely named via the front panel menu system to simplify identification and can be recalled quickly to put the equipment in a known state. Presets are an ideal mechanism for the station engineer to pre-configure the equipment for simplified operation by a less skilled operator.

The system also features a front and rear panel ethernet interface that can be conveniently used to upload new operating firmware into the unit. This interface supports high data transfer rates and simplifies the firmware upgrade process. This equipment makes extensive use of FPGA (field programmable gate array) and microprocessor controlled hardware. Ease of firmware upgrade helps ensure that the equipment is always kept up to date.

The TCII also includes embedded web based management that can be accessed with any PC using a web browser and connected to the front or rear panel Ethernet port. This interface supports all the front panel programmable features as well as others such as the ability to configure channel plans, and download preconfigured presets (duplicate equipment setups). The system can be controlled remotely via an RS232 control port as well; consult BMS for the protocol specification for this port.

Outdoor Unit

A simplified block diagram of the ODU is shown below:

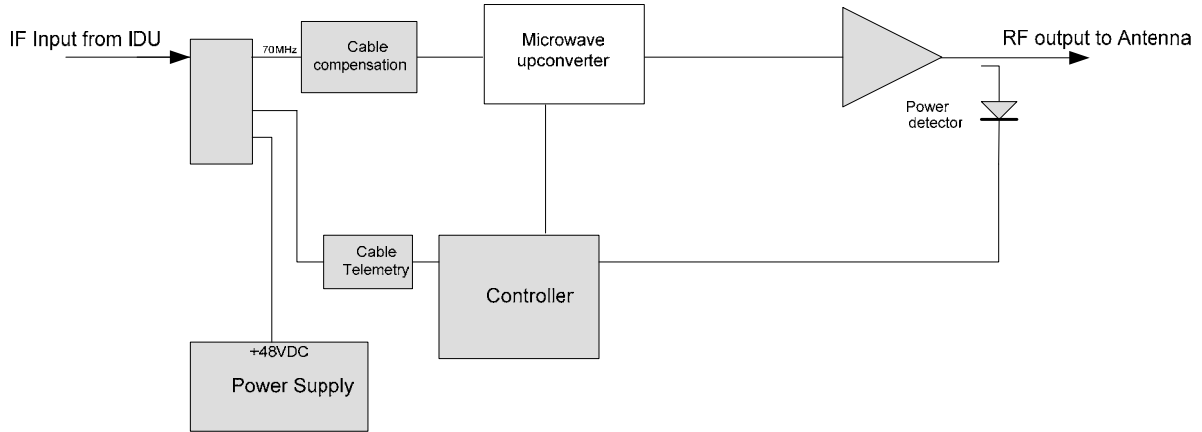

TCII Outdoor Unit

Figure 3 TCII Outdoor Unit (ODU) Block Diagram

The ODU is mounted outdoors and connected to the IDU by a single coaxial cable.

The ODU is in constant communication with the IDU via a telemetry channel that is frequency multiplexed onto the single cable interface between the IDU and ODU. This channel is used to configure the ODU (select frequency, power level etc) and also to monitor performance (PLL lock, temperature etc). A microcontroller within the ODU handles this communication and controls the respective parts of the ODU.

The 70MHz input is first up-converted to the UHF band and then up-converted again to the desired operating frequency. The signal is then amplified and fed to the antenna. A power detector at the transmitter output helps ensure that the transmitter always operates most efficiently which is particularly important when transmitting digital COFDM.

The ODU provides connector interfaces to support remote (mast mounted) antenna selection and antenna feed polarity selection. Four additional contact closures are also provided for user specific applications. These are controlled by corresponding inputs at the IDU.

A temperature sensor is included in the ODU and can be monitored on the IDU front panel. If the equipment is operated in extremely hot temperatures the ODU will automatically back off the output power to preserve operation and prevent damage to the unit.

Technical Specifications

Table 1 General Specifications

	Indoor Unit (IDU)	Outdoor Unit (ODU)
Size	17.5 x 14.9 x 3.5 in (44.1 x 37.8 x 8.9 cm)	15.0 x 3.7 x 9.0 in (38.1 x 22.9 x 9.2 cm)
Weight	11 lb (5 kg)	16.5 lb (7.5 kg)
Oper Altitude	15,000 ft	15,000 ft
Operating Temp	-20 - +55° C	-20 - +55° C
Stor. Temp	-30 - +70° C	-40 - +80° C
Relative Humidity	98% NC	100%
Power Req	105-260 VAC 50/60 Hz	48 VDC (supplied by IDU)
Ventilation Requirements	Fan inlet and outlets must have no obstruction	Fins must be oriented vertically on antenna mast

Specification		
Frequency	6.4 – 7.2 GHz (Pre-programmed with US 12 MHz and 17MHz BAS channel plans including offsets)	
Tuning Step Size	250KHz	
Frequency Stability	+/- 5ppm max	
Power Consumption	200W max	
Recommended IDU-ODU Cable	100ft max 50 or 75 Ω cable (selectable)	
Average Output Power (6.4 – 7.2 GHz)	FM	COFDM
	4 W (typical)	4 W (typical)

Table 2 Analog (FM)

Feature	Spec
Video	
Video Deviation (MHz)	4.0MHz pk /17 MHz Ch 3.5MHz pk /12 MHz Ch
Video Pre-Emphasis	405 (Per CCIR Recommendation)
VSNR (@12 MHz)	2 GHz 63 dB Typical (60 dB min.) 7 GHz 63 dB Typical (61 dB min)
Audio	
Audio Sub-Carriers (2)	Frequency (Programmable)
#1	4.83, 5.5, 5.8, 6.2, 6.8 MHz
#2	5.5, 5.8, 6.2, 6.8, 7.5 MHz
Audio Deviation	± 75kHz pk
Audio Pre-Emphasis	75 µS
Audio Distortion	1% max

Table 3 Digital (COFDM)

Feature	Spec
Bandwidth	6, 7, 8 MHz Selectable
Constellation	QPSK, 16 QAM, 64 QAM, Selectable
Guard	1/4, 1/8, 1/16, 1/32 Selectable
Code Rate	1/2, 2/3, 3/4, 5/6, 7/8 Selectable
Scrambler	Proprietary 6 digit PIN code
MPEG – 2 4:2:0 SP@ML	1.5 – 15 Mb/s, 0.1 Mb/s Resolution
MPEG – 2 4:2:2 SP@ML	1.5 – 32 Mb/s, 0.1 Mb/s Resolution
GOP Structure	I/IP/IBBP/422IBBP Variable
GOP Length	6/12/18/24 Selectable
Audio Sampling Rates	32, 64, 128, or 192 kb/s per Channel
Audio, Video, PCR PID	User programmable

Table 4 TCII Input/Output

I/O	Format
IF OUT (to ODU)	70 MHz IF Output with Control & Power (selectable 50 or 75 ohms)
IF IN	70 MHz (0dBm, 75 Ω)
Aux. IF OUT	70 MHz (0dBm, 75 Ω, BNC-f)
ASI IN	75 Ω (HD Capable)
ASI OUT	Encoder Output 75 Ω (BNC-f)
Digital Video IN	SDI w/Embedded Audio (SMPTE 259C CCIR 601)
Aux Inputs (4)	General purpose inputs that control respective Form 'C' contact closures available at the ODU.
Summary Alarm	Form 'C' Contact Closure (Rated 1A Max)

External Control ¹ (Remote Control Of TCII)	
Ethernet	10/100 bT

	Digital (COFDM)	Analog (FM)
Audio Inputs (2)	600 ohm Bal	
Impedance		
Level	+0 dB nom menu adj atten +4 to -9dB, in 1dB steps	+9dBm (Factory Set)
Composite Video Input	1V p-p 26dB min 75 ohms unbal	
Level		
Return loss		
Impedance		
YUV Video Input (Optional)	Optional	Not Available
RS232 (general purpose data channel to CRS-DCII)	User selectable 1200, 4800, 9600 baud	Not operational

¹ Consult Factory For Protocols

This Page Intentionally Left Blank

UNPACKING

No special instruction is required for removing the items from the packaging other than to open the box with care as to not damage any of the contents.

Parts List

Manuals

Item	Part Number	Quantity
TRUCK-CODER II INSTALLATION AND OPERATION MANUAL	6051419100	1

Components

Item	Part Number	Quantity
Indoor Unit (IDU)	8014191000	1
Outdoor Unit (ODU)	8014192700	1
Installation Kit	7614191020	1

Cables

The versatile design of the TCII makes it suitable for many different applications. Depending on the needs of the ENG, there is a great variety of cable configurations. The table below provides a list of all the cables that the TCII can accommodate and along with the BMS part numbers. The specific cable set for any application is defined when an order is placed. Please refer to the packing list and/or the original sale order for the specific cables included with your TCII System.

Cable	Recommended Cable P/N	Length	End Connector P/N
70 MHz/ 48 VDC (to ODU)	TIMES SF-214 (STANDARD)	100 ft (30.5 m)	210009800
70 MHz/ 48 VDC triax (to ODU)	Belden 8232	100 ft (30.5 m)	210071813
70 MHz IN	600001300	100 ft (30.5 m)	210015200
70 MHz OUT		100 ft (30.5 m)	
SDI IN w/ AUDIO		100 ft (30.5 m)	
ASI IN		100 ft (30.5 m)	
ASI OUT		100 ft (30.5 m)	
VIDEO IN		100 ft (30.5 m)	
VIDEO OUT		100 ft (30.5 m)	
Y,U, V input		100 ft (30.5 m)	
AUDIO 1 IN		600000100	
AUDIO 2 IN	100 ft (30.5 m)		
RS-232 DCE	Custom	100 ft (30.5 m)	210022000
RS-232 CONTROL		100 ft (30.5 m)	
RS-232 AUX DATA		100 ft (30.5 m)	

This Page Intentionally Left Blank

INSTALLATION

NOTE:

The TCII equipment installation should only be performed by qualified technicians in compliance with safety regulations and accepted industry practices.

Equipment Installation

The following equipment will need to be installed:

Indoor Unit (IDU)

Outdoor Unit (ODU)

Please refer to component footprint drawings listed in Table 5 to aid installation.

Table 5 Component Mounting Requirement Reference

Component	Footprint
Indoor Unit (IDU)	Figure 4
Outdoor Unit (ODU)	Figure 5

This Page Intentionally Left Blank

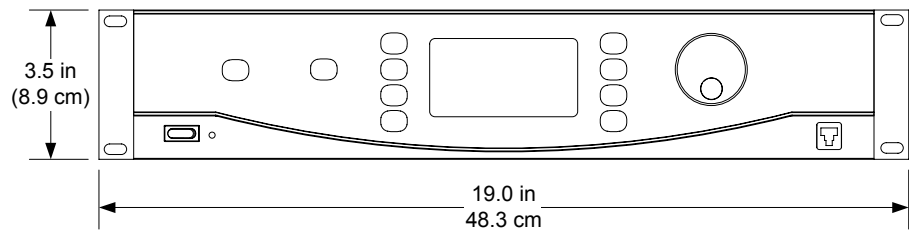
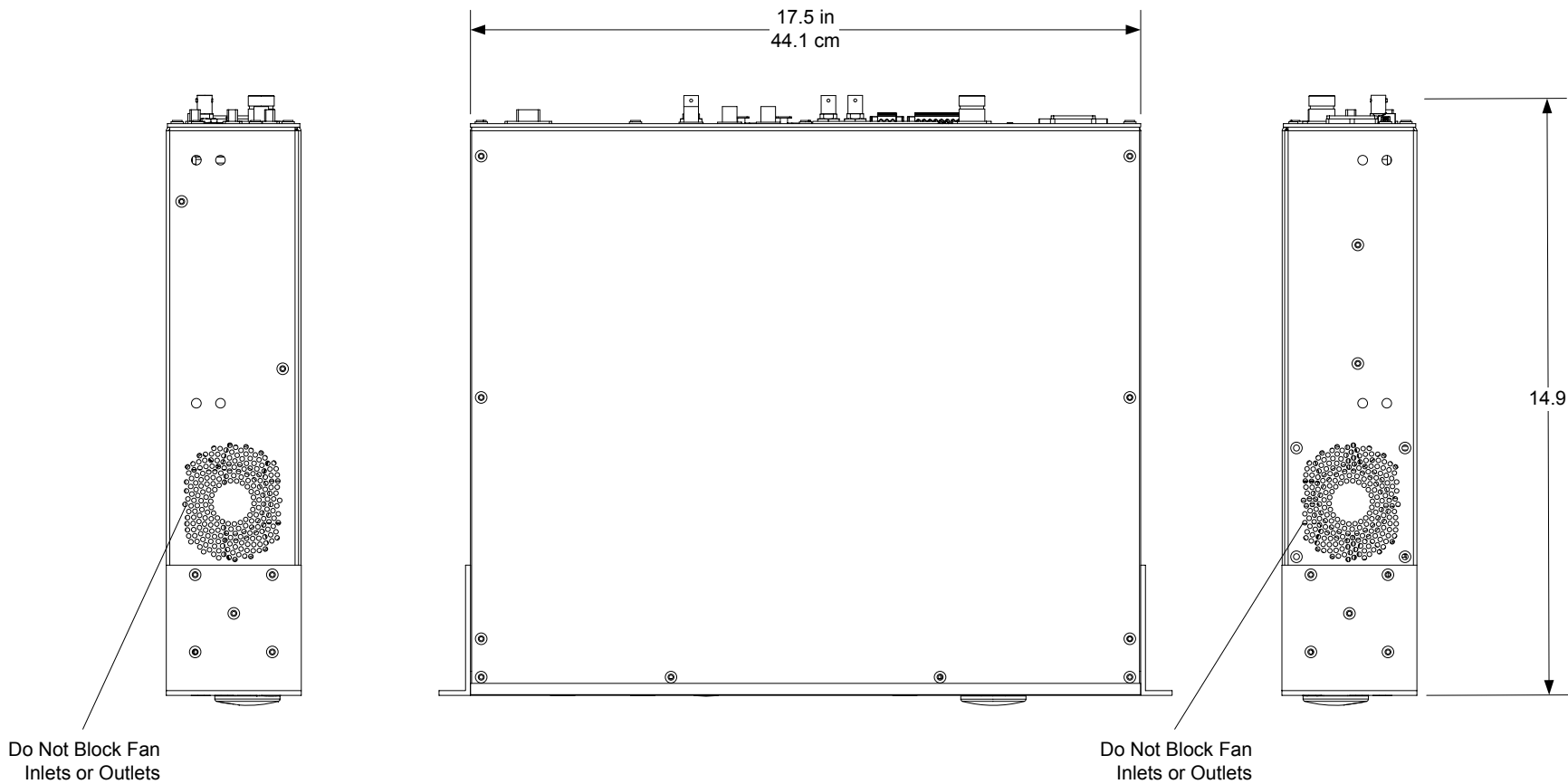

Figure 4 IDU Footprint

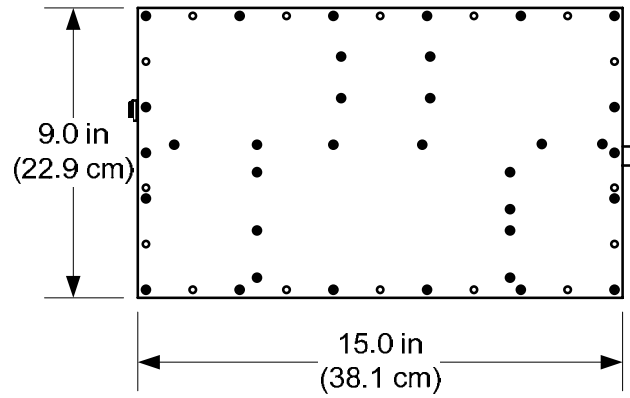
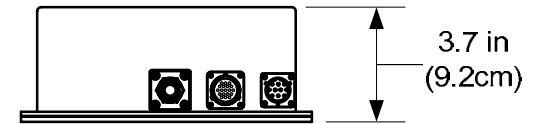
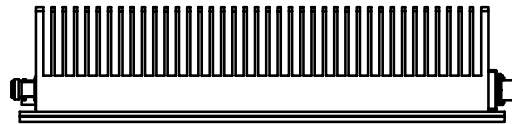
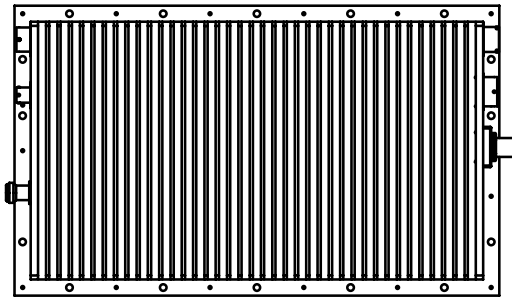

Figure 5 ODU Footprint

Installing the Indoor Unit (IDU)



Figure 6 TCII Indoor Unit

To install the Truck-Coder II Indoor unit:

The TCII Indoor unit is designed to fit in a standard 19" rack using either permanent shelf or rails to support the IDU. A mounting kit (BMS P/N 7614191020) is included if needed.

Select a location to mount the unit. There needs to be enough space around the unit to allow for proper ventilation and access to connections.

Warning:

Failure to ensure proper ventilation could cause the system to overheat resulting in system failure and possible damage. Do not block the intake or exhaust fan vents

1. Make the appropriate connections to the back panel (see Figure 7). Be sure that all connections are secure. Route the cables as needed.
2. Slide the IDU into position so that the front panel is flush with the rack.
3. Using 4 each, #10-32 ½ in long pan head screws, flat washers and split-lock washers, secure the IDU to the rack.
4. Install the ODU on to the antenna mast.

This Page Intentionally Left Blank

Indoor Unit (IDU) Connections

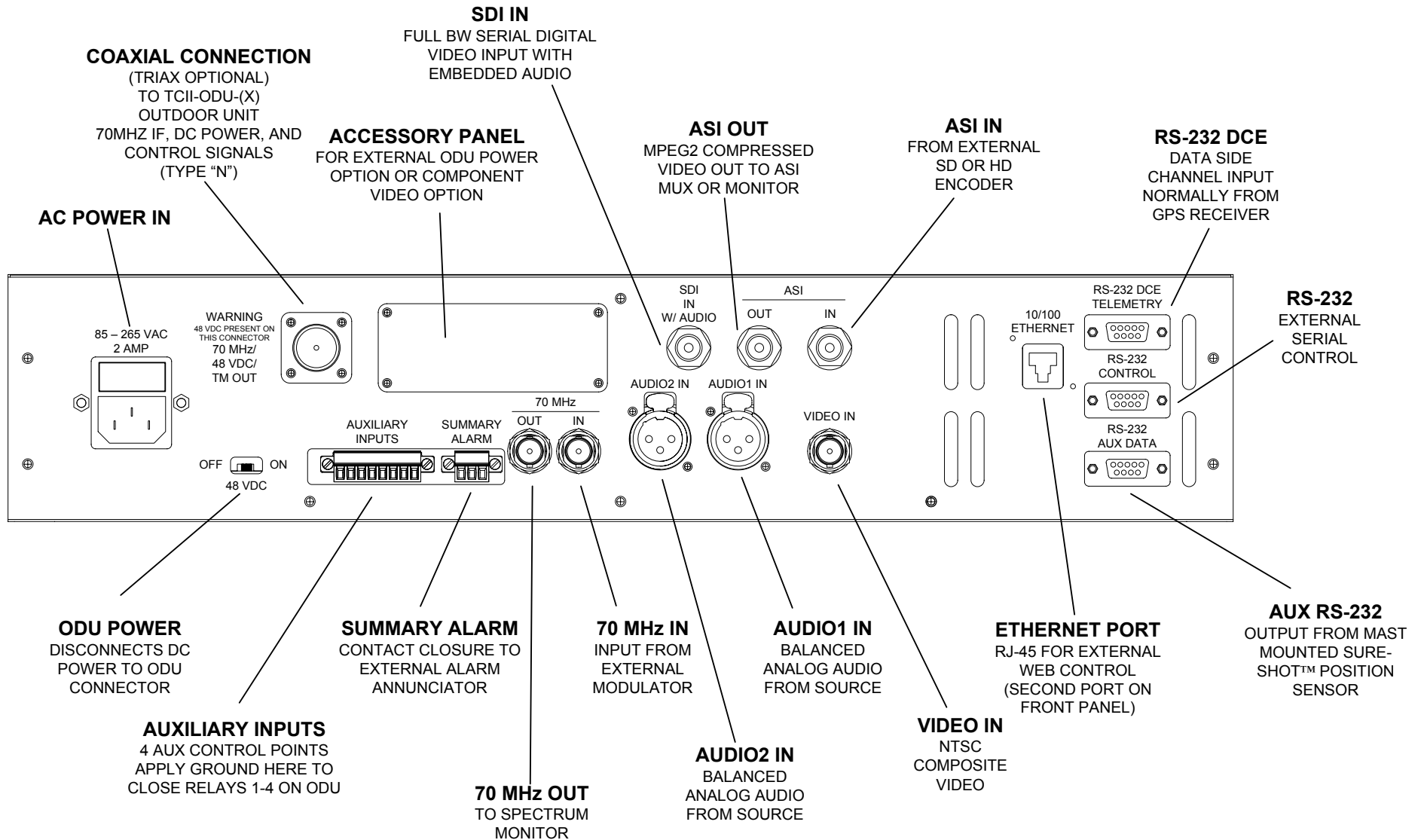

Figure 7 TCII Indoor Unit Rear Panel Connections

Installing the Outdoor Unit (ODU)



Figure 8 TCII Outdoor Unit

The ODU is designed to be mounted on an antenna mast using a custom mast mount specifically designed for the mast. See Figure 9 for footprint requirements, hole sizes and hole locations to aid in the design of the custom antenna mast mount.

This Page Intentionally Left Blank

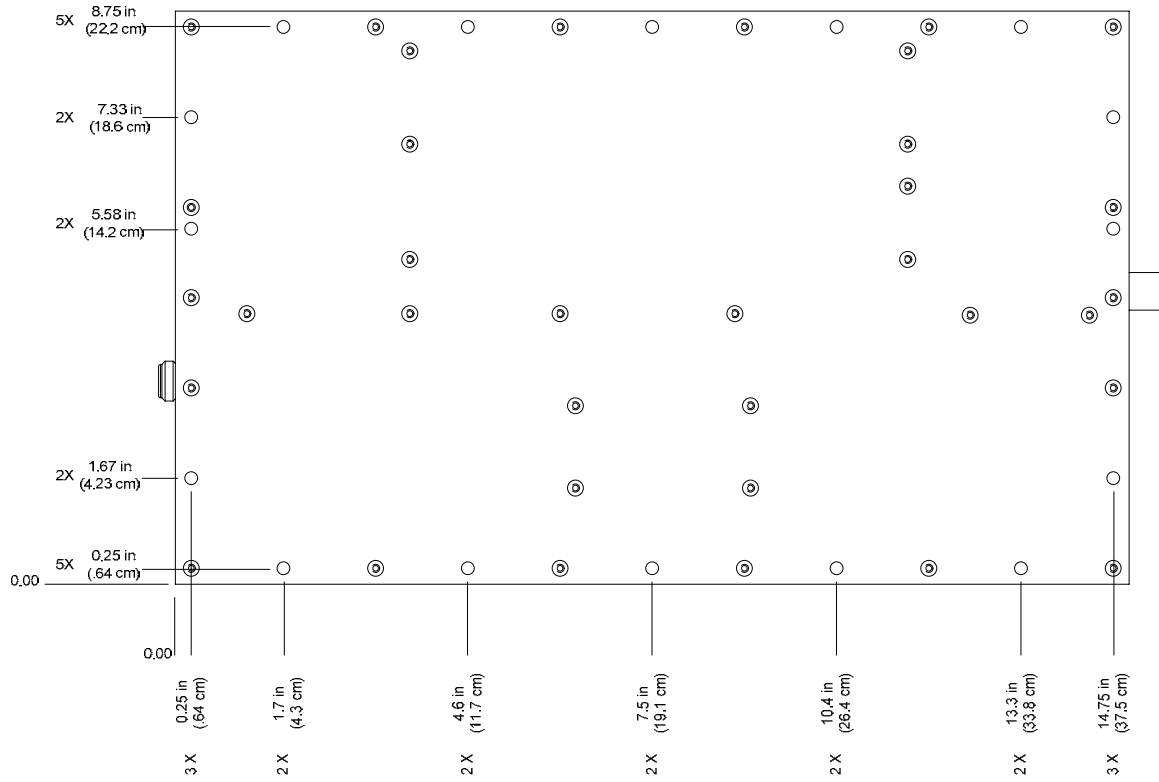

Figure 9 ODU Mounting Footprint

1. Secure the ODU to the custom antenna mast mount with 16-#10 screws (included in installation kit BMS P/N 7614191020.)

Note:

The Orientation of the ODU is critical to the performance of the TCII system. The ODU must be mounted on the Antenna mast so that the RF connectors are down. (Figure 10)

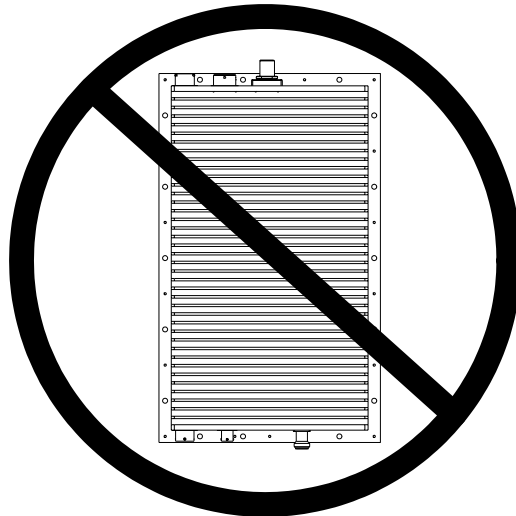
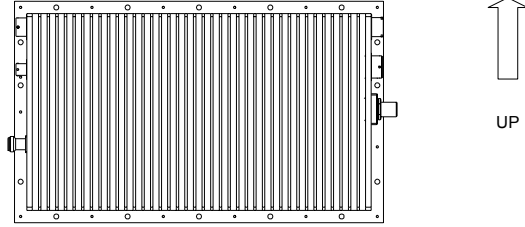

Figure 10 ODU Mounting Orientation

2. Make the appropriate connections to the ODU.
3. All unused connectors must be capped and sealed to protect the ODU from the weather & elements. See Table 6.

Table 6 Connector Caps

Connector	Connector Protection Cap BMS P/N (Use self vulcanizing tape to secure seal.)
J1 – External Data In	210061400
J4 – Antenna Control	210061400
J5 – External Control	210059901

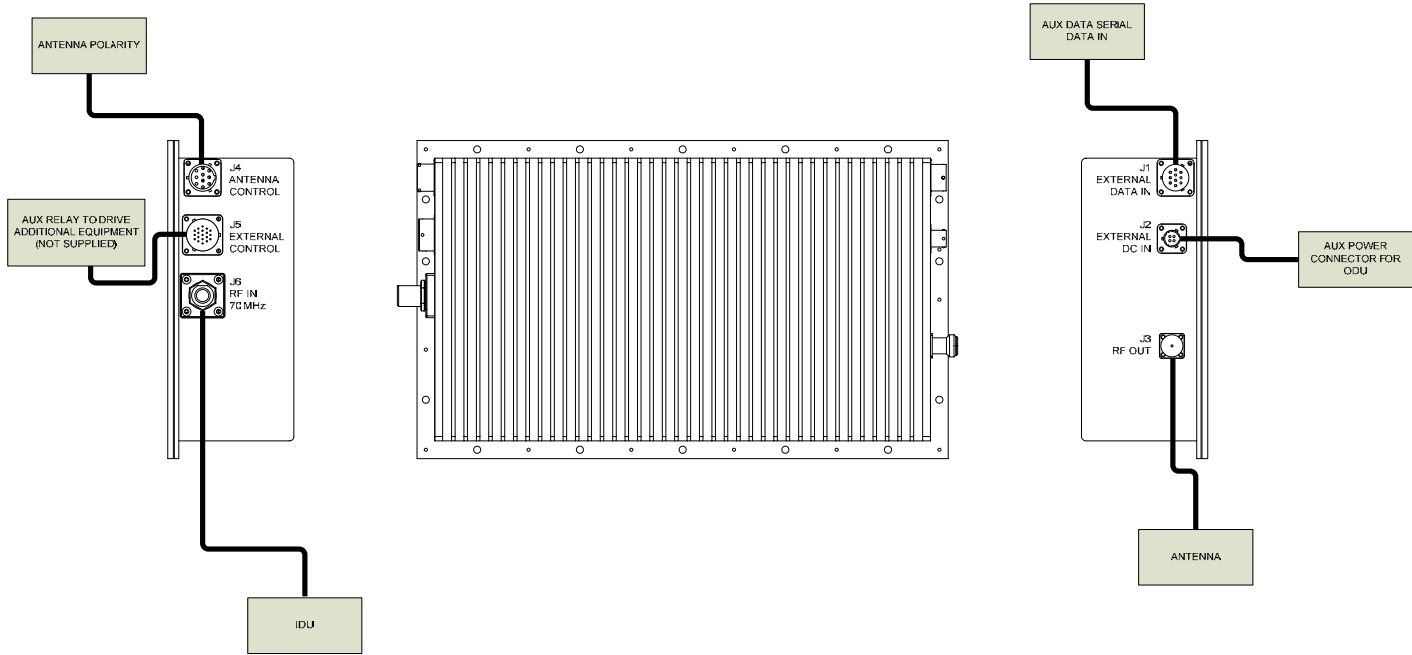

Figure 11 ODU Connections

Table 7 ODU Connections

Component	Connection	Connecting Component
Outdoor Unit (ODU)	J1 EXTERNAL DATA IN	Factory Service Port Only – This connector should be capped and sealed during operation
	J2 EXTERNAL DC IN	External 24VDC Power Supply – Most systems will be powered through the Coax requiring this connector to be capped and sealed.
	J3 RF OUT	ANTENNA
	J4 ANTENNA CONTROL	To Auxiliary Equipment or capped and sealed if not used.
	J5 EXTERNAL CONTROL	To Auxiliary Equipment or capped and sealed if not used.
	J6 RF IN 70 MHz	IDU

OPERATION

NOTE:

Follow all procedures precisely to ensure initialization & operation.

Initialization

1. Power the TCII on by switching the System Power to the ON position. The green indicator light to the right of the power switch will turn on immediately.
2. The TCII will immediately go into a diagnostics/test mode and will take about 20 seconds to initialize before the display is activated.
3. Once the internal systems check out, the TCII will display the HOME Screen.

This Page Intentionally Left Blank

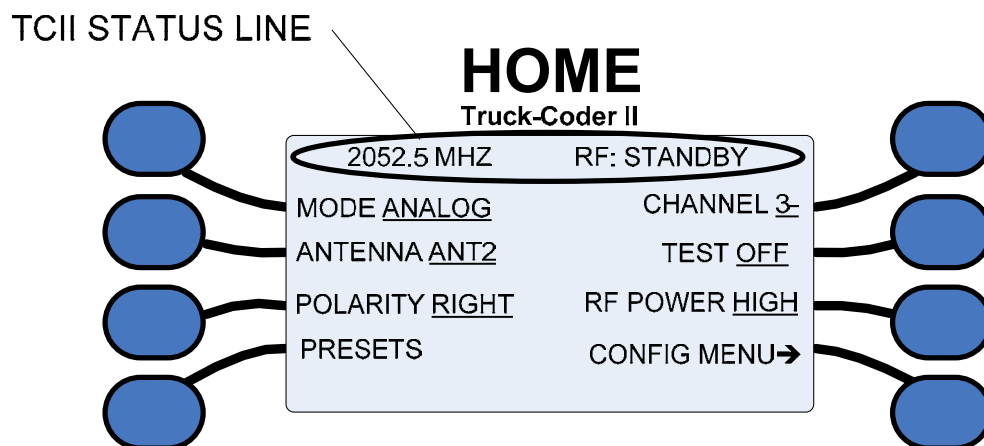

Figure 12 The HOME Menu

The home menu will display the current transmission frequency and status (RF: STANDBY or RF: ON) and various transmission settings.

1. Verify transmission TCII status. The frequency or the Preset Description will appear on the left in the Status line. The transmission status will appear on the right. The current settings for transmission MODE, selected ANTENNA, antenna POLARITY , CHANNEL, TEST signal, and RF POWER are indicated by the underline.
2. If all the settings are correct, begin transmission by pressing the RF On/Standby button on the front panel. The Status Line will read RF: ON, the LED to the left of the RF On/Standby button will change from orange to green.
3. To end transmission, switch the transmission mode to standby pressing the RF On/Standby button again. The Status Line will read RF: STANDBY and the RF Indicator LED will return to orange.
4. The system may now be shut down by switching the System Power switch to the OFF position.

WARRANTY

BMS warrants that, at time of delivery, the product will be free from defects in materials and workmanship, provided the equipment or system is installed, operated and maintained in accordance with the Operation and Maintenance manual or such other BMS documentation as may be applicable. Any such defect reported to BMS within two years, BMS will take reasonable and prompt action to repair or replace such equipment.

Should any of the components be defective, please contact BMS immediately. Please have the following information available so we can best serve you.

- Customer Name
- Contract Number
- BMS Model Number
- Serial Number
- Detailed Description of Problem
- Name of Contact Person
- Contact Information such as phone number and/or email address
- Return Information

Much of this information can be found on the product label found on the component.

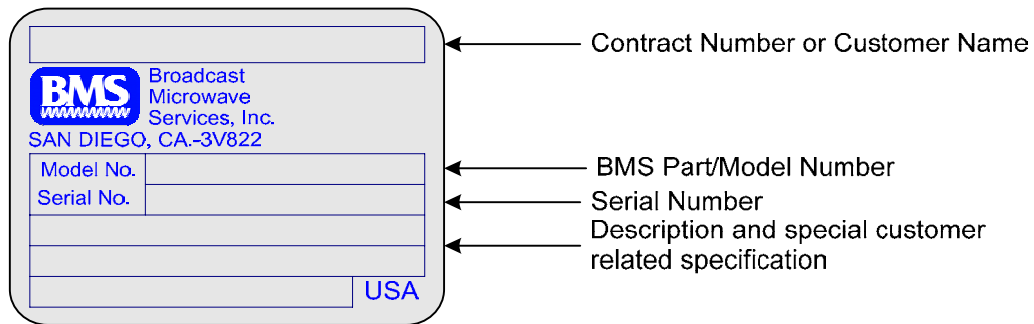

Figure 13 Product Label

Defective components under BMS warranty will be repaired/replaced at the discretion of BMS. Items no longer under warranty will require a PO before repairs can proceed.

NOTE:

All goods returned for service require an RMA #. Any goods received without an RMA# may not be processed in a timely manner. Please contact BMS for an RMA#.

Customer Service Information

Broadcast Microwave Services, Inc.
12367 Crosthwaite Circle
Poway, CA 92064

Tel: +1 (858) 391-3050
Toll free (US): 800-669-9667
Fax: +1 (858) 391-3049
Email: support@bms-inc.com
Web: www.bms-inc.com

This Page Intentionally Left Blank

TROUBLE SHOOTING

The TCII has certain required parameters. When anomalies happen and the TCII starts to operate outside the specified parameters, the fault indicator light will be activated and the system status will scroll across the top of the HOME screen.

Below is a list of faults along with the possible causes and solutions.

Fault	Cause	Solution
COMMS FAIL	IDU not communicating with ODU.	Check connections. Shut down then restart the TCII to reset.
DIGITAL COMM FAIL	Internal Failure	Shut down then restart system to reset. If fault is still present, then contact BMS.
FAIL-SAFE MODE	The TCII has experienced a failure that caused the transmission to be shut down.	Shut down then restart system to reset. If the TCII is still in FAIL-SAFE mode, identify the fault and follow the recommended solution.
IFU PLL UNLOCK	Internal Failure	Shut down then restart system to reset. If fault is still present, then contact BMS.
INPUT RF POWER TOO HIGH	RF Power at ODU exceeds limit	Check RF Power Out at IDU
INPUT RF POWER TOO LOW	RF Power at ODU too low	Check RF Power Out at IDU, check coaxial connections
INPUT RF POWER UNSTABLE	Too much power fluctuation	Check the coaxial connections
INPUT VOLTAGE TOO HIGH	Possible power supply failure	Check for 48 V@ IDU out. Contact BMS
INPUT VOLTAGE TOO LOW	Not enough voltage into ODU	Check connections, Check cable impedance/ verify setting in TCII. Check for 48V out @ IDU.
PA TEMPERATURE GETTING HIGH	PA Temp between 73° C and 85° C	RF Power will automatically go into LOW power mode. Limit transmission and/or Wait for Temperature to fall below 73° C.
PA TEMPERATURE TOO HIGH	PA Temp has exceeded 85° C	Put in STANDBY Mode. Wait for ODU to cool.
POST/BIST FAIL	Internal Failure	Shut down then restart system to reset. If fault is still present, then contact BMS.
RF OUTPUT POWER TOO HIGH	Exceeded the RF Power Output Limit	Contact BMS
RF OUTPUT POWER TOO LOW	Not enough RF Output Power	Check connections
RFU PLL UNLOCK	Internal Failure	Shut down then restart system to reset. If fault is still present, then contact BMS.
THERMAL SETBACK	PA Temp above 73° C. RF Power is automatically reduced	Limit transmission. Wait for PA Temp to fall below 73° C.
THERMAL SHUTDOWN	PA Temp above 85° C. RF transmission automatically shut down.	Wait until PA Temp falls below 73° C for normal transmission.

Diagnostics

The Diagnostic Table contains a list of the most common problem symptoms and their solution.

Symptom	Possible Cause	Solution
Tone at receive site - Video OK	Test signal turned on at transmitter	On HOME Menu, select TEST <u>OFF</u>
No RF at receive site	Wrong frequency, polarity or mode. Unit is in Standby Wrong antenna selected or antenna not directed at receiver	Verify that settings on HOME menu match those at receiver. Place transmitter in transmit by pressing RF On/Standby button. Green LED -- Transmit Amber LED – Standby Make sure correct antenna is selected and pointed at receive site.
Receiver shows signal strength, but no picture or sound	Audio/video connections Wrong modulation/encoding parameters selected	See below Ensure that Modulation, and MPEG encoding settings match those of receiver.
Video is intermittent or poor quality - transmitter displays video alarm	Bad connection on video input.	Check cable and connections, particularly cable reels and camera terminations.
Video appears “smeared” or pixilated, particularly during movement.	Encoding/decoding errors or incompatibility	Ensure that MPEG settings match those of receiver. Video/audio/pcr PIDS
Audio is intermittent	Bad connection on audio input.	Check cable and connections, particularly cable reels and microphone terminations.

If you have attempted the solution and the symptoms have not resolved or if you are experiencing a symptom not listed please contact BMS.

Customer Service Information

Broadcast Microwave Services, Inc.
12367 Crosthwaite Circle
Poway, CA 92064

Tel: +1 (858) 391-3050
Toll free (US): 800-669-9667
Fax: +1 (858) 391-3049
Email: support@bms-inc.com
Web: www.bms-inc.com

PIN OUTS

IDU

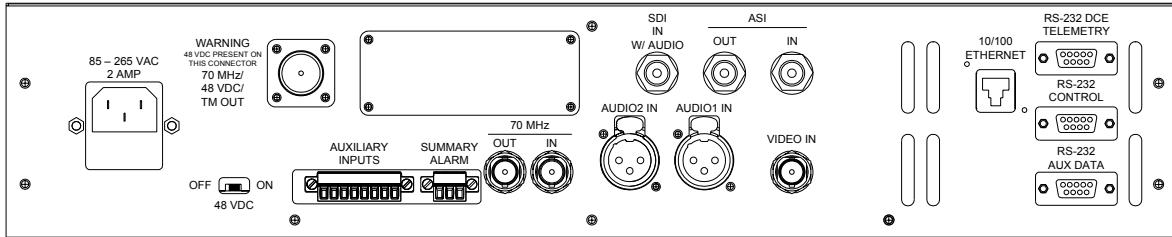
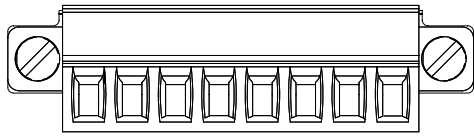

Figure 14 IDU REAR PANEL CONNECTORS

Table 8 AUXILIARY INPUT PINOUTS

AUXILIARY INPUTS	PIN	Description
		1
2		RELAY 2
3		RELAY 3
4		RELAY 4
5		RETURN 1
6		RETURN 2
7		RETURN 3
8		RETURN 4

The auxiliary inputs are control inputs that transferred to the ODU output (J5 EXTERNAL CONTROL PIN OUT) for control of auxiliary equipment.

Table 9 SUMMARY ALARM PINOUTS

SUMMARY ALARM	PIN	Description	
		1	NC
		2	COM
3		NO	

Table 10 AUDIO 1 IN PINOUTS

	PIN	Description
	1	GND
	2	POS
	3	NEG

Table 11 AUDIO 2 IN PINOUTS

	PIN	Description
	1	GND
	2	POS
	3	NEG

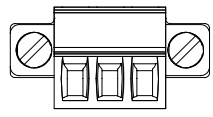
ODU

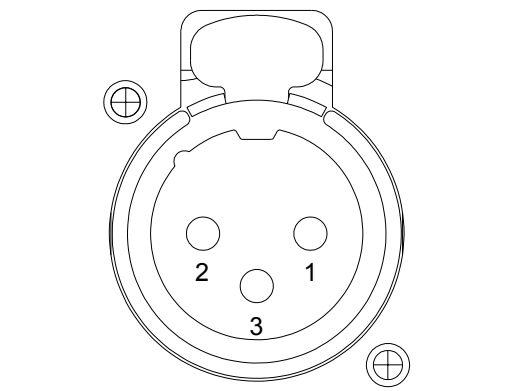
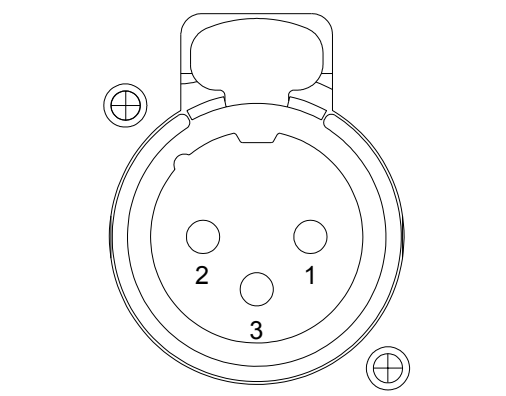
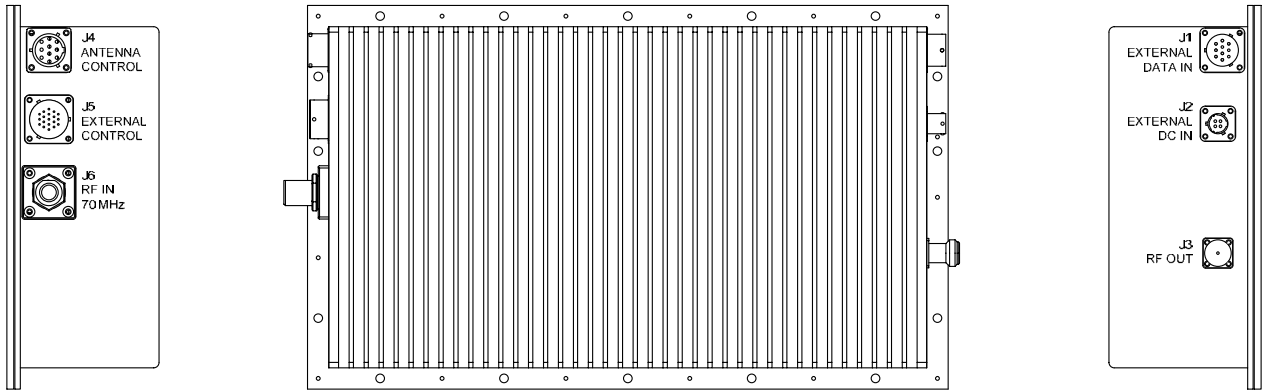

Figure 15 ODU CONNECTORS

Table 12 J1 EXTERNAL DATA IN

	PIN	Description
	A	NC
	B	RESERVED
	C	GND
	D	NC
	E	NC
	F	NC
	G	GND
	H	RESERVED
	J	RESERVED
	K	RESERVED

Table 13 J2 EXTERNAL DC IN PIN OUTS (Optional)

	PIN	Description
	A	+ V DC
	B	+V DC
	C	Return
	D	Return

Table 14 J4 ANTENNA CONTROL PIN OUTS

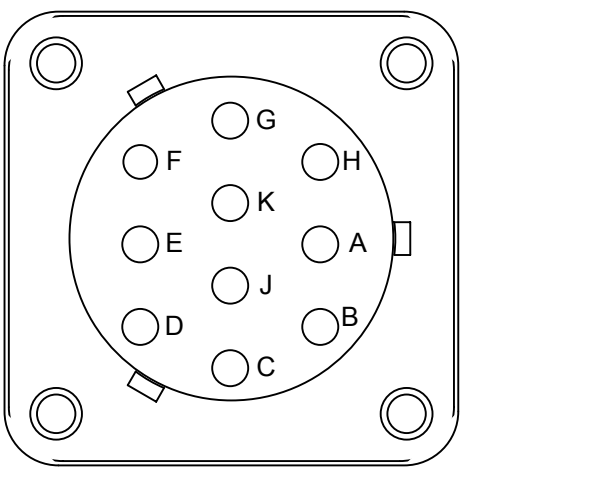

Feed Type is configured by the cable connector.

Jumper pins J – A for NSI

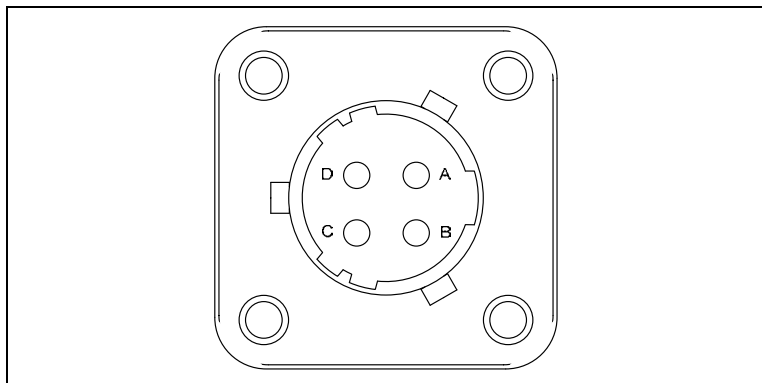
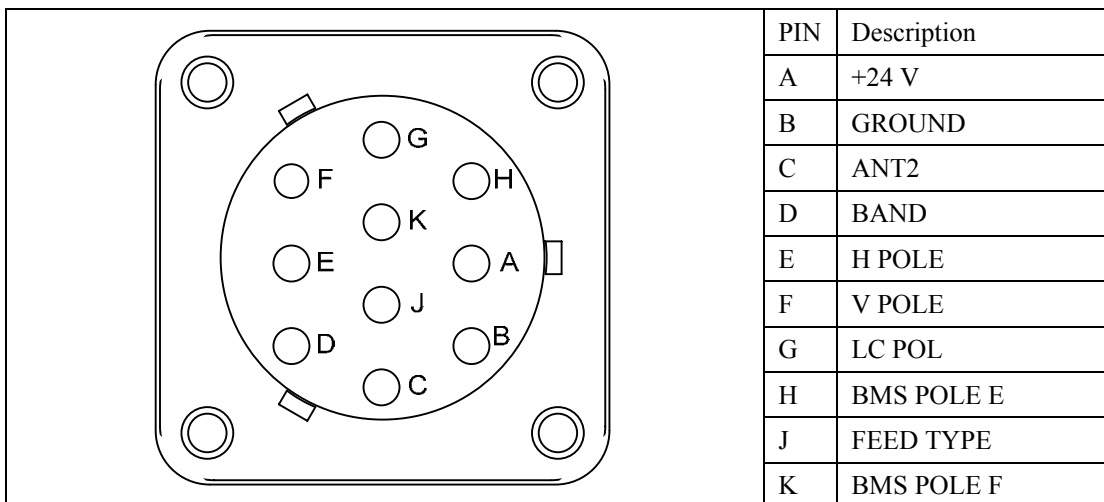
Jumper pins J – B for MRC

Table 15 ODU J5 EXTERNAL CONTROL PIN OUT

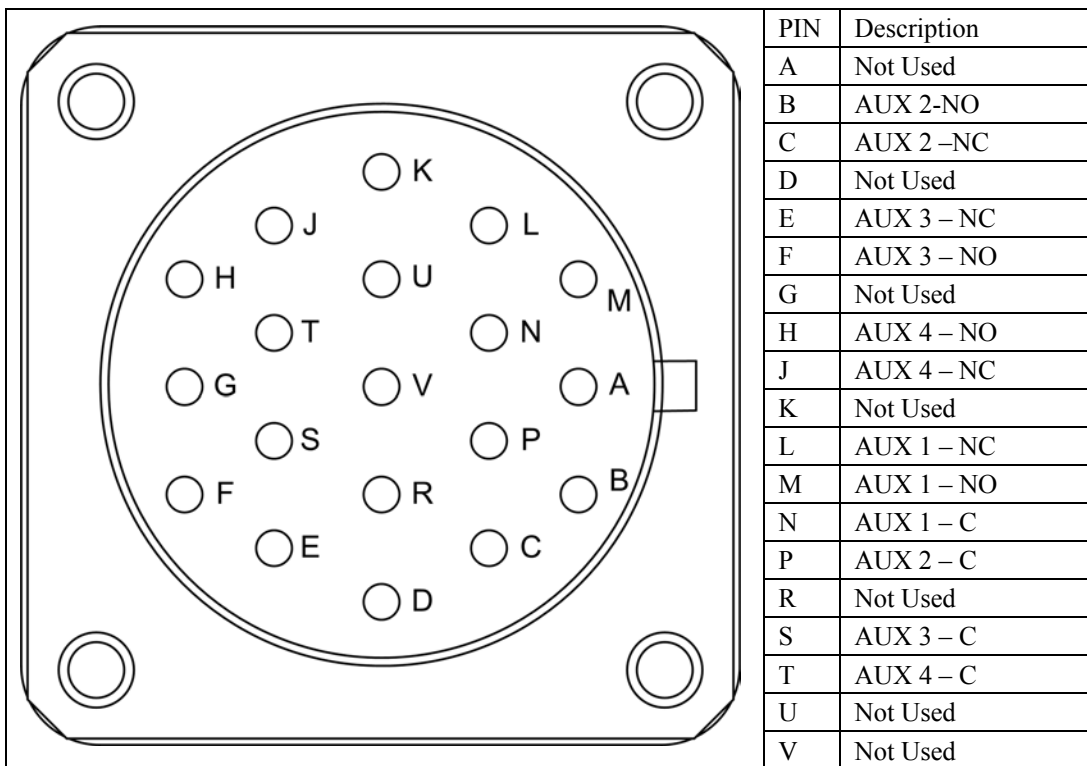

US Broadcast Frequency Assignments

Old BAS Channel Plan 2 GHz (S) Band 1990-2110 MHz			17 MHz CW
1	1994.75	1999.00	2003.25
2	2012.25	2016.50	2020.75
3	2029.25	2033.50	2037.75
4	2046.25	2050.50	2054.75
5	2063.25	2067.50	2071.75
6	2080.25	2084.50	2088.75
7	2097.25	2101.50	2105.75

New BAS Channel Plan 2 GHz (S) Band 1990-2110 MHz			12 MHz CW 12 MHz CS
A1r	2028.50	2031.50	2034.50
A2r	2040.50	2043.50	2046.50
A3r	2052.50	2055.50	2058.50
A4r	2064.50	2067.50	2070.50
A5r	2076.50	2079.50	2082.50
A6r	2088.50	2091.50	2094.50
A7r	2100.50	2103.50	2106.50

2.5 GHz (S) Band 2450-2500 MHz			17 MHz CW 17 MHz CS
8	2454.25	2458.50	2462.75
9	2471.25	2475.50	2479.75
10	2487.75	2492.00	2496.25

6 GHz (C) Low Band 6425-6525 MHz			25 MHz CW 25 MHz CS
1	6431.00	6437.50	6444.00
2	6456.00	6462.50	6469.00
3	6481.00	6487.50	6494.00
4	6506.00	6512.50	6519.00

7 GHz (C) High Band 6875-7125 MHz			25 MHz CW 25 MHz CS
1	6881.00	6887.50	6894.00
2	6906.00	6912.50	6919.00
3	6931.00	6937.50	6944.00
4	6956.00	6962.50	6969.00
5	6981.00	6987.50	6994.00
6	7006.00	7012.50	7019.00
7	7031.00	7037.50	7044.00
8	7056.00	7062.50	7069.00
9	7081.00	7087.50	7094.00
10	7106.00	7112.50	7119.00

13 GHz Band 12700-13250 MHz		25 MHz CW 25 MHz CS	
1	12706.25	12712.50	12718.75
2	12731.25	12737.50	12743.75
3	12756.25	12762.50	12768.75
4	12781.25	12787.50	12793.75
5	12806.25	12812.50	12818.75
6	12831.25	12837.50	12843.75
7	12856.25	12862.50	12868.75
8	12881.25	12887.50	12893.75
9	12906.25	12912.50	12918.75
10	12931.25	12937.50	12943.75
11	12956.25	12962.50	12968.75
12	12981.25	12987.50	12993.75
13	13006.25	13012.50	13018.75
14	13031.25	13037.50	13043.75
15	13056.25	13062.50	13068.75
16	13081.25	13087.50	13093.75
17	13106.25	13112.50	13118.75
18	13131.25	13137.50	13143.75
19	13156.25	13162.50	13168.75
20	13181.25	13187.50	13193.75
21	13206.25	13212.50	13218.75
22	13231.25	13237.50	13243.75

This Page Intentionally Left Blank

Coded Orthogonal Frequency Division Multiplex (COFDM) Modulation

COFDM is used for microwave applications like wireless cameras and mobile video links because of its tolerance to multipath transmission errors. In addition COFDM offers more than twice the spectral efficiency of comparable FM analog microwave transmission.

COFDM does not rely on the vulnerability of a single carrier but spreads the digital information over many narrow band carriers using Frequency Division Multiplex (FDM). The bandwidth and the data rate on each of these carriers are reduced and therefore the RF robustness is increased. The carriers are accurately spaced and orthogonal, which means they can be generated and recovered without carrier specific filtering. Even though the spectra of adjacent carriers significantly overlap, each carrier can be demodulated without crosstalk from its neighbors.

The main COFDM parameters are:

- Number Of Sub-Carriers (About 2,000 In Our Case)
- The Symbol
- Individual Sub-Carrier Modulation
- Guard Interval (GI) Duration Between COFDM Symbols
- Data Redundancy Code Rate Used For Error Correction

Symbols

The active symbol is the period that digital information is sampled. The number of bits carried in each symbol depends on the choice of modulation.

Modulation

Modulation is the process of varying a carrier signal in order to use that signal to convey information. Quadrature amplitude modulation (QAM) is a modulation scheme which conveys data by changing (modulating) the amplitude and phase of two carrier waves. BMS uses the forms QPSK, 16QAM, and 64QAM.

QPSK	2 bits/symbol
16 QAM	4 bits/symbol
64 QAM	6 bits/symbol

The higher-order QAM has a higher susceptibility to noise and other corruption. 64QAM will transmit more bits per symbol but with higher bit error rate. It is a less robust signal, but over an easy transmission path (studio setting) it probably won't matter. More difficult transmission paths (mobile or aerial over long ranges with lots of interference from trees and buildings) will require a more robust signal.

Guard Interval (GI)

The guard interval acts as a buffer to protect the active symbol from echoes. A guard interval is added to the beginning of each symbol to allow time for echoes to settle before beginning the active symbol period. A wide range of guard interval options are available from $\frac{1}{32}$ to $\frac{1}{4}$. This fraction represents the ratio between the guard interval to the active symbol period.

Code Rate

The code rate represents the amount of Forward Error Correction (FEC) used for each active symbol. FEC is a method of obtaining error control in data transmission. A code rate of $\frac{1}{2}$ means that for two bits of information received, 1 bit is the real data. The other bit tells how intact the first bit is. A code rate of $\frac{7}{8}$ means that out of the 8 bits sent, there are 7 bits of real data and only 1 bit that is to catch any errors in those 7.

Transmission Rates

Finding the best transmission mode to suit a given situation means selecting the best compromise between modulation, guard interval and code rate. What follows the ETSI EN 300 744 V1.4.1 (2001-01) standards for the useful bitrate (Mbit/s) for all combinations of guard interval, constellation and code rate for non-hierarchical systems for 6, 7, and 8 MHz channels respectively

Modulation	Code Rate	Transport Rate (Mb/s) at each Guard Interval for 6 MHz BW				Transport Rate (Mb/s) at each Guard Interval for 7 MHz BW				Transport Rate (Mb/s) at each Guard Interval for 8 MHz BW			
		1/4	1/8	1/16	1/32	1/4	1/8	1/16	1/32	1/4	1/8	1/16	1/32
QPSK	1/2	<i>3,732²</i>	<i>4,147</i>	<i>4,391</i>	<i>4,524</i>	4,354	4,838	5,123	5,278	<i>4,98</i>	<i>5,53</i>	<i>5,85</i>	<i>6,03</i>
	2/3	<i>4,976</i>	<i>5,529</i>	<i>5,855</i>	<i>6,032</i>	5,806	6,451	6,830	7,037	<i>6,64</i>	<i>7,37</i>	<i>7,81</i>	<i>8,04</i>
	3/4	<i>5,599</i>	<i>6,221</i>	<i>6,587</i>	<i>6,786</i>	6,532	7,257	7,684	7,917	<i>7,46</i>	<i>8,29</i>	<i>8,78</i>	<i>9,05</i>
	5/6	<i>6,221</i>	<i>6,912</i>	<i>7,318</i>	<i>7,540</i>	7,257	8,064	8,538	8,797	<i>8,29</i>	<i>9,22</i>	<i>9,76</i>	<i>10,05</i>
	7/8	<i>6,532</i>	<i>7,257</i>	<i>7,684</i>	<i>7,917</i>	7,620	8,467	8,965	9,237	<i>8,71</i>	<i>9,68</i>	<i>10,25</i>	<i>10,56</i>
16QAM	1/2	<i>7,465</i>	<i>8,294</i>	<i>8,782</i>	<i>9,048</i>	8,709	9,676	10,246	10,556	<i>9,95</i>	<i>11,06</i>	<i>11,71</i>	<i>12,06</i>
	2/3	<i>9,953</i>	<i>11,059</i>	<i>11,709</i>	<i>12,064</i>	11,612	12,902	13,661	14,075	<i>13,27</i>	<i>14,75</i>	<i>15,61</i>	<i>16,09</i>
	3/4	<i>11,197</i>	<i>12,441</i>	<i>13,173</i>	<i>13,572</i>	13,063	14,515	15,369	15,834	<i>14,93</i>	<i>16,59</i>	<i>17,56</i>	<i>18,10</i>
	5/6	<i>12,441</i>	<i>13,824</i>	<i>14,637</i>	<i>15,080</i>	14,515	16,127	17,076	17,594	<i>16,59</i>	<i>18,43</i>	<i>19,52</i>	<i>20,11</i>
	7/8	<i>13,063</i>	<i>14,515</i>	<i>15,369</i>	<i>15,834</i>	15,240	16,934	17,930	18,473	<i>17,42</i>	<i>19,35</i>	<i>20,49</i>	<i>21,11</i>
64QAM	1/2	<i>11,197</i>	<i>12,441</i>	<i>13,173</i>	<i>13,572</i>	13,063	14,515	15,369	15,834	<i>14,93</i>	<i>16,59</i>	<i>17,56</i>	<i>18,10</i>
	2/3	<i>14,929</i>	<i>16,588</i>	<i>17,564</i>	<i>18,096</i>	17,418	19,353	20,491	21,112	<i>19,91</i>	<i>22,12</i>	<i>23,42</i>	<i>24,13</i>
	3/4	<i>16,796</i>	<i>18,662</i>	<i>19,760</i>	<i>20,358</i>	19,595	21,772	23,053	23,751	<i>22,39</i>	<i>24,88</i>	<i>26,35</i>	<i>27,14</i>
	5/6	<i>18,662</i>	<i>20,735</i>	<i>21,955</i>	<i>22,620</i>	21,772	24,191	25,614	26,390	<i>24,88</i>	<i>27,65</i>	<i>29,27</i>	<i>30,16</i>
	7/8	<i>19,595</i>	<i>21,772</i>	<i>23,053</i>	<i>23,751</i>	22,861	25,401	26,895	27,710	<i>26,13</i>	<i>29,03</i>	<i>30,74</i>	<i>31,67</i>

² Figures in *italics* are approximate values.

This Page Intentionally Left Blank

Glossary

Analog Transmission	Frequency Modulated (FM) method of sending information with radio waves. An older, dependable method of transmission. (See Digital Transmission)
Antenna Actuator	The mechanism which deploys or retracts the antenna radio operation or for landing and take-off.
ASI: Asynchronous Serial Interface.	Transmission standard used to connect video delivery equipment within a cable, satellite or terrestrial plant.
BNC Connector	The Bayonet Neill-Concelman connector is a type of RF connector used for terminating coaxial cable. (See TNC connector)
COFDM: Coded Orthogonal Frequency Division Multiplex	A digital modulation method that divides a single digital signal across multiple (1000+) signal carriers simultaneously. BMS Coder II family products use COFDM digital modulation.
Composite Video	The format of an analog television (picture only) signal before it is combined with a sound signal and modulated onto an RF carrier.
dB: Decibel	A unit for expressing the ratio of two amounts of electric or acoustic signal power equal to 10 times the common logarithm of this ratio.
dBm	A unit for expressing the power ratio in decibel (dB) of the measured power referenced to one milliwatt (mW).
Digital Transmission	Digitally Modulated (COFDM and others) method of sending information with radio waves. Newer more reliable method of transmission. (See Analog Transmission)
Directional Antenna	The final transmit element of a microwave system that radiates the signal one direction, in a directed or focused narrow beam. This requires aiming of the antenna toward the receive site.
DTV: Digital Television	Digital Television uses digital modulation and compression to broadcast video, audio and data signals.
DVB-T: Digital Video Broadcasting- Terrestrial	An international digital television (DTV) standard that defines digital COFDM modulation using MPEG2 compression.
GPS: Global Positioning System	A navigational system using satellite signals to fix the location of a receiver on or above the earth surface.

MPEG-2	A compression standard for digital video and audio data.
Multipath	The radio wave propagation phenomenon that results in the transmitted signals. reaching the receiving antenna by two or more paths. This condition is not desirable and usually results in signal fading and interference.
MUX Multiplex	The combining of multiple signals into a single transmission.
Omni-Directional Antenna	The final transmit element of the microwave system that radiates the signal approximately equally throughout a 360 degree circle. Does not require aiming of the antenna.
PAL phase- alternating line	A color encoding used in broadcast television systems in large parts of the world.
PAT Program Association Table	Indicates which PID the PMT is to be found
PID	Packet Identifier
PMT-PID Program Map Table	Yields information about the Program, Video PID, Audio PID, and PCR PID. The PMT-PID default is 200 for BMS systems.
PCR-PID Program Clock Reference	A time stamp indicating the system time clock value when the stamped packet leaves the encoder buffer and enters the decoder buffer used to Synchronize the receiver System Time Clock (STC) with the transmitter STC. Default is 101 for BMS systems.
RF: Radio Frequency	That portion of the Electromagnetic Spectrum that is used for radio and television transmission.
SDI: Serial Digital Interface	A digitized video format used for broadcast grade video.
Stand-by	The condition of an RF system where all but the transmit circuits are energized. In this status the system may be switched into transmit mode instantaneously. (See Transmit)
TNC Connector	Threaded version of the BNC connector (See BNC connector)
Transmit	The condition of an RF system where it is sending out signal. (See Stand-by)
YUV	The YUV model defines a color space in terms of one luminance and two chrominance components. YUV is used in the PAL system of television broadcasting, which is the standard in much of the world.