



Nemko USA, Inc.
Phone (858) 755-5525 Fax (858) 452-1810
11696 Sorrento Valley Rd., Suite F
San Diego, CA 92121-1024

Test Report: 2004 110516 FCC

Applicant: **Broadcast Microwave Services**
12367 Crosthwaite Circle Dock 10
Poway, CA 92064
858-391-3050
858-391-3049- fax

Equipment Under Test: Model: **CCII-7 Transmitter**

FCC ID: CNVCCII-7

In Accordance With: **FCC PART 2, FCC PART 74.637, PART 90.209**

Tested By: Nemko USA Inc.
11696 Sorrento Valley Road
San Diego, CA 92121-1024

Date: 1-24-05

Total Number of Pages: 43

Table of Contents

Section 1. Summary of Test Results5

Section 2. General Equipment Specification6

Section 3. RF Power Output7

Section 4. Modulation Limiting.....8

Section 5. Occupied Bandwidth.....12

Section 6. Spurious Emissions At Antenna Terminals16

Section 7. Field Strength of Spurious27

Section 8. Frequency Stability28

Section 9. Test Setup Block Diagrams29

Section 10. Test Equipment List.....32

Section 1. Summary of Test Results**General**

All measurements are traceable to national standards.

These tests were conducted on a sample of the equipment for the purpose of demonstrating compliance with FCC Part 22, Subpart H.

DOCUMENT HISTORY

REVISION	DATE	COMMENTS
-	11-30-04	Prepared By: A. Laudani
-	1-24-05	Initial Release: R. L. Hill

NOTE: Nemko USA, Inc. hereby makes the following statements so as to conform to Chapter 10 (Test Reports) Requirements of ANSI C63.4 (1992) "Methods and Measurement of Radio-Noise Emissions from Low-Voltage Electrical and Electronic Equipment in the Range of 9 kHz to 40 GHz":

- The unit described in this report was received at Nemko USA, Inc.'s facilities on November 17, 2004. Testing was performed on the unit described in this report on November 17, 2004 to November 24, 2004 .
- The Test Results reported herein apply only to the Unit actually tested, and to substantially identical Units.
- This report does not imply the endorsement of the Federal Communications Commission (FCC), NVLAP or any other government agency.

This Report is the property of Nemko USA, Inc., and shall not be reproduced, except in full, without prior written approval of Nemko USA, Inc. However, all ownership rights are hereby returned unconditionally to Broadcast Microwave Services, and approval is hereby granted to Broadcast Microwave Services and its employees and agents to reproduce all or part of this report for any legitimate business purpose without further reference to Nemko USA, Inc.

CERTIFICATION

Nemko USA, Inc., an independent Electromagnetic Compatibility (EMC) Test Laboratory, produced this Test Report and performed the Radio Frequency Interference (RFI) testing and data evaluation contained herein.

Nemko USA, Inc.'s measurement facility is currently registered with the United States Federal Communications Commission (FCC) in accordance with the provisions of 47 United States Code (CFR) Part 2, Subpart I, Section 2.948(a). A current description of Nemko USA, Inc.'s measurement facility is on file with the FCC. Nemko USA Inc. has additionally satisfied the FCC that it complies with the requirements set forth in 47 CFR Part 2, Subpart I, Section 2.948(d) regarding the accreditation of EMC laboratories. As a result, the FCC has placed Nemko USA Inc. on its list of EMC laboratories approved to perform Declaration of Conformity (DOC) procedure testing.

The RFI testing, test data collection and test data evaluation were accomplished in accordance with the ANSI C63.4-1992 Standard, and in accordance with the applicable sections of the FCC rules (47 CFR Parts 2 and 18)." digital devices. The testing was also accomplished in accordance with Industry Canada's ICES-003 standard for unintentional radiating device per EMCAB-3, Issue 3 (May 1998). The administrative summary of this test report provides a description of the test sample

I hereby certify that the test data, test data evaluation, and equipment configurations used to compile this test report are a true and accurate representation of the test sample's radio frequency interference characteristics as of the test date(s), and, for the design of the test sample.

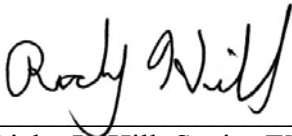

Ricky L. Hill, Senior EMC Test Engineer

Summary Of Test Data

Name Of Test	Para. No.	Result
RF Power Output	2.1046	PASS
Modulation Characteristics	2.1047	AS REPORTED
Occupied Bandwidth	2.1049	PASS
Spurious Emissions at Antenna Terminals	2.1051	PASS
Field Strength of Spurious Emissions	2.1053	PASS
Frequency Stability	2.1055	PASS

Footnotes For N/A's: **EUT is a digitally modulated transmitter. Parts 74 and 90 do not express limits or pass/fail criteria for Modulation Characteristics.**

Test Conditions:

Indoor Temperature: 19--22 °C
 Humidity: 40-50 %

Outdoor Temperature: 15--24 °C
 Humidity: 40-50 %

Section 3. RF Power Output

Para. No.: 2.1046(c)

Test Performed By: A. Laudani	Date of Test: 11-22-04
--------------------------------------	-------------------------------

Minimum Standard: Subpart F--Television Broadcast Auxiliary Stations

Sec. 74.636 Power limitations.

Transmitter peak output power shall not be greater than necessary, and in any event, shall not exceed the power listed in the table below:

Transmitter power Frequency band (MHz)	Fixed (W)	Mobil (W)

1,990 to 2,110.....	20.0	12.0
2,450 to 2,500.....	20.0	12.0

Test Results: EUT complies

Test Conditions:

Tested by Peak Power meter thru a 40 dB attenuator at antenna terminal.
Digitally modulated by video camera, set at 64QAM, highest power setting.
Antenna Gain = 2 dBi

Measurement Data:

Channel	Frequency (MHz)	Output Power (dBm)	Output Power (Watts)
1	1999.0	35.80	3.8
4	2050.5	36.13	4.1
7	2101.5	35.68	3.7
8	2458.5	35.19	3.3
9	2475.5	34.77	3.0
10	2492.0	34.47	2.8

Section 4. Modulation Characteristics

Para. No.: 2.1047

Test Performed By: Alan Laudani	Date of Test: 11-29-04
--	-------------------------------

Minimum Standard: Part 74, Part 90

Test Results: As Reported. Conductive emission plots captured on the Spectrum Analyzer thru a 50 dB attenuator.

Measurement Data: See attached plots to exemplify the three modes of modulation: Modulation modes are QPSK, 16QAM, 64QAM. Each mode was investigated and no one mode was a “worst-case “ mode. The Mode 16QAM was used for all tests as it provided under lower resolution bandwidth slightly wider bandwidth. Modulation mode had no effect for spurious, power or frequency stability measurements.

Modulation Mode: 64QAM

Ref Lvl	RBW	100 kHz	RF Att	0 dB
40 dBm	VBW	300 kHz	Unit	dBm
	SWT	5 ms		

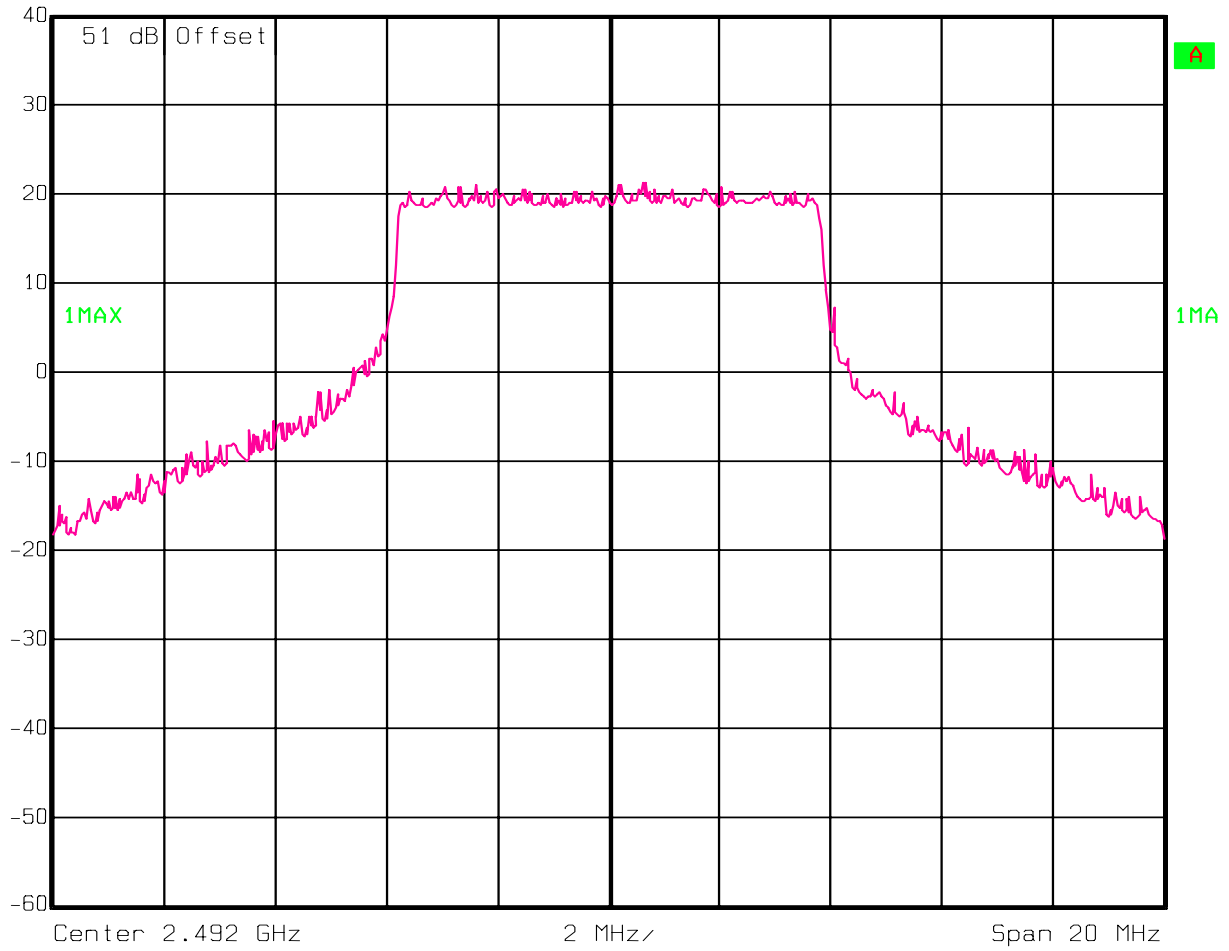

Date: 29.NOV.2004 15:59:47

Modulation Mode: 16QAM

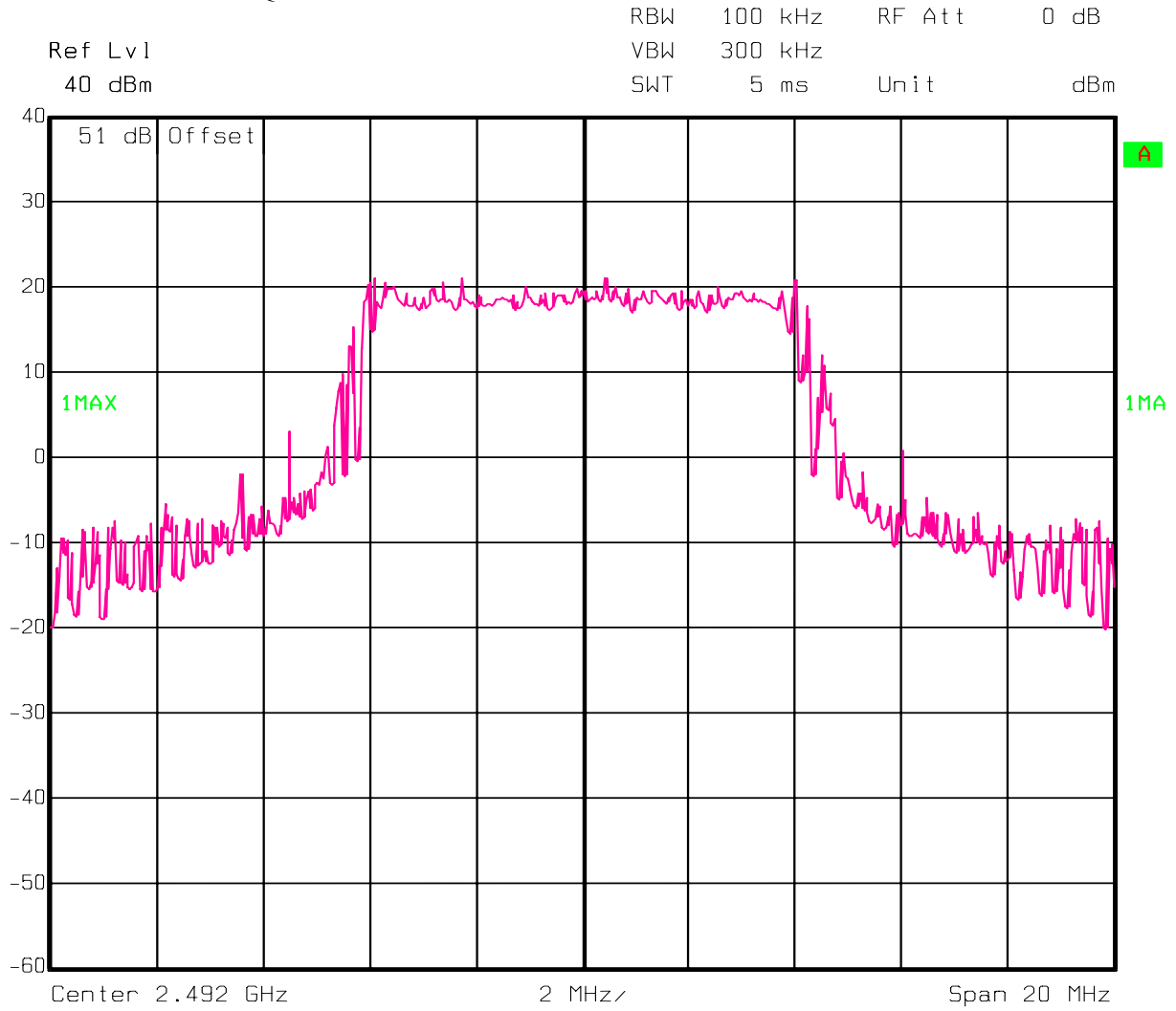

Date: 29.NOV.2004 16:00:30

Modulation Mode: QPSK

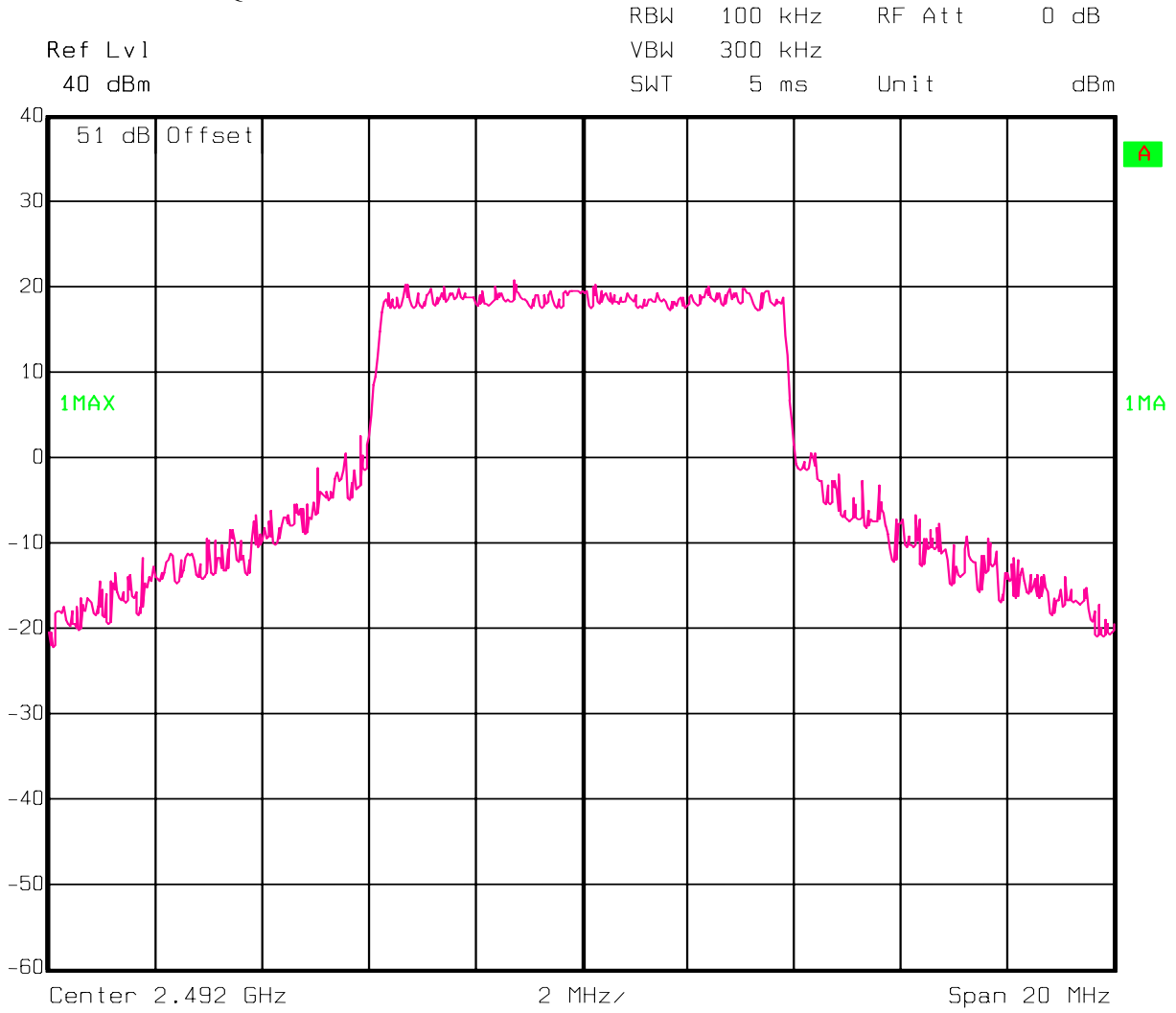

Date: 29.NOV.2004 16:01:09

Section 5. Occupied Bandwidth

Para. No.: 2.1049

Test Performed By: Alan Laudani	Date of Test: 11-30-2004
--	---------------------------------

Minimum Standard: Part 74.637 (g) and 90.209 (a) Occupied/Authorized bandwidth.

Maximum authorized bandwidth

Frequency Band (MHz) (MHz)

1,990 to 2,110..... 18

2,450 to 2,500..... Note 2 of 90.209(b)(5)

Test Results: EUT Complies. Conductive emission plots captured on the Spectrum Analyzer thru a 50 dB attenuator.

Test Data: See attached plots.

Channel 1 1999.0 MHz BW = 9 MHz

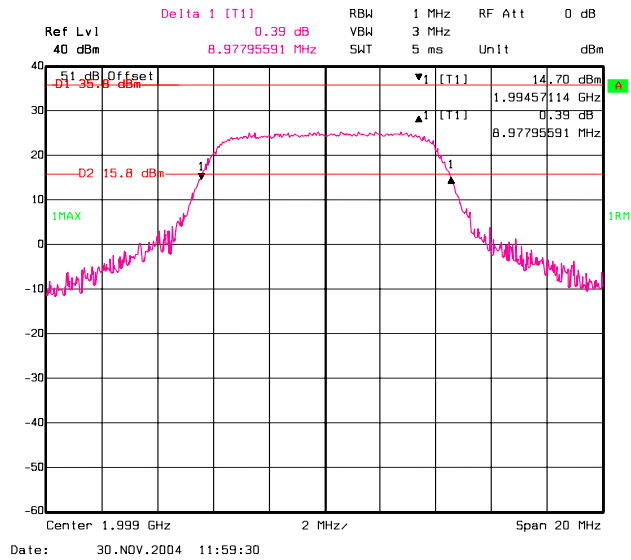

Channel 4 2050.5 MHz BW = 9 MHz

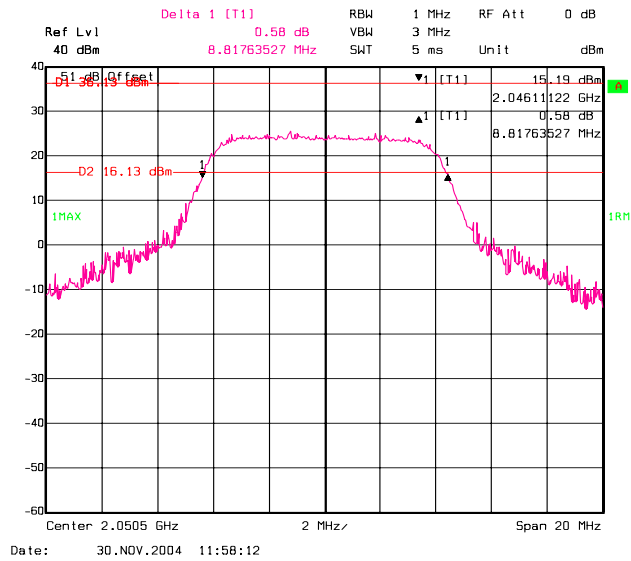

Channel 7 2101.5 MHz BW = 9 MHz

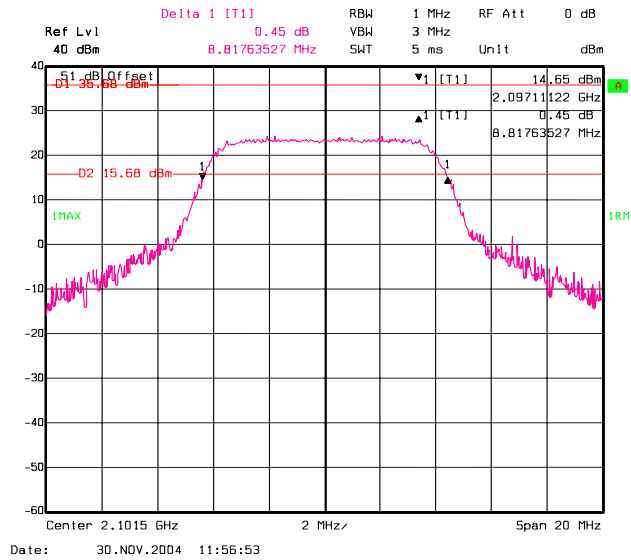

Channel 8 2458.5 MHz BW = 9 MHz

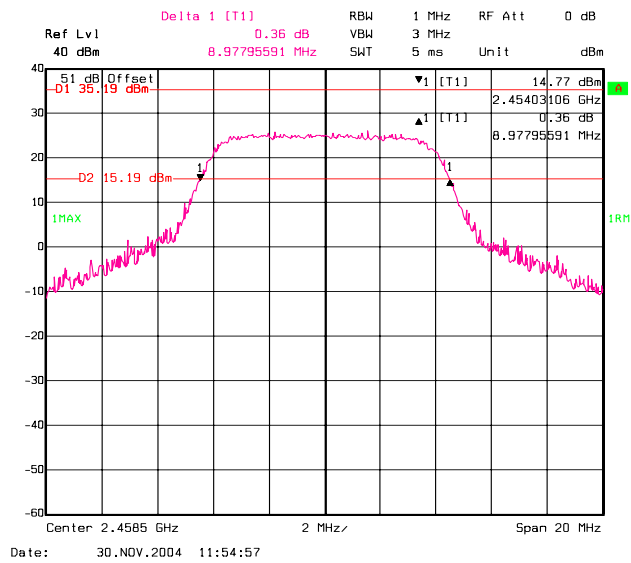

Channel 9 2475.5 MHz BW = 9 MHz

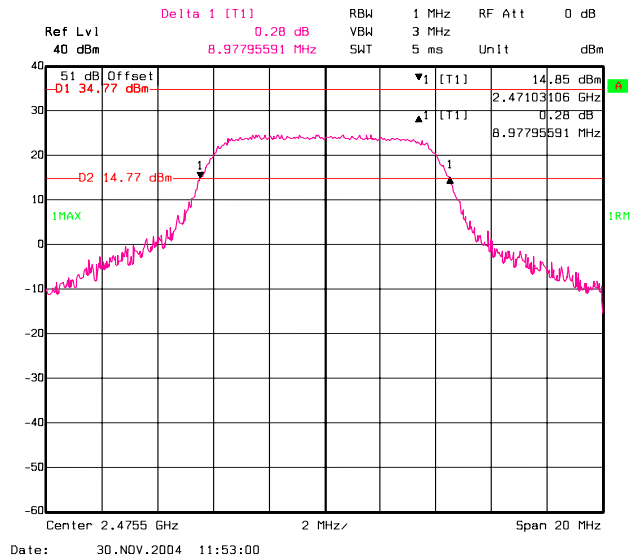

Channel 10 2492.0 MHz BW = 9 MHz

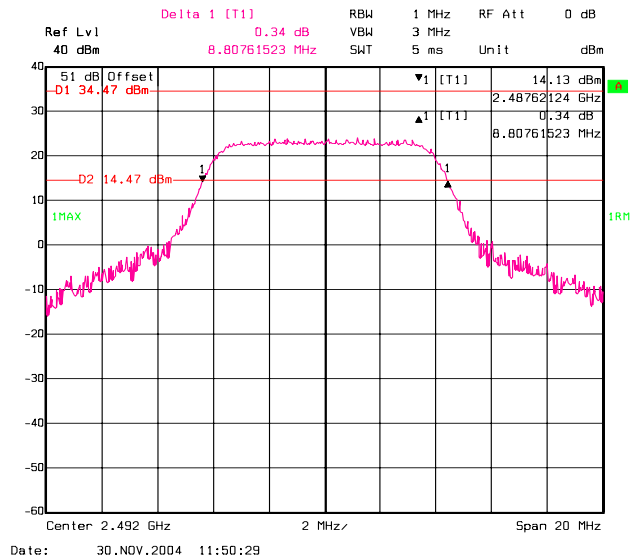

Section 6. Spurious Emissions At Antenna Terminals

Para. No.: 2.1051

Test Performed By: Alan Laudani	Date of Test: 11-30-2004
--	---------------------------------

Minimum Standard: Part 74.637 Emissions and emission limitations

(2) When using digital modulation:

(i) In any 1 MHz band, the center frequency of which is removed from the assigned frequency by more than 50% up to and including 250% of the authorized bandwidth: As specified by the following equation but in no event less than 11 dB.

$$A = 11 + 0.4 (P - 50) + 10 \log_{10}(B)$$

where:

A=Attenuation (in dB) below the mean output power level

P=Percent removed from the carrier frequency

B=Authorized bandwidth in MHz [Attenuation greater than 56 decibels is not required.]

(ii) In any 4 kHz band, the center frequency of which is removed from the assigned frequency by more than 250% of the authorized bandwidth: At least $43 + 10 \log_{10}(\text{M.O.P.})$... (mean output power in watts) dB, or 80 dB, whichever is the lesser attenuation.

Test Results: EUT Complies. Conductive emission plots captured on the Spectrum Analyzer thru a 50 dB attenuator. 5 kHz Resolution Bandwidth measured the emissions closest to the limit (the second harmonic). Emissions were investigated from 1 GHz to 25 GHz .

Test Data: See table and attached Plots (balance in Appendix).

Frequency	Measured (dBm)	Limit	Margin
1999.0 MHz	-32.0	-13	-19.0
2050.5 MHz	-32.1	-13	-19.1
2101.5 MHz	-41.1	-13	-28.1
2458.5 MHz	-28.7	-13	-15.7
2475.5 MHz	-29.2	-13	-16.2
2492.0 MHz	-29.9	-13	-16.9

Emission Mask Endpoints:

BW = 18 MHz, REF LVL = Mean Output Power

50% of BW = 9 MHz -- down 11 dB from MOP

250% of BW = 45 MHz -- down 56 dB from MOP

Channel 1 1999.0 MHz

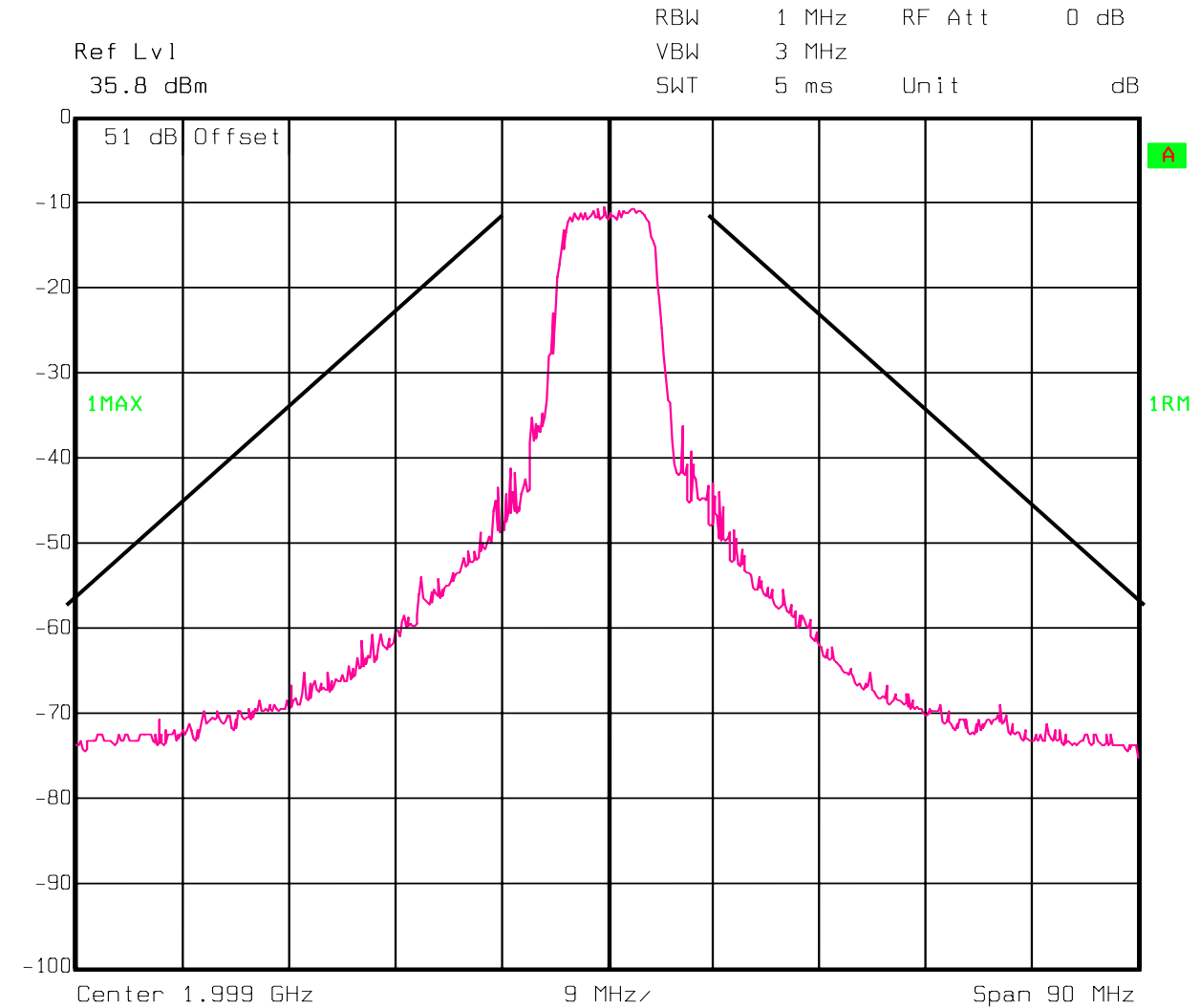

Date: 30.NOV.2004 15:40:11

The second Harmonic was closest to the limit. Display line = Limit = -13 dBm

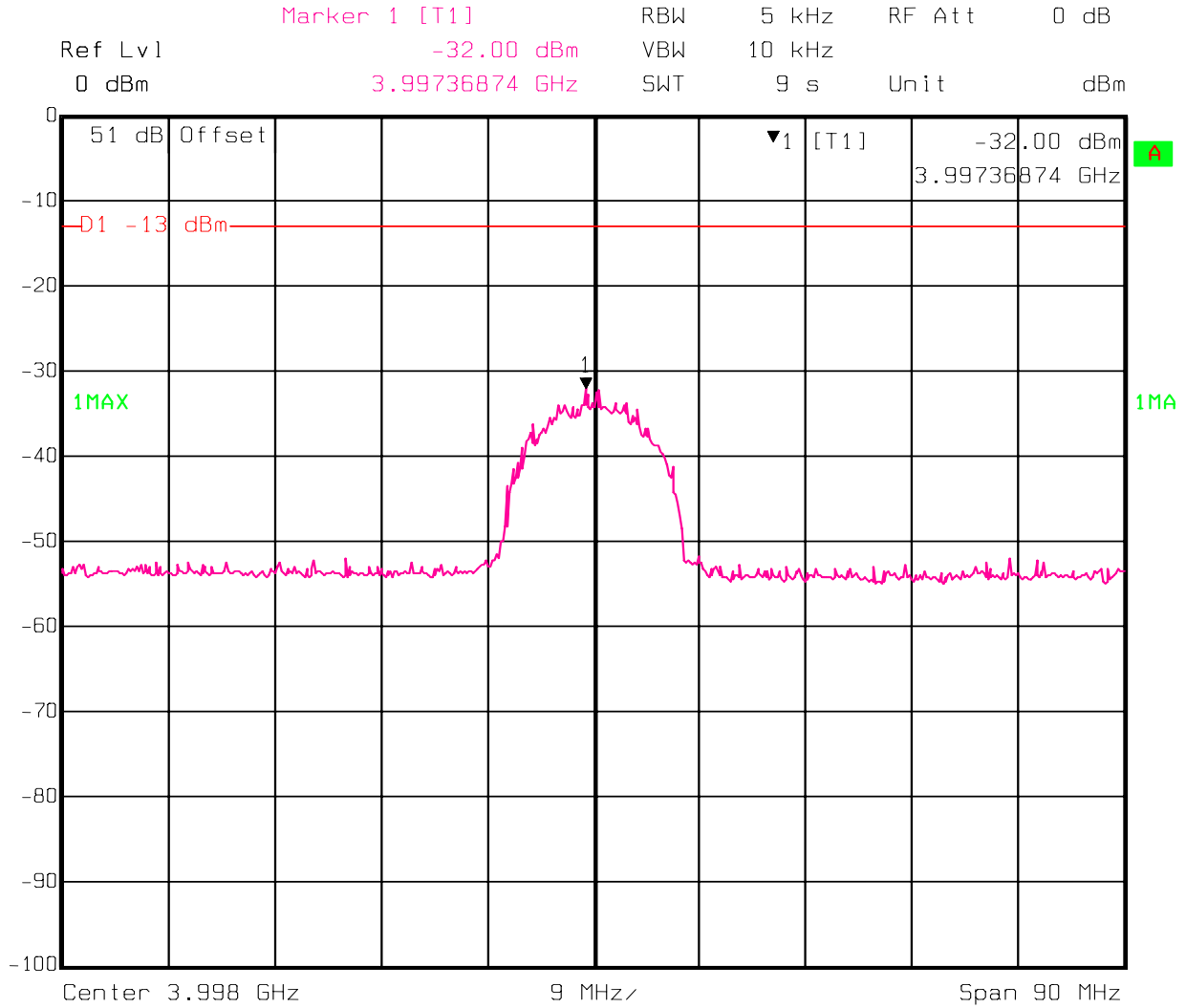

Date: 30.NOV.2004 16:37:48

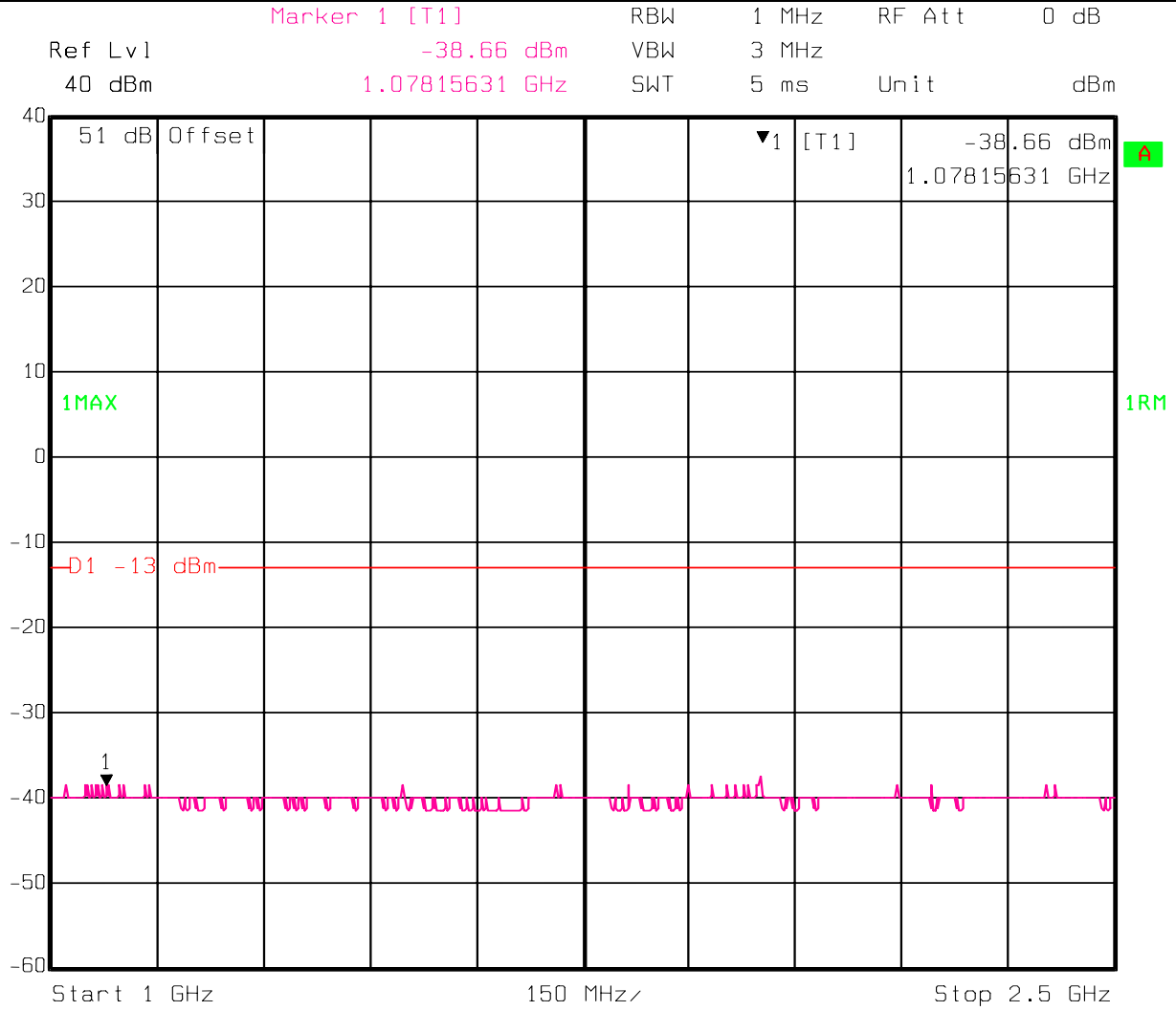

Date: 30.NOV.2004 09:31:38

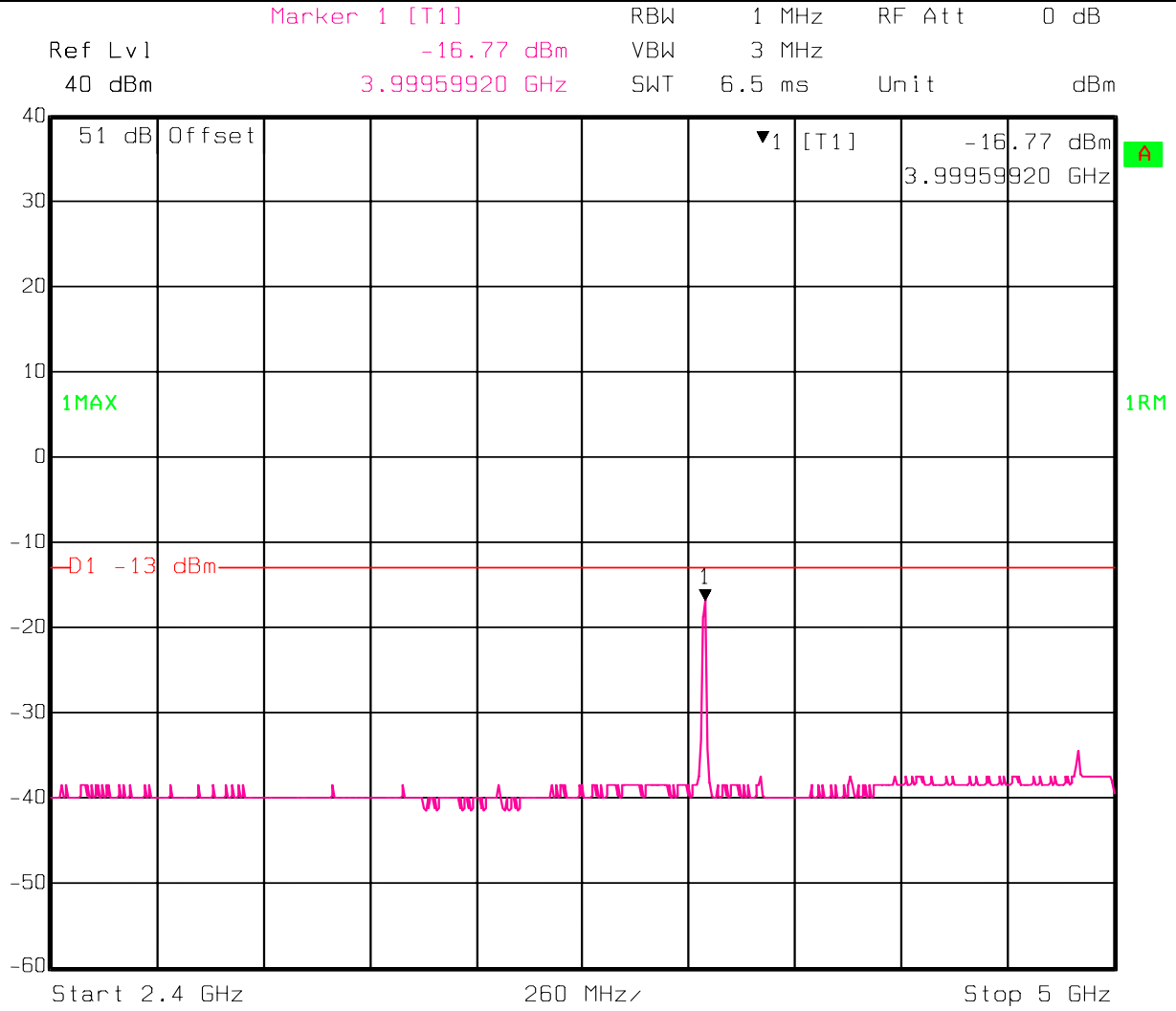

Date: 30.NOV.2004 09:32:22

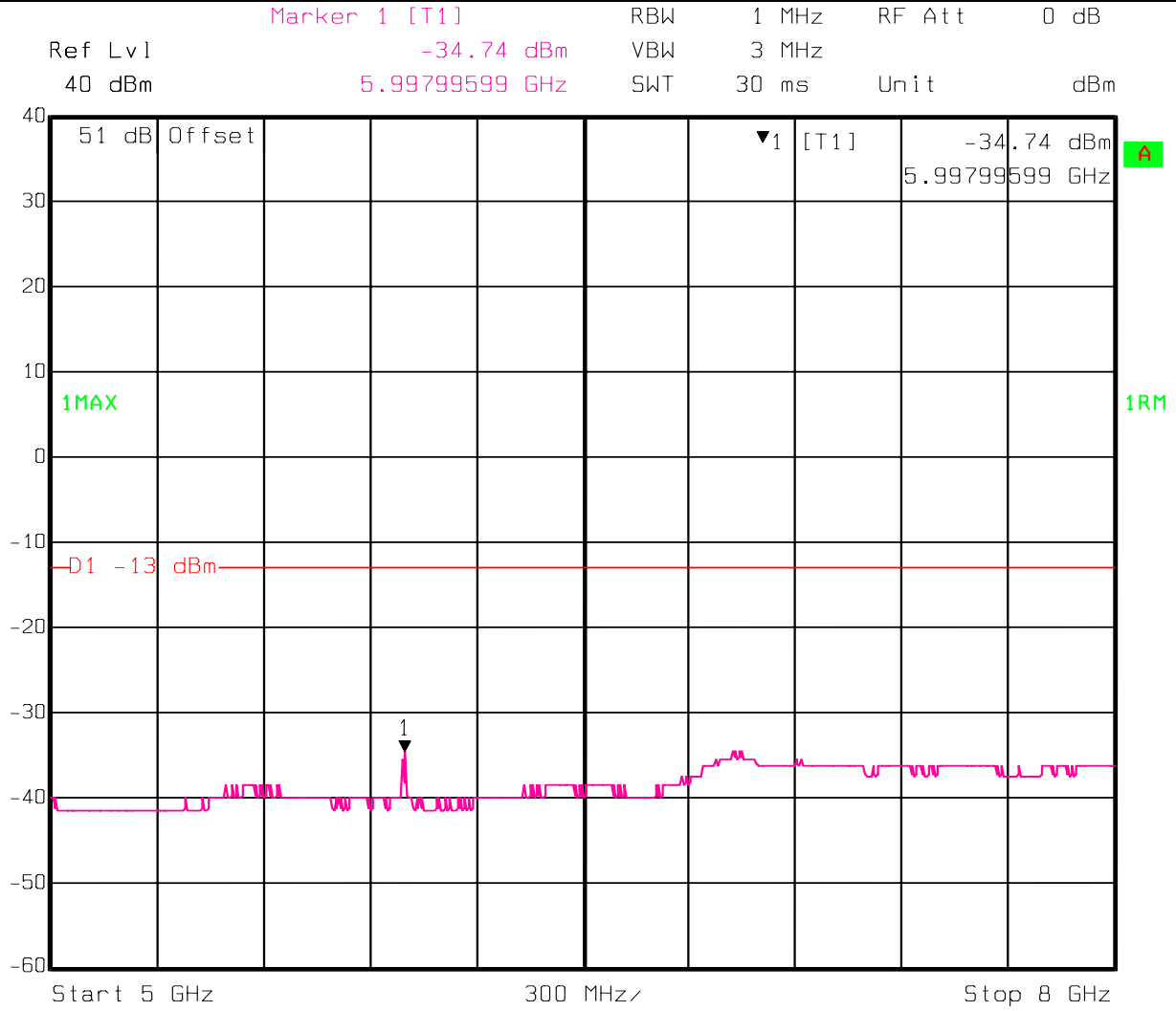

Date: 30.NOV.2004 09:33:24

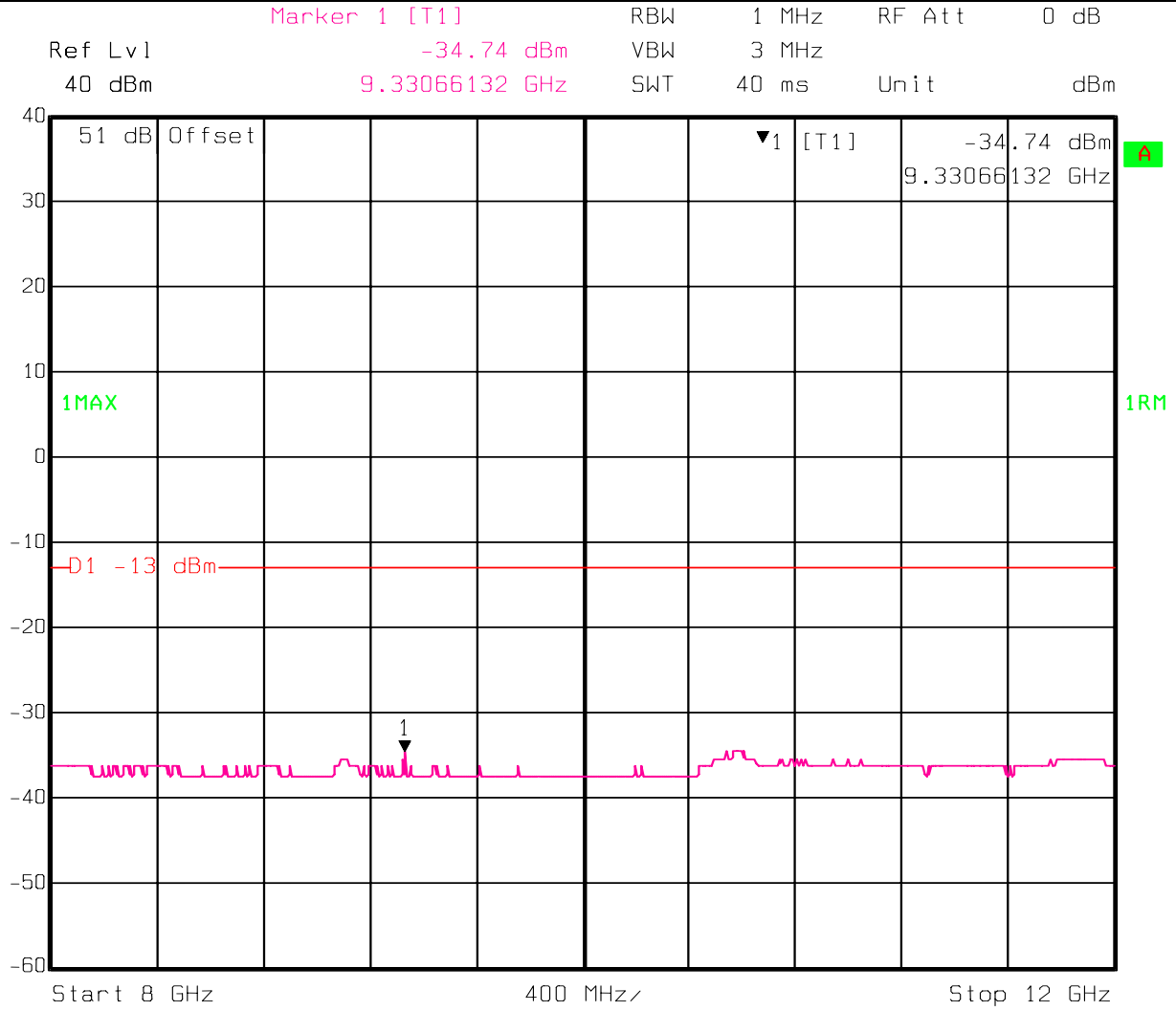

Date: 30.NOV.2004 09:34:32

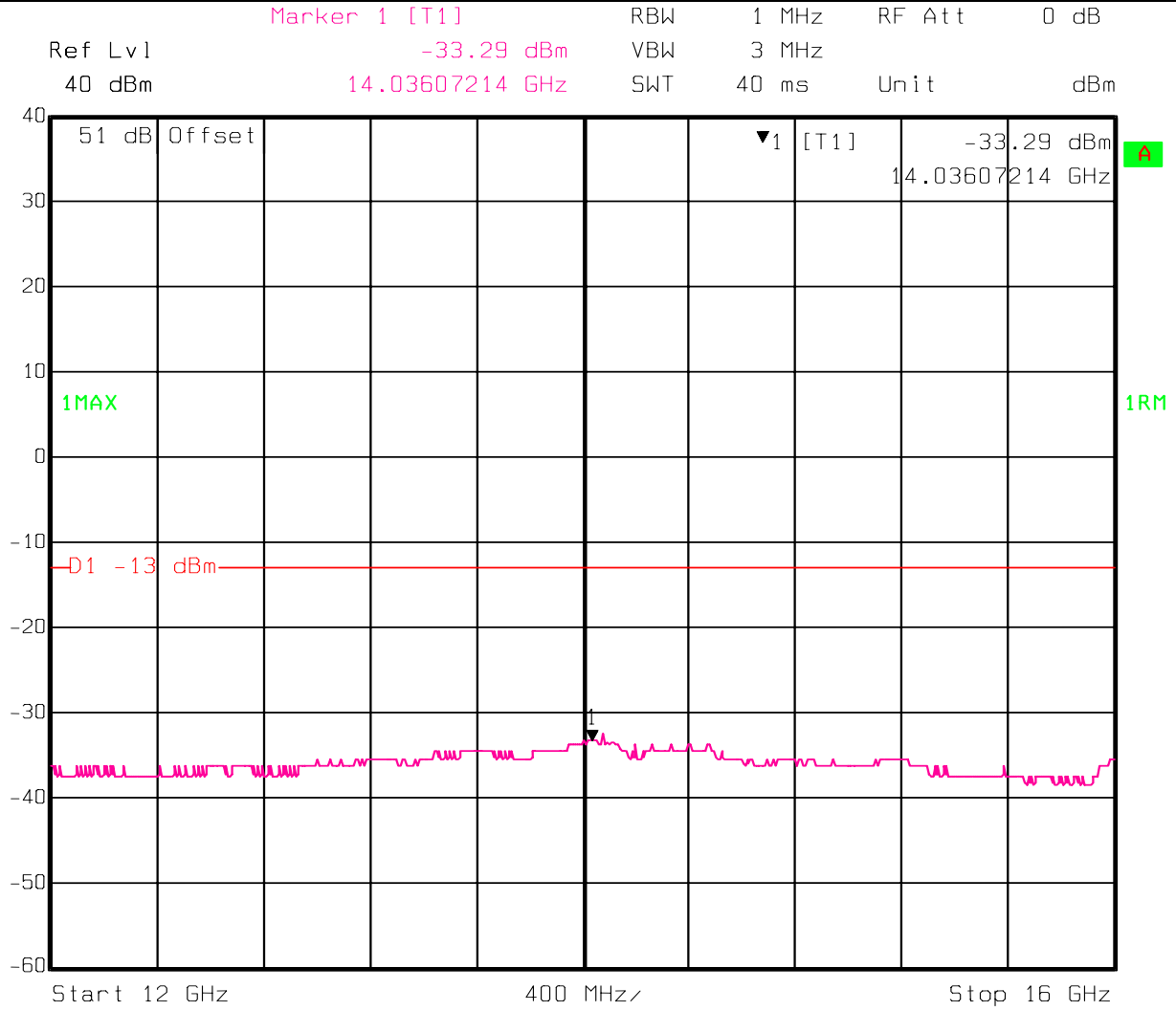

Date: 30.NOV.2004 09:35:08

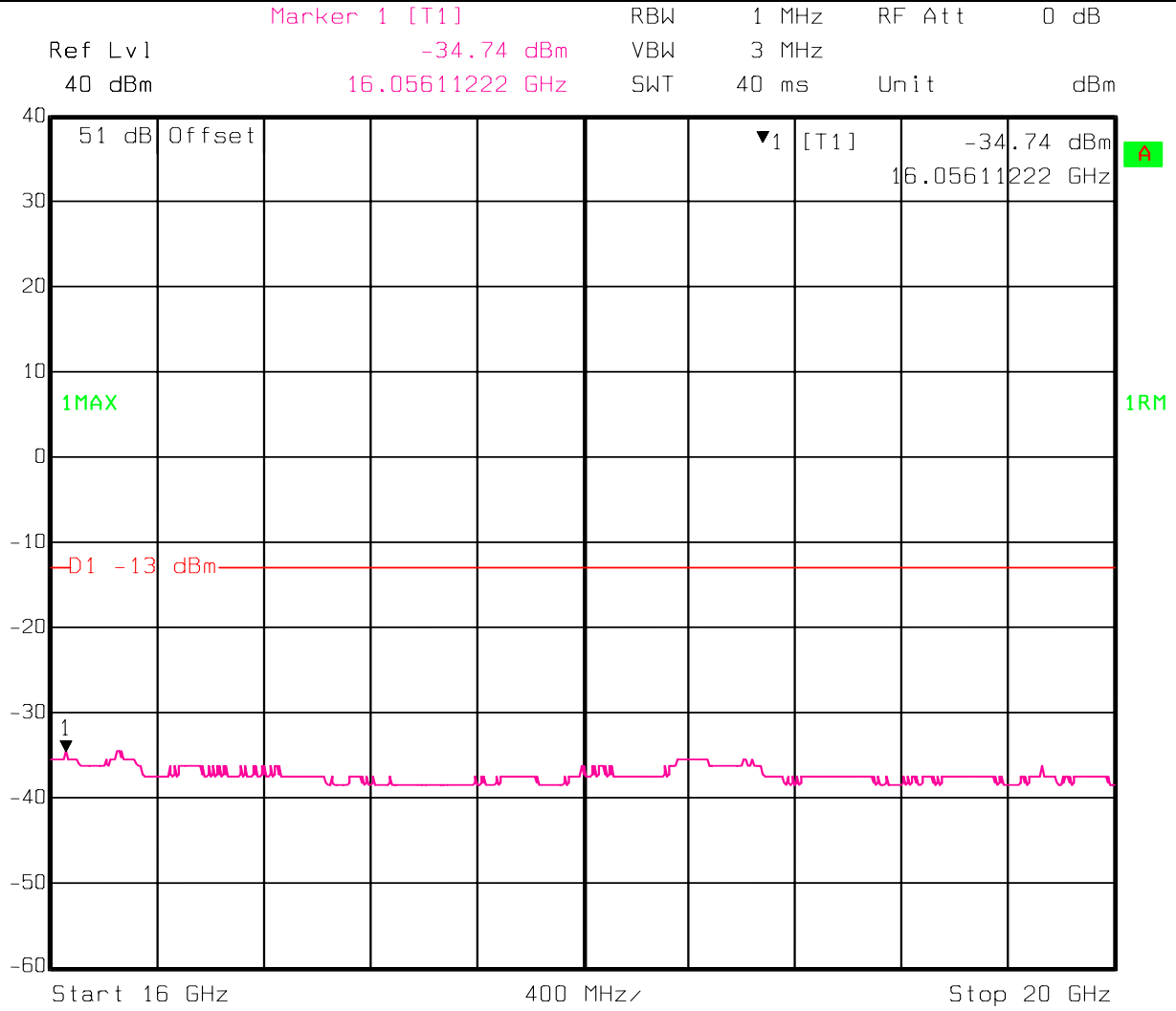

Date: 30.NOV.2004 09:36:01

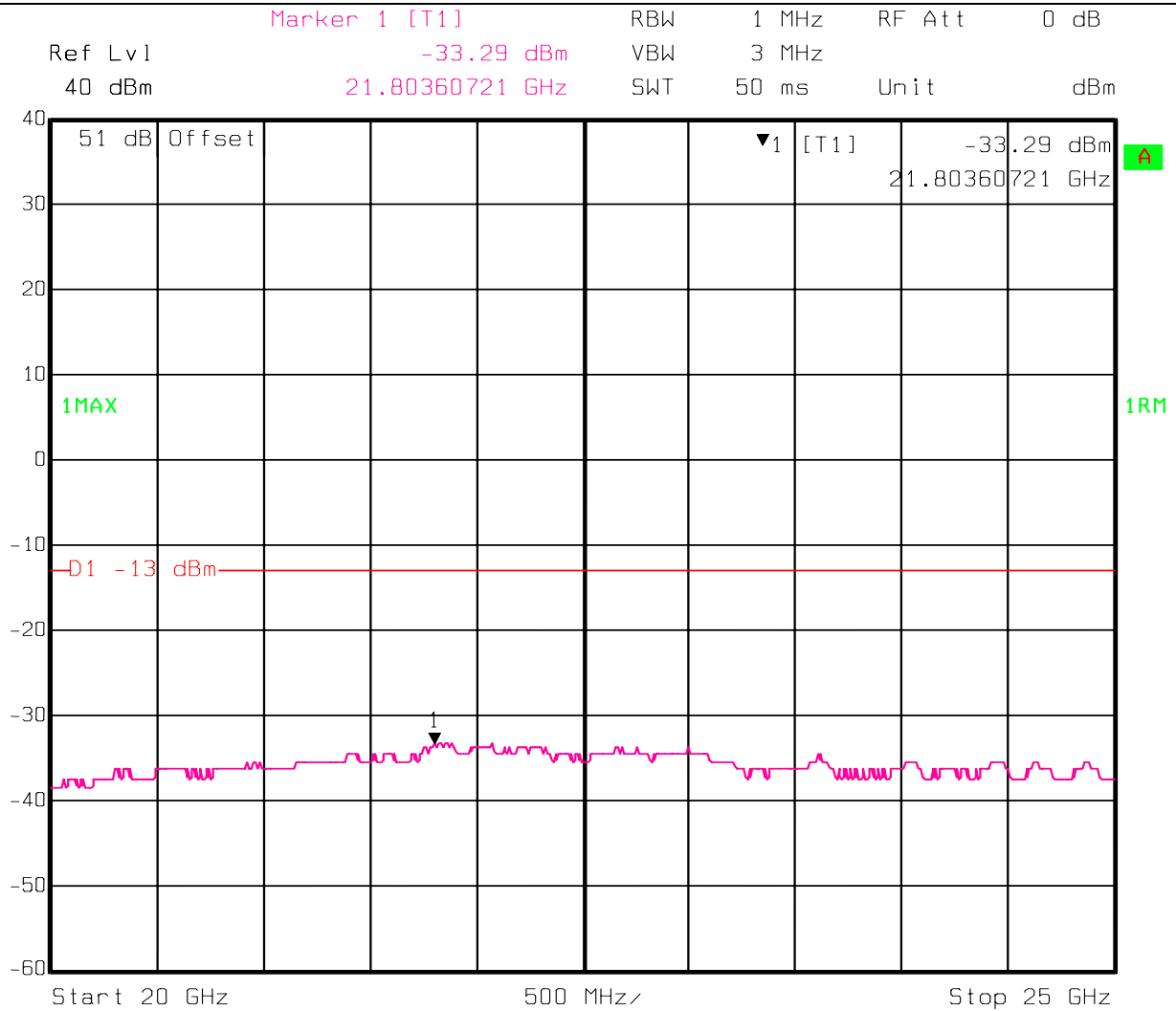

Date: 30.NOV.2004 09:36:52

This report just presented one channel of six to report. The results are typical of all. View the remaining five channels in the Appendix.

Section 12. Field Strength of Spurious

Para. No.: 2.1053

Test Performed By: Alan Laudani	Date of Test: 11-20-2004
--	---------------------------------

Minimum Standard: Part 74.(2)(ii)

Test Results: EUT Complies. Emissions were searched from 30 MHz to 25 GHz with the antenna port terminated into a 50 ohm load. No spurious emissions above 1 GHz within 20 dB of the limit were observed. Emissions between 30 MHz and 1 GHz were searched and two emissions were found and the results proved by substitution.

Test Data: See attached tables.

Quasi-peak measurements with a RBW = VBW = 100 kHz.

Meas. Freq. (MHz)	Ant. Pol. (H/V)	Meter Reading (dBuV/m)	Comment
351	V	46.9	
490	V	37.7	

Results—Substitution

Frequency mHz	target level dBuV/m	dipole	cable loss dB	Signal Generator dBm	Total (EIRP) DBm	Spec dBm	Margin dBm
351	46.9	0	1	-38.1	-39.1	-13.0	-26.1
490	37.7	0	1	-41.3	-42.3	-13.0	-29.3

Location: North OATS, T = 22°C, 40% R.H. 3 meters

No other measurements within 20 dB of the limit noted.

Section 13. Frequency Stability

Para. No.: 2.1055

Test Performed By: A. Laudani	Date of Test: Nov. 22, 2004
--------------------------------------	------------------------------------

Minimum Standard: 2.1055 Frequency Stability vs Temperature Variation and Power Supply Voltage Variation.

Test Results: 221 Hz difference which corresponds to 0.088 ppm
Limit = 0.01 % = 10 ppm or 24,920 Hz

Measurement Data:

Part 2.1055
-30 --- +50 °C
Spectrum Analyzer @ 1 MHz VBW, 1 MHz RBW, Span = 20 MHz
Worst case 220.5 Hz Variation

|
Set Frequency MHz = 2491.9799575

Frequencies are read one minute after turning on EUT, Frequencies are stable

with no variance in ten minutes of turning on.

Temperature/ Time	85% of Vnom Power Level dBm	Vnom = 15 Vdc Power Level dBm	115% of Vnom Power Level dBm
Setpoint °C	Actual Time	Lower Frequency Higher Frequency	Frequency Variation Hz

Temperature/ Time	85% of Vnom Power Level dBm	Vnom = 15 Vdc Power Level dBm	115% of Vnom Power Level dBm
Setpoint °C	Actual Time	Lower Frequency Higher Frequency	Frequency Variation Hz
-30	-30.3 4.45	31.59 2.485607210 2.498032064	2.491819637 -160.321
		30.58 2.485687370 2.498152300	2.491919835 -60.122
		31.64 2.485527054 2.498432870	2.491979962 0.004
-20	-19.8 3.40	31.14 2.486128260 2.498272550	2.492200405 220.448
		31.02 2.485767540 2.498232460	2.492000000 20.043
		31.03 2.485967936 2.498112220	2.492040078 60.121
-10	-9.9 2.35	31.39 2.485847695 2.498172550	2.492010123 30.165
		31.22 2.486128260 2.498272550	2.492200405 220.448
		31.31 2.485887780 2.497951900	2.491919840 -60.117
0	0.0 1.36	31.17 2.486328660 2.497751500	2.492040080 60.122
		30.92 2.486088180 2.498272550	2.492180365 200.407
		31.46 2.486128260 2.497831660	2.491979960 0.003
10	10.0 12.35	31.85 2.485807615 2.498152300	2.491979958 0.000
		31.54 2.485527050 2.498392790	2.491959920 -20.037
		31.13 2.486048096 2.498112224	2.492080160 100.203
20	20.1 8.30	31.81 2.486208170 2.497711420	2.491959795 -20.163
		31.46 2.485847695 2.498112220	2.491979958 0.000
		31.43 2.486328657 2.497951900	2.492140279 160.321
30	30.2 9.35	31.34 2.486088180 2.497831660	2.491959920 -20.037
		31.33 2.485567130 2.498342710	2.491954920 -25.037
		31.31 2.485967936 2.497991980	2.491979958 0.001
40	40.9 10.35	30.67 2.486368737 2.497951900	2.492160319 180.361
		30.55 2.486368737 2.497951900	2.492160319 180.361
		30.10 2.485967936 2.497991980	2.491979958 0.001
50	50.0 11.36	30.72 2.486163400 2.497791580	2.491977490 -2.467
		30.88 2.485846950 2.497751500	2.491799225 -180.732
		30.74 2.486248497 2.497631260	2.491939879 -40.079

Section 14. Block Diagrams

Para. No. 2.1046 - R.F. Power Output

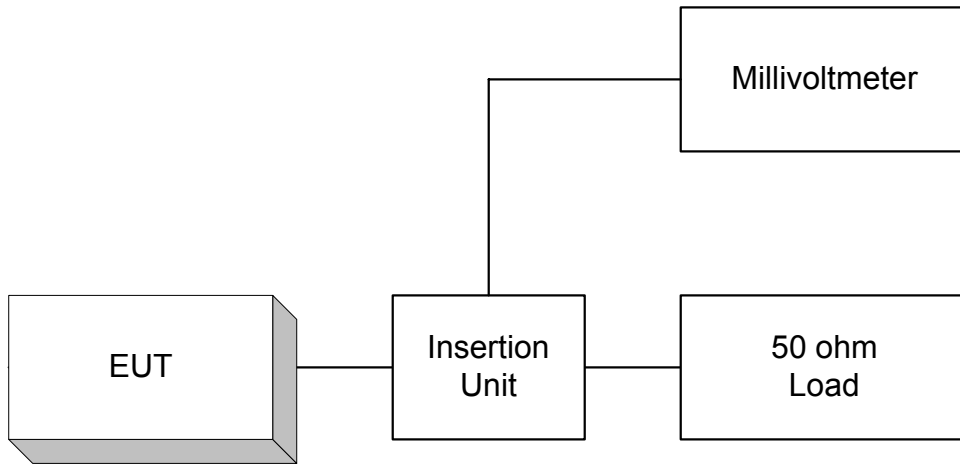

Para. No. 2.1049 - Occupied Bandwidth

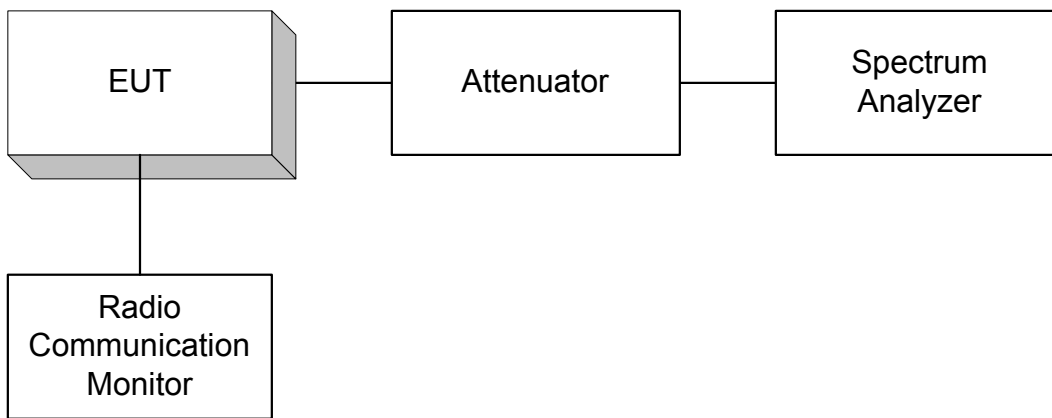

Para. No. 2.1051 Spurious Emissions at Antenna Terminals

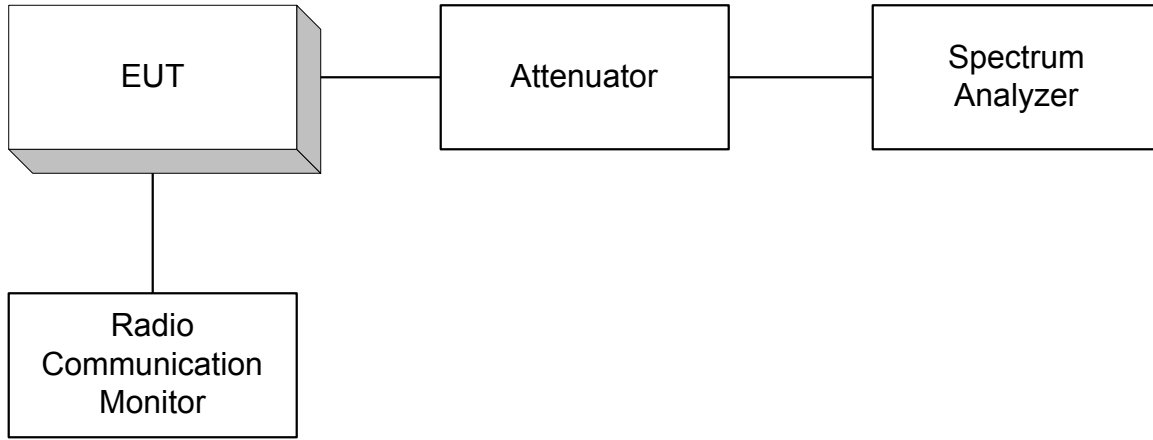

Para. No. 2.1053 - Field Strength of Spurious Radiation

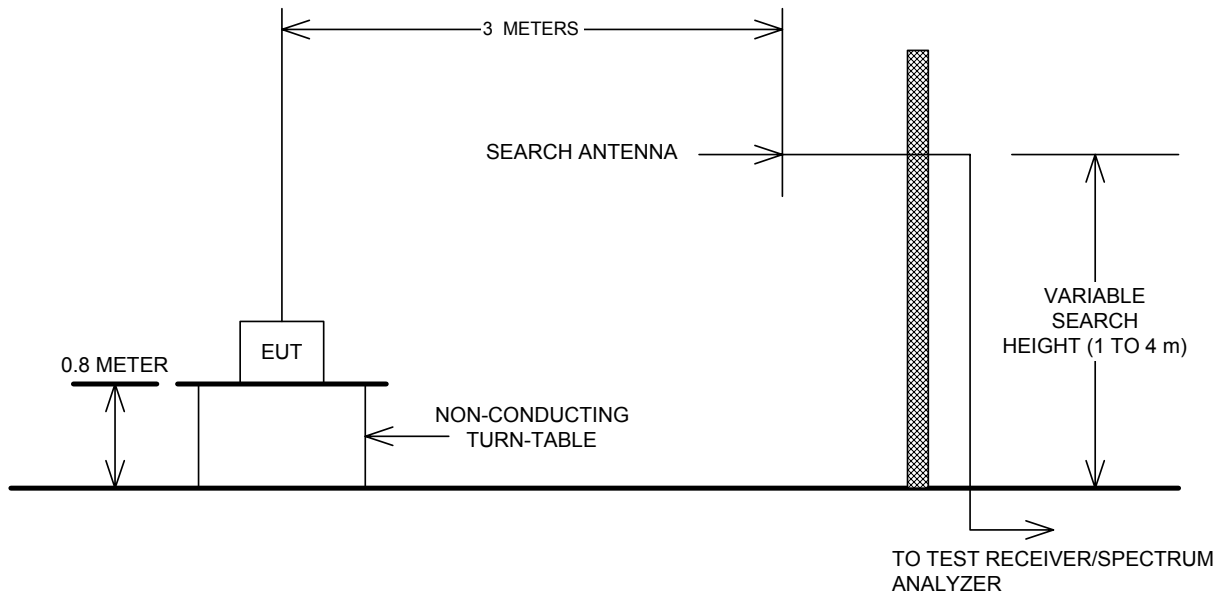

Para. No. 2.1055 - Frequency Stability

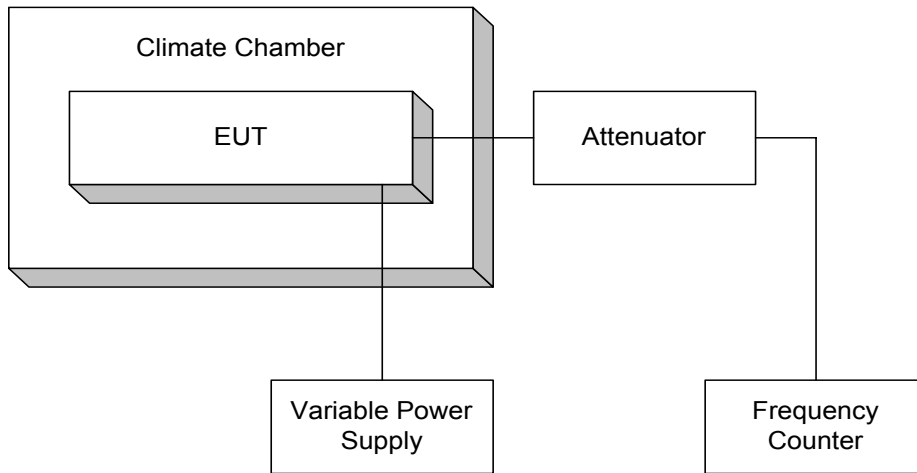

Para. No. 2.1045 – Audio Frequency Response, Audio Low Pass Filter Response And Modulation Limiting

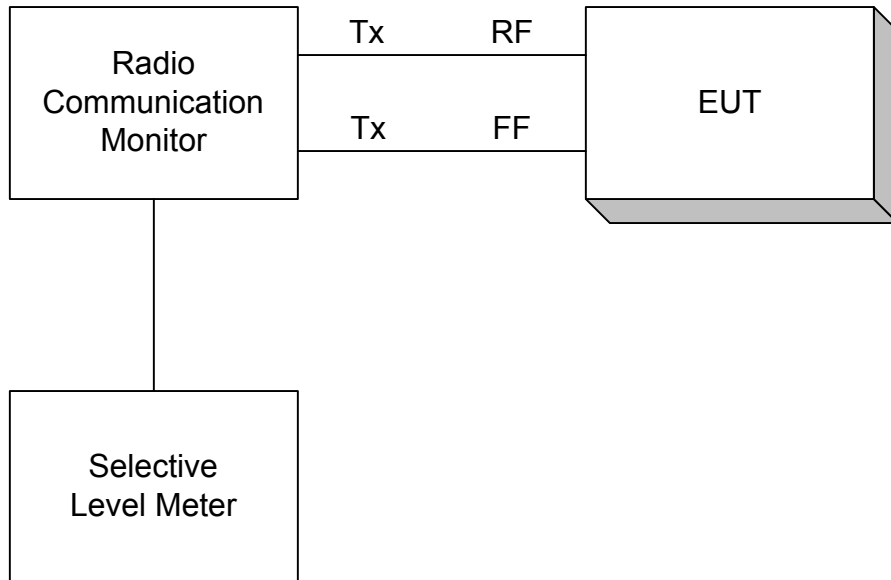

Section 15. Test Equipment List

<i>Device Type</i>	<i>Model #</i>	<i>MFG</i>	<i>Asset #</i>	<i>SN</i>	<i>Cal Due</i>
OATS #1 (North)					
Spectrum Analyzer	1088.3494.30	R & S	835	830320/002	12/11/04
Antenna, Ridged Guide	3115	EMCO	529	2505	3/30/04
Antenna, Ridged Guide	3116	EMCO	625	9611-2325	1/12/05
Preamplifier	40 dB	Miteq	171	NA	NCR
4 GHz High Pass Filter	9SH10-4000	K&L	NA	55	NCR
Antenna, Ridged Guide	3115	EMCO	752	9609-4943	12/19/04
Signal Generator	E8254A	Agilent	836	US41140229	11/6/05
Spectrum Analyzer	8568B	HP	422	2517A01757	3-22-05
Preamplifier	ZHL-2	MINICIR CUITS	635	091887-21	10-22-05
Antenna, Bi-conical	3110	EMCO	116	1287	8-30-05
Antenna, Log Periodic	3146	EMCO	112	9101-2988	10-28-05
Quasi-peak Detector	85650A	HP	533	3145A01672	9-22-05
10dB Attenuator	777C	Narda	na	31073	4-21-05
4GHz HP Filter	92h10-4000	K&L	na	55	NCR
Peak Power Meter	8900D	HP			11-28-04
Environmental Chamber	Thermotron		Na	34946	2-2-05

Appendix A.

The remaining five channels of Conductive Spurious:

Channel 4: 2050.5 MHz

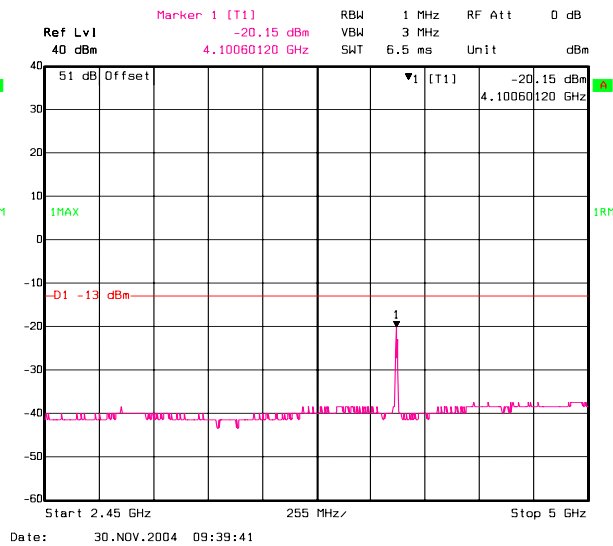
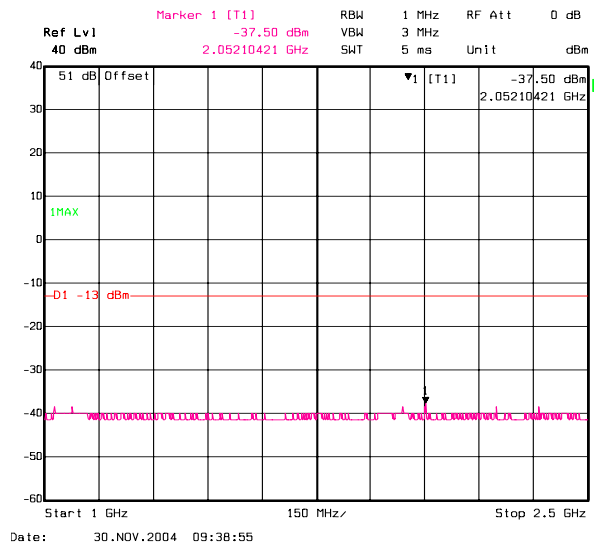
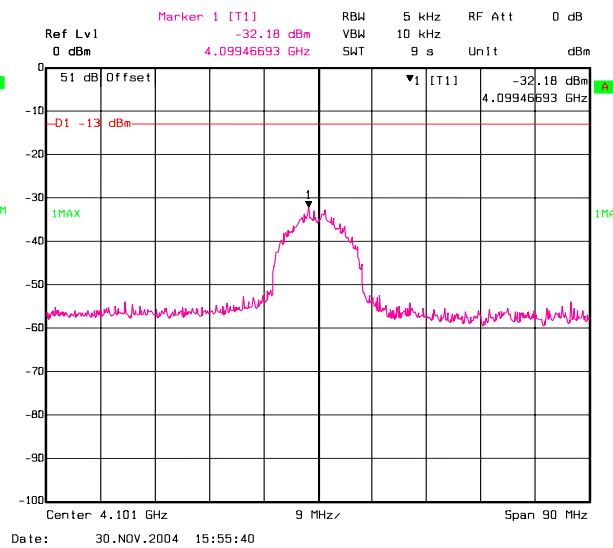
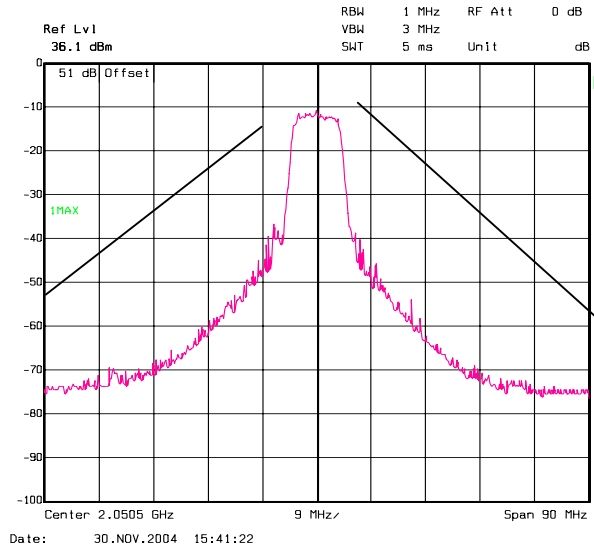

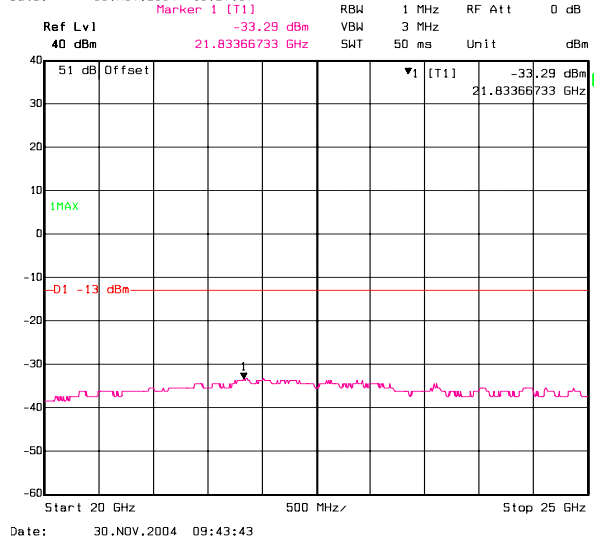
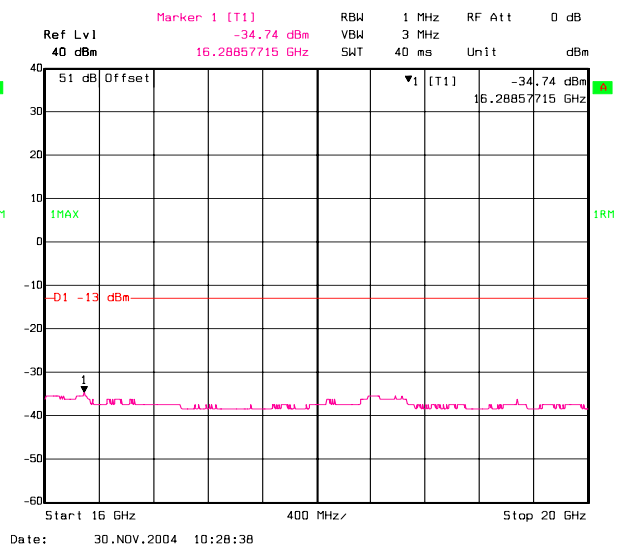
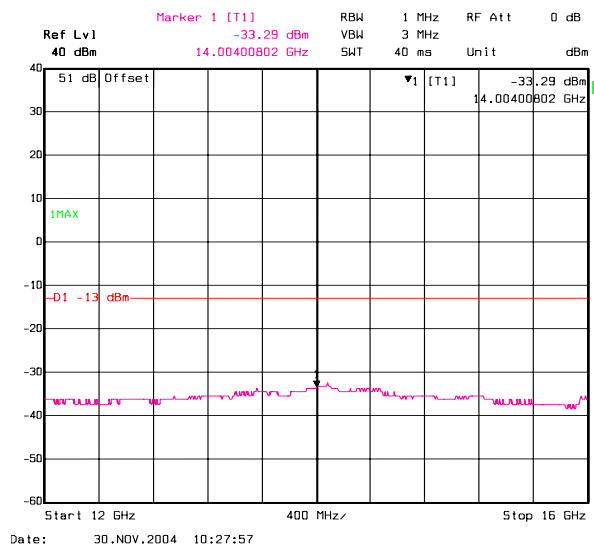
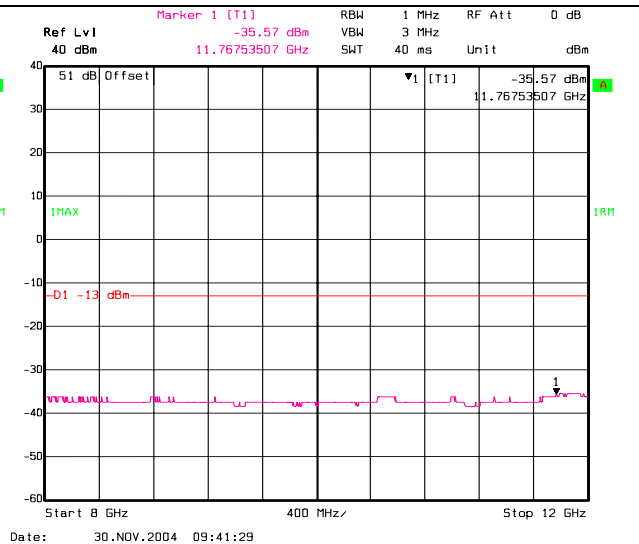
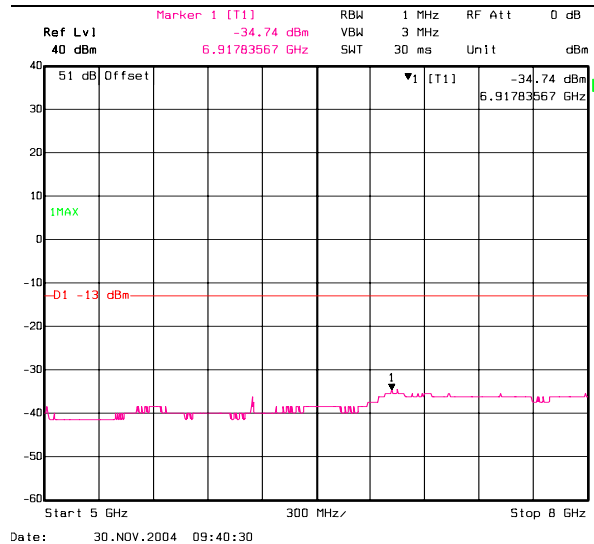

Channel 7: 2101.5 MHz

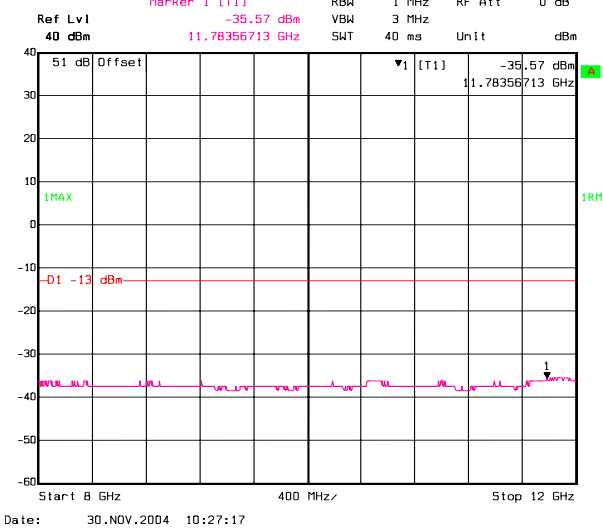
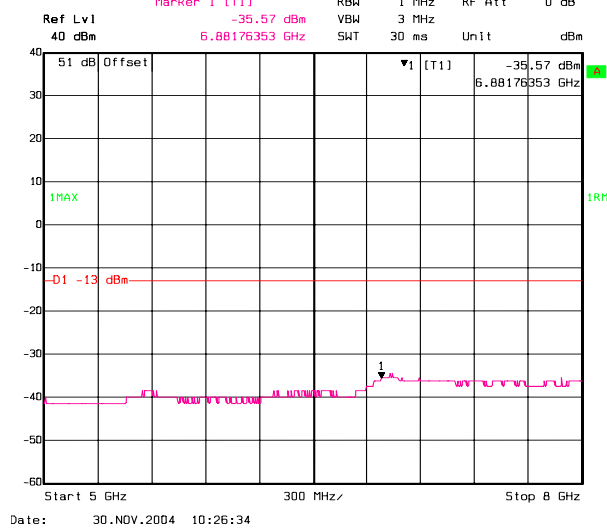
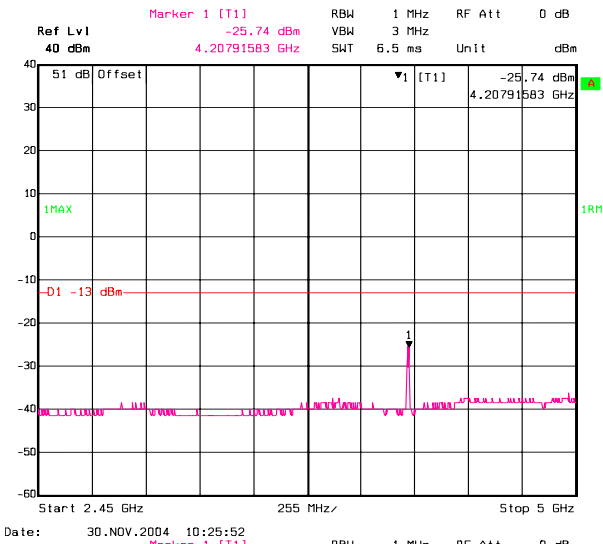
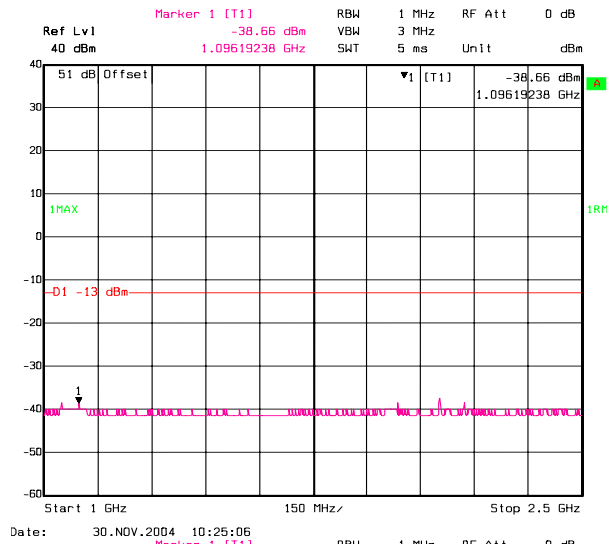
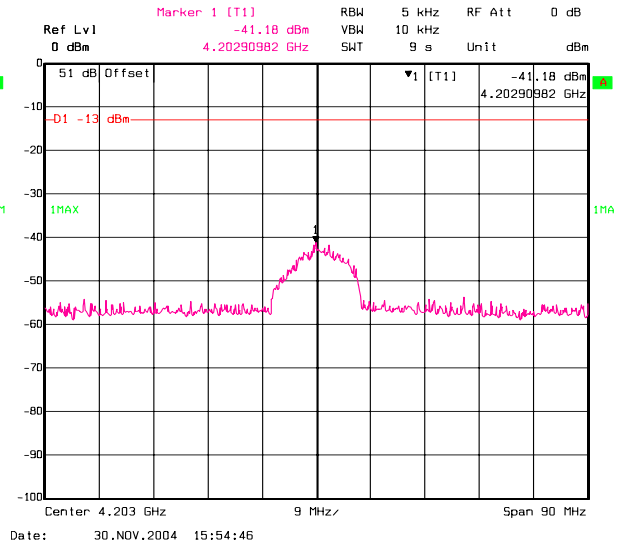
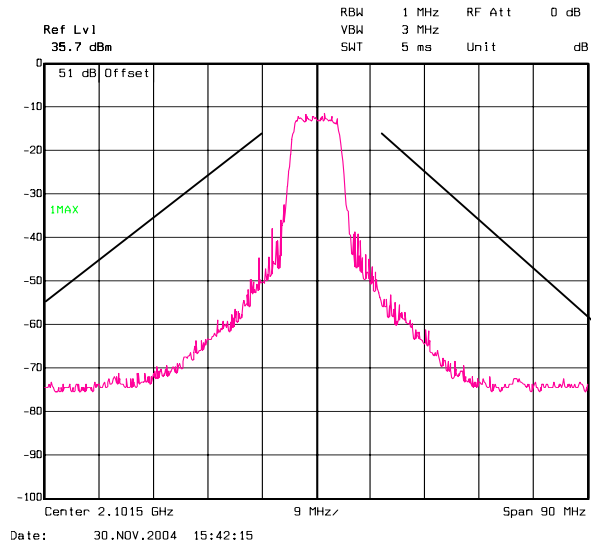

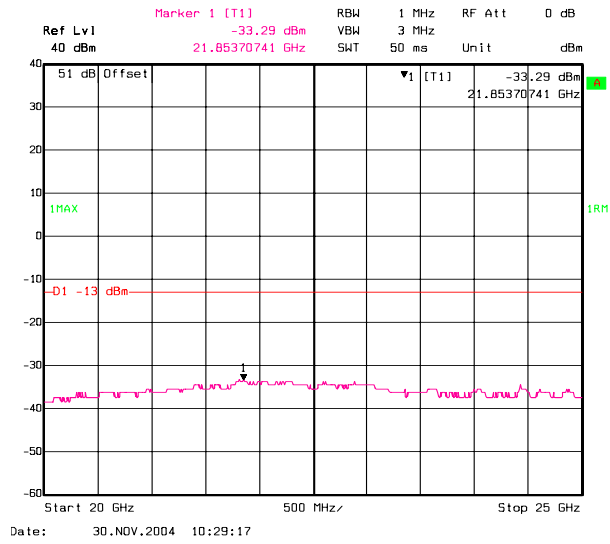
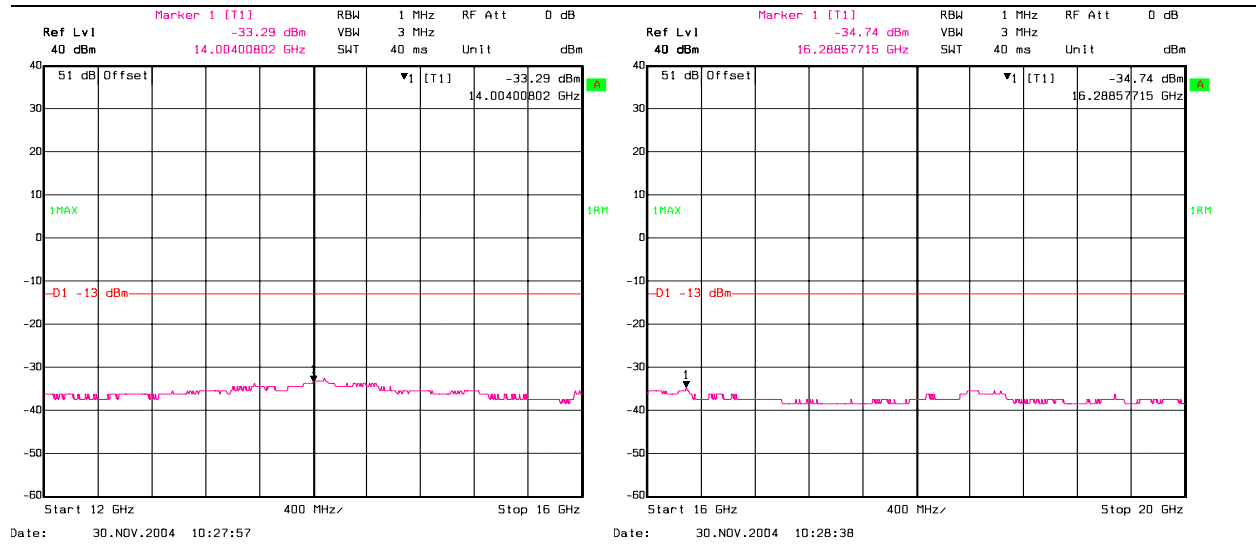

Channel 8: 2458.5 MHz

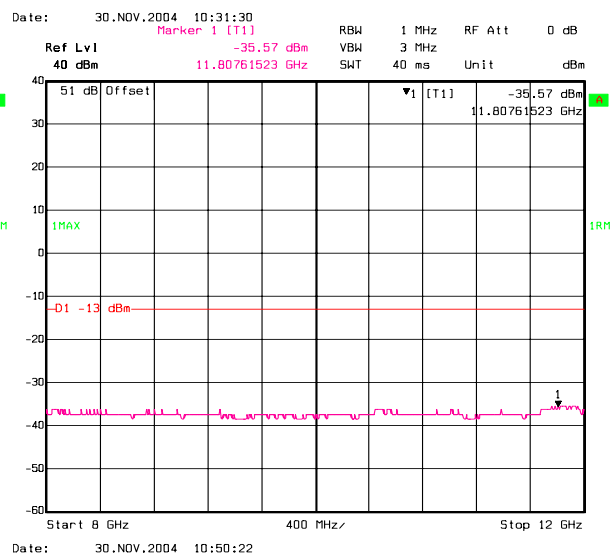
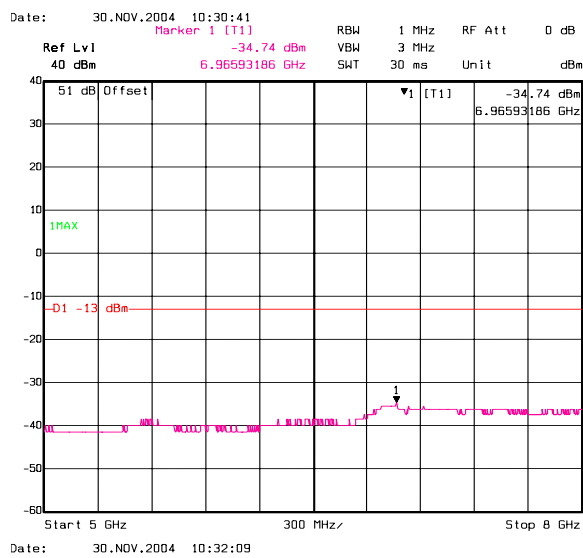
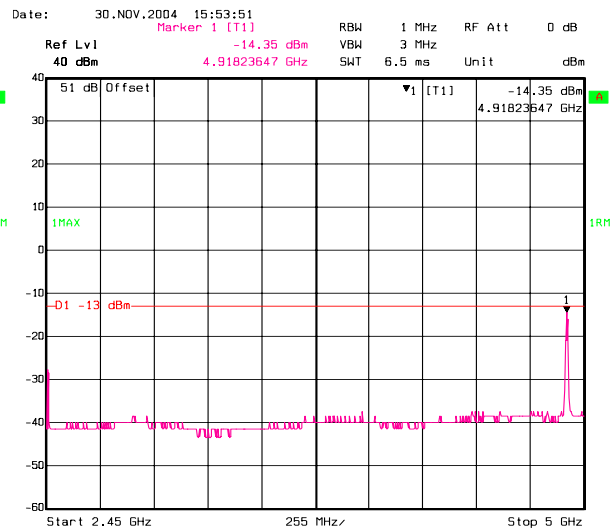
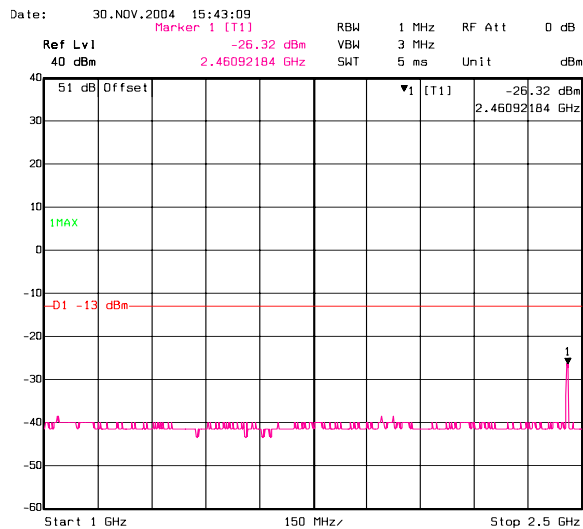
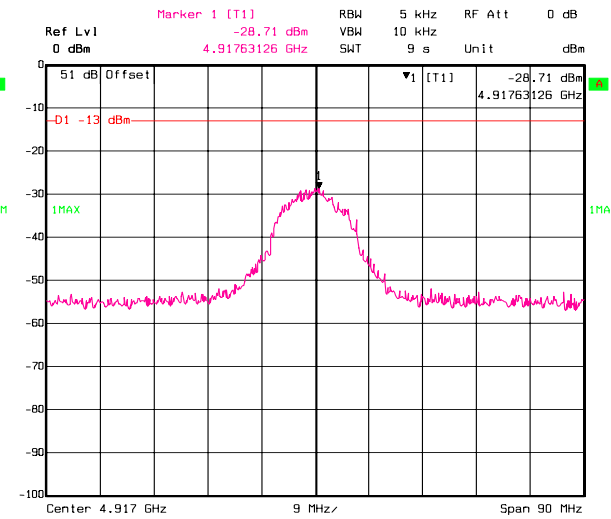
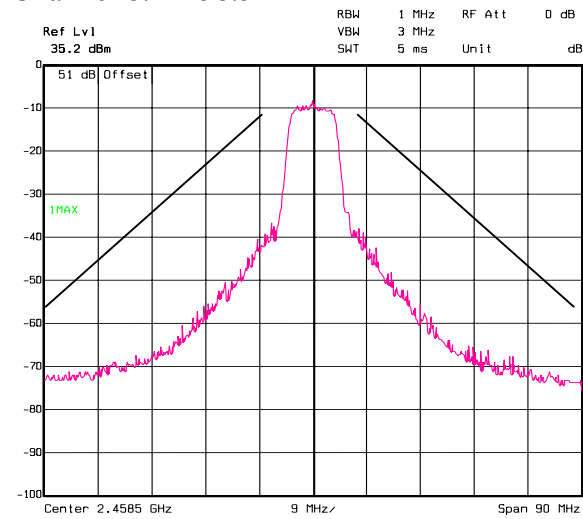

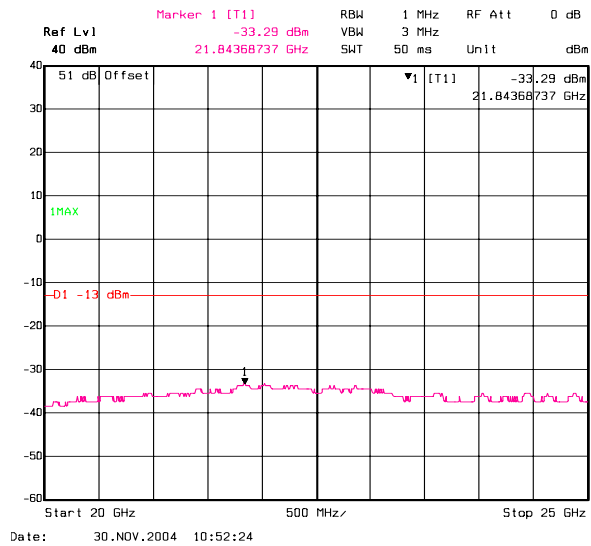
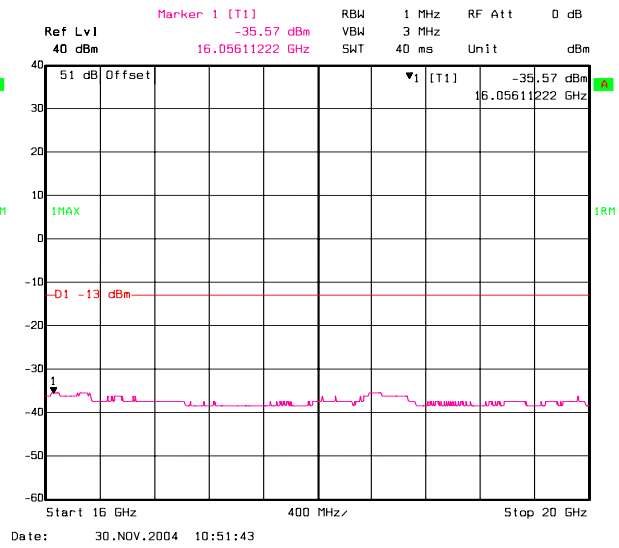
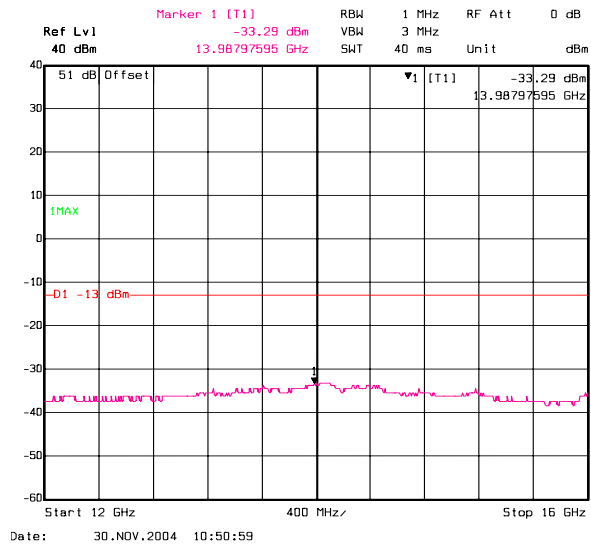

Channel 9: 2475.5 MHz

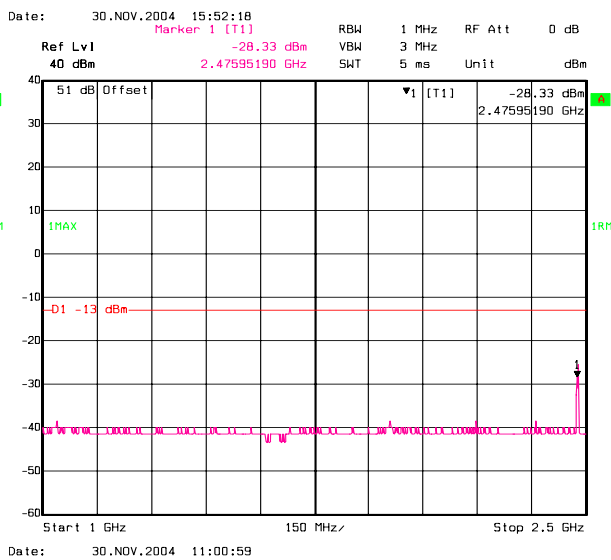
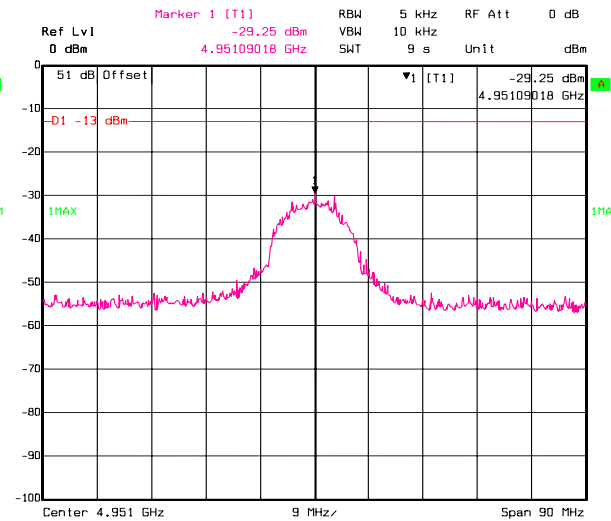
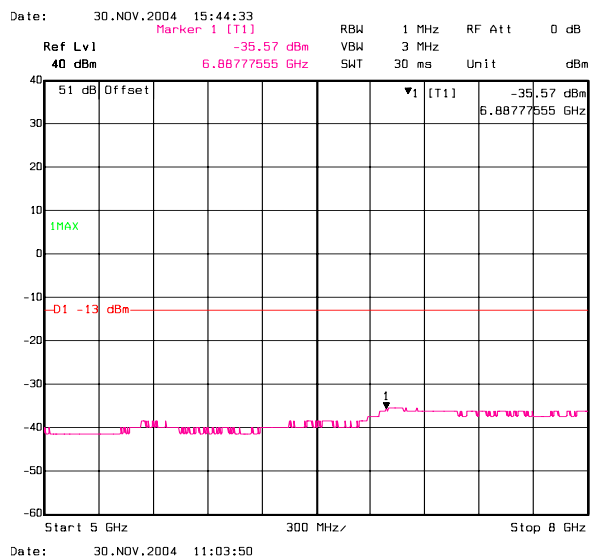
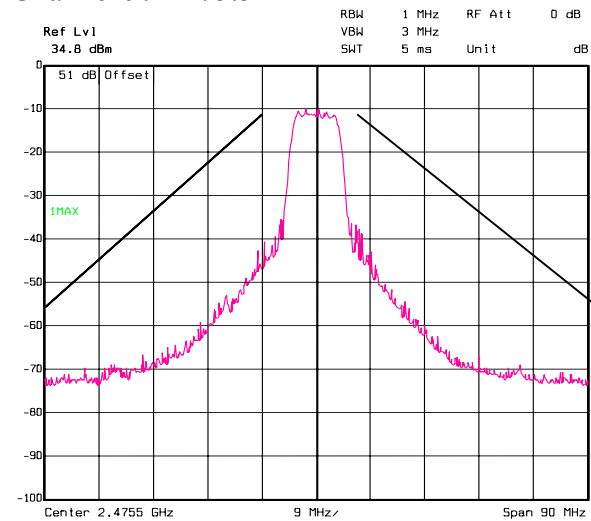

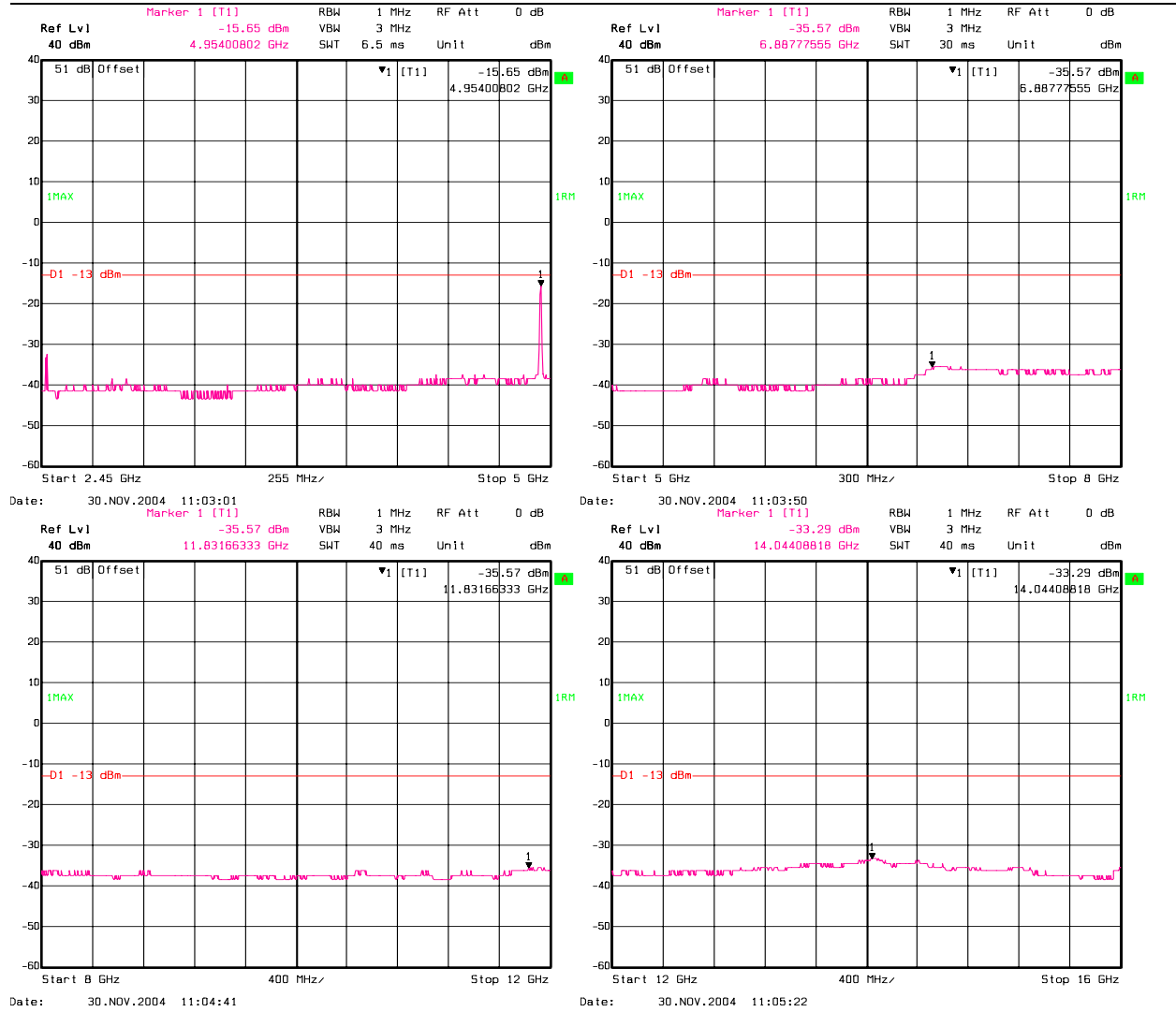

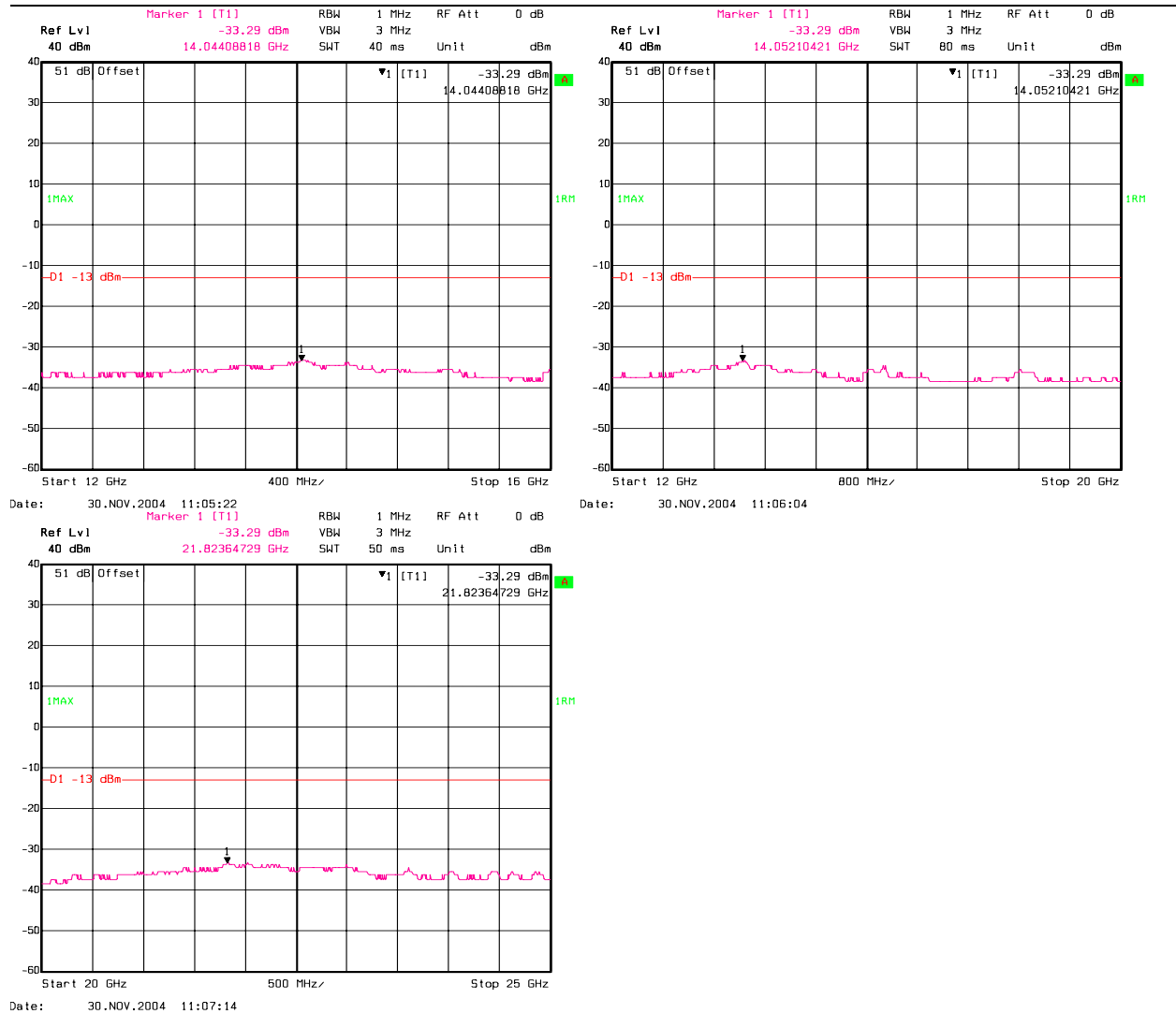

Channel 10: 2492.0 MHz

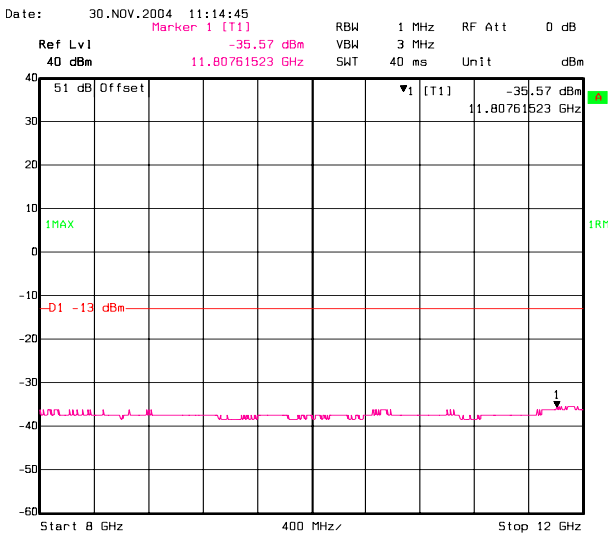
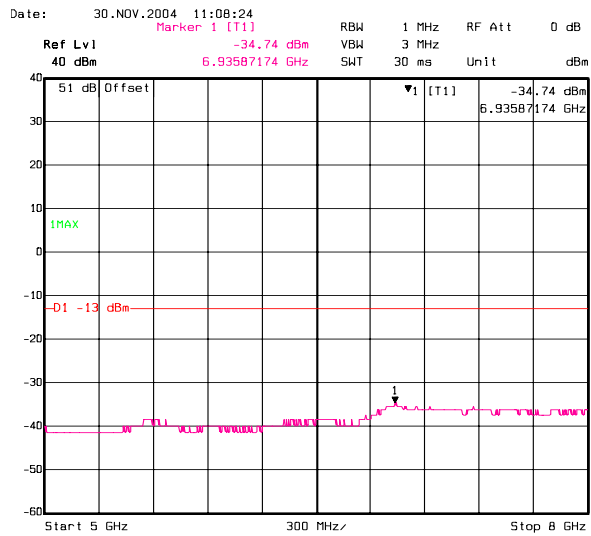
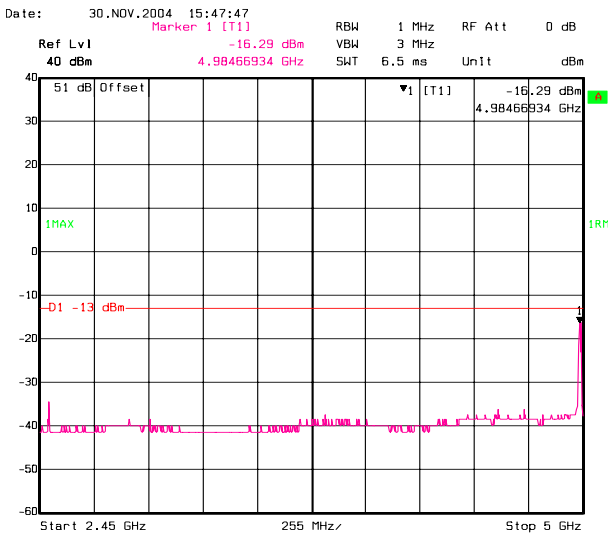
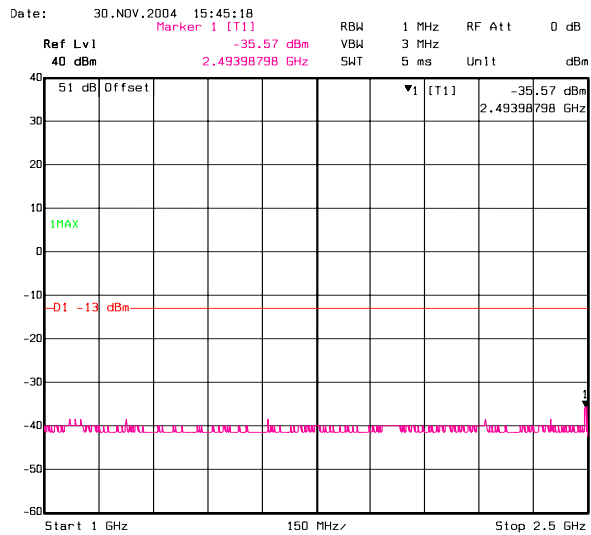
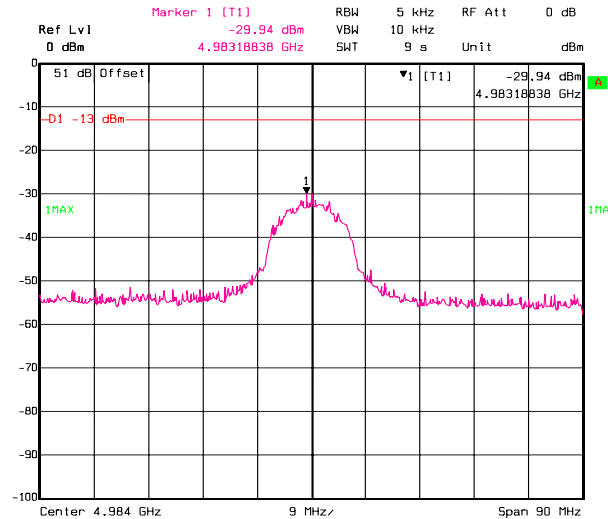
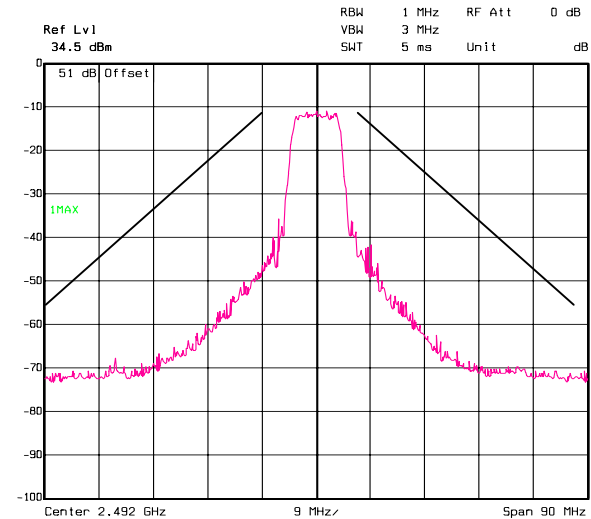

Date: 30.NOV.2004 11:15:34

Date: 30.NOV.2004 11:16:17

