



FCC/ISED - TEST REPORT

Report Number : **68.950.22.0171.01** Date of Issue: 2022-03-16

Model : **STMD1**

Product Type : WiFi/BT Module

Applicant : GoPro, Inc.

Address : 3025 Clearview Way, San Mateo, CA 94402, USA

Manufacturer : GoPro, Inc.

Address : 3025 Clearview Way, San Mateo, CA 94402, USA

Test Result : **Positive** **Negative**

Total pages including Appendices : 64

Any use for advertising purposes must be granted in writing. This technical report may only be quoted in full. This report is the result of a single examination of the object in question and is not generally applicable evaluation of the quality of other products in regular production. For further details, please see testing and certification regulation chapter A-3.4.



1 Table of Contents

1	Table of Contents.....	2
2	Details about the Test Laboratory.....	3
3	Description of the Equipment under Test	4
4	Summary of Test Standards	5
5	Summary of Test Results.....	6
6	General Remarks.....	7
7	Test Setups	8
8	Systems test configuration.....	9
9	Technical Requirement	10
9.1	Conducted Emission	10
9.2	Conducted output power & EIRP	13
9.3	6dB bandwidth.....	15
9.4	99% bandwidth.....	21
9.5	Power spectral density	27
9.6	Spurious RF conducted emissions.....	33
9.7	Band edge	47
9.8	Spurious radiated emissions for transmitter.....	51
10	Test Equipment List.....	63
11	System Measurement Uncertainty	64



2 Details about the Test Laboratory

Details about the Test Laboratory

Test Site 1

Company name: TÜV SÜD Certification and Testing (China) Co., Ltd. Shenzhen Branch
Building 12&13, Zhiheng Wisdomland Business Park,
Nantou Checkpoint Road 2, Nanshan District,
Shenzhen City, 518052,
P. R. China

FCC Designation Number: CN5009

FCC Registration No.: 514049

ISED#: 10320A

Telephone: 86 755 8828 6998
Fax: 86 755 8828 5299

3 Description of the Equipment under Test

Product:	WiFi/BT Module
Model no.:	STMD1
FCC ID:	CNFSTMD1
IC:	10193A-STMD1
PMN:	STMD1
HVIN:	STMD1
Rating:	3.6VDC
RF Transmission Frequency:	2412MHz-2462MHz for 802.11b/g/n20/ac20
No. of Operated Channel:	11
Modulation:	802.11b: BPSK, QPSK, CCK, 802.11g/802.11n20: BPSK, QPSK, 16-QAM, 64-QAM 802.11ac 20: BPSK, QPSK, 16QAM, 64QAM, 256QAM
Antenna Type:	PIFA
Antenna Gain:	1.64dBi max for 2.4GHz
Description of the EUT:	The Equipment Under Test (EUT) is a Wi-Fi/BT Module supports 2.4GHz Bluetooth/WIFI, 5GHz WIFI functions.

4 Summary of Test Standards

Test Standards	
FCC Part 15 Subpart C 10-1-2020 Edition	PART 15 - RADIO FREQUENCY DEVICES Subpart C - Intentional Radiators
RSS-Gen Issue 5, Amendment 2, February 2021	General Requirements and Information for the Certification of Radio Apparatus
RSS-247 Issue 2 February 2017	Digital Transmission Systems (DTSS), Frequency Hopping Systems (FHSS) and License-Exempt Local Area Network (LE-LAN) Devices

All the test methods were according to KDB558074 D01 v05r02 DTS Measurement Guidance and ANSI C63.10 (2013).

5 Summary of Test Results

Technical Requirements			
FCC Part 15 Subpart C/RSS-247 Issue 2/RSS-Gen Issue 5			
Test Condition		Test Result	Test Site
§15.207 RSS-GEN 8.8	Conducted emission AC power port	Pass	Site 1
§15.247 (b) (3) & RSS-247 5.4(d)	Conducted output power	Pass	Site 1
RSS-247 5.4(d)	Equivalent Isotropic Radiated Power	Pass	Site 1
§15.247(e) RSS-247 5.2(b)	Power spectral density	Pass	Site 1
§15.247(a)(2) RSS-247 5.2(a) & RSS-GEN 6.7	6dB bandwidth	Pass	Site 1
§15.247(a)(1) RSS-247 5.1(b)	20dB Occupied bandwidth	N/A	--
RSS-GEN 6.7	99% Occupied Bandwidth	Pass	Site 1
§15.247(a)(1) RSS-247 5.1(b)	Carrier frequency separation	N/A	--
§15.247(a)(1)(iii) RSS-247 5.1(d)	Number of hopping frequencies	N/A	--
§15.247(a)(1)(iii) RSS-247 5.1(d)	Dwell Time	N/A	--
§15.247(d) RSS-247 5.5	Spurious RF conducted emissions	Pass	Site 1
§15.247(d) RSS-247 5.5	Band edge	Pass	Site 1
§15.247(d) & §15.209 & §15.205 RSS-247 5.5 & RSS- Gen 6.13	Spurious radiated emissions for transmitter	Pass	Site 1
§15.203 RSS-Gen 6.8	Antenna requirement	Pass See note 1	--

Remark 1: N/A – Not Applicable.

Note 1: The EUT uses a PIFA antenna, which gain is 1.64dBi. In accordance to §15.203 and RSS-Gen 6.8, it is considered sufficiently to comply with the provisions of this section.



6 General Remarks

Remarks

This submittal(s) (test report) is intended for FCC ID: CNFSTMD1, complies with Section 15.207, 15.209, 15.205, 15.247 of the FCC Part 15, Subpart C.

This submittal(s) (test report) is intended for IC: 10193A-STMD1, complies with RSS-247, RSS-GEN.

The Model: STMD1 supports Bluetooth Low Energy/Bluetooth BR+EDR /WIFI functions

The TX and RX range is 2402MHz-2480MHz for Bluetooth, 2412MHz – 2462MHz for 2.4GHzWIFI, 5180MHz – 5320MHz, 5500MHz – 5720MHz, 5745MHz – 5825MHz for 5GHzWIFI

This report is for the WIFI 2.4GHz part.

SUMMARY:

All tests according to the regulations cited on page 6 were

■ - Performed

□ - **Not** Performed

The Equipment under Test

■ - **Fulfills** the general approval requirements.

□ - **Does not** fulfill the general approval requirements.

Sample Received Date: 2022-02-10

Testing Start Date: 2022-02-10

Testing End Date: 2022-03-08

- TÜV SÜD Certification and Testing (China) Co., Ltd. Shenzhen Branch -

Reviewed by:

Prepared by:

Tested by:



John Zhi
Project Manager

Joe Gu
Project Engineer

Carry Cai
Test Engineer

7 Test Setups

7.1 Radiated test setups

Below 1GHz

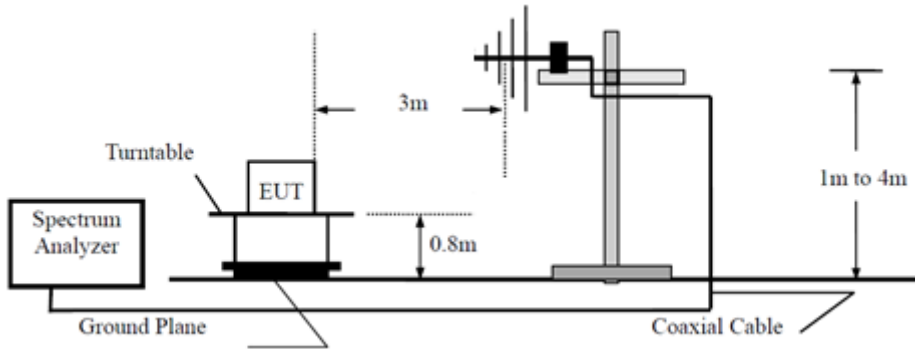

Above 1GHz

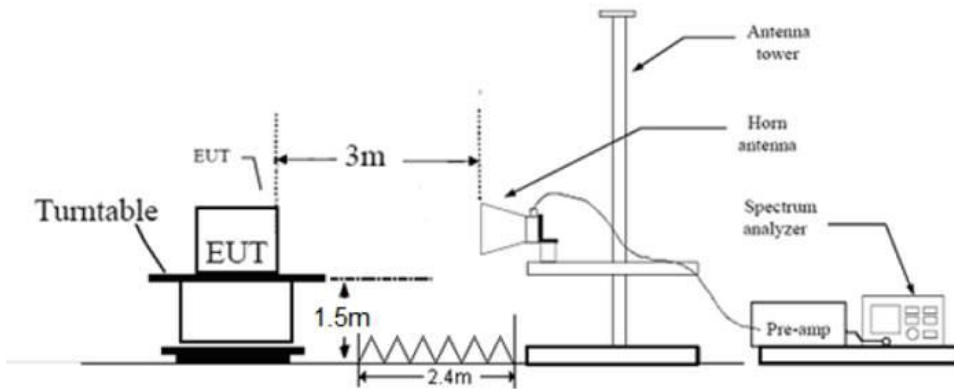

7.2 Conducted RF test setups

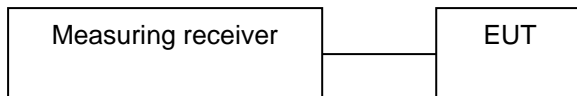

7.3 AC Power Line Conducted Emission test setups

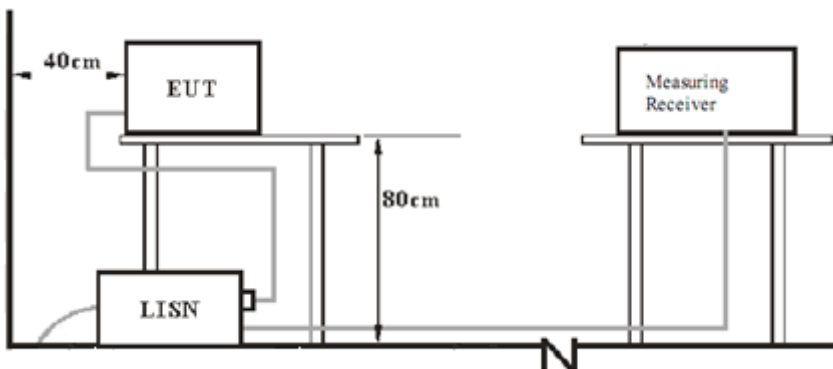

8 Systems test configuration

Auxiliary Equipment Used during Test:

DESCRIPTION	MANUFACTURER	MODEL NO.	S/N
NOTEBOOK	LENOVO	X220	---

Test Channel information:

Test Mode	Channel (MHz)		
802.11b	CH 1: 2412MHz	CH 6: 2437MHz	CH 11: 2462MHz
802.11g	CH 1: 2412MHz	CH 6: 2437MHz	CH 11: 2462MHz
802.11n20	CH 1: 2412MHz	CH 6: 2437MHz	CH 11: 2462MHz
802.11ac20	CH 1: 2412MHz	CH 6: 2437MHz	CH 11: 2462MHz

9 Technical Requirement

9.1 Conducted Emission

Test Method

1. The EUT was placed 0.4 meter from the conducting wall of the shielding room was kept at least 80 centimeters from any other grounded conducting surface.
2. Connect EUT to the power mains through a line impedance stabilization network (LISN).
3. All the support units are connecting to the other LISN.
4. The LISN provides 50 ohm coupling impedance for the measuring instrument.
5. Both sides of AC line were checked for maximum conducted interference.
6. The frequency range from 150 kHz to 30 MHz was searched.
7. Set the test-receiver system to Peak Detect Function and specified bandwidth (IF Bandwidth = 9kHz) with Maximum Hold Mode. Then measurement is also conducted by Average Detector and Quasi-Peak Detector Function respectively

Limit According to §15.207, conducted emissions limit as below:

Frequency MHz	QP Limit dB μ V	AV Limit dB μ V
0.150-0.500	66-56*	56-46*
0.500-5	56	46
5-30	60	50

*Decreasing linearly with logarithm of the frequency

Conducted Emission

Product Type : WiFi/BT Module
 M/N : STMD1
 Operating Condition : Charging + TX
 Test Specification : Power Line, Neutral
 Comment : AC 120V/60Hz (Notebook)

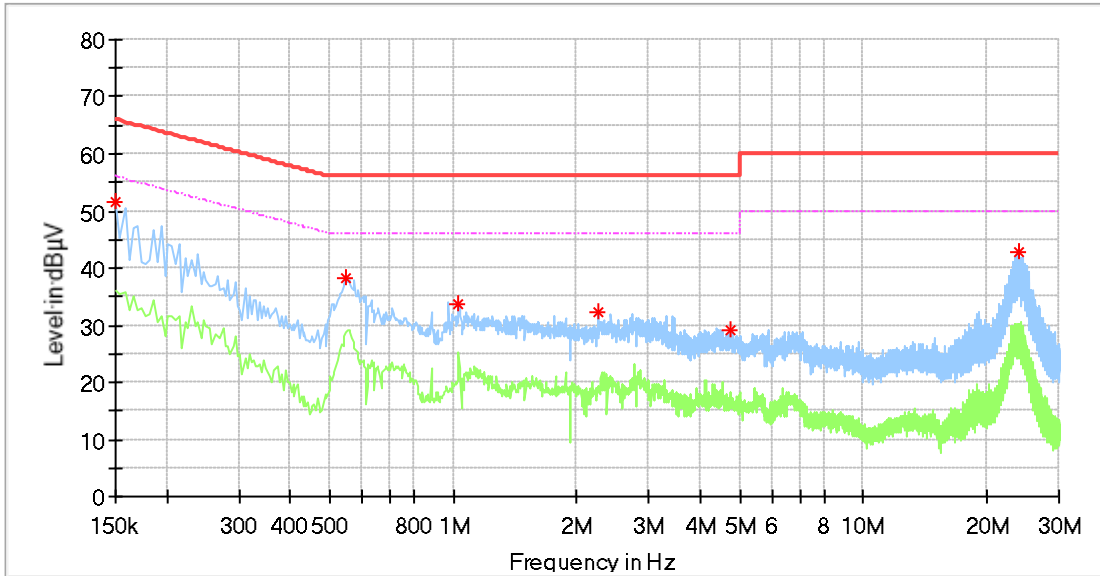

Frequency (MHz)	MaxPeak (dBµV)	Average (dBµV)	Limit (dBµV)	Margin (dB)	Line	Corr. (dB)
0.150000	51.56	---	66.00	14.44	L1	9.74
0.546000	38.17	---	56.00	17.83	L1	9.65
1.030000	33.56	---	56.00	22.44	L1	9.66
2.262000	32.27	---	56.00	23.73	L1	9.70
4.746000	29.19	---	56.00	26.81	L1	9.81
24.038000	42.66	---	60.00	17.34	L1	10.42

Remark :
 Level=Reading Level + Correction Factor
 Correction Factor=Cable Loss + LISN Factor
 (The Reading Level is recorded by software which is not shown in the sheet)

Conducted Emission

Product Type : WiFi/BT Module
 M/N : STMD1
 Operating Condition : Charging + TX
 Test Specification : Power Line, Neutral
 Comment : AC 120V/60Hz (Notebook)

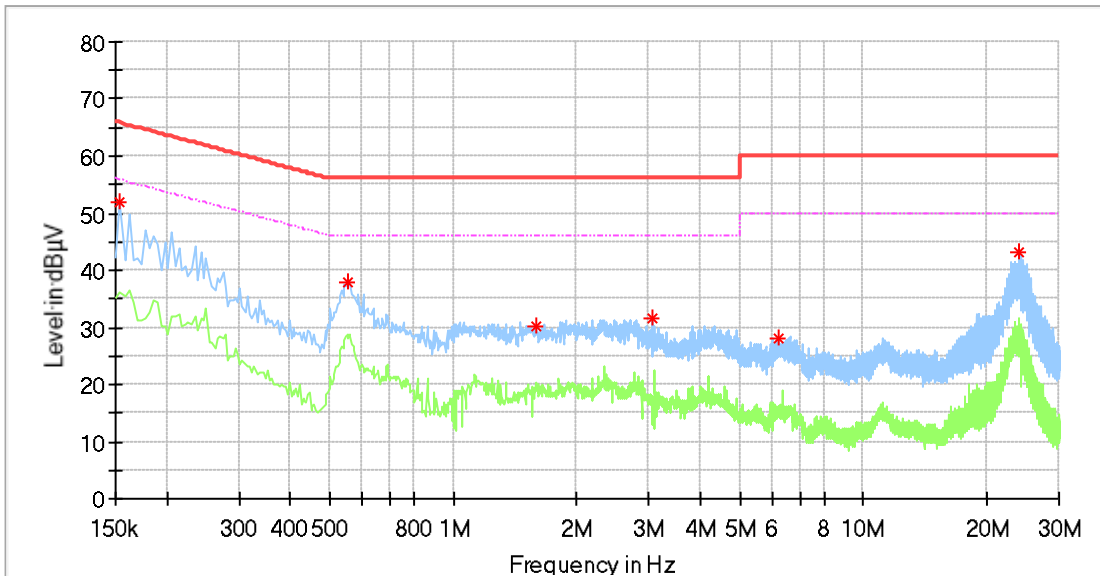

Frequency (MHz)	MaxPeak (dBµV)	Average (dBµV)	Limit (dBµV)	Margin (dB)	Line	Corr. (dB)
0.154000	51.78	---	65.78	14.00	N	9.78
0.550000	38.04	---	56.00	17.96	N	9.68
1.590000	30.34	---	56.00	25.66	N	9.72
3.054000	31.62	---	56.00	24.38	N	9.78
6.222000	27.97	---	60.00	32.03	N	9.94
24.018000	43.27	---	60.00	16.73	N	10.79

Remark :

Level=Reading Level + Correction Factor

Correction Factor=Cable Loss + LISN Factor

(The Reading Level is recorded by software which is not shown in the sheet)



9.2 Conducted output power & EIRP

Test Method

1. The EUT was placed on 0.8m height table, the RF output of EUT was connected to the power meter by RF cable. The path loss was compensated to the results for each measurement.
2. Setting the highest output power level of the EUT
3. Record the power value.

Limits

According to §15.247 (b) (3) & RSS-247 5.4(d), conducted output power limit as below:

Frequency Range MHz	Limit W	Limit dBm
2400-2483.5	≤1	≤30

According to & RSS-247 5.4(d), EIRP limit as below:

Frequency Range MHz	Limit W	Limit dBm
2400-2483.5	≤4	≤36.2

Test result as below table

802.11B_SISO modulation Test Result

Frequency (MHz)	Conducted Output Power (dBm)	Antenna Gain (dBi)	EIRP (dBm)	Result
Low channel 2412MHz	19.39	1.64	21.03	Pass
Middle channel 2437MHz	19.50	1.64	21.14	Pass
High channel 2462MHz	19.47	1.64	21.11	Pass

802.11G_SISO modulation Test Result

Frequency (MHz)	Conducted Output Power (dBm)	Antenna Gain (dBi)	EIRP (dBm)	Result
Low channel 2412MHz	17.72	1.64	19.36	Pass
Middle channel 2437MHz	17.84	1.64	19.48	Pass
High channel 2462MHz	17.67	1.64	19.31	Pass

802.11N20_SISO modulation Test Result

Frequency (MHz)	Conducted Output Power (dBm)	Antenna Gain (dBi)	EIRP (dBm)	Result
Low channel 2412MHz	16.50	1.64	18.14	Pass
Middle channel 2437MHz	17.80	1.64	19.44	Pass
High channel 2462MHz	17.60	1.64	19.24	Pass

802.11AC20_SISO modulation Test Result

Frequency (MHz)	Conducted Output Power (dBm)	Antenna Gain (dBi)	EIRP (dBm)	Result
Low channel 2412MHz	16.50	1.64	18.14	Pass
Middle channel 2437MHz	16.60	1.64	18.24	Pass
High channel 2462MHz	16.80	1.64	18.44	Pass



9.3 6dB bandwidth

Test Method

1. Connect EUT test port to spectrum analyzer.
2. Use the following spectrum analyzer settings:
RBW=100K, VBW≥3RBW, Sweep = auto, Detector function = peak, Trace = max hold
3. Use the automatic bandwidth measurement capability of an instrument, may be employed using the X dB bandwidth mode with X set to 6 dB, care shall be taken so that the bandwidth measurement is not influenced by any intermediate power nulls in the fundamental emission that might be ≥ 6 dB.
4. Allow the trace to stabilize, record the X dB Bandwidth value.

Limit

Limit [kHz]

≥500

Test result

TestMode	Channel	DTS BW [MHz]	Limit [MHz]	Verdict
11B	2412	8.120	0.5	PASS
	2437	9.080	0.5	PASS
	2462	9.080	0.5	PASS
11G	2412	16.400	0.5	PASS
	2437	16.400	0.5	PASS
	2462	16.120	0.5	PASS
11N20SISO	2412	17.000	0.5	PASS
	2437	17.240	0.5	PASS
	2462	16.600	0.5	PASS
11AC20SISO	2412	17.360	0.5	PASS
	2437	17.240	0.5	PASS
	2462	17.120	0.5	PASS

Test Graphs

11B_Ant1_2412

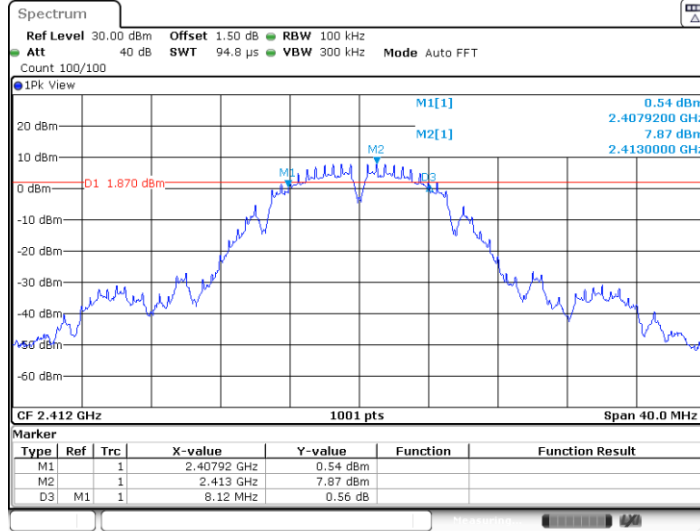

Date: 2 MAR 2022 16:49:44

11B_Ant1_2437

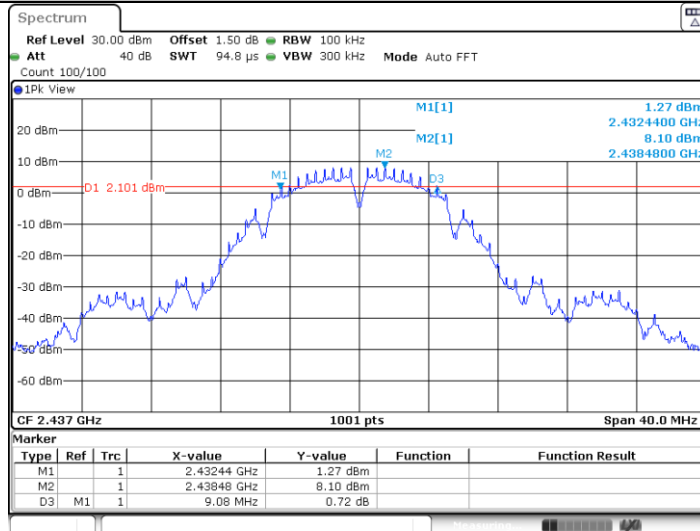

Date: 2 MAR 2022 16:50:39

11B_Ant1_2462

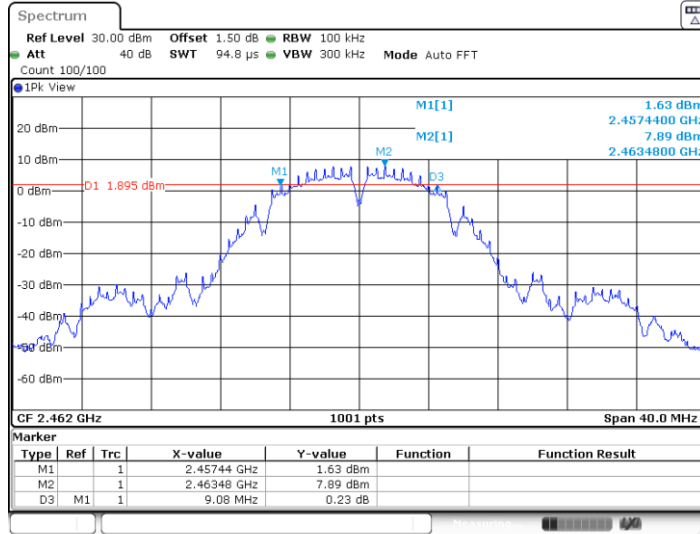

Date: 2 MAR 2022 16:51:46

11G_Ant1_2412

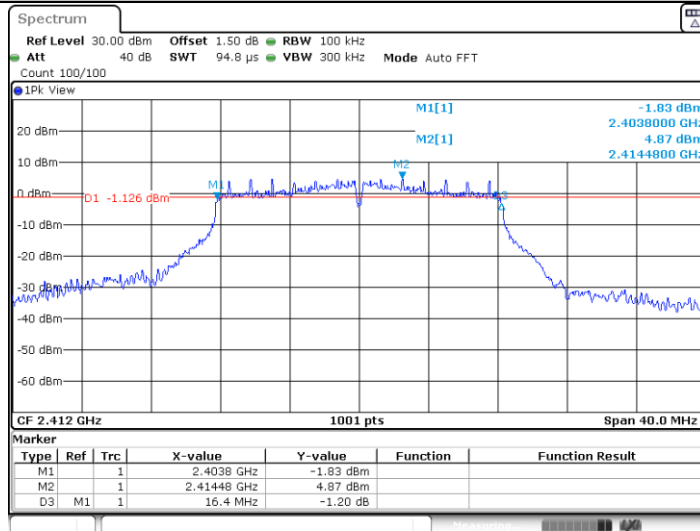

Date: 15 FEB 2022 14:33:43

11G_Ant1_2437

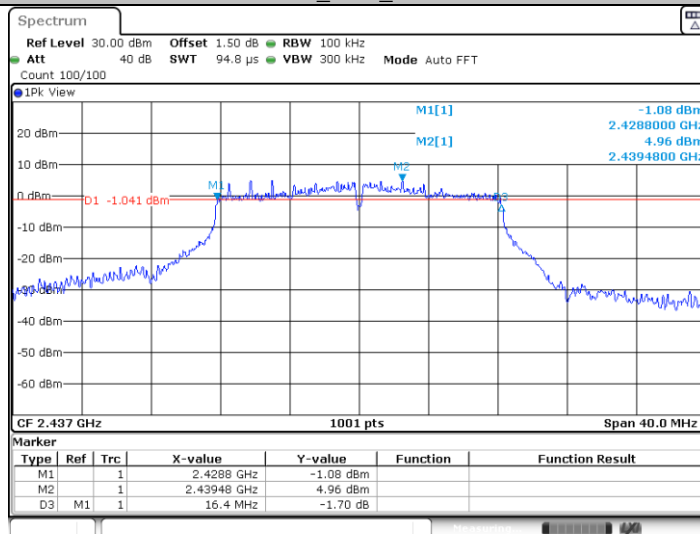

Date: 15 FEB 2022 14:35:13

11G_Ant1_2462

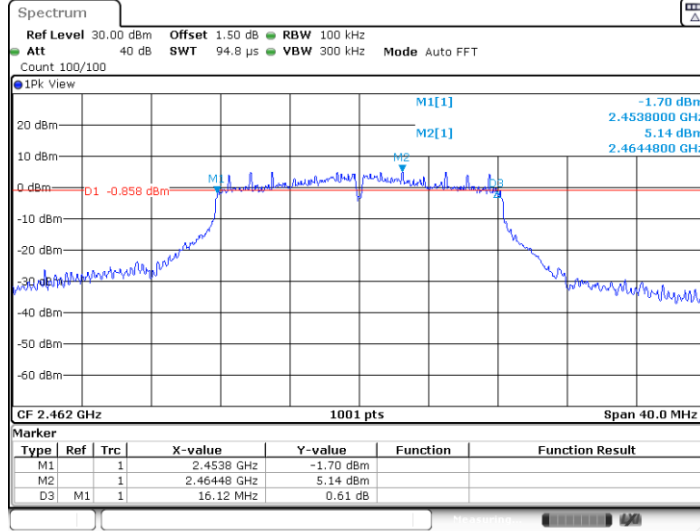

Date: 15.FEB.2022 14:36:31

11N20SISO_Ant1_2412

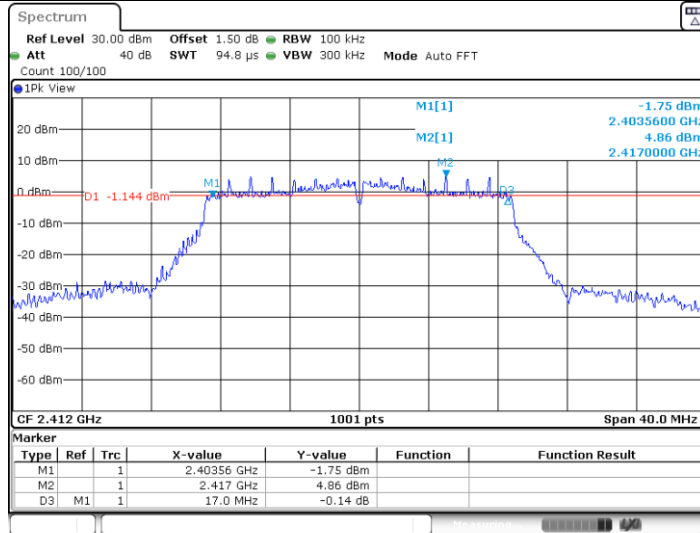

Date: 15.FEB.2022 14:38:04

11N20SISO_Ant1_2437

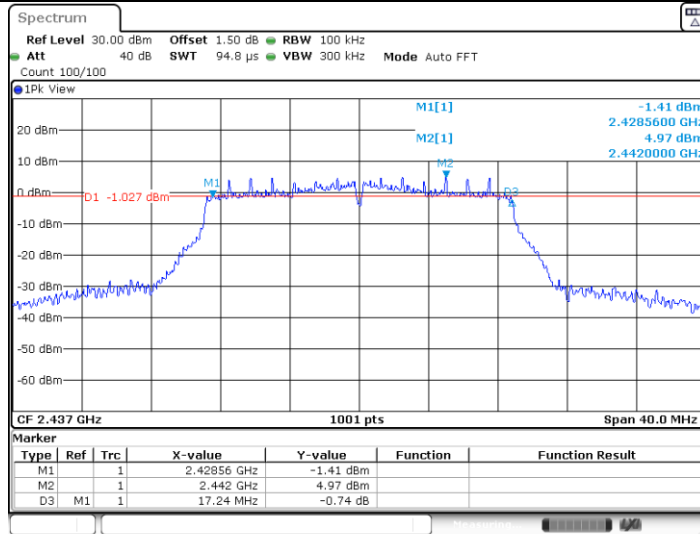

Date: 15.FEB.2022 14:39:35

11N20SISO_Ant1_2462

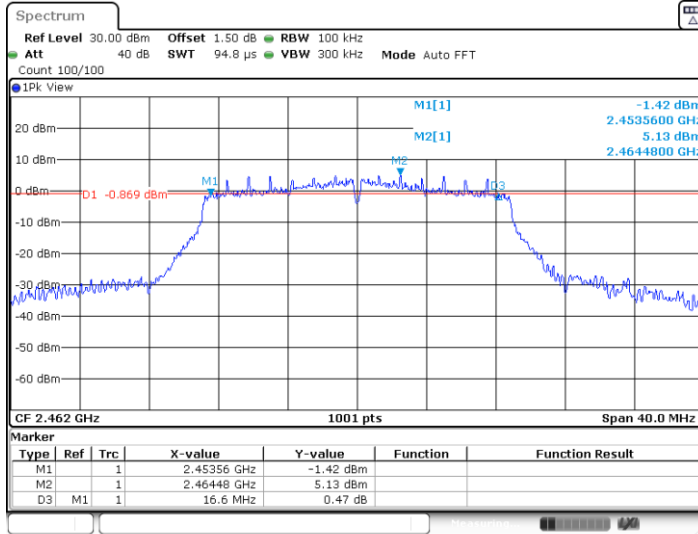

Date: 15.FEB.2022 14:40:59

11AC20SISO_Ant1_2412

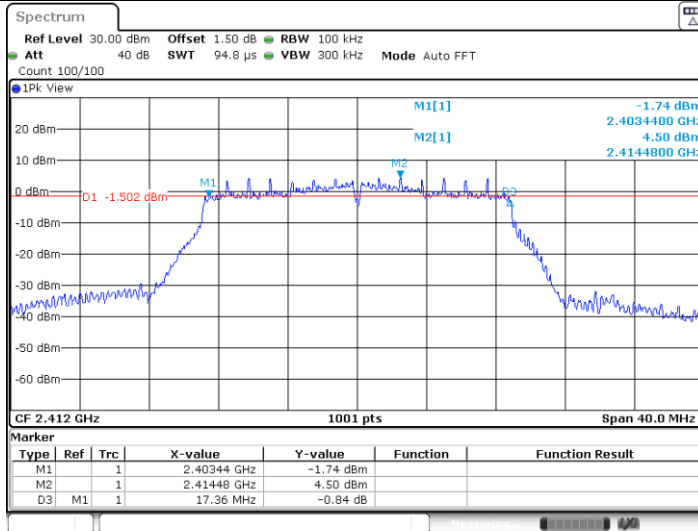

Date: 23.FEB.2022 17:02:45

11AC20SISO_Ant1_2437

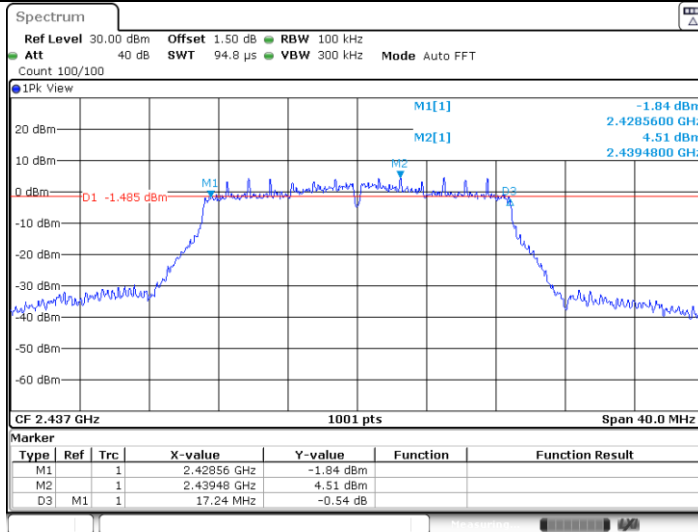

Date: 23.FEB.2022 16:58:42

11AC20SISO_Ant1_2462

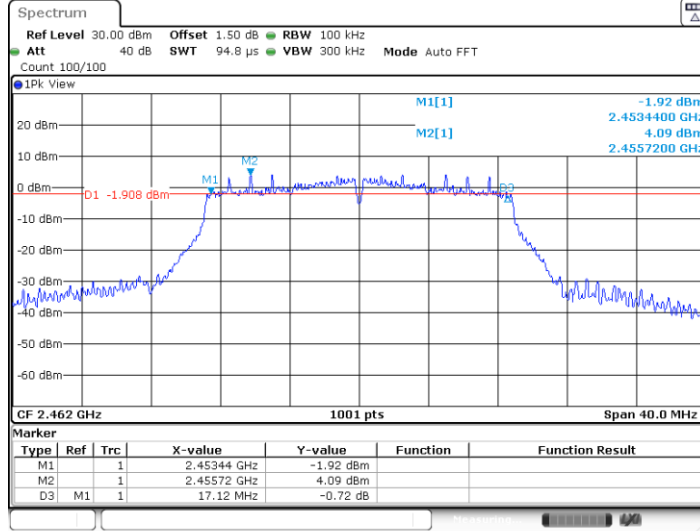

Date: 23.FEB.2022 17:00:27

9.4 99% bandwidth

Test Method

1. Connect EUT test port to spectrum analyzer.
2. Use the following spectrum analyzer settings:
RBW=1% to 5% of the actual occupied, VBW \geq 3RBW, Sweep = auto,
Detector function = peak, Trace = max hold
3. Use the automatic bandwidth measurement capability of an instrument, care shall be taken so that the bandwidth measurement is not influenced by any intermediate power nulls in the fundamental emission that might be ≥ 6 dB.
4. Allow the trace to stabilize, record the X dB Bandwidth value.

Limit

Limit [kHz]

--

Test Result

TestMode	Channel	OCB [MHz]	Limit[MHz]	Verdict
11B	2412	11.948	---	PASS
	2437	11.948	---	PASS
	2462	12.068	---	PASS
11G	2412	17.822	---	PASS
	2437	17.982	---	PASS
	2462	17.662	---	PASS
11N20SISO	2412	18.701	---	PASS
	2437	18.661	---	PASS
	2462	18.541	---	PASS
11AC20SISO	2412	18.661	---	PASS
	2437	18.581	---	PASS
	2462	18.501	---	PASS

Test Graphs

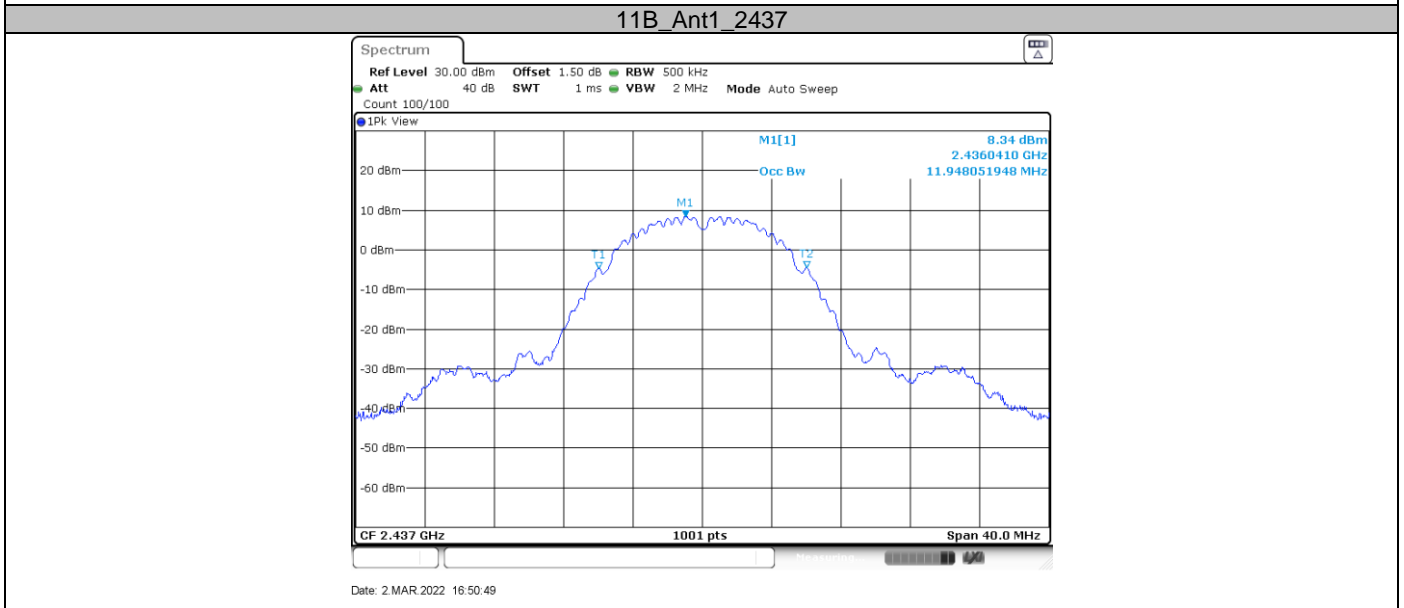
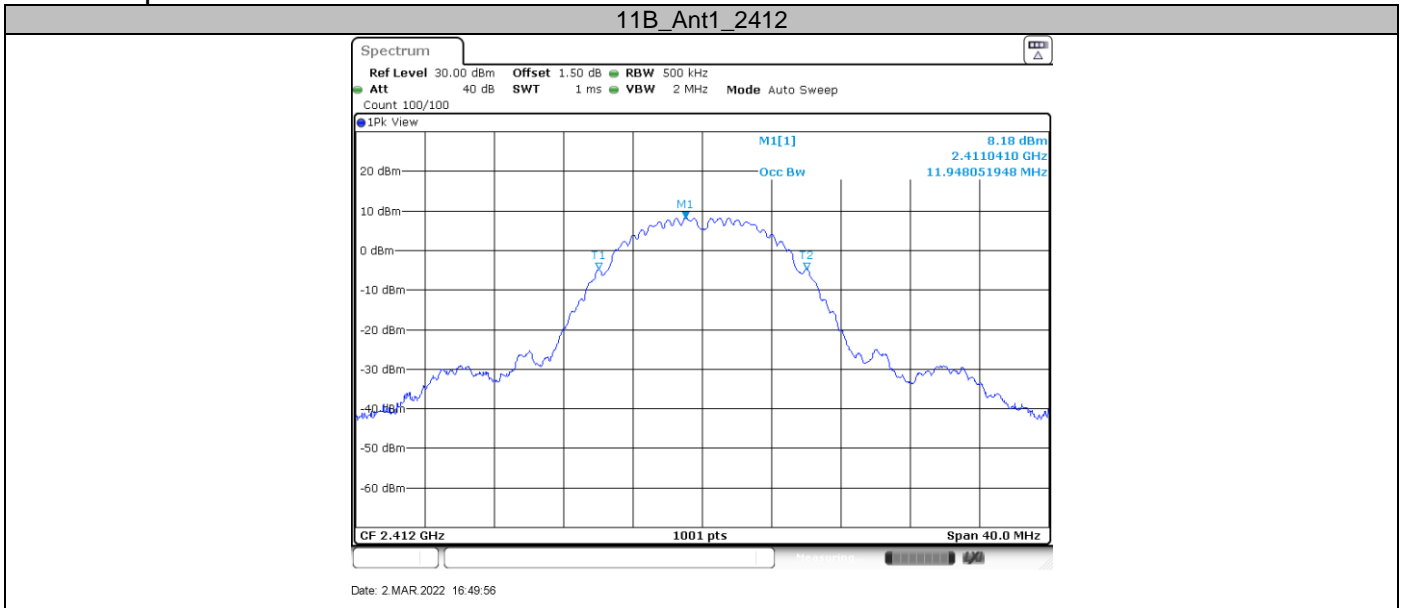



11B_Ant1_2462

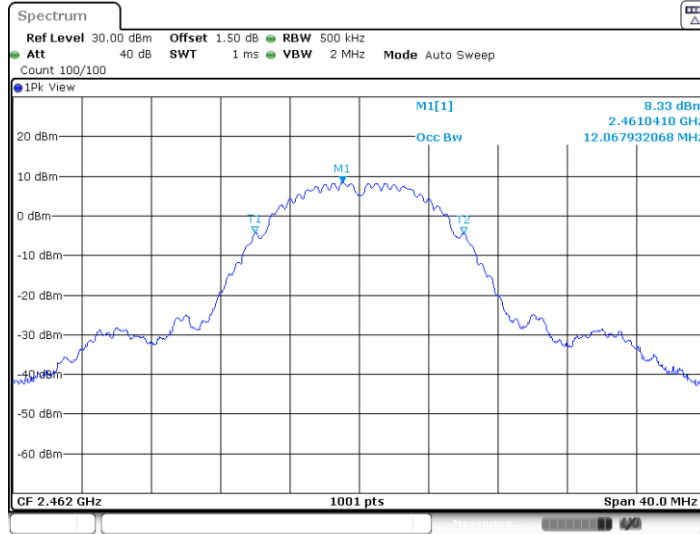

Date: 2 MAR 2022 16:51:56

11G_Ant1_2412

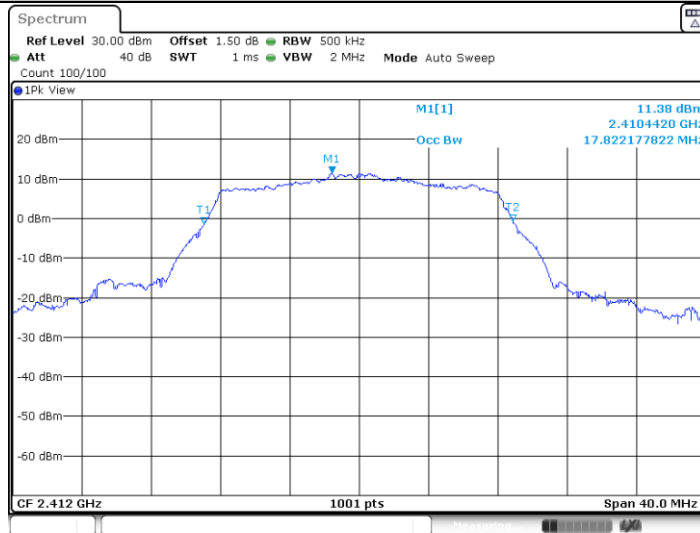

Date: 15 FEB 2022 14:33:54

11G_Ant1_2437



Date: 15 FEB 2022 14:35:24

11G_Ant1_2462

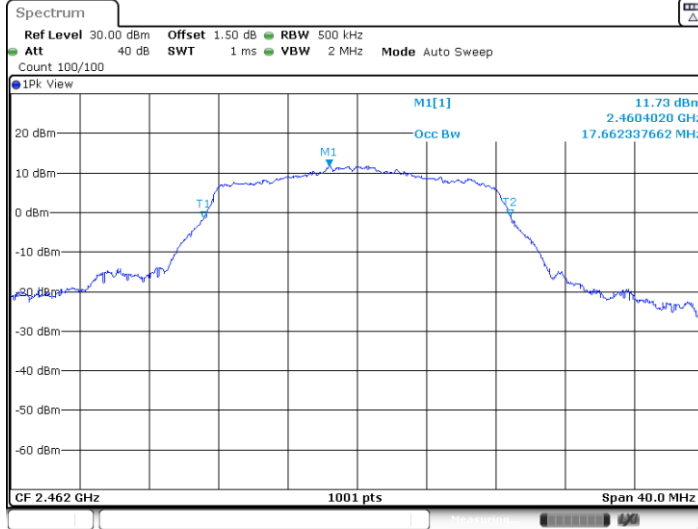

Date: 15.FEB.2022 14:36:42

11N20SISO_Ant1_2412

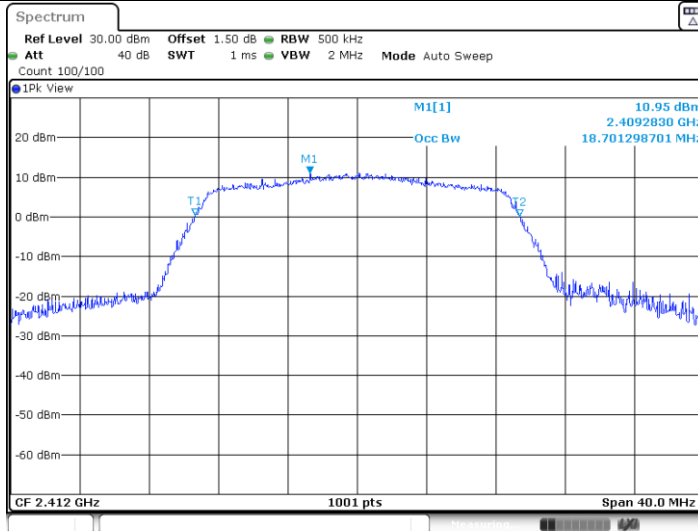

Date: 15.FEB.2022 14:38:14

11N20SISO_Ant1_2437

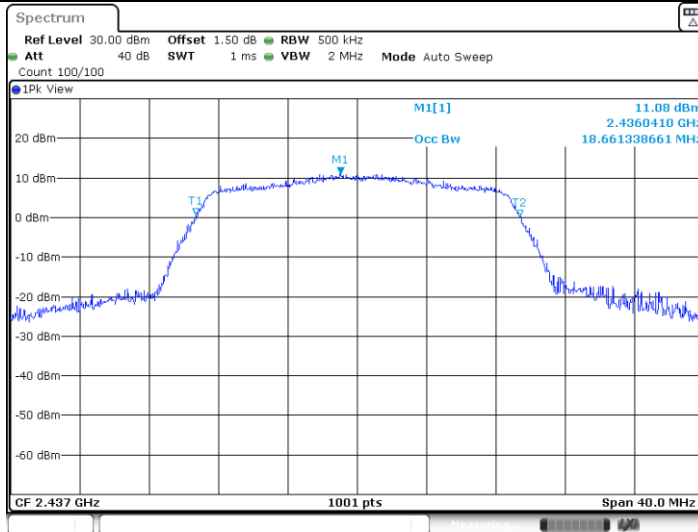

Date: 15.FEB.2022 14:39:46



11N20SISO_Ant1_2462

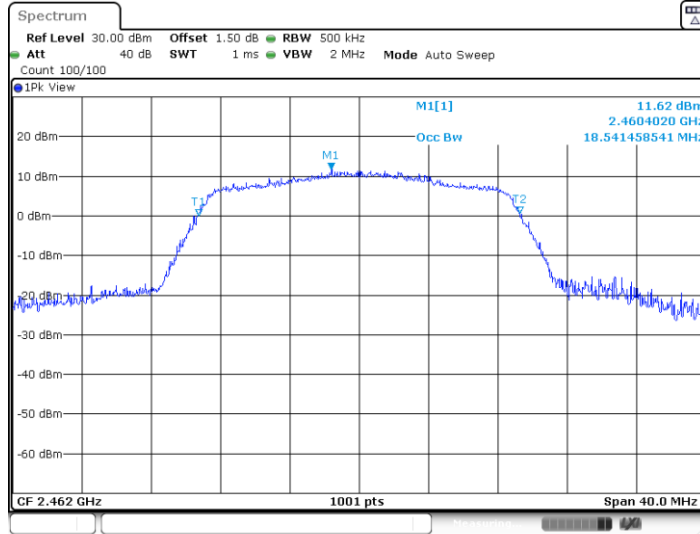

Date: 15.FEB.2022 14:41:09

11AC20SISO_Ant1_2412

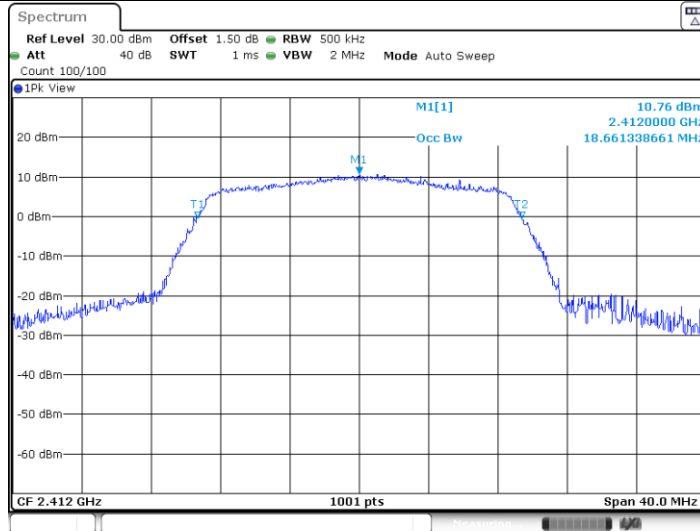

Date: 23.FEB.2022 17:02:56

11AC20SISO_Ant1_2437

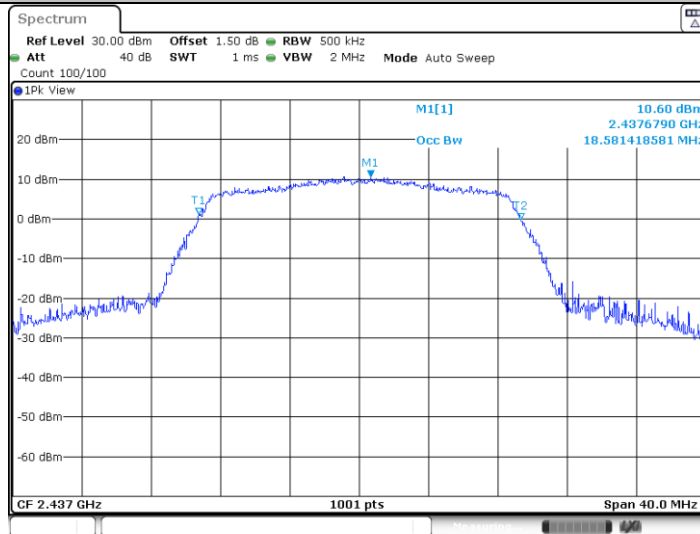

Date: 23.FEB.2022 16:58:53

11AC20SISO_Ant1_2462

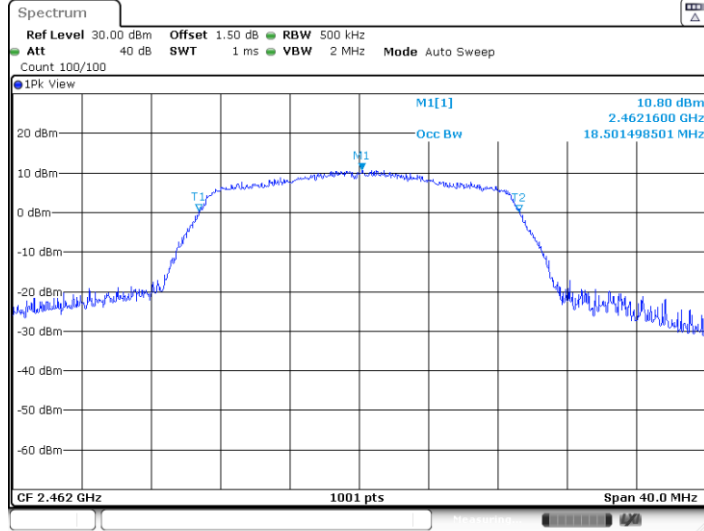

Date: 23.FEB.2022 17:00:38

9.5 Power spectral density

Test Method

This procedure shall be used if maximum peak conducted output power was used to demonstrate compliance:

1. The RF output of EUT was connected to the test receiver by RF cable. The path loss was compensated to the results for each measurement.
2. Set analyzer center frequency to DTS channel center frequency. RBW=3kHz, VBW \geq 3RBW, Span=1.5 times DTS bandwidth, Detector=Peak, Sweep=auto, Trace= max hold.
3. Allow trace to fully stabilize, use the peak marker function to determine the maximum amplitude level within the RBW.
4. Repeat above procedures until other frequencies measured were completed.

Limit

Limit [dBm/3KHz]

≤8

Test result

TestMode	Channel	Result(dBm/3KHz)	Limit(dBm/3KHz)	Verdict
11B	2412	-1.19	≤8	PASS
	2437	0.2	≤8	PASS
	2462	-1.65	≤8	PASS
11G	2412	-6.68	≤8	PASS
	2437	-6.55	≤8	PASS
	2462	-6.36	≤8	PASS
11N20SISO	2412	-6.27	≤8	PASS
	2437	-6.95	≤8	PASS
	2462	-6.82	≤8	PASS
11AC20SISO	2412	-7.46	≤8	PASS
	2437	-7.82	≤8	PASS
	2462	-7.62	≤8	PASS

Test Graphs

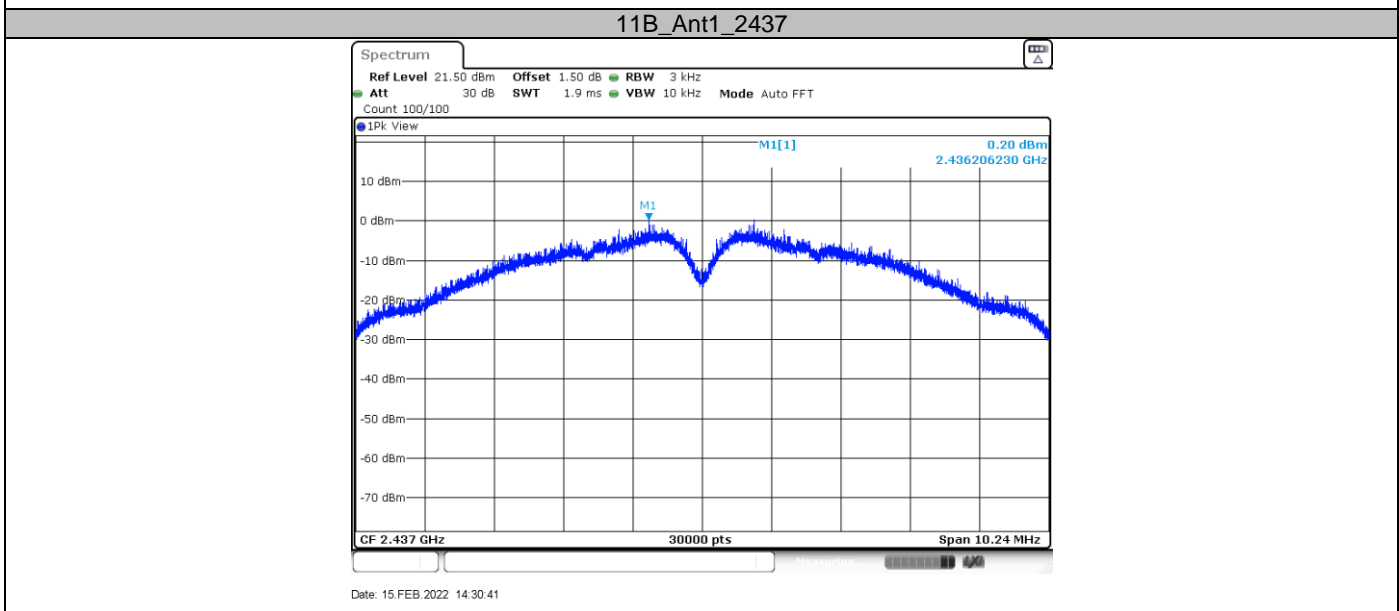
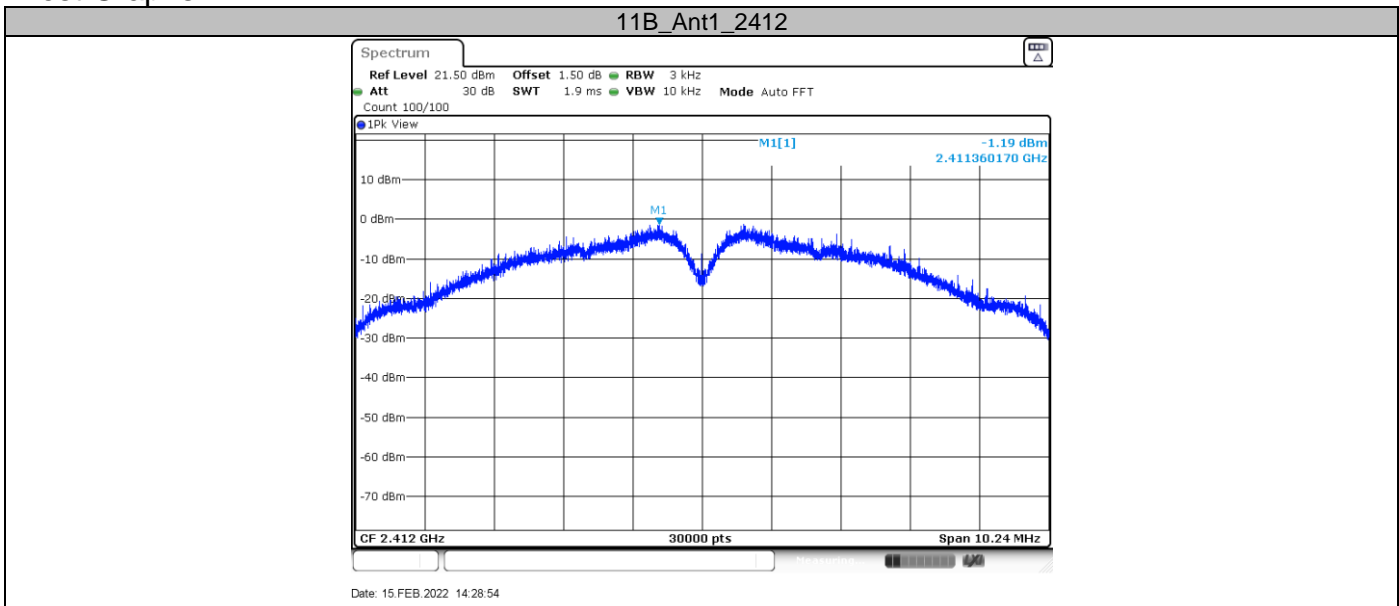

11B_Ant1_2462

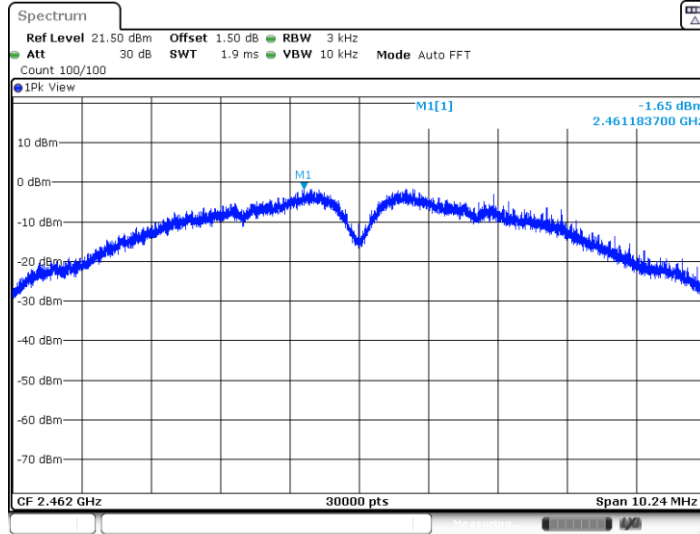

Date: 15.FEB.2022 14:32:30

11G_Ant1_2412

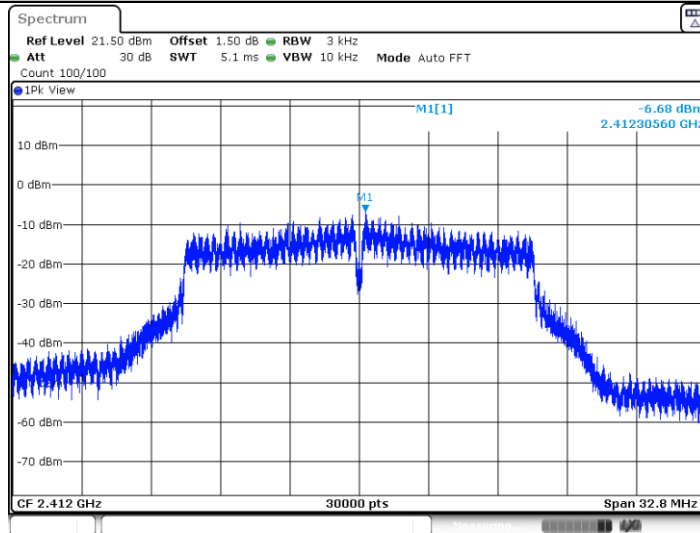

Date: 15.FEB.2022 14:33:59

11G_Ant1_2437

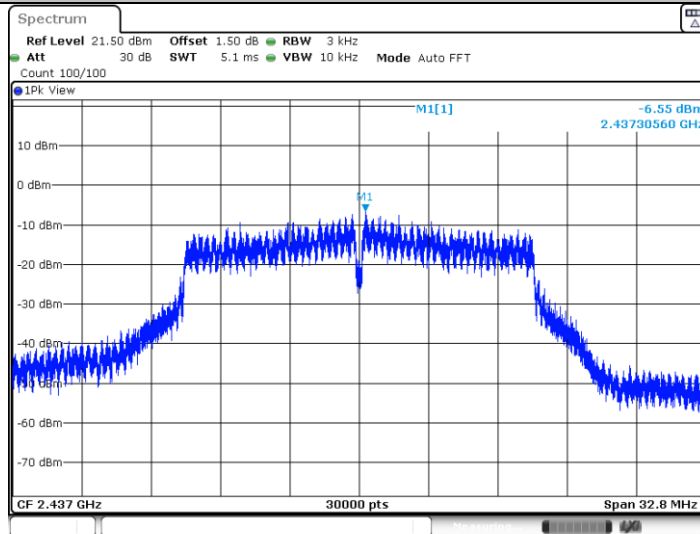

Date: 15.FEB.2022 14:35:29

11G_Ant1_2462

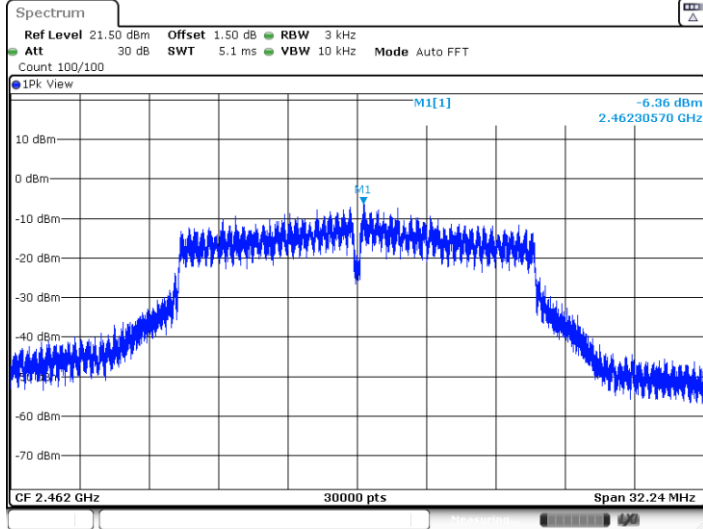

Date: 15.FEB.2022 14:36:48

11N20SISO_Ant1_2412

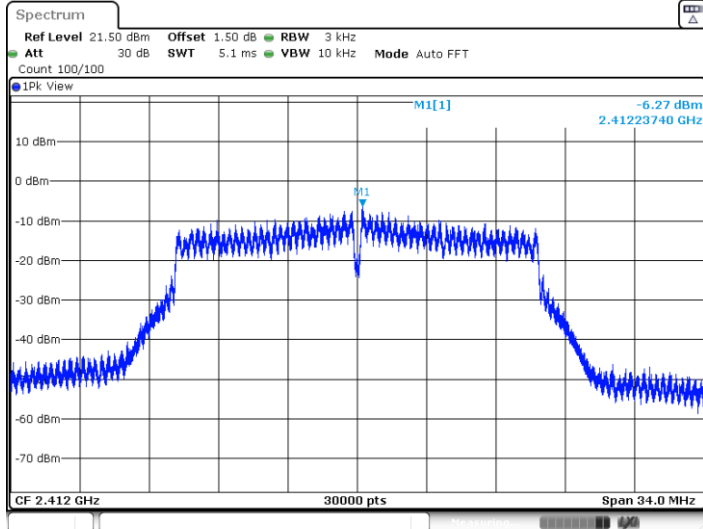

Date: 15.FEB.2022 14:38:20

11N20SISO_Ant1_2437

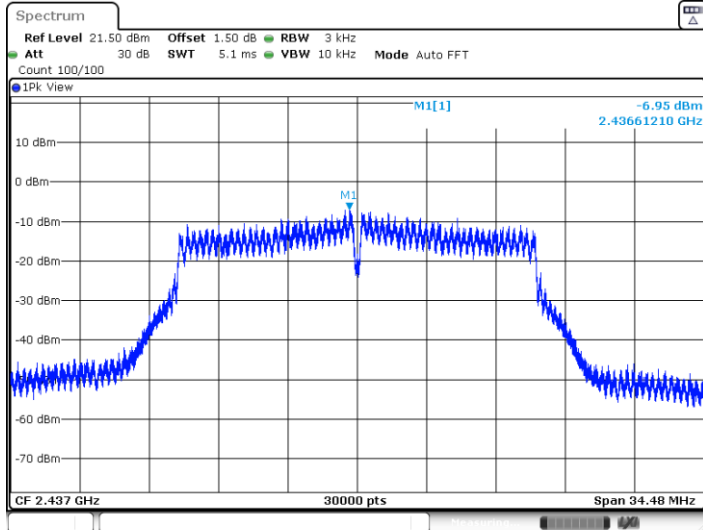

Date: 15.FEB.2022 14:39:52

11N20SISO_Ant1_2462

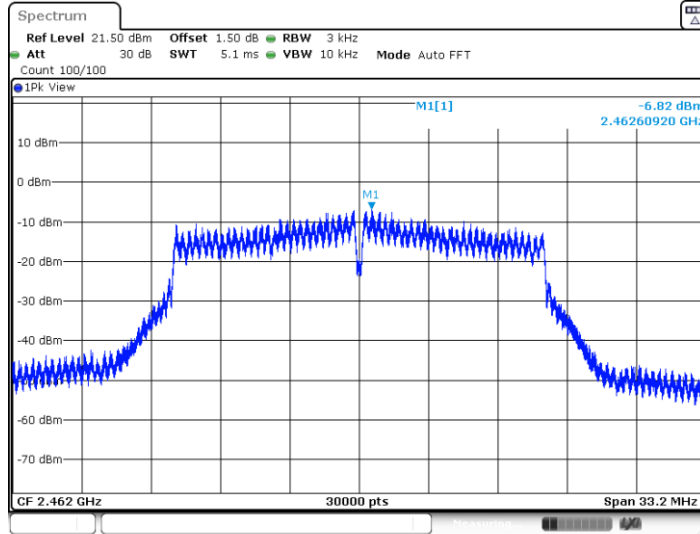

Date: 15.FEB.2022 14:41:15

11AC20SISO_Ant1_2412

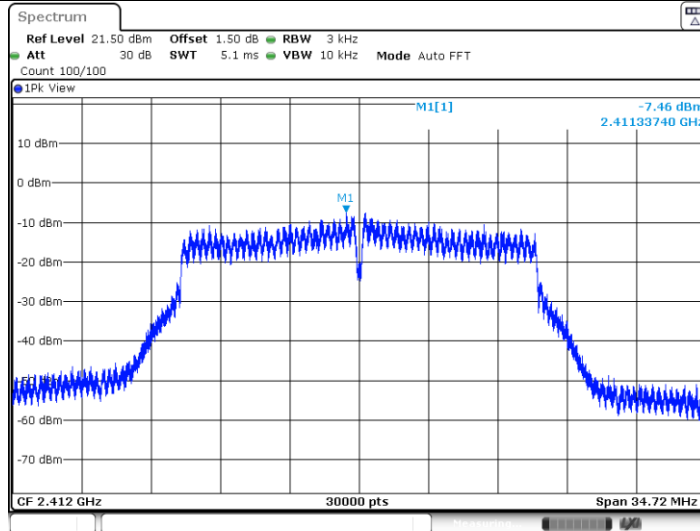

Date: 23.FEB.2022 17:03:02

11AC20SISO_Ant1_2437

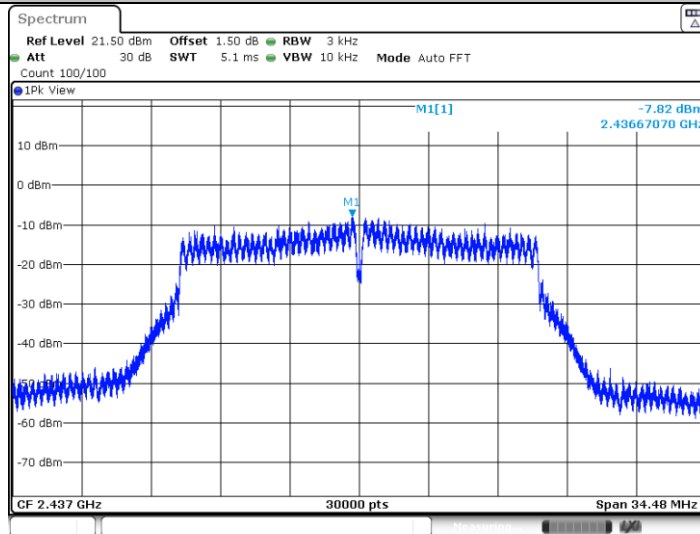

Date: 23.FEB.2022 16:58:59

11AC20SISO_Ant1_2462

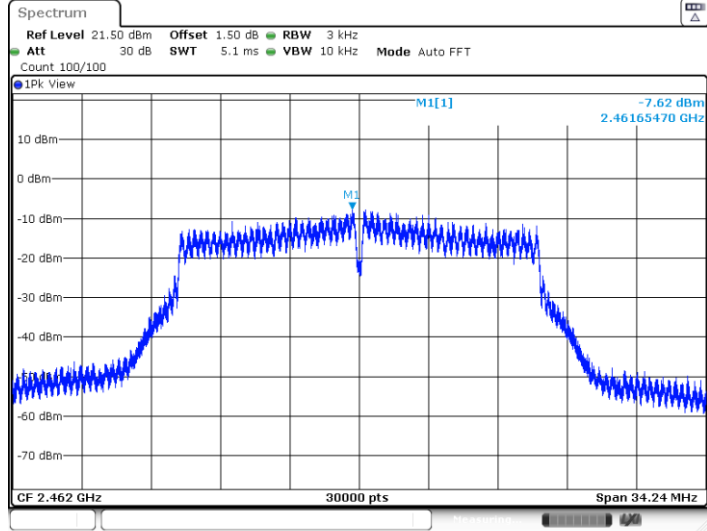

Date: 23.FEB.2022 17:00:44



9.6 Spurious RF conducted emissions

Test Method

1. The RF output of EUT was connected to the spectrum analyzer by RF cable. The path loss was compensated to the results for each measurement.
2. Use the following spectrum analyzer settings:
 Span = wide enough to capture the peak level of the in-band emission and all spurious emissions (e.g., harmonics) from the lowest frequency generated in the EUT up through the 10th harmonic. Typically, several plots are required to cover this entire span.
 RBW = 100 kHz, VBW ≥ RBW, Sweep = auto, Detector function = peak, Trace = max hold
3. Allow the trace to stabilize. Set the marker on the peak of any spurious emission recorded.
4. The level displayed must comply with the limit specified in this Section. Submit these plots.
5. Repeat above procedures until all frequencies measured were complete.

Limit

Frequency Range MHz	Limit (dBc)
30-25000	-20

Test Result

Remark: The emissions exceed limit is fundamental signal.

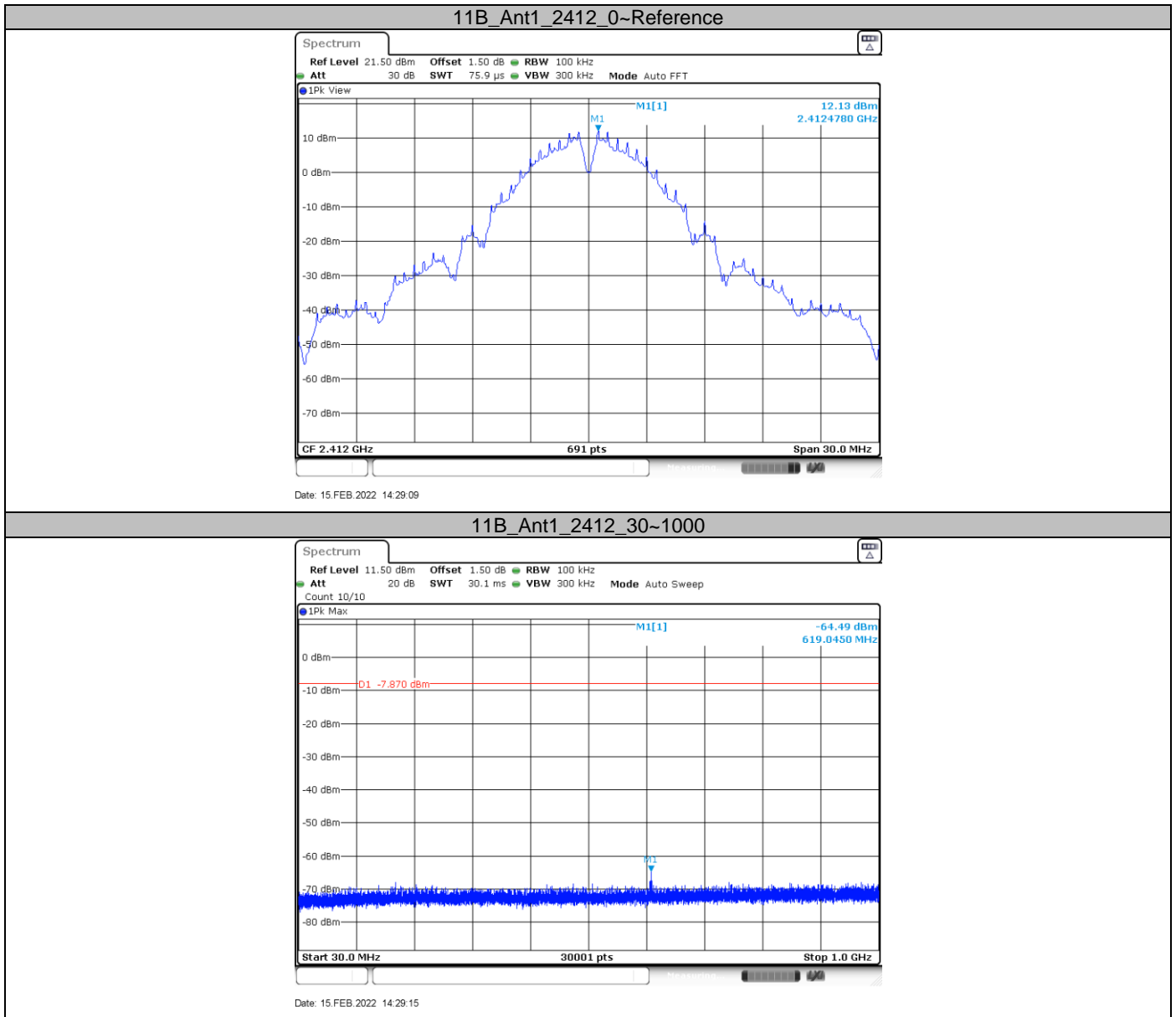



11B_Ant1_2412_1000~26500

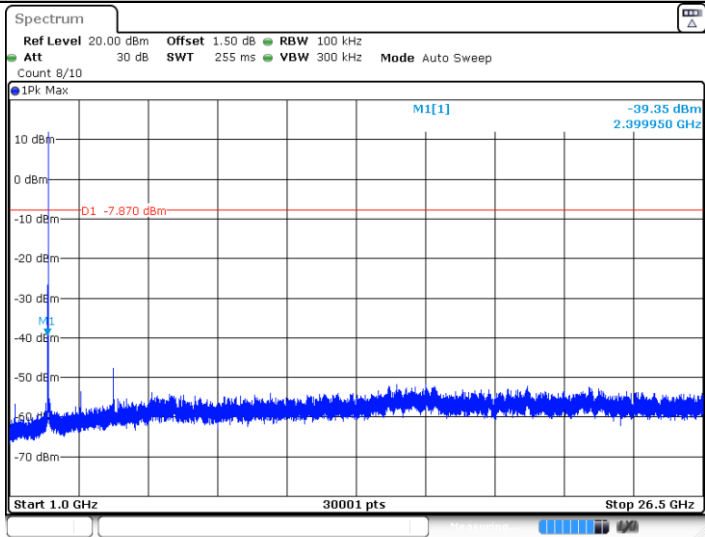

Date: 15.FEB.2022 14:29:23

11B_Ant1_2437_0~Reference

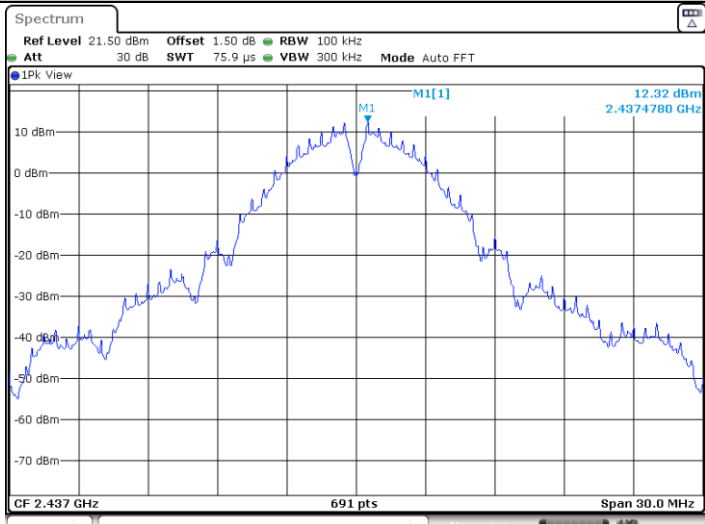

Date: 15.FEB.2022 14:30:46

11B_Ant1_2437_30~1000

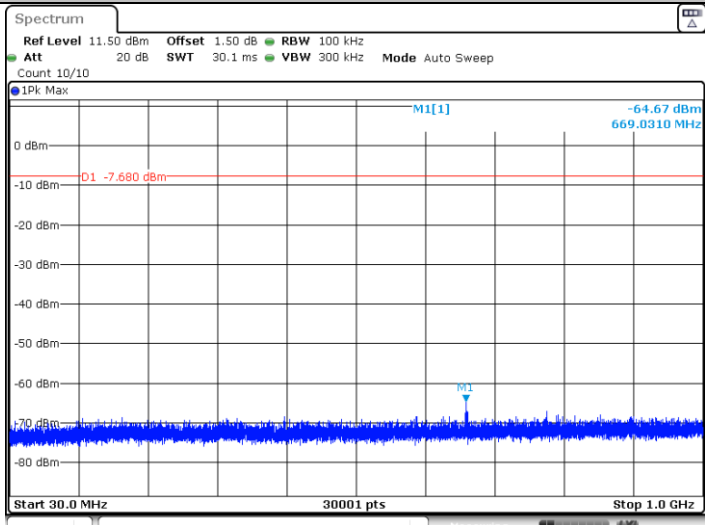

Date: 15.FEB.2022 14:30:53

11B_Ant1_2437_1000~26500

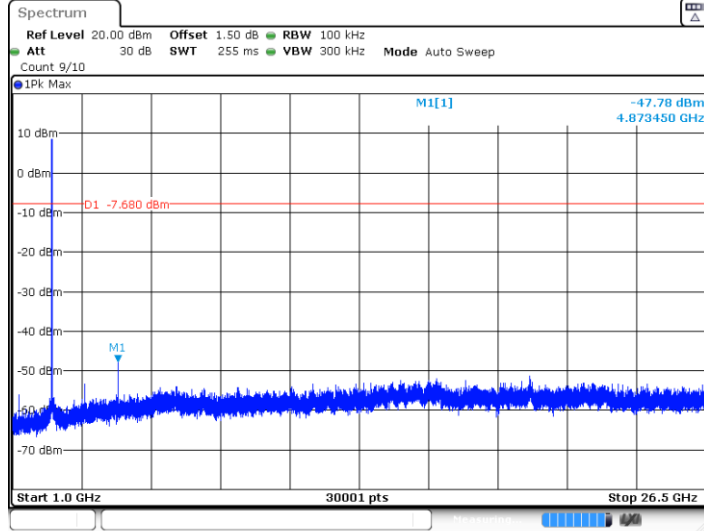

Date: 15.FEB.2022 14:31:00

11B_Ant1_2462_0~Reference

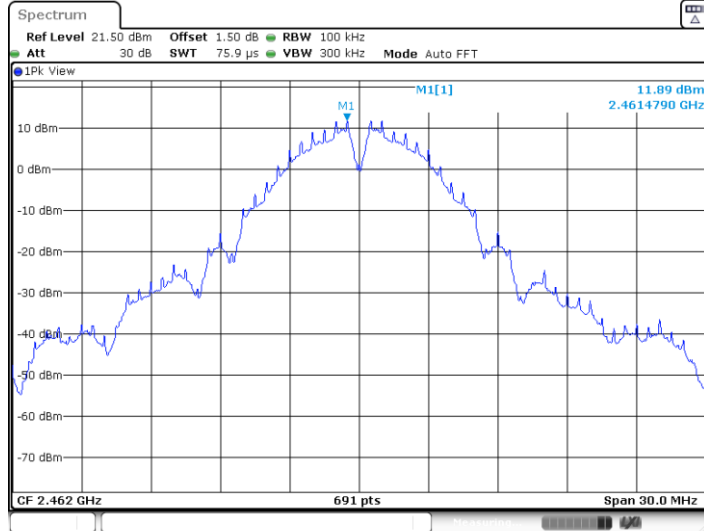

Date: 15.FEB.2022 14:32:44

11B_Ant1_2462_30~1000

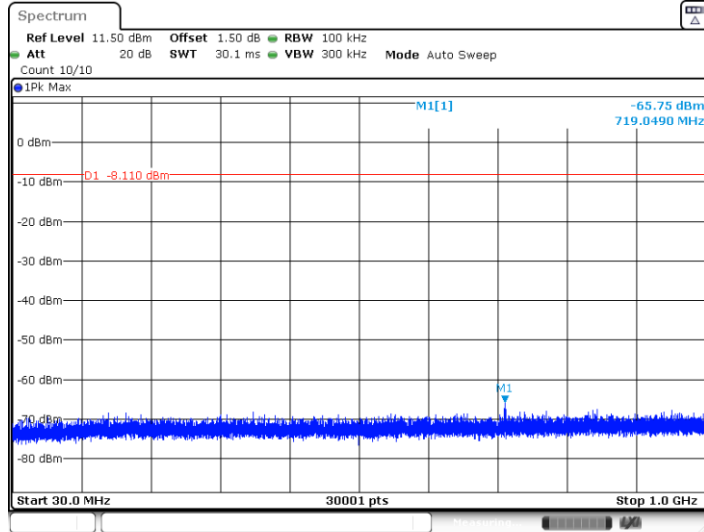

Date: 15.FEB.2022 14:32:51

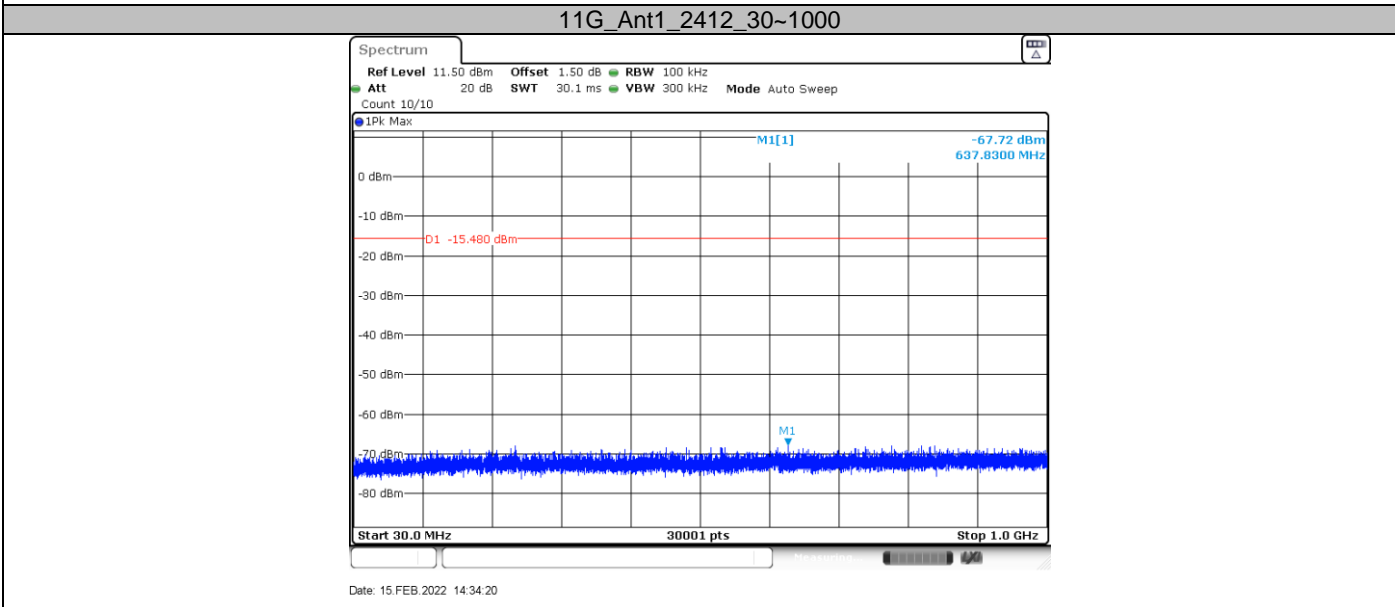
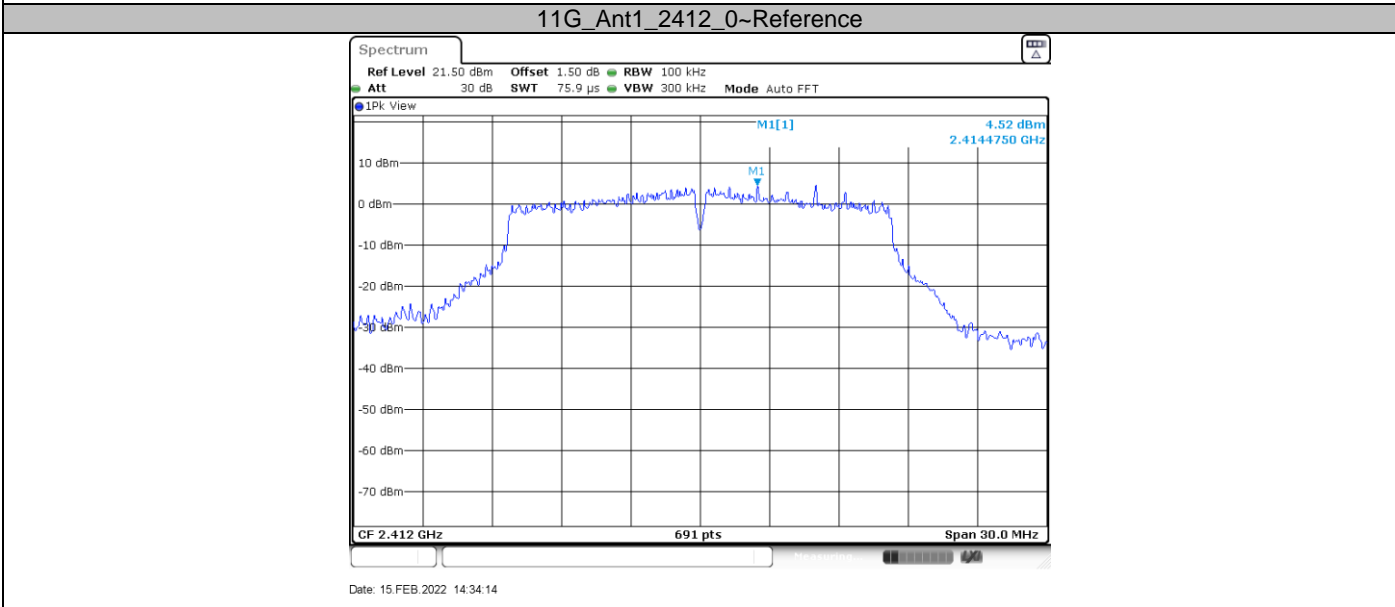
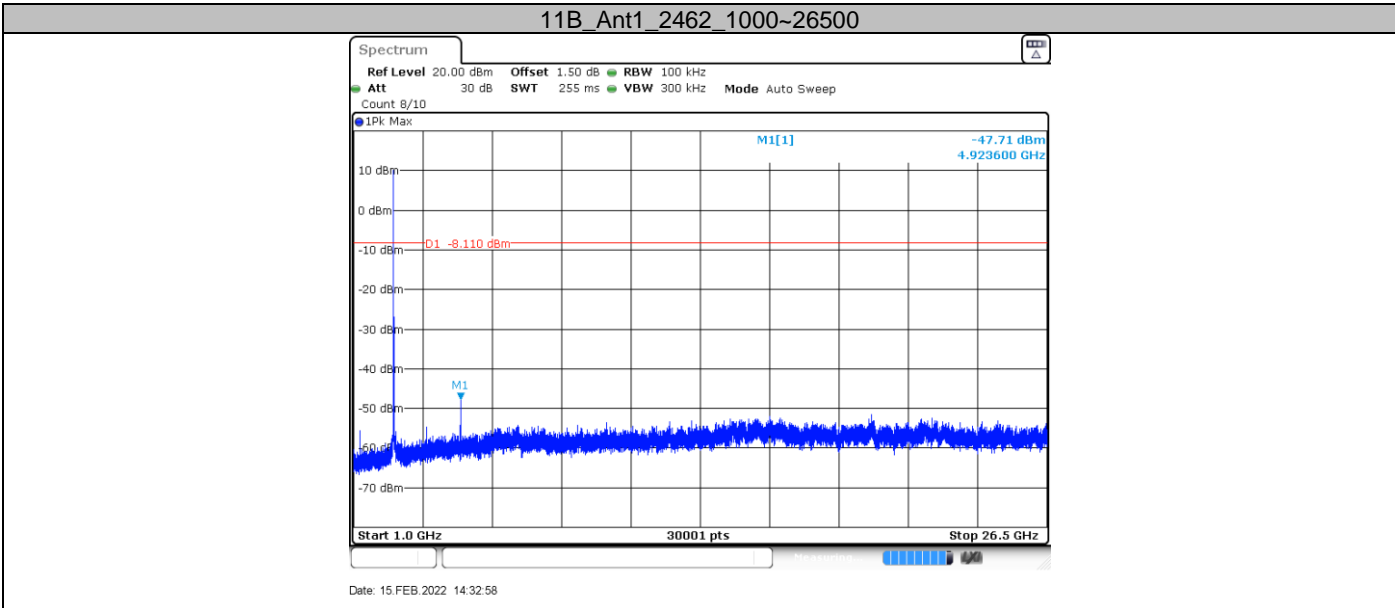

11G_Ant1_2412_1000~26500

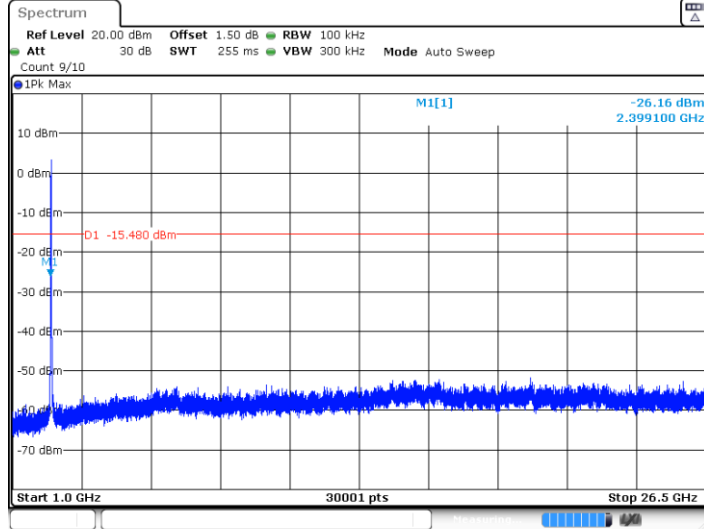

Date: 15.FEB.2022 14:34:28

11G_Ant1_2437_0~Reference

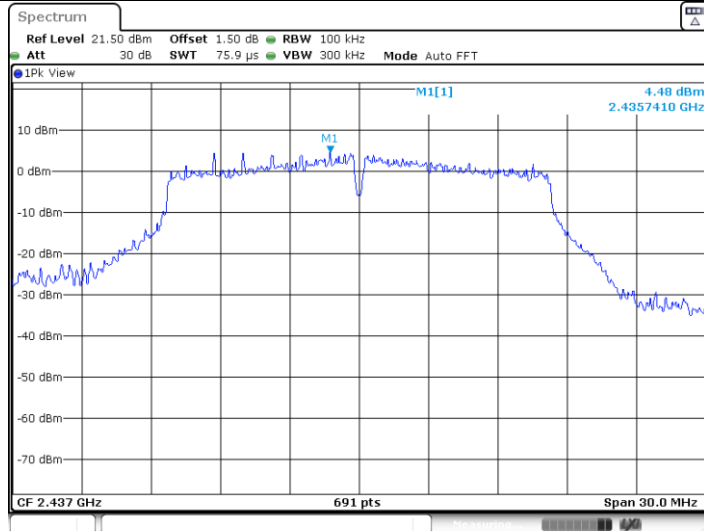

Date: 15.FEB.2022 14:35:35

11G_Ant1_2437_30~1000

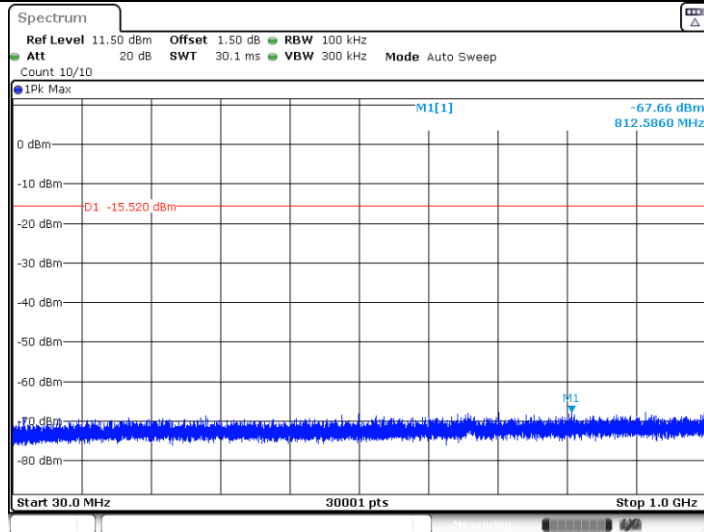

Date: 15.FEB.2022 14:35:41

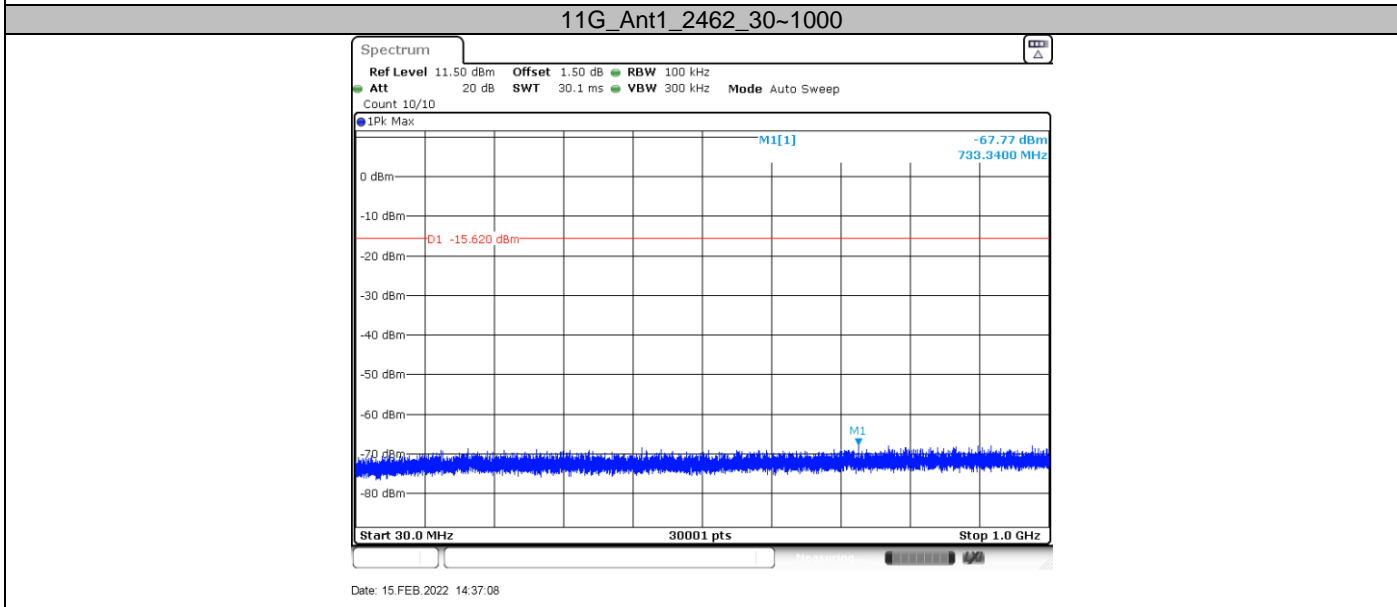
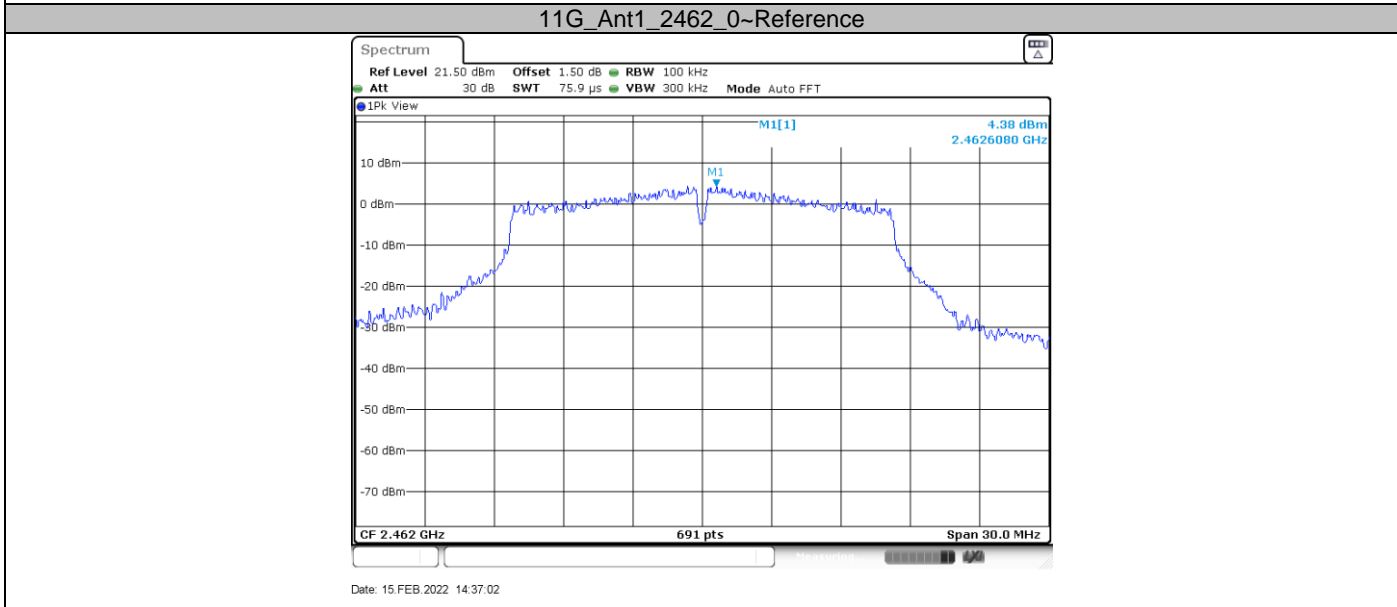
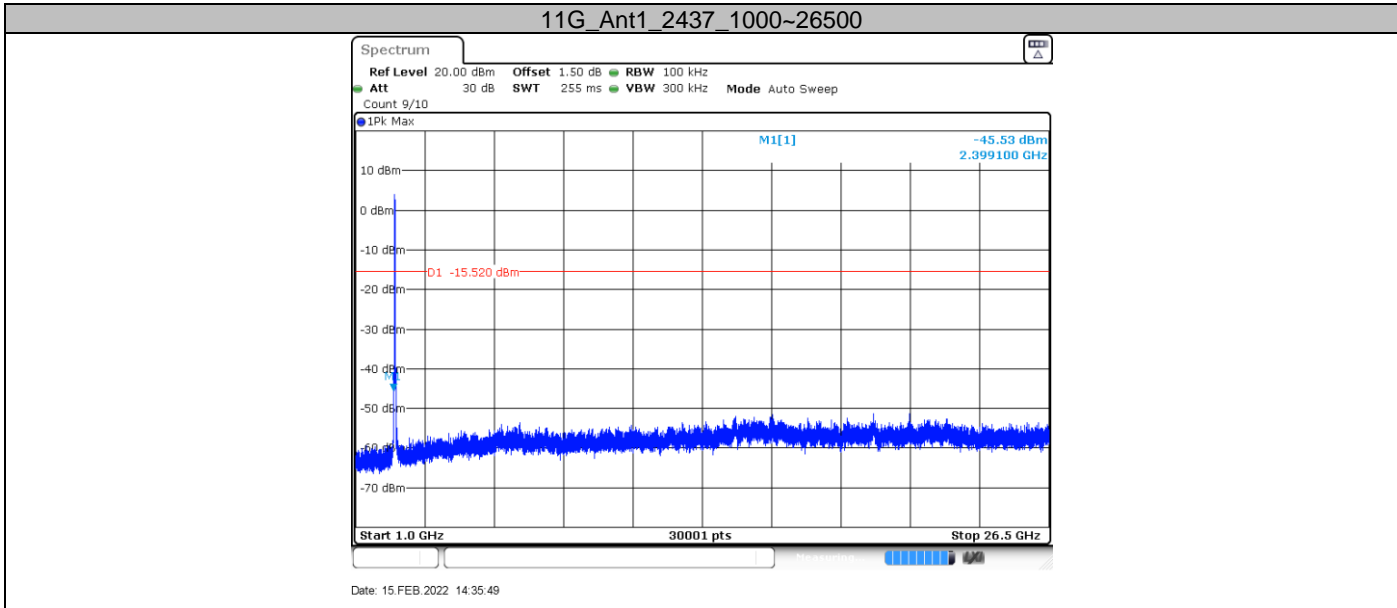

11G_Ant1_2462_1000~26500

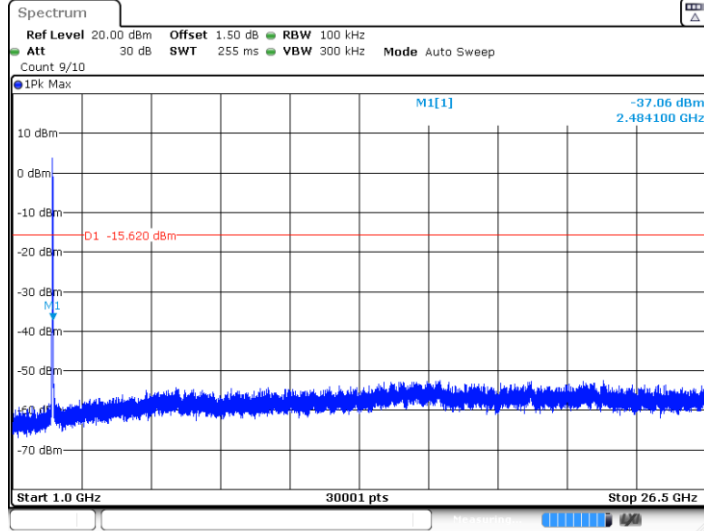

Date: 15.FEB.2022 14:37:16

11N20SISO_Ant1_2412_0~Reference

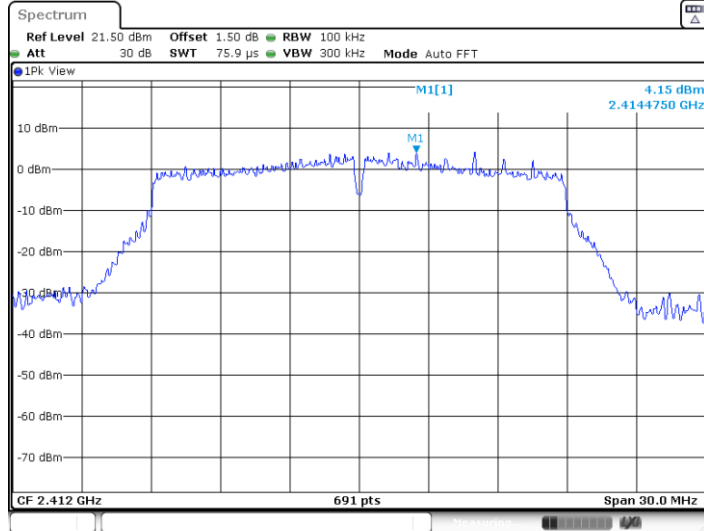

Date: 15.FEB.2022 14:38:35

11N20SISO_Ant1_2412_30~1000

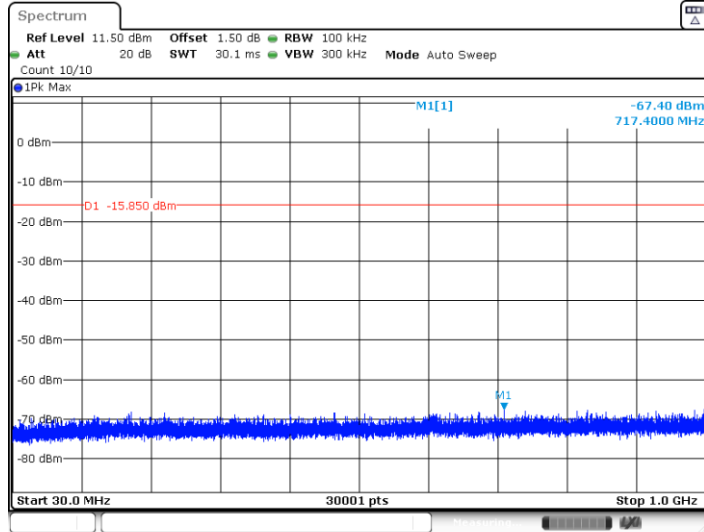

Date: 15.FEB.2022 14:38:41

11N20SISO_Ant1_2412_1000~26500

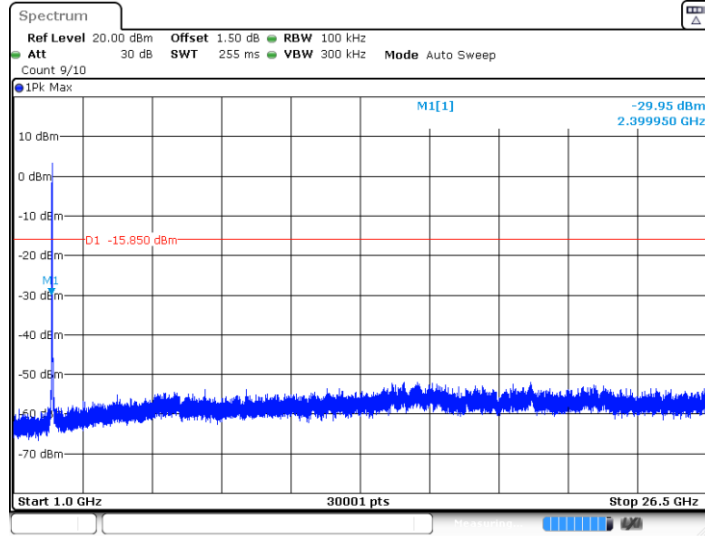

Date: 15.FEB.2022 14:38:49

11N20SISO_Ant1_2437_0~Reference

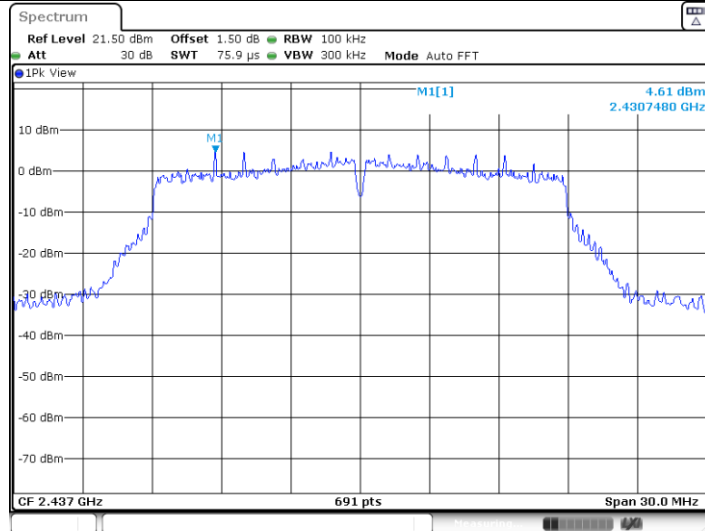

Date: 15.FEB.2022 14:39:57

11N20SISO_Ant1_2437_30~1000

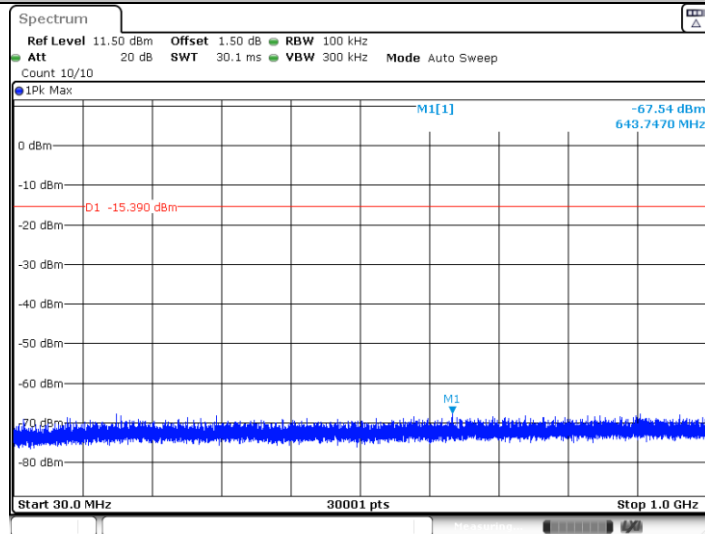

Date: 15.FEB.2022 14:40:03

11N20SISO_Ant1_2437_1000~26500

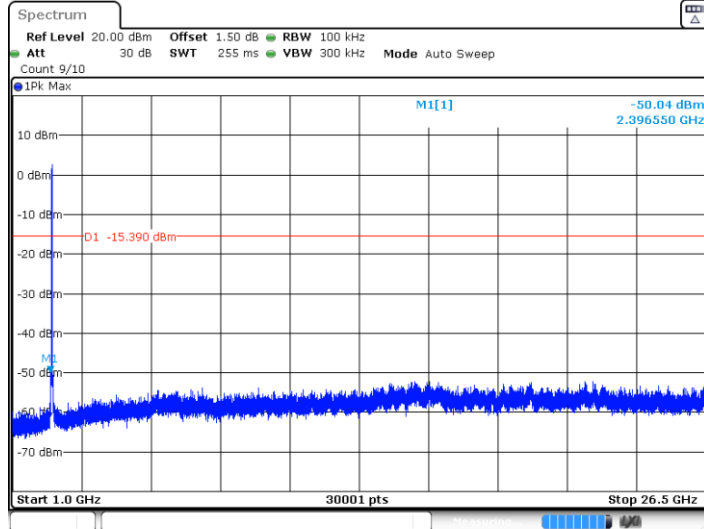

Date: 15.FEB.2022 14:40:11

11N20SISO_Ant1_2462_0~Reference

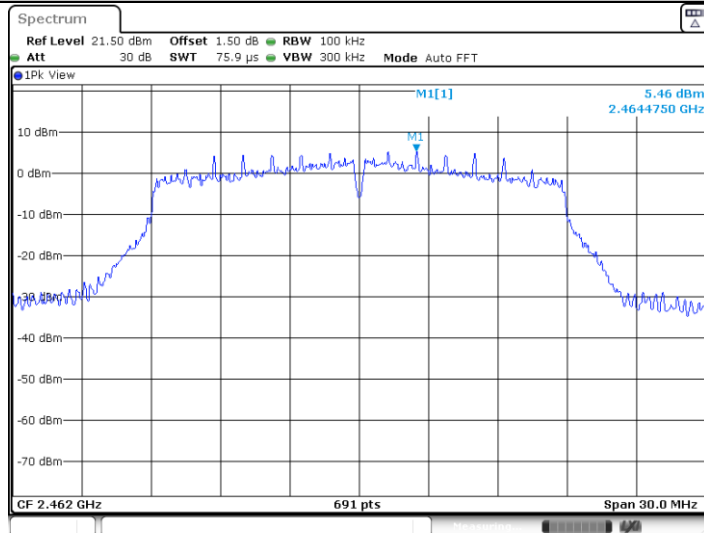

Date: 15.FEB.2022 14:41:30

11N20SISO_Ant1_2462_30~1000

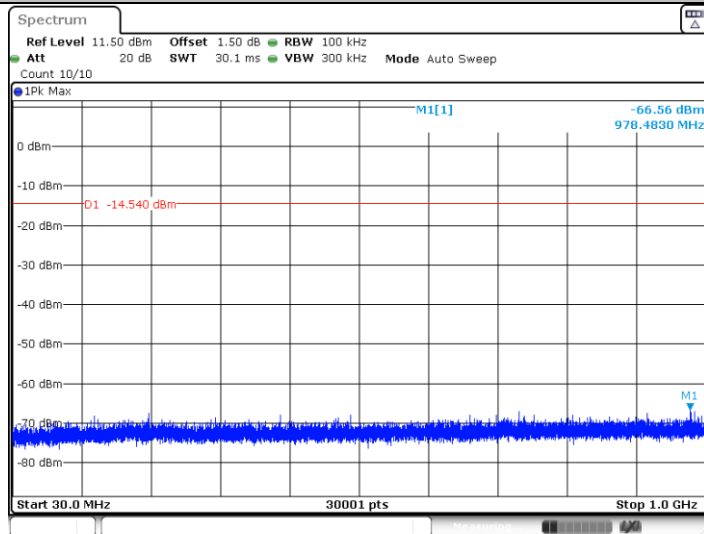

Date: 15.FEB.2022 14:41:36



11N20SISO_Ant1_2462_1000-26500

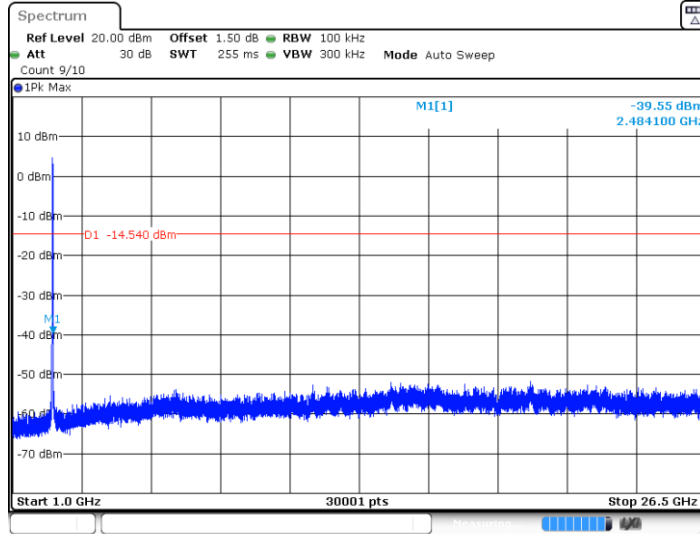

Date: 15.FEB.2022 14:41:44

11AC20SISO_Ant1_2412_0-Reference

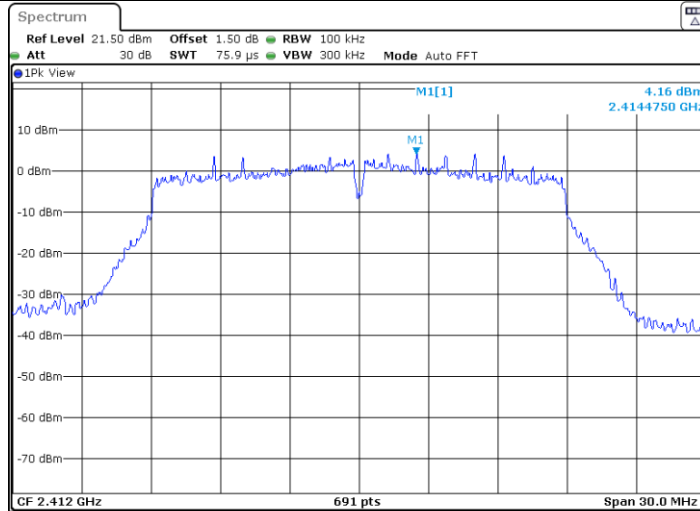

Date: 23.FEB.2022 16:57:39

11AC20SISO_Ant1_2412_30-1000

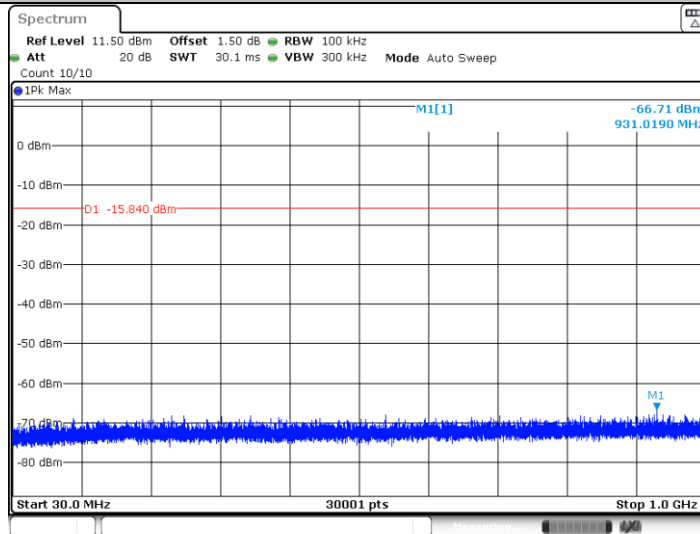

Date: 23.FEB.2022 16:57:45

11AC20SISO_Ant1_2412_1000~26500

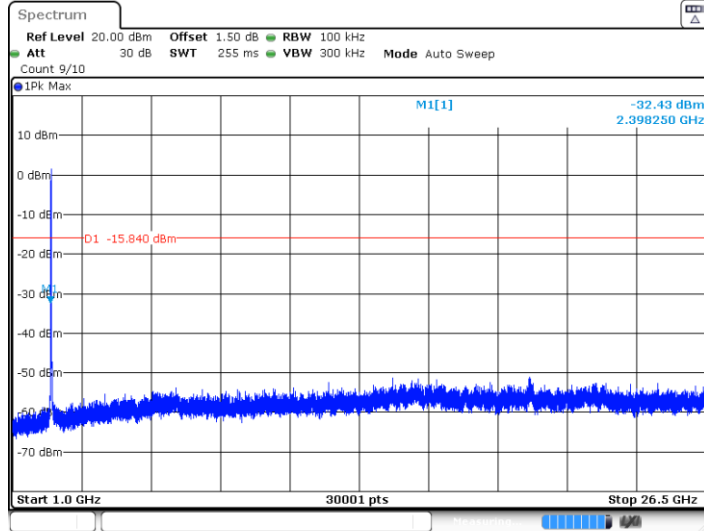

Date: 23.FEB.2022 16:57:53

11AC20SISO_Ant1_2437_0~Reference

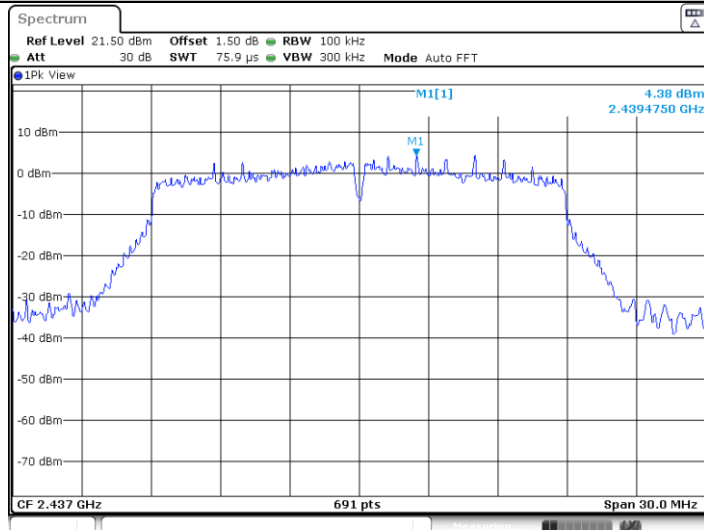

Date: 23.FEB.2022 16:59:04

11AC20SISO_Ant1_2437_30~1000

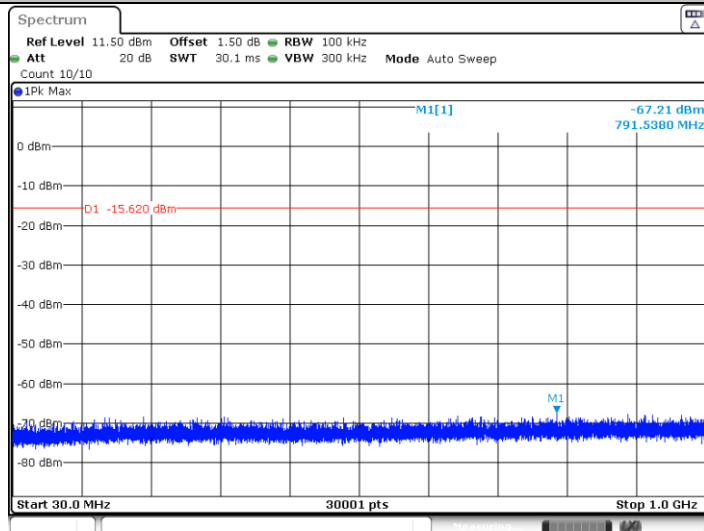

Date: 23.FEB.2022 16:59:10

11AC20SISO_Ant1_2437_1000~26500

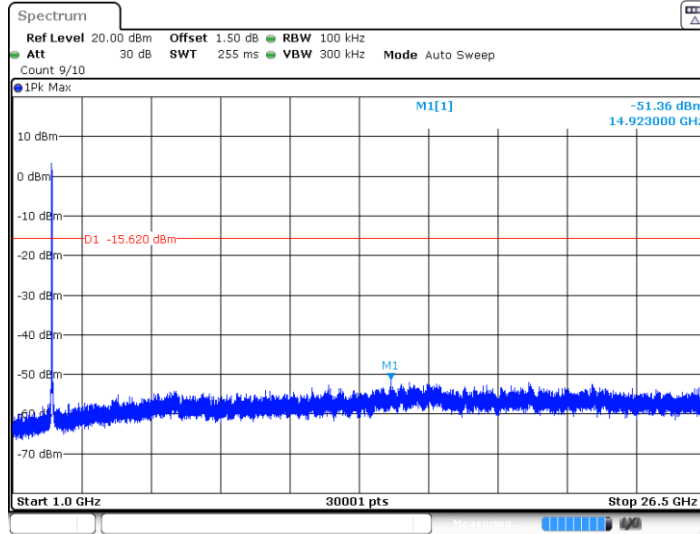

Date: 23.FEB.2022 16:59:18

11AC20SISO_Ant1_2462_0~Reference

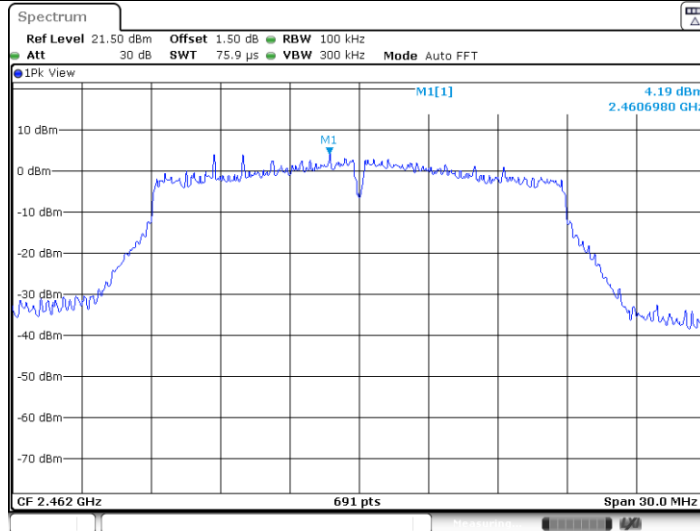

Date: 23.FEB.2022 17:00:58

11AC20SISO_Ant1_2462_30~1000

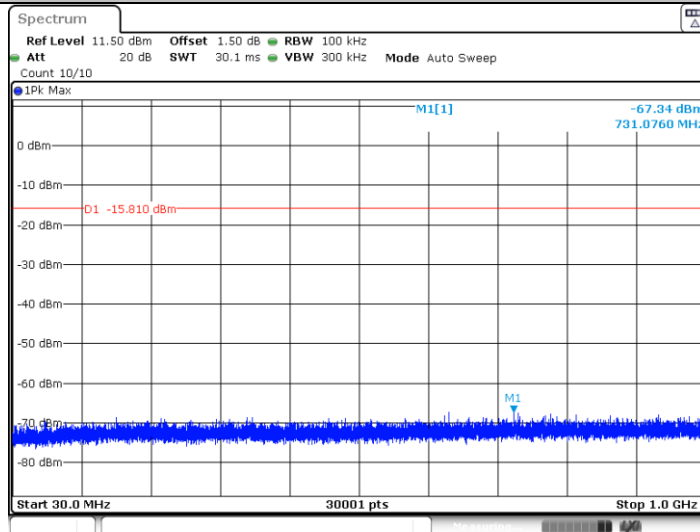

Date: 23.FEB.2022 17:01:04

11AC20SISO_Ant1_2462_1000~26500

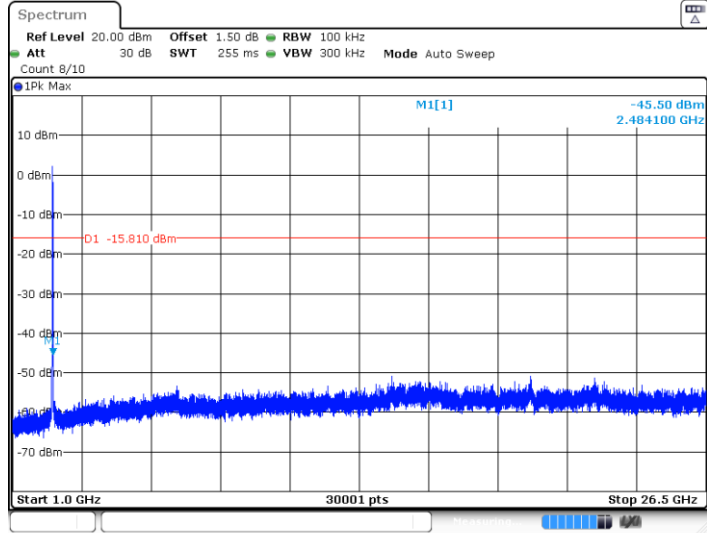

Date: 23.FEB.2022 17:01:12



9.7 Band edge

Test Method

1. The RF output of EUT was connected to the spectrum analyzer by RF cable. The path loss was compensated to the results for each measurement.
2. Use the following spectrum analyzer settings:
Span = wide enough to capture the peak level of the in-band emission and all spurious
RBW = 100 kHz, VBW ≥ RBW, Sweep = auto, Detector function = peak, Trace = max hold
3. Allow the trace to stabilize, use the peak and delta measurement to record the result.
The level displayed must comply with the limit specified in this Section.
4. The level displayed must comply with the limit specified in this Section.
5. Repeat the test at the hopping off and hopping on mode, submit all the plots.

Limit:

According to §15.247(d) and RSS-247 5.5, in any 100 kHz bandwidth outside the frequency bands in which the spread spectrum intentional radiator is operating, the radio frequency power that is produced by the intentional radiator shall be at least 20 dB below that in the 100 kHz bandwidth within the band that contains the highest level of the desired power, based on either an RF conducted or a radiated measurement, provided the transmitter demonstrates compliance with the peak conducted power limits. In addition, radiated emissions which fall in the restricted bands, as defined in §15.205(a) and RSS-Gen 8.10, must also comply with the radiated emission limits specified in 15.209(a) (see Section 15.205(c)) and RSS-Gen.

Frequency Range MHz	Limit (dBc)
30-25000	-20

Test result

11B_Ant1_Low_2412

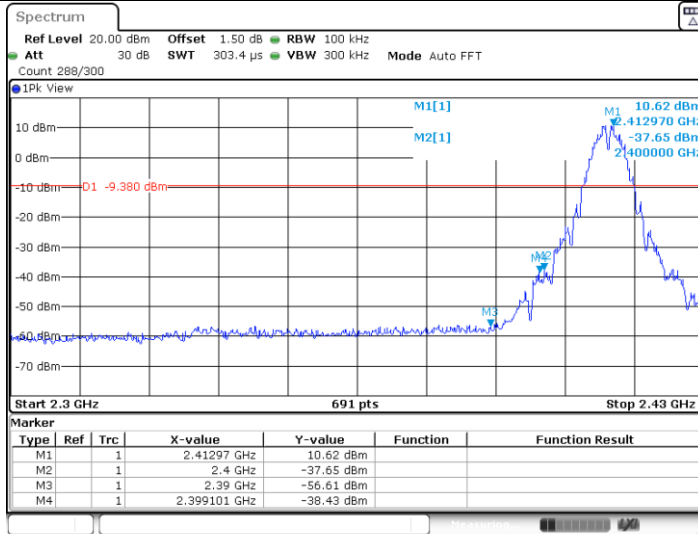

Date: 15.FEB.2022 14:29:03

11B_Ant1_High_2462

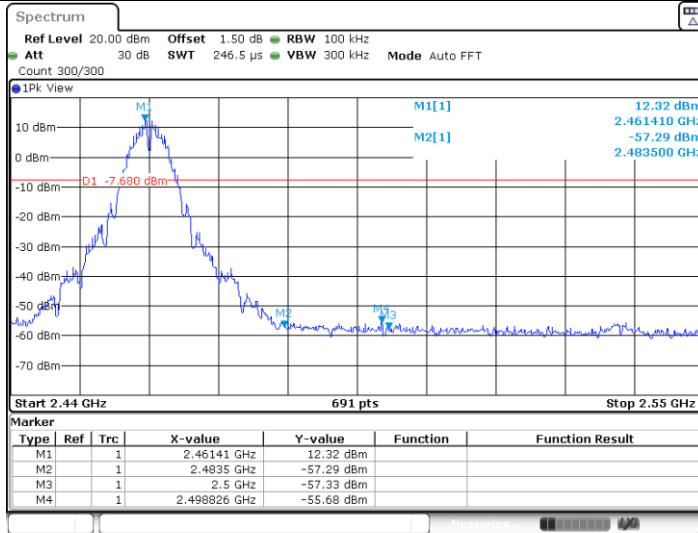

Date: 15.FEB.2022 14:32:39

11G_Ant1_Low_2412

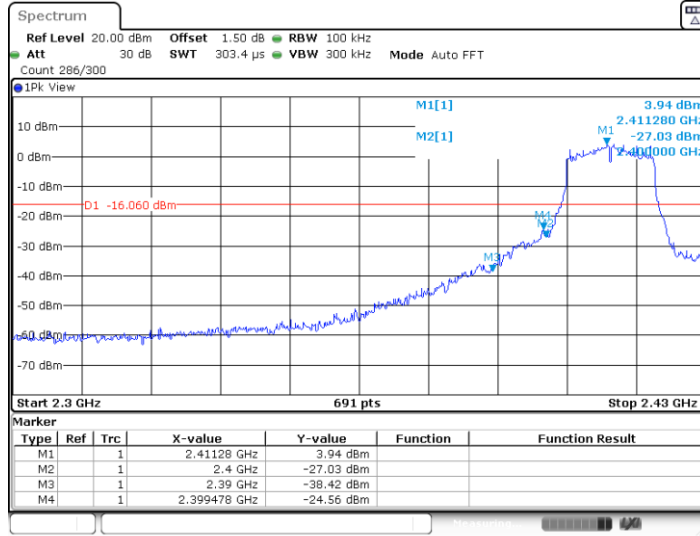

Date: 15.FEB.2022 14:34:08

11G_Ant1_High_2462

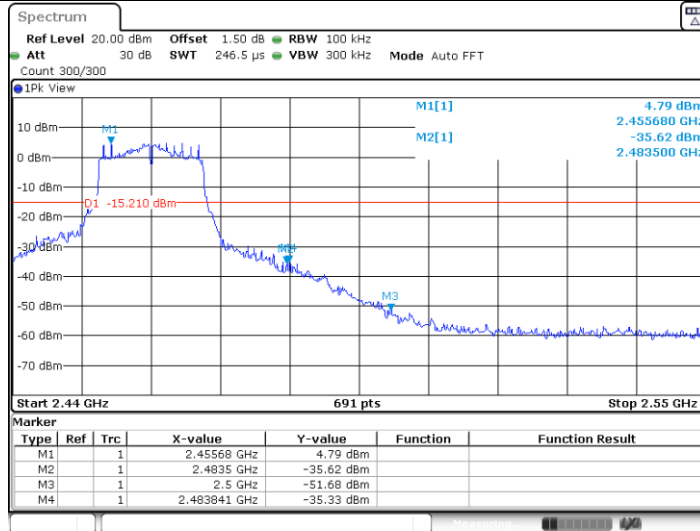

Date: 15.FEB.2022 14:36:57

11N20SISO_Ant1_Low_2412

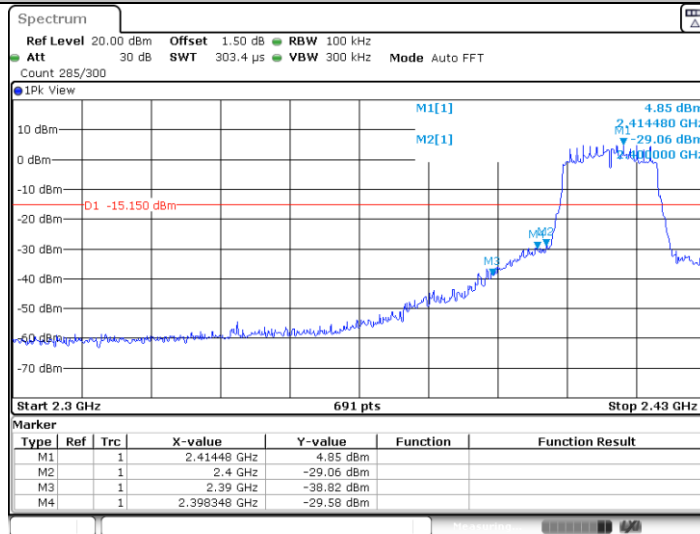

Date: 15.FEB.2022 14:38:29

11N20SISO_Ant1_High_2462

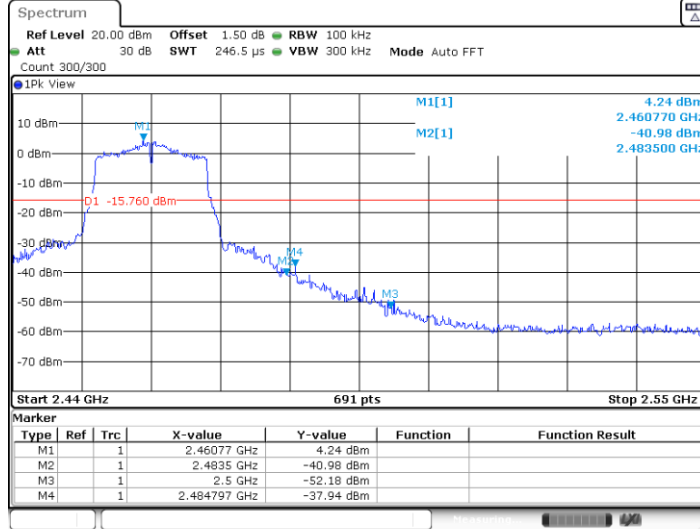

Date: 15.FEB.2022 14:41:24

11AC20SISO_Ant1_Low_2412

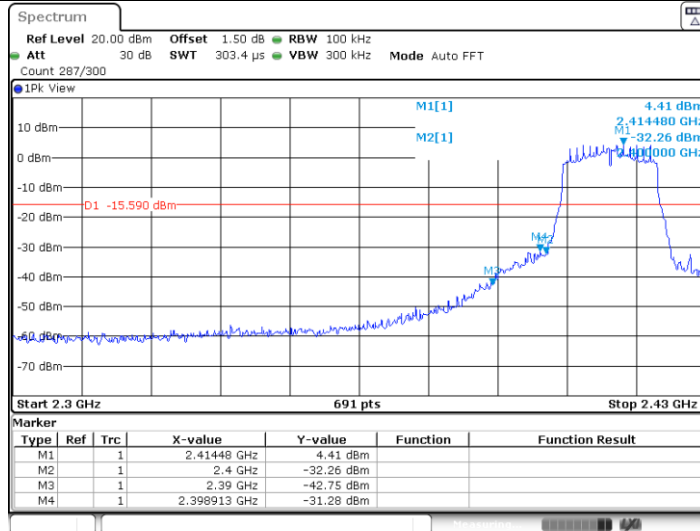

Date: 23.FEB.2022 16:57:33

11AC20SISO_Ant1_High_2462

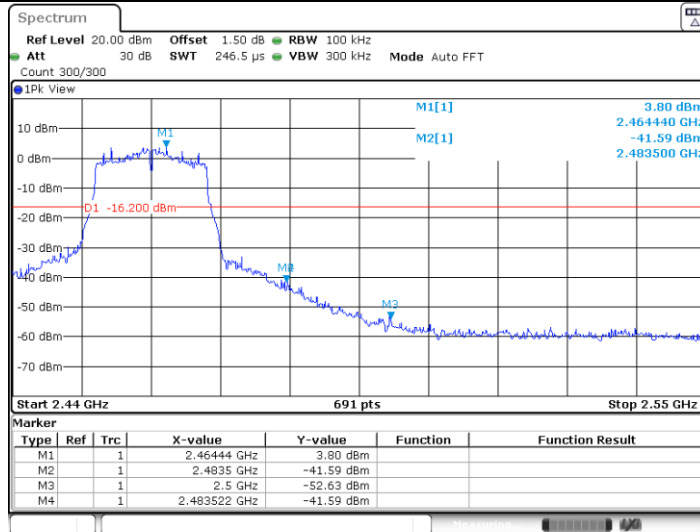

Date: 23.FEB.2022 17:00:53

9.8 Spurious radiated emissions for transmitter

Test Method

- 1: The EUT was placed on a turn table which is 1.5m above ground plane for above 1GHz and 0.8m above ground for below 1GHz at 3 meter chamber room for test. The table was rotated 360 degrees to determine the position of the highest radiation.
- 2: The EUT was set 3 meters away from the interference – receiving antenna, which was mounted on the top of a variable – height antenna tower.
- 3: The height of antenna is varied from one meter to four meters above the ground to determine the maximum value of the field strength. Both horizontal and vertical polarizations of the antenna are set to make the measurement.
- 4: For each suspected emission, the EUT was arranged to its worst case and then the antenna was tuned to heights from 1 meter to 4 meters and the rotatable table was turned from 0 degrees to 360 degrees to find the maximum reading.
- 5: Use the following spectrum analyzer settings According to C63.10:

For Below 1GHz

Use the following spectrum analyzer settings:

Span = wide enough to capture the peak level of the in-band emission and all spurious
 RBW = 100 KHz to 120KHz, VBW ≥ RBW for peak measurement, Sweep = auto, Detector function = peak, Trace = max hold.

For Peak unwanted emissions Above 1GHz:

Span = wide enough to capture the peak level of the in-band emission and all spurious
 RBW = 1MHz, VBW ≥ RBW for peak measurement, Sweep = auto, Detector function = peak, Trace = max hold.

Procedures for average unwanted emissions measurements above 1000 MHz

a) RBW = 1MHz.

b) VBW \ [3 × RBW].

c) Detector = RMS (power averaging), if [span / (# of points in sweep)] \ RBW / 2.

Satisfying this condition can require increasing the number of points in the sweep or reducing the span. If the condition is not satisfied, then the detector mode shall be set to peak.

d) Averaging type = power (i.e., rms) (As an alternative, the detector and averaging type may be set for linear voltage averaging. Some instruments require linear display mode to use linear voltage averaging. Log or dB averaging shall not be used.)

e) Sweep time = auto.

f) Perform a trace average of at least 100 traces if the transmission is continuous. If the transmission is not continuous, then the number of traces shall be increased by a factor of 1 / D, where D is the duty cycle. For example, with 50% duty cycle, at least 200 traces shall be averaged. (If a specific emission is demonstrated to be continuous—i.e., 100% duty cycle—then rather than turning ON and OFF with the transmit cycle, at least 100 traces shall be averaged.)

g) If tests are performed with the EUT transmitting at a duty cycle less than 98%, then a correction factor shall be added to the measurement results prior to comparing with the emission limit, to compute the emission level that would have been measured had the test been performed at 100% duty cycle. The correction factor is computed as follows:

1) If power averaging (rms) mode was used in the preceding step e), then the correction

factor is $[10 \log (1 / D)]$, where D is the duty cycle. For example, if the transmit duty cycle was 50%, then 3 dB shall be added to the measured emission levels.

2) If linear voltage averaging mode was used in the preceding step e), then the correction factor is $[20 \log (1 / D)]$, where D is the duty cycle. For example, if the transmit duty cycle was 50%, then 6 dB shall be added to the measured emission levels.

3) If a specific emission is demonstrated to be continuous (100% duty cycle) rather than turning ON and OFF with the transmit cycle, then no duty cycle correction is required for that emission.

Limit

The radio emission outside the operating frequency band shall be at least 20 dB below that in the 100 kHz bandwidth within the band that contains the highest level of the desired power. Radiated emissions which fall in the restricted bands, as defined in section 15.205 and RSS-GEN 8.10, must comply with the radiated emission limits specified in section 15.209.

Frequency MHz	Field Strength uV/m	Field Strength dBµV/m	Detector
30-88	100	40	QP
88-216	150	43.5	QP
216-960	200	46	QP
960-1000	500	54	QP
Above 1000	500	54	AV
Above 1000	5000	74	PK

Spurious radiated emissions for transmitter

According to C63.10, if the peak (or quasi-peak) measured value complies with the average limit, it is unnecessary to perform an average measurement, so AV emission value did not show in below table if the peak value complies with average limit.

The only worse case (802.11n20) test result is listed in the report.

Transmitting spurious emission test result as below:

Below 1G:

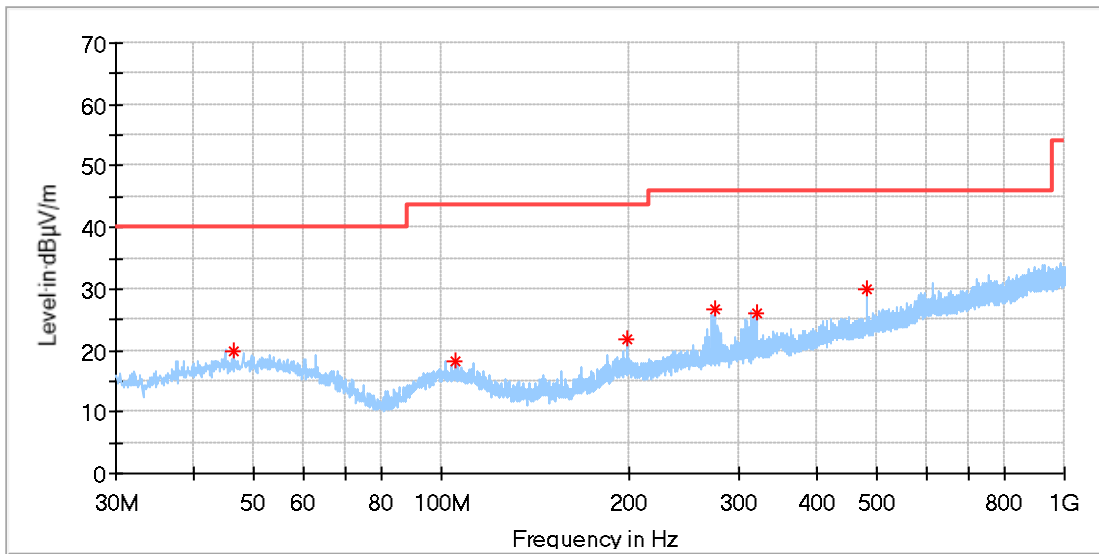

Frequency (MHz)	MaxPeak (dBµV/m)	Limit (dBµV/m)	Margin (dB)	Height (cm)	Pol	Azimuth (deg)	Corr. (dB/m)
46.429375	19.75	40.00	20.25	100.0	H	346.0	20.85
105.175000	18.16	43.50	25.34	100.0	H	3.0	19.22
198.052500	21.66	43.50	21.84	100.0	H	321.0	19.63
274.136875	26.66	46.00	19.34	200.0	H	0.0	20.95
320.151250	26.15	46.00	19.85	100.0	H	198.0	22.08
480.019375	29.81	46.00	16.19	200.0	H	118.0	25.62

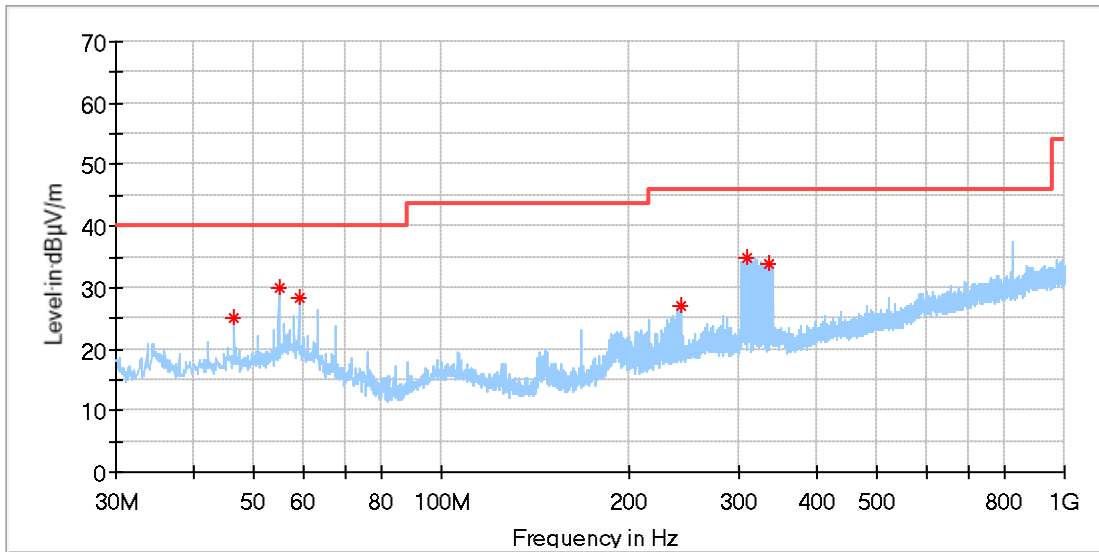

Frequency (MHz)	MaxPeak (dBµV/m)	Limit (dBµV/m)	Margin (dB)	Height (cm)	Pol	Azimuth (deg)	Corr. (dB/m)
46.368750	25.11	40.00	14.89	100.0	V	0.0	20.86
54.856250	30.03	40.00	9.97	100.0	V	311.0	20.80
59.039375	28.29	40.00	11.71	200.0	V	345.0	20.09
242.672500	27.02	46.00	18.98	100.0	V	0.0	20.41
310.330000	34.70	46.00	11.30	100.0	V	3.0	21.80
334.640625	33.89	46.00	12.11	100.0	V	3.0	22.76

Low channel 2412MHz

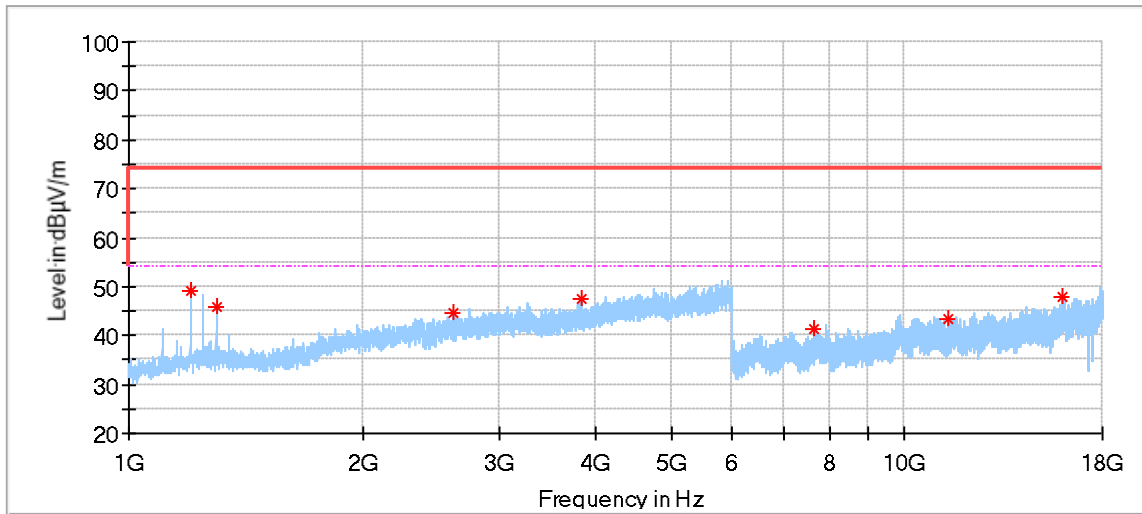

Frequency (MHz)	MaxPeak (dBµV/m)	Limit (dBµV/m)	Margin (dB)	Height (cm)	Pol	Azimuth (deg)	Corr. (dB/m)
1200.500000	49.00	74.00	25.00	150.0	H	28.0	-8.43
1296.500000	45.98	74.00	28.02	150.0	H	9.0	-7.70
2627.500000	44.81	74.00	29.19	150.0	H	62.0	-1.43
3827.500000	47.42	74.00	26.58	150.0	H	68.0	1.21
7643.500000	41.49	74.00	32.51	150.0	H	333.0	7.97
11374.500000	43.53	74.00	30.47	150.0	H	123.0	11.09
15997.000000	47.98	74.00	26.02	150.0	H	290.0	17.53

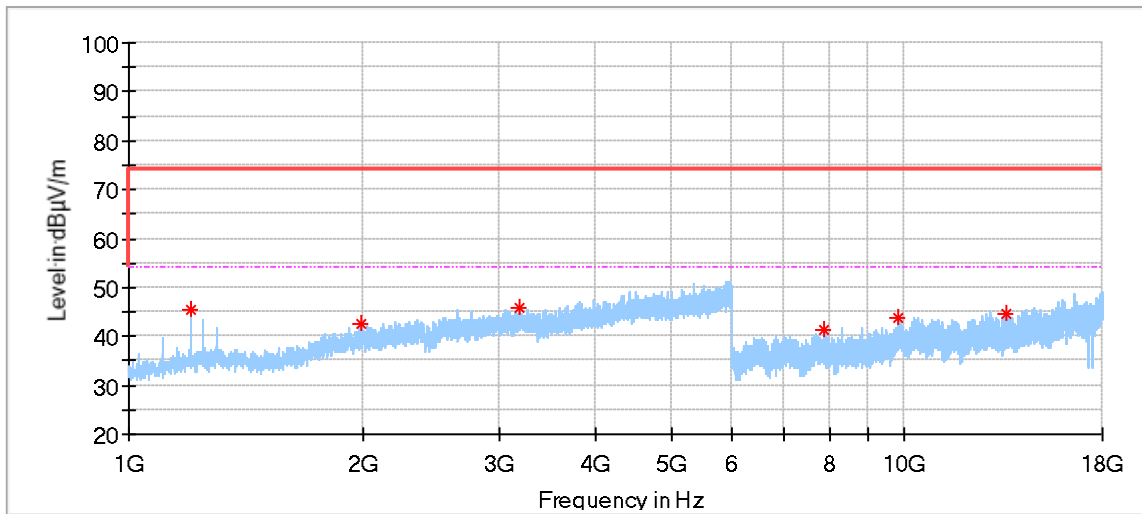

Frequency (MHz)	MaxPeak (dBµV/m)	Limit (dBµV/m)	Margin (dB)	Height (cm)	Pol	Azimuth (deg)	Corr. (dB/m)
1200.000000	45.33	74.00	28.67	150.0	V	4.0	-8.43
1988.000000	42.42	74.00	31.58	150.0	V	15.0	-3.61
3196.000000	45.64	74.00	28.36	150.0	V	82.0	0.23
7859.000000	41.44	74.00	32.56	150.0	V	248.0	8.25
9805.500000	43.76	74.00	30.24	150.0	V	269.0	10.88
13527.500000	44.57	74.00	29.43	150.0	V	68.0	12.48

Middle channel 2437MHz

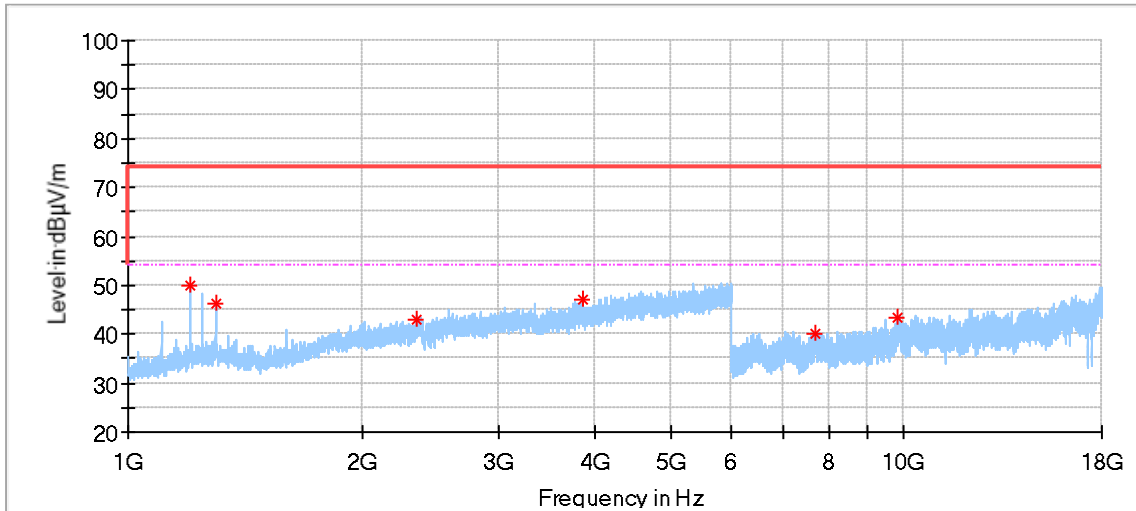

Frequency (MHz)	MaxPeak (dBµV/m)	Limit (dBµV/m)	Margin (dB)	Height (cm)	Pol	Azimuth (deg)	Corr. (dB/m)
1200.000000	49.84	74.00	24.16	150.0	H	28.0	-8.43
1296.500000	46.16	74.00	27.84	150.0	H	9.0	-7.70
2349.500000	42.99	74.00	31.01	150.0	H	242.0	-2.37
3853.500000	47.06	74.00	26.94	150.0	H	22.0	1.27
7678.000000	40.08	74.00	33.92	150.0	H	83.0	8.23
9817.000000	43.27	74.00	30.73	150.0	H	245.0	11.08

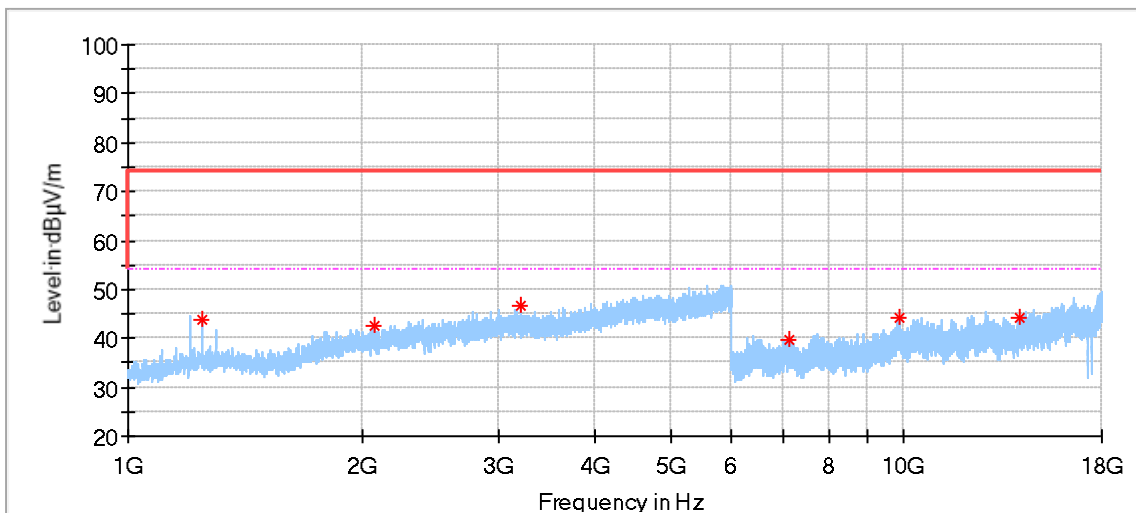

Frequency (MHz)	MaxPeak (dBµV/m)	Limit (dBµV/m)	Margin (dB)	Height (cm)	Pol	Azimuth (deg)	Corr. (dB/m)
1248.000000	43.77	74.00	30.23	150.0	V	358.0	-8.14
2081.500000	42.52	74.00	31.48	150.0	V	343.0	-3.66
3207.000000	46.77	74.00	27.23	150.0	V	129.0	0.20
7109.000000	39.89	74.00	34.11	150.0	V	143.0	7.29
9861.500000	44.21	74.00	29.79	150.0	V	163.0	11.83
14110.500000	44.19	74.00	29.81	150.0	V	245.0	12.55

High channel 2462MHz

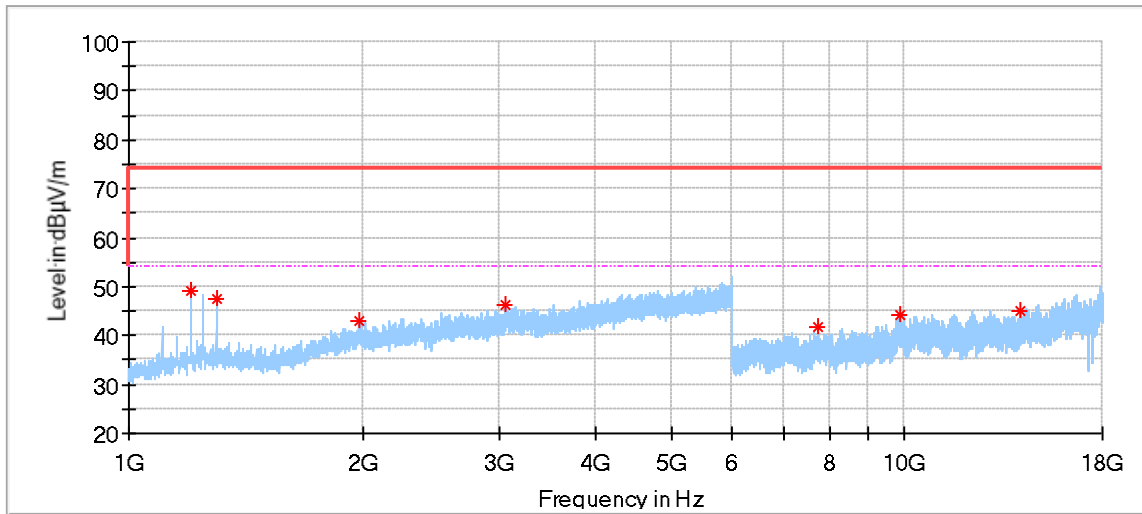

Frequency (MHz)	MaxPeak (dBµV/m)	Limit (dBµV/m)	Margin (dB)	Height (cm)	Pol	Azimuth (deg)	Corr. (dB/m)
1200.000000	49.14	74.00	24.86	150.0	H	312.0	-8.43
1296.000000	47.31	74.00	26.69	150.0	H	17.0	-7.70
1976.000000	43.09	74.00	30.91	150.0	H	292.0	-3.77
3054.000000	46.14	74.00	27.86	150.0	H	84.0	0.13
7738.500000	41.60	74.00	32.40	150.0	H	23.0	8.15
9847.500000	44.12	74.00	29.88	150.0	H	224.0	11.59
14091.000000	44.89	74.00	29.11	150.0	H	43.0	12.51

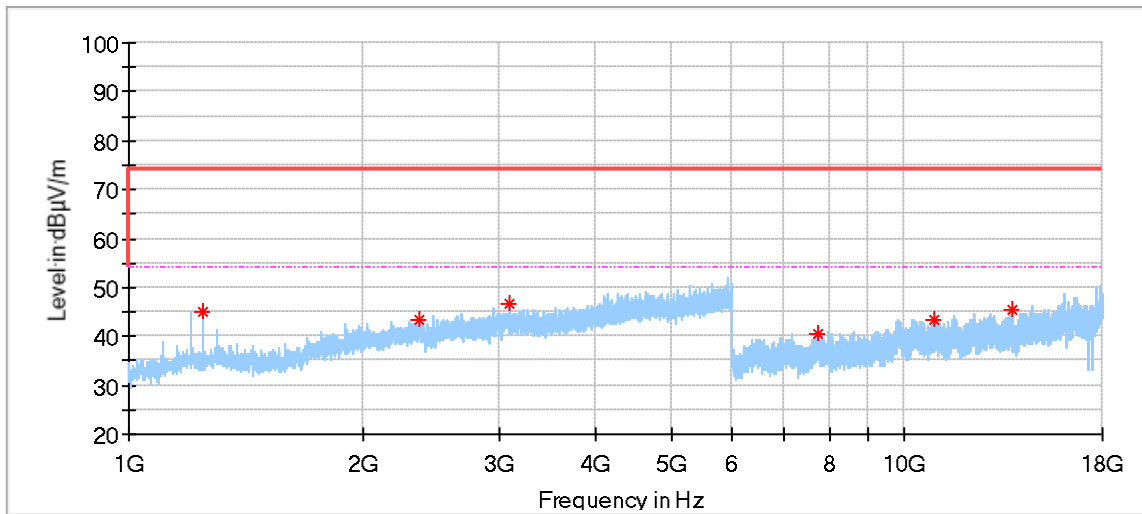

Frequency (MHz)	MaxPeak (dBµV/m)	Limit (dBµV/m)	Margin (dB)	Height (cm)	Pol	Azimuth (deg)	Corr. (dB/m)
1248.000000	45.22	74.00	28.78	150.0	V	359.0	-8.14
2373.000000	43.19	74.00	30.81	150.0	V	298.0	-2.30
3093.500000	46.71	74.00	27.29	150.0	V	165.0	0.23
7749.500000	40.67	74.00	33.33	150.0	V	5.0	8.11
10904.000000	43.53	74.00	30.47	150.0	V	144.0	10.84
13774.000000	45.46	74.00	28.54	150.0	V	81.0	12.12

Remark:

- (1) Data of measurement within frequency range 18-26GHz are the noise floor or attenuated more than 20dB below the permissible limits or the field strength is too small to be measured, so test data does not present in this report,

- (2) These frequencies which exceed the limit are carrier frequency.
- (3) Level= Reading Level + Correction Factor
- (4) Above 1GHz: Corrector factor = Antenna Factor + Cable Loss- Amplifier Gain
Below 1GHz: Corrector factor = Antenna Factor + Cable Loss
(The Reading Level is recorded by software which is not shown in the sheet)

Restricted bands of operation. test result as below:

802.11n20 Modulation 2412MHz

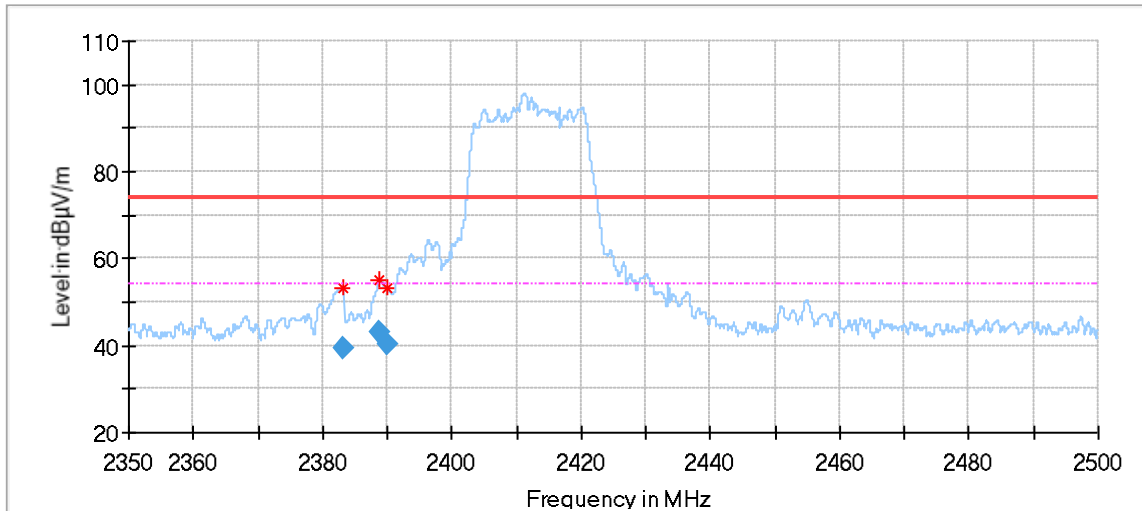

Frequency (MHz)	MaxPeak (dBµV/m)	Limit (dBµV/m)	Margin (dB)	Height (cm)	Pol	Azimuth (deg)	Corr. (dB/m)
2383.165000	53.19	74.00	20.81	150.0	H	339.0	-3.10
2388.790000	54.99	74.00	19.01	150.0	H	352.0	-3.11
2390.125000	53.15	74.00	20.85	150.0	H	352.0	-3.12
Frequency (MHz)	Average (dBµV/m)	Limit (dBµV/m)	Margin (dB)	Height (cm)	Pol	Azimuth (deg)	Corr. (dB/m)
2383.165000	39.25	54.00	14.75	150.0	H	339.0	-3.10
2388.790000	43.02	54.00	10.98	150.0	H	352.0	-3.11
2390.125000	40.12	54.00	13.88	150.0	H	352.0	-3.12

Remark:
 Level=Reading Level + Correction Factor
 Correction Factor=Antenna Factor + Cable Loss – Pre-amplifier
 (The Reading Level is recorded by software which is not shown in the sheet)

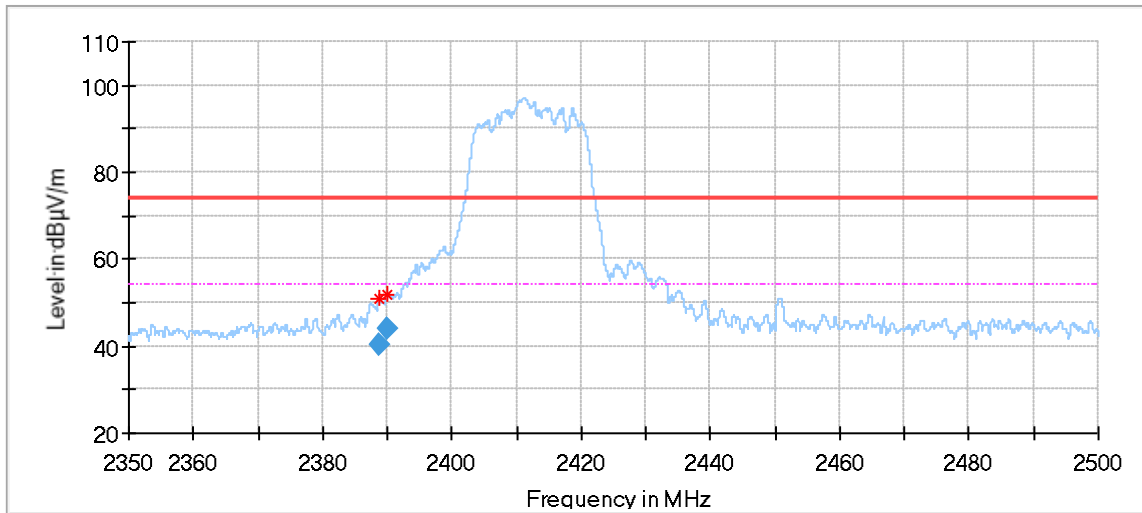

Frequency (MHz)	MaxPeak (dBµV/m)	Limit (dBµV/m)	Margin (dB)	Height (cm)	Pol	Azimuth (deg)	Corr. (dB/m)
2388.775000	51.15	74.00	22.85	150.0	V	313.0	-3.11
2390.035000	52.04	74.00	21.96	150.0	V	261.0	-3.12
Frequency (MHz)	Average (dBµV/m)	Limit (dBµV/m)	Margin (dB)	Height (cm)	Pol	Azimuth (deg)	Corr. (dB/m)
2388.775000	40.26	54.00	13.74	150.0	V	313.0	-3.11
2390.035000	43.96	54.00	10.04	150.0	V	261.0	-3.12

Remark:

Level=Reading Level + Correction Factor

Correction Factor=Antenna Factor + Cable Loss – Pre-amplifier

(The Reading Level is recorded by software which is not shown in the sheet)

802.11n20 Modulation 2462MHz

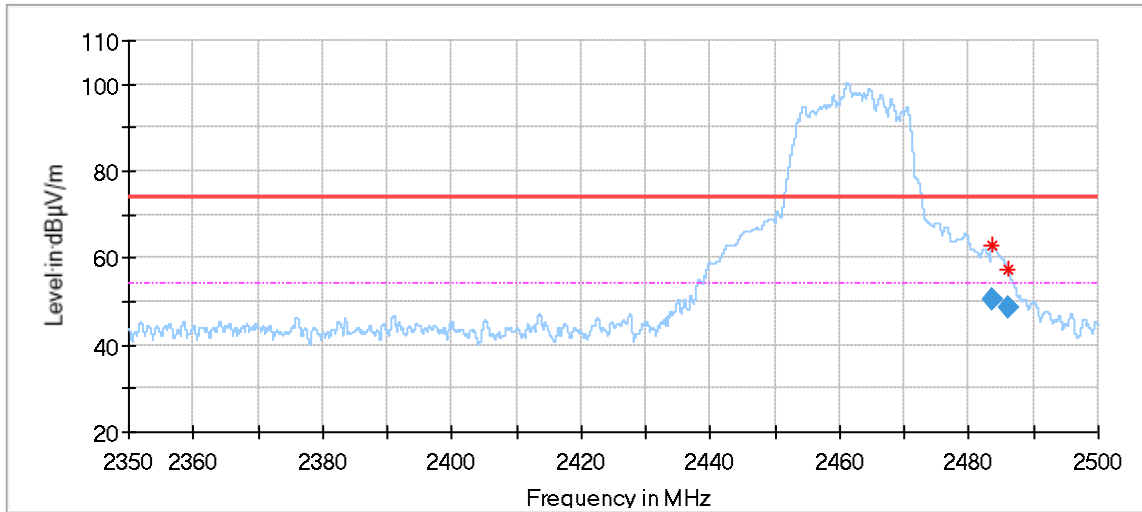

Frequency (MHz)	MaxPeak (dBµV/m)	Limit (dBµV/m)	Margin (dB)	Height (cm)	Pol	Azimuth (deg)	Corr. (dB/m)
2483.560000	63.05	74.00	10.95	150.0	H	4.0	-2.76
2485.900000	57.32	74.00	16.68	150.0	H	4.0	-2.76
Frequency (MHz)	Average (dBµV/m)	Limit (dBµV/m)	Margin (dB)	Height (cm)	Pol	Azimuth (deg)	Corr. (dB/m)
2483.560000	50.25	54.00	3.75	150.0	H	4.0	-2.76
2485.900000	48.78	54.00	5.22	150.0	H	4.0	-2.76

Remark:

Level=Reading Level + Correction Factor

Correction Factor=Antenna Factor + Cable Loss – Pre-amplifier

(The Reading Level is recorded by software which is not shown in the sheet)

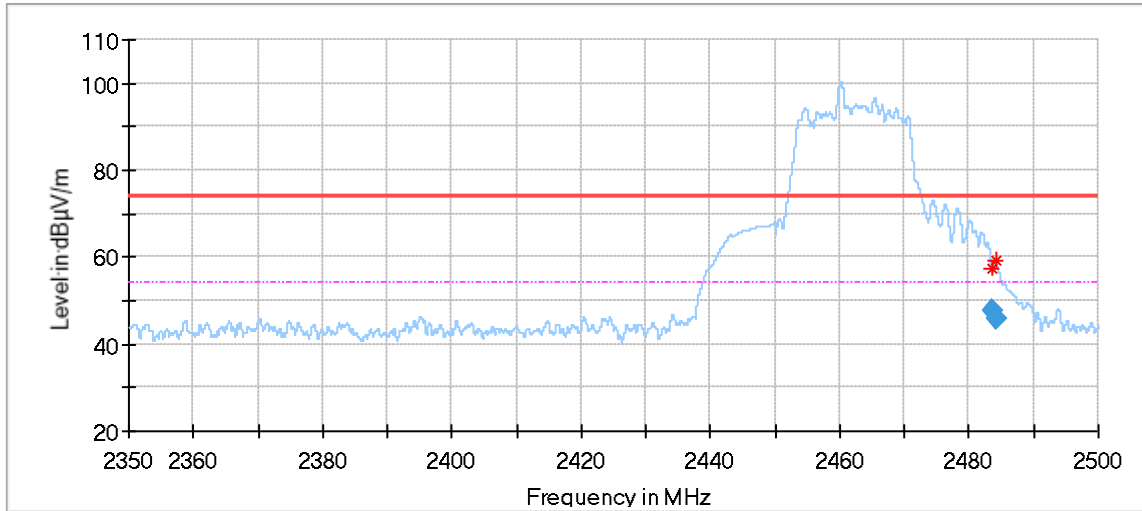

Frequency (MHz)	MaxPeak (dBµV/m)	Limit (dBµV/m)	Margin (dB)	Height (cm)	Pol	Azimuth (deg)	Corr. (dB/m)
2483.515000	57.47	74.00	16.53	150.0	V	247.0	-2.76
2484.040000	59.07	74.00	14.93	150.0	V	256.0	-2.76
Frequency (MHz)	Average (dBµV/m)	Limit (dBµV/m)	Margin (dB)	Height (cm)	Pol	Azimuth (deg)	Corr. (dB/m)
2483.515000	47.85	54.00	6.15	150.0	V	247.0	-2.76
2484.040000	45.83	54.00	8.17	150.0	V	256.0	-2.76

Remark:
 Level=Reading Level + Correction Factor
 Correction Factor=Antenna Factor + Cable Loss – Pre-amplifier
 (The Reading Level is recorded by software which is not shown in the sheet)

10 Test Equipment List

Conducted Emission Test

Description	Manufacturer	Model no.	Equipment ID	Serial no.	cal interval (year)	cal. due date
EMI Test Receiver	Rohde & Schwarz	ESR 3	68-4-74-19-002	102590	1	2022-6-4
LISN	Rohde & Schwarz	ENV216	68-4-87-19-001	102472	1	2022-6-5
Attenuator	Shanghai Huaxiang	TS2-26-3	68-4-81-16-003	080928189	1	2022-6-3
Test software	Rohde & Schwarz	EMC32	68-4-90-19-005-A01	Version10.35.02	N/A	N/A
Shielding Room	TDK	CSR #2	68-4-90-19-005	----	1	2022-11-07

Radiated Emission Test

Description	Manufacturer	Model no.	Equipment ID	Serial no.	cal interval (year)	cal. due date
EMI Test Receiver	Rohde & Schwarz	ESR 26	68-4-74-14-002	101269	1	2022-6-4
Trilog Super Broadband Test Antenna	Schwarzbeck	VULB 9162	68-4-80-19-003	284	1	2022-2-2
Wave Guide Antenna	ETS	3117	68-4-80-19-001	00218954	1	2022-5-24
Pre-amplifier	Rohde & Schwarz	SCU 18F	68-4-29-19-001	100745	1	2022-10-10
Pre-amplifier	Rohde & Schwarz	SCU 18F	68-4-29-19-002	100746	1	2022-10-10
Sideband Horn Antenna	Q-PAR	QWH-SL-18-40-K-SG	68-4-80-14-008	12827	1	2022-7-21
Pre-amplifier	Rohde & Schwarz	SCU 40A	68-4-29-14-002	100432	1	2022-7-27
Attenuator	Mini-circuits	UNAT-6+	68-4-81-21-002	15542	1	2022-8-23
3m Semi-anechoic chamber	TDK	SAC-3 #2	68-4-90-19-006	----	2	2023-5-28
Test software	Rohde & Schwarz	EMC32	68-4-90-19-006-A01	Version10.35.02	N/A	N/A

RF Conducted Test

Description	Manufacturer	Model no.	Equipment ID	Serial no.	cal interval (year)	cal. due date
Signal Analyzer	Rohde & Schwarz	FSV40	68-4-74-14-004	101030	1	2022-6-3

11 System Measurement Uncertainty

For a 95% confidence level, the measurement expanded uncertainties for defined systems, in accordance with the recommendations of ISO 17025 were:

System Measurement Uncertainty	
Test Items	Extended Uncertainty
Uncertainty for Conducted Emission 150kHz-30MHz (for test using AMN ENV432 or ENV4200)	3.62dB
Uncertainty for Radiated Spurious Emission 25MHz-3000MHz	Horizontal: 4.67dB; Vertical: 4.65dB;
Uncertainty for Radiated Spurious Emission 3000MHz-18000MHz	Horizontal: 4.77dB; Vertical: 4.75dB;
Uncertainty for Radiated Spurious Emission 18000MHz-40000MHz	Horizontal: 3.12dB; Vertical: 3.10dB;
Uncertainty for Conducted RF test with TS 8997	RF Power Conducted: 1.27dB Frequency test involved: 0.6×10 ⁻⁷ or 1%

---THE END OF REPORT---