



### FCC/IC - TEST REPORT

Report Number : **68.950.18.0190.01** Date of Issue: June 21, 2018

Model : **SPTM1**

Product Type : Camera

Applicant : GoPro, Inc.

Address : 3000 Clearview Way, San Mateo, CA 94402, USA

Production Facility : GoPro, Inc.

Address : 3000 Clearview Way, San Mateo, CA 94402, USA

Test Result :  **Positive**     **Negative**

Total pages including Appendices : **53**

*TÜV SÜD Certification and Testing (China) Co., Ltd. Shenzhen Branch is a subcontractor to TÜV SÜD Product Service GmbH according to the principles outlined in ISO 17025.*

*TÜV SÜD Certification and Testing (China) Co., Ltd. Shenzhen Branch reports apply only to the specific samples tested under stated test conditions. Construction of the actual test samples has been documented. It is the manufacturer's responsibility to assure that additional production units of this model are manufactured with identical electrical and mechanical components. The manufacturer/importer is responsible to the Competent Authorities in Europe for any modifications made to the production units which result in non-compliance to the relevant regulations. TÜV SÜD Certification and Testing (China) Co., Ltd. Shenzhen Branch shall have no liability for any deductions, inferences or generalizations drawn by the client or others from TÜV SÜD Certification and Testing (China) Co., Ltd. Shenzhen Branch issued reports.*

*This report is the confidential property of the client. As a mutual protection to our clients, the public and ourselves, extracts from the test report shall not be reproduced except in full without our written approval*



# 1 Table of Contents

1	Table of Contents .....	2
2	Details about the Test Laboratory .....	3
3	Description of the Equipment under Test .....	4
4	Summary of Test Standards .....	5
5	Summary of Test Results.....	6
6	General Remarks .....	7
7	Test Setups .....	8
8	Systems test configuration.....	9
9	Technical Requirement.....	10
9.1	Conducted Emission.....	10
9.2	Conducted Average output power .....	13
9.3	6dB bandwidth .....	14
9.4	99% bandwidth .....	19
9.5	Power spectral density .....	24
9.6	Spurious RF conducted emissions .....	29
9.7	Band edge .....	38
9.8	Spurious radiated emissions for transmitter.....	42
10	Test Equipment List .....	52
11	System Measurement Uncertainty.....	53



## 2 Details about the Test Laboratory

### Details about the Test Laboratory

#### Test Site 1

Company name: TÜV SÜD Certification and Testing (China) Co., Ltd. Shenzhen Branch  
Building 12&13, Zhiheng Wisdomland Business Park,  
Nantou Checkpoint Road 2, Nanshan District,  
Shenzhen City, 518052,  
P. R. China

FCC Registration Number: 514049

IC Registration Number: 10320A-1

Telephone: 86 755 8828 6998  
Fax: 86 755 8828 5299

### 3 Description of the Equipment under Test

Product:	Camera
Model no.:	SPTM1
IC:	10193A-SPTM1
FCC ID:	CNFSPTM1
Rating:	3.85Vdc
RF Transmission Frequency:	2412MHz-2462MHz for 802.11b/g/n HT20 2422MHz-2452MHz for 802.11n HT40
No. of Operated Channel:	11
Modulation:	802.11b: BPSK, QPSK, CCK, 802.11g/802.11n HT20/40: BPSK, QPSK, 16-QAM, 64-QAM
Antenna Type:	Integrated Metal antenna
Antenna Gain:	0.5dBi max for 2.4GHz
Description of the EUT:	The Equipment Under Test (EUT) is a Camera supports 2.4GHz Bluetooth/WIFI, 5GHz WIFI functions.



## 4 Summary of Test Standards

Test Standards	
FCC Part 15 Subpart C 10-1-2017 Edition	PART 15 - RADIO FREQUENCY DEVICES Subpart C - Intentional Radiators
RSS-Gen Issue 5 April 2018	RSS-Gen — General Requirements for Compliance of Radio Apparatus
RSS-247 Issue 2 February 2017	Digital Transmission Systems (DTS), Frequency Hopping Systems (FHSS) and License-Exempt Local Area Network (LE-LAN) Devices

All the test methods were according to KDB558074 D01 v4.0 DTS Measurement Guidance and ANSI C63.10 (2013).



## 5 Summary of Test Results

Technical Requirements					
FCC Part 15 Subpart C/RSS-247 Issue 2/RSS-Gen Issue 5					
Test Condition			Pages	Test Result	Test Site
§15.207	RSS-GEN 8.8	Conducted emission AC power port	10	Pass	Site 1
§15.247(b)(1)	RSS-247 Clause 5.4(b)	Conducted AV output power for FHSS	--	N/A	--
§15.247(b)(3)	RSS-247 Clause 5.4(d)	Conducted AV output power for DTS	13	Pass	Site 1
§15.247(e)	RSS-247 Clause 5.2(b)	Power spectral density	24	Pass	Site 1
§15.247(a)(2)	RSS-247 Clause 5.2(a)	6dB bandwidth	14	Pass	Site 1
§15.247(a)(1)	RSS-247 Clause 5.1(a)	20dB Occupied bandwidth	--	N/A	--
--	RSS-GEN 6.7	99% Occupied Bandwidth	19	Pass	Site 1
§15.247(a)(1)	RSS-247 Clause 5.1(b)	Carrier frequency separation	--	N/A	--
§15.247(a)(1)(i ii)	RSS-247 Clause 5.1(d)	Number of hopping frequencies	--	N/A	--
§15.247(a)(1)(i ii)	RSS-247 Clause 5.1(d)	Dwell Time	--	N/A	--
§15.247(d)	RSS-247 Clause 5.5	Spurious RF conducted emissions	29	Pass	Site 1
§15.247(d)	RSS-247 Clause 5.5	Band edge	38	Pass	Site 1
§15.247(d) & §15.209 & §15.205	RSS-247 Clause 5.5 & RSS-GEN 6.13 RSS-GEN 8.9 RSS-GEN 8.10	Spurious radiated emissions for transmitter	42	Pass	Site 1
§15.203	RSS-GEN 6.8	Antenna requirement	See note 2	Pass	--

Note 1: N/A – Not Applicable.

Note 2: The EUT uses an integrated metal antenna 0.5dBi max. According to §15.203, it is considered sufficiently to comply with the provisions of this section.



## 6 General Remarks

### Remarks

This submittal(s) (test report) is intended for FCC ID: CNFSPTM1, IC: 10193A-SPTM1, complies with Section 15.207, 15.209, 15.205, 15.247 of the FCC Part 15, Subpart C and RSS 247 and RSS-Gen rules.

The Model: SPTM1 supports Bluetooth BR+EDR/Bluetooth Low Energy/WIFI/GPS & Galileo receiving functions, power by 3.85Vdc, 1220mAh supplied by an internal rechargeable Lithium Ion Battery or 5Vdc supplied by USB type C port.

The TX and RX range is 2402MHz-2480MHz for Bluetooth, 2412MHz – 2462MHz for 2.4GHzWIFI, 5180MHz – 5320MHz, 5500MHz – 5700MHz, 5745MHz – 5825MHz for 5GHzWIFI, 1575.42MHz for GNSS (only GPS and Galileo) Receiver, also supports two versions (Version W and Version S), the Version W is identical with the Version S except of the Version S is Dark grey color with GPS & Galileo receiving function, supported resolutions:4K/30fps, 1440/30fps, 1440/60fps and 960/90fps. The Version W is Light grey color without GPS & Galileo receiving function; supported resolutions: 1440/30fps and 1440/60fps, therefore Spurious Emissions was tested with the two versions, and the others test items were only performed on the Version S.

This report is for the WIFI 2.4GHz part.

### SUMMARY:

All tests according to the regulations cited on page 5 were

- Performed

- **Not** Performed

The Equipment under Test

- **Fulfills** the general approval requirements.

- **Does not** fulfill the general approval requirements.

Sample Received Date: May 09, 2018

Testing Start Date: May 09, 2018

Testing End Date: June 06, 2018

- TÜV SÜD Certification and Testing (China) Co., Ltd. Shenzhen Branch -

Reviewed by:

Prepared by:

Tested by:



Laurent Yuan  
EMC Project Manager

Aaron Lai  
EMC Project Engineer

Louise Liu  
EMC Test Engineer

## 7 Test Setups

### 7.1 Radiated test setups

Below 1GHz

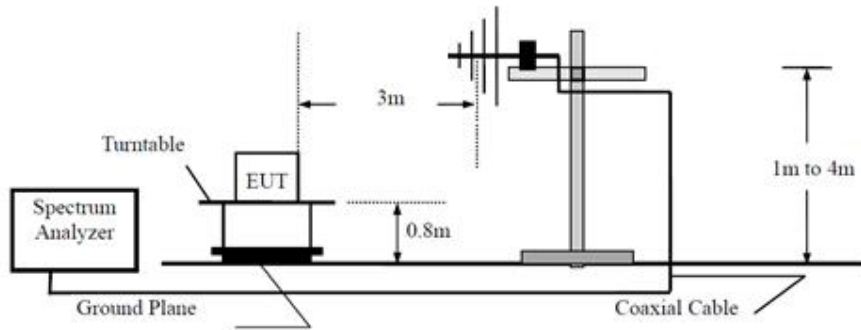

Above 1GHz

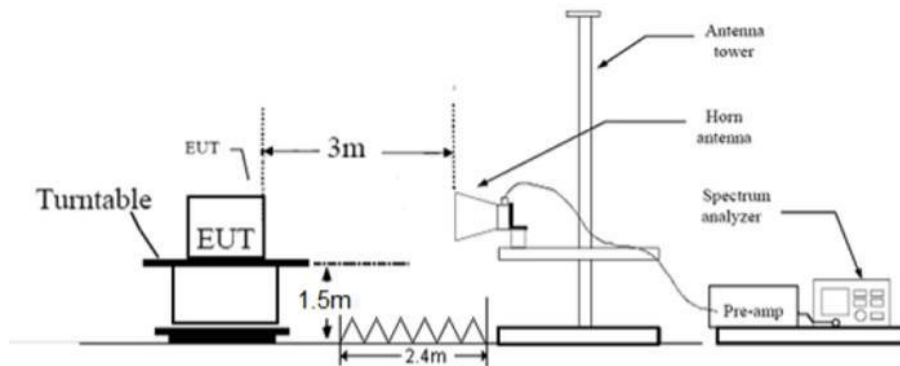

### 7.2 Conducted RF test setups

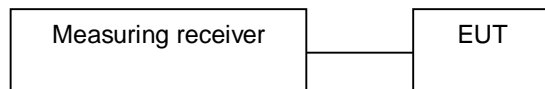

### 7.3 AC Power Line Conducted Emission test setups

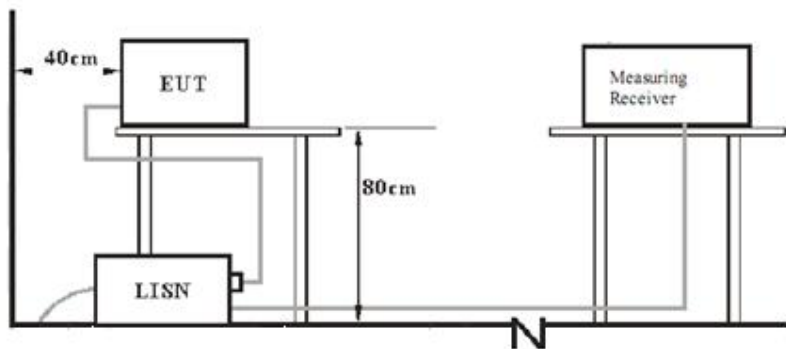



## 8 Systems test configuration

### Auxiliary Equipment Used during Test:

DESCRIPTION	MANUFACTURER	MODEL NO.	S/N
Laptop	Lenovo	T460S	---
USB Type C cable	GoPro	0.55m (Length)	---
AC Adapter	Apple	A1401	---

### Test software information:

Test Software Version	QRCT (V3.0-00230) from QUALCOMM	
Modulation	Setting TX Power	Data Rate
802.11b	14	11b LONG 1 Mbps
802.11g	14	11g 6 Mbps
802.11n HT20	14	MCS0 6.5 Mbps
802.11n HT40	14	MCS0 13.5 Mbps (40MHz)

### Test Channel information:

Test Mode	Channel (MHz)		
802.11b	CH 1: 2412MHz	CH 6: 2437MHz	CH 11: 2462MHz
802.11g	CH 1: 2412MHz	CH 6: 2437MHz	CH 11: 2462MHz
802.11n HT20	CH 1: 2412MHz	CH 6: 2437MHz	CH 11: 2462MHz
802.11n HT40	CH 3: 2422MHz	CH 6: 2437MHz	CH 9: 2452MHz



## 9 Technical Requirement

### 9.1 Conducted Emission

#### Test Method

1. The EUT was placed on a table, which is 0.8m above ground plane
2. The power line of the EUT is connected to the AC mains through a Artificial Mains Network (A.M.N.).
3. Maximum procedure was performed to ensure EUT compliance
4. A EMI test receiver is used to test the emissions from both sides of AC line

#### Limit

Frequency MHz	QP Limit dB $\mu$ V	AV Limit dB $\mu$ V
0.150-0.500	66-56*	56-46*
0.500-5	56	46
5-30	60	50

Decreasing linea

## Conducted Emission

Product Type : Camera  
 M/N : SPTM1 (Version S)  
 Operating Condition : Charging + TX  
 Test Specification : Power Line, Live  
 Comment : AC 120V/60Hz (External adapter)

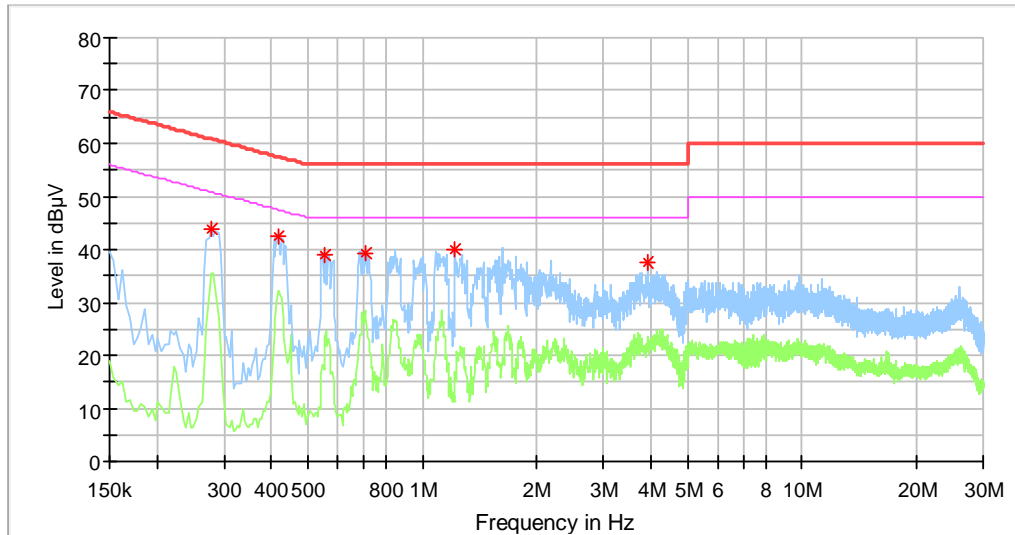

Frequency (MHz)	MaxPeak (dBµV)	Average (dBµV)	Limit (dBµV)	Margin (dB)	Line	Corr. (dB)
0.278000	43.98	---	60.88	16.89	L1	10.2
0.418000	42.51	---	57.49	14.98	L1	11.4
0.554000	38.77	---	56.00	17.23	L1	10.2
0.706000	39.33	---	56.00	16.67	L1	10.2
1.222000	40.16	---	56.00	15.84	L1	10.2
3.930000	37.58	---	56.00	18.42	L1	10.3

Remark : “\*” Correct factor=cable loss + LISN factor

## Conducted Emission

Product Type : Camera  
 M/N : SPTM1 (Version S)  
 Operating Condition : Charging + TX  
 Test Specification : Power Line, Neutral  
 Comment : AC 120V/60Hz (External adapter)

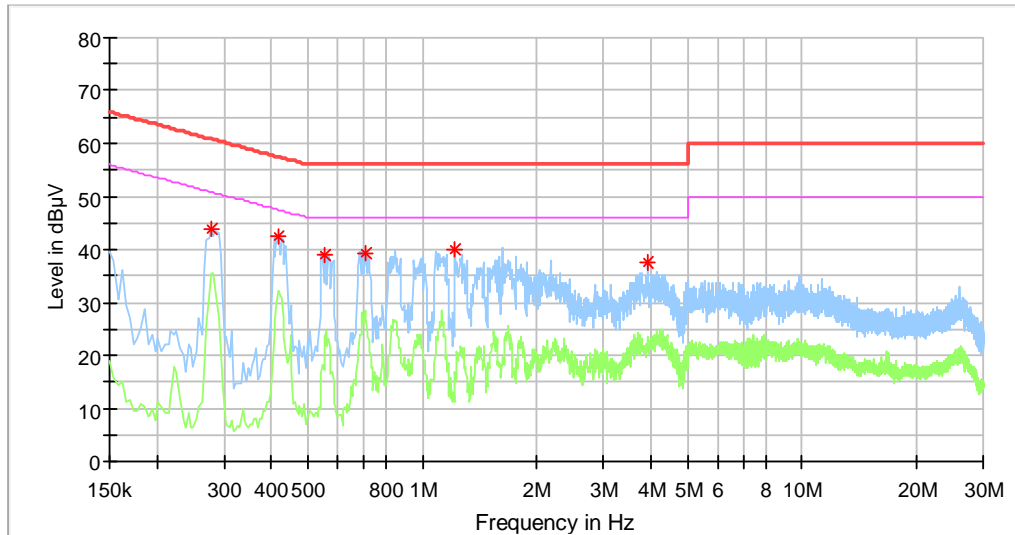

Frequency (MHz)	MaxPeak (dBµV)	Average (dBµV)	Limit (dBµV)	Margin (dB)	Line	Corr. (dB)
0.278000	43.98	---	60.88	16.89	L1	10.2
0.418000	42.51	---	57.49	14.98	L1	11.4
0.554000	38.77	---	56.00	17.23	L1	10.2
0.706000	39.33	---	56.00	16.67	L1	10.2
1.222000	40.16	---	56.00	15.84	L1	10.2
3.930000	37.58	---	56.00	18.42	L1	10.3

Remark : “\*” Correct factor=cable loss + LISN factor

## 9.2 Conducted Average output power

### Test Method

1. Setting the highest output power level of the EUT:
2. Connect to gated RF power meter.

### Test Setup

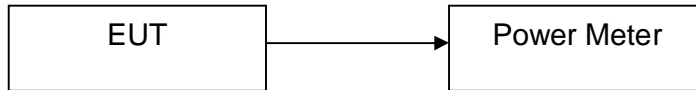

### Limits

According to §15.247 (b) (3), conducted Average output power limit as below:

Frequency Range MHz	Limit W	Limit dBm
2400-2483.5	≤1	≤30

Test result as below table

802.11b

Frequency MHz	Conducted Average Output Power dBm	Result
Top channel 2412MHz	15.80	Pass
Middle channel 2437MHz	<b>15.90</b>	Pass
Bottom channel 2462MHz	15.80	Pass

802.11g

Frequency MHz	Conducted Average Output Power dBm	Result
Top channel 2412MHz	<b>15.60</b>	Pass
Middle channel 2437MHz	15.40	Pass
Bottom channel 2462MHz	15.40	Pass

802.11n HT20

Frequency MHz	Conducted Average Output Power dBm	Result
Top channel 2412MHz	<b>15.60</b>	Pass
Middle channel 2437MHz	15.40	Pass
Bottom channel 2462MHz	15.40	Pass

802.11n HT40

Frequency MHz	Conducted Average Output Power dBm	Result
Top channel 2422MHz	<b>15.60</b>	Pass
Middle channel 2437MHz	15.50	Pass
Bottom channel 2452MHz	15.40	Pass



### 9.3 6dB bandwidth

#### Test Method

1. Use the following spectrum analyzer settings:  
RBW=100K, VBW≥3RBW, Sweep = auto, Detector function = peak, Trace = max hold
2. Use the automatic bandwidth measurement capability of an instrument, may be employed using the X dB bandwidth mode with X set to 6 dB, care shall be taken so that the bandwidth measurement is not influenced by any intermediate power nulls in the fundamental emission that might be ≥ 6 dB.
3. Allow the trace to stabilize, record the X dB Bandwidth value.

#### Limit

Limit [kHz]

\_\_\_\_\_

≥500

#### Test result

Test Mode	Channel (MHz)	Result (MHz)	Limit (KHz)	Verdict
11b	2412	7.200	≥500	PASS
11b	2437	7.200	≥500	PASS
11b	2462	8.120	≥500	PASS
11g	2412	16.440	≥500	PASS
11g	2437	16.440	≥500	PASS
11g	2462	16.440	≥500	PASS
11n HT20	2412	17.640	≥500	PASS
11n HT20	2437	17.640	≥500	PASS
11n HT20	2462	17.640	≥500	PASS
11n HT40	2422	35.280	≥500	PASS
11n HT40	2437	35.440	≥500	PASS
11n HT40	2452	35.440	≥500	PASS

Test Graphs

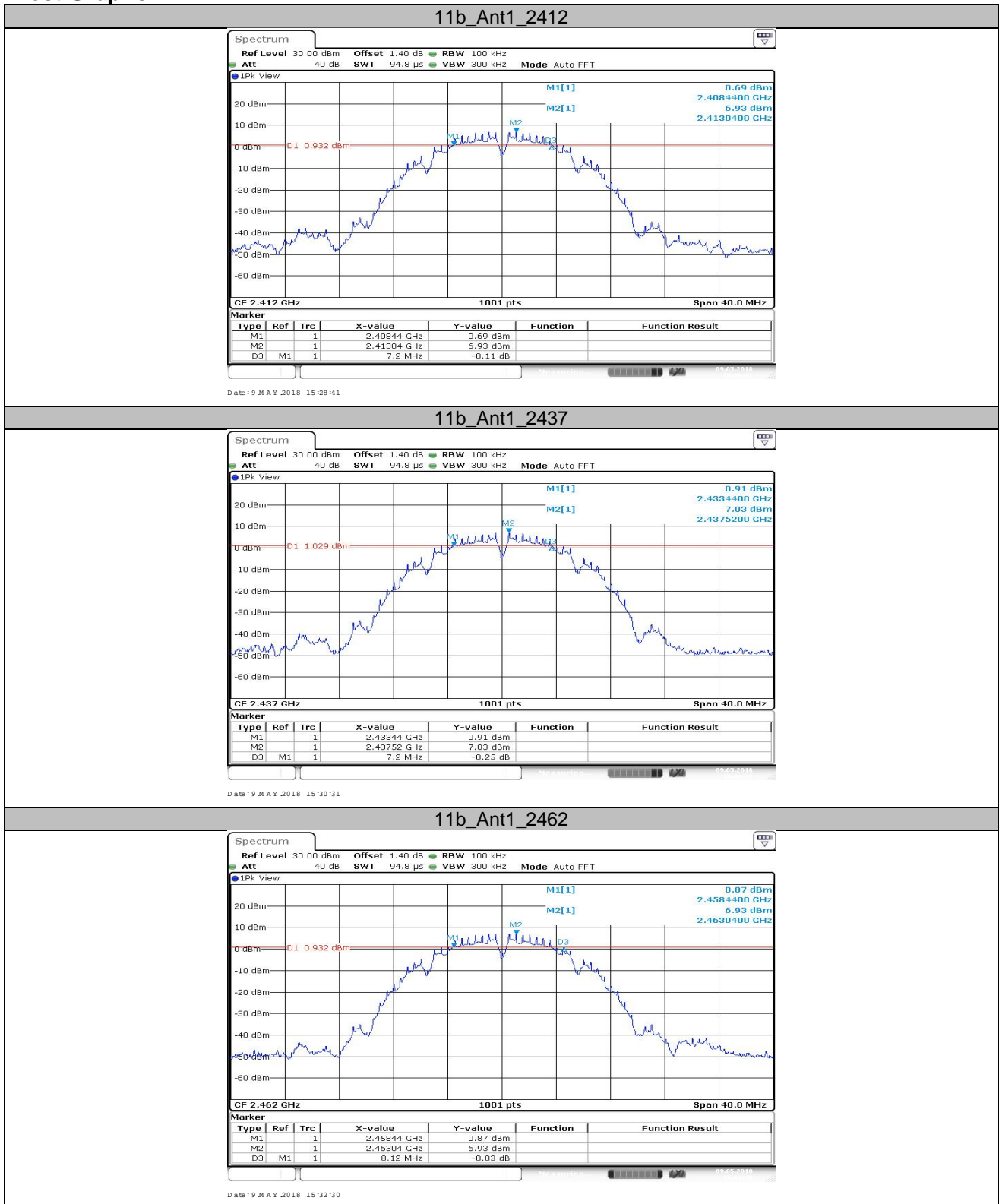

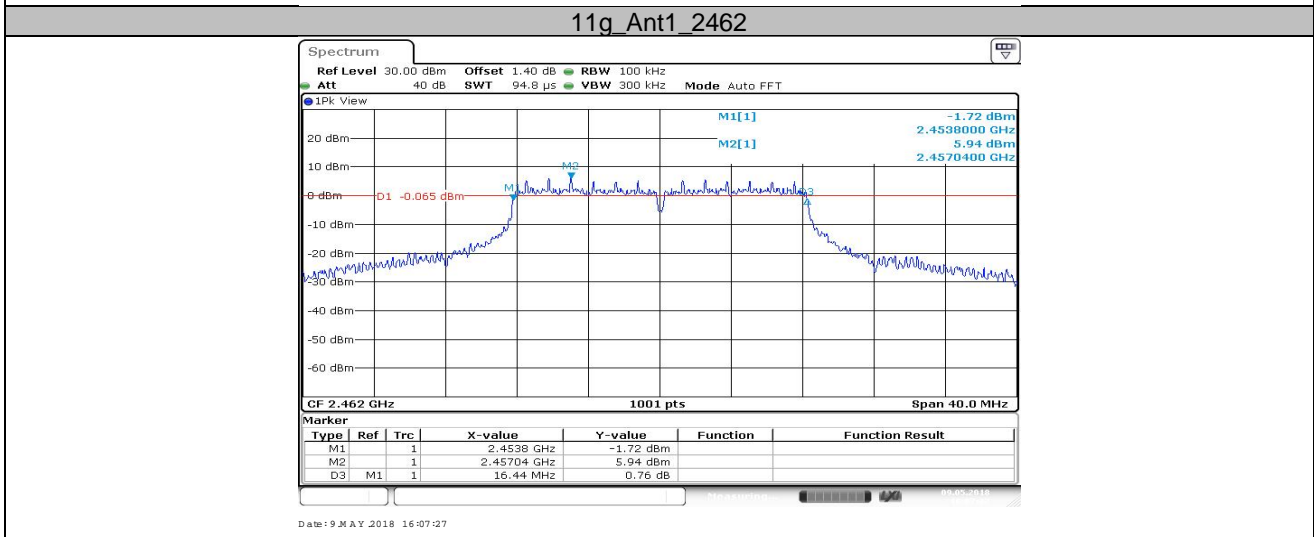
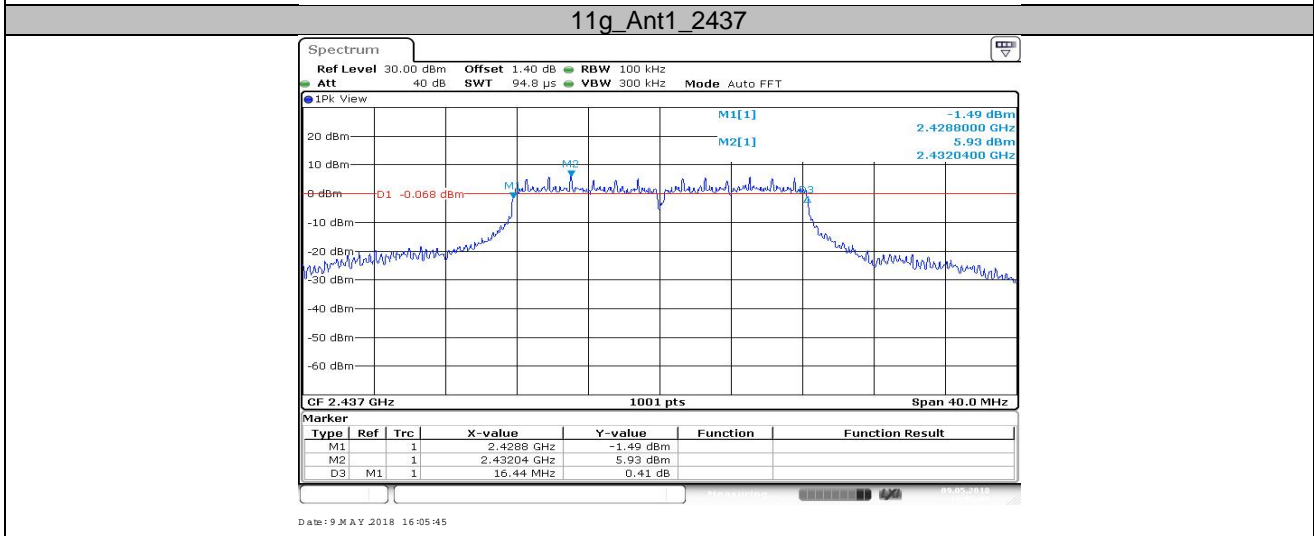
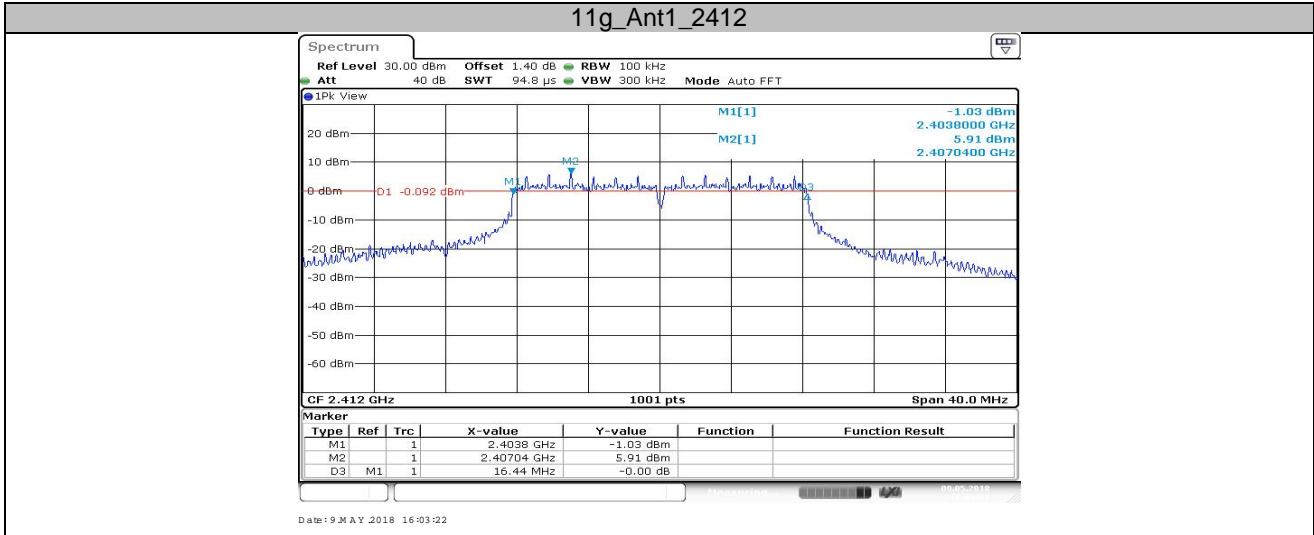



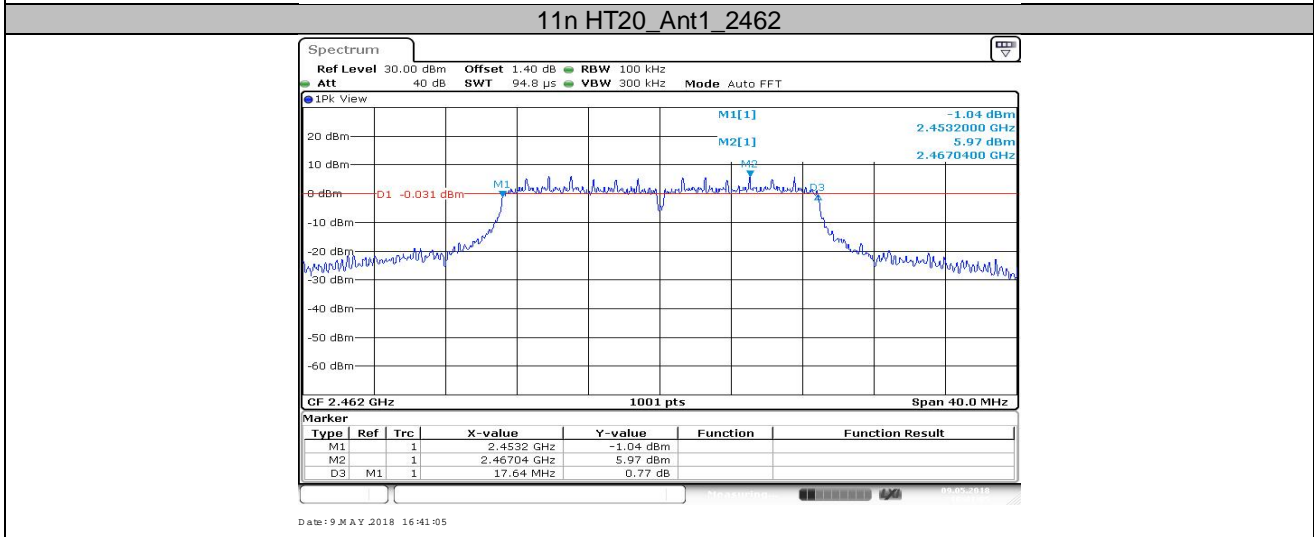
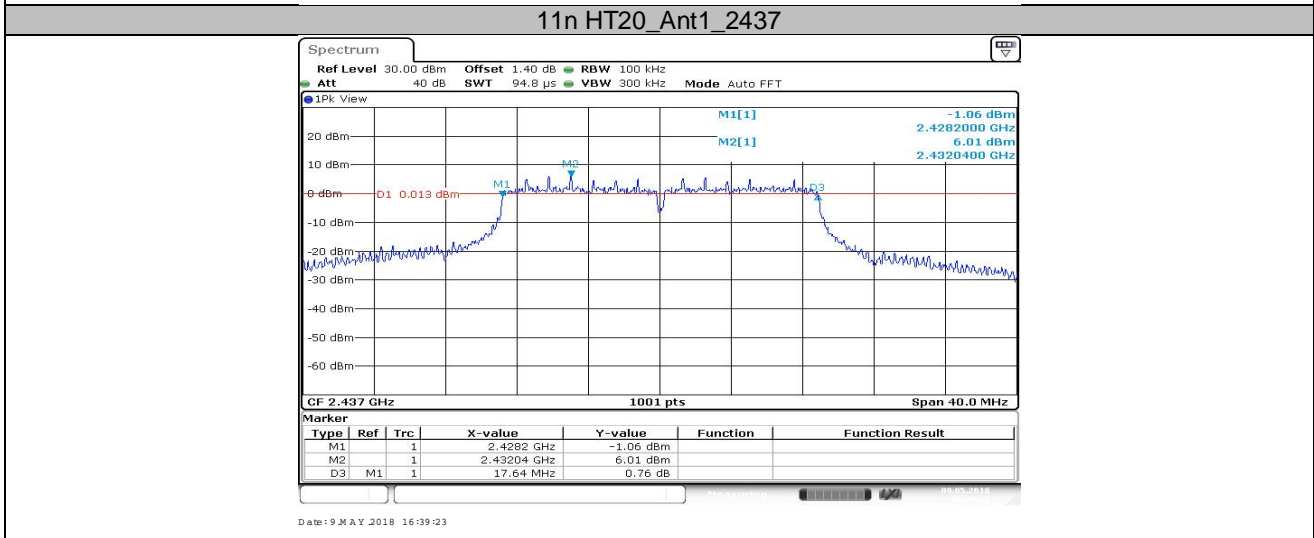
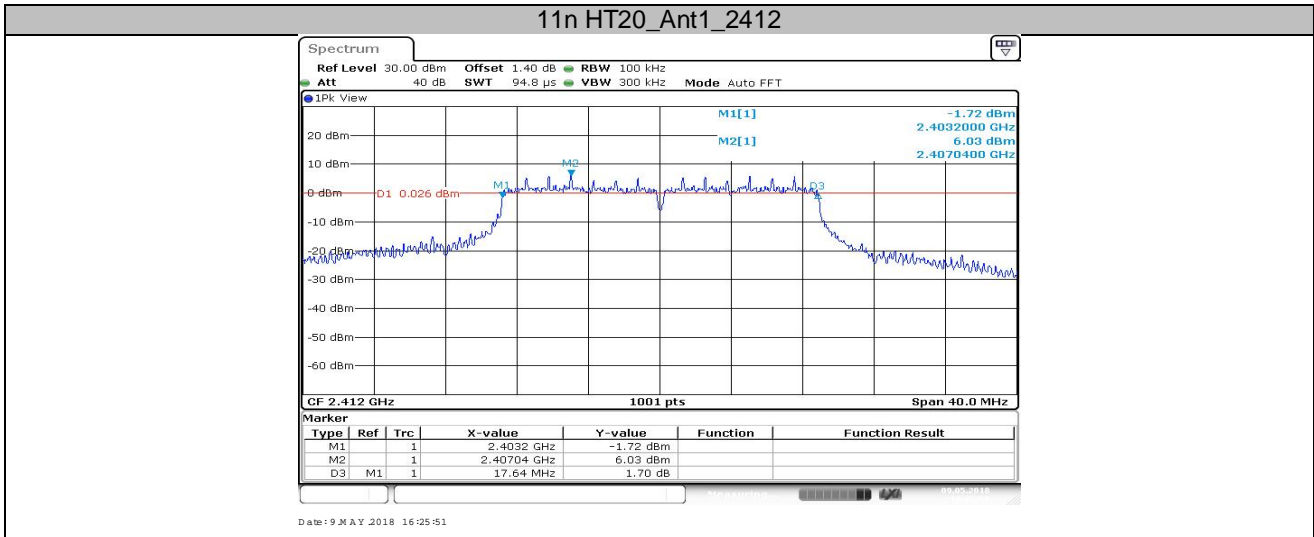

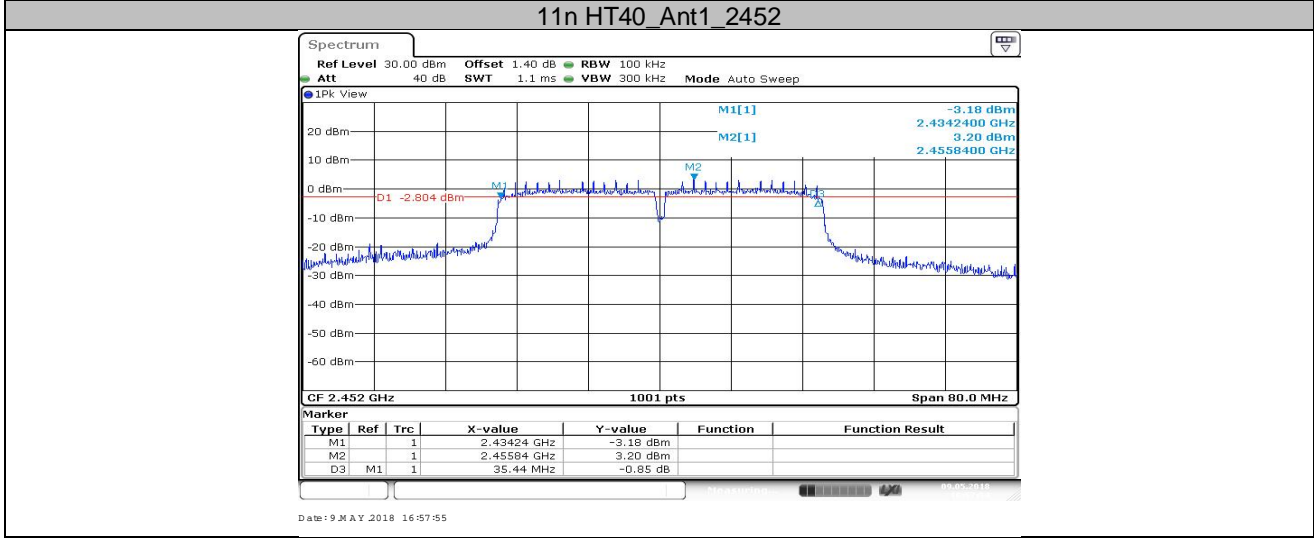
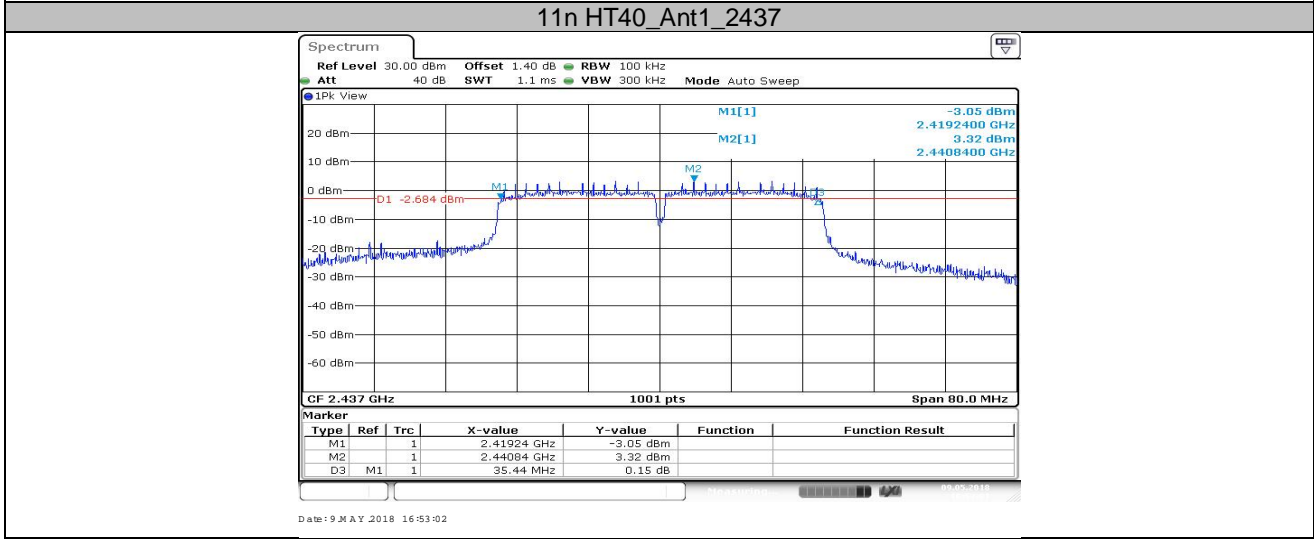
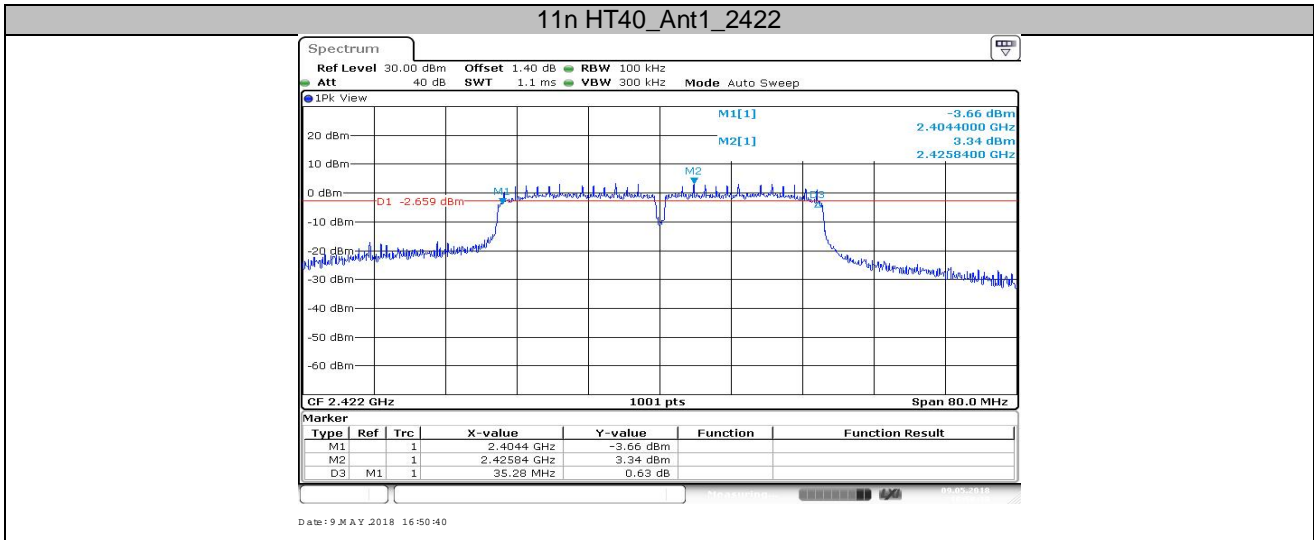



## 9.4 99% bandwidth

### Test Method

4. Use the following spectrum analyzer settings:  
RBW=100K, VBW≥3RBW, Sweep = auto, Detector function = peak, Trace = max hold
5. Use the automatic bandwidth measurement capability of an instrument, may be employed using the OBW bandwidth mode.
6. Allow the trace to stabilize, record the OBW Bandwidth value.

### Limit

Limit [kHz]

---

--

### Test Result

Test Mode	Channel (MHz)	Result (MHz)	Limit (KHz)	Verdict
11b	2412	13.187	---	PASS
11b	2437	13.147	---	PASS
11b	2462	13.147	---	PASS
11g	2412	18.661	---	PASS
11g	2437	18.302	---	PASS
11g	2462	18.102	---	PASS
11n HT20	2412	19.341	---	PASS
11n HT20	2437	19.061	---	PASS
11n HT20	2462	18.861	---	PASS
11n HT40	2422	39.800	---	PASS
11n HT40	2437	38.921	---	PASS
11n HT40	2452	38.521	---	PASS



### Test Graphs

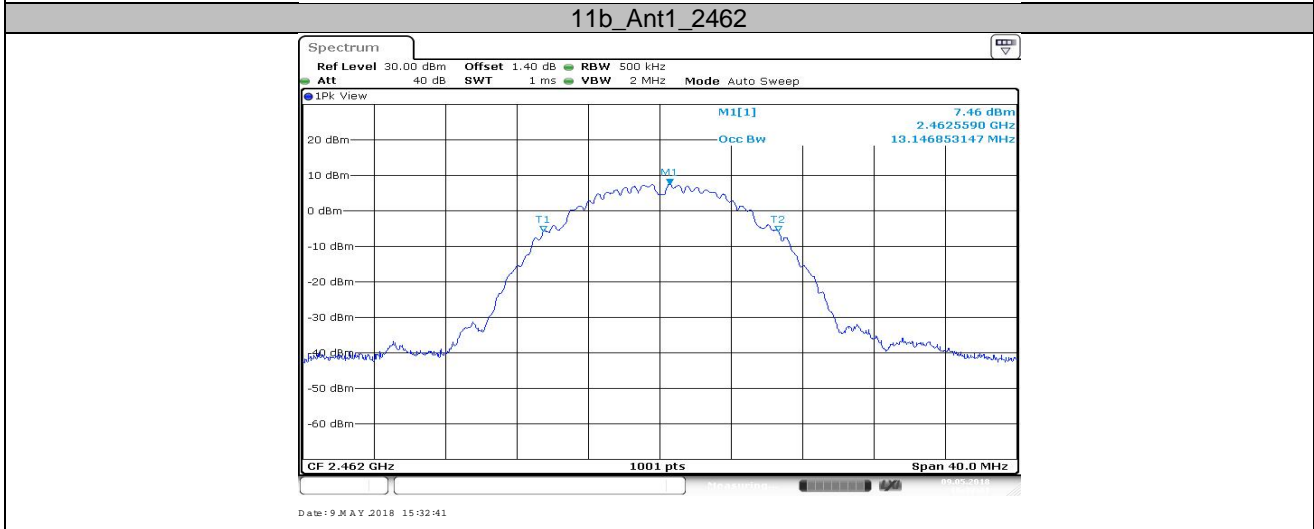
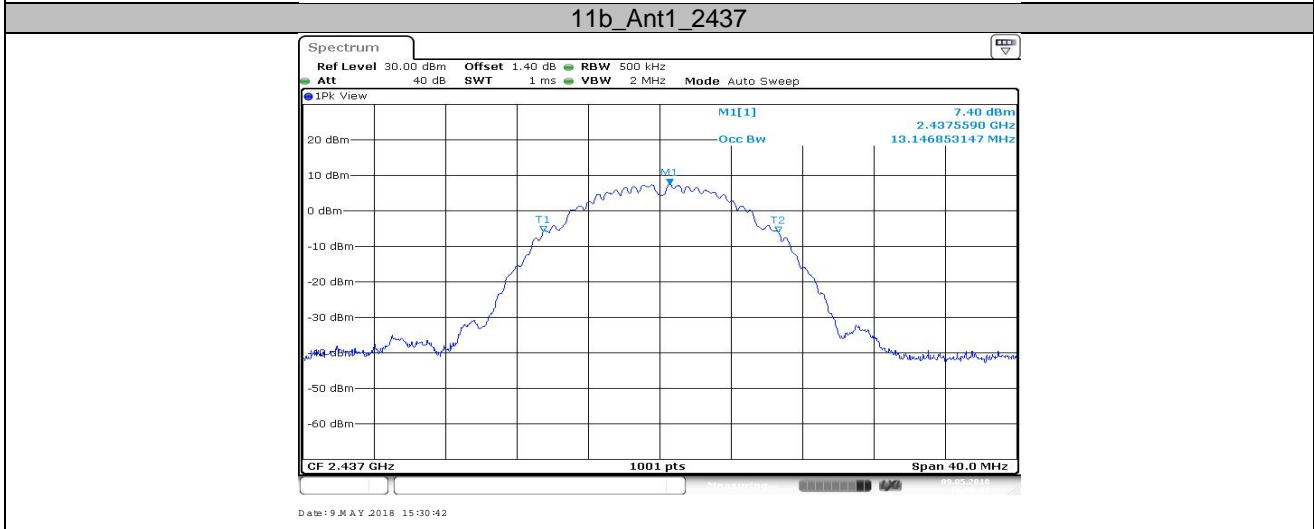
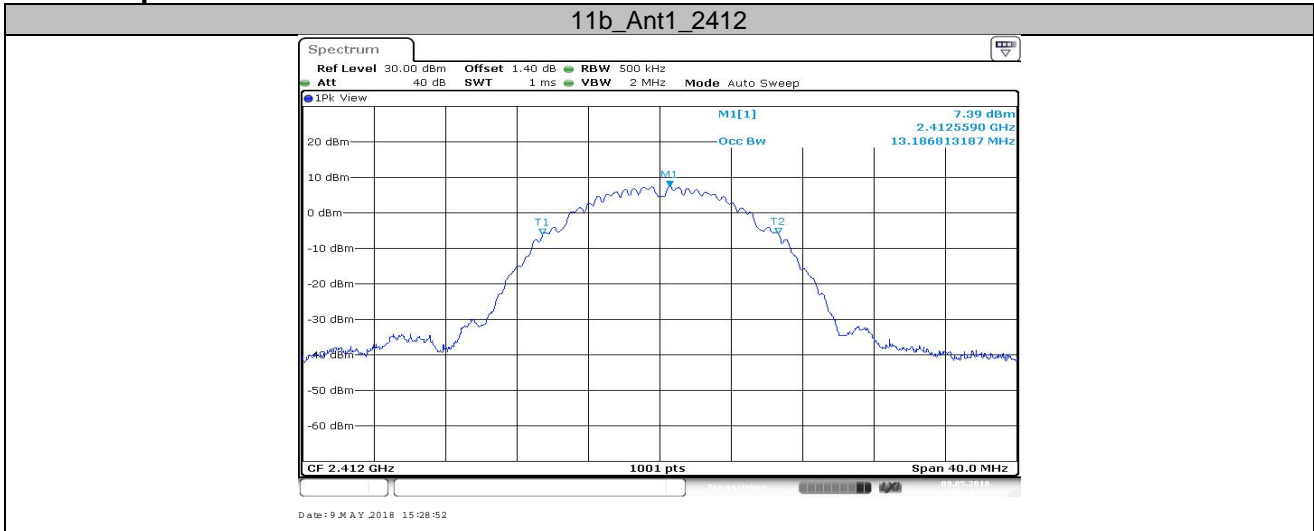

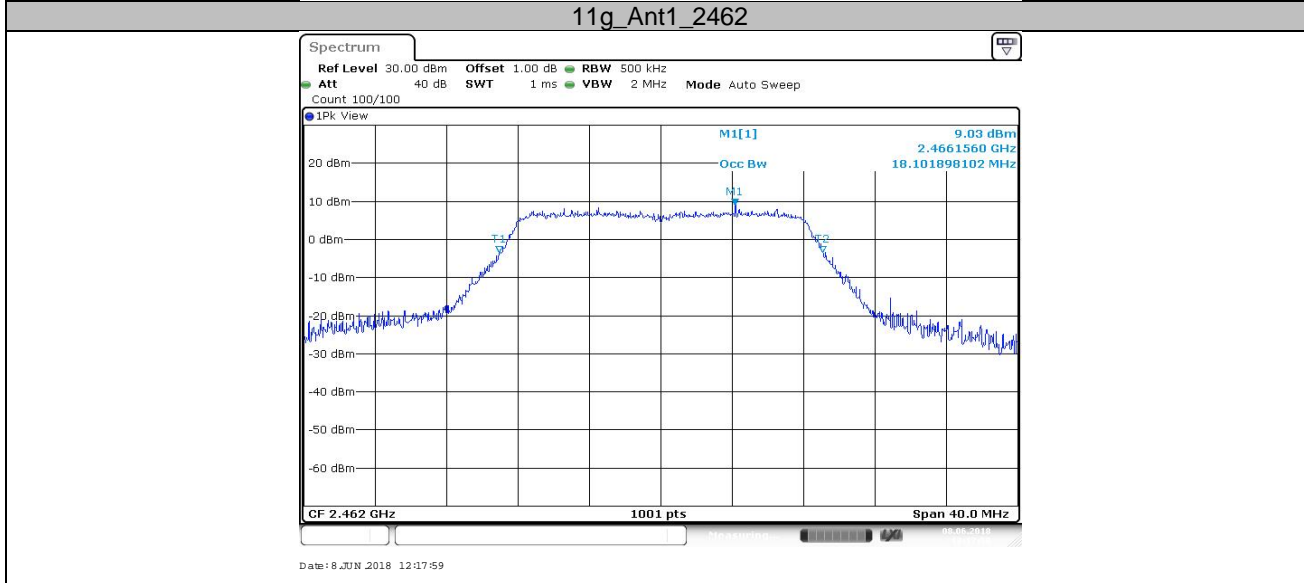
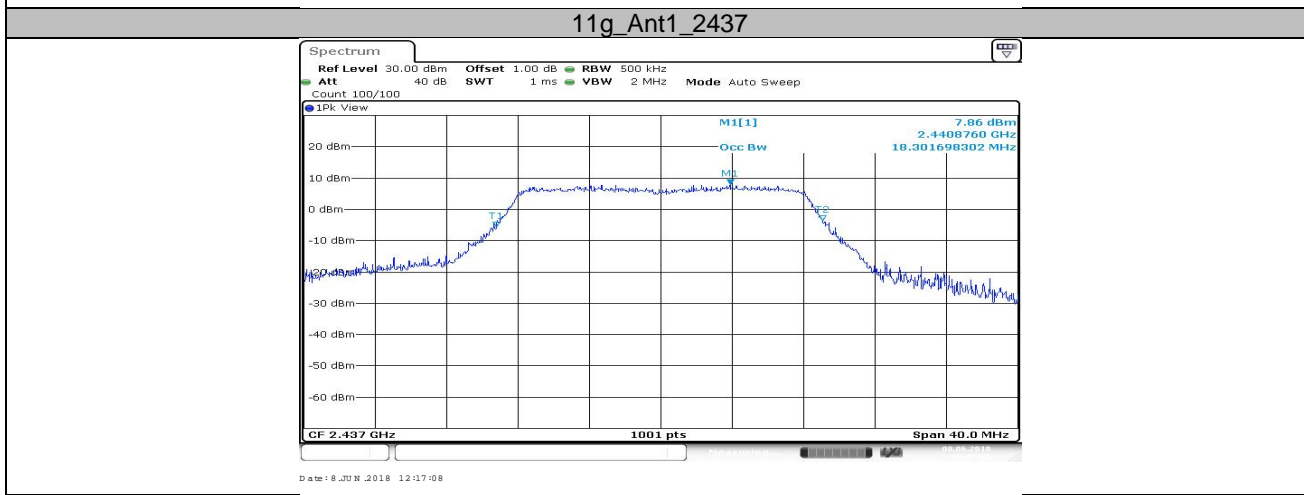

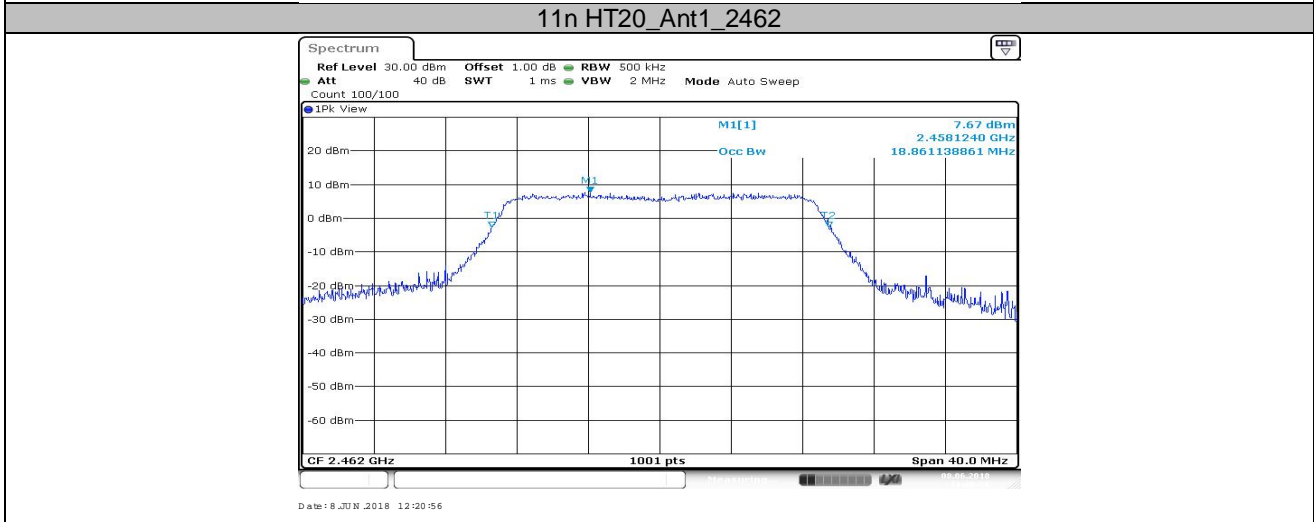
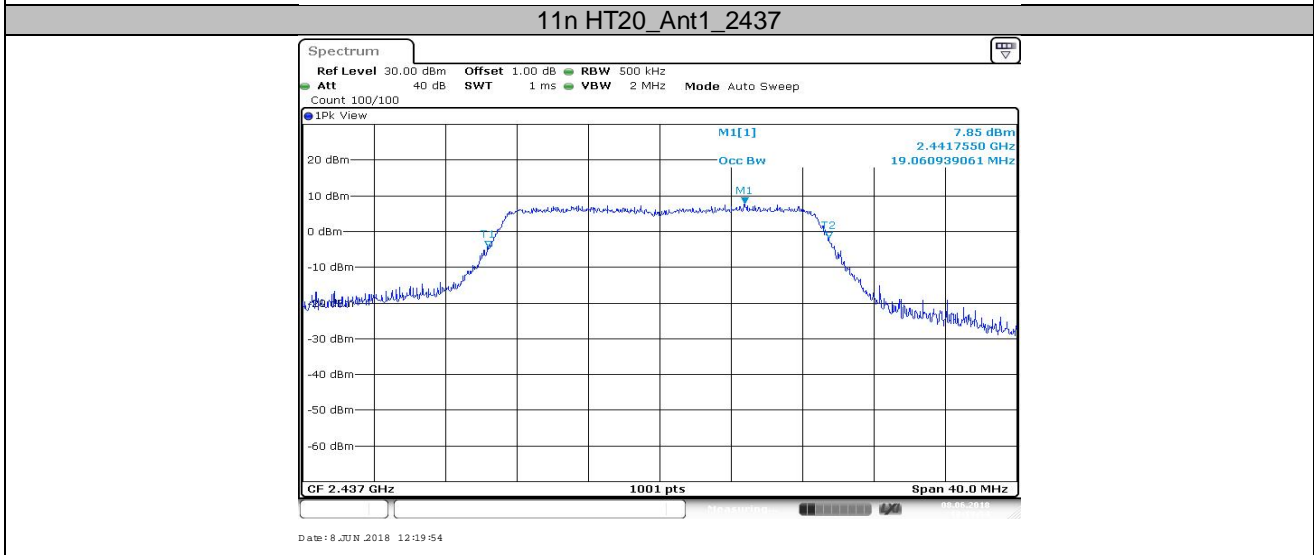
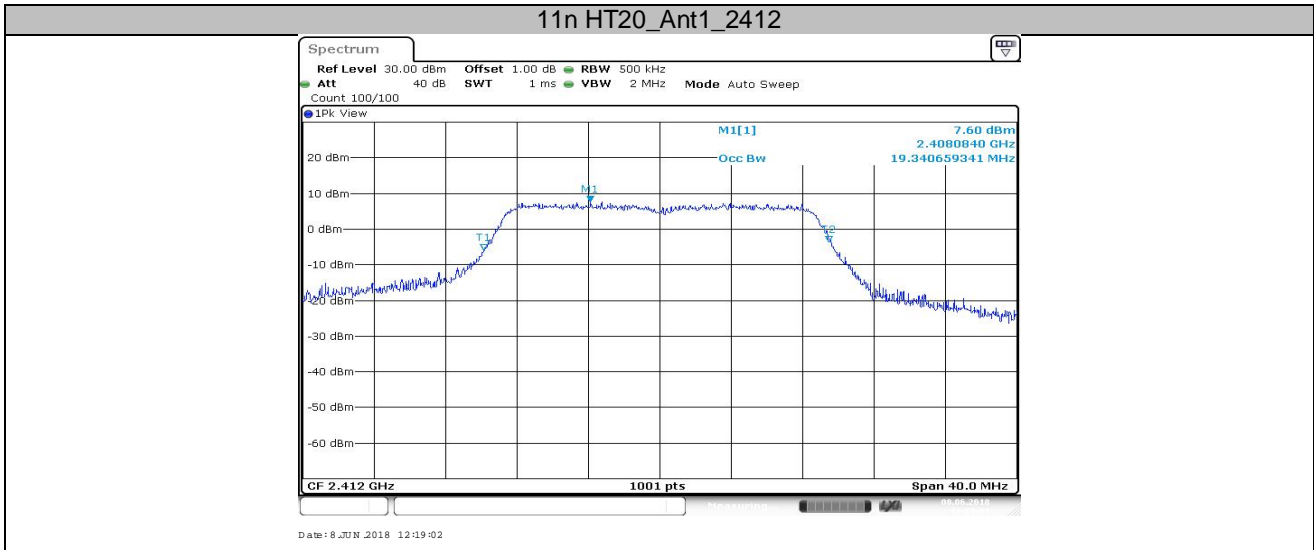

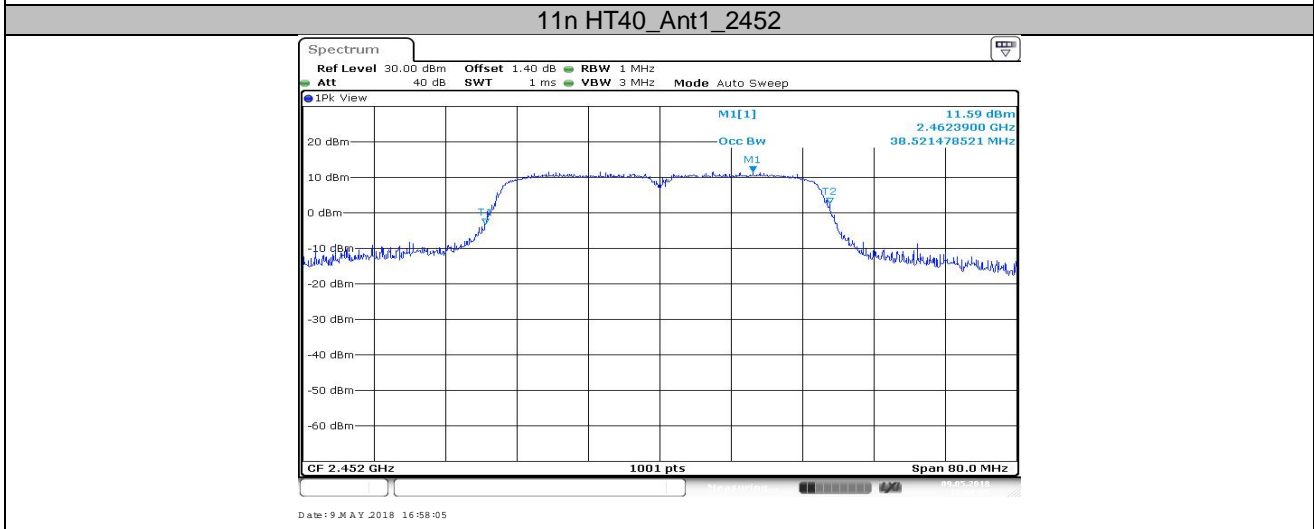
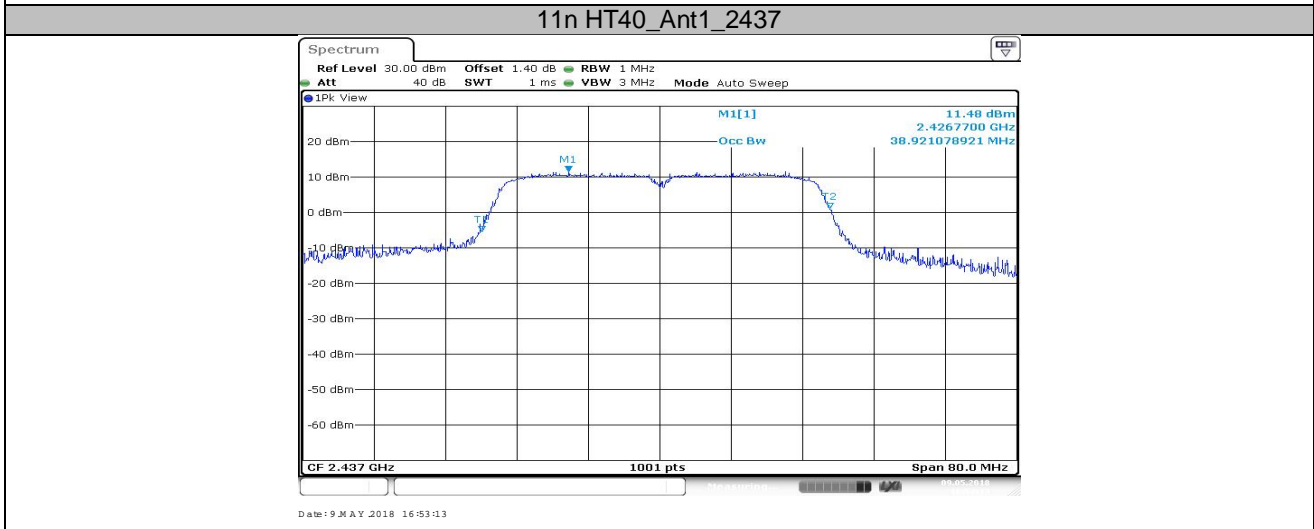
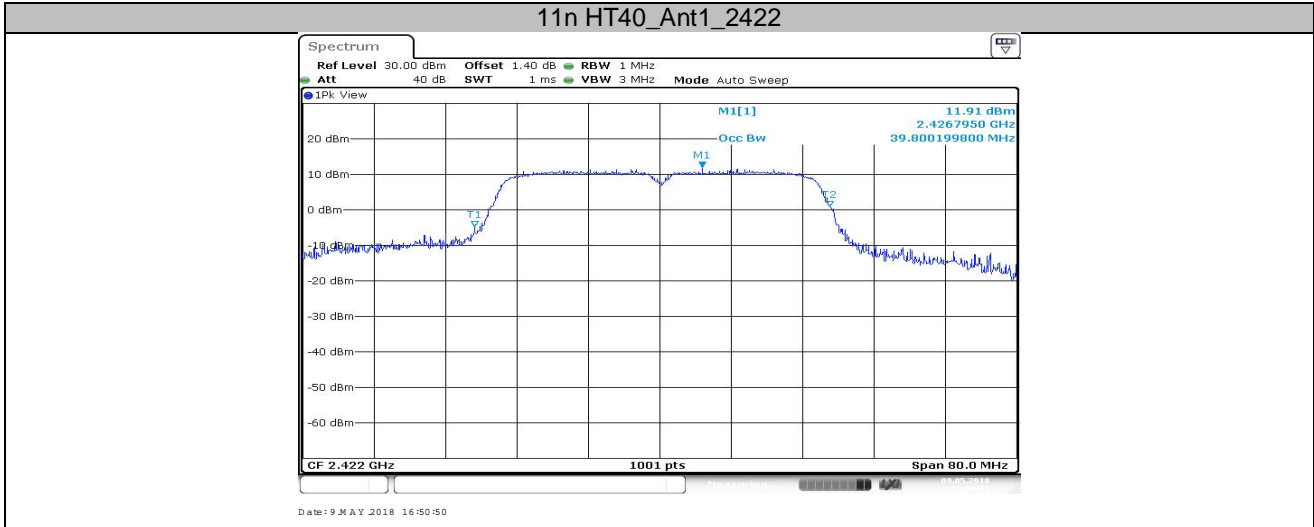



## 9.5 Power spectral density

### Test Method

This procedure shall be used if maximum peak conducted output power was used to demonstrate compliance:

1. Set analyzer center frequency to DTS channel center frequency. RBW=3kHz, VBW≥3RBW, Span=1.5 times DTS bandwidth, Detector=Peak, Sweep=auto, Trace= max hold.
2. Allow trace to fully stabilize, use the peak marker function to determine the maximum amplitude level within the RBW.
3. Repeat above procedures until other frequencies measured were completed.

### Limit

Limit [dBm]

≤8

### Test result

Test Mode	Channel (MHz)	Result (dBm)	Limit (dBm)	Verdict
11b	2412	0.37	8	PASS
11b	2437	0.90	8	PASS
11b	2462	1.33	8	PASS
11g	2412	-1.86	8	PASS
11g	2437	-1.95	8	PASS
11g	2462	-1.71	8	PASS
11n HT20	2412	-2.46	8	PASS
11n HT20	2437	-1.63	8	PASS
11n HT20	2462	-2.36	8	PASS
11n HT40	2422	-4.59	8	PASS
11n HT40	2437	-4.68	8	PASS
11n HT40	2452	-4.74	8	PASS



### Test Graphs

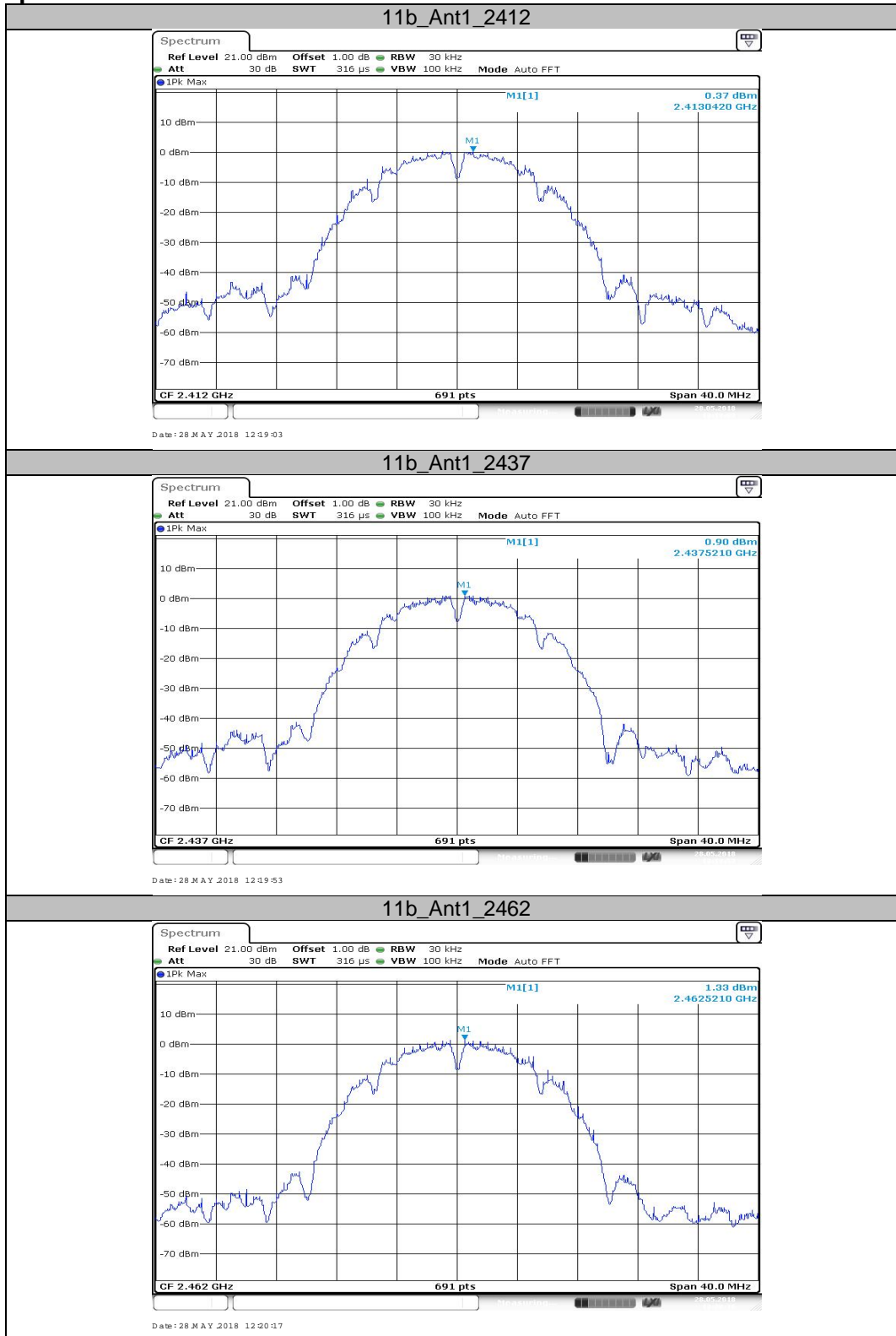

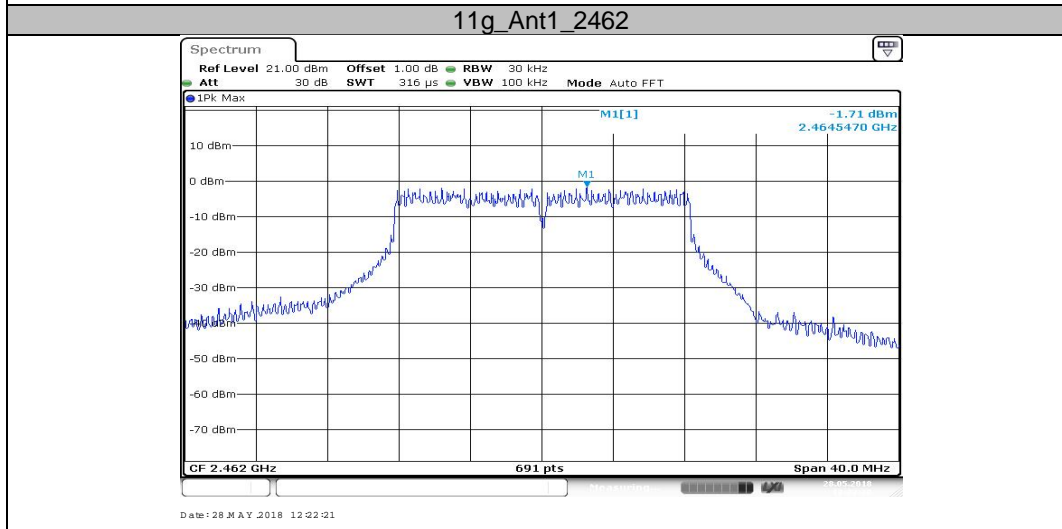
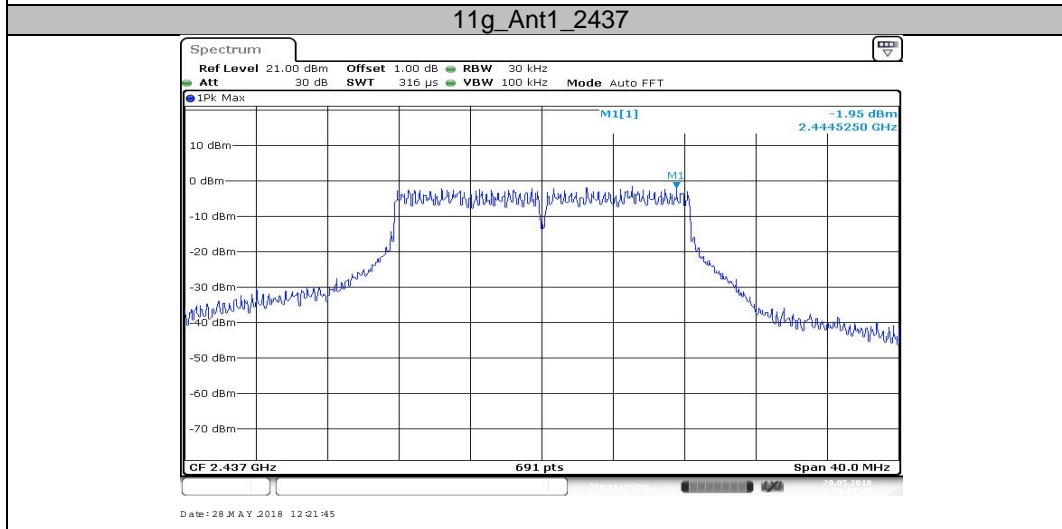
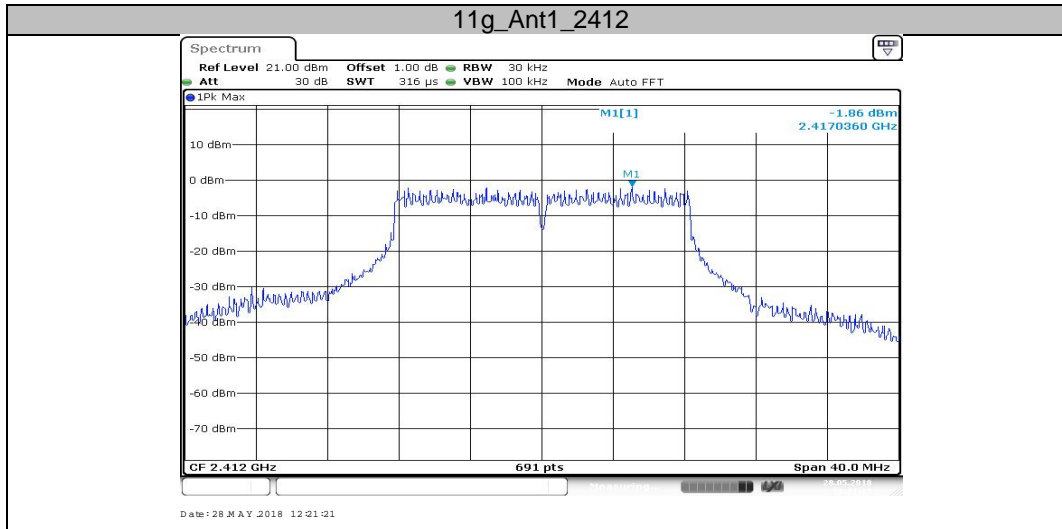

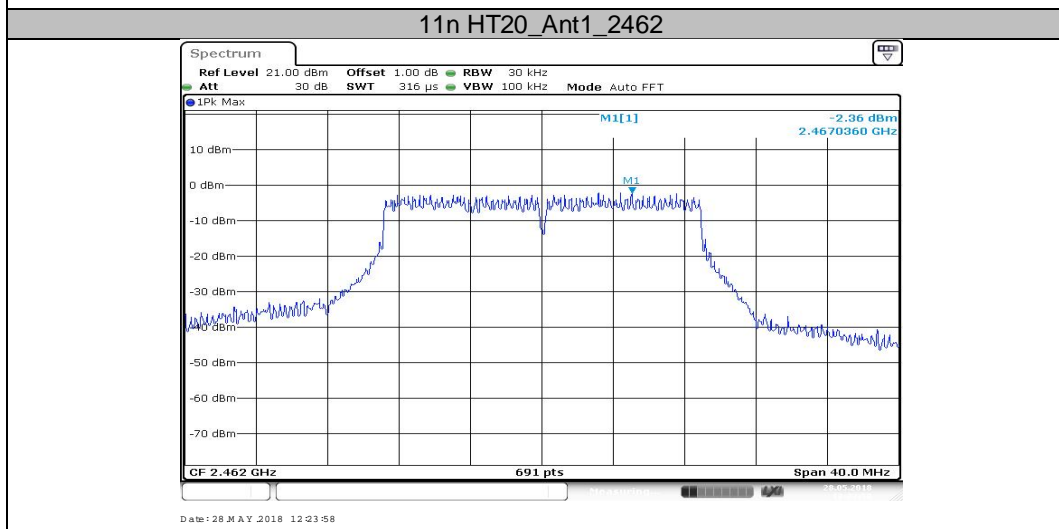
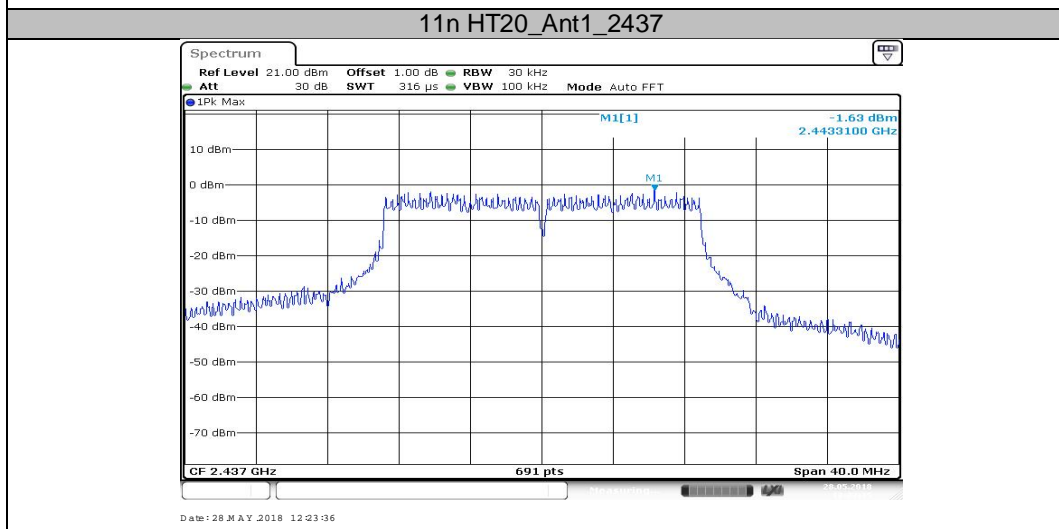
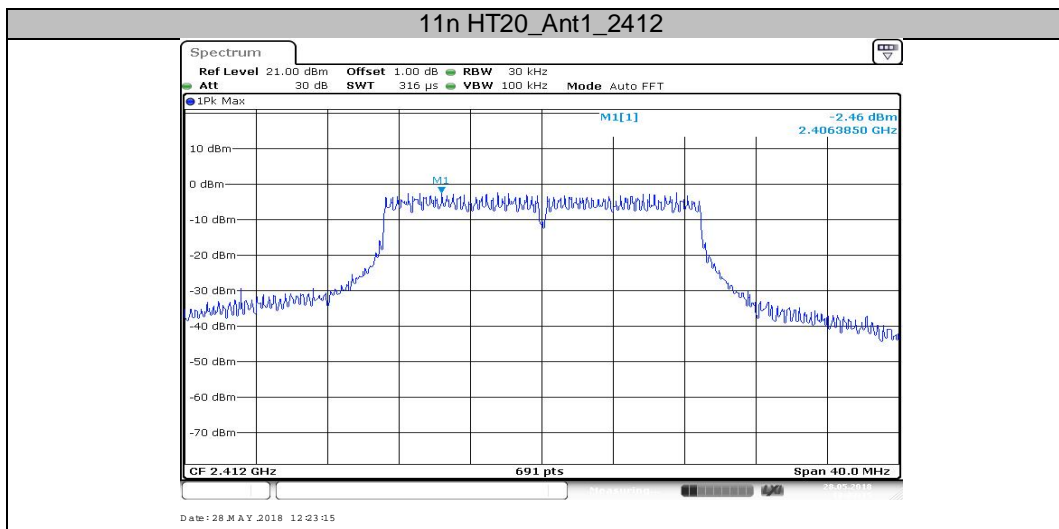

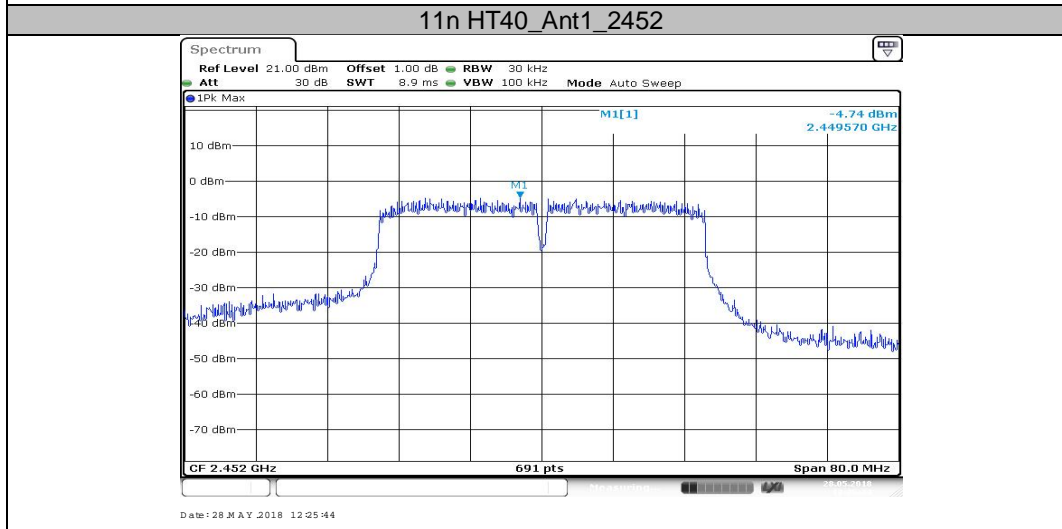
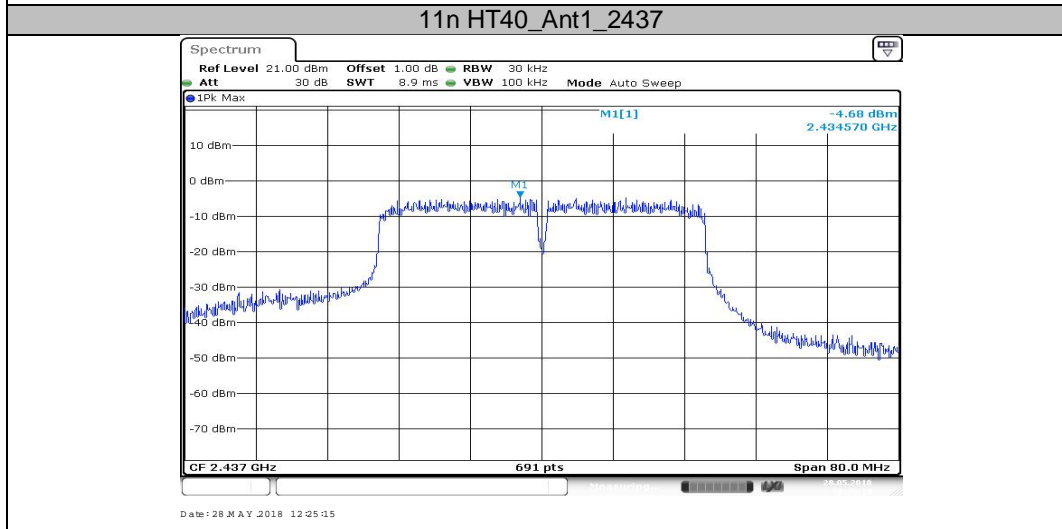
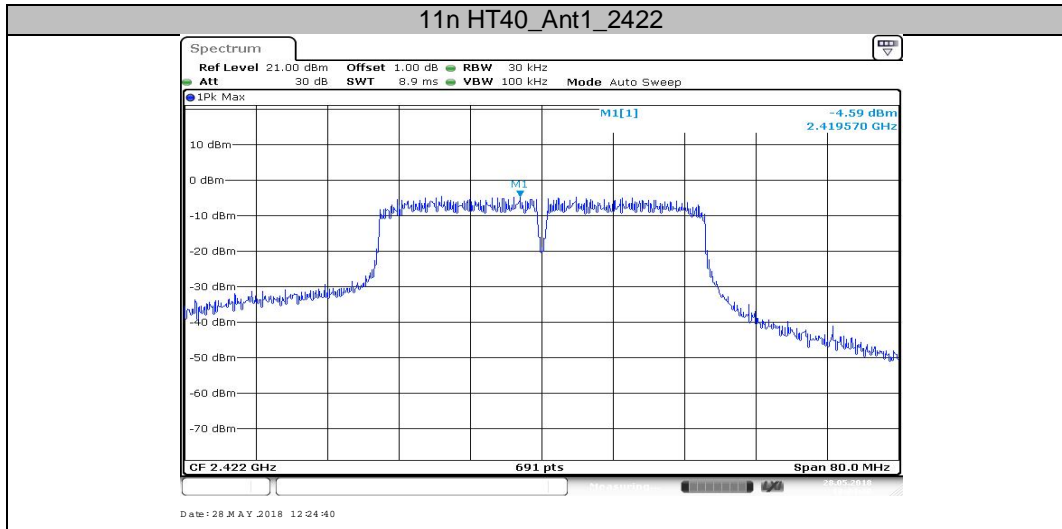

## 9.6 Spurious RF conducted emissions

### Test Method

1. Establish a reference level by using the following procedure:
  - a. Set RBW=100 kHz. VBW $\geq$ 3RBW. Detector =peak, Sweep time = auto couple, Trace mode = max hold.
  - b. Allow trace to fully stabilize, use the peak marker function to determine the maximum PSD level.
2. Use the maximum PSD level to establish the reference level.
  - a. Set the center frequency and span to encompass frequency range to be measured.
  - b. Use the peak marker function to determine the maximum amplitude level. Ensure that the amplitude of all unwanted emissions outside of the authorized frequency band (excluding restricted frequency bands) are attenuated by at least the minimum requirements, report the three highest emissions relative to the limit.
3. Repeat above procedures until other frequencies measured were completed.

### Limit

Frequency Range MHz	Limit (dBc)
30-25000	-20

### Test Result

Test Mode	Channel (MHz)	Freq Range (MHz)	Result (dBm)	Limit (dBm)	Verdict
11b	2412	30~1000	-68.6	-13.38	PASS
11b	2412	1000~26500	-42.49	-13.38	PASS
11b	2437	30~1000	-68.42	-13.23	PASS
11b	2437	1000~26500	-42.52	-13.23	PASS
11b	2462	30~1000	-68.55	-12.72	PASS
11b	2462	1000~26500	-42.77	-12.72	PASS
11g	2412	30~1000	-67.37	-14.15	PASS
11g	2412	1000~26500	-42.79	-14.15	PASS
11g	2437	30~1000	-68.62	-14.5	PASS
11g	2437	1000~26500	-42.63	-14.5	PASS
11g	2462	30~1000	-68.56	-14.26	PASS
11g	2462	1000~26500	-42.38	-14.26	PASS
11n HT20	2412	30~1000	-68.46	-14.44	PASS
11n HT20	2412	1000~26500	-42.97	-14.44	PASS
11n HT20	2437	30~1000	-68.27	-14.17	PASS
11n HT20	2437	1000~26500	-42.61	-14.17	PASS
11n HT20	2462	30~1000	-67.57	-14.16	PASS
11n HT20	2462	1000~26500	-42.87	-14.16	PASS
11n HT40	2422	30~1000	-67.82	-16.75	PASS
11n HT40	2422	1000~26500	-35.47	-16.75	PASS
11n HT40	2437	30~1000	-65.14	-16.91	PASS
11n HT40	2437	1000~26500	-38.89	-16.91	PASS
11n HT40	2452	30~1000	-66.27	-17.32	PASS
11n HT40	2452	1000~26500	-39.59	-17.32	PASS



### Test Graphs

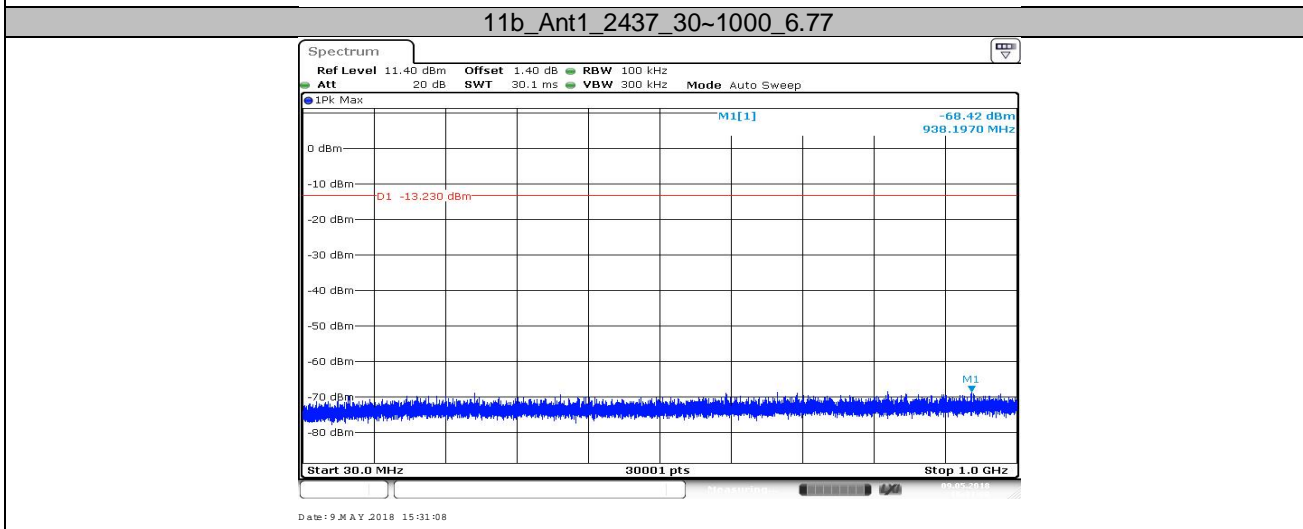
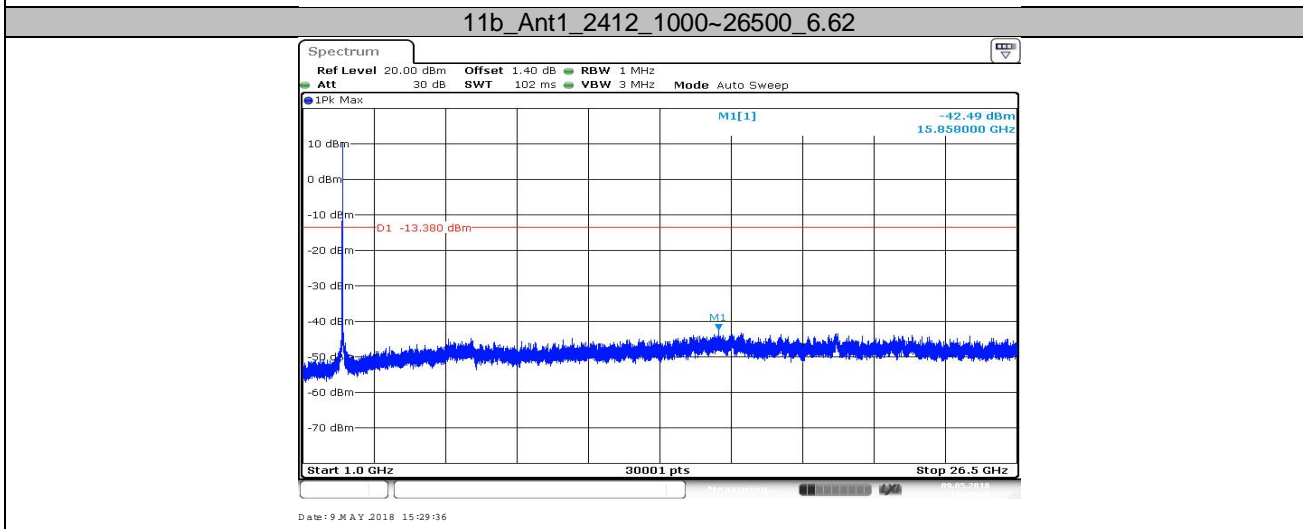
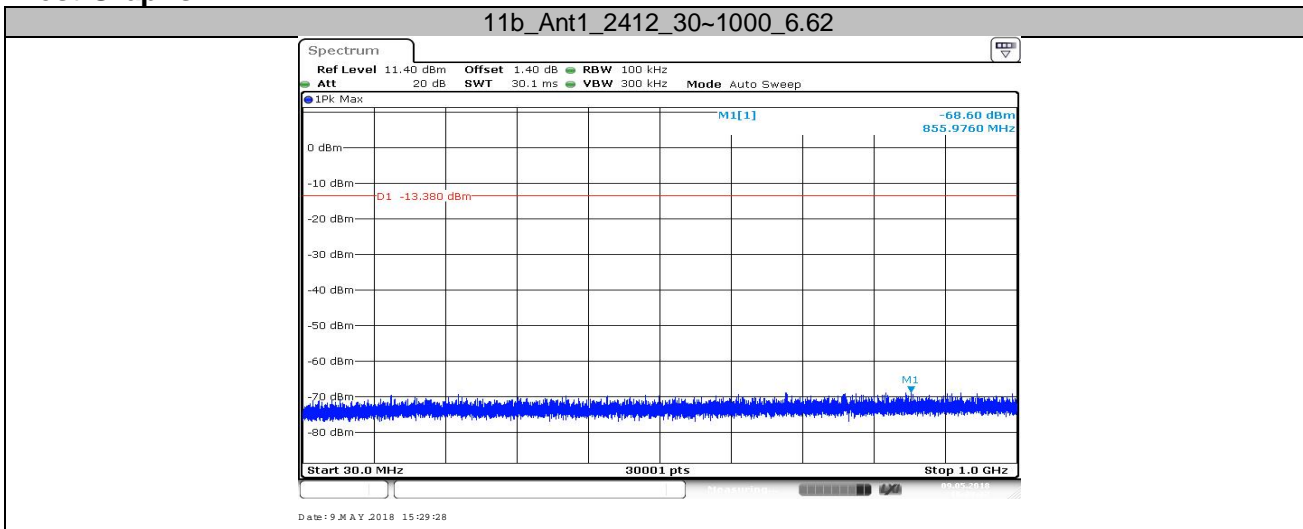

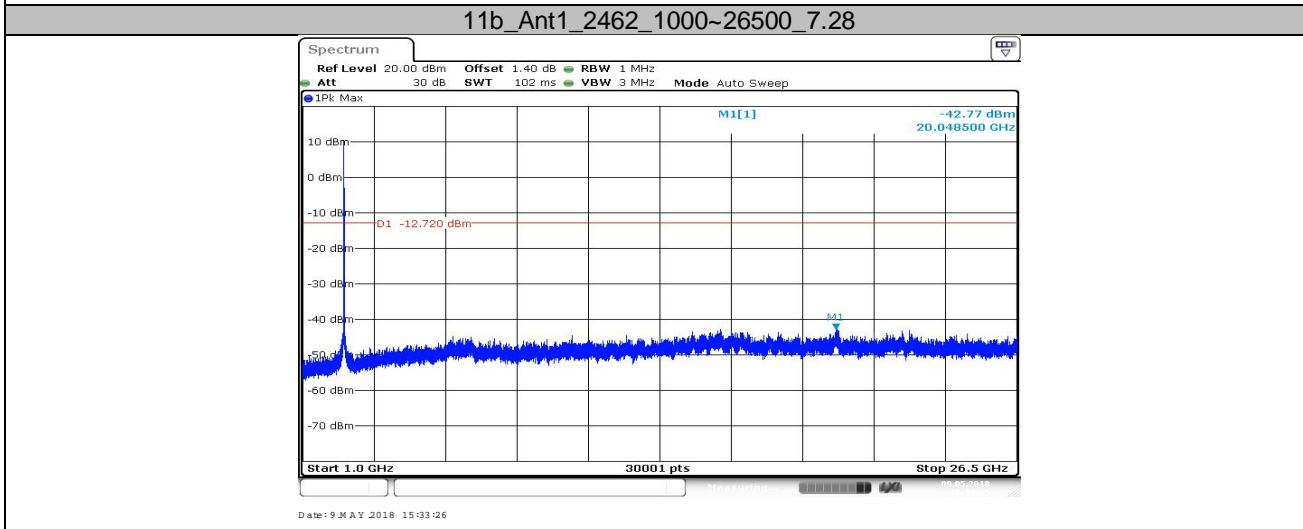
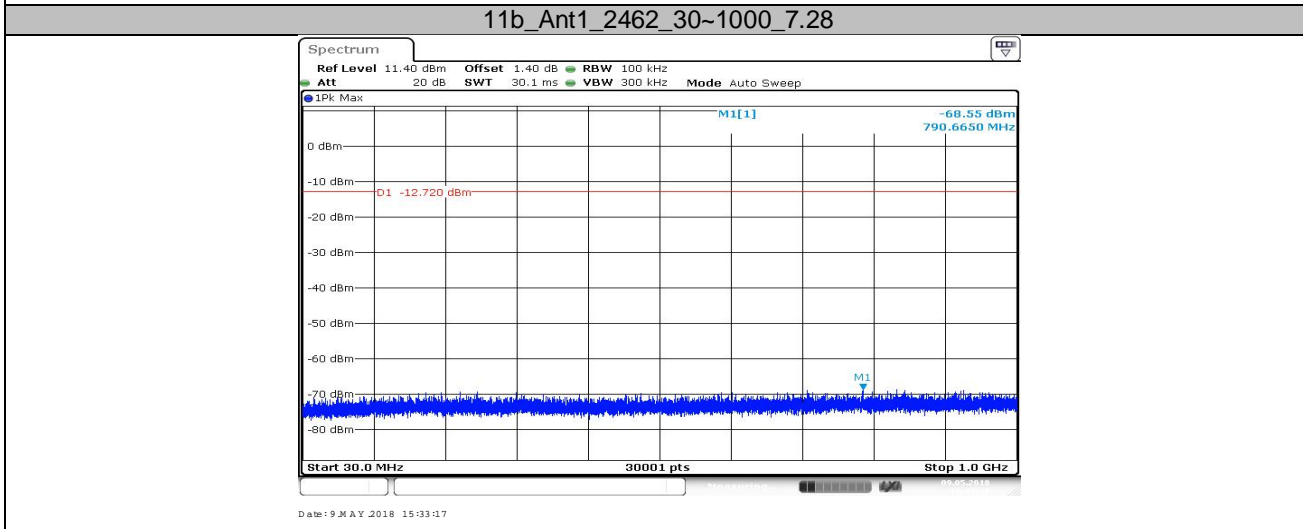
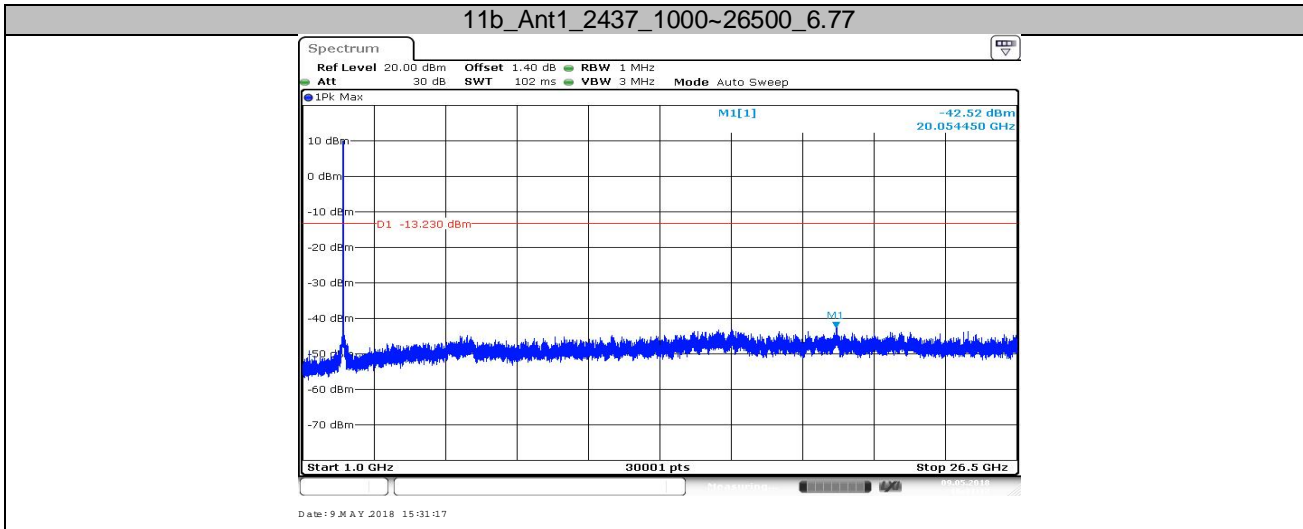

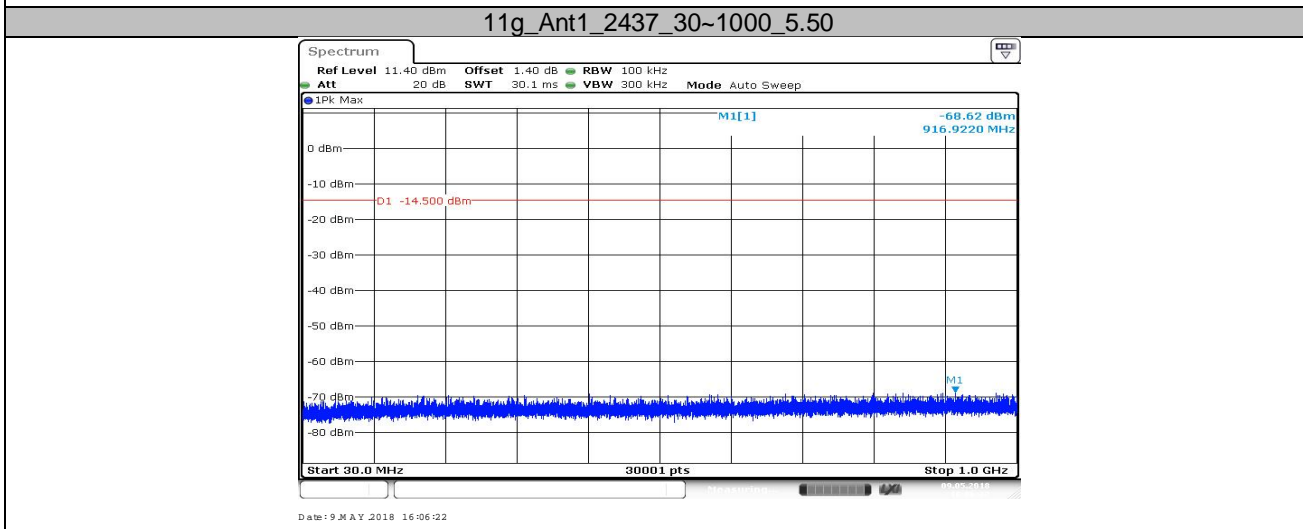
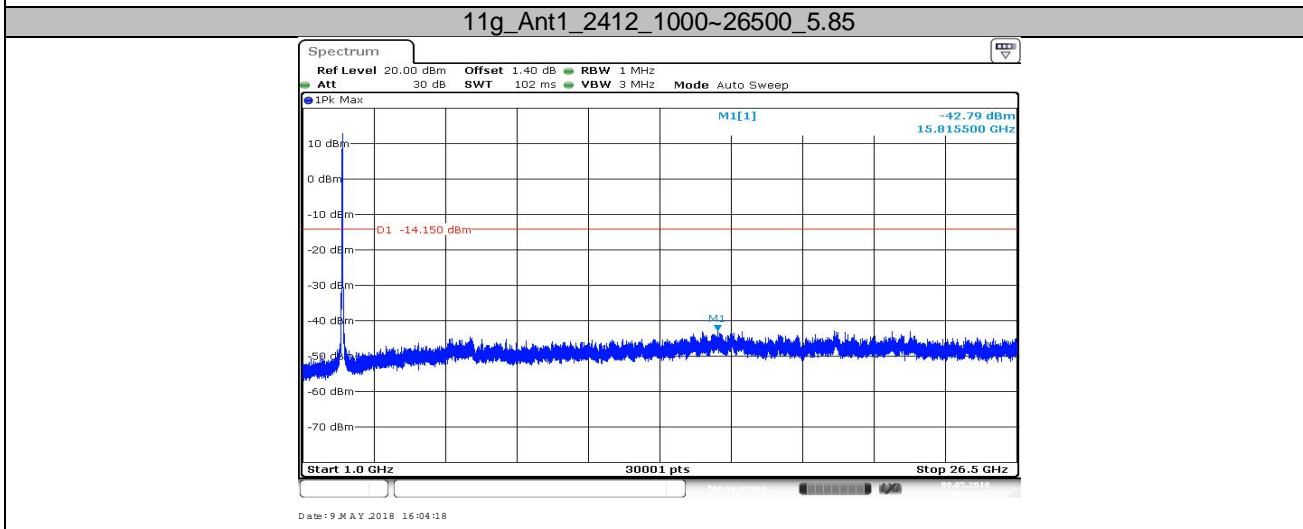
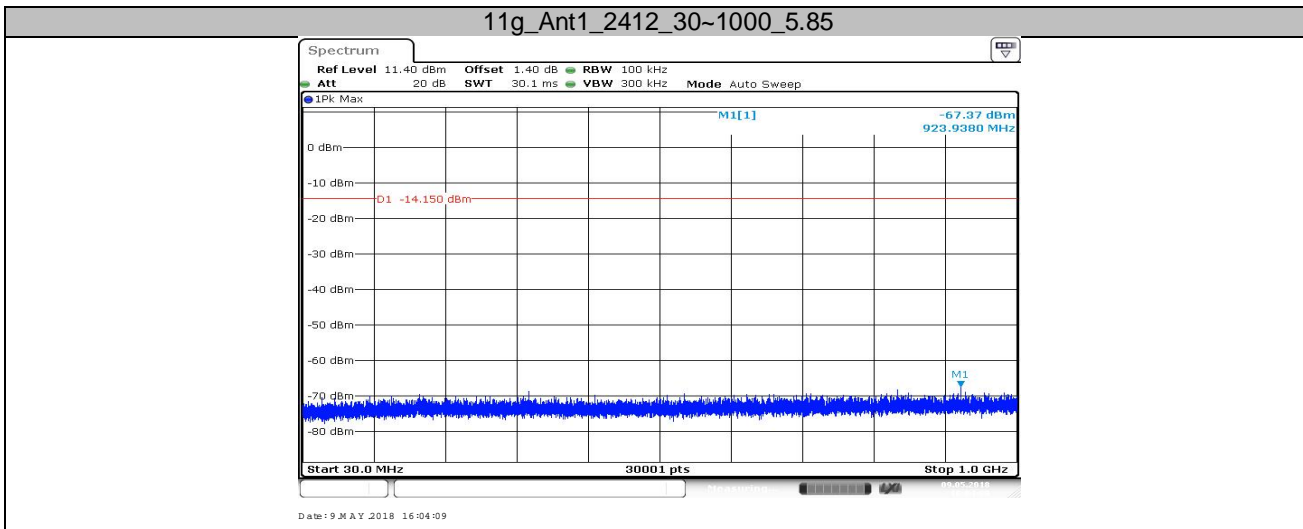



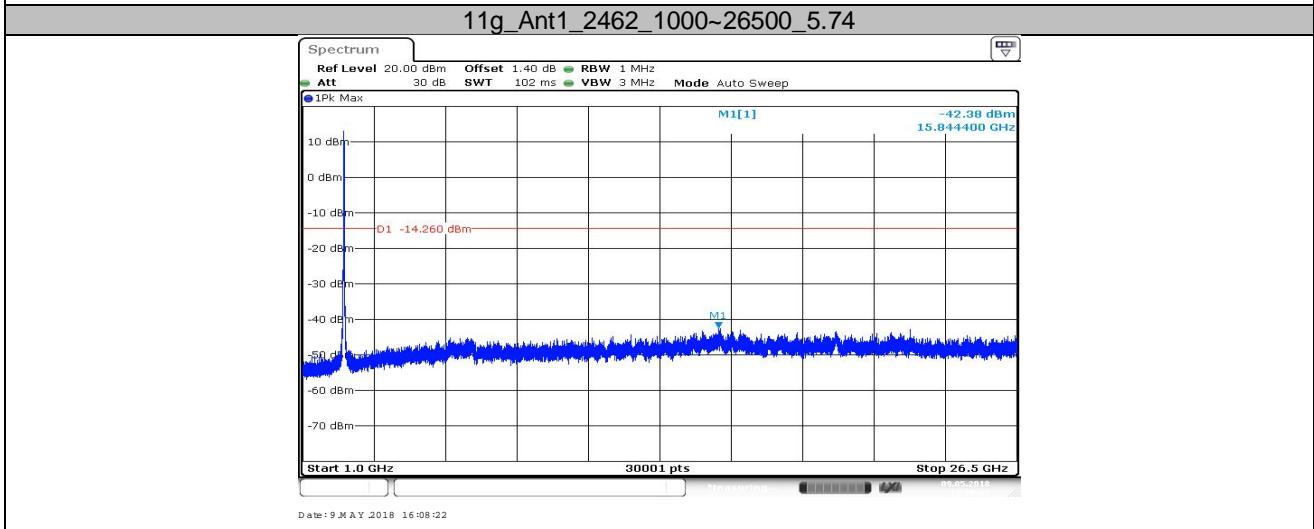
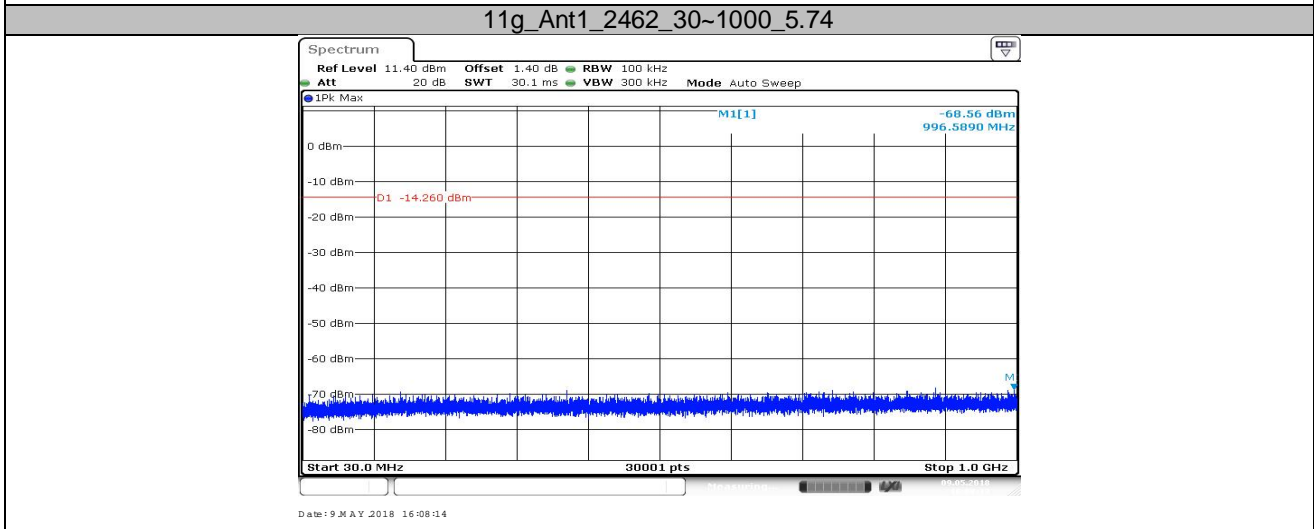
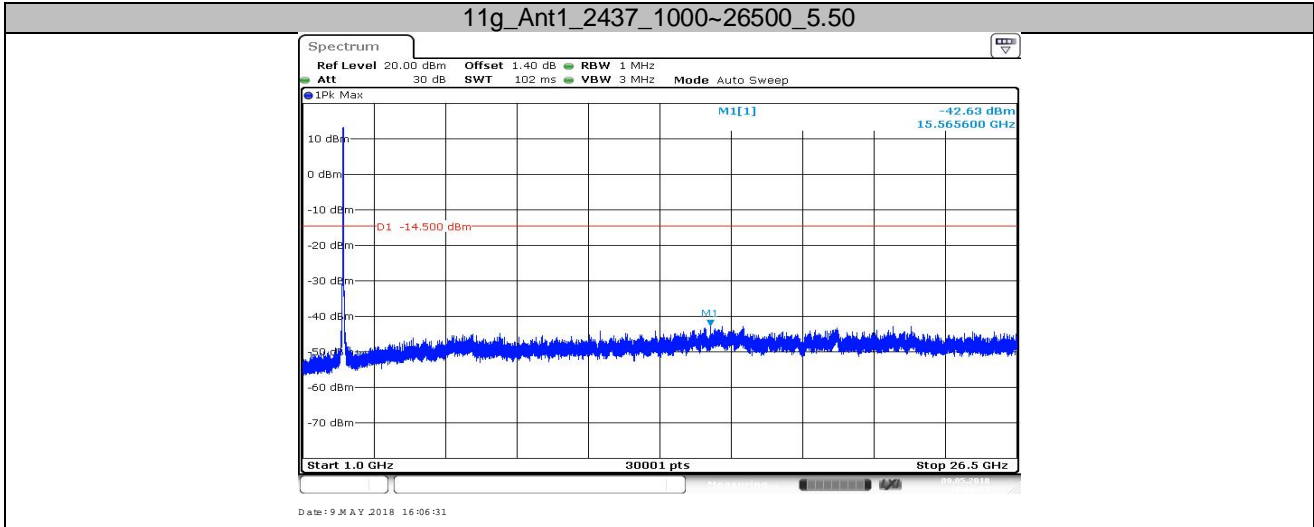

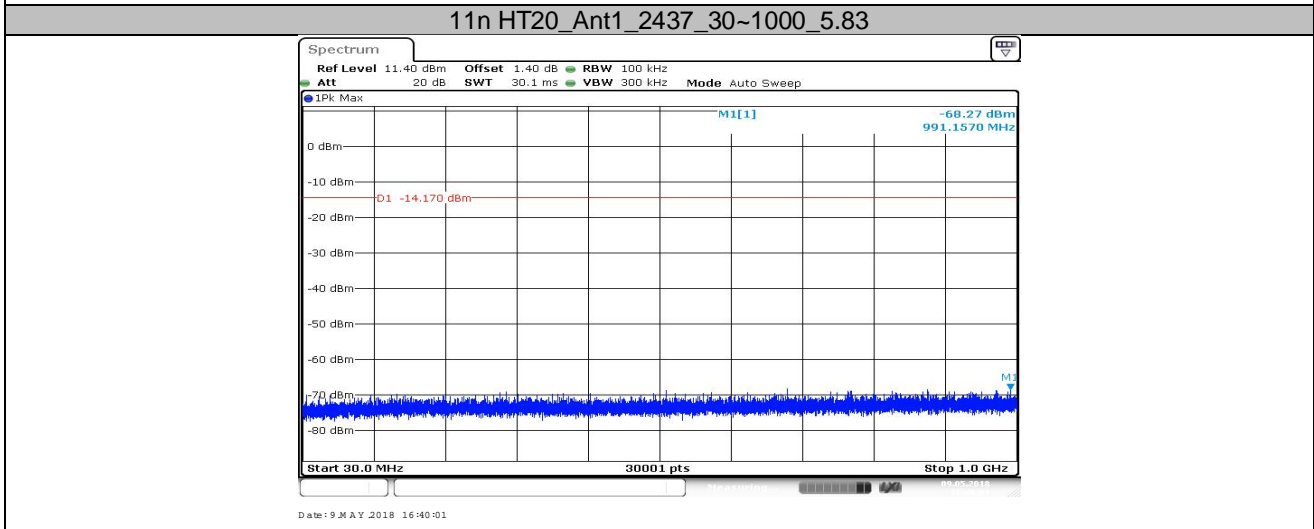
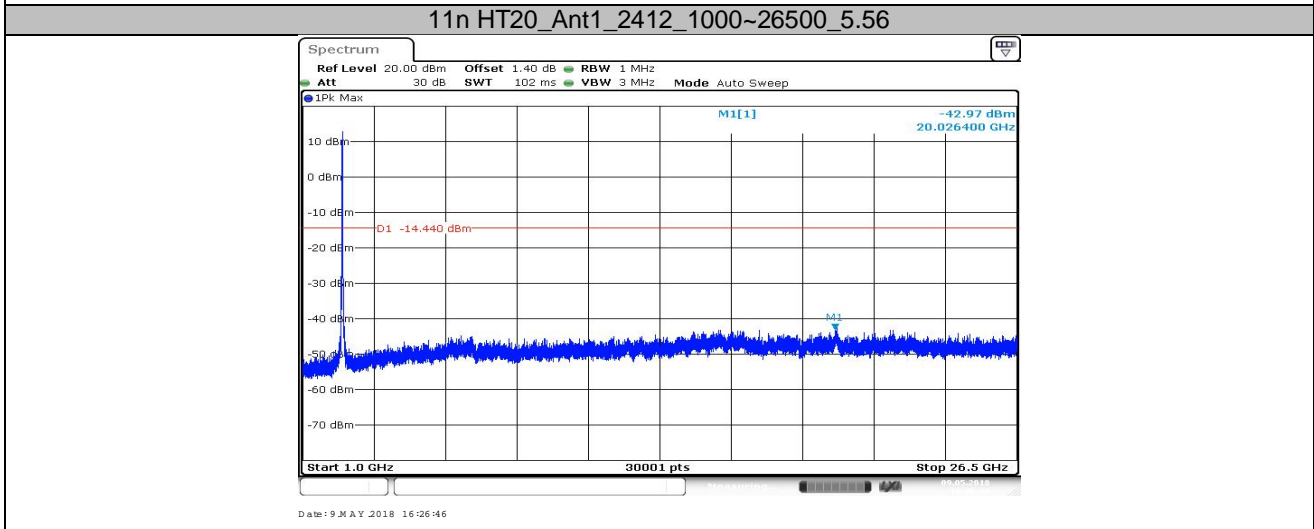
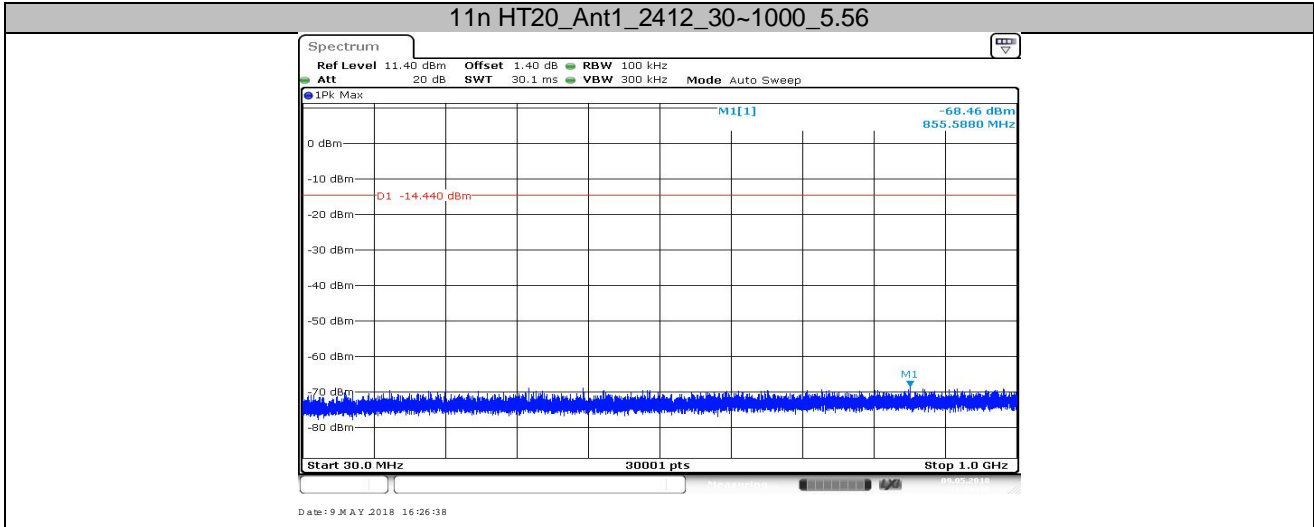

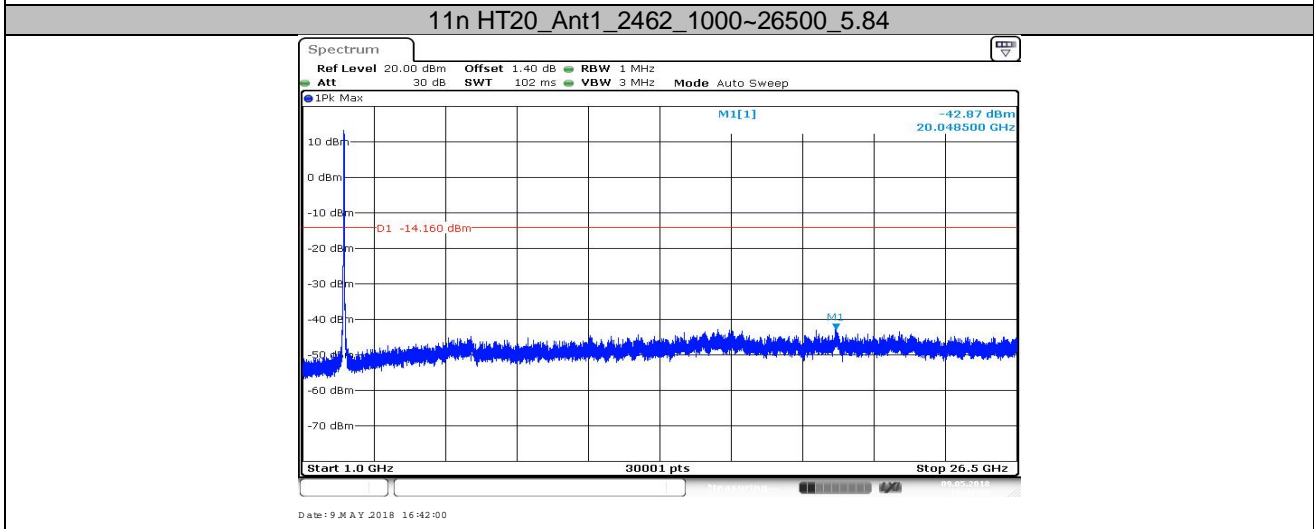
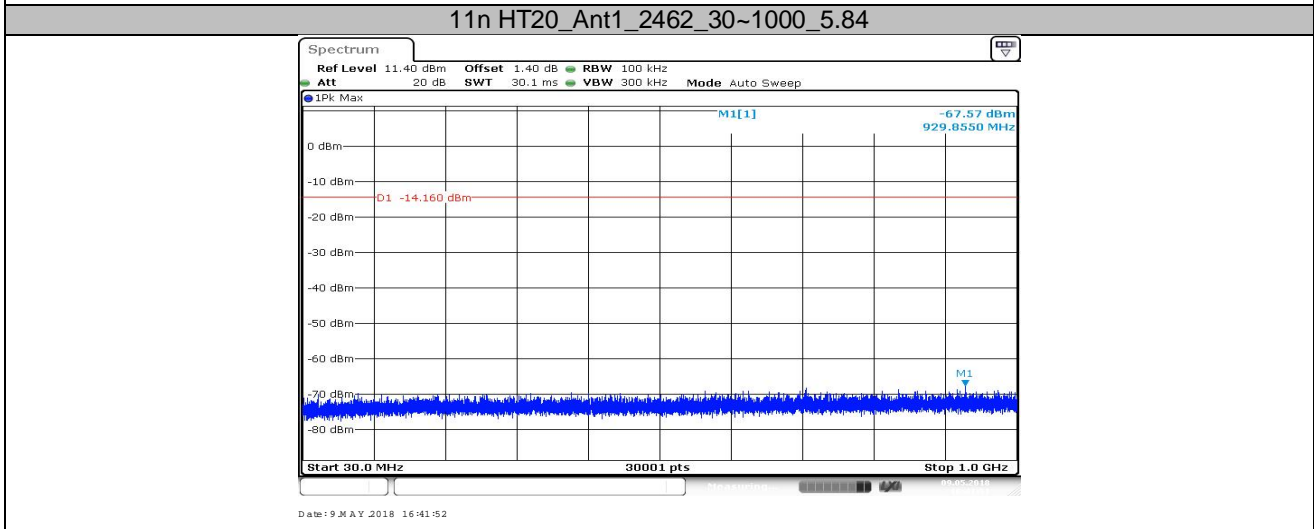
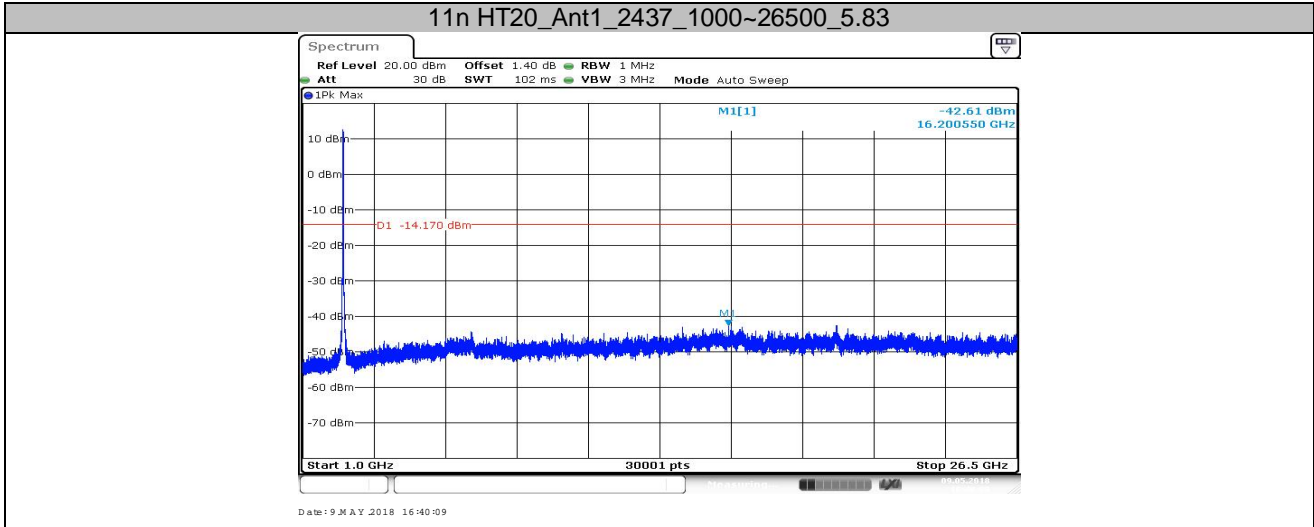

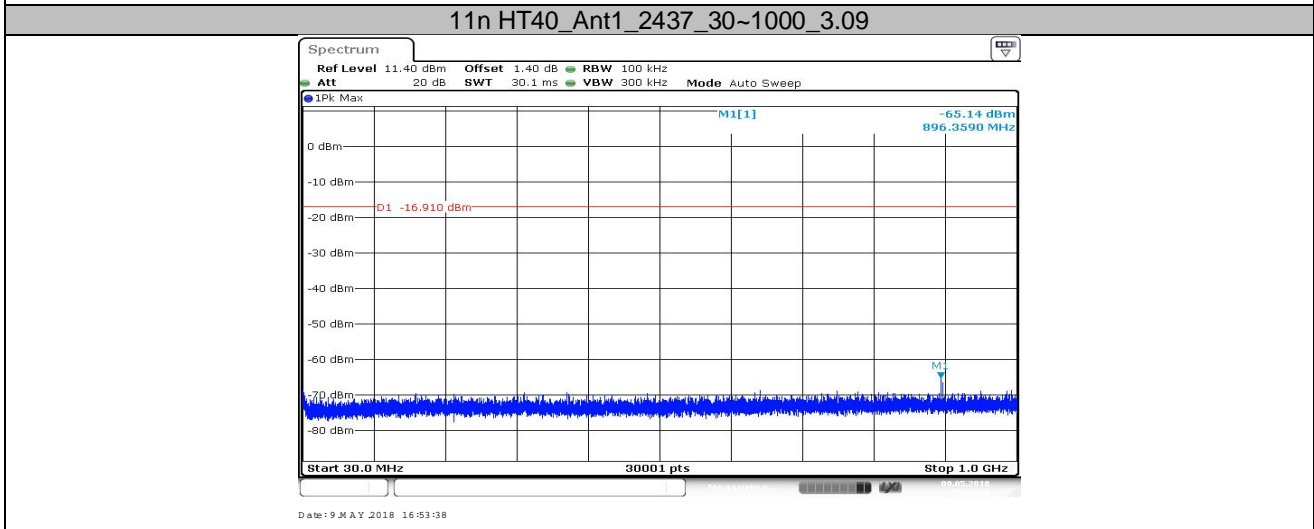
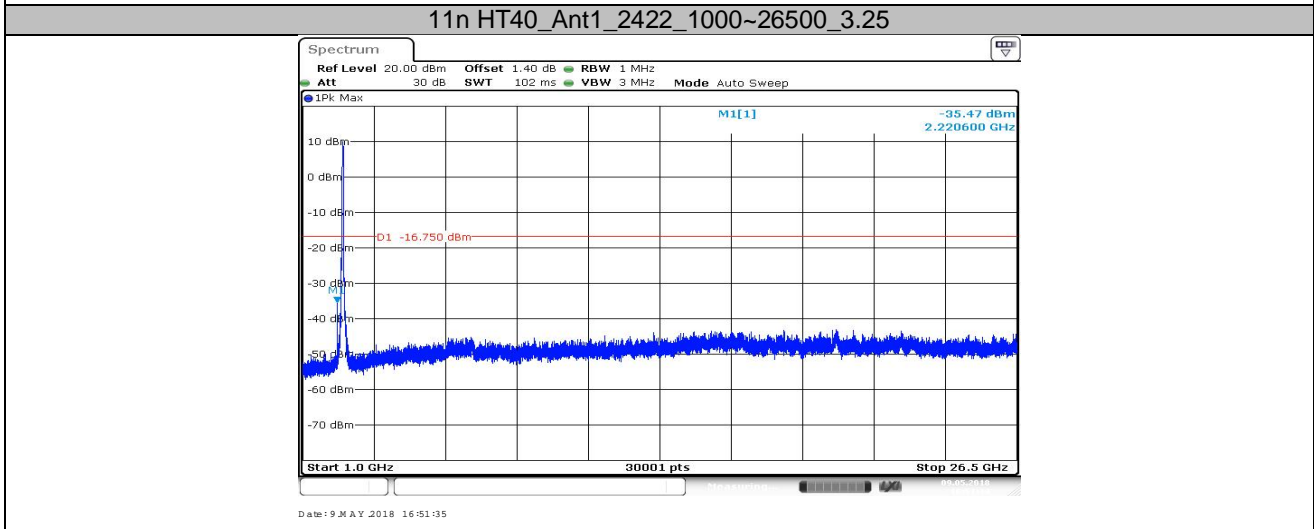
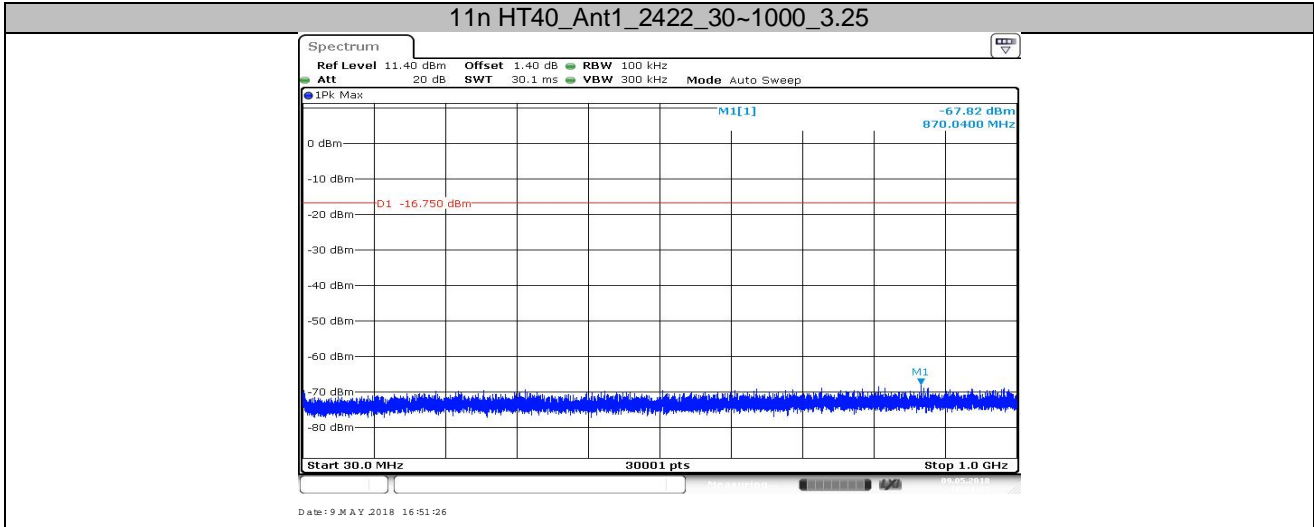

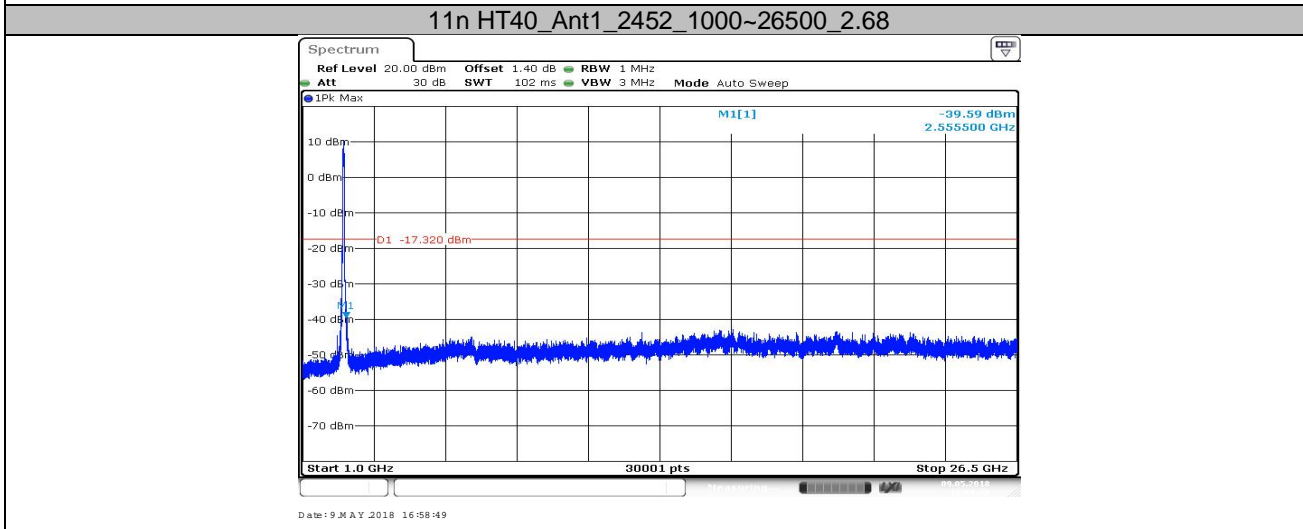
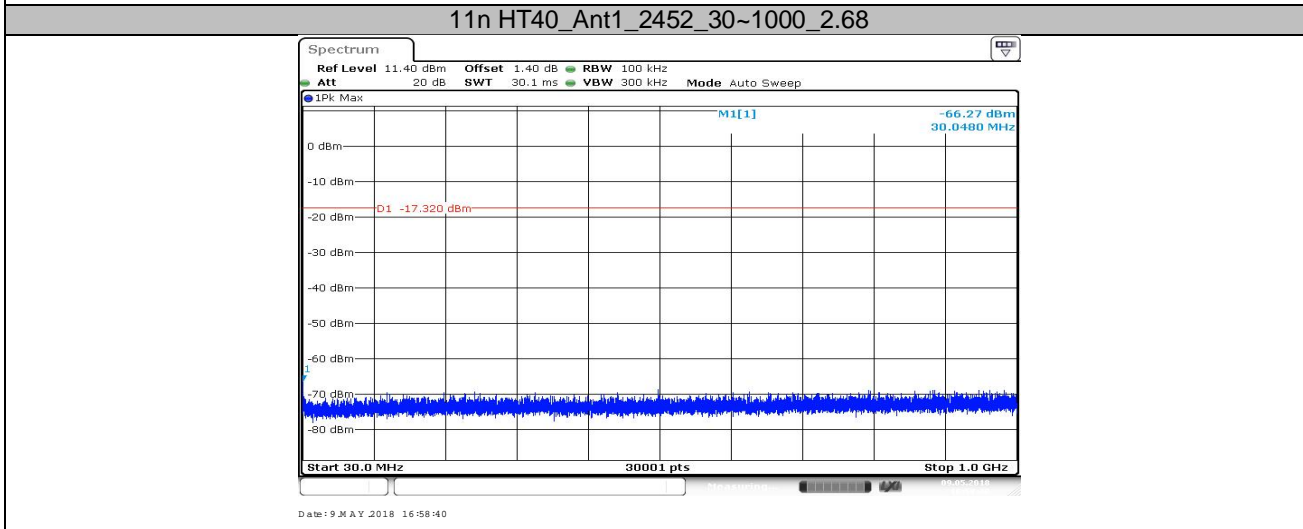
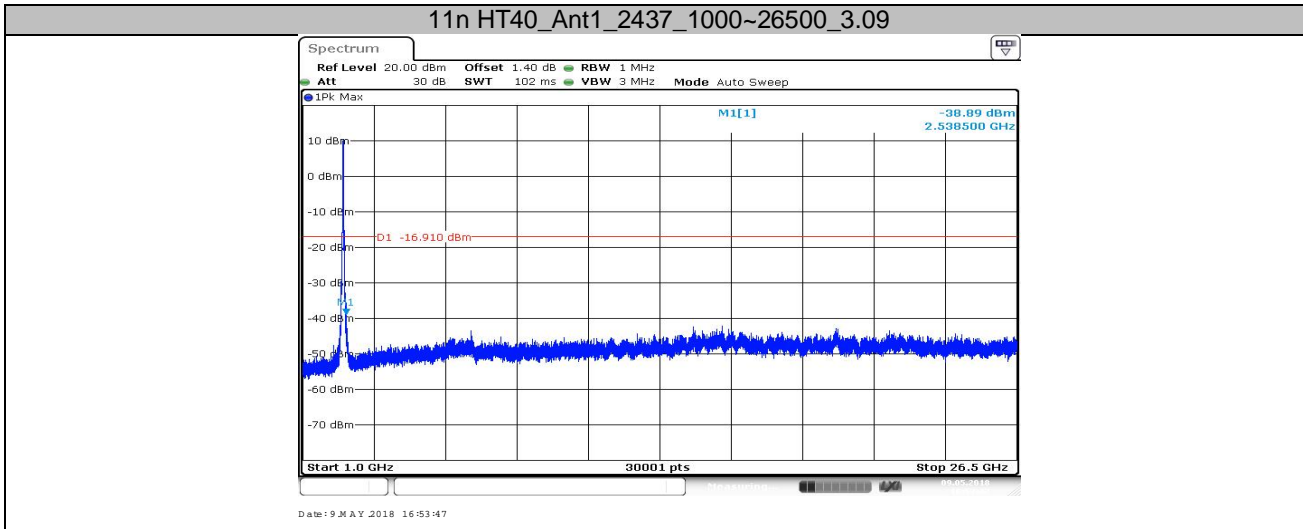



## 9.7 Band edge

### Test Method

- 1 Use the following spectrum analyzer settings:  
Span = wide enough to capture the peak level of the in-band emission and all spurious  
RBW = 100 kHz, VBW ≥ RBW, Sweep = auto, Detector function = peak, Trace = max hold.
- 2 Allow the trace to stabilize, use the peak and delta measurement to record the result.
- 3 The level displayed must comply with the limit specified in this Section.

### Limit

Frequency Range MHz	Limit (dBc)
30-25000	-20

### Test result

Test Mode	Ch Name	Channel	Result	Limit	Verdict
11b	Low	2412	-38.81	-13.31	PASS
11b	High	2462	-51.72	-13.75	PASS
11g	Low	2412	-17.72	-14.19	PASS
11g	High	2462	-32.66	-14.08	PASS
11n HT20	Low	2412	-17.85	-14.16	PASS
11n HT20	High	2462	-29.17	-14.05	PASS
11n HT40	Low	2422	-23.90	-19.59	PASS
11n HT40	High	2452	-36.47	-19.46	PASS

Test Graphs

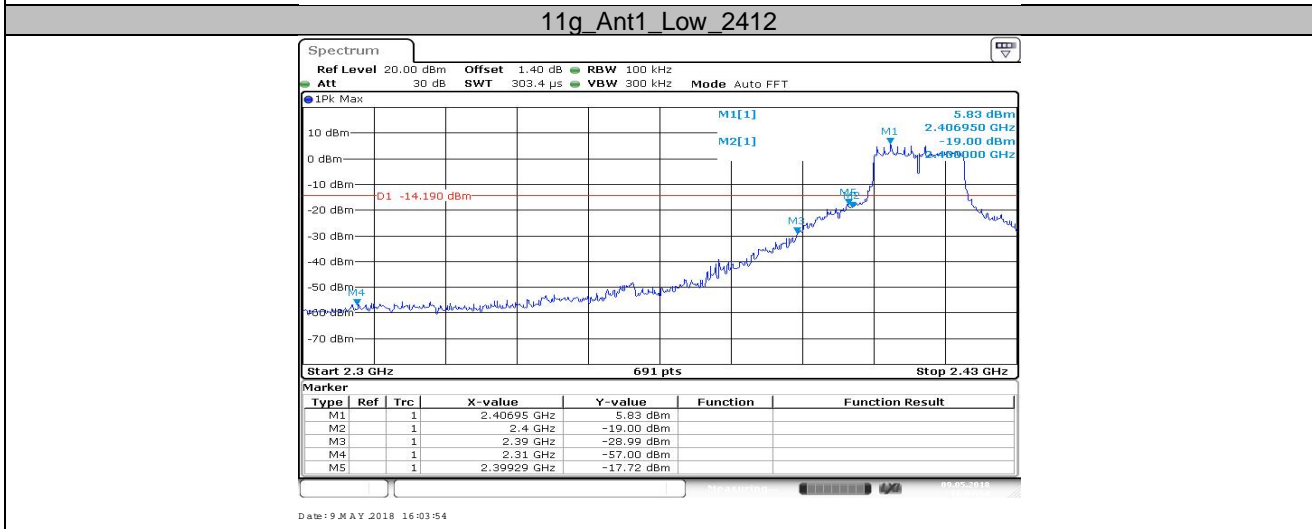
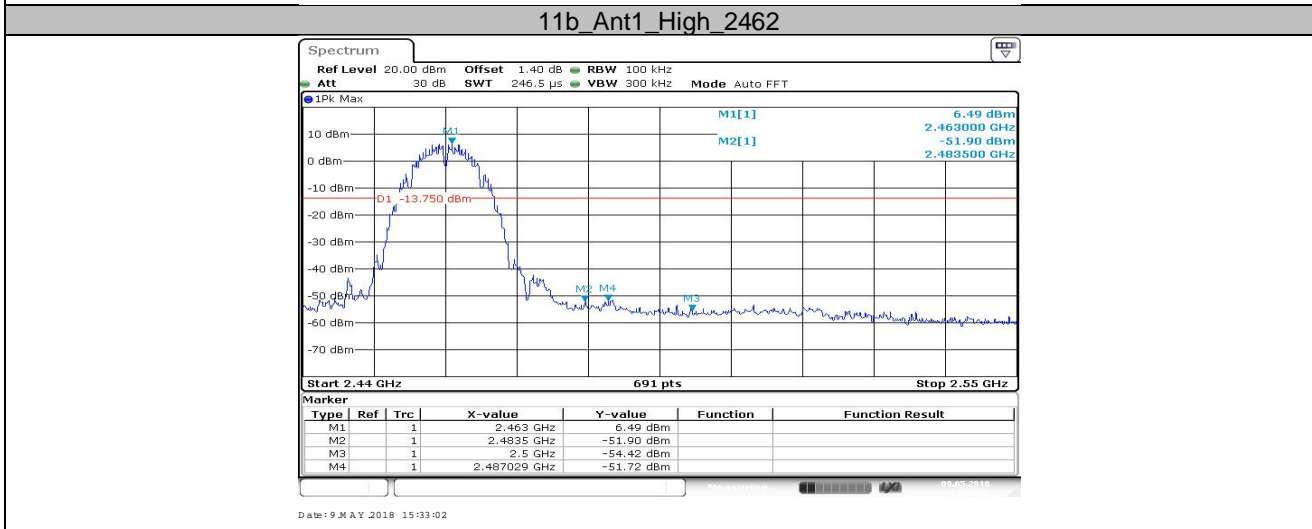
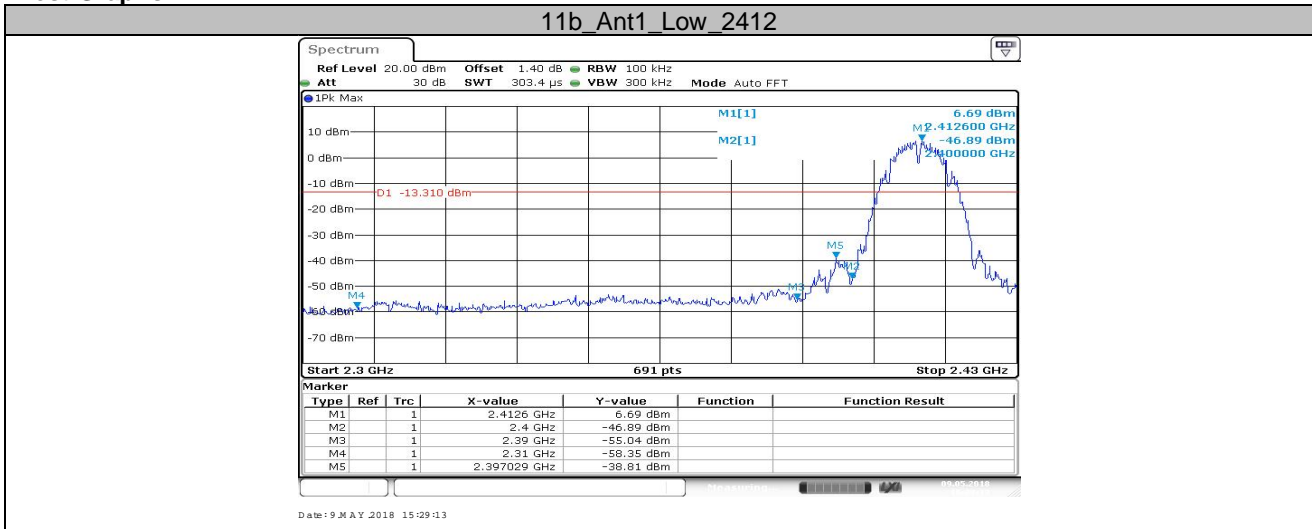

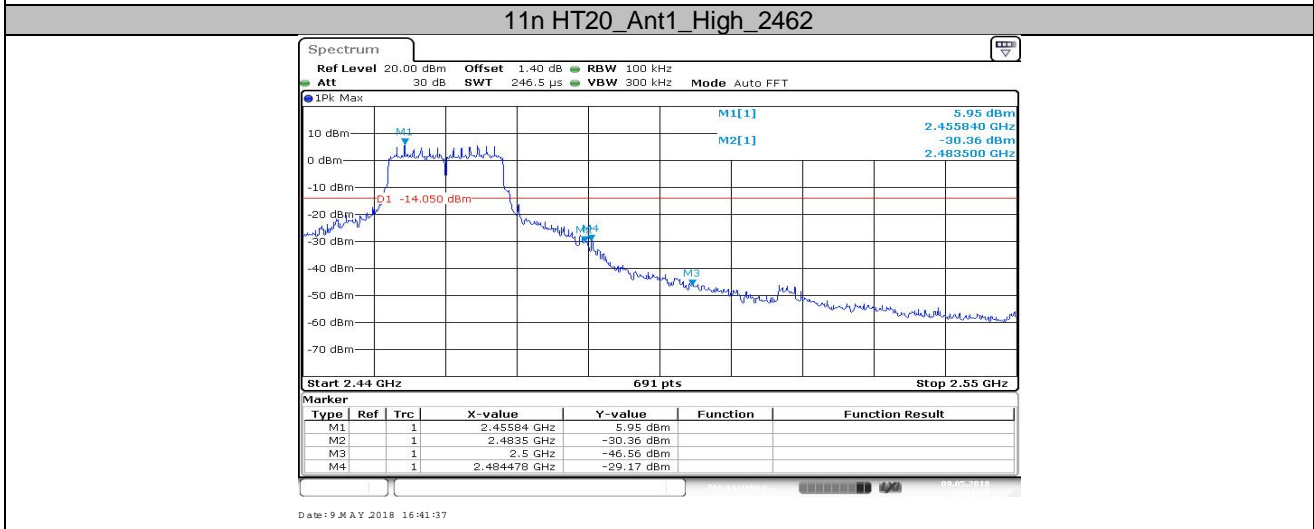
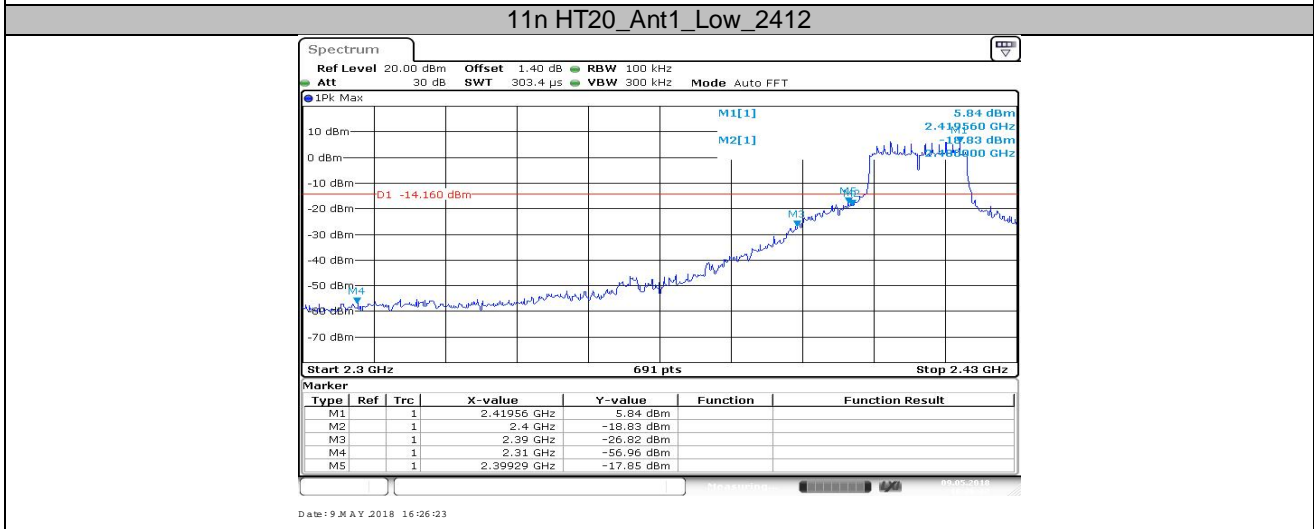
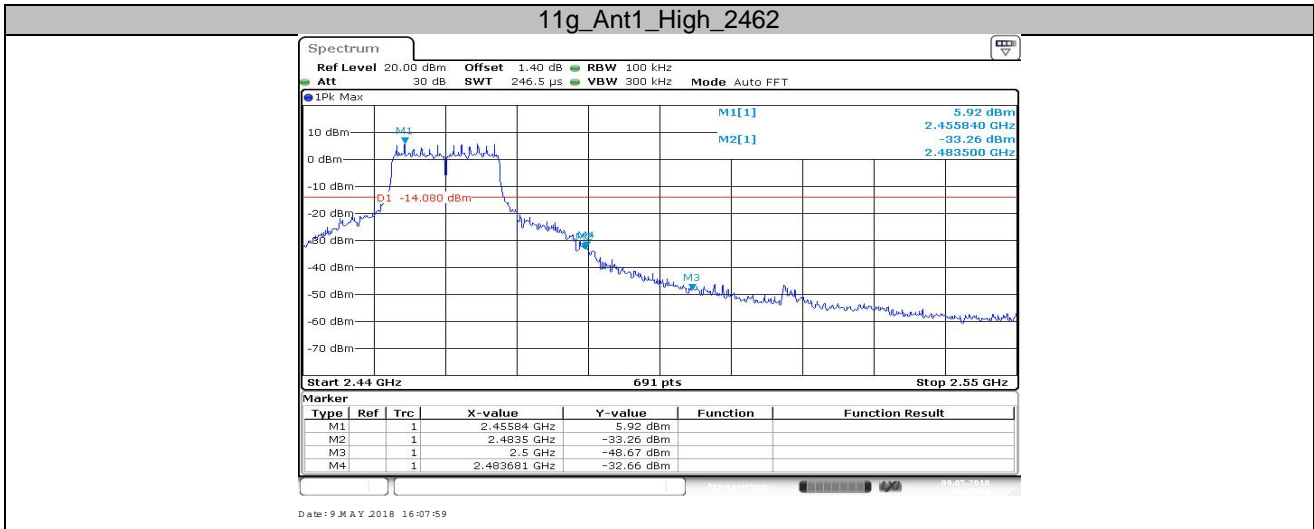



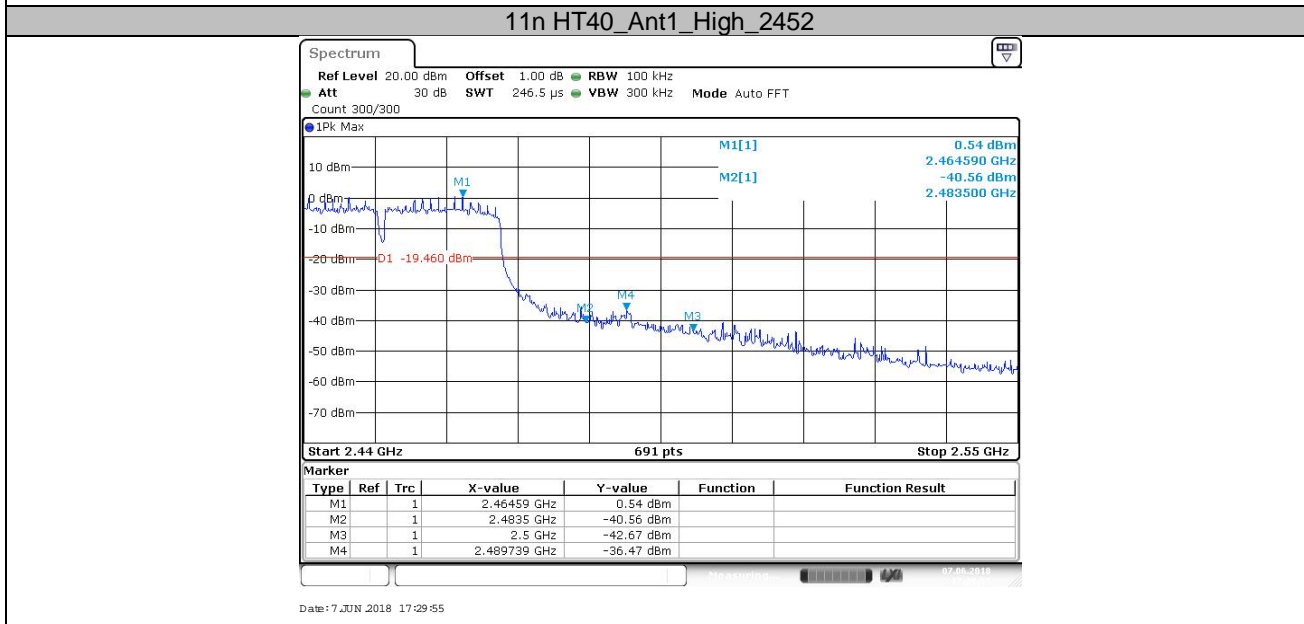
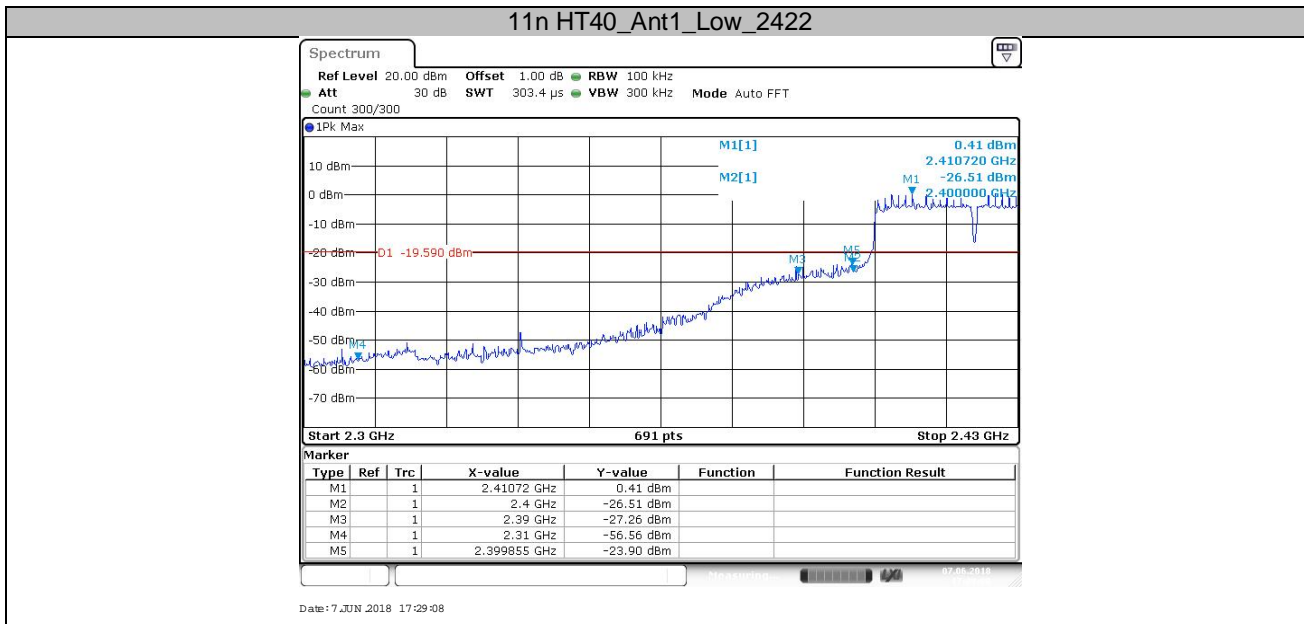

## 9.8 Spurious radiated emissions for transmitter

### Test Method

- 1: The EUT was placed on a turn table which is 1.5m above ground plane for above 1GHz and 0.8m above ground for below 1GHz at 3meter chamber room for test. The table was rotated 360 degrees to determine the position of the highest radiation.
- 2: The EUT was set 3 meters away from the interference – receiving antenna, which was mounted on the top of a variable – height antenna tower.
- 3: The height of antenna is varied from one meter to four meters above the ground to determine the maximum value of the field strength. Both horizontal and vertical polarizations of the antenna are set to make the measurement.
- 4: For each suspected emission, the EUT was arranged to its worst case and then the antenna was tuned to heights from 1 meter to 4 meters and the rotatable table was turned from 0 degrees to 360 degrees to find the maximum reading.
- 5: Use the following spectrum analyzer settings According to C63.10:

#### For Above 1GHz

Span = wide enough to capture the peak level of the in-band emission and all spurious  
RBW = 1MHz, VBW  $\geq$  RBW for peak measurement and VBW = 10Hz for average measurement, Sweep = auto, Detector function = peak, Trace = max hold.

#### For Below 1GHz

Use the following spectrum analyzer settings:

Span = wide enough to capture the peak level of the in-band emission and all spurious  
RBW = 100 KHz, VBW  $\geq$  RBW for peak measurement, Sweep = auto, Detector function = peak, Trace = max hold.

### Note:

- 1: The resolution bandwidth and video bandwidth of test receiver/spectrum analyzer is 120 KHz for Quasi-peak detection (QP) at frequency below 1GHz.
- 2: The resolution bandwidth of test receiver/spectrum analyzer is 1MHz and the video bandwidth is 3MHz for peak detection (PK) at frequency above 1GHz.
- 3: The resolution bandwidth of test receiver/spectrum analyzer is 1MHz and the video bandwidth is 3MHz for RMS Average ((duty cycle < 98%) for Average detection (AV) at frequency above 1GHz, then the measurement results was added to a correction factor ( $20\log(1/\text{duty cycle})$ ).
- 4: The resolution bandwidth of test receiver/spectrum analyzer is 1MHz and the video bandwidth is 10Hz (duty cycle > 98%) for Average detection (AV) at frequency above 1GHz.

## Limit

The radio emission outside the operating frequency band shall be at least 20 dB below that in the 100 kHz bandwidth within the band that contains the highest level of the desired power. Radiated emissions which fall in the restricted bands, as defined in section 15.205, must comply with the radiated emission limits specified in section 15.209.

Frequency MHz	Field Strength uV/m	Field Strength dB $\mu$ V/m	Detector
30-88	100	40	QP
88-216	150	43.5	QP
216-960	200	46	QP
960-1000	500	54	QP
Above 1000	500	54	AV
Above 1000	5000	74	PK



**Spurious radiated emissions for transmitter**

According to C63.10, if the peak (or quasi-peak) measured value complies with the average limit, it is unnecessary to perform an average measurement, so AV emission value did not show in below table if the peak value complies with average limit.

**Transmitting spurious emission test result as below:**

SPTM1 (Version S)

802.11b

2412MHz (30MHz – 1GHz)

Frequency MHz	Emission Level dBuV/m	Polarization	Limit dBuV/m	Margin dB	Detector	Corr. dB	Result
202.49	28.43	Horizontal	43.50	15.07	QP	-28.9	Pass
233.21	30.44	Vertical	46.00	15.56	QP	-26.7	Pass

2412MHz (Above 1GHz)

Frequency MHz	Emission Level dBuV/m	Polarization	Limit dBuV/m	Margin dB	Detector	Corr. dB/m	Result
4251.09	35.39	Horizontal	74.00	38.61	PK	0.5	Pass
4680.93 *	34.32	Vertical	74.00	39.68	PK	1.9	Pass

2437MHz (30MHz – 1GHz)

Frequency MHz	Emission Level dBuV/m	Polarization	Limit dBuV/m	Margin dB	Detector	Corr. dB	Result
--	--	Horizontal	--	--	QP	--	--
--	--	Vertical	--	--	QP	--	--

2437MHz (Above 1GHz)

Frequency MHz	Emission Level dBuV/m	Polarization	Limit dBuV/m	Margin dB	Detector	Corr. dB/m	Result
6308.43	36.80	Horizontal	74.00	37.20	PK	4.4	Pass
4856.25 *	36.03	Vertical	74.00	37.97	PK	2.7	Pass

2462MHz (30MHz – 1GHz)

Frequency MHz	Emission Level dBuV/m	Polarization	Limit dBuV/m	Margin dB	Detector	Corr. dB	Result
--	--	Horizontal	--	--	QP	--	--
--	--	Vertical	--	--	QP	--	--

2462MHz (Above 1GHz)

Frequency MHz	Emission Level dBuV/m	Polarization	Limit dBuV/m	Margin dB	Detector	Corr. dB/m	Result
7494.84 *	40.25	Horizontal	74.00	33.75	PK	6.6	Pass
4804.21 *	34.41	Vertical	74.00	39.59	PK	2.6	Pass



802.11g

2412MHz (30MHz – 1GHz)

Frequency MHz	Emission Level dBuV/m	Polarization	Limit dBµV/m	Margin dB	Detector	Corr. dB	Result
--	--	Horizontal	--	--	QP	--	--
--	--	Vertical	--	--	QP	--	--

2412MHz (Above 1GHz)

Frequency MHz	Emission Level dBuV/m	Polarization	Limit dBµV/m	Margin dB	Detector	Corr. dB/m	Result
4555.31 *	34.07	Horizontal	74.00	39.93	PK	1.4	Pass
4939.68 *	34.53	Vertical	74.00	39.47	PK	2.7	Pass

2437MHz (30MHz – 1GHz)

Frequency MHz	Emission Level dBuV/m	Polarization	Limit dBµV/m	Margin dB	Detector	Corr. dB	Result
--	--	Horizontal	--	--	QP	--	--
--	--	Vertical	--	--	QP	--	--

2437MHz (Above 1GHz)

Frequency MHz	Emission Level dBuV/m	Polarization	Limit dBµV/m	Margin dB	Detector	Corr. dB/m	Result
7050.46	38.99	Horizontal	74.00	35.01	PK	6.0	Pass
7525.78 *	39.93	Vertical	74.00	34.07	PK	6.6	Pass

2462MHz (30MHz – 1GHz)

Frequency MHz	Emission Level dBuV/m	Polarization	Limit dBµV/m	Margin dB	Detector	Corr. dB	Result
--	--	Horizontal	--	--	QP	--	--
--	--	Vertical	--	--	QP	--	--

2462MHz (Above 1GHz)

Frequency MHz	Emission Level dBuV/m	Polarization	Limit dBµV/m	Margin dB	Detector	Corr. dB/m	Result
6477.65	38.07	Horizontal	74.00	35.93	PK	4.7	Pass
5801.25	35.42	Vertical	74.00	38.58	PK	3.5	Pass

## 802.11n HT20

## 2412MHz (30MHz – 1GHz)

Frequency MHz	Emission Level dBuV/m	Polarization	Limit dB $\mu$ V/m	Margin dB	Detector	Corr. dB	Result
--	--	Horizontal	--	--	QP	--	--
--	--	Vertical	--	--	QP	--	--

## 2412MHz (Above 1GHz)

Frequency MHz	Emission Level dBuV/m	Polarization	Limit dB $\mu$ V/m	Margin dB	Detector	Corr. dB/m	Result
8766.09	42.10	Horizontal	74.00	31.90	PK	8.8	Pass
4959.37 *	35.33	Vertical	74.00	38.67	PK	2.8	Pass

## 2437MHz (30MHz – 1GHz)

Frequency MHz	Emission Level dBuV/m	Polarization	Limit dB $\mu$ V/m	Margin dB	Detector	Corr. dB	Result
--	--	Horizontal	--	--	QP	--	--
--	--	Vertical	--	--	QP	--	--

## 2437MHz (Above 1GHz)

Frequency MHz	Emission Level dBuV/m	Polarization	Limit dB $\mu$ V/m	Margin dB	Detector	Corr. dB/m	Result
8759.53	41.79	Horizontal	74.00	32.21	PK	8.8	Pass
7464.37 *	39.53	Vertical	74.00	34.47	PK	6.6	Pass

## 2462MHz (30MHz – 1GHz)

Frequency MHz	Emission Level dBuV/m	Polarization	Limit dB $\mu$ V/m	Margin dB	Detector	Corr. dB	Result
--	--	Horizontal	--	--	QP	--	--
--	--	Vertical	--	--	QP	--	--

## 2462MHz (Above 1GHz)

Frequency MHz	Emission Level dBuV/m	Polarization	Limit dB $\mu$ V/m	Margin dB	Detector	Corr. dB/m	Result
5046.09 *	37.59	Horizontal	74.00	36.41	PK	3.0	Pass
7030.31	39.26	Vertical	74.00	34.74	PK	6.1	Pass

## 802.11n HT40

## 2422MHz (30MHz – 1GHz)

Frequency MHz	Emission Level dBuV/m	Polarization	Limit dB $\mu$ V/m	Margin dB	Detector	Corr. dB	Result
--	--	Horizontal	--	--	QP	--	--
--	--	Vertical	--	--	QP	--	--

## 2422MHz (Above 1GHz)

Frequency MHz	Emission Level dBuV/m	Polarization	Limit dB $\mu$ V/m	Margin dB	Detector	Corr. dB/m	Result
4718.90 *	36.15	Horizontal	74.00	37.85	PK	1.9	Pass
7132.50	38.74	Vertical	74.00	35.26	PK	5.6	Pass

## 2437MHz (30MHz – 1GHz)

Frequency MHz	Emission Level dBuV/m	Polarization	Limit dB $\mu$ V/m	Margin dB	Detector	Corr. dB	Result
--	--	Horizontal	--	--	QP	--	--
--	--	Vertical	--	--	QP	--	--

## 2437MHz (Above 1GHz)

Frequency MHz	Emission Level dBuV/m	Polarization	Limit dB $\mu$ V/m	Margin dB	Detector	Corr. dB/m	Result
8820.46	41.51	Horizontal	74.00	32.49	PK	8.5	Pass
9748.12	45.77	Vertical	74.00	28.23	PK	9.0	Pass

## 2462MHz (30MHz – 1GHz)

Frequency MHz	Emission Level dBuV/m	Polarization	Limit dB $\mu$ V/m	Margin dB	Detector	Corr. dB	Result
--	--	Horizontal	--	--	QP	--	--
--	--	Vertical	--	--	QP	--	--

## 2462MHz (Above 1GHz)

Frequency MHz	Emission Level dBuV/m	Polarization	Limit dB $\mu$ V/m	Margin dB	Detector	Corr. dB/m	Result
9808.12	43.03	Horizontal	74.00	30.97	PK	8.9	Pass
8740.31	41.93	Vertical	74.00	32.07	PK	8.8	Pass

## Remark:

- (1) "\*" means the emission(s) appear within the restrict bands shall follow the requirement of section 15.205.
- (2) Data of measurement within this frequency range shown "--" in the table above means the reading of emissions are the noise floor or attenuated more than 10dB below the permissible limits or the field strength is too small to be measured.
- (3) Above 1GHz: Corrector factor = Antenna Factor + Cable Loss- Amplifier Gain.
- (4) Below 1GHz: Corrector factor = Antenna Factor + Cable Loss.



SPTM1 (Version W)

802.11b

2412MHz (30MHz – 1GHz)

Frequency MHz	Emission Level dBuV/m	Polarization	Limit dBµV/m	Margin dB	Detector	Corr. dB	Result
880.31	31.46	Horizontal	46.00	14.54	QP	-15.8	Pass
280.79	32.80	Vertical	46.00	13.20	QP	-21.4	Pass

2412MHz (Above 1GHz)

Frequency MHz	Emission Level dBuV/m	Polarization	Limit dBµV/m	Margin dB	Detector	Corr. dB/m	Result
8720.15	40.53	Horizontal	74.00	33.47	PK	8.6	Pass
8761.87	42.60	Vertical	74.00	31.40	PK	8.9	Pass

2437MHz (30MHz – 1GHz)

Frequency MHz	Emission Level dBuV/m	Polarization	Limit dBµV/m	Margin dB	Detector	Corr. dB	Result
--	--	Horizontal	--	--	QP	--	--
--	--	Vertical	--	--	QP	--	--

2437MHz (Above 1GHz)

Frequency MHz	Emission Level dBuV/m	Polarization	Limit dBµV/m	Margin dB	Detector	Corr. dB/m	Result
7057.50	38.97	Horizontal	74.00	35.03	PK	6.0	Pass
7380.00	39.01	Vertical	74.00	34.99	PK	6.2	Pass

2462MHz (30MHz – 1GHz)

Frequency MHz	Emission Level dBuV/m	Polarization	Limit dBµV/m	Margin dB	Detector	Corr. dB	Result
--	--	Horizontal	--	--	QP	--	--
--	--	Vertical	--	--	QP	--	--

2462MHz (Above 1GHz)

Frequency MHz	Emission Level dBuV/m	Polarization	Limit dBµV/m	Margin dB	Detector	Corr. dB/m	Result
9748.12	42.76	Horizontal	74.00	31.24	PK	8.9	Pass
8778.28	42.43	Vertical	74.00	31.57	PK	9.0	Pass





802.11g

2412MHz (30MHz – 1GHz)

Frequency MHz	Emission Level dBuV/m	Polarization	Limit dBµV/m	Margin dB	Detector	Corr. dB	Result
--	--	Horizontal	--	--	QP	--	--
--	--	Vertical	--	--	QP	--	--

2412MHz (Above 1GHz)

Frequency MHz	Emission Level dBuV/m	Polarization	Limit dBµV/m	Margin dB	Detector	Corr. dB/m	Result
7459.21	39.07	Horizontal	74.00	34.93	PK	6.5	Pass
9197.81	40.38	Vertical	74.00	33.62	PK	8.8	Pass

2437MHz (30MHz – 1GHz)

Frequency MHz	Emission Level dBuV/m	Polarization	Limit dBµV/m	Margin dB	Detector	Corr. dB	Result
--	--	Horizontal	--	--	QP	--	--
--	--	Vertical	--	--	QP	--	--

2437MHz (Above 1GHz)

Frequency MHz	Emission Level dBuV/m	Polarization	Limit dBµV/m	Margin dB	Detector	Corr. dB/m	Result
7043.90	40.38	Horizontal	74.00	33.62	PK	6.0	Pass
8733.28	42.49	Vertical	74.00	31.51	PK	8.8	Pass

2462MHz (30MHz – 1GHz)

Frequency MHz	Emission Level dBuV/m	Polarization	Limit dBµV/m	Margin dB	Detector	Corr. dB	Result
--	--	Horizontal	--	--	QP	--	--
--	--	Vertical	--	--	QP	--	--

2462MHz (Above 1GHz)

Frequency MHz	Emission Level dBuV/m	Polarization	Limit dBµV/m	Margin dB	Detector	Corr. dB/m	Result
9340.31	41.19	Horizontal	74.00	32.81	PK	8.7	Pass
9298.59	42.36	Vertical	74.00	31.64	PK	8.8	Pass



802.11n HT20  
2412MHz (30MHz – 1GHz)

Frequency MHz	Emission Level dBuV/m	Polarization	Limit dBuV/m	Margin dB	Detector	Corr. dB	Result
--	--	Horizontal	--	--	QP	--	--
--	--	Vertical	--	--	QP	--	--

2412MHz (Above 1GHz)

Frequency MHz	Emission Level dBuV/m	Polarization	Limit dBuV/m	Margin dB	Detector	Corr. dB/m	Result
8787.65	41.55	Horizontal	74.00	32.45	PK	8.8	Pass
8759.06	42.68	Vertical	74.00	31.32	PK	8.9	Pass

2437MHz (30MHz – 1GHz)

Frequency MHz	Emission Level dBuV/m	Polarization	Limit dBuV/m	Margin dB	Detector	Corr. dB	Result
--	--	Horizontal	--	--	QP	--	--
--	--	Vertical	--	--	QP	--	--

2437MHz (Above 1GHz)

Frequency MHz	Emission Level dBuV/m	Polarization	Limit dBuV/m	Margin dB	Detector	Corr. dB/m	Result
9565.31	40.43	Horizontal	74.00	33.57	PK	8.6	Pass
9359.06	41.81	Vertical	74.00	32.19	PK	8.9	Pass

2462MHz (30MHz – 1GHz)

Frequency MHz	Emission Level dBuV/m	Polarization	Limit dBuV/m	Margin dB	Detector	Corr. dB	Result
--	--	Horizontal	--	--	QP	--	--
--	--	Vertical	--	--	QP	--	--

2462MHz (Above 1GHz)

Frequency MHz	Emission Level dBuV/m	Polarization	Limit dBuV/m	Margin dB	Detector	Corr. dB/m	Result
8644.21	42.17	Horizontal	74.00	31.83	PK	8.1	Pass
8770.78	42.52	Vertical	74.00	31.48	PK	9.0	Pass

## 802.11n HT40

## 2422MHz (30MHz – 1GHz)

Frequency MHz	Emission Level dBuV/m	Polarization	Limit dB $\mu$ V/m	Margin dB	Detector	Corr. dB	Result
--	--	Horizontal	--	--	QP	--	--
--	--	Vertical	--	--	QP	--	--

## 2422MHz (Above 1GHz)

Frequency MHz	Emission Level dBuV/m	Polarization	Limit dB $\mu$ V/m	Margin dB	Detector	Corr. dB/m	Result
9298.12	41.33	Horizontal	74.00	32.67	PK	8.6	Pass
8152.03	40.33	Vertical	74.00	33.67	PK	8.0	Pass

## 2437MHz (30MHz – 1GHz)

Frequency MHz	Emission Level dBuV/m	Polarization	Limit dB $\mu$ V/m	Margin dB	Detector	Corr. dB	Result
--	--	Horizontal	--	--	QP	--	--
--	--	Vertical	--	--	QP	--	--

## 2437MHz (Above 1GHz)

Frequency MHz	Emission Level dBuV/m	Polarization	Limit dB $\mu$ V/m	Margin dB	Detector	Corr. dB/m	Result
7111.40	38.12	Horizontal	74.00	35.88	PK	5.6	Pass
7332.65	38.27	Vertical	74.00	35.73	PK	6.1	Pass

## 2462MHz (30MHz – 1GHz)

Frequency MHz	Emission Level dBuV/m	Polarization	Limit dB $\mu$ V/m	Margin dB	Detector	Corr. dB	Result
--	--	Horizontal	--	--	QP	--	--
--	--	Vertical	--	--	QP	--	--

## 2462MHz (Above 1GHz)

Frequency MHz	Emission Level dBuV/m	Polarization	Limit dB $\mu$ V/m	Margin dB	Detector	Corr. dB/m	Result
8672.34	40.87	Horizontal	74.00	33.13	PK	8.3	Pass
7508.43	40.00	Vertical	74.00	34.00	PK	6.7	Pass

## Remark:

- (1) "\*" means the emission(s) appear within the restrict bands shall follow the requirement of section 15.205.
- (2) Data of measurement within this frequency range shown "--" in the table above means the reading of emissions are the noise floor or attenuated more than 10dB below the permissible limits or the field strength is too small to be measured.
- (3) Above 1GHz: Corrector factor = Antenna Factor + Cable Loss- Amplifier Gain.
- (4) Below 1GHz: Corrector factor = Antenna Factor + Cable Loss.

## 10 Test Equipment List

### Radiated Emission Test

DESCRIPTION	MANUFACTURER	MODEL NO.	SERIAL NO.	CAL. DUE DATE
EMI Test Receiver	Rohde & Schwarz	ESR 26	101269	2018-7-14
Trilog Super Broadband Test Antenna	Schwarzbeck	VULB 9163	707	2018-7-14
Horn Antenna	Rohde & Schwarz	HF907	102294	2018-7-14
Pre-amplifier	Rohde & Schwarz	SCU 18	102230	2018-7-14
Signal Generator	Rohde & Schwarz	SMY01	839369/005	2018-7-7
Attenuator	Agilent	8491A	MY39264334	2018-7-7
3m Semi-anechoic chamber	TDK	9X6X6	----	2020-7-7
Test software	Rohde & Schwarz	EMC32	Version 9.15.00	N/A

### Conducted Emission Test

DESCRIPTION	MANUFACTURER	MODEL NO.	SERIAL NO.	CAL. DUE DATE
EMI Test Receiver	Rohde & Schwarz	ESR 3	101782	2018-7-14
LISN	Rohde & Schwarz	ENV4200	100249	2018-7-14
LISN	Rohde & Schwarz	ENV432	101318	2018-7-14
LISN	Rohde & Schwarz	ENV216	100326	2018-7-14
ISN	Rohde & Schwarz	ENY81	100177	2018-7-14
ISN	Rohde & Schwarz	ENY81-CA6	101664	2018-7-14
High Voltage Probe	Rohde & Schwarz	TK9420(VT9420)	9420-584	2018-7-14
RF Current Probe	Rohde & Schwarz	EZ-17	100816	2018-7-14
Attenuator	Shanghai Huaxiang	TS2-26-3	080928189	2018-7-7
Test software	Rohde & Schwarz	EMC32	Version9.15.00	N/A

### TS8997 Test System

DESCRIPTION	MANUFACTURER	MODEL NO.	SERIAL NO.	CAL. DUE DATE
Signal Generator	Rohde & Schwarz	SMB100A	108272	2018-7-7
Vector Signal Generator	Rohde & Schwarz	SMBV100A	262825	2018-7-23
Communication Synthetical Test Instrument	Rohde & Schwarz	CMW 270	101251	2019-2-15
Signal Analyzer	Rohde & Schwarz	FSV40	101030	2018-7-7
Vector Signal Generator	Rohde & Schwarz	SMU 200A	105324	2018-7-7
RF Switch Module	Rohde & Schwarz	OSP120/OSP-B157	101226/100851	2018-7-7
Power Splitter	Weinschel	1580	SC319	2018-7-7
10dB Attenuator	Weinschel	56-10	58764	2018-7-14
10dB Attenuator	R&S	DNF	DNF-001	2018-7-14
10dB Attenuator	R&S	DNF	DNF-002	2018-7-14
10dB Attenuator	R&S	DNF	DNF-003	2018-7-14
10dB Attenuator	R&S	DNF	DNF-004	2018-7-14
Test software	Rohde & Schwarz	EMC32	Version 10.38.00	N/A
Test software	Tonscend	System for BT/WIFI	Version 2.6	N/A



## 11 System Measurement Uncertainty

For a 95% confidence level, the measurement expanded uncertainties for defined systems, in accordance with the recommendations of ISO 17025 were:

System Measurement Uncertainty	
Items	Extended Uncertainty
Uncertainty for Radiated Spurious Emission 25MHz-3000MHz	Horizontal: 4.80dB; Vertical: 4.87dB;
Uncertainty for Radiated Spurious Emission 3000MHz-18000MHz	Horizontal: 4.59dB; Vertical: 4.58dB;
Uncertainty for Radiated Spurious Emission 18000MHz-40000MHz	Horizontal: 5.05dB; Vertical: 5.04dB;
Uncertainty for Conducted RF test with TS 8997	Power level test involved: 2.13dB Frequency test involved: $0.6 \times 10^{-7}$
Uncertainty for Conducted Emission 150kHz-30MHz (for test using AMN ENV432 or ENV4200)	3.21dB