



FCC/IC - TEST REPORT

Report Number	: 68.950.18.0210.01	Date of Issue:	<u>June 21, 2018</u>
Model	: SPTM1		
Product Type	: Camera		
Applicant	: GoPro, Inc.		
Address	: 3000 Clearview Way, San Mateo, CA 94402, USA		
Production Facility	: GoPro, Inc.		
Address	: 3000 Clearview Way, San Mateo, CA 94402, USA		
Test Result	: <input checked="" type="checkbox"/> Positive <input type="checkbox"/> Negative		
Total pages including Appendices	: 52		

TÜV SÜD CERTIFICATION AND TESTING (CHINA) CO., LTD. SHENZHEN BRANCH is a subcontractor to TÜV SÜD Product Service GmbH according to the principles outlined in ISO 17025. TÜV SÜD CERTIFICATION AND TESTING (CHINA) CO., LTD. SHENZHEN BRANCH reports apply only to the specific samples tested under stated test conditions. Construction of the actual test samples has been documented. It is the manufacturer's responsibility to assure that additional production units of this model are manufactured with identical electrical and mechanical components. The manufacturer/importer is responsible to the Competent Authorities in Europe for any modifications made to the production units which result in non-compliance to the relevant regulations TÜV SÜD CERTIFICATION AND TESTING (CHINA) CO., LTD. SHENZHEN BRANCH shall have no liability for any deductions, inferences or generalizations drawn by the client or others from TÜV SÜD CERTIFICATION AND TESTING (CHINA) CO., LTD. SHENZHEN BRANCH issued reports. This report is the confidential property of the client. As a mutual protection to our clients, the public and ourselves, extracts from the test report shall not be reproduced except in full without our written approval.



1 Table of Contents

1	Table of Contents	2
2	Details about the Test Laboratory	3
3	Description of the Equipment Under Test	4
4	Summary of Test Standards	5
5	Summary of Test Results	6
6	General Remarks	7
7	Test Setups	8
8	Systems test configuration	9
9	Technical Requirement	10
9.1	Conducted Emission	10
9.2	Conducted AV output power	13
9.3	20 dB bandwidth.....	14
9.4	99% Occupied Bandwidth	19
9.5	Carrier Frequency Separation	24
9.6	Number of hopping frequencies	27
9.7	Dwell Time.....	30
9.8	Spurious RF conducted emissions.....	34
9.9	Band edge testing	42
9.10	Spurious radiated emissions for transmitter.....	47
10	Test Equipment List.....	51
11	System Measurement Uncertainty	52



2 Details about the Test Laboratory

Details about the Test Laboratory

Test Site 1

Company name: TÜV SÜD Certification and Testing (China) Co., Ltd. Shenzhen Branch
Building 12 & 13, Zhiheng Wisdomland Business Park, Nantou Checkpoint
Road 2, Nanshan District
Shenzhen 518052
P.R. China

Telephone: 86 755 8828 6998

Fax: 86 755 8828 5299

FCC Registration Number: 514049

Number:

IC Registration Number: 10320A-1

Number:

3 Description of the Equipment Under Test

Product:	Camera
Model no.:	SPTM1
IC:	10193A-SPTM1
FCC ID:	CNFSPTM1
Rating:	3.85Vdc
RF Transmission Frequency:	2402MHz-2480MHz
No. of Operated Channel:	79
Modulation:	GFSK, $\pi/4$ -DQPSK, 8-DPSK
Antenna Type:	Integrated Metal Antenna
Antenna Gain:	0.5dBi max for 2.4GHz
Description of the EUT:	The Equipment Under Test (EUT) is a Camera supports 2.4GHz Bluetooth/WIFI, 5GHz WIFI functions.

4 Summary of Test Standards

Test Standards	
FCC Part 15 Subpart C 10-1-2017 Edition	PART 15 - RADIO FREQUENCY DEVICES Subpart C - Intentional Radiators
RSS-Gen Issue 5 April 2018	RSS-Gen — General Requirements for Compliance of Radio Apparatus
RSS-247 Issue 2 February 2017	Digital Transmission Systems (DTS), Frequency Hopping Systems (FHSS) and License-Exempt Local Area Network (LE-LAN) Devices

All the test methods were according to Public Notice DA 00-705 -Frequency Hopper Spread Spectrum Test Procedure released by FCC on March 30, 2000 and ANSI C63.10-2013.

5 Summary of Test Results

Technical Requirements					
FCC Part 15 Subpart C/RSS-247 Issue 2/RSS-Gen Issue 5					
Test Condition			Pages	Test Result	Test Site
§15.207	RSS-GEN 8.8	Conducted emission AC power port	10	Pass	Site 1
§15.247(b)(1)	RSS-247 Clause 5.4(b)	Conducted AV output power for FHSS	13	Pass	Site 1
§15.247(b)(3)	RSS-247 Clause 5.4(d)	Conducted AV output power for DTS	--	N/A	--
§15.247(e)	RSS-247 Clause 5.2(b)	Power spectral density	--	N/A	--
§15.247(a)(2)	RSS-247 Clause 5.2(a)	6dB bandwidth	--	N/A	--
§15.247(a)(1)	RSS-247 Clause 5.1(a)	20dB Occupied bandwidth	14	Pass	Site 1
--	RSS-GEN 6.7	99% Occupied Bandwidth	19	Pass	Site 1
§15.247(a)(1)	RSS-247 Clause 5.1(b)	Carrier frequency separation	24	Pass	Site 1
§15.247(a)(1)(i ii)	RSS-247 Clause 5.1(d)	Number of hopping frequencies	27	Pass	Site 1
§15.247(a)(1)(i ii)	RSS-247 Clause 5.1(d)	Dwell Time	30	Pass	Site 1
§15.247(d)	RSS-247 Clause 5.5	Spurious RF conducted emissions	34	Pass	Site 1
§15.247(d)	RSS-247 Clause 5.5	Band edge	42	Pass	Site 1
§15.247(d) & §15.209 & §15.205	RSS-247 Clause 5.5 & RSS-GEN 6.13 RSS-GEN 8.9 RSS-GEN 8.10	Spurious radiated emissions for transmitter	47	Pass	Site 1
§15.203	RSS-GEN 6.8	Antenna requirement	See note 2	Pass	--

Note 1: N/A – Not Applicable.

Note 2: The EUT uses an integrated metal antenna 0.5dBi max. According to §15.203, it is considered sufficiently to comply with the provisions of this section.



6 General Remarks

Remarks

This submittal(s) (test report) is intended for FCC ID: CNFSPTM1, IC: 10193A-SPTM1, complies with Section 15.207, 15.209, 15.205, 15.247 of the FCC Part 15, Subpart C and RSS 247 and RSS-Gen rules.

The Model: SPTM1 supports Bluetooth BR+EDR/Bluetooth Low Energy/WIFI/GPS & Galileo receiving functions, power by 3.85Vdc, 1220mAh supplied by an internal rechargeable Lithium Ion Battery or 5Vdc supplied by USB type C port.

The TX and RX range is 2402MHz-2480MHz for Bluetooth, 2412MHz – 2462MHz for 2.4GHzWIFI, 5180MHz – 5320MHz, 5500MHz – 5700MHz, 5745MHz – 5825MHz for 5GHzWIFI, 1575.42MHz for GNSS (only GPS and Galileo) Receiver, also supports two versions (Version W and Version S), the Version W is identical with the Version S except of the Version S is Dark grey color with GPS & Galileo receiving function, supported resolutions:4K/30fps, 1440/30fps, 1440/60fps and 960/90fps. The Version W is Light grey color without GPS & Galileo receiving function; supported resolutions: 1440/30fps and 1440/60fps, therefore Spurious Emissions was tested with the two versions, and the others test items were only performed on the Version S.

This report is for the Bluetooth BR+EDR part.

SUMMARY:

All tests according to the regulations cited on page 5 were

- Performed

- **Not** Performed

The Equipment Under Test

- **Fulfills** the general approval requirements.

- **Does not** fulfill the general approval requirements.

- **Fulfills** the general approval requirements.

- **Does not** fulfill the general approval requirements.

Sample Received Date: May 09, 2018

Testing Start Date: May 09, 2018

Testing End Date: June 06, 2018

- TÜV SÜD Certification and Testing (China) Co., Ltd. Shenzhen Branch -

Reviewed by:

Prepared by:

Tested by:



Phoebe Hu
EMC Project Manager

Aaron Lai
EMC Project Engineer

Louise Liu
EMC Test Engineer

7 Test Setups

7.1 Radiated test setups

Below 1GHz

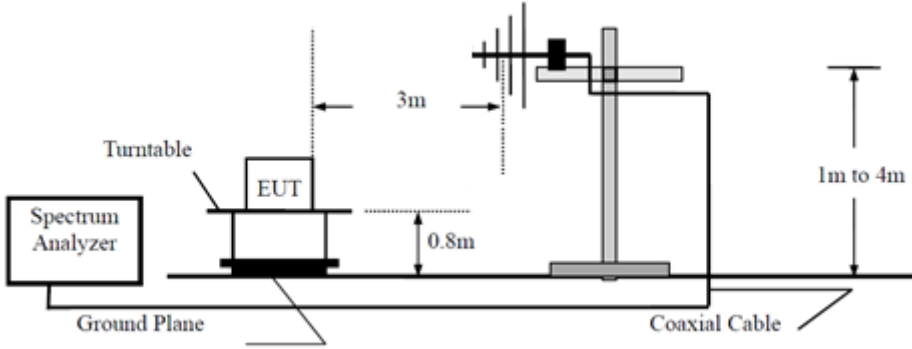

Above 1GHz

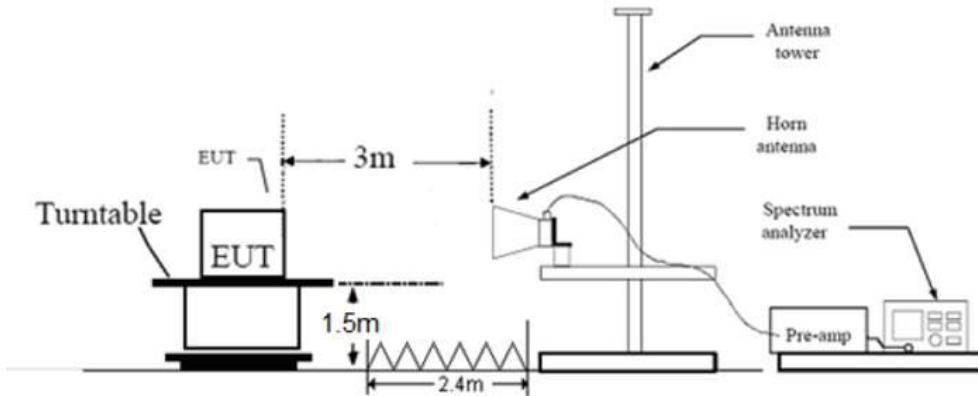

7.2 Conducted RF test setups

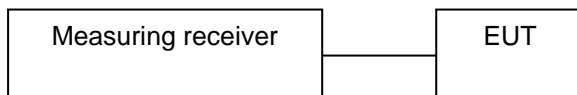

7.3 AC Power Line Conducted Emission test setups

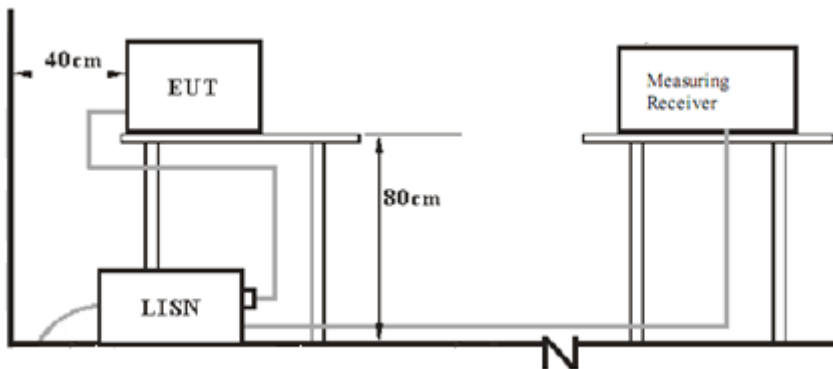

8 Systems test configuration

Auxiliary Equipment Used during Test:

DESCRIPTION	MANUFACTURER	MODEL NO.	S/N
Laptop	Lenovo	T460S	---
USB Type C cable	GoPro	0.55m (Length)	---
AC Adapter	Apple	A1401	---

Test software information:

Test Software Version	QRCT (V3.0-00230) from QUALCOMM	
Modulation	Setting TX Power	Packet Type
GFSK	8	DH5
π/4DQPSK	8	2DH5
8-DPSK	8	3DH5

The system was configured to hopping mode and non-hopping mode.

Hopping mode: typical working mode (normal hopping status)

Non-hopping mode: The system was configured to operate at a signal channel transmitting. The test software allows the configuration and operation at the worst-case duty and the highest transmit power



9 Technical Requirement

9.1 Conducted Emission

Test Method

1. The EUT was placed on a table, which is 0.8m above ground plane
2. The power line of the EUT is connected to the AC mains through a Artificial Mains Network (A.M.N.).
3. Maximum procedure was performed to ensure EUT compliance
4. A EMI test receiver is used to test the emissions from both sides of AC line

Limit

Frequency MHz	QP Limit dB μ V	AV Limit dB μ V
0.150-0.500	66-56*	56-46*
0.500-5	56	46
5-30	60	50

Decreasing linea

Conducted Emission

Product Type : Camera
 M/N : SPTM1 (Version S)
 Operating Condition : Charging + TX
 Test Specification : Power Line, Live
 Comment : AC 120V/60Hz (External adapter)

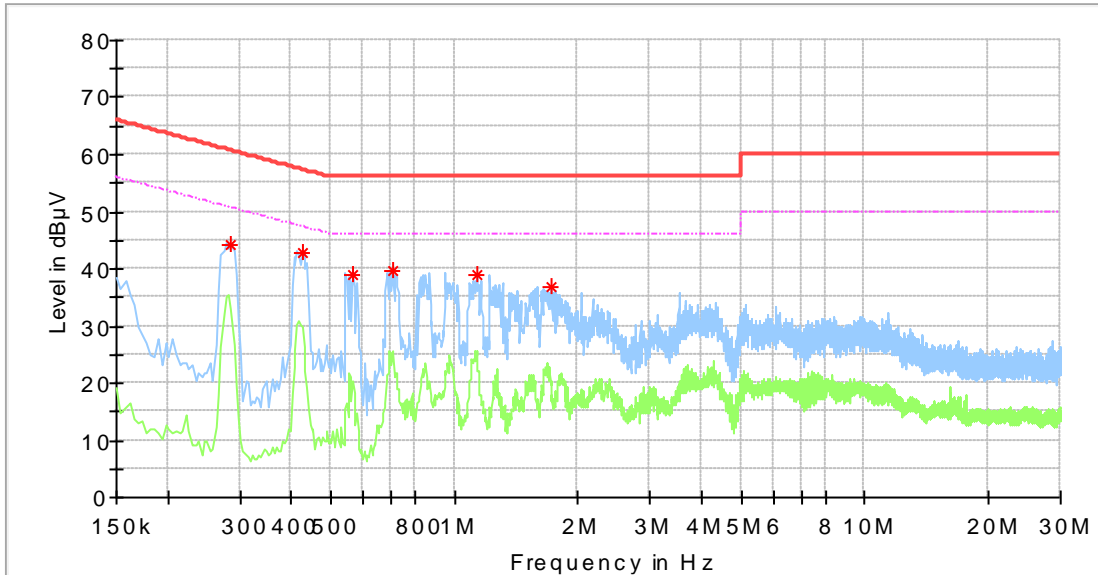

Frequency (MHz)	MaxPeak (dBµV)	Average (dBµV)	Limit (dBµV)	Margin (dB)	Line	Corr. (dB)
0.286000	44.33	---	60.64	16.31	L1	10.2
0.426000	42.97	---	57.33	14.36	L1	11.3
0.566000	38.89	---	56.00	17.11	L1	10.2
0.706000	39.70	---	56.00	16.30	L1	10.2
1.134000	38.85	---	56.00	17.15	L1	10.2
1.718000	36.99	---	56.00	19.01	L1	10.2

Remark : “*” Correct factor=cable loss + LISN factor

Conducted Emission

Product Type : Camera
 M/N : SPTM1 (Version S)
 Operating Condition : Charging + TX
 Test Specification : Power Line, Neutral
 Comment : AC 120V/60Hz (External adapter)

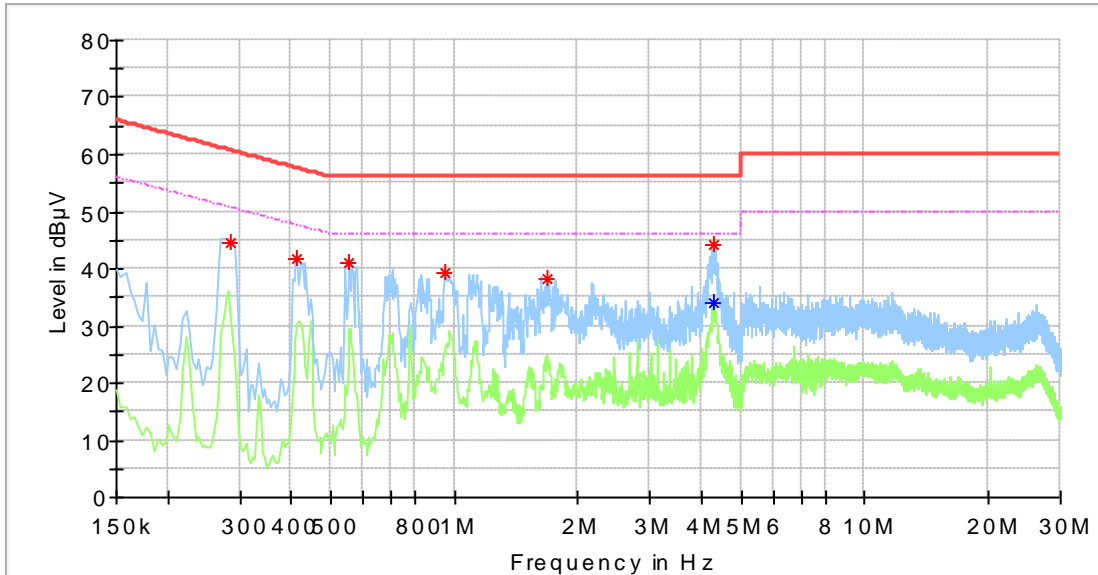

Frequency (MHz)	MaxPeak (dBµV)	Average (dBµV)	Limit (dBµV)	Margin (dB)	Line	Corr. (dB)
0.286000	44.72	---	60.64	15.92	N	10.3
0.414000	41.82	---	57.57	15.75	N	10.3
0.554000	41.20	---	56.00	14.80	N	10.4
0.946000	39.35	---	56.00	16.65	N	10.4
1.678000	38.11	---	56.00	17.89	N	10.4
4.262000	---	34.11	46.00	11.89	N	10.5
4.266000	44.09	---	56.00	11.91	N	10.5

Remark : “*” Correct factor=cable loss + LISN factor

9.2 Conducted AV output power

Test Method

1. Setting the highest output power level of the EUT:
2. Connect to gated RF power meter.

Test Setup

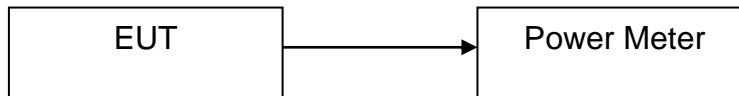

Limits

According to §15.247 (b) (1), conducted AV output power limit as below:

Frequency Range MHz	Limit W	Limit dBm
2400-2483.5	≤1	≤30

Test Result

Bluetooth Mode GFSK modulation Test Result

Frequency MHz	Conducted AV Output Power dBm	Result
Low channel 2402MHz	6.70	Pass
Middle channel 2441MHz	6.60	Pass
High channel 2480MHz	6.30	Pass

Bluetooth Mode π/4-DQPSK modulation Test Result

Frequency MHz	Conducted AV Output Power dBm	Result
Low channel 2402MHz	4.40	Pass
Middle channel 2441MHz	4.30	Pass
High channel 2480MHz	4.00	Pass

Bluetooth Mode 8DPSK modulation Test Result

Frequency MHz	Conducted AV Output Power dBm	Result
Low channel 2402MHz	4.40	Pass
Middle channel 2441MHz	4.30	Pass
High channel 2480MHz	4.00	Pass



9.3 20 dB bandwidth

Test Method

1. Check the calibration of the measuring instrument using either an internal calibrator or a known signal from an external generator.
2. Position the EUT without connection to measurement instrument. Turn on the EUT and connect it to measurement instrument. Then set it to any one convenient frequency within its operating range. Set a reference level on the measuring instrument equal to the highest peak value.
3. Measure the frequency difference of two frequencies that were attenuated 20 dB from the reference level. Record the frequency difference as the emission bandwidth.
4. Repeat above procedures until all frequencies measured were complete.

Limit

Limit [kHz]

N/A

20 dB bandwidth

Test Mode	Channel (MHz)	Result (MHz)	Limit	Verdict
GFSK	2402	1.122	---	PASS
GFSK	2441	1.122	---	PASS
GFSK	2480	1.122	---	PASS
$\pi/4$ -DQPSK	2402	1.371	---	PASS
$\pi/4$ -DQPSK	2441	1.368	---	PASS
$\pi/4$ -DQPSK	2480	1.368	---	PASS
8DPSK	2402	1.377	---	PASS
8DPSK	2441	1.377	---	PASS
8DPSK	2480	1.374	---	PASS

Test Graphs

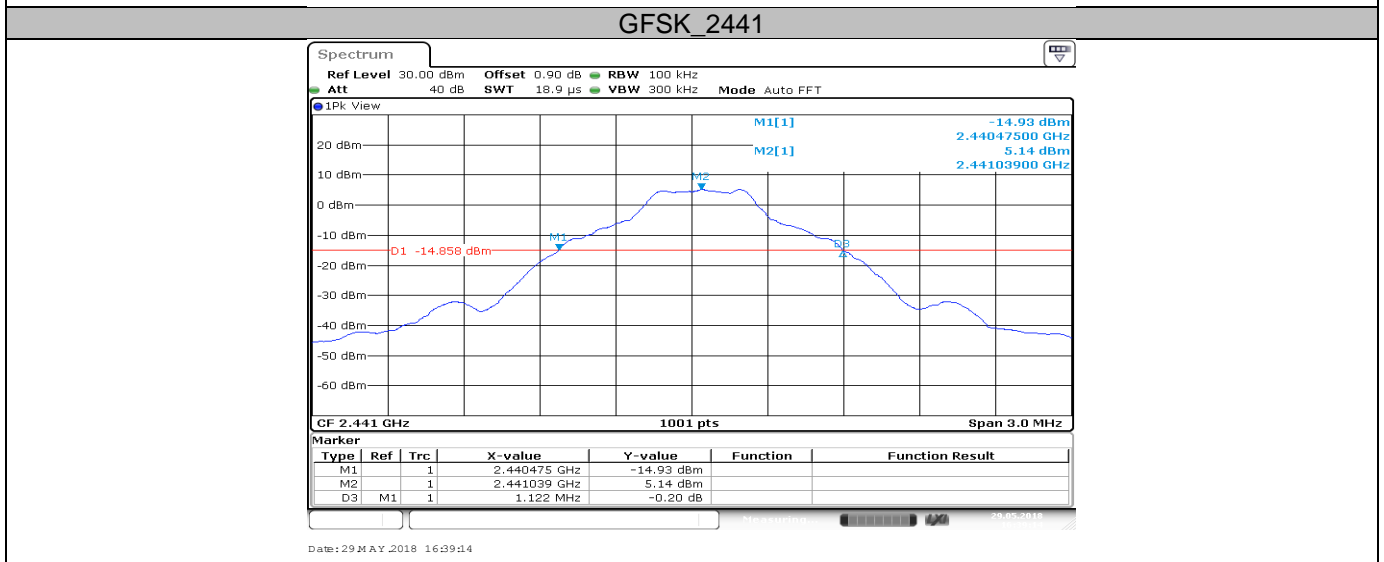
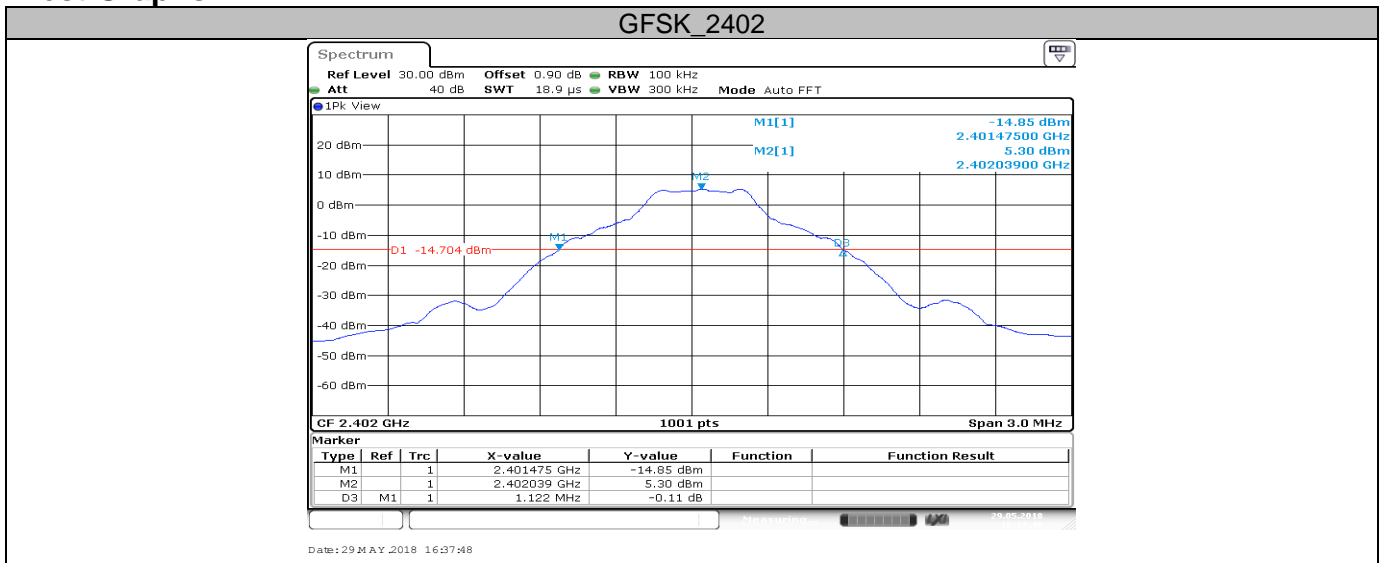

GFSK_2480

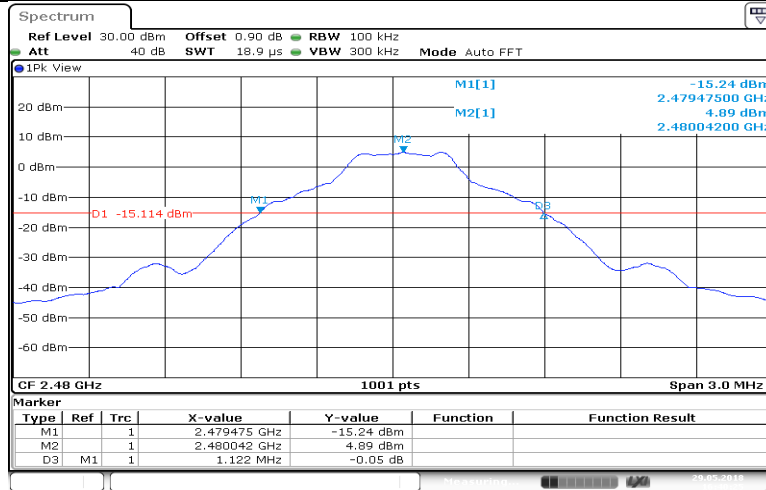

Date: 29 MAY 2018 16:40:25

$\pi/4$ -DQPSK_2402

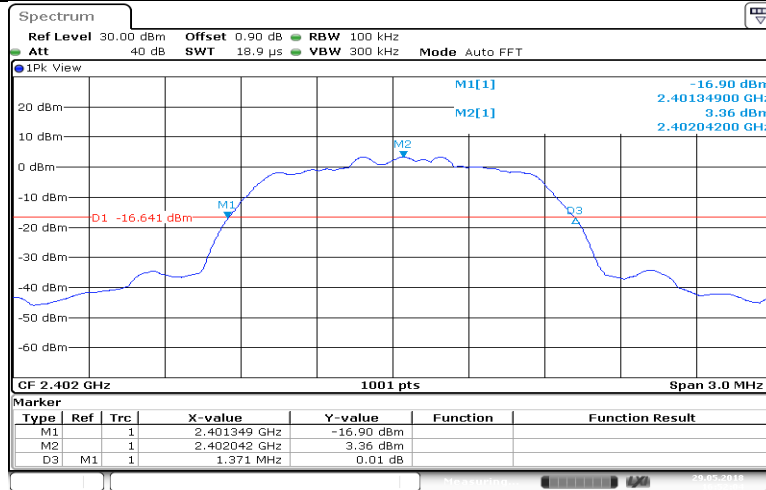

Date: 29 MAY 2018 16:52:04

$\pi/4$ -DQPSK_2441

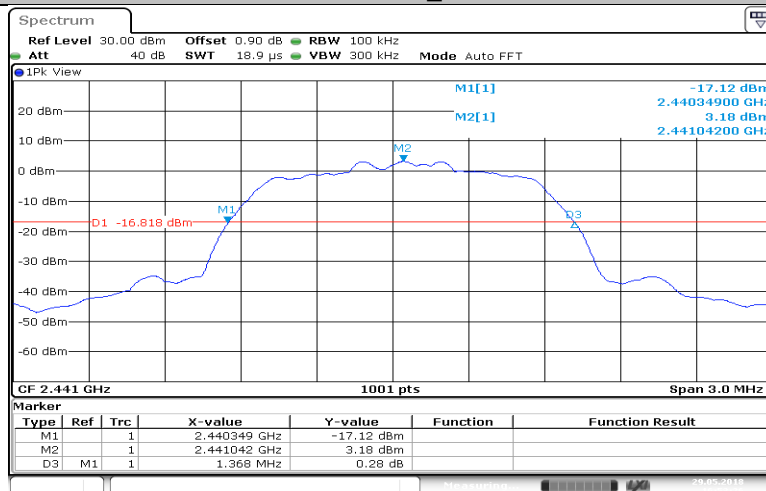

Date: 29 MAY 2018 16:53:26

π/4-DQPSK_2480

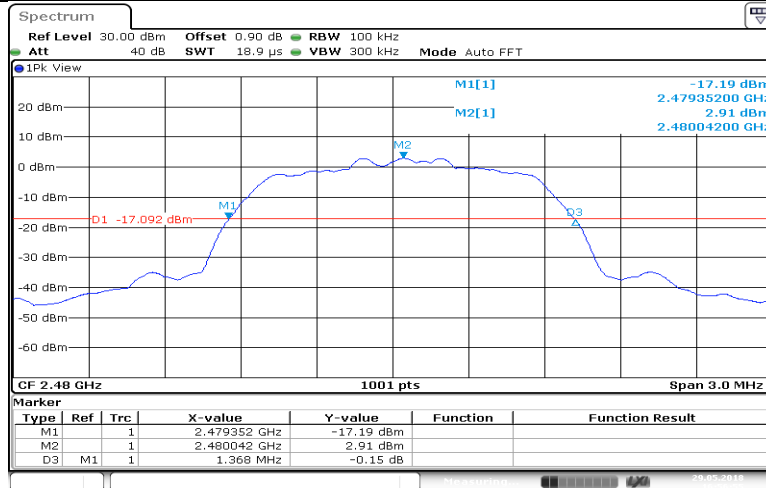

Date: 29 MAY 2018 16:56:55

8DPSK_2402

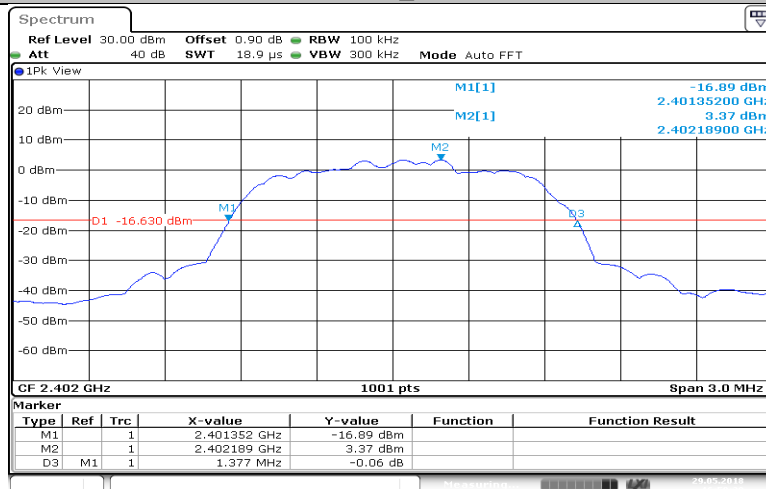

Date: 29 MAY 2018 16:58:28

8DPSK_2441

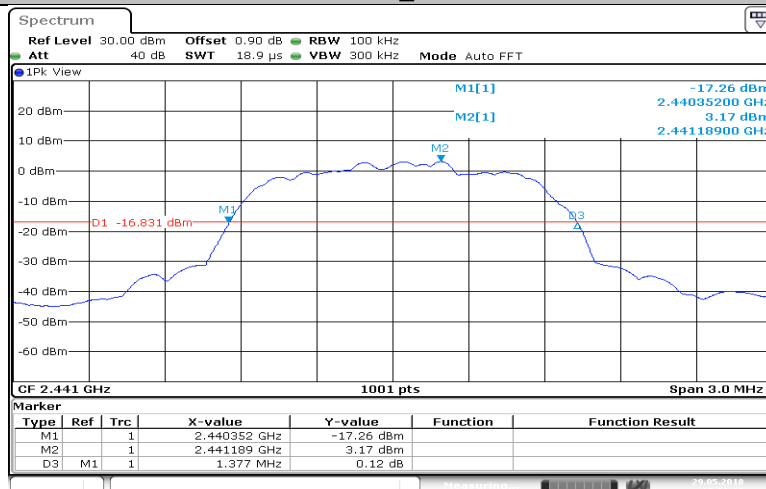

Date: 29 MAY 2018 17:01:10

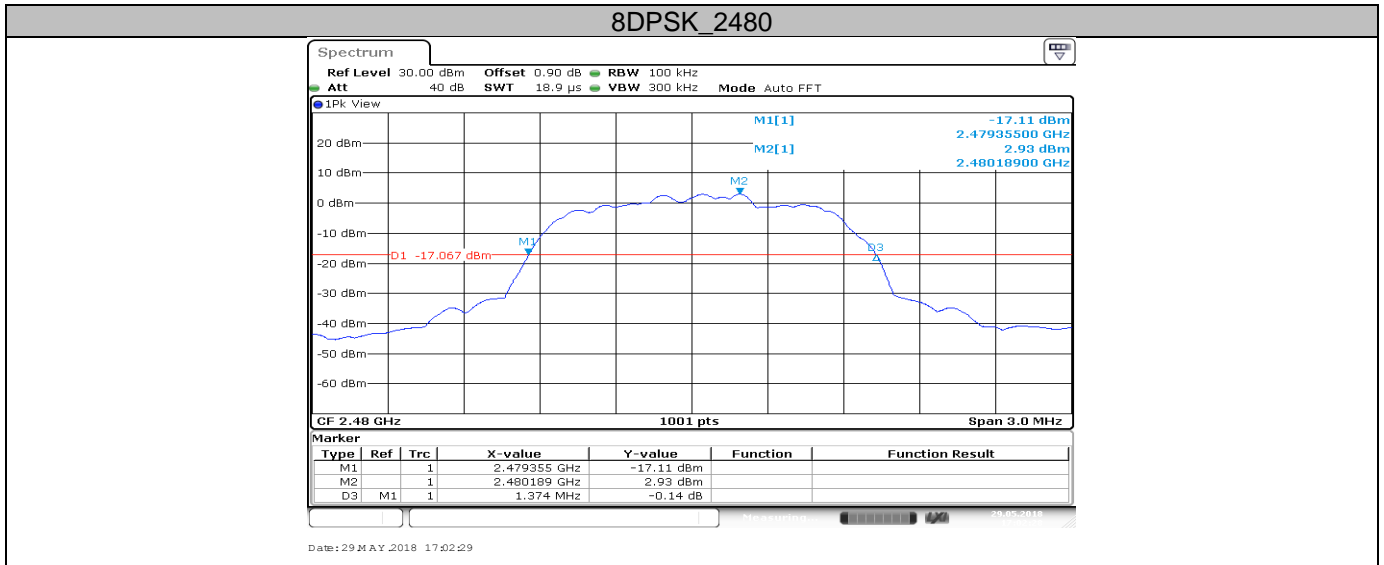

9.4 99% Occupied Bandwidth

Test Method

1. Check the calibration of the measuring instrument using either an internal calibrator or a known signal from an external generator.
2. Position the EUT without connection to measurement instrument. Turn on the EUT and connect it to measurement instrument. Then set it to any one convenient frequency within its operating range. Set a reference level on the measuring instrument equal to the highest peak value.
3. Select OBW function in measurement instrument.
4. Repeat above procedures until all frequencies measured were complete.

Limit

Limit [kHz]

N/A

99% Occupied Bandwidth

Test Mode	Channel (MHz)	Result (MHz)	Limit	Verdict
GFSK	2402	0.878	---	PASS
GFSK	2441	0.878	---	PASS
GFSK	2480	0.878	---	PASS
$\pi/4$ -DQPSK	2402	1.169	---	PASS
$\pi/4$ -DQPSK	2441	1.172	---	PASS
$\pi/4$ -DQPSK	2480	1.172	---	PASS
8DPSK	2402	1.172	---	PASS
8DPSK	2441	1.172	---	PASS
8DPSK	2480	1.172	---	PASS

Test Graphs

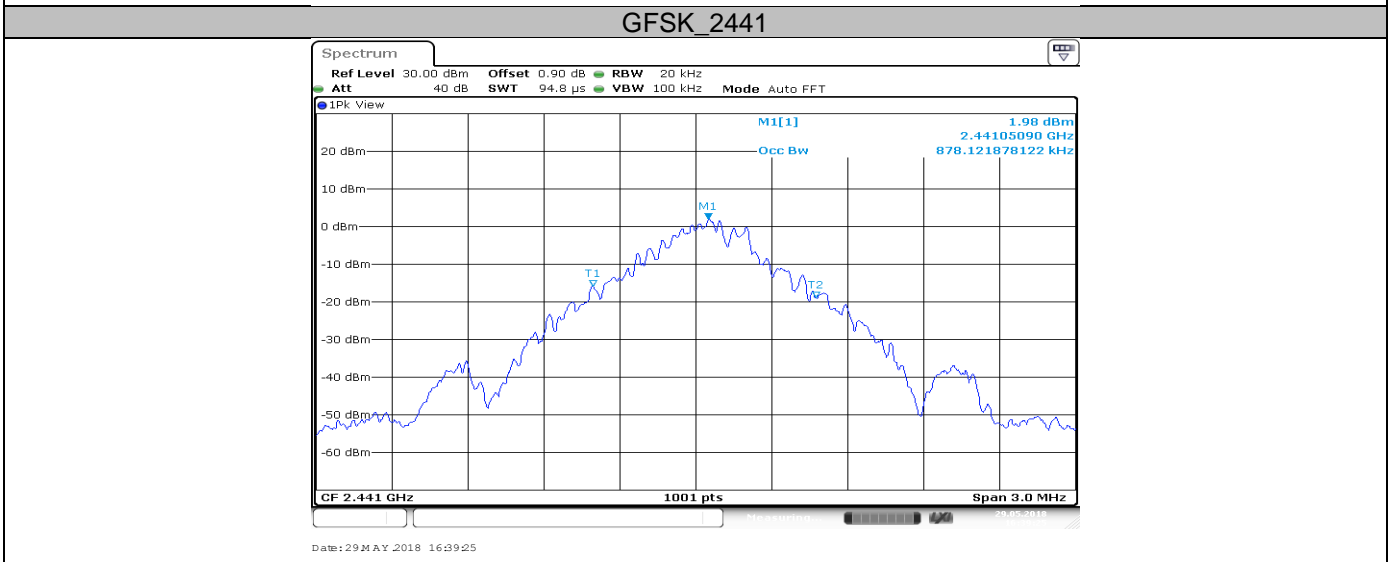
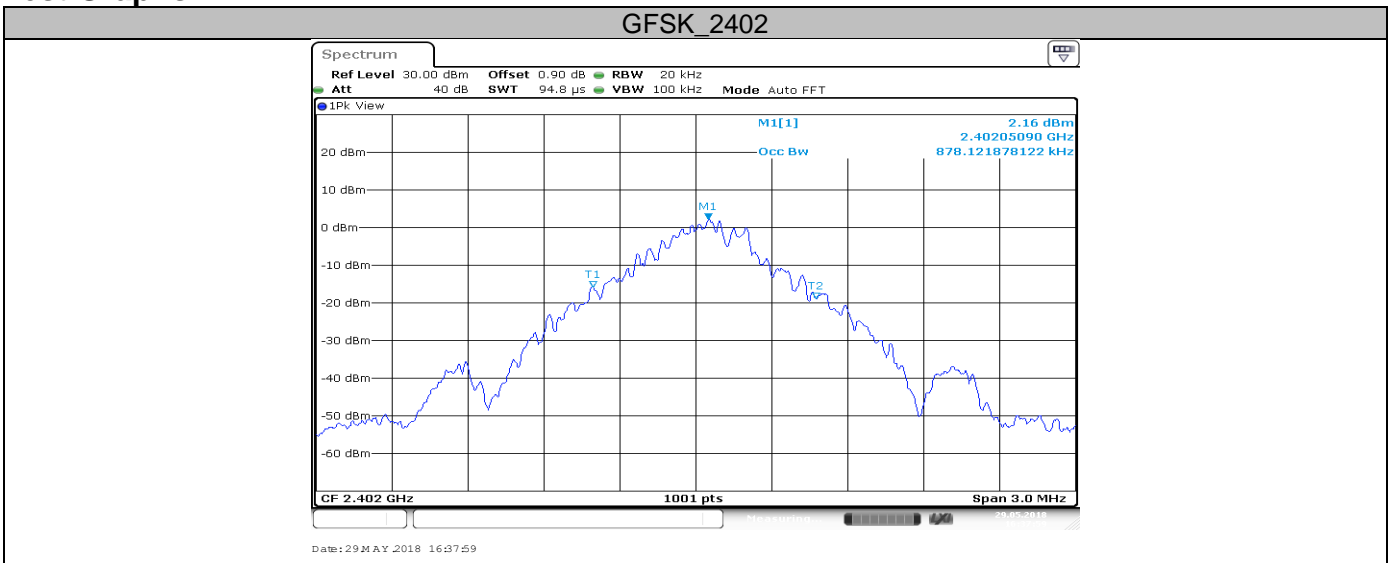



GFSK_2480

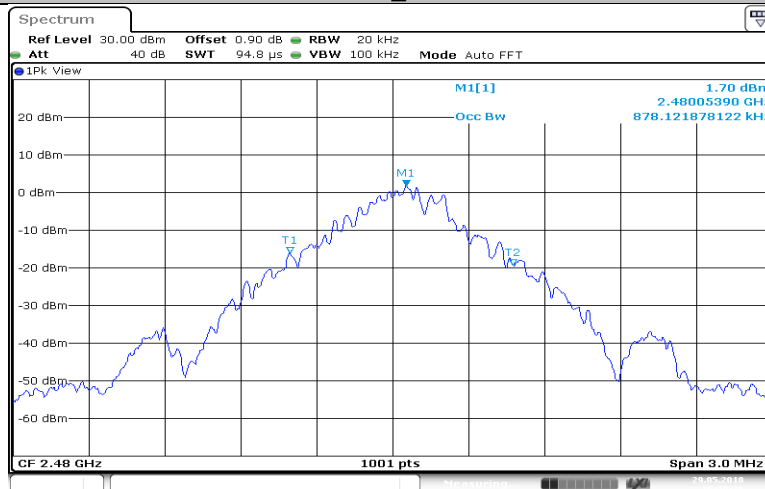

Date: 29 MAY 2018 16:40:37

$\pi/4$ -DQPSK_2402

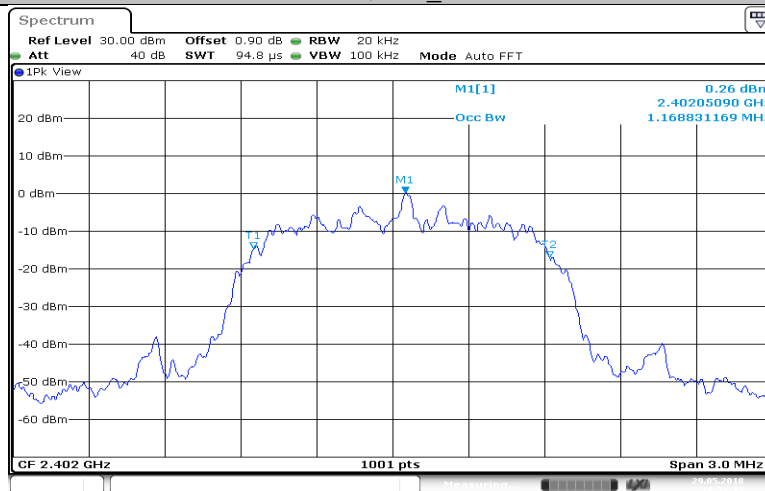

Date: 29 MAY 2018 16:52:15

$\pi/4$ -DQPSK_2441

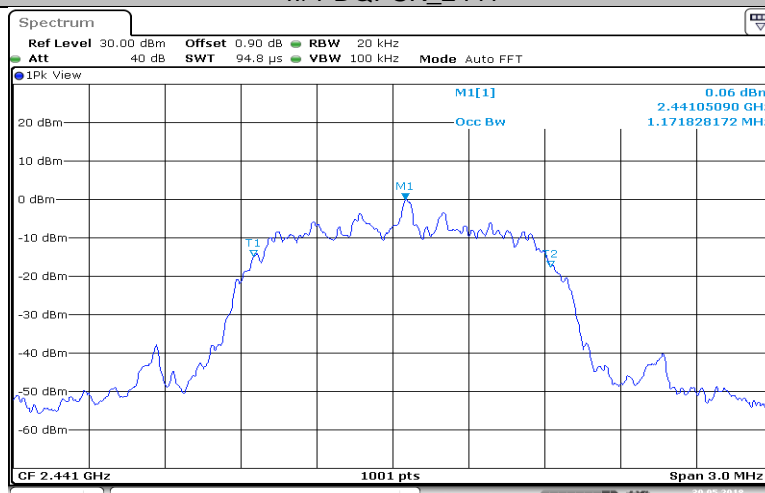

Date: 30 MAY 2018 10:46:32

$\pi/4$ -DQPSK_2480

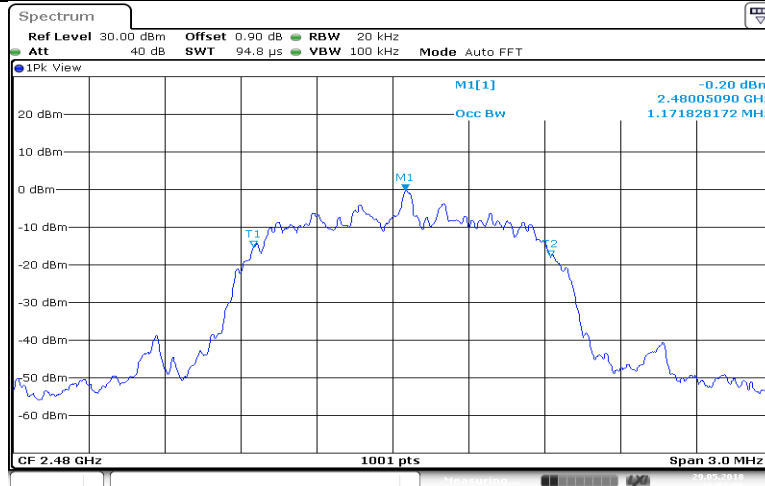

Date: 29 MAY 2018 16:57:06

8DPSK_2402

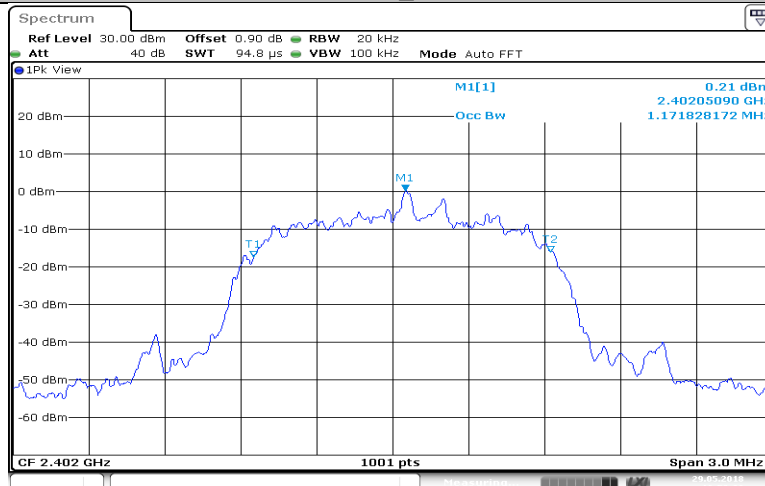

Date: 29 MAY 2018 16:58:39

8DPSK_2441

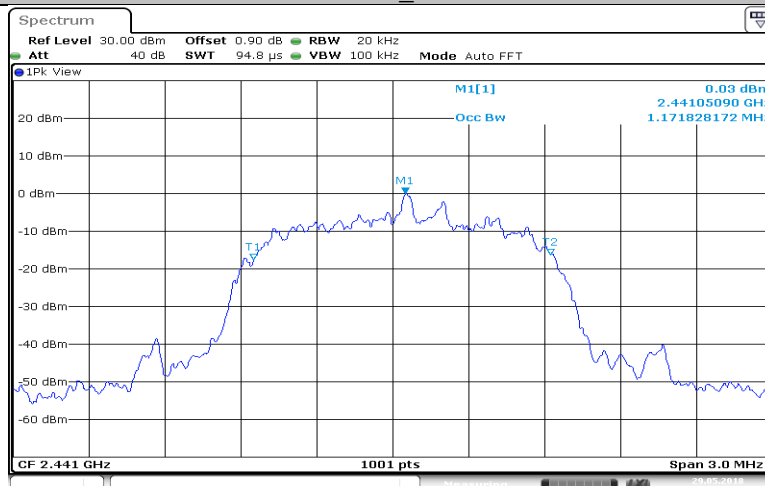

Date: 29 MAY 2018 17:01:21

8DPSK_2480

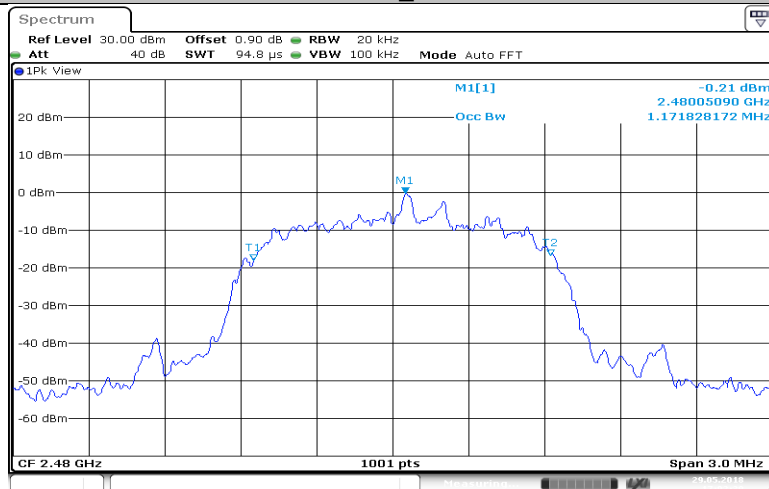

Date: 29 MAY 2018 17:02:40



9.5 Carrier Frequency Separation

Test Method

1. Use the following spectrum analyzer settings:
Span = wide enough to capture the peaks of two adjacent channels, RBW \geq 1% of the span, VBW) \geq RBW, Sweep = auto, Detector function = peak
2. By using the Max-Hold function record the separation of two adjacent channels.
3. Measure the frequency difference of these two adjacent channels by spectrum analyzer marker function.
4. Repeat above procedures until all frequencies measured were complete.

Limit

Limit kHz
$\geq 25\text{kHz}$ or 2/3 of the 20 dB bandwidth which is greater

GFSK Modulation Limit

Frequency MHz	2/3 of 20 dB Bandwidth kHz
2402	748.00
2441	748.00
2480	748.00

Carrier Frequency Separation

Test Mode	Channel (MHz)	Result (MHz)	Limit	Verdict
GFSK	Hop	0.997	0.748	PASS
$\pi/4$ -DQPSK	Hop	1.003	0.914	PASS
8DPSK	Hop	1.000	0.918	PASS

Test Graphs

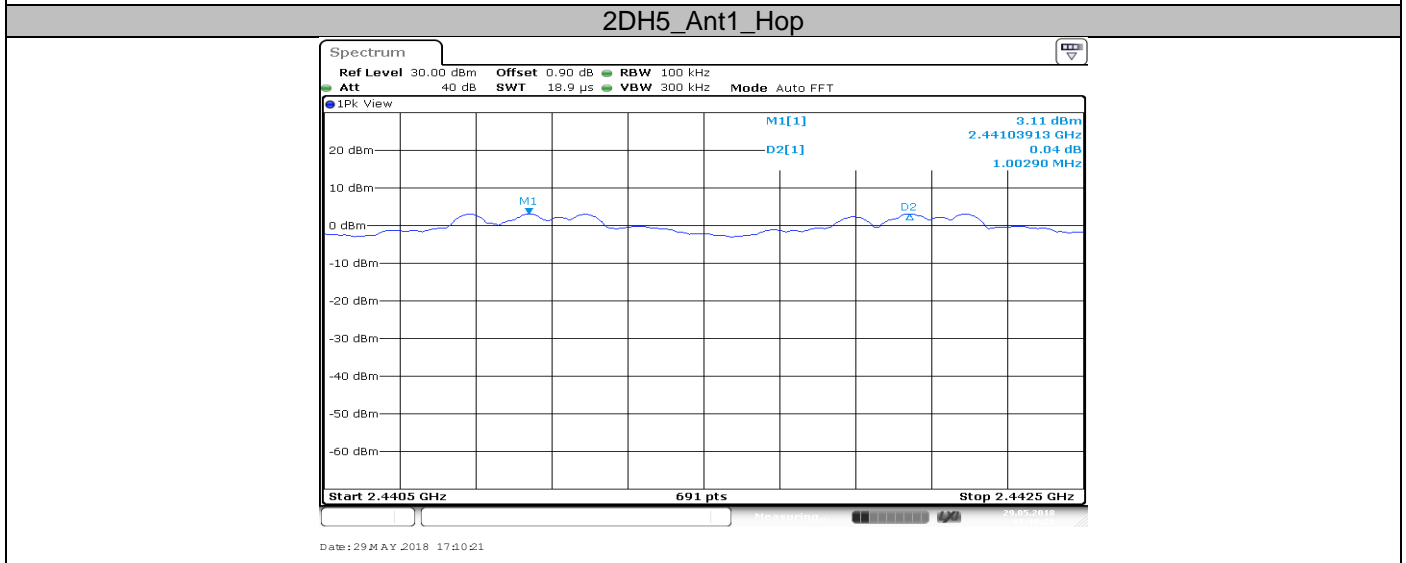
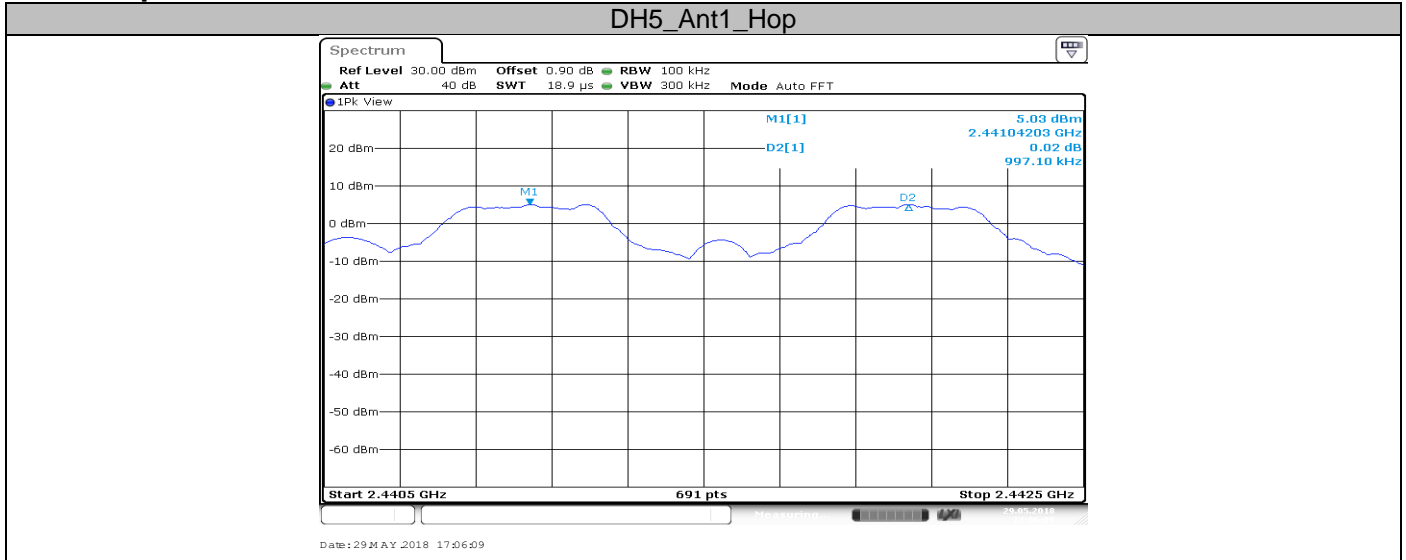

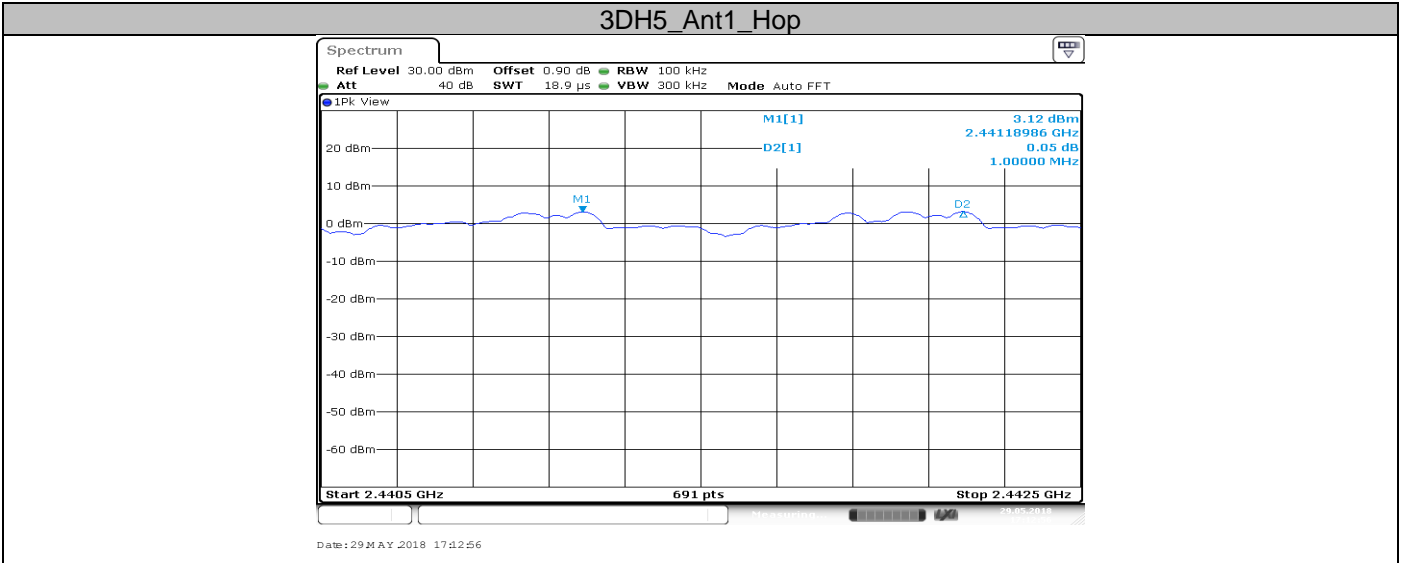

9.6 Number of hopping frequencies

Test Method

1. Use the following spectrum analyzer settings:
Span = wide enough to capture the peaks of two adjacent channels, RBW \geq 1% of the span, VBW \geq RBW, Sweep = auto, Detector function = peak
2. Set the spectrum analyzer on Max-Hold Mode, and then keep the EUT in hopping mode.
3. Record all the signals from each channel until each one has been recorded.
4. Repeat above procedures until all frequencies measured were complete.

Limit

**Limit
number**
—————
 ≥ 15

Number of hopping frequencies

Test Mode	Channel	Result (Channel)	Limit (Channel)	Verdict
GFSK	Hop	79	15	PASS
$\pi/4$ -DQPSK	Hop	79	15	PASS
8DPSK	Hop	79	15	PASS

Test Graphs

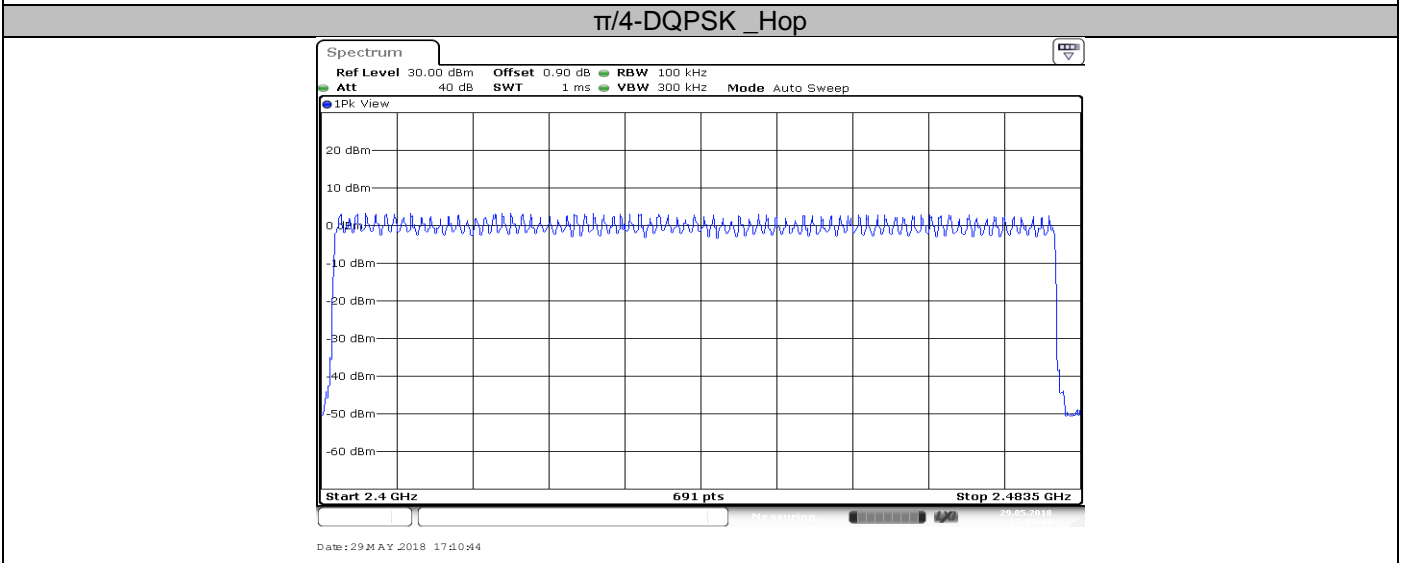
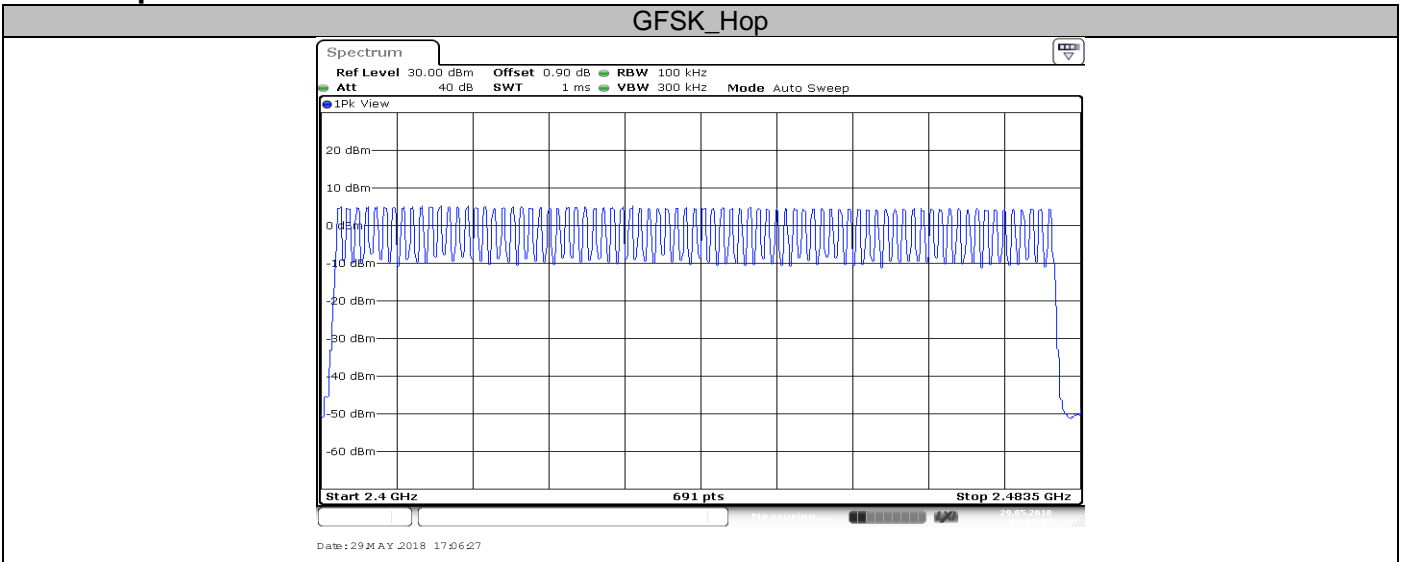

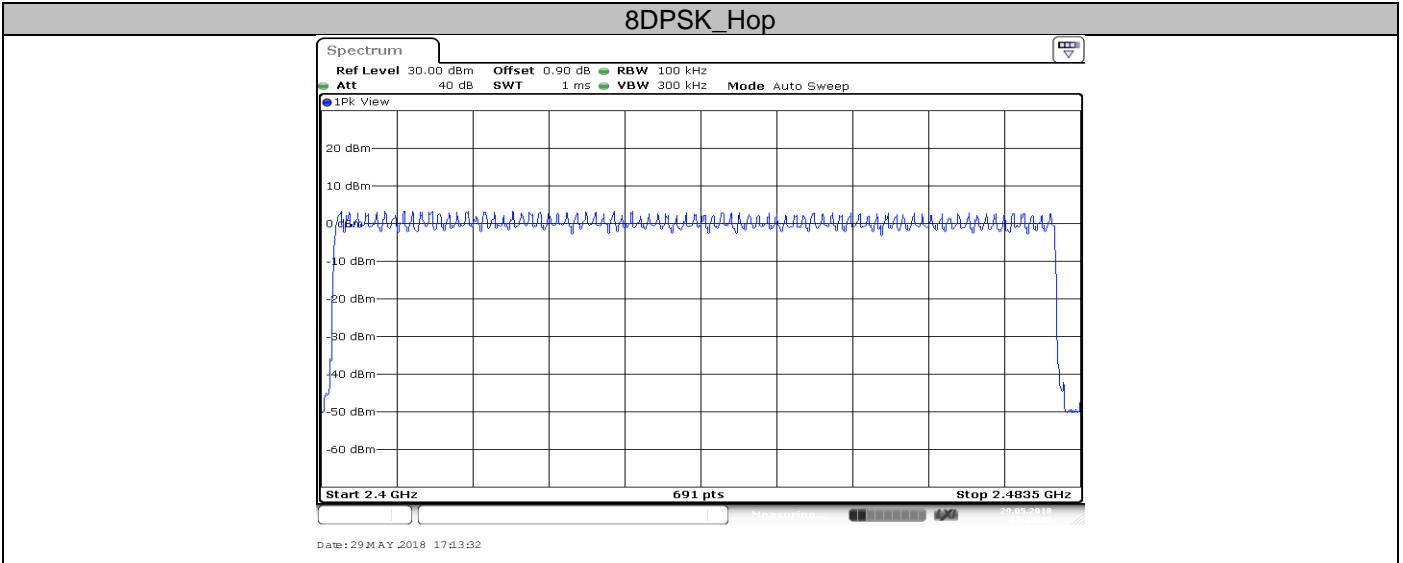

9.7 Dwell Time

Test Method

1. Connect EUT antenna terminal to the spectrum analyzer with a low loss cable.
Equipment mode: Spectrum analyzer
2. RBW: 1MHz; VBW: 1MHz; SPAN: Zero Span
3. Adjust the center frequency of spectrum analyzer on any frequency be measured.
4. Measure the Dwell Time by spectrum analyzer Marker function.
5. Repeat above procedures until all frequencies measured were complete.

Limit

The average time of occupancy on any frequency shall not be greater than 0.4 seconds within a period of 0.4 seconds multiplied by the number of hopping channels employed.

Dwell Time

Dwell time

The maximum dwell time shall be 0.4 s.

According to the Bluetooth Core Specification, the worse result (DH5 mode) was reported to show compliance.

The Dwell Time = Burst Width * Total Hops. The detailed calculations are showed as follows:

The duration for dwell time calculation: 0.4 [s] * hopping number = 0.4 [s] * 79 [ch] = 31.6 [s*ch];

The burst width, which is directly measured, refers to the duration on one channel hop.

The maximum number of hopping channels in 31.6s for DH5=1600 / 6 / 79 *31.6=106.67

Test Result

Test Mode	Channel	Burst Width (ms)	Total Hops	Result (s)	Limit (s)	Verdict
GFSK	Hop	2.87	80	0.229	0.4	PASS
$\pi/4$ -DQPSK	Hop	2.87	130	0.373	0.4	PASS
8-DPSK	Hop	2.87	70	0.201	0.4	PASS

Test Graphs

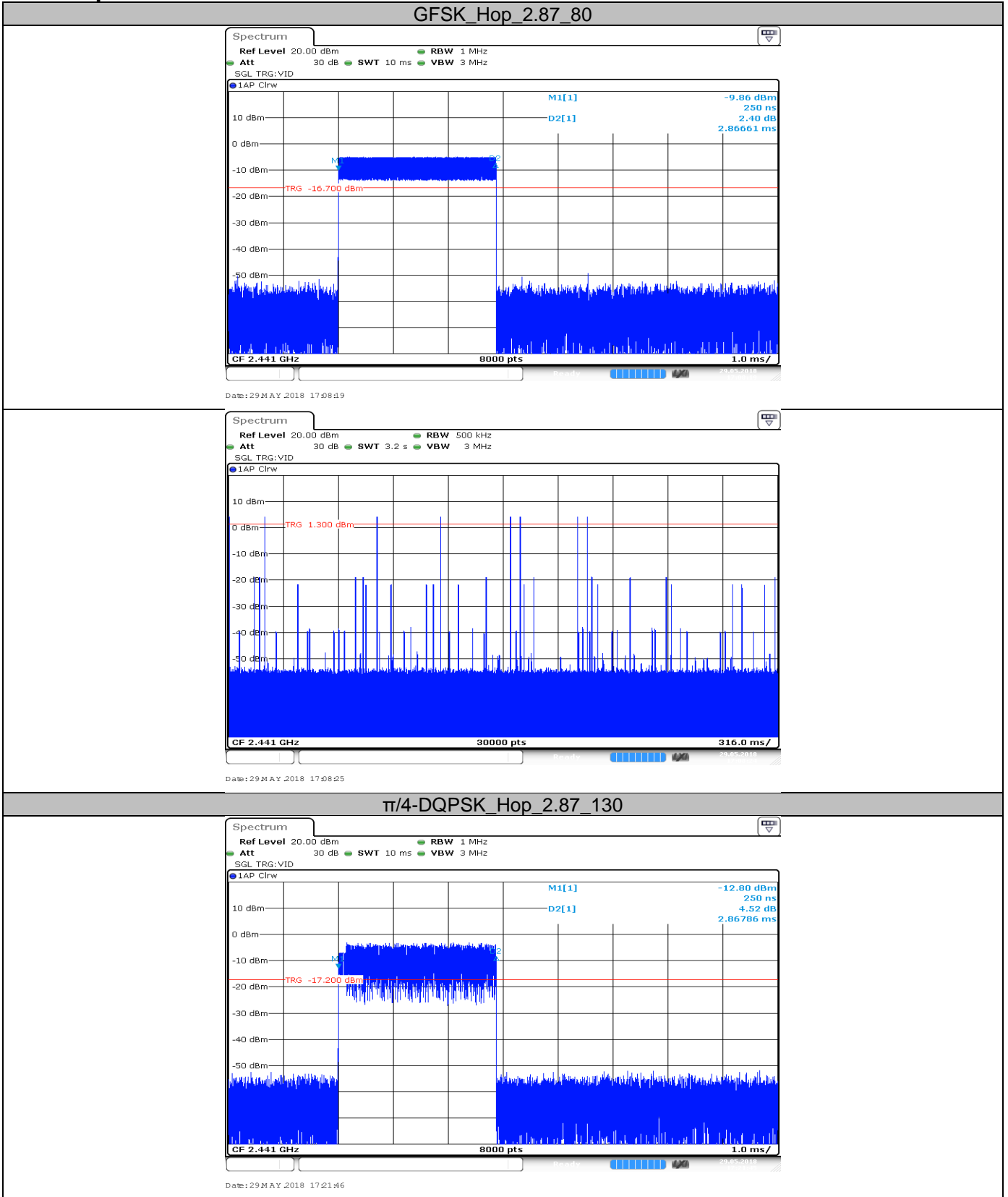

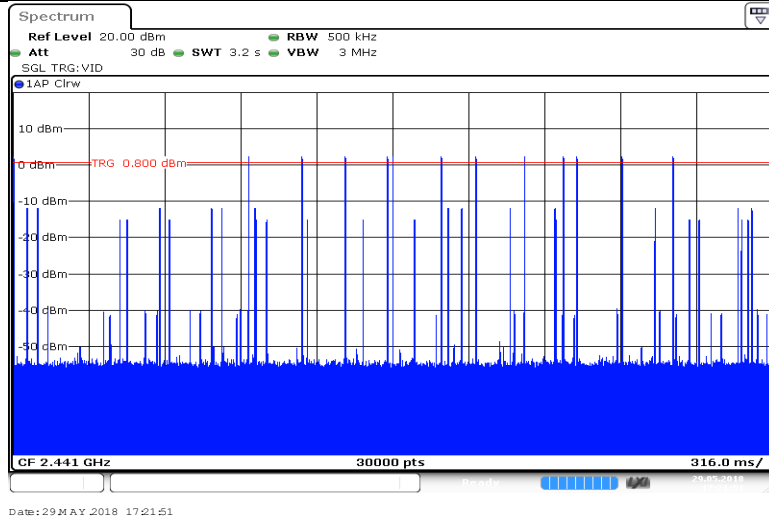

8-DPSK_Hop_2.87_70

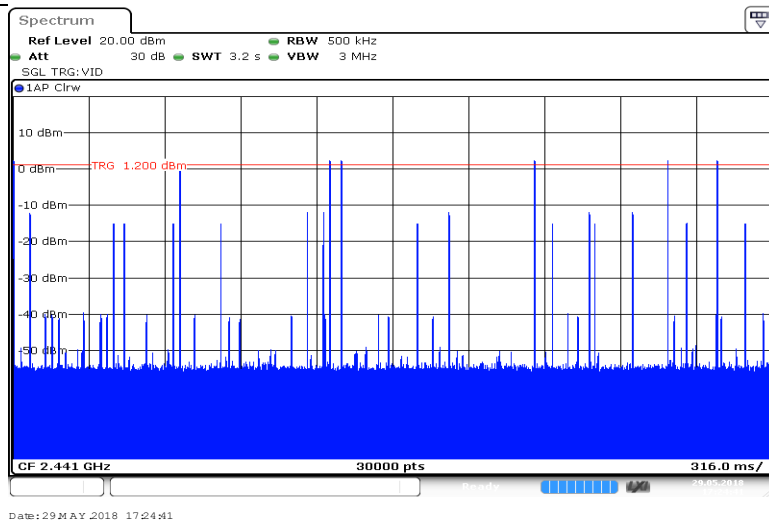
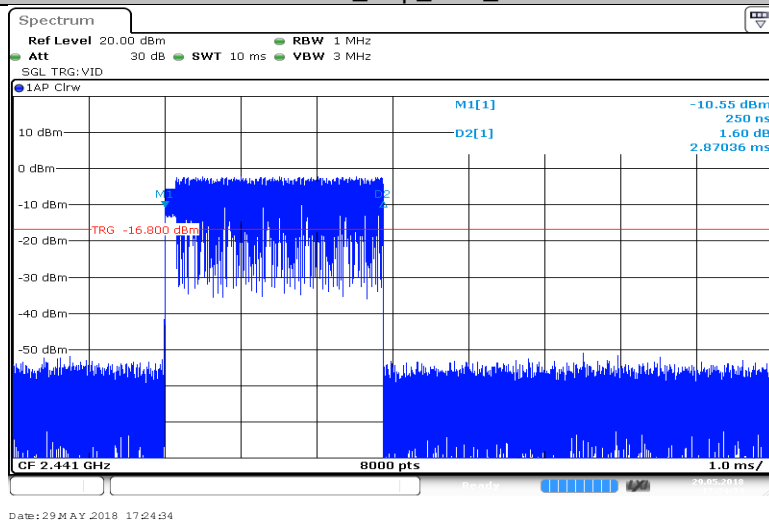



9.8 Spurious RF conducted emissions

Test Method

1. Use the following spectrum analyzer settings:
 Span = wide enough to capture the peak level of the in-band emission and all spurious emissions (e.g., harmonics) from the lowest frequency generated in the EUT up through the 10th harmonic. Typically, several plots are required to cover this entire span.
 RBW = 100 kHz, VBW ≥ RBW, Sweep = auto, Detector function = peak, Trace = max hold
2. Allow the trace to stabilize. Set the marker on the peak of any spurious emission recorded.
3. The level displayed must comply with the limit specified in this Section. Submit these plots.
4. Repeat above procedures until all frequencies measured were complete.

Limit

Frequency Range MHz	Limit (dBc)
30-25000	-20

Spurious RF conducted emissions

Test Result

Test Mode	Channel (MHz)	Freq Range (MHz)	Result (dBm)	Limit (dBm)	Verdict
GFSK	2402	30~1000	-69.31	-14.7	PASS
GFSK	2402	1000~26500	-42.17	-14.7	PASS
GFSK	2441	30~1000	-69.11	-14.88	PASS
GFSK	2441	1000~26500	-42.86	-14.88	PASS
GFSK	2480	30~1000	-69.59	-15.11	PASS
GFSK	2480	1000~26500	-43.46	-15.11	PASS
$\pi/4$ -DQPSK	2402	30~1000	-69.09	-16.64	PASS
$\pi/4$ -DQPSK	2402	1000~26500	-43.24	-16.64	PASS
$\pi/4$ -DQPSK	2441	30~1000	-69.17	-16.86	PASS
$\pi/4$ -DQPSK	2441	1000~26500	-43.45	-16.86	PASS
$\pi/4$ -DQPSK	2480	30~1000	-67.82	-17.08	PASS
$\pi/4$ -DQPSK	2480	1000~26500	-43.14	-17.08	PASS
8-DPSK	2402	30~1000	-68.74	-16.63	PASS
8-DPSK	2402	1000~26500	-43.41	-16.63	PASS
8-DPSK	2441	30~1000	-69.05	-16.84	PASS
8-DPSK	2441	1000~26500	-43.47	-16.84	PASS
8-DPSK	2480	30~1000	-68.15	-17.06	PASS
8-DPSK	2480	1000~26500	-43.74	-17.06	PASS

Test Graphs

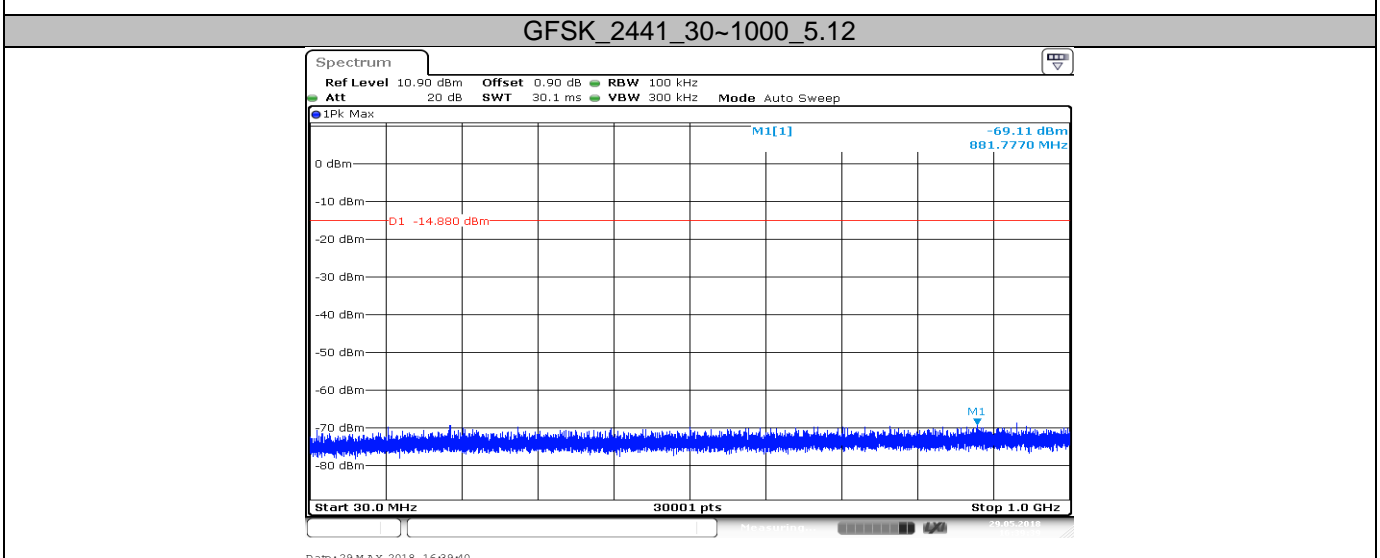
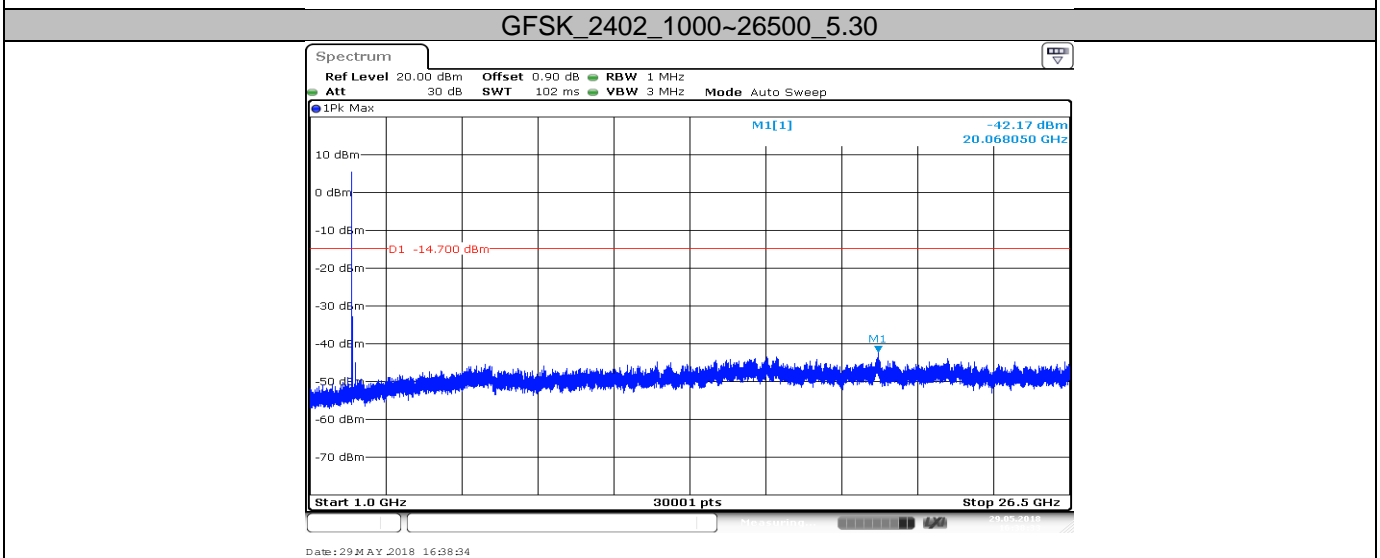
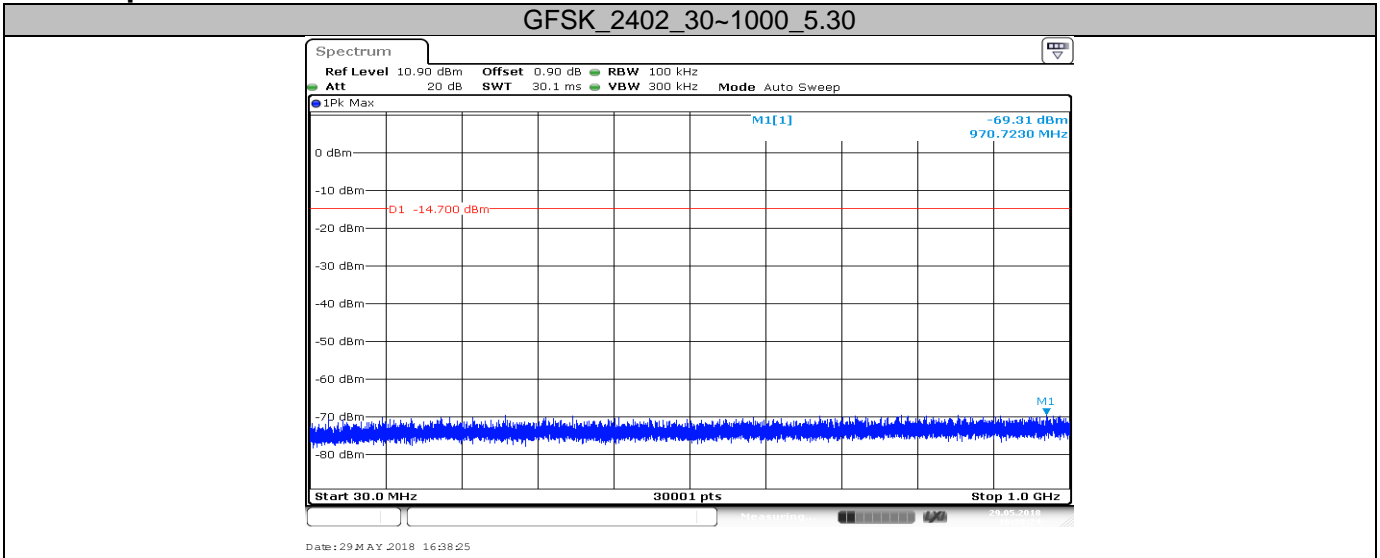

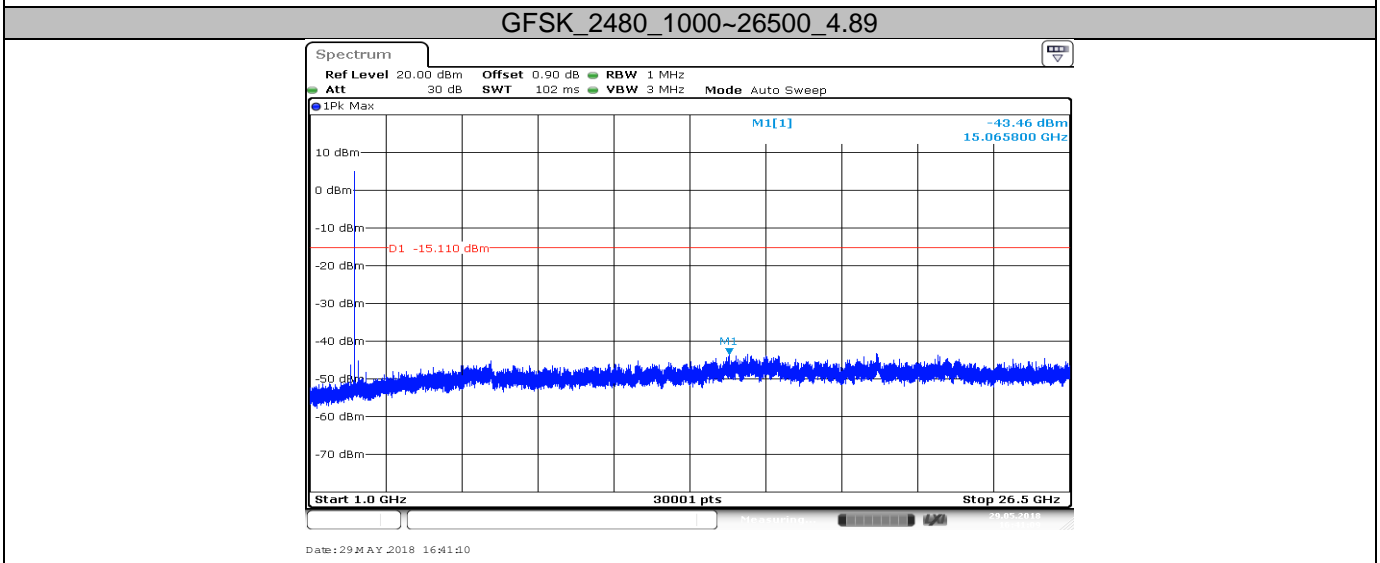
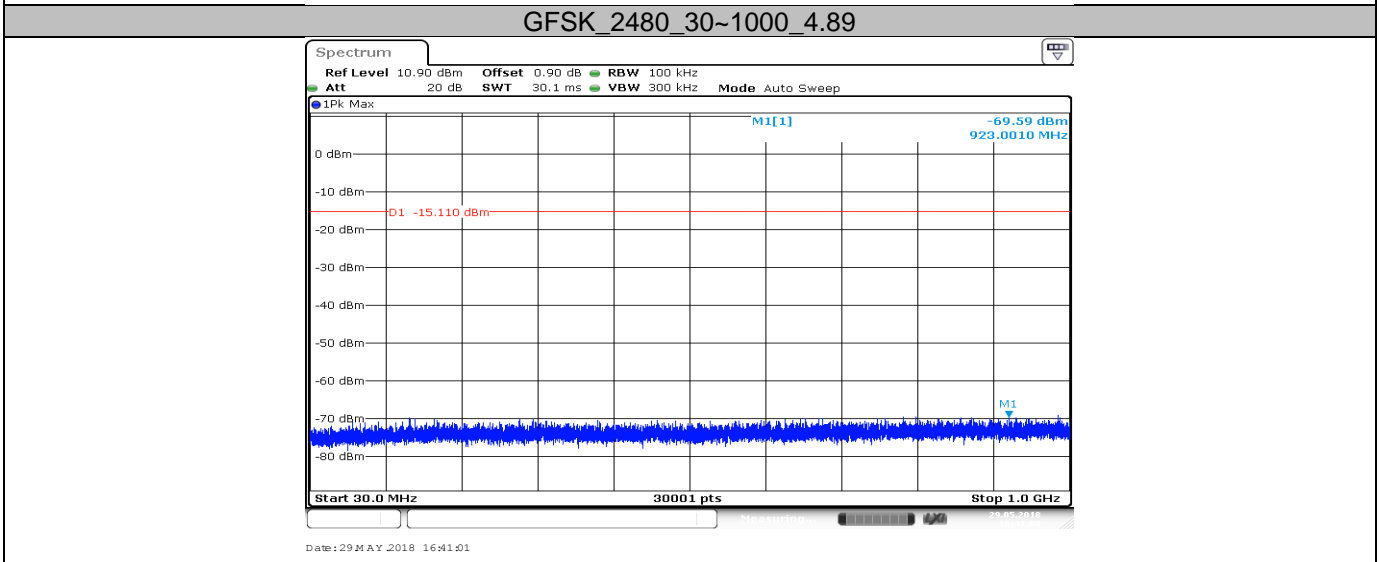
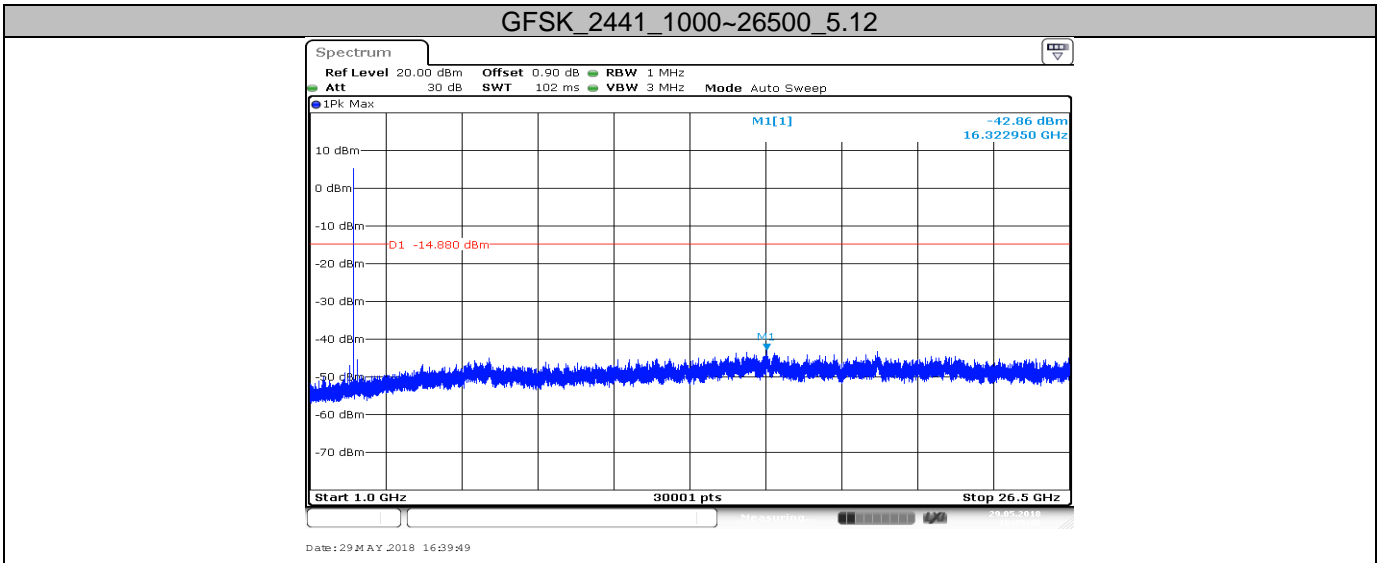

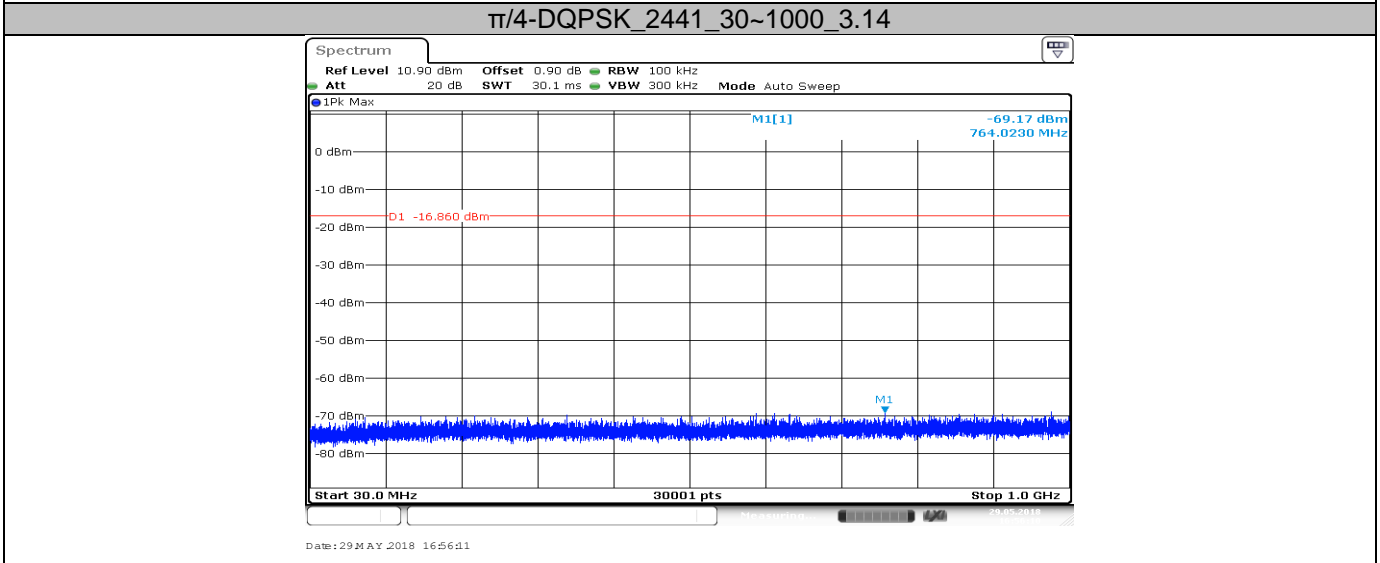
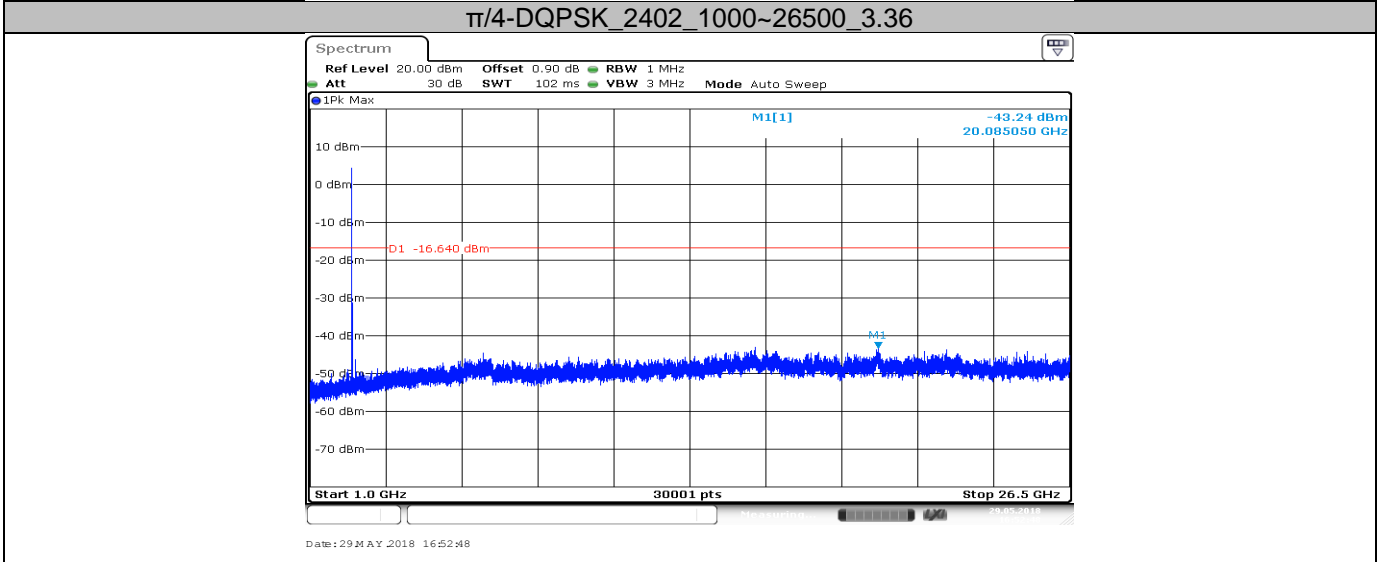
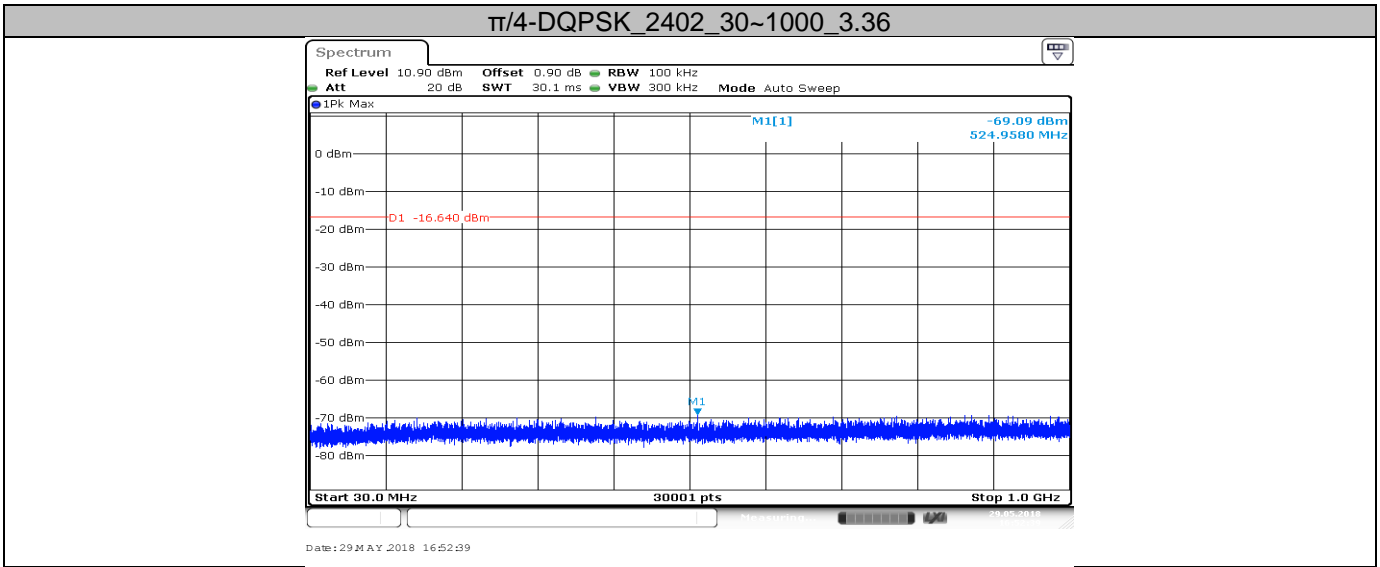



$\pi/4$ -DQPSK_2441_1000~26500_3.14

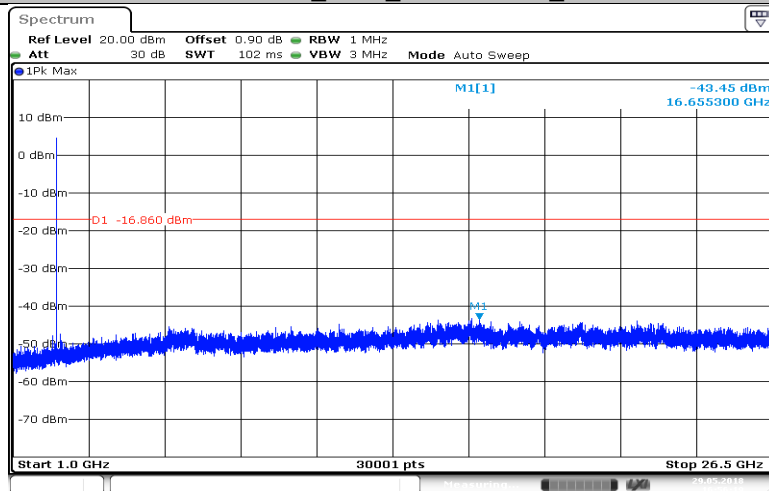

Date: 29 MAY 2018 16:56:20

$\pi/4$ -DQPSK_2480_30~1000_2.92

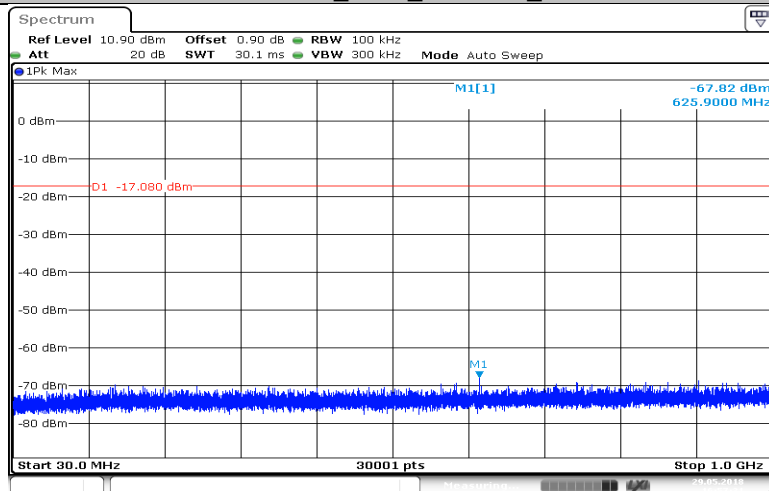

Date: 29 MAY 2018 16:57:31

$\pi/4$ -DQPSK_2480_1000~26500_2.92

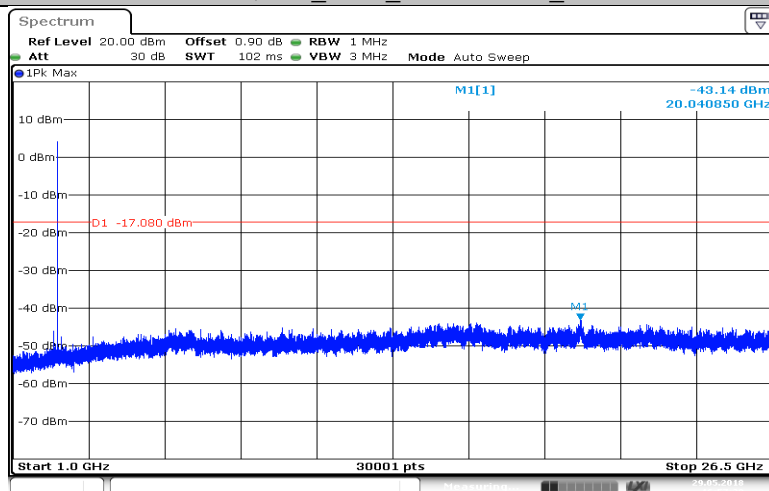

Date: 29 MAY 2018 16:57:40

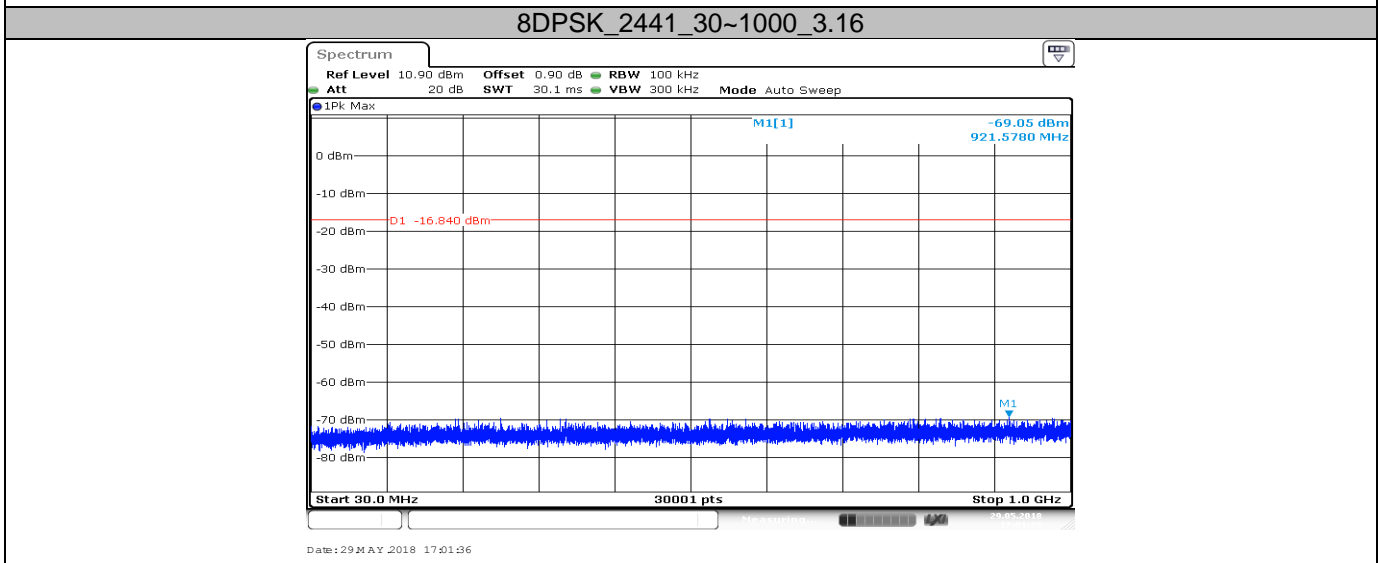
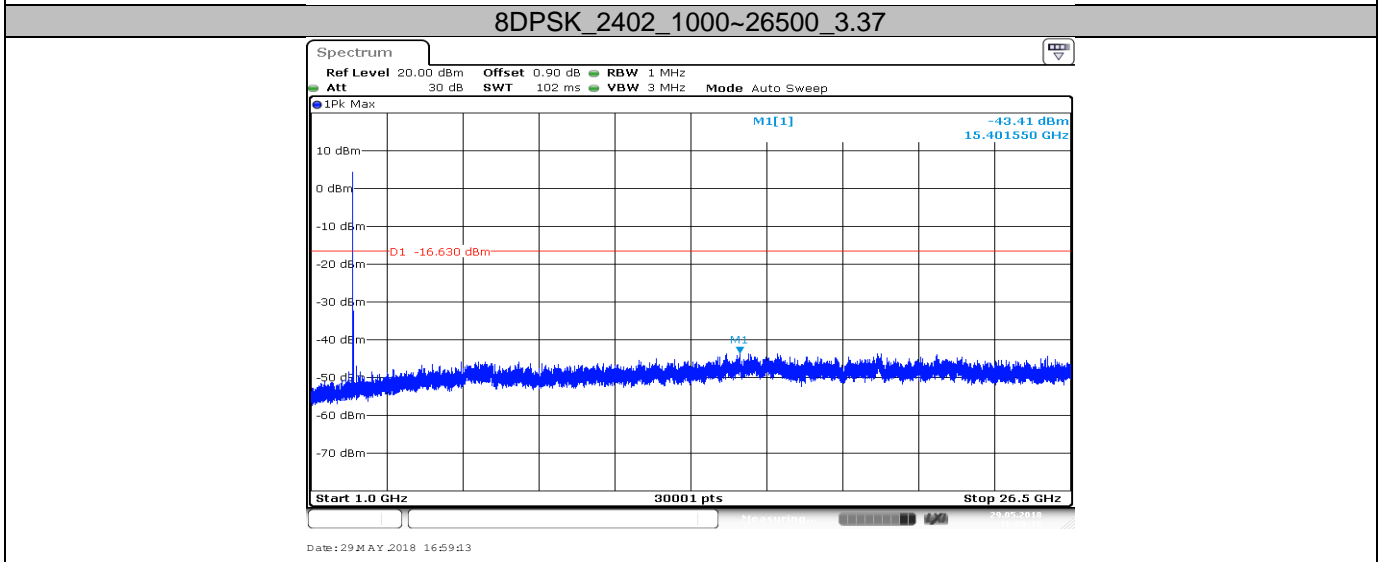
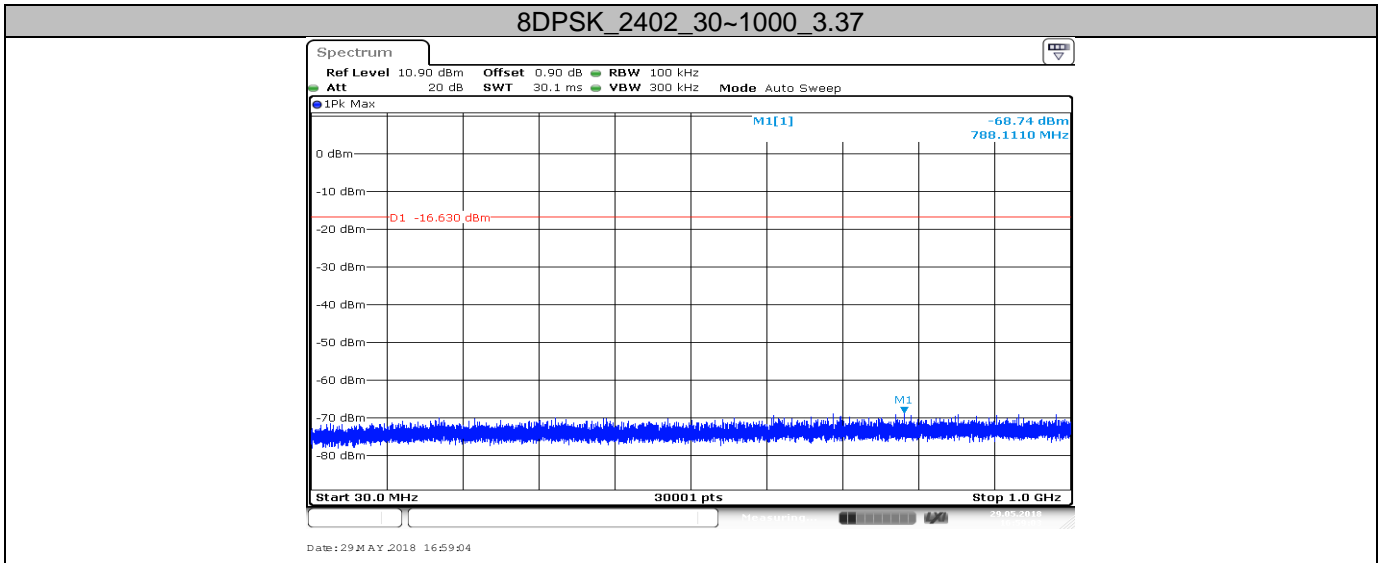

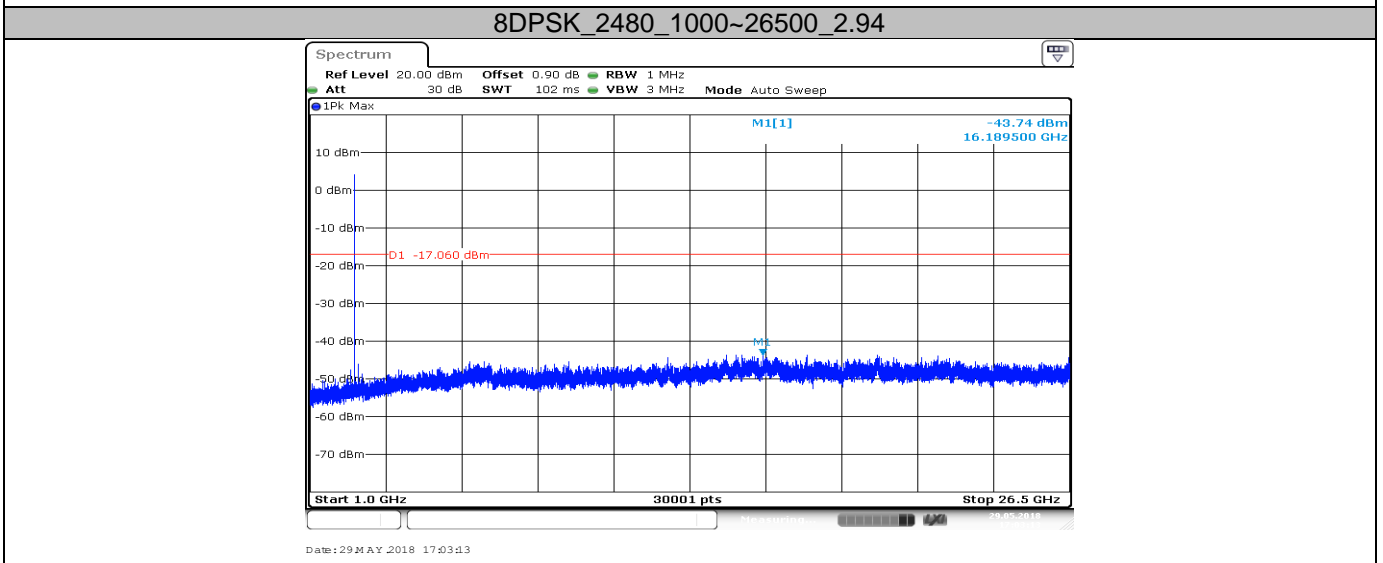
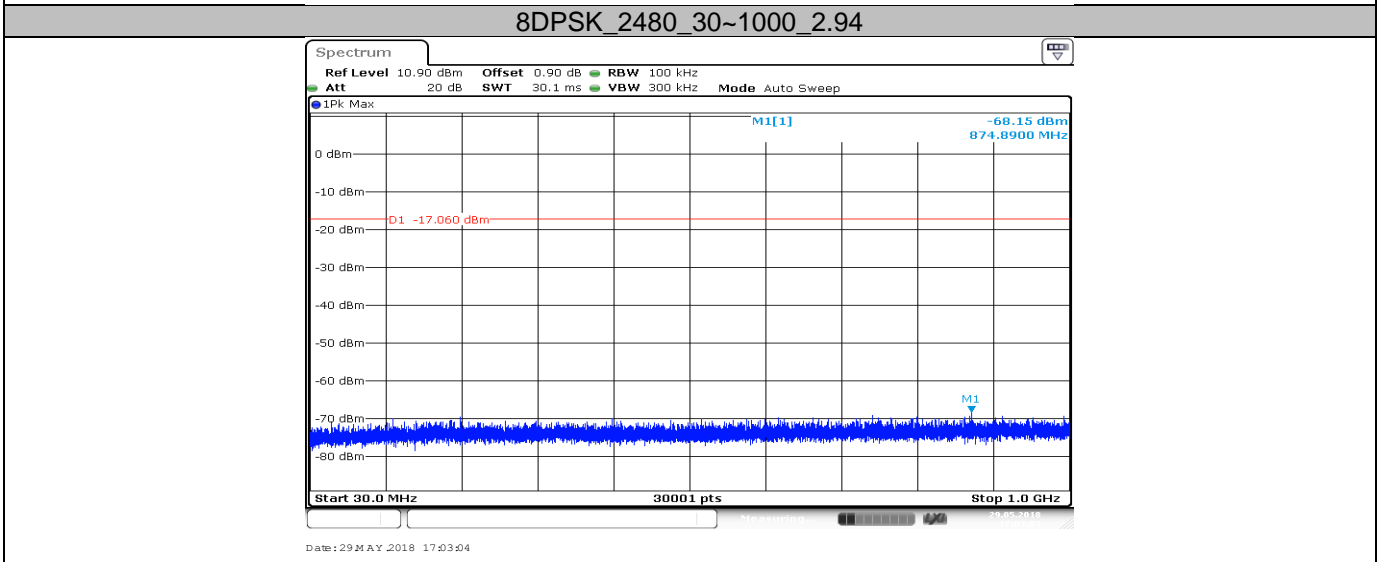
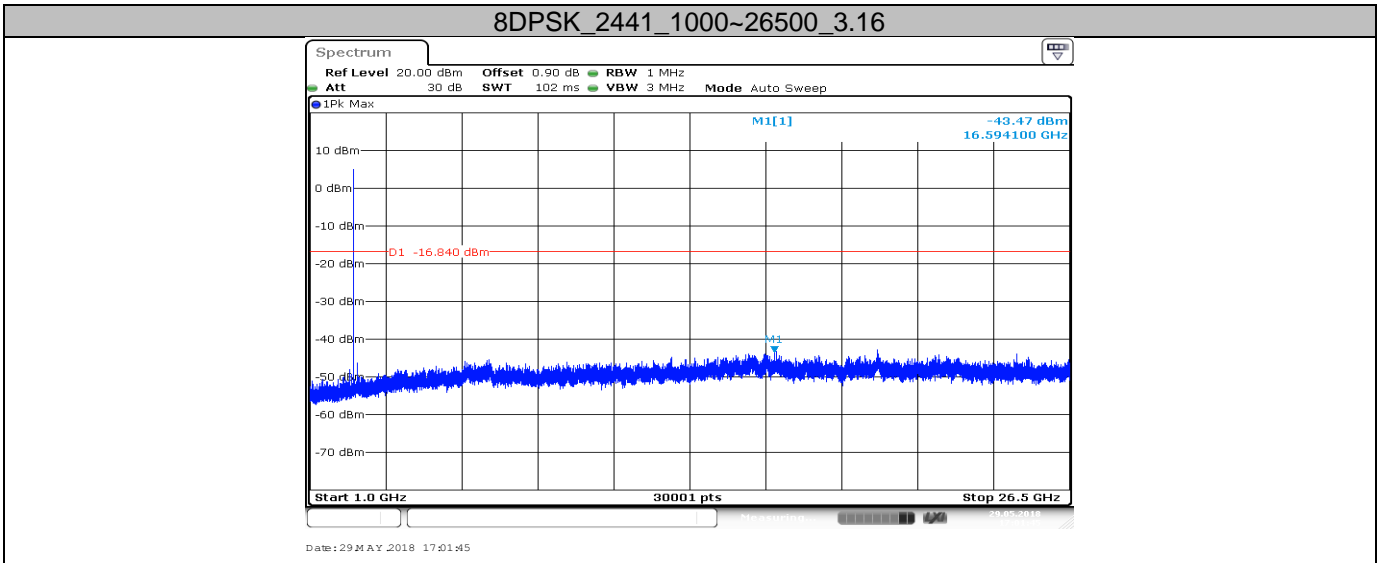

9.9 Band edge testing

Test Method

- 1 Use the following spectrum analyzer settings:
Span = wide enough to capture the peak level of the in-band emission and all spurious
RBW = 100 kHz, VBW \geq RBW, Sweep = auto, Detector function = peak, Trace = max hold
- 2 Allow the trace to stabilize, use the peak and delta measurement to record the result.
- 3 The level displayed must comply with the limit specified in this Section. .
- 4 Repeat the test at the hopping off and hopping on mode, submit all the plots.

Limit:

In any 100 kHz bandwidth outside the frequency band in which the spread spectrum or digitally modulated device is operating, the RF power that is produced shall be at least 20 dB below that in the 100 kHz bandwidth within the band that contains the highest level of the desired power, based on either an RF conducted or a radiated measurement, provided that the transmitter demonstrates compliance with the peak conducted power limits.

Test Result:

Test Mode	Ch Name	Channel (MHz)	Result (dBm)	Limit (dBm)	Verdict
GFSK	Low	2402	-53.04	-24.7	PASS
GFSK	High	2480	-53.89	-25.2	PASS
GFSK	Low	Hop_2402	-49.95	-25.5	PASS
GFSK	High	Hop_2480	-53.79	-25.53	PASS
$\pi/4$ -DQPSK	Low	2402	-57.45	-26.73	PASS
$\pi/4$ -DQPSK	High	2480	-49.53	-27.2	PASS
$\pi/4$ -DQPSK	Low	Hop_2402	-52.72	-26.6	PASS
$\pi/4$ -DQPSK	High	Hop_2480	-53.54	-27.86	PASS
8DPSK	Low	2402	-56.63	-26.63	PASS
8DPSK	High	2480	-53.73	-27.13	PASS
8DPSK	Low	Hop_2402	-53.43	-29.19	PASS
8DPSK	High	Hop_2480	-54.97	-27.33	PASS

Test Graphs

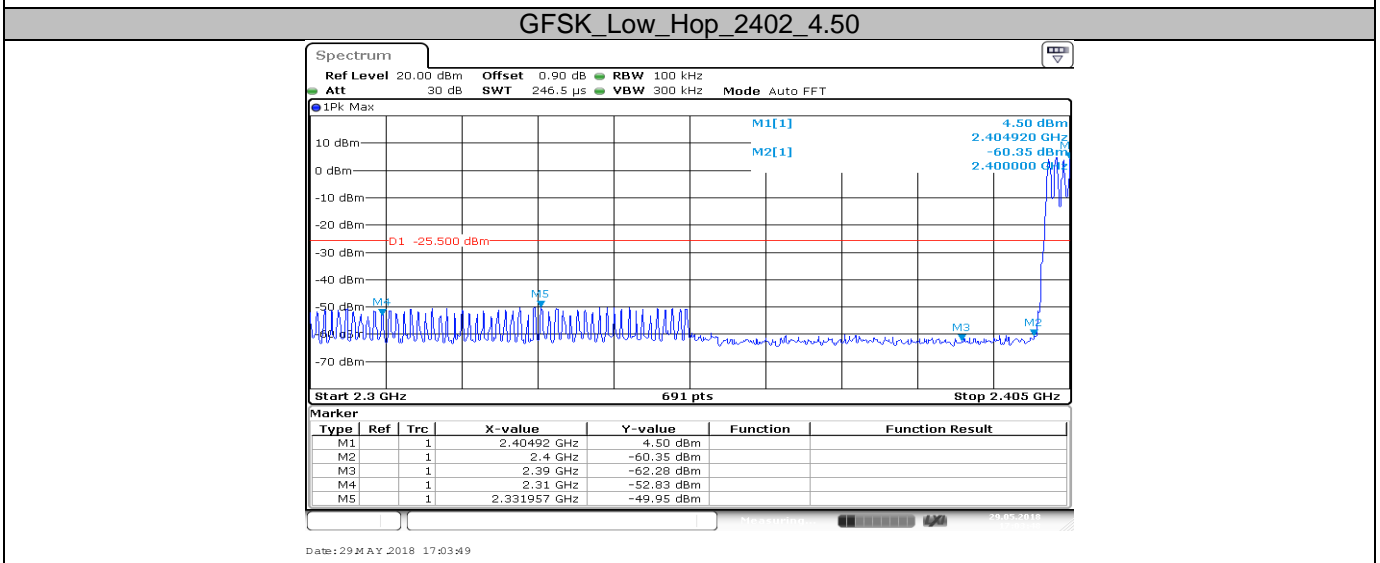
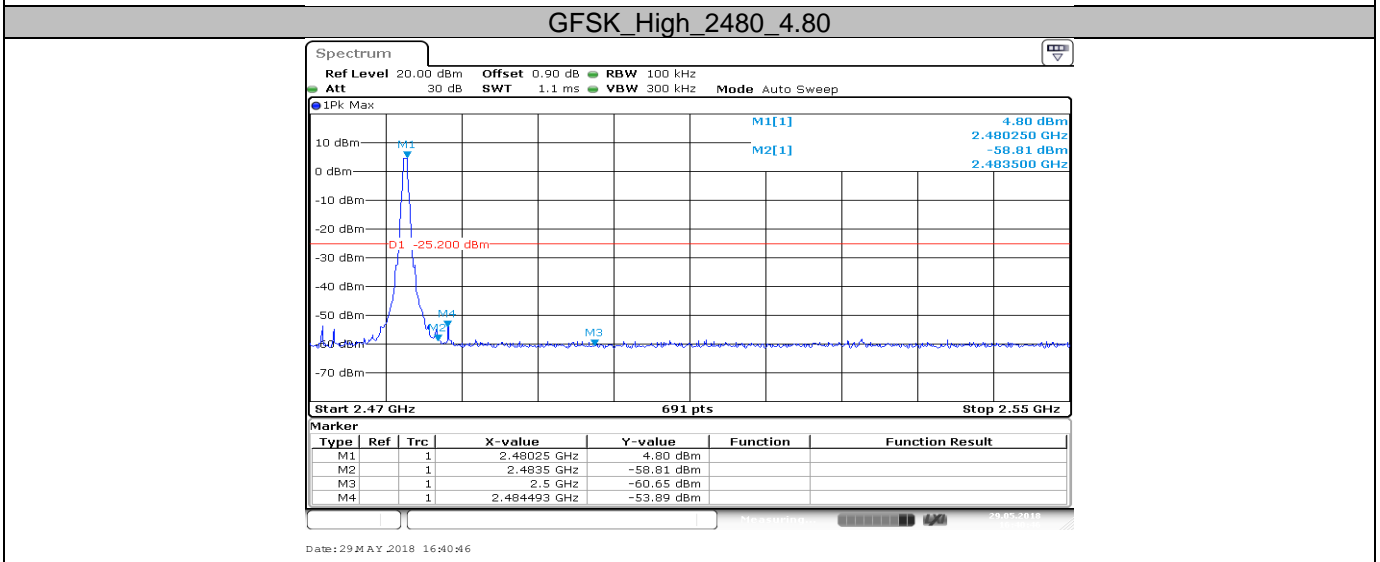
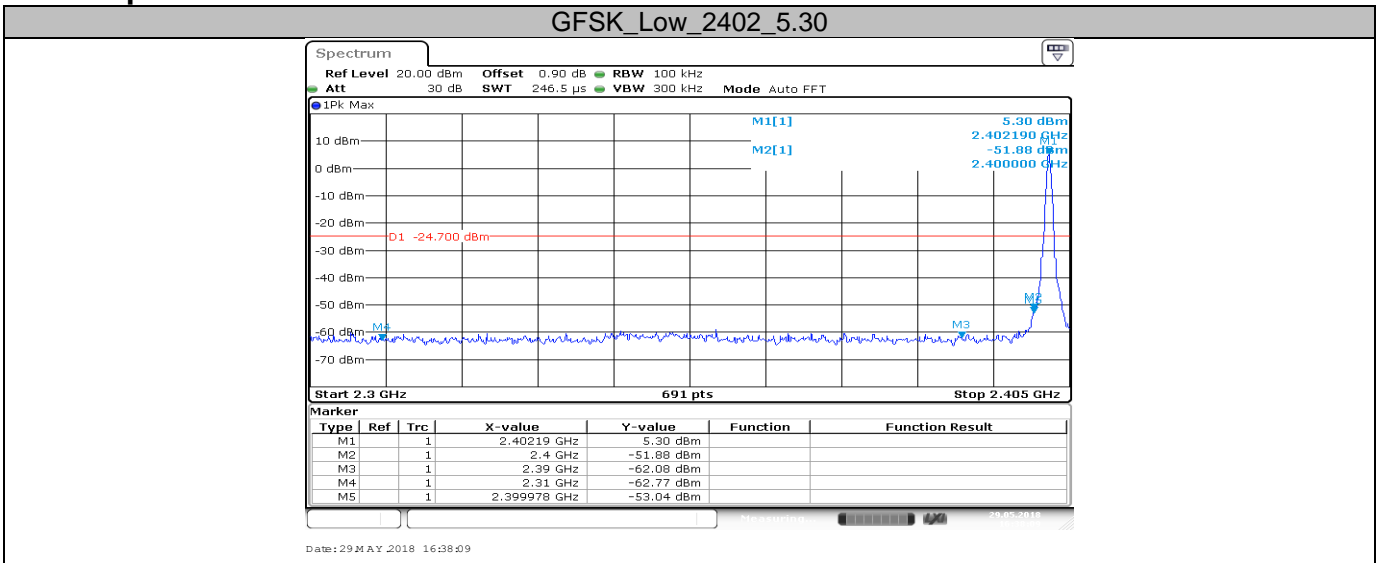

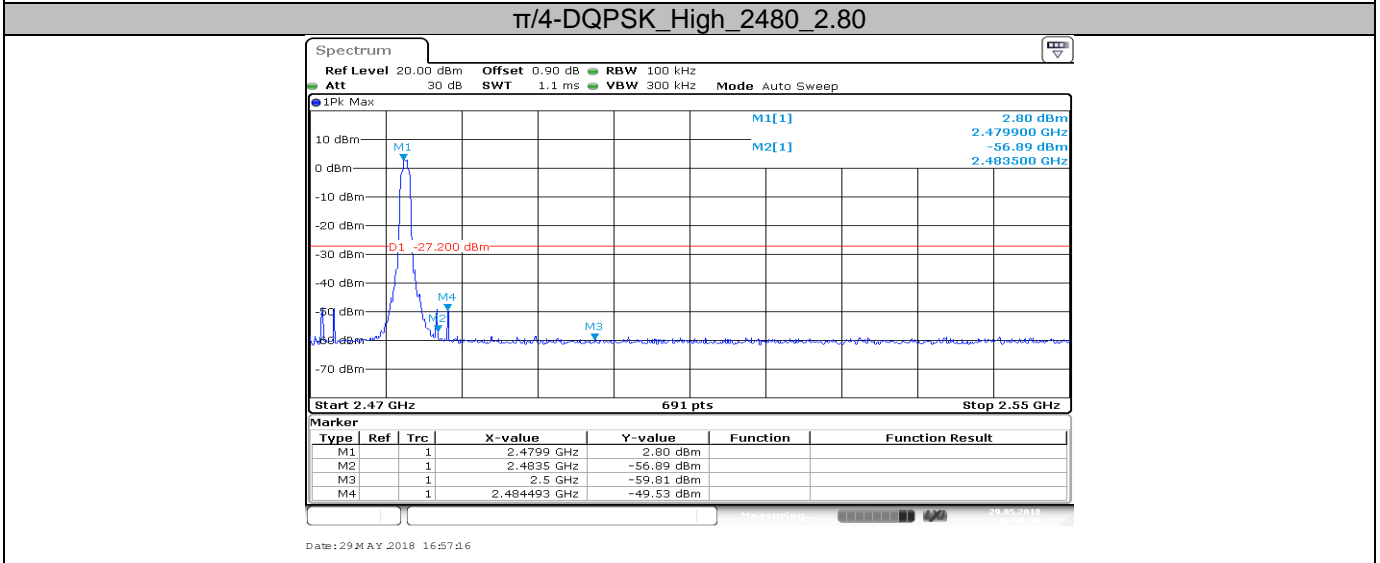
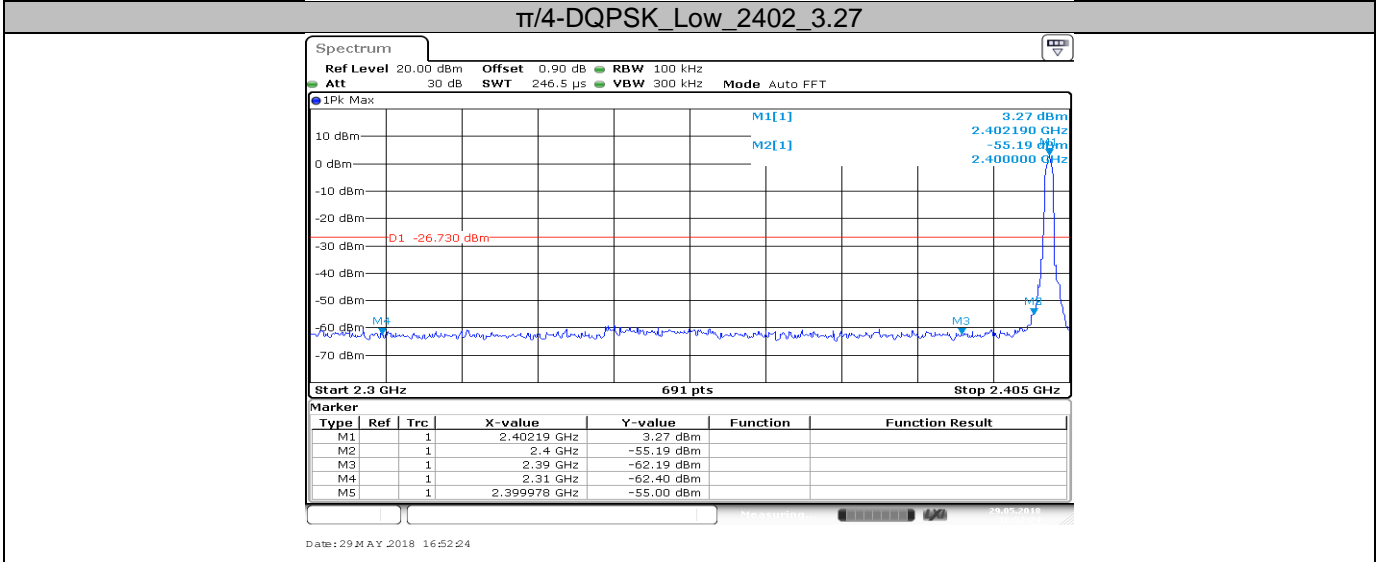
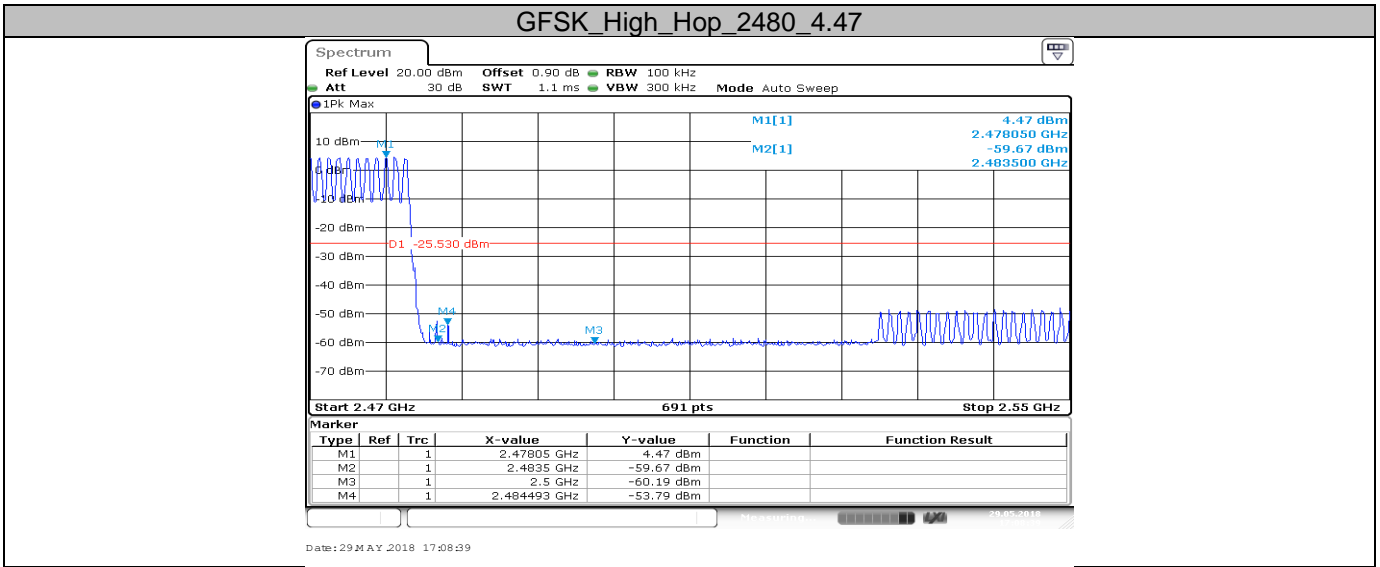

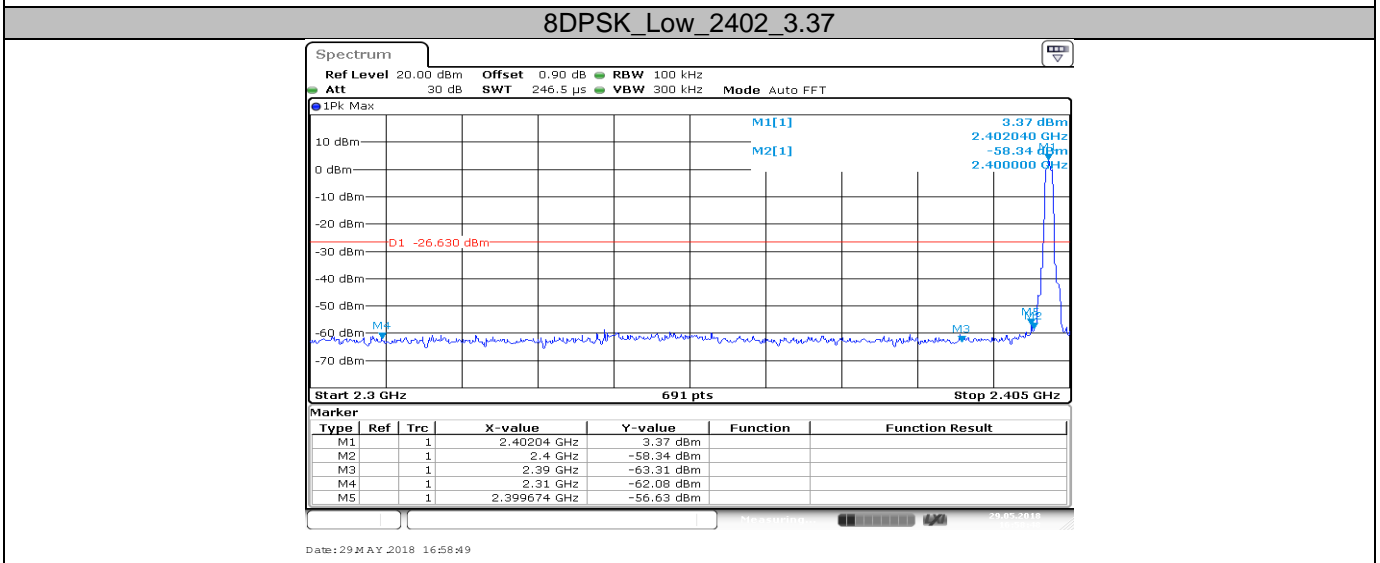
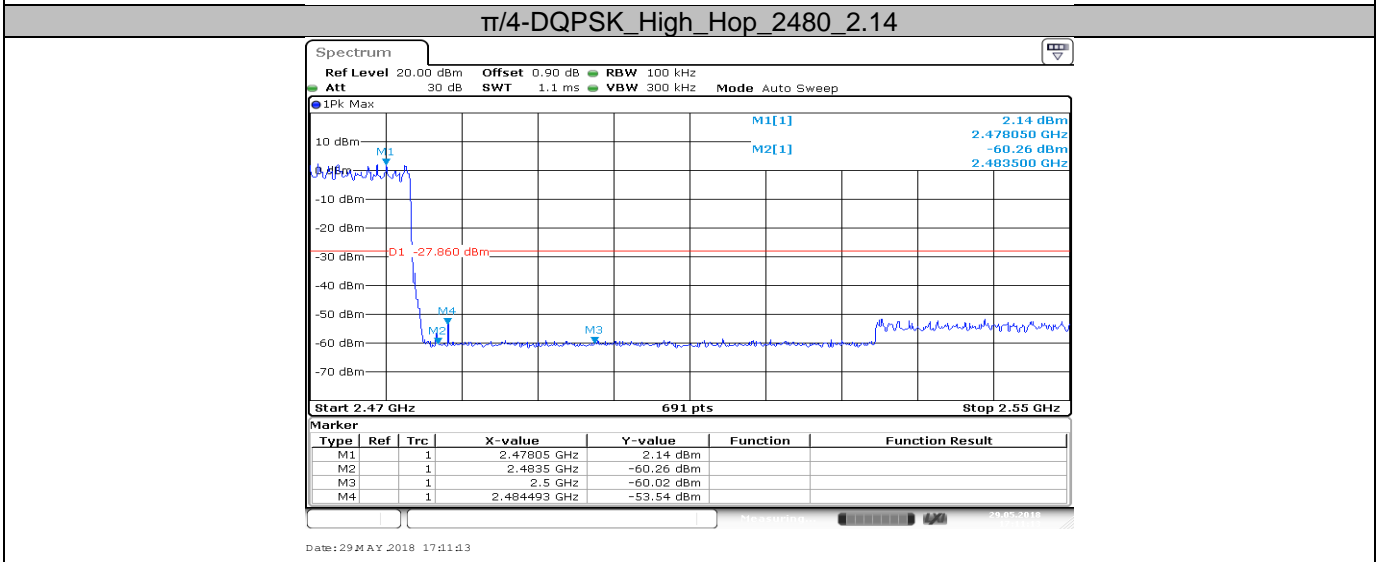
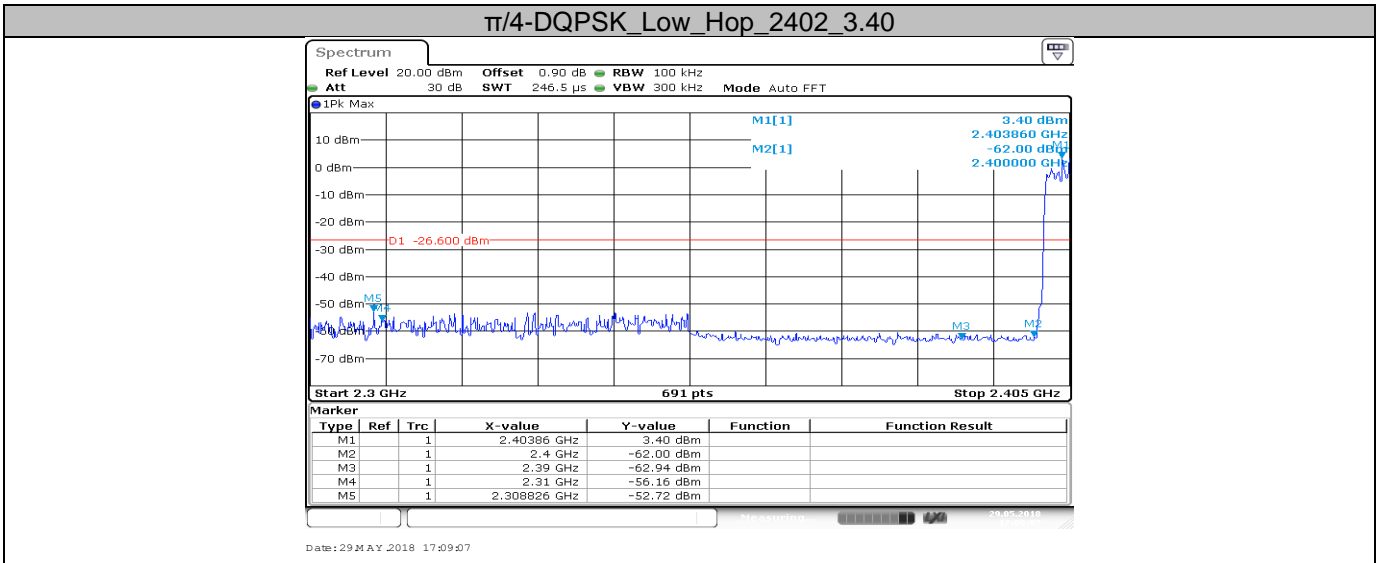

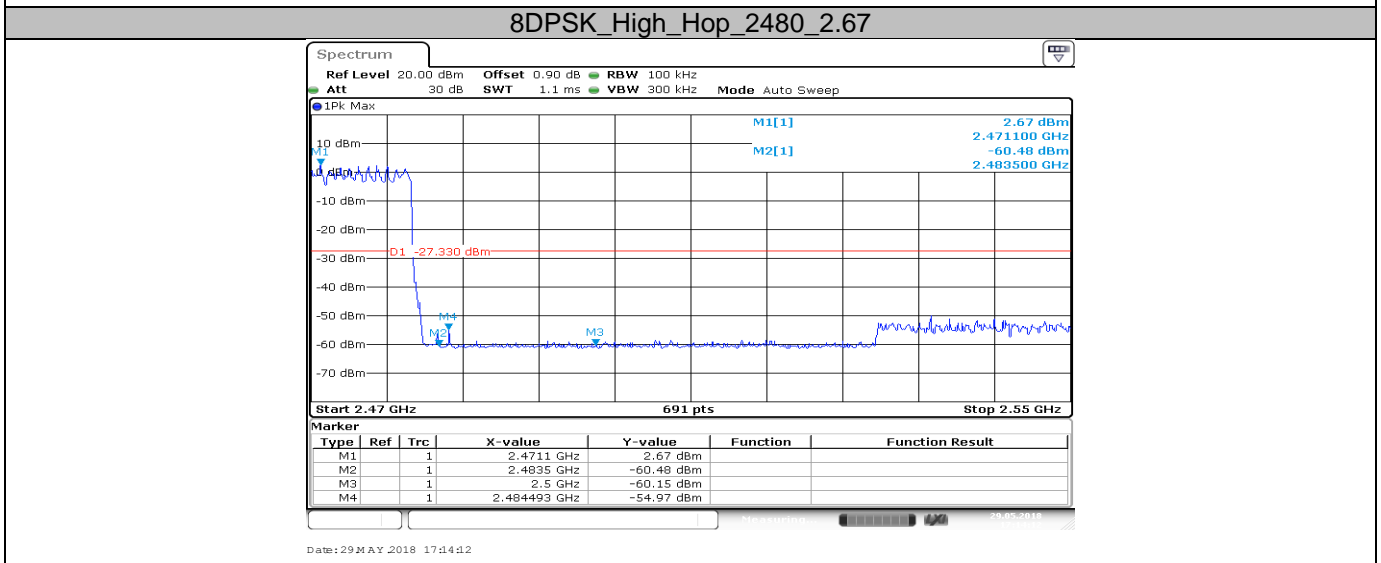
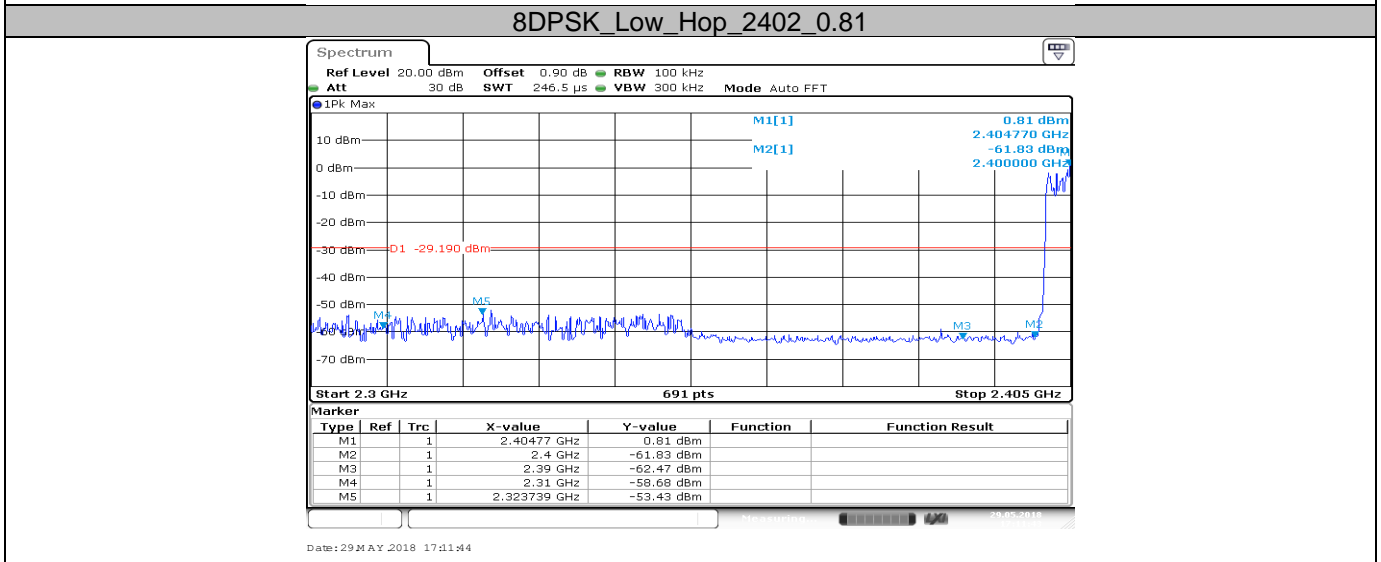
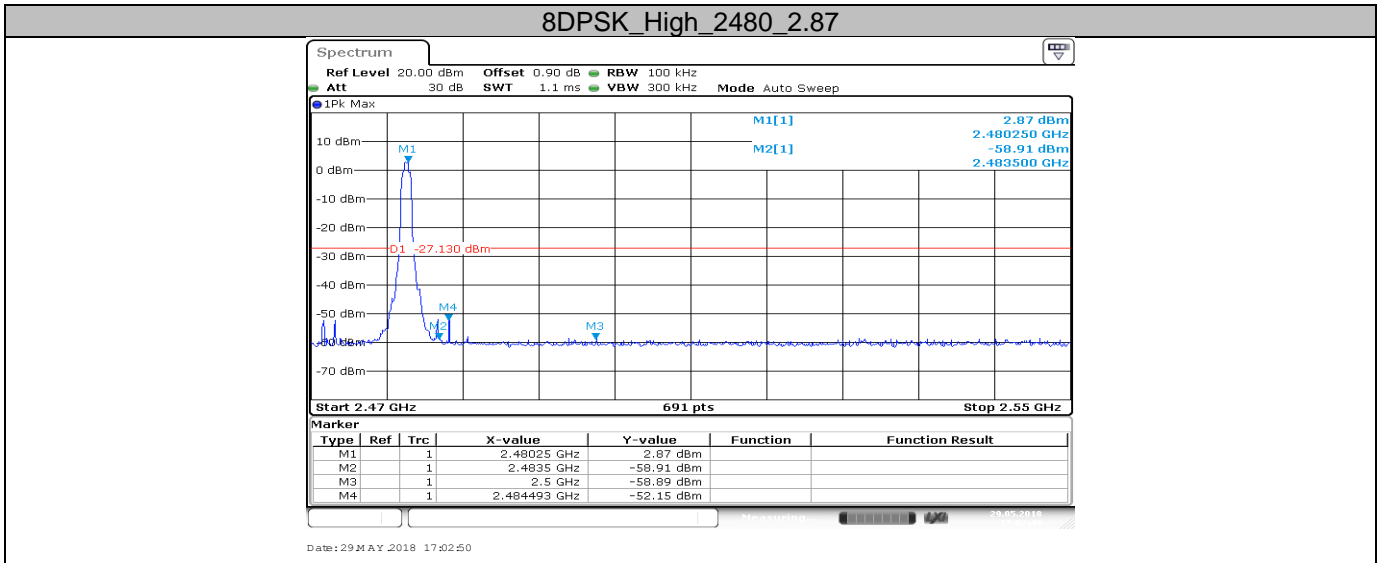

9.10 Spurious radiated emissions for transmitter

Test Method

- 1: The EUT was placed on a turn table which is 1.5m above ground plane for above 1GHz and 0.8m above ground for below 1GHz at 3meter chamber room for test. The table was rotated 360 degrees to determine the position of the highest radiation.
- 2: The EUT was set 3 meters away from the interference – receiving antenna, which was mounted on the top of a variable – height antenna tower.
- 3: The height of antenna is varied from one meter to four meters above the ground to determine the maximum value of the field strength. Both horizontal and vertical polarizations of the antenna are set to make the measurement.
- 4: For each suspected emission, the EUT was arranged to its worst case and then the antenna was tuned to heights from 1 meter to 4 meters and the rotatable table was turned from 0 degrees to 360 degrees to find the maximum reading.
- 5: Use the following spectrum analyzer settings According to C63.10:

For Above 1GHz

Span = wide enough to capture the peak level of the in-band emission and all spurious
RBW = 1MHz, VBW \geq RBW for peak measurement and VBW = 10Hz for average measurement, Sweep = auto, Detector function = peak, Trace = max hold.

For Below 1GHz

Use the following spectrum analyzer settings:

Span = wide enough to capture the peak level of the in-band emission and all spurious
RBW = 100 KHz, VBW \geq RBW for peak measurement, Sweep = auto, Detector function = peak, Trace = max hold.

Note:

- 1: The resolution bandwidth and video bandwidth of test receiver/spectrum analyzer is 120 KHz for Quasi-peak detection (QP) at frequency below 1GHz.
- 2: The resolution bandwidth of test receiver/spectrum analyzer is 1MHz and the video bandwidth is 3MHz for peak detection (PK) at frequency above 1GHz.
- 3: The resolution bandwidth of test receiver/spectrum analyzer is 1MHz and the video bandwidth is 3MHz for RMS Average ((duty cycle < 98%) for Average detection (AV) at frequency above 1GHz, then the measurement results was added to a correction factor ($20\log(1/\text{duty cycle})$).
- 4: The resolution bandwidth of test receiver/spectrum analyzer is 1MHz and the video bandwidth is 10Hz (duty cycle > 98%) for Average detection (AV) at frequency above 1GHz.



Limit

The radio emission outside the operating frequency band shall be at least 20 dB below that in the 100 kHz bandwidth within the band that contains the highest level of the desired power. Radiated emissions which fall in the restricted bands, as defined in section 15.205, must comply with the radiated emission limits specified in section 15.209.

Frequency MHz	Field Strength uV/m	Field Strength dBµV/m	Detector
30-88	100	40	QP
88-216	150	43.5	QP
216-960	200	46	QP
960-1000	500	54	QP
Above 1000	500	54	AV
Above 1000	5000	74	PK

Spurious radiated emissions for transmitter

According to C63.10, if the peak (or quasi-peak) measured value complies with the average limit, it is unnecessary to perform an average measurement, so AV emission value did not show in below table if the peak value complies with average limit.

The only worse case (which is subject to the maximum EIRP, GFSK mode) test result is listed in the report.

Transmitting spurious emission test result as below:

SPTM1 (Version S)

GFSK Modulation 2402MHz Test Result

Frequency Band	Frequency	Emission Level	Polarization	Limit	Detector	Margin	Corr.	Result
	MHz	dBuV/m		dBuV/m				
30-1000MHz	243.99	31.68	H	46.00	QP	14.32	-26.80	Pass
	31.02	27.35	V	40.00	QP	12.65	-25.60	Pass
1000-25000MHz	7009.21	40.16	H	74.00	PK	33.84	5.7	Pass
	--	--	H	54.00	AV	--	--	Pass
	8831.25	42.12	V	74.00	PK	31.88	8.6	Pass
	--	--	V	54.00	AV	--	--	Pass

GFSK Modulation 2441MHz Test Result

Frequency Band	Frequency	Emission Level	Polarization	Limit	Detector	Margin	Corr.	Result
	MHz	dBuV/m		dBuV/m				
30-1000MHz	--	--	H	43.5	QP	--	--	Pass
	--	--	V	46	QP	--	--	Pass
1000-25000MHz	9868.53	42.59	H	74	PK	31.41	9.4	Pass
	--	--	H	54	AV	--	--	Pass
	7039.21	40.05	V	74	PK	33.95	6.1	Pass
	--	--	V	54	AV	--	--	Pass

GFSK Modulation 2480MHz Test Result

Frequency Band	Frequency	Emission Level	Polarization	Limit	Detector	Margin	Corr.	Result
	MHz	dBuV/m		dBuV/m				
30-1000MHz	--	--	H	43.5	QP	--	--	Pass
	--	--	V	46	QP	--	--	Pass
1000-25000MHz	10063.12	43.27	H	74	PK	30.73	9.7	Pass
	--	--	H	54	AV	--	--	Pass
	7030.31	40.13	V	74	PK	33.87	6.1	Pass
	--	--	V	54	AV	--	--	Pass

SPTM1 (Version W)
GFSK Modulation 2402MHz Test Result

Frequency Band	Frequency	Emission Level	Polarization	Limit	Detector	Margin	Corr.	Result
	MHz	dBuV/m		dB μ V/m				
30-1000MHz	103.34	30.31	H	43.50	QP	13.19	-28.00	Pass
	764.61	36.67	V	46.00	QP	9.33	-18.20	Pass
1000-25000MHz	7079.53	39.28	H	74.00	PK	34.72	5.8	Pass
	--	--	H	54.00	AV	--	--	Pass
	7053.75	38.87	V	74.00	PK	35.13	6.2	Pass
	--	--	V	54.00	AV	--	--	Pass

GFSK Modulation 2441MHz Test Result

Frequency Band	Frequency	Emission Level	Polarization	Limit	Detector	Margin	Corr.	Result
	MHz	dBuV/m		dB μ V/m				
30-1000MHz	--	--	H	43.5	QP	--	--	Pass
	--	--	V	46	QP	--	--	Pass
1000-25000MHz	8752.03	41.10	H	74	PK	32.90	8.8	Pass
	--	--	H	54	AV	--	--	Pass
	7050.00	38.63	V	74	PK	35.37	6.2	Pass
	--	--	V	54	AV	--	--	Pass

GFSK Modulation 2480MHz Test Result

Frequency Band	Frequency	Emission Level	Polarization	Limit	Detector	Margin	Corr.	Result
	MHz	dBuV/m		dB μ V/m				
30-1000MHz	--	--	H	43.5	QP	--	--	Pass
	--	--	V	46	QP	--	--	Pass
1000-25000MHz	6470.15	37.43	H	74	PK	36.57	4.6	Pass
	--	--	H	54	AV	--	--	Pass
	*7528.59	39.63	V	74	PK	34.37	6.6	Pass
	--	--	V	54	AV	--	--	Pass

Remark:

- (1) "*" means the emission(s) appear within the restrict bands shall follow the requirement of section 15.205.
- (2) Data of measurement within this frequency range shown "--" in the table above means the reading of emissions are the noise floor or attenuated more than 10dB below the permissible limits or the field strength is too small to be measured.
- (3) Above 1GHz: Corrector factor = Antenna Factor + Cable Loss- Amplifier Gain.
- (4) Below 1GHz: Corrector factor = Antenna Factor + Cable Loss.

10 Test Equipment List

Radiated Emission Test

DESCRIPTION	MANUFACTURER	MODEL NO.	SERIAL NO.	CAL. DUE DATE
EMI Test Receiver	Rohde & Schwarz	ESR 26	101269	2018-7-14
Trilog Super Broadband Test Antenna	Schwarzbeck	VULB 9163	707	2018-7-14
Horn Antenna	Rohde & Schwarz	HF907	102294	2018-7-14
Pre-amplifier	Rohde & Schwarz	SCU 18	102230	2018-7-14
Signal Generator	Rohde & Schwarz	SMY01	839369/005	2018-7-7
Attenuator	Agilent	8491A	MY39264334	2018-7-7
3m Semi-anechoic chamber	TDK	9X6X6	----	2020-7-7
Test software	Rohde & Schwarz	EMC32	Version 9.15.00	N/A

Conducted Emission Test

DESCRIPTION	MANUFACTURER	MODEL NO.	SERIAL NO.	CAL. DUE DATE
EMI Test Receiver	Rohde & Schwarz	ESR 3	101782	2018-7-14
LISN	Rohde & Schwarz	ENV4200	100249	2018-7-14
LISN	Rohde & Schwarz	ENV432	101318	2018-7-14
LISN	Rohde & Schwarz	ENV216	100326	2018-7-14
ISN	Rohde & Schwarz	ENY81	100177	2018-7-14
ISN	Rohde & Schwarz	ENY81-CA6	101664	2018-7-14
High Voltage Probe	Rohde & Schwarz	TK9420(VT9420)	9420-584	2018-7-14
RF Current Probe	Rohde & Schwarz	EZ-17	100816	2018-7-14
Attenuator	Shanghai Huaxiang	TS2-26-3	080928189	2018-7-7
Test software	Rohde & Schwarz	EMC32	Version9.15.00	N/A

TS8997 Test System

DESCRIPTION	MANUFACTURER	MODEL NO.	SERIAL NO.	CAL. DUE DATE
Signal Generator	Rohde & Schwarz	SMB100A	108272	2018-7-7
Vector Signal Generator	Rohde & Schwarz	SMBV100A	262825	2018-7-23
Communication Synthetical Test Instrument	Rohde & Schwarz	CMW 270	101251	2019-2-15
Signal Analyzer	Rohde & Schwarz	FSV40	101030	2018-7-7
Vector Signal Generator	Rohde & Schwarz	SMU 200A	105324	2018-7-7
RF Switch Module	Rohde & Schwarz	OSP120/OSP-B157	101226/100851	2018-7-7
Power Splitter	Weinschel	1580	SC319	2018-7-7
10dB Attenuator	Weinschel	56-10	58764	2018-7-14
10dB Attenuator	R&S	DNF	DNF-001	2018-7-14
10dB Attenuator	R&S	DNF	DNF-002	2018-7-14
10dB Attenuator	R&S	DNF	DNF-003	2018-7-14
10dB Attenuator	R&S	DNF	DNF-004	2018-7-14
Test software	Rohde & Schwarz	EMC32	Version 10.38.00	N/A
Test software	Tonscend	System for BT/WIFI	Version 2.6	N/A

11 System Measurement Uncertainty

For a 95% confidence level, the measurement expanded uncertainties for defined systems, in accordance with the recommendations of ISO 17025 were:

System Measurement Uncertainty	
Items	Extended Uncertainty
Uncertainty for Radiated Spurious Emission 25MHz-3000MHz	Horizontal: 4.80dB; Vertical: 4.87dB;
Uncertainty for Radiated Spurious Emission 3000MHz-18000MHz	Horizontal: 4.59dB; Vertical: 4.58dB;
Uncertainty for Radiated Spurious Emission 18000MHz-40000MHz	Horizontal: 5.05dB; Vertical: 5.04dB;
Uncertainty for Conducted RF test with TS 8997	Power level test involved: 2.13dB Frequency test involved: 0.6×10^{-7}
Uncertainty for Conducted Emission 150kHz-30MHz (for test using AMN ENV432 or ENV4200)	3.21dB