



FCC PART 15.407
 ISED RSS-247, ISSUE 1
 DYNAMIC FREQUENCY SELECTION
 TEST AND MEASUREMENT REPORT



For

GoPro, Inc.

3000 Clearview Way,

San Mateo, CA 94402, USA

FCC ID: CNFHWMR1
IC: 10193A-HWMR1

Report Type: Original Report	Product Type: Wireless Video Camera
Prepared By: Jin Yang Test Engineer	
Report Number: R1606032-DFS	
Report Date: 2016-08-18	
Reviewed By: Bo Li RF Lead	
Bay Area Compliance Laboratories Corporation (BACL) 1274 Anvilwood Avenue, Sunnyvale, CA 94089, USA Tel: (408) 732-9162 Fax: (408) 732-9164	

Note: This test report is prepared for the customer shown above and for the device described herein. It may not be duplicated or used in part without prior written consent from Bay Area Compliance Laboratories Corp. This report **must not** be used by the customer to claim product certification, approval, or endorsement by A2LA* or any agency of the Federal Government.

* This report may contain data that are not covered by the A2LA accreditation and are marked with an asterisk "*" Rev. 11

TABLE OF CONTENTS

1	GENERAL DESCRIPTION.....	5
1.1	GENERAL STATEMENTS.....	5
1.2	OBJECTIVE.....	5
1.3	PRODUCT DESCRIPTION FOR EQUIPMENT UNDER TEST (EUT).....	5
1.4	RELATED SUBMITTAL(S)/GRANT(S).....	5
1.5	TEST METHODOLOGY.....	5
1.6	TEST FACILITY REGISTRATIONS.....	6
1.7	TEST FACILITY ACCREDITATIONS.....	6
2	EUT TEST CONFIGURATION.....	9
2.1	JUSTIFICATION.....	9
2.2	EUT EXERCISE SOFTWARE.....	9
2.3	EQUIPMENT MODIFICATIONS.....	9
2.4	LOCAL SUPPORT EQUIPMENT.....	9
2.5	INTERFACE PORTS AND CABLES.....	9
3	SUMMARY OF TEST RESULTS.....	10
4	APPLICABLE STANDARDS.....	11
4.1	DFS REQUIREMENT.....	11
4.2	DFS MEASUREMENT SYSTEM.....	14
4.3	SYSTEM BLOCK DIAGRAM.....	14
4.4	CONDUCTED METHOD.....	15
4.5	RADIATED METHOD.....	16
4.6	TEST PROCEDURE.....	17
5	TEST RESULTS.....	18
5.1	DESCRIPTION OF EUT.....	18
5.2	ANTENNA DETAILS.....	18
5.3	TEST EQUIPMENT LIST AND DETAILS.....	18
5.4	RADAR WAVEFORM CALIBRATION.....	19
5.5	TEST LOCATION, DATE, PERSONNEL AND ENVIRONMENTAL CONDITIONS.....	19
6	CHANNEL MOVE TIME AND CHANNEL CLOSING TRANSMISSION TIME.....	28
6.1	TEST PROCEDURE.....	28
6.2	TEST RESULTS.....	28
7	NON-OCCUPANCY TIME.....	31
8	EXHIBIT A – TEST SETUP PHOTOGRAPHS.....	32
8.1	DFS TEST SETUP VIEW.....	32
8.2	DFS TEST SETUP DETAIL VIEW.....	32
9	EXHIBIT B - EUT PHOTOGRAPHS.....	33
9.1	EUT – FRONT VIEW.....	33
8.2	EUT – BACK VIEW.....	33
8.3	EUT – LEFT VIEW.....	34
8.4	EUT – RIGHT VIEW.....	34
8.5	EUT – TOP VIEW.....	35
8.6	EUT – BOTTOM VIEW.....	35
8.7	EUT – OPEN CASE VIEW.....	36
8.8	EUT – MAIN PCB BOARD – TOP VIEW.....	36

8.9	EUT – MAIN PCB BOARD – BOTTOM VIEW	37
8.10	EUT – ATTACHMENT 1 VIEW.....	37
8.11	EUT – ATTACHMENT 2 VIEW.....	38
8.12	EUT – BATTERY VIEW	38

DOCUMENT REVISION HISTORY

Revision Number	Report Number	Description of Revision	Date of Revision
0	R1606032-DFS	Original Report	2016-08-18

1 General Description

1.1 General Statements

Bay area Compliance Laboratory Corp. [BACL] hereby makes the following Statements:

- The Unit(s) described in this Test Report were received at BACL's facilities on 6 June 2016 and was in working condition upon arrival. Testing was performed on the Unit(s) described in this Test Report during the period 3 August 2016.
- The Test Results reported herein apply only to the Unit(s) actually tested, and to substantially identical Units.
- This Test Report must not be used to claim product endorsement by A2LA, or any agency of the U.S. Government, or by any other foreign government.
- This Test Report is the property of BACL, and shall not be reproduced, except in full, without prior written approval of BACL.

1.2 Objective

This report is prepared on behalf of GoPro, Inc. in accordance with FCC CFR47 §15.407 (h), RSS247 Issue 1 and KDB: 905462 D02 UNII DFS Compliance Procedures New Rules v02

The objective is to determine compliance with FCC rules for Channel Closing Transmission Time, and Channel Move time in Client Mode without Radar detection function

1.3 Product Description for Equipment under Test (EUT)

This test and measurement report was prepared on behalf of *GoPro, Inc.*, and their product model: *HWMR1*, FCC ID: CNFHWMR1; IC: 10193A-HWMR1 or the "EUT" as referred to in this report. It is a Wireless video camera.

1.4 Related Submittal(s)/Grant(s)

FCC Part 15, Subpart C, Equipment DSS with FCC ID: CNFHWMR1
FCC Part 15, Subpart E, Equipment NII with FCC ID: CNFHWMR1

1.5 Test Methodology

FCC CFR 47 Part2, Part15.407 (h)

KDB: 905462 D02 UNII DFS Compliance Procedures New Rules v02

COMPLIANCE MEASUREMENT PROCEDURES FOR UNLICENSED-NATIONAL INFORMATION INFRASTRUCTURE DEVICES OPERATING IN THE 5250-5350 MHz AND 5470-5725 MHz BANDS INCORPORATING DYNAMIC FREQUENCY SELECTION

1.6 Test Facility Registrations

BACLs test facilities that are used to perform Radiated and Conducted Emissions tests are currently recognized by the Federal Communications Commission as Accredited with NIST Designation Number US1129.

BACL's test facilities that are used to perform Radiated and Conducted Emissions tests are currently registered with Industry Canada under Registration Numbers: 3062A-1, 3062A-2, and 3062A-3.

BACL is a Chinese Taipei Bureau of Standards Metrology and Inspection (BSMI) validated Conformity Assessment Body (CAB), under Appendix B, Phase I Procedures of the APEC Mutual Recognition Arrangement (MRA). BACL's BSMI Lab Code Number is: SL2-IN-E-1002R

BACL's test facilities that are used to perform AC Line Conducted Emissions, Telecommunications Line Conducted Emissions, Radiated Emissions from 30 MHz to 1 GHz, and Radiated Emissions from 1 GHz to 6 GHz are currently recognized as Accredited in accordance with the Voluntary Control Council for Interference [VCCI] Article 15 procedures under Registration Number A-0027.

1.7 Test Facility Accreditations

Bay Area Compliance Laboratories Corp. (BACL) is:

A- An independent, 3rd-Party, Commercial Test Laboratory accredited to ISO/IEC 17025:2005 by A2LA (Test Laboratory Accreditation Certificate Number 3279.02), in the fields of: Electromagnetic Compatibility and Telecommunications. Unless noted by an Asterisk (*) in the Compliance Matrix (See Section 3 of this Test Report), BACL's ISO/IEC 17025:2005 Scope of Accreditation includes all of the Test Method Standards and/or the Product Family Standards detailed in this Test Report..

BACL's ISO/IEC 17025:2005 Scope of Accreditation includes a comprehensive suite of EMC Emissions, EMC Immunity, Radio, RF Exposure, Safety and wireline Telecommunications test methods applicable to a wide range of product categories. These product categories include Central Office Telecommunications Equipment [including NEBS - Network Equipment Building Systems], Unlicensed and Licensed Wireless and RF devices, Information Technology Equipment (ITE); Telecommunications Terminal Equipment (TTE); Medical Electrical Equipment; Industrial, Scientific and Medical Test Equipment; Professional Audio and Video Equipment; Industrial and Scientific Instruments and Laboratory Apparatus; Cable Distribution Systems, and Energy Efficient Lighting.

B- A Product Certification Body accredited to ISO/IEC 17065:2012 by A2LA (Product Certification Body Accreditation Certificate Number 3279.03) to certify

- For the USA (Federal Communications Commission):

- 1- All Unlicensed radio frequency devices within FCC Scopes A1, A2, A3, and A4;
- 2- All Licensed radio frequency devices within FCC Scopes B1, B2, B3, and B4;
- 3- All Telephone Terminal Equipment within FCC Scope C.

- For the Canada (Industry Canada):

- 1- All Scope 1-Licence-Exempt Radio Frequency Devices;
- 2- All Scope 2-Licensed Personal Mobile Radio Services;
- 3- All Scope 3-Licensed General Mobile & Fixed Radio Services;
- 4- All Scope 4-Licensed Maritime & Aviation Radio Services;
- 5- All Scope 5-Licensed Fixed Microwave Radio Services
- 6- All Broadcasting Technical Standards (BETS) in the Category I Equipment Standards List.

- For Singapore (Info-Communications Development Authority (IDA)):

- 1 All Line Terminal Equipment: All Technical Specifications for Line Terminal Equipment – Table 1 of IDA MRA Recognition Scheme: 2011, Annex 2
 2. All Radio-Communication Equipment: All Technical Specifications for Radio-Communication Equipment – Table 2 of IDA MRA Recognition Scheme: 2011, Annex 2
- For the Hong Kong Special Administrative Region:
- 1 All Radio Equipment, per KHCA 10XX-series Specifications;
 - 2 All GMDSS Marine Radio Equipment, per HKCA 12XX-series Specifications;
 - 3 All Fixed Network Equipment, per HKCA 20XX-series Specifications.
- For Japan:
- 1 MIC Telecommunication Business Law (Terminal Equipment):
 - All Scope A1 - Terminal Equipment for the Purpose of Calls;
 - All Scope A2 - Other Terminal Equipment
 - 2 Radio Law (Radio Equipment):
 - All Scope B1 - Specified Radio Equipment specified in Article 38-2-2, paragraph 1, item 1 of the Radio Law
 - All Scope B2 - Specified Radio Equipment specified in Article 38-2-2, paragraph 1, item 2 of the Radio Law
 - All Scope B3 - Specified Radio Equipment specified in Article 38-2-2, paragraph 1, item 3 of the Radio Law

C- A Product Certification Body accredited to ISO/IEC 17065:2012 by A2LA (Product Certification Body Accreditation Certificate Number 3279.01) to certify Products to USA's Environmental Protection Agency (EPA) ENERGY STAR Product Specifications for:

- 1 Electronics and Office Equipment:
 - for Telephony (ver. 3.0)
 - for Audio/Video (ver. 3.0)
 - for Battery Charging Systems (ver. 1.1)
 - for Set-top Boxes & Cable Boxes (ver. 4.1)
 - for Televisions (ver. 6.1)
 - for Computers (ver. 6.0)
 - for Displays (ver. 6.0)
 - for Imaging Equipment (ver. 2.0)
 - for Computer Servers (ver. 2.0)
- 2 Commercial Food Service Equipment
 - for Commercial Dishwashers (ver. 2.0)
 - for Commercial Ice Machines (ver. 2.0)
 - for Commercial Ovens (ver. 2.1)
 - for Commercial Refrigerators and Freezers
- 3 Lighting Products
 - For Decorative Light Strings (ver. 1.5)
 - For Luminaires (including sub-components) and Lamps (ver. 1.2)
 - For Compact Fluorescent Lamps (CFLs) (ver. 4.3)
 - For Integral LED Lamps (ver. 1.4)
- 4 Heating, Ventilation, and AC Products
 - for Residential Ceiling Fans (ver. 3.0)
 - for Residential Ventilating Fans (ver. 3.2)
- 5 Other
 - For Water Coolers (ver. 3.0)

D- A NIST Designated Phase-I and Phase-II Conformity Assessment Body (CAB) for the following economies and regulatory authorities under the terms of the stated MRAs/Treaties:

- Australia: ACMA (Australian Communication and Media Authority) – APEC Tel MRA -Phase I;
- Canada: (Industry Canada - IC) Foreign Certification Body – FCB – APEC Tel MRA -Phase I & Phase II;
- Chinese Taipei (Republic of China – Taiwan):
 - o BSMI (Bureau of Standards, Metrology and Inspection) APEC Tel MRA -Phase I;
 - o NCC (National Communications Commission) APEC Tel MRA -Phase I;
- European Union:
 - o Radio & Teleterminal Equipment (R&TTE) Directive 1995/5/EC
US -EU EMC & Telecom MRA CAB
- Hong Kong Special Administrative Region: (Office of the Telecommunications Authority – OFTA)
APEC Tel MRA -Phase I & Phase II
- Israel – US-Israel MRA Phase I
- Republic of Korea (Ministry of Communications - Radio Research Laboratory) APEC Tel MRA -Phase I
- Singapore: (Infocomm Development Authority - IDA) APEC Tel MRA -Phase I & Phase II;
- Japan: VCCI - Voluntary Control Council for Interference US-Japan Telecom Treaty VCCI Side Letter-
- USA:
 - o ENERGY STAR Recognized Test Laboratory – US EPA
 - o Telecommunications Certification Body (TCB) – US FCC;
- Vietnam: APEC Tel MRA -Phase I;

2 EUT Test Configuration

2.1 Justification

The EUT was configured for testing according to FCC Part 15.407(H), RSS 247 Issue 1 and KDB: 905462 D02 UNII DFS Compliance Procedures New Rules v02

2.2 EUT Exercise Software

The test firmware used was V00:04:02 provided by *GoPro, Inc.*, the software is comply with the standard requirements being tested against.

2.3 Equipment Modifications

N/A

2.4 Local Support Equipment

Manufacturer	Description	Model
Dell	Laptop	Latitude D630
Fortinet	Access point	FAP-221C-E
Fortinet	AP adapter	DSA-20PFE-12
Fortinet	Access Controller	FG-60D-POE
Fortinet	AC adapter	FSP036-RAB

2.5 Interface Ports and Cables

Cable Description	Length (m)	To	From
USB Cable	< 1 m	Laptop	EUT

3 Summary of Test Results

The following result table represents the list of measurements required under the CFR47 §47 Part15.407 (h), and KDB: 905462 D02 UNII DFS Compliance Procedures New Rules v02.

Items	Description of Test	Results
Detection Bandwidth	UNII Detection Bandwidth	Compliant ¹
Performance Requirements Check	Initial Channel Availability Check Time (CAC)	Compliant ¹
	Radar Burst at the Beginning of the CAC	Compliant ¹
	Radar Burst at the End of the CAC	Compliant ¹
In-Service Monitoring	Channel Move Time	Compliant
	Channel Closing Transmission Time	Compliant
	Non-Occupancy Period	Compliant ¹
Radar Detection	Statistical Performance Check	Compliant ¹

¹ Test item is not required for Client Device without radar detection

4 Applicable Standards

4.1 DFS Requirement

FCC CFR47 §15.407 (h), RSS-247 Issue 1 and KDB: 905462 D02 UNII DFS Compliance Procedures New Rules v02

Table 1: Applicability of DFS requirements prior to use of a channel

Requirement	Operational Mode		
	Master	Client (Without radar detection)	Client (With radar detection)
Non-Occupancy Period	Yes	Not Required	Yes
DFS Detection Threshold	Yes	Not Required	Yes
Channel Availability Check Time	Yes	Not Required	Not Required
U-NII Detection Bandwidth	Yes	Not Required	Yes

Table 2: Applicability of DFS requirements during normal operation

Requirement	Operational Mode	
	Master Device or Client with Radar Detection	Client Without Radar Detection
DFS Detection Threshold	Yes	Not Required
Channel Closing Transmission Time	Yes	Yes
Channel Move Time	Yes	Yes
U-NII Detection Bandwidth	Yes	Not Required

Additional requirements for devices with multiple bandwidth modes	Master Device or Client with Radar Detection	Client Without Radar Detection
U-NII Detection Bandwidth and Statistical Performance Check	All BW modes must be tested	Not required
Channel Move Time and Channel Closing Transmission Time	Test using widest BW mode available	Test using the widest BW mode available for the link
All other tests	Any single BW mode	Not required

Note: Frequencies selected for statistical performance check (Section 7.8.4) should include several frequencies within the radar detection bandwidth and frequencies near the edge of the radar detection bandwidth. For 802.11 devices it is suggested to select frequencies in each of the bonded 20 MHz channels and the channel center frequency.

Table 3: Interference Threshold values, Master or Client incorporating In-Service Monitoring

Maximum Transmit Power	Value (See Notes 1, 2 and 3)
EIRP \geq 200 milliwatt	-64 dBm
EIRP < 200 milliwatt and power spectral density < 10dBm/MHz	-62 dBm
EIRP < 200 milliwatt that do not meet the power spectral density requirement	-64 dBm

Note 1: This is the level at the input of the receiver assuming a 0 dBi receive antenna.
Note 2: Throughout these test procedures an additional 1 dB has been added to the amplitude of the test transmission waveforms to account for variations in measurement equipment. This will ensure that the test signal is at or above the detection threshold level to trigger a DFS response.
Note 3: EIRP is based on the highest antenna gain. For MIMO devices refer to KDB Publication 662911D01.

Table 4: DFS Response Requirement Values

Parameter	Value
Non-occupancy period	Minimum 30 minutes
Channel Availability Check Time	60 seconds
Channel Move Time	10 seconds See Note 1.
Channel Closing Transmission Time	200 milliseconds + an aggregate of 60 milliseconds over remaining 10 second period. See Notes 1 and 2.
U-NII Detection Bandwidth	Minimum 100% of the UNII 99% transmission power bandwidth. See Note 3.

Note 1: *Channel Move Time and the Channel Closing Transmission Time should be performed with Radar Type 0. The measurement timing begins at the end of the Radar Type 0 burst.*
Note 2: The Channel Closing Transmission Time is comprised of 200 milliseconds starting at the beginning of the Channel Move Time plus any additional intermittent control signals required to facilitate a Channel move (an aggregate of 60 milliseconds) during the remainder of the 10 second period. The aggregate duration of control signals will not count quiet periods in between transmissions.
Note 3: During the *U-NII Detection Bandwidth* detection test, radar type 0 is used and for each frequency step the minimum percentage of detection is 90 percent. Measurements are performed with no data traffic.

Table 5: Short Pulse Radar Test Waveforms

Radar Type	Pulse Width (Microseconds)	PRI (Microseconds)	Pulses	Minimum Percentage of Successful Detection	Minimum Number of Trials
0	1	1428	18	See Note 1	See Note 1
1	1	Test A: 15 unique PRI values randomly selected from the list of 23 PRI values in Table 5a	$\text{Roundup}\left(\left(\frac{1}{360}\right) \cdot \left(\frac{19 \cdot 10^6}{\text{PRI}_{\mu\text{sec}}}\right)\right)$	60%	30
		Test B: 15 unique PRI values randomly selected within the range of 518-3066 μsec , with a minimum increment of 1 μsec , excluding PRI values selected in Test A			
2	1-5	150-230	23-29	60%	30
3	6-10	200-500	16-18	60%	30
4	11-20	200-500	12-16	60%	30
Aggregate (Radar Types 1-4)				80%	120
Note 1: Short Pulse Radar Type 0 should be used for the detection bandwidth test, channel move time, and channel closing time tests.					

Table 6: Long Pulse Radar Test Signal

Radar Type	Bursts	Chirp Width (MHz)	PRI (usec)	Number of Pulses per Burst	Number of Bursts	Minimum Percentage of Successful Detection	Minimum Number of Trials
5	50-100	5-20	1000-2000	1-3	8-20	80%	30

The parameters for this waveform are randomly chosen. Thirty unique waveforms are required for the Long Pulse Radar Type waveforms. If more than 30 waveforms are used for the Long Pulse Radar Type waveforms, then each additional waveform must also be unique and not repeated from the previous waveforms.

Table 7: Frequency Hopping Radar Test Signal

Radar Type	Pulse Width (usec)	PRI (usec)	Pulses per Hop	Hopping Rate (kHz)	Hopping Sequence Length (msec)	Minimum Percentage of Successful Detection	Minimum Number of Trials
6	1	333	9	0.333	300	70%	30

4.2 DFS Measurement System

BACL DFS measurement system consists of two subsystems: (1) The radar signal generating subsystem and (2) the traffic monitoring subsystem.

4.3 System Block Diagram

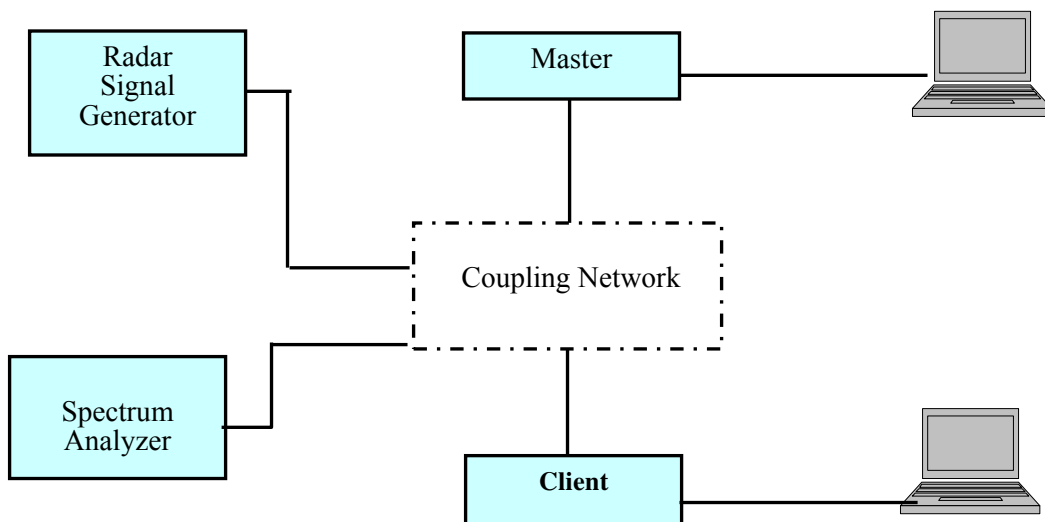

4.4 Conducted Method

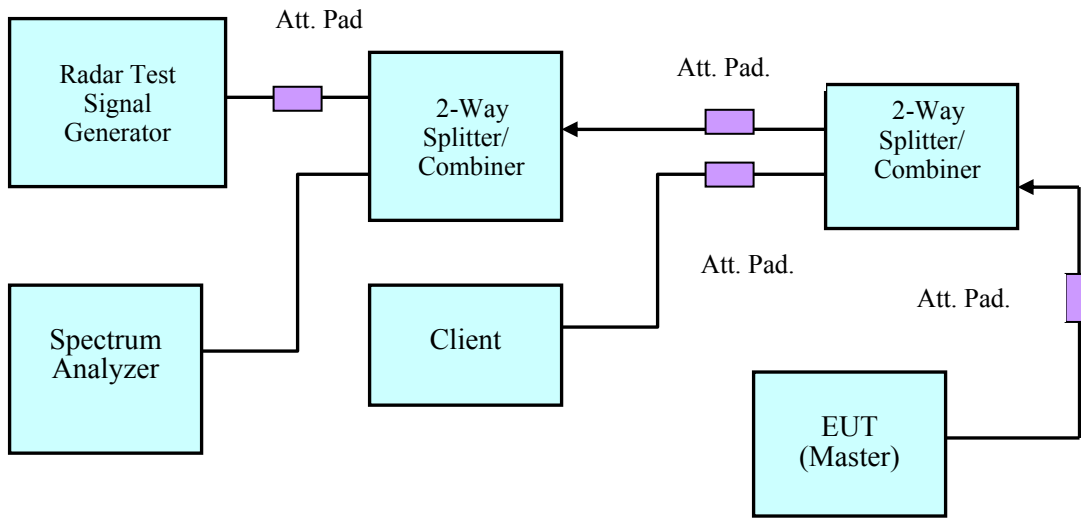

Setup for Master with injection at the Master

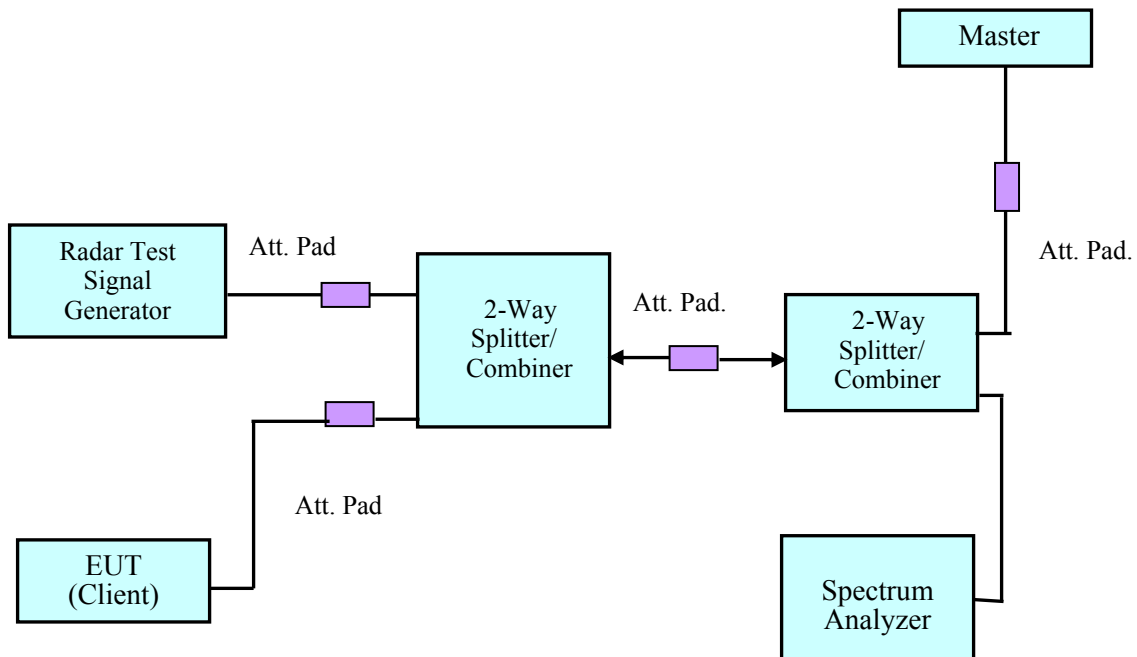

Setup for Client with injection at the Master

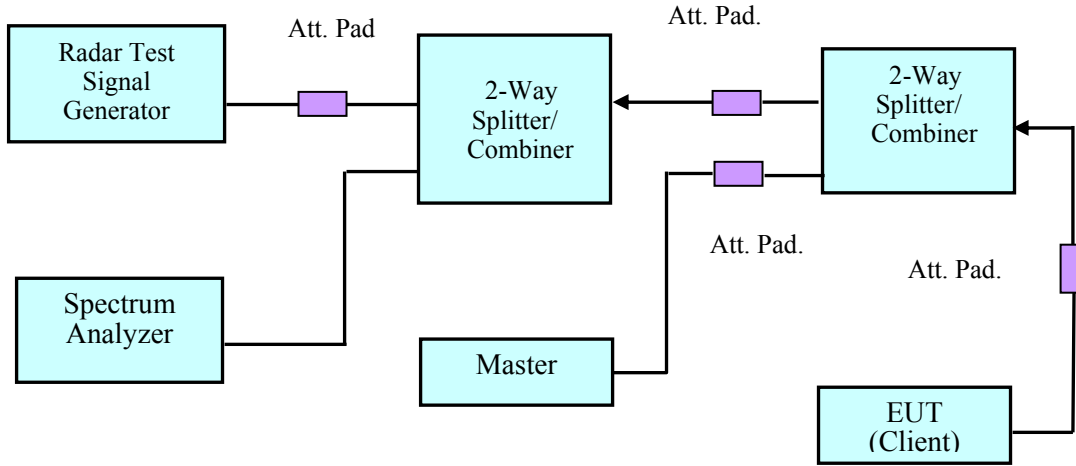

Setup for Client with injection at the Client

4.5 Radiated Method

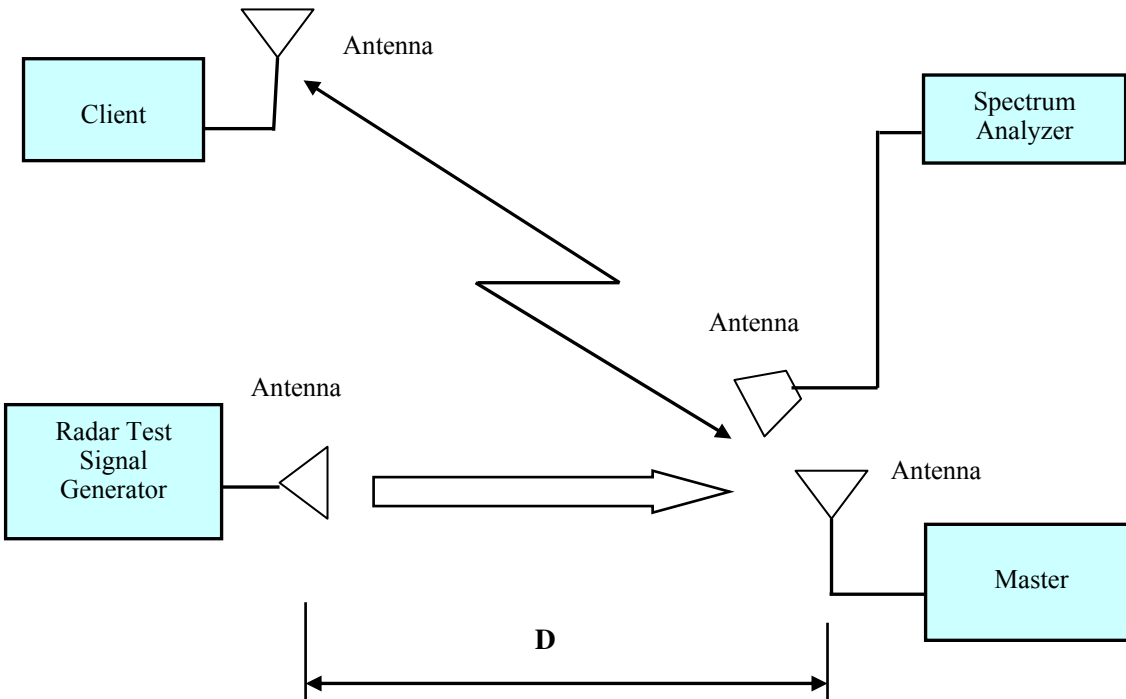

4.6 Test Procedure

A spectrum analyzer is used as a monitor that verifies the EUT's status, which includes the Channel Closing Transmission Time and the Channel Move Time. The Spectrum analyzer is used to monitor the equipment under test (EUT) does not transmit on the same channel during the Non-Occupied Period after the radar detection.

5 Test Results

5.1 Description of EUT

The EUT operates in 5230-5350 MHz and 5470-5725 MHz range in client Mode.

The rated output power of EUT is <23 dBm (EIRP), Therefore the required interference threshold level is -62 dBm, the required radiated threshold at antenna port is -64 dBm.

WLAN traffic is generated by streaming the data with iperf software.

5.2 Antenna Details

Type	Operating Freq. (MHz)/Ant. Gain (dBi)	
	5250-5350	5470-5725
Internal	1.41	1.41

5.3 Test Equipment List and Details

Manufacturer	Equipment Description	Model	S/N	Calibration Date	Calibration Interval
National Instruments	NI PXI-1042 8-Slot chassis	PXI-1042	V08X01EE1	N/A	N/A
National Instruments	Arbitrary Waveform Generator	PXI-5421	N/A	N/A	N/A
National Instruments	RF Upconverter	PXI-5610	N/A	N/A	N/A
ASCOR	Upconverter	AS-7206	N/A	N/A	N/A
Agilent	Spectrum Analyzer	E4440A	MY44303352	2015-10-16	1 year
A.R.A.	Antenna Horn	DRG-118/A	1132	2016-01-29	2 years
EMCO	Antenna Horn	3115	9511-4627	2015-10-17	2 years
Mini-Circuits	Splitter/Combiner	2FSC-2-10G	0349	N/A	N/A
Narda	Splitter/Combiner	4326B-2	03514	N/A	N/A
Midwest	Attenuator	290-30	N/A	N/A	N/A
Mini-Circuits	Attenuator	BW-S30W2	N/A	N/A	N/A
Redwolf	DFS test software	N/A	N/A	N/A	N/A

Statement of Traceability: *BACL Corp.* attests that all calibrations have been performed according to A2LA requirements, traceable to the NIST.

5.4 Radar Waveform Calibration

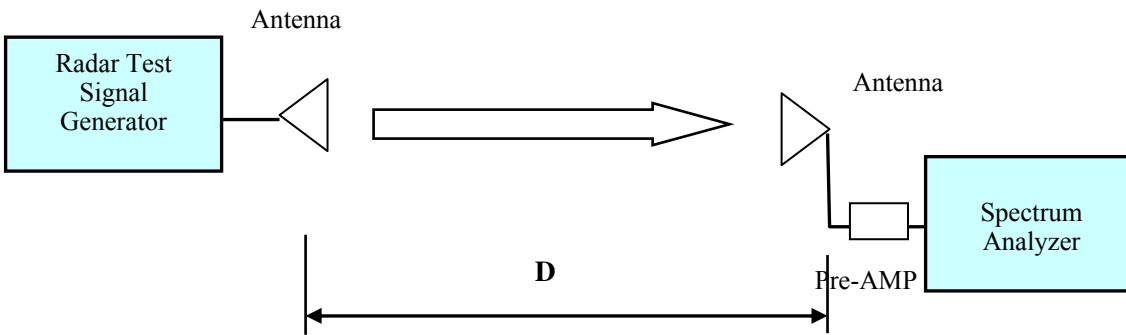

Radiated Calibration Setup Block Diagram

5.5 Test Location, Date, Personnel and Environmental Conditions

Test Date:	2016-08-03
Test Site:	DFS Testing Site
Temperature:	23° C
Relative Humidity:	44 %
Barometric Pressure:	102.1 kPa
Test Personnel:	Jin Yang

Plots of Radar Waveforms

5290 MHz

Radar Type 0

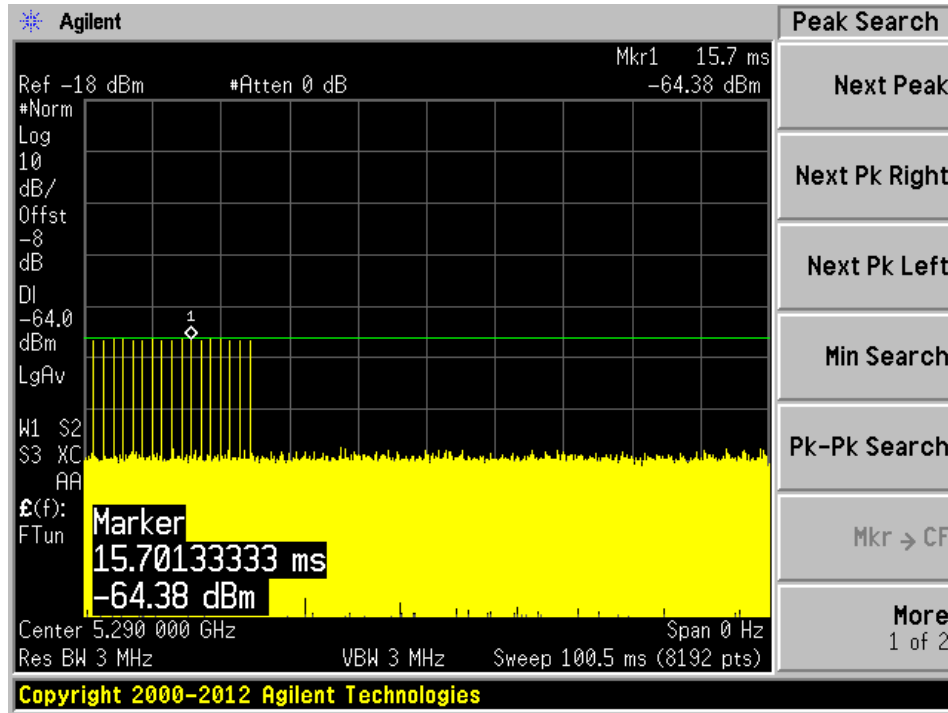

Radar Type 1A

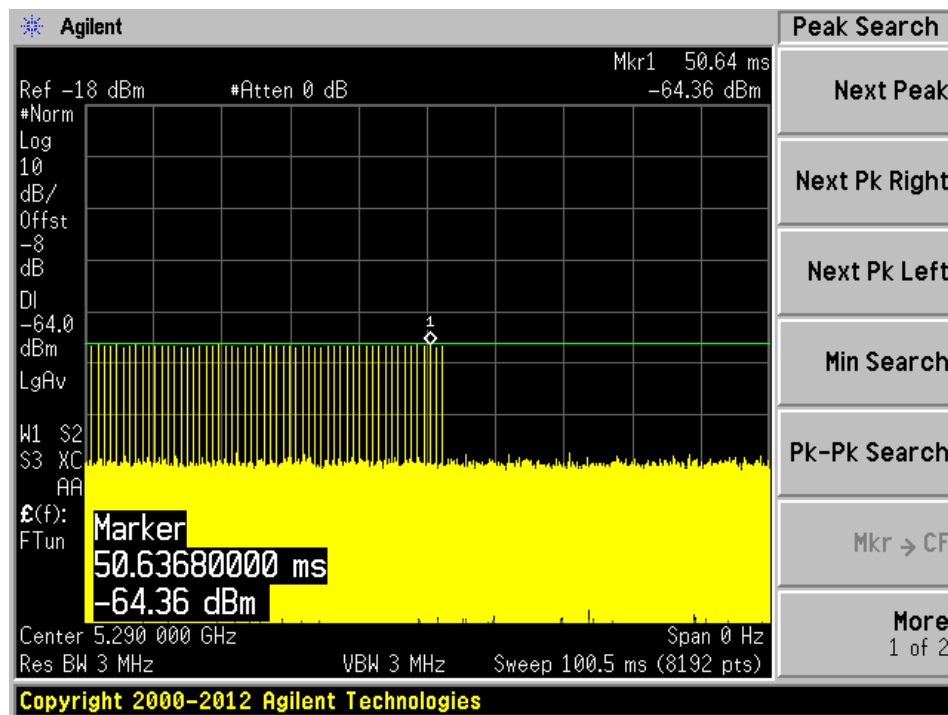

Radar Type 1B

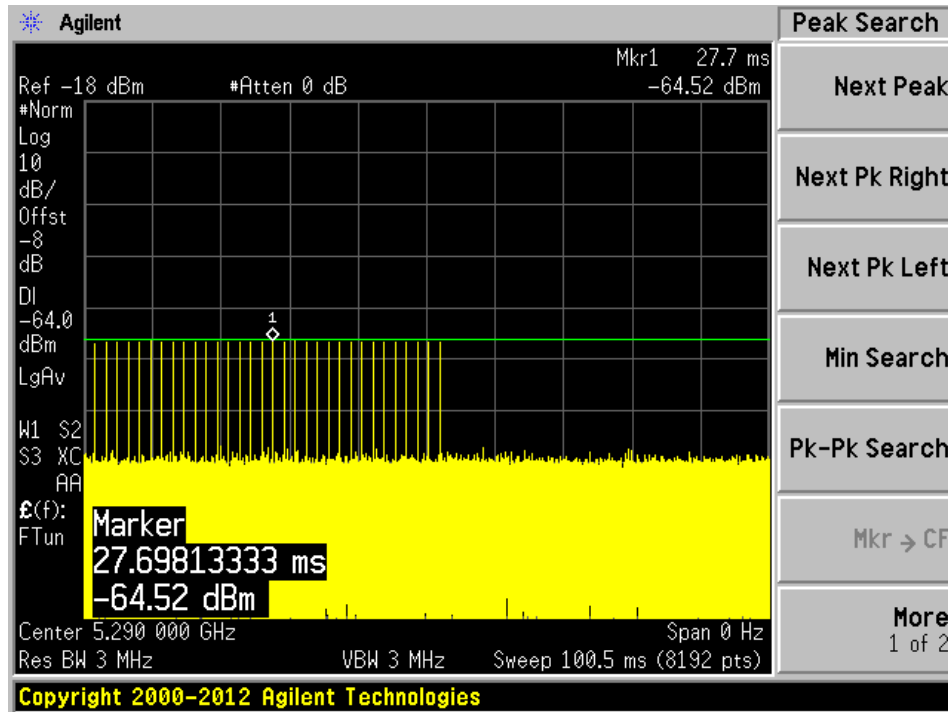

Radar Type 2

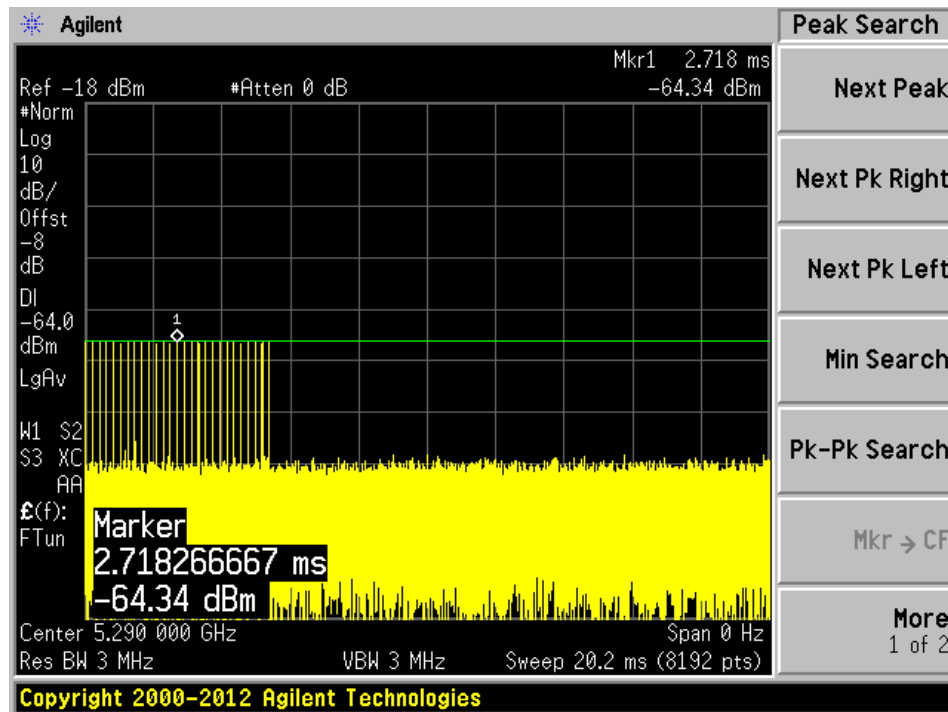

Radar Type 3

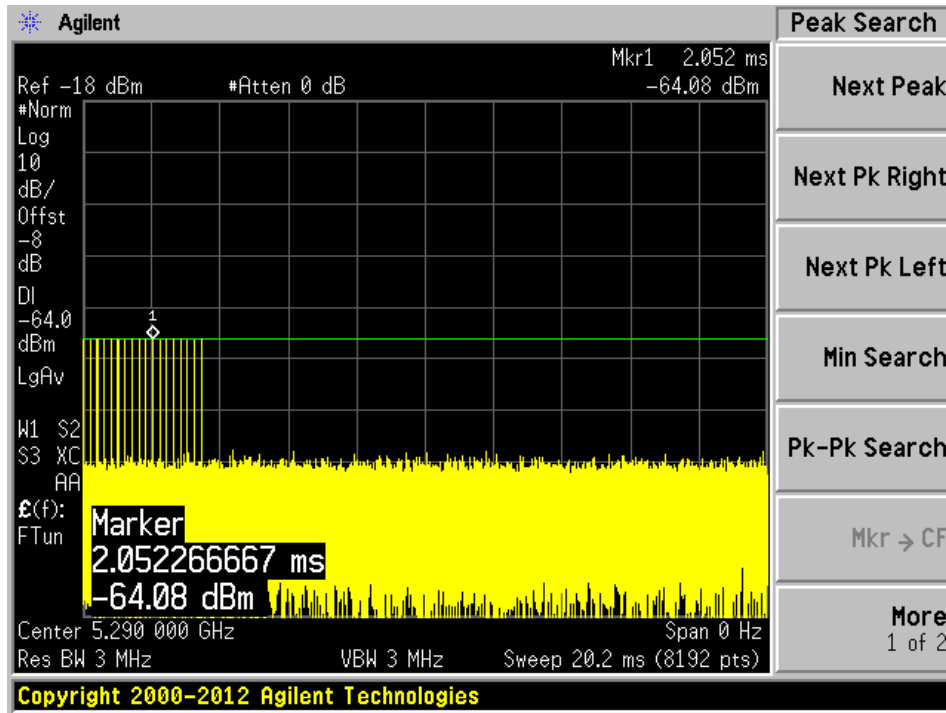

Radar Type 4

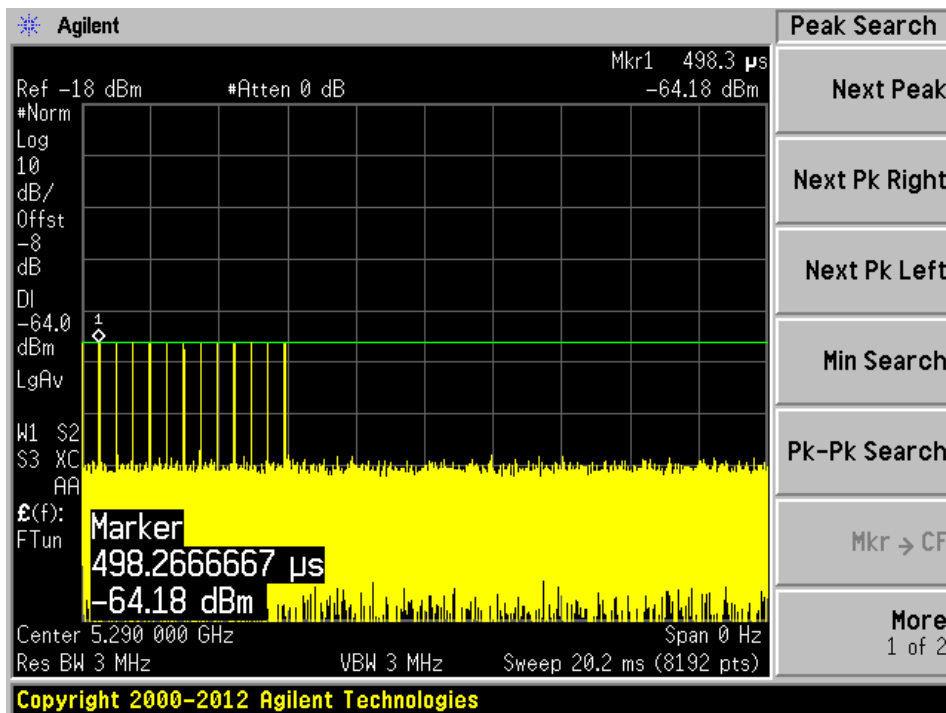

Radar Type 5

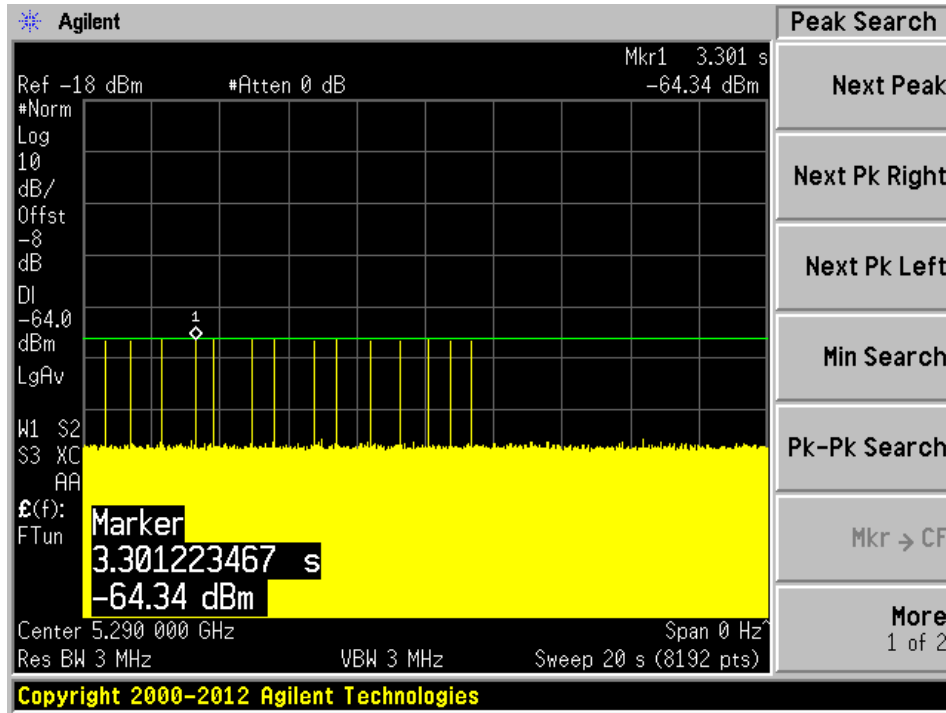

Radar Type 6

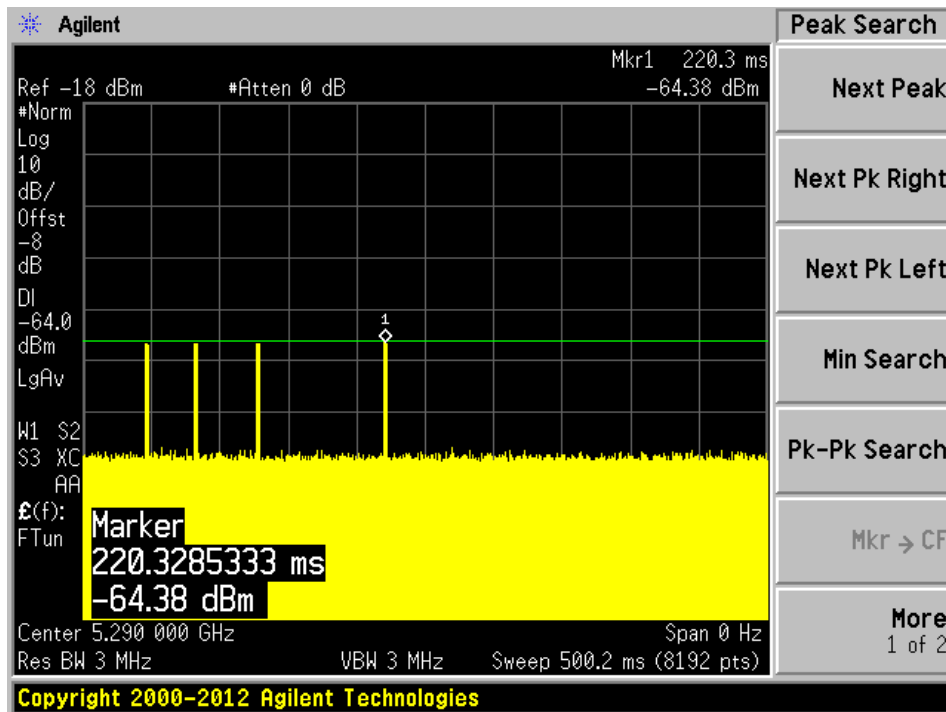

5530 MHz

Radar Type 0

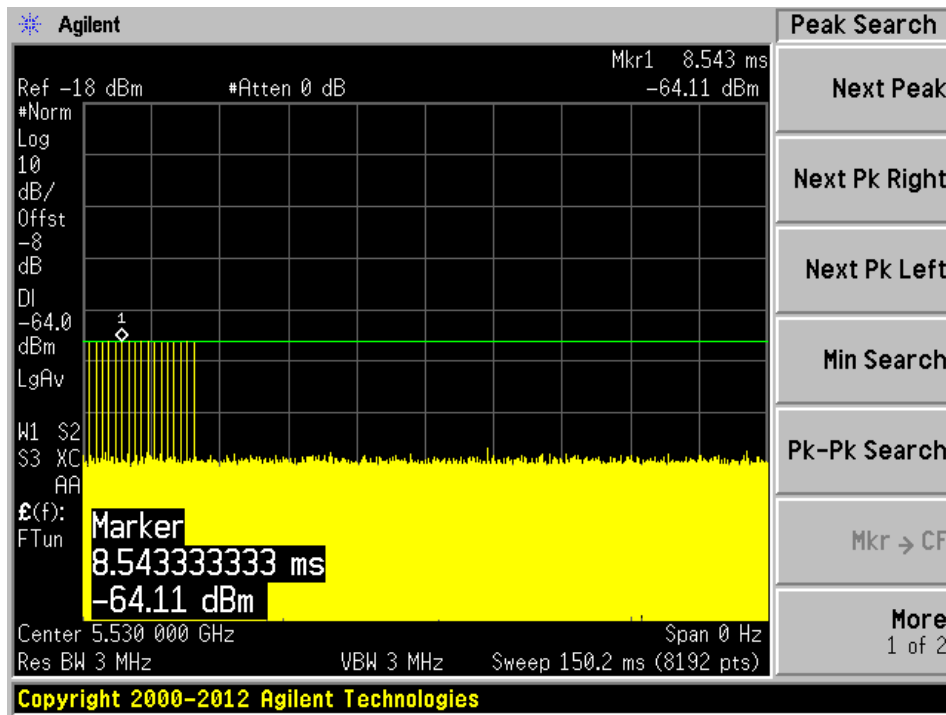

Radar Type 1A

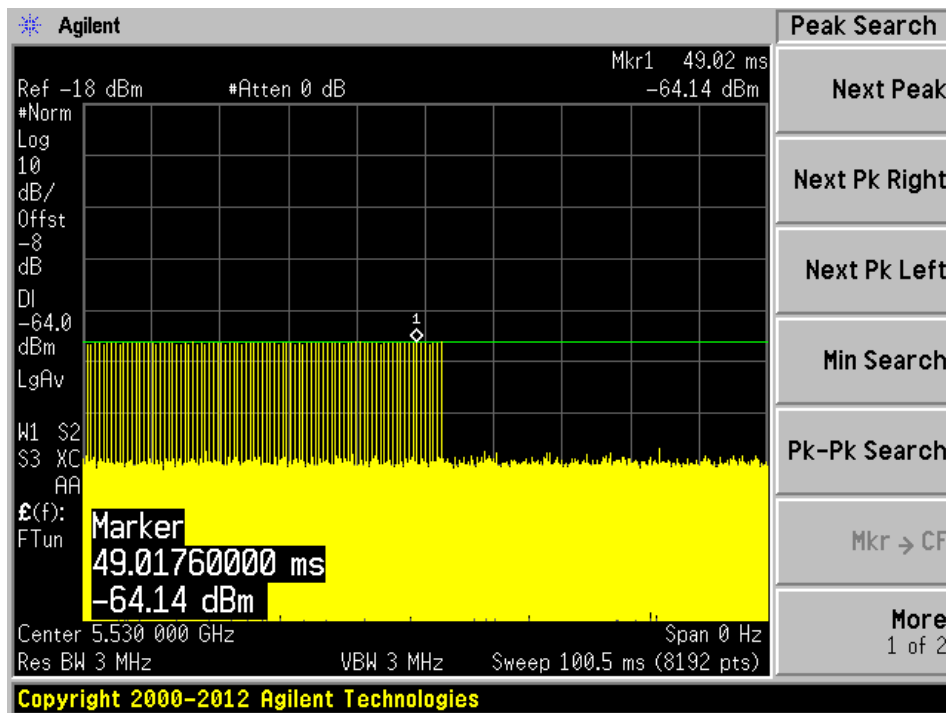

Radar Type 1B

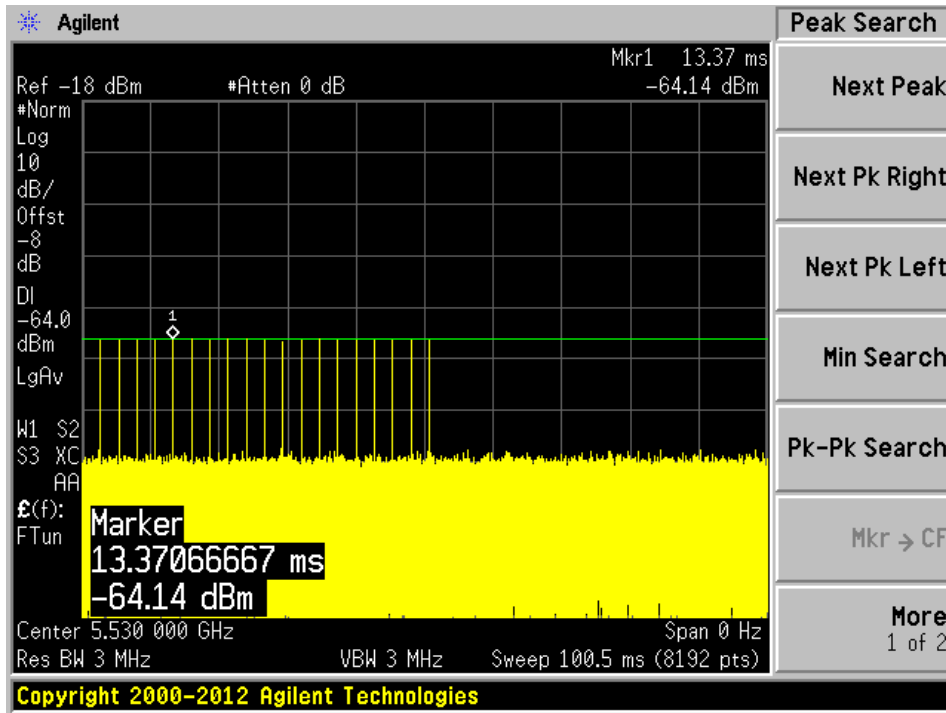

Radar Type 2

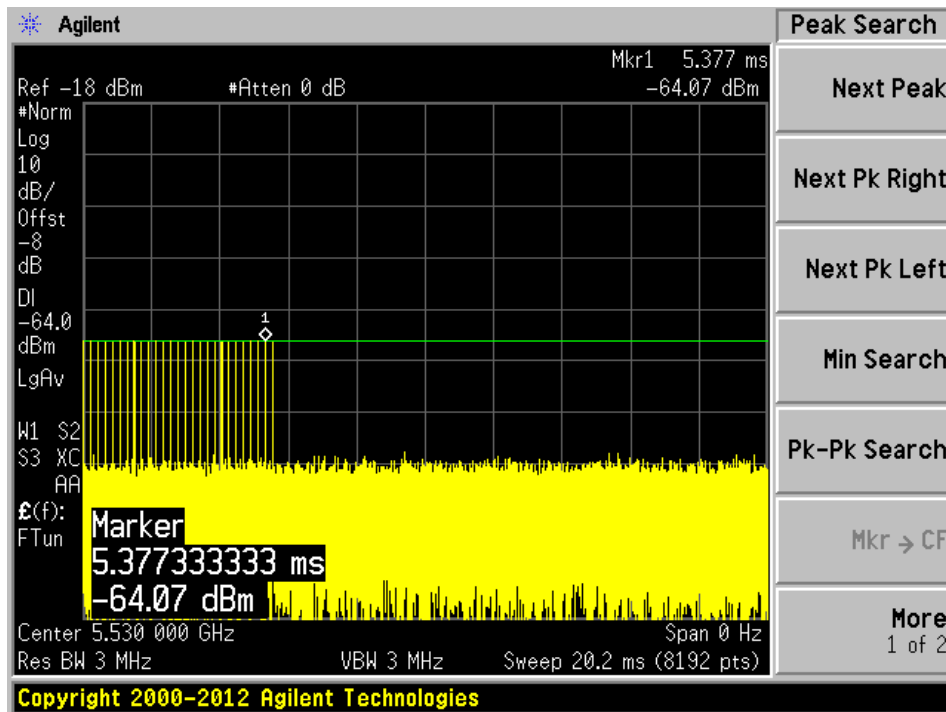

Radar Type 3

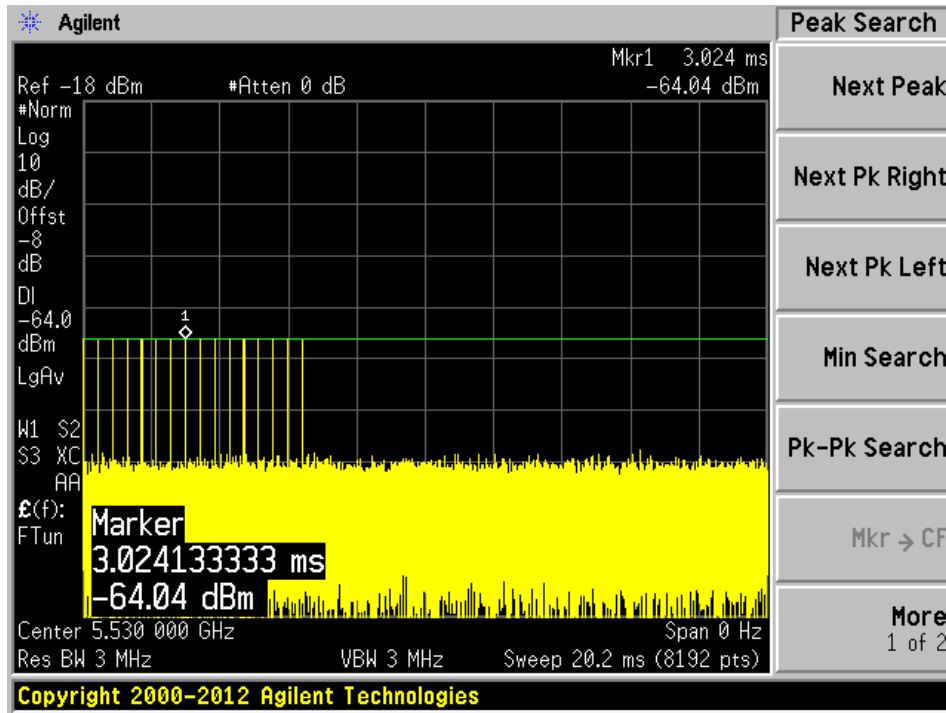

Radar Type 4

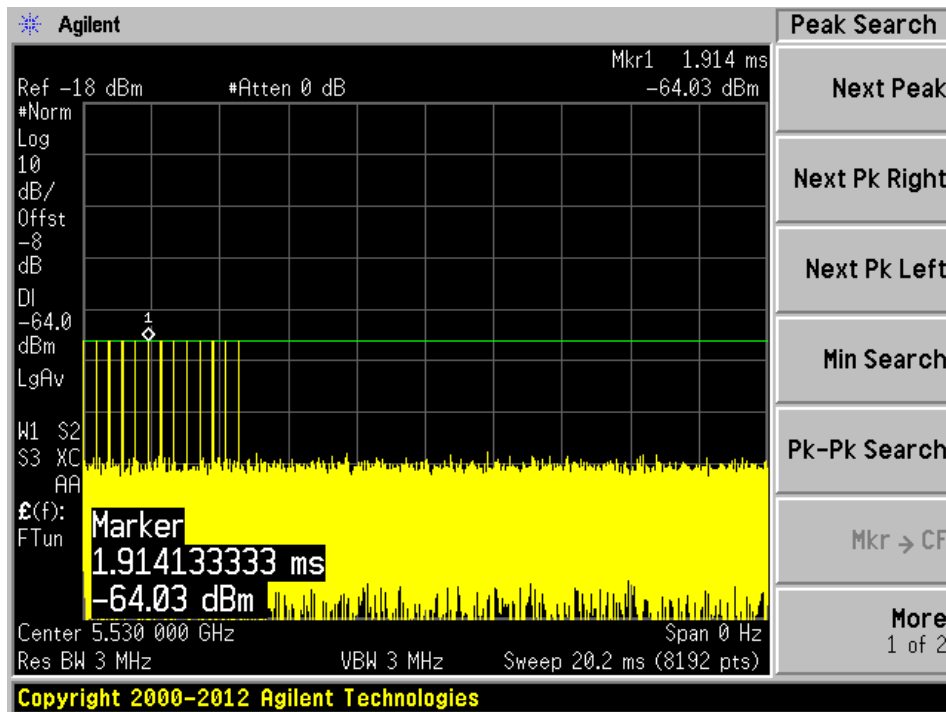

Radar Type 5

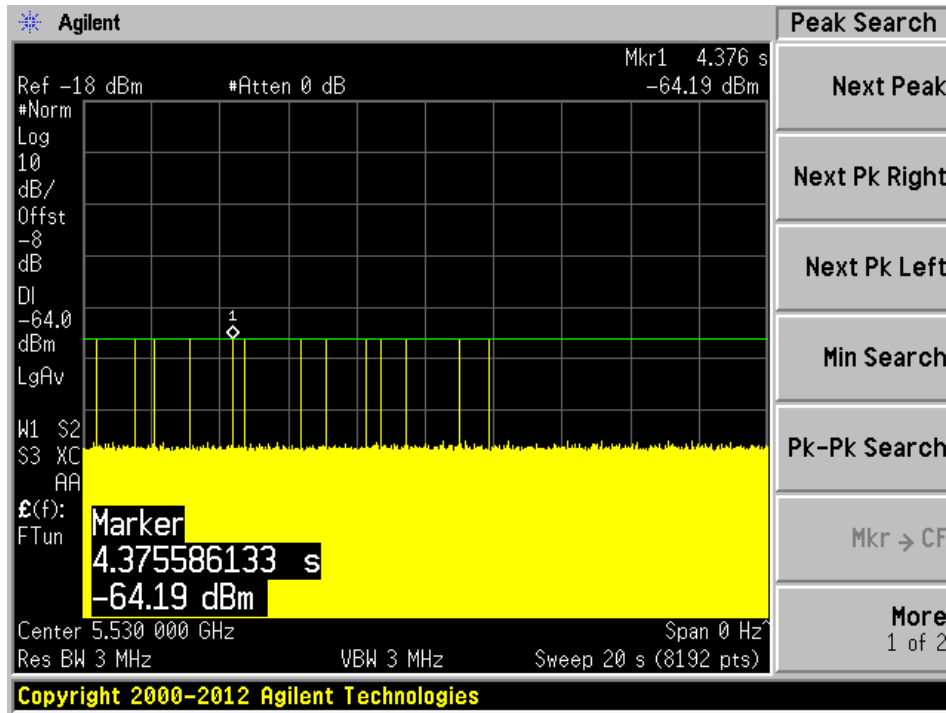

Radar Type 6

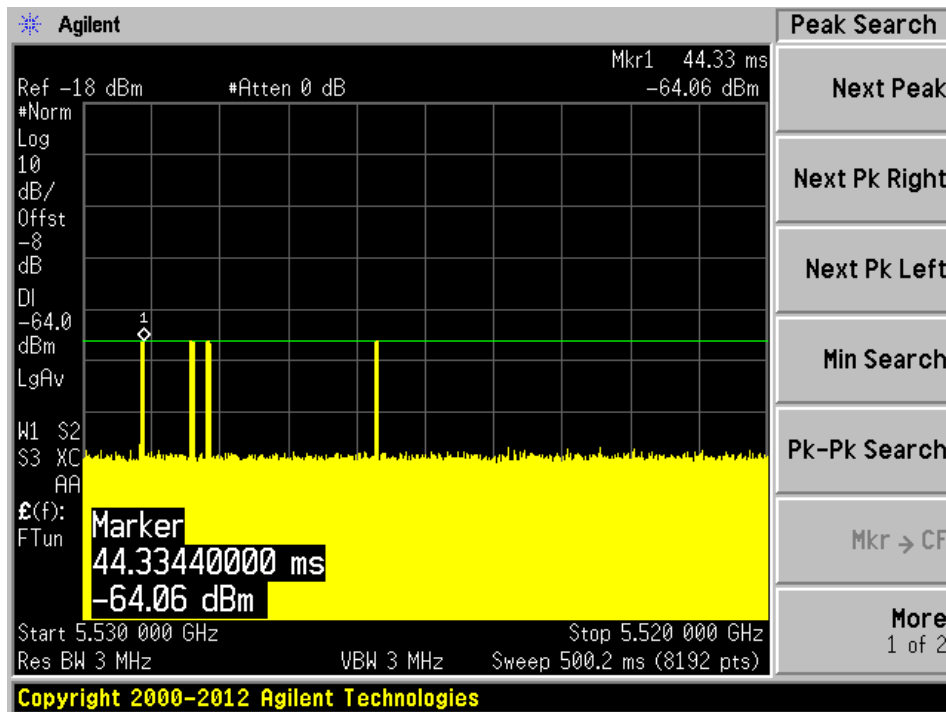

6 Channel Move Time and Channel Closing Transmission Time

6.1 Test Procedure

Perform one of the type 0 short pulse radar waveform

The aggregate channel closing transmission time is calculated as follows:

Aggregate Transmission Time = N * Dwell Time

N is the number of spectrum analyzer bins showing a device transmission

Dwell Time is the dwell time per bin (i.e. Dwell Time = S/B, S is the sweep time and B is the number of bin, i.e. 8192)

6.2 Test Results

Frequency (MHz)	Bandwidth (MHz)	Radar Type	Results
5290	80	Type 0	Compliant
5530	80	Type 0	Compliant

Please refer to the following tables and plots.

5290 MHz Bandwidth 80 MHz

Type 0 radar channel moving and closing transmission time result:

Frequency (MHz)	Radar Type	Channel Closing Transmission Time				Channel Move Time	
		Test	Limit	Aggregate Transmission Time	Limit	Test	Limit
5290	0	70.8 ms	200 ms	61.04 ms	60 ms	< 10 s	10 s

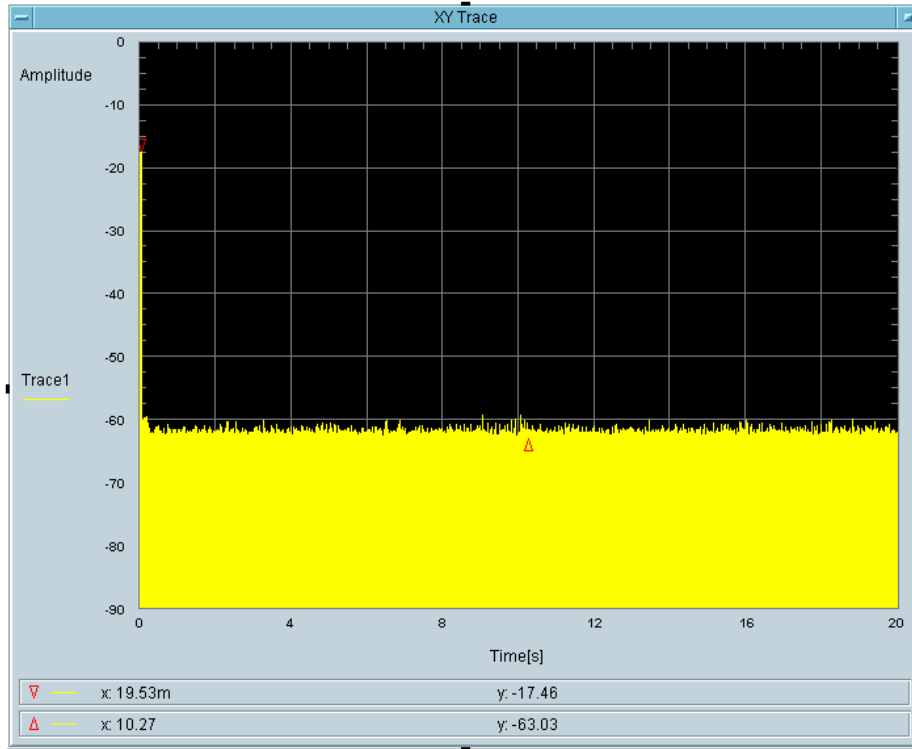

Total On Time [s]
70.8m

Total On Time After Delay [s]
61.04m

5530 MHz Bandwidth 80 MHz

Type 0 radar channel moving and closing transmission time result:

Frequency (MHz)	Radar Type	Channel Closing Transmission Time				Channel Move Time	
		Test	Limit	Aggregate Transmission Time	Limit	Test	Limit
5530	0	97.66 ms	200 ms	92.77 ms	60 ms	< 10 s	10 s

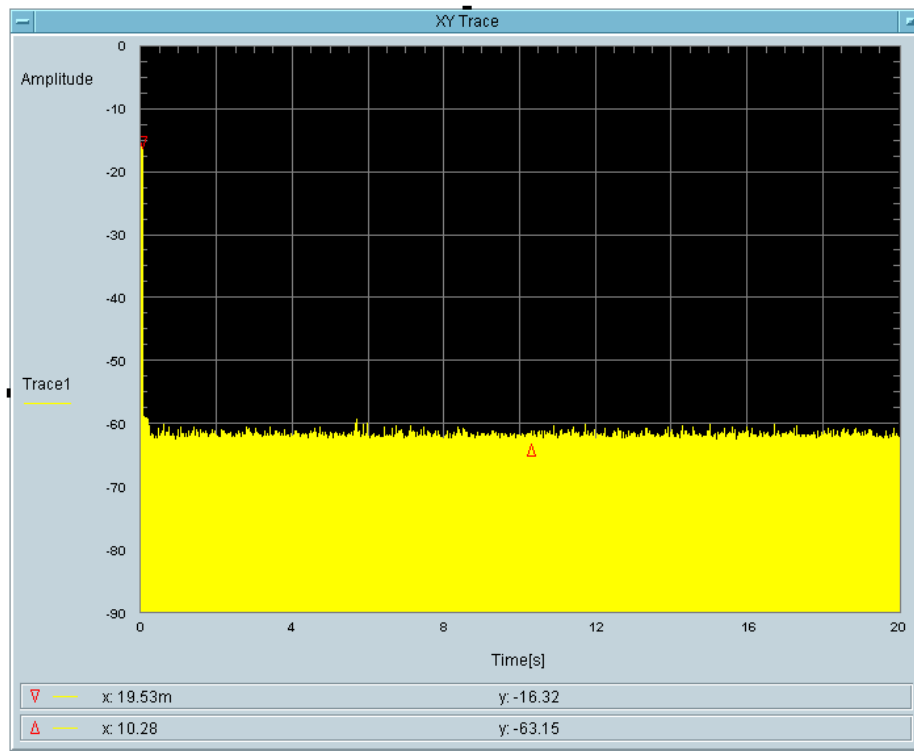

Total On Time [s]
97.66m

Total On Time After Delay [s]
92.77m

7 Non-Occupancy Time

5290 MHz

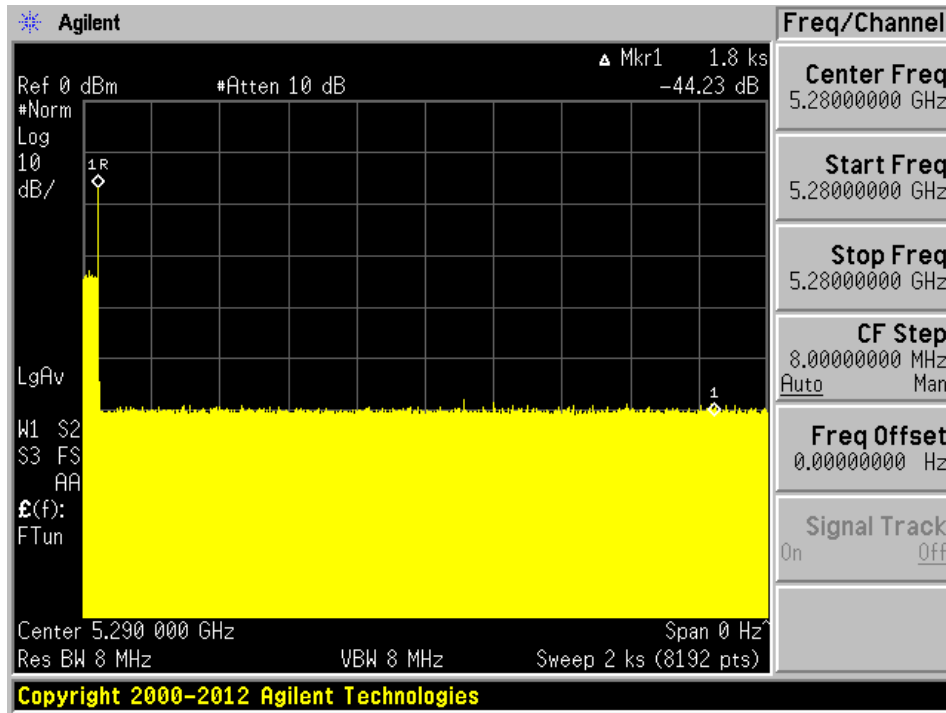

5530 MHz

