

## FCC Test Report (BT EDR)

**Report No.:** RF160719D06

**FCC ID:** CNFGVRC1

**Test Model:** GVRC1

**Received Date:** Jul. 7, 2016

**Test Date:** Jul. 7 ~ 21, 2016

**Issued Date:** Jul. 28, 2016

**Applicant:** GoPro, Inc.

**Address:** 3000 Clearview Way, San Mateo, CA 94402 USA

**Issued By:** Bureau Veritas Consumer Products Services (H.K.) Ltd., Taoyuan Branch

**Lab Address:** No. 47-2, 14th Ling, Chia Pau Vil., Lin Kou Dist., New Taipei City, Taiwan (R.O.C.)



This report is for your exclusive use. Any copying or replication of this report to or for any other person or entity, or use of our name or trademark, is permitted only with our prior written permission. This report sets forth our findings solely with respect to the test samples identified herein. The results set forth in this report are not indicative or representative of the quality or characteristics of the lot from which a test sample was taken or any similar or identical product unless specifically and expressly noted. Our report includes all of the tests requested by you and the results thereof based upon the information that you provided to us. You have 60 days from date of issuance of this report to notify us of any material error or omission caused by our negligence, provided, however, that such notice shall be in writing and shall specifically address the issue you wish to raise. A failure to raise such issue within the prescribed time shall constitute your unqualified acceptance of the completeness of this report, the tests conducted and the correctness of the report contents. Unless specific mention, the uncertainty of measurement has been explicitly taken into account to declare the compliance or non-compliance to the specification. The report must not be used by the client to claim product certification, approval, or endorsement by TAF or any government agencies.

## Table of Contents

<b>Release Control Record</b> .....	<b>4</b>
<b>1 Certificate of Conformity</b> .....	<b>5</b>
<b>2 Summary of Test Results</b> .....	<b>6</b>
2.1 Measurement Uncertainty.....	6
2.2 Modification Record.....	6
<b>3 General Information</b> .....	<b>7</b>
3.1 General Description of EUT.....	7
3.2 Description of Test Modes.....	8
3.2.1 Test Mode Applicability and Tested Channel Detail.....	9
3.3 Description of Support Units.....	11
3.3.1 Configuration of System under Test.....	12
3.4 General Description of Applied Standards.....	13
<b>4 Test Types and Results</b> .....	<b>14</b>
4.1 Radiated Emission and Bandedge Measurement.....	14
4.1.1 Limits of Radiated Emission and Bandedge Measurement.....	14
4.1.2 Test Instruments.....	15
4.1.3 Test Procedures.....	16
4.1.4 Deviation from Test Standard.....	16
4.1.5 Test Set Up.....	17
4.1.6 EUT Operating Conditions.....	17
4.1.7 Test Results.....	18
4.2 Conducted Emission Measurement.....	25
4.2.1 Limits of Conducted Emission Measurement.....	25
4.2.2 Test Instruments.....	25
4.2.3 Test Procedures.....	26
4.2.4 Deviation from Test Standard.....	26
4.2.5 Test Setup.....	26
4.2.6 EUT Operating Conditions.....	26
4.2.7 Test Results.....	27
4.3 Number of Hopping Frequency Used.....	31
4.3.1 Limits of Hopping Frequency Used Measurement.....	31
4.3.2 Test Setup.....	31
4.3.3 Test Instruments.....	31
4.3.4 Test Procedure.....	31
4.3.5 Deviation from Test Standard.....	31
4.3.6 Test Results.....	32
4.4 Dwell Time on Each Channel.....	33
4.4.1 Limits of Dwell Time on Each Channel Measurement.....	33
4.4.2 Test Setup.....	33
4.4.3 Test Instruments.....	33
4.4.4 Test Procedures.....	33
4.4.5 Deviation from Test Standard.....	33
4.4.6 Test Results.....	34
4.5 Channel Bandwidth.....	38
4.5.1 Limits of Channel Bandwidth Measurement.....	38
4.5.2 Test Setup.....	38
4.5.3 Test Instruments.....	38
4.5.4 Test Procedure.....	38
4.5.5 Deviation from Test Standard.....	38
4.5.6 EUT Operating Condition.....	38
4.5.7 Test Results.....	39
4.6 Hopping Channel Separation.....	40



4.6.1	Limits of Hopping Channel Separation Measurement.....	40
4.6.2	Test Setup .....	40
4.6.3	Test Instruments.....	40
4.6.4	Test Procedure .....	40
4.6.5	Deviation From Test Standard.....	40
4.6.6	Test Results.....	41
4.7	Maximum Output Power.....	42
4.7.1	Limits of Maximum Output Power Measurement .....	42
4.7.2	Test Setup .....	42
4.7.3	Test Instruments.....	42
4.7.4	Test Procedure .....	42
4.7.5	Deviation fromTest Standard.....	42
4.7.6	EUT Operating Condition.....	42
4.7.7	Test Results.....	43
4.8	Conducted Out of Band Emission Measurement.....	44
4.8.1	Limits Of Conducted Out Of Band Emission Measurement.....	44
4.8.2	Test Instruments.....	44
4.8.3	Test Procedure .....	44
4.8.4	Deviation From Test Standard.....	44
4.8.5	Eut Operating Condition .....	44
4.8.6	Test Results.....	44
<b>5</b>	<b>Pictures of Test Arrangements.....</b>	<b>47</b>
	<b>Appendix – Information on the Testing Laboratories.....</b>	<b>48</b>



### Release Control Record

Issue No.	Description	Date Issued
RF160719D06	Original release.	Jul. 28, 2016



## 2 Summary of Test Results

47 CFR FCC Part 15, Subpart C (SECTION 15.247)			
FCC Clause	Test Item	Result	Remarks
15.207	AC Power Conducted Emission	PASS	Meet the requirement of limit. Minimum passing margin is -16.33dB at 0.76328MHz.
15.247(a)(1)(iii)	Number of Hopping Frequency Used	PASS	Meet the requirement of limit.
15.247(a)(1)(iii)	Dwell Time on Each Channel	PASS	Meet the requirement of limit.
15.247(a)(1)	1. Hopping Channel Separation 2. Spectrum Bandwidth of a Frequency Hopping Sequence Spread Spectrum System	PASS	Meet the requirement of limit.
15.247(b)	Maximum Peak Output Power	PASS	Meet the requirement of limit.
15.205 / 15.209 / 15.247(d)	Radiated Emissions and Band Edge Measurement	PASS	Meet the requirement of limit. Minimum passing margin is -12.02dB at 2483.50MHz.
15.247(d)	Antenna Port Emission	PASS	Meet the requirement of limit.
15.203	Antenna Requirement	PASS	No antenna connector is used.

**NOTE:** If The Frequency Hopping System operating in 2400-2483.5MHz band and the output power less than 125mW. The hopping channel carrier frequencies separated by a minimum of 25kHz or two-thirds of the 20dB bandwidth of hopping channel whichever is greater.

### 2.1 Measurement Uncertainty

Where relevant, the following measurement uncertainty levels have been estimated for tests performed on the EUT as specified in CISPR 16-4-2:

Measurement	Frequency	Expanded Uncertainty (k=2) (±)
Conducted Emissions at mains ports	150kHz ~ 30MHz	2.78 dB
Radiated Emissions up to 1 GHz	30MHz ~ 1000MHz	4.00 dB
Radiated Emissions above 1 GHz	Above 1GHz	3.36 dB

### 2.2 Modification Record

There were no modifications required for compliance.

### 3 General Information

#### 3.1 General Description of EUT

Product	REMOTE
Brand	GoPro
Test Model	GVRC1
Status of EUT	Engineering sample
Power Supply Rating	3.7Vdc (from battery) or 5.0Vdc (from host equipment or Adapter)
Modulation Type	GFSK, $\pi/4$ -DQPSK, 8DPSK
Modulation Technology	FHSS
Transfer Rate	1/2/3Mbps
Operating Frequency	2402 ~ 2480MHz
Number of Channel	79
Output Power	6.982mW
Antenna Type	PCB antenna with -0.95dBi gain
Antenna Connector	N/A
Accessory Device	N/A
Data Cable Supplied	Shielded USB (0.5 m) cable.

Note:

1. The EUT is a REMOTE.
2. The EUT was pre-tested with the following modes:
  - <sup>2</sup> Operating Mode (EUT stand-alone)
  - <sup>2</sup> Operating + Charging Mode (EUT + Notebook)
  - <sup>2</sup> Operating + Charging Mode (EUT + Adapter)
 The worst emission level was found when the EUT tested under **Operating + Charging Mode (EUT + Notebook)** therefore, only its test data was recorded in this report.
3. The above EUT information is declared by manufacturer and for more detailed features description, please refer to the manufacturer's specifications or user's manual.

### 3.2 Description of Test Modes

79 channels are provided to this EUT

Channel	Freq. (MHz)	Channel	Freq. (MHz)	Channel	Freq. (MHz)	Channel	Freq. (MHz)
0	2402	20	2422	40	2442	60	2462
1	2403	21	2423	41	2443	61	2463
2	2404	22	2424	42	2444	62	2464
3	2405	23	2425	43	2445	63	2465
4	2406	24	2426	44	2446	64	2466
5	2407	25	2427	45	2447	65	2467
6	2408	26	2428	46	2448	66	2468
7	2409	27	2429	47	2449	67	2469
8	2410	28	2430	48	2450	68	2470
9	2411	29	2431	49	2451	69	2471
10	2412	30	2432	50	2452	70	2472
11	2413	31	2433	51	2453	71	2473
12	2414	32	2434	52	2454	72	2474
13	2415	33	2435	53	2455	73	2475
14	2416	34	2436	54	2456	74	2476
15	2417	35	2437	55	2457	75	2477
16	2418	36	2438	56	2458	76	2478
17	2419	37	2439	57	2459	77	2479
18	2420	38	2440	58	2460	78	2480
19	2421	39	2441	59	2461		



### 3.2.1 Test Mode Applicability and Tested Channel Detail

EUT CONFIGURE MODE	APPLICABLE TO				DESCRIPTION
	RE <sup>3</sup> 1G	RE<1G	PLC	APCM	
A	√	√	√	√	Operating + Charging Mode (EUT + Notebook)
B	-	-	√	-	Operating + Charging Mode (EUT + Adapter)

Where **RE<sup>3</sup>1G**: Radiated Emission above 1GHz      **RE<1G**: Radiated Emission below 1GHz  
**PLC**: Power Line Conducted Emission      **APCM**: Antenna Port Conducted Measurement

**NOTE:** The EUT had been pre-tested on the positioned of each 3 axis. The worst case was found when positioned on **X-plane**.

#### **Radiated Emission Test (Above 1GHz):**

- Pre-Scan has been conducted to determine the worst-case mode from all possible combinations between available modulations, data rates and antenna ports (if EUT with antenna diversity architecture).
- Following channel(s) was (were) selected for the final test as listed below.

EUT CONFIGURE MODE	AVAILABLE CHANNEL	TESTED CHANNEL	MODULATION TECHNOLOGY	MODULATION TYPE	PACKET TYPE
A	0 to 78	0, 39, 78	FHSS	GFSK	DH5
A	0 to 78	0, 39, 78	FHSS	8DPSK	DH5

#### **Radiated Emission Test (Below 1GHz):**

- Pre-Scan has been conducted to determine the worst-case mode from all possible combinations between available modulations, data rates and antenna ports (if EUT with antenna diversity architecture).
- Following channel(s) was (were) selected for the final test as listed below.

EUT CONFIGURE MODE	AVAILABLE CHANNEL	TESTED CHANNEL	MODULATION TECHNOLOGY	MODULATION TYPE	PACKET TYPE
A	0 to 78	39	FHSS	GFSK	DH5

#### **Power Line Conducted Emission Test:**

- Pre-Scan has been conducted to determine the worst-case mode from all possible combinations between available modulations, data rates and antenna ports (if EUT with antenna diversity architecture).
- Following channel(s) was (were) selected for the final test as listed below.

EUT CONFIGURE MODE	AVAILABLE CHANNEL	TESTED CHANNEL	MODULATION TECHNOLOGY	MODULATION TYPE	PACKET TYPE
A	0 to 78	39	FHSS	GFSK	DH5
B	0 to 78	39	FHSS	GFSK	DH5

### Antenna Port Conducted Measurement:

- This item includes all test value of each mode, but only includes spectrum plot of worst value of each mode.
- Pre-Scan has been conducted to determine the worst-case mode from all possible combinations between available modulations, data rates and antenna ports (if EUT with antenna diversity architecture).
- Following channel(s) was (were) selected for the final test as listed below.

EUT CONFIGURE MODE	AVAILABLE CHANNEL	TESTED CHANNEL	MODULATION TECHNOLOGY	MODULATION TYPE	PACKET TYPE
A	0 to 78	0, 39, 78	FHSS	GFSK	DH5
A	0 to 78	0, 39, 78	FHSS	8DPSK	DH5

### Test Condition:

APPLICABLE TO	MODE	ENVIRONMENTAL CONDITIONS	INPUT POWER	TESTED BY
RE <sup>3</sup> 1G	A	26deg. C, 61%RH	120Vac, 60Hz (System)	Ian Chang
RE<1G	A	26deg. C, 61%RH	120Vac, 60Hz (System)	Ian Chang
PLC	A	26deg. C, 68%RH	120Vac, 60Hz (System)	Ian Chang
	B	26deg. C, 68%RH	120Vac, 60Hz (Adapter)	Ian Chang
APCM	A	25deg. C, 60%RH	120Vac, 60Hz (System)	Saxon Lee

### 3.3 Description of Support Units

The EUT has been tested as an independent unit together with other necessary accessories or support units. The following support units or accessories were used to form a representative test configuration during the tests.

ID	Product	Brand	Model No.	Serial No.	FCC ID	Remarks
A.	NOTEBOOK COMPUTER	DELL	PP27L	8SNZ12S	FCC DoC Approved	Provided by Lab
B.	Adapter	Apple	A1385	N/A	FCC DoC Approved	Provided by Lab

Note: All power cords of the above support units are non-shielded (1.8m).

ID	Descriptions	Qty.	Length (m)	Shielding (Yes/No)	Cores (Qty.)	Remarks
1.	USB cable	1	0.5	Y	0	Supplied by client

Note: The core(s) is(are) originally attached to the cable(s).

### 3.3.1 Configuration of System under Test

#### Mode A

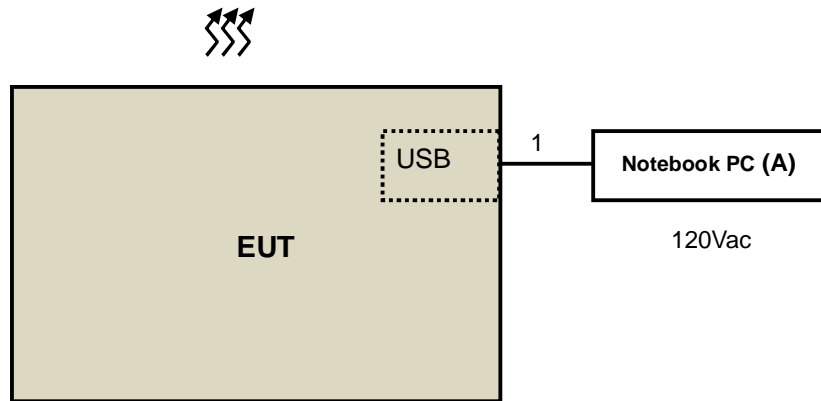

#### Mode B

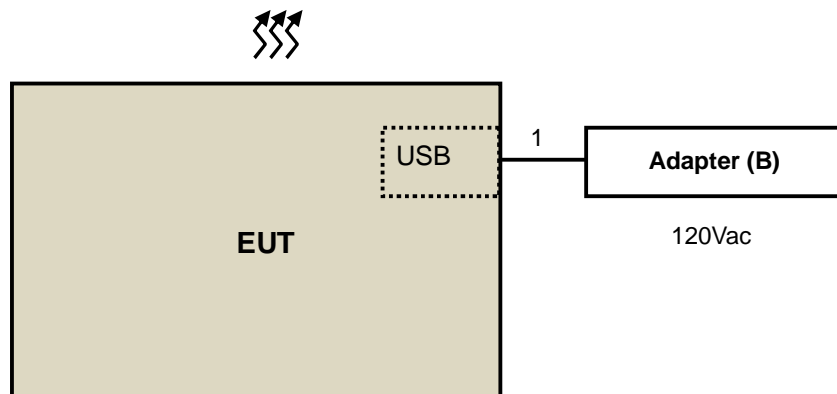

### 3.4 General Description of Applied Standards

The EUT is a RF Product. According to the specifications of the manufacturer, it must comply with the requirements of the following standards:

**FCC Part 15, Subpart C (15.247)**

ANSI C63.10-2013

All test items have been performed and recorded as per the above standards.

## 4 Test Types and Results

### 4.1 Radiated Emission and Bandedge Measurement

#### 4.1.1 Limits of Radiated Emission and Bandedge Measurement

Radiated emissions which fall in the restricted bands must comply with the radiated emission limits specified as below table. Other emissions shall be at least 20dB below the highest level of the desired power:

Frequencies (MHz)	Field Strength (microvolts/meter)	Measurement Distance (meters)
0.009 ~ 0.490	2400/F(kHz)	300
0.490 ~ 1.705	24000/F(kHz)	30
1.705 ~ 30.0	30	30
30 ~ 88	100	3
88 ~ 216	150	3
216 ~ 960	200	3
Above 960	500	3

**NOTE:**

1. The lower limit shall apply at the transition frequencies.
2. Emission level (dBuV/m) = 20 log Emission level (uV/m).
3. For frequencies above 1000MHz, the field strength limits are based on average detector, however, the peak field strength of any emission shall not exceed the maximum permitted average limits, specified above by more than 20dB under any condition of modulation.

#### 4.1.2 Test Instruments

DESCRIPTION & MANUFACTURER	MODEL NO.	SERIAL NO.	CALIBRATED DATE	CALIBRATED UNTIL
HP Preamplifier	8447D	2432A03504	Feb. 26, 2016	Feb. 25, 2017
HP Preamplifier	8449B	3008A01201	Feb. 26, 2016	Feb. 25, 2017
MITEQ Preamplifier	AMF-6F-260400-3 3-8P	892164	Mar. 01, 2016	Feb. 28, 2017
Agilent TEST RECEIVER	N9038A	MY51210129	Feb. 02, 2016	Feb. 01, 2017
Schwarzbeck Antenna	VULB 9168	139	Jan. 04, 2016	Jan. 03, 2017
Schwarzbeck Antenna	VHBA 9123	480	May 29, 2015	May 28, 2017
Schwarzbeck Horn Antenna	BBHA-9170	212	Jan. 08, 2016	Jan. 07, 2017
Schwarzbeck Horn Antenna	BBHA 9120-D1	D130	Jan. 21, 2016	Jan. 20, 2017
ADT. Turn Table	TT100	0306	NA	NA
ADT. Tower	AT100	0306	NA	NA
Software	Radiated_V7.6.15. 9.4	NA	NA	NA
SUHNER RF cable With 4dB PAD	SF104	CABLE-CH6	Aug. 15, 2015	Aug. 14, 2016
SUHNER RF cable With 3dB PAD	SF102	Cable-CH8-3.6m	Aug. 15, 2015	Aug. 14, 2016
KEYSIGHT MIMO Powermeasurement Test set	U2021XA	U2021XA-001	May 25, 2016	May 24, 2017
EMCO Horn Antenna	3115	00028257	Jan. 19, 2016	Jan. 18, 2017
Highpass filter Wainwright Instruments	WHK 3.1/18G-10SS	SN 8	NA	NA
ROHDE & SCHWARZ Spectrum Analyzer	FSV40	101042	Sep. 23, 2015	Sep. 22, 2016
Anritsu Power Sensor	MA2411B	0738404	Apr. 28, 2016	Apr. 27, 2017
Anritsu Power Meter	ML2495A	0842014	Apr. 28, 2016	Apr. 27, 2017

- NOTE:** 1. The calibration interval of the above test instruments is 12/24 months. And the calibrations are traceable to NML/ROC and NIST/USA.
2. The horn antenna and HP preamplifier (model: 8449B) are used only for the measurement of emission frequency above 1GHz if tested.
3. The test was performed in Chamber No. 6.
4. The Industry Canada Reference No. IC 7450E-6.
5. The FCC Site Registration No. is 447212.

#### 4.1.3 Test Procedures

- a. The EUT was placed on the top of a rotating table 0.8 meters (for below 1GHz) / 1.5 meters (for above 1GHz) above the ground at 3 meter chamber room for test. The table was rotated 360 degrees to determine the position of the highest radiation.
- b. The EUT was set 3 meters away from the interference-receiving antenna, which was mounted on the top of a variable-height antenna tower.
- c. The height of antenna is varied from one meter to four meters above the ground to determine the maximum value of the field strength. Both horizontal and vertical polarizations of the antenna are set to make the measurement.
- d. For each suspected emission, the EUT was arranged to its worst case and then the antenna was tuned to heights from 1 meter to 4 meters and the rotatable table was turned from 0 degrees to 360 degrees to find the maximum reading.
- e. The test-receiver system was set to quasi-peak detect function and specified bandwidth with maximum hold mode when the test frequency is below 1 GHz.
- f. The test-receiver system was set to peak detect function and specified bandwidth with maximum hold mode when the test frequency is above 1 GHz.

**Note:**

1. The resolution bandwidth and video bandwidth of test receiver/spectrum analyzer is 120kHz for Quasi-peak detection (QP) at frequency below 1GHz.
2. The resolution bandwidth of test receiver/spectrum analyzer is 1 MHz and the video bandwidth is 3 MHz for Peak detection (PK) at frequency above 1GHz.
3. All modes of operation were investigated and the worst-case emissions are reported.
4. The setting of RBW/VBW is 1MHz/ 10Hz for AV (RMS) measurement.

#### 4.1.4 Deviation from Test Standard

No deviation.



#### 4.1.5 Test Set Up

##### <Frequency Range below 1GHz>

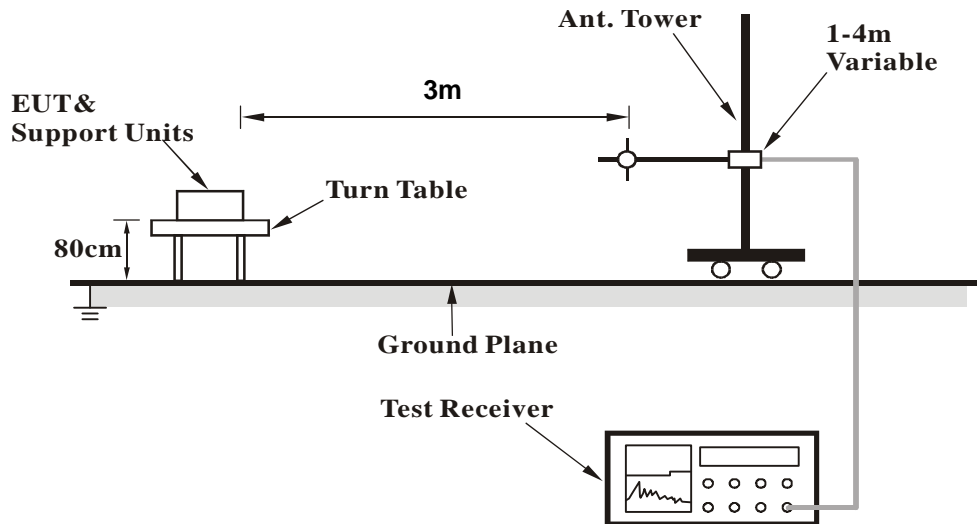

##### <Frequency Range above 1GHz>

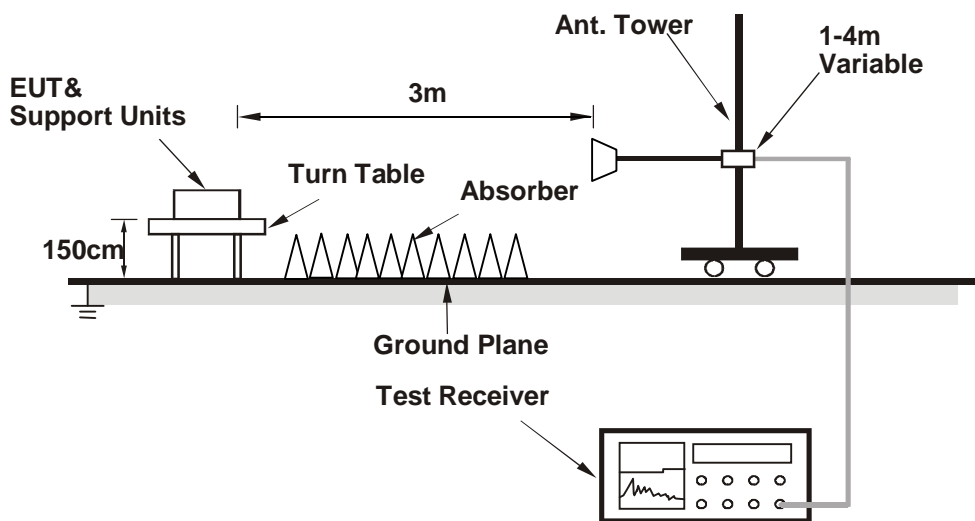

For the actual test configuration, please refer to the attached file (Test Setup Photo).

#### 4.1.6 EUT Operating Conditions

- Placed the EUT on the testing table.
- Set the EUT under transmission condition continuously at specific channel frequency.

4.1.7 Test Results

Mode A

ABOVE 1GHz DATA

BT\_GFSK

<b>CHANNEL</b>	TX Channel 0	<b>DETECTOR FUNCTION</b>	Peak (PK)
<b>FREQUENCY RANGE</b>	1GHz ~ 25GHz		Average (AV)
			RB=1MHz, VB=10Hz

**ANTENNA POLARITY & TEST DISTANCE: HORIZONTAL AT 3 M**

NO.	FREQ. (MHz)	EMISSION LEVEL (dBuV/m)	LIMIT (dBuV/m)	MARGIN (dB)	ANTENNA HEIGHT (m)	TABLE ANGLE (Degree)	RAW VALUE (dBuV)	CORRECTION FACTOR (dB/m)
1	2390.00	55.33 PK	74.00	-18.67	2.44 H	118	55.64	-0.31
2	2390.00	40.95 AV	54.00	-13.05	2.44 H	118	41.26	-0.31
3	*2402.00	100.56 PK			2.44 H	118	100.80	-0.24
4	*2402.00	60.35 AV			2.44 H	118	60.59	-0.24
5	4804.00	50.93 PK	74.00	-23.07	1.00 H	360	44.85	6.08
6	4804.00	35.83 AV	54.00	-18.17	1.00 H	360	29.75	6.08
7	#7206.00	54.20 PK	74.00	-19.80	1.77 H	67	40.78	13.42
8	#7206.00	38.98 AV	54.00	-15.02	1.77 H	67	25.56	13.42

**ANTENNA POLARITY & TEST DISTANCE: VERTICAL AT 3 M**

NO.	FREQ. (MHz)	EMISSION LEVEL (dBuV/m)	LIMIT (dBuV/m)	MARGIN (dB)	ANTENNA HEIGHT (m)	TABLE ANGLE (Degree)	RAW VALUE (dBuV)	CORRECTION FACTOR (dB/m)
1	2390.00	54.86 PK	74.00	-19.14	3.84 V	11	55.17	-0.31
2	2390.00	40.65 AV	54.00	-13.35	3.84 V	11	40.96	-0.31
3	*2402.00	94.38 PK			3.84 V	11	94.62	-0.24
4	*2402.00	58.23 AV			3.84 V	11	58.47	-0.24
5	4804.00	47.12 PK	74.00	-26.88	3.94 V	242	41.04	6.08
6	4804.00	33.17 AV	54.00	-20.83	3.94 V	242	27.09	6.08
7	#7206.00	53.37 PK	74.00	-20.63	1.03 V	61	39.95	13.42
8	#7206.00	38.33 AV	54.00	-15.67	1.03 V	61	24.91	13.42

**REMARKS:**

1. Emission Level(dBuV/m) = Raw Value(dBuV) + Correction Factor(dB/m)
2. Correction Factor(dB/m) = Antenna Factor(dB/m) + Cable Factor(dB) – Pre-Amplifier Factor(dB)
3. The other emission levels were very low against the limit.
4. Margin value = Emission Level – Limit value
5. " \* ": Fundamental frequency.
6. " # ": The radiated frequency is out of the restricted band.

<b>CHANNEL</b>	TX Channel 39	<b>DETECTOR FUNCTION</b>	Peak (PK)
<b>FREQUENCY RANGE</b>	1GHz ~ 25GHz		Average (AV) RB=1MHz, VB=10Hz

**ANTENNA POLARITY & TEST DISTANCE: HORIZONTAL AT 3 M**

NO.	FREQ. (MHz)	EMISSION LEVEL (dBuV/m)	LIMIT (dBuV/m)	MARGIN (dB)	ANTENNA HEIGHT (m)	TABLE ANGLE (Degree)	RAW VALUE (dBuV)	CORRECTION FACTOR (dB/m)
1	*2441.00	101.36 PK			2.63 H	127	101.35	0.01
2	*2441.00	60.62 AV			2.63 H	127	60.61	0.01
3	4882.00	51.31 PK	74.00	-22.69	1.06 H	356	45.16	6.15
4	4882.00	36.79 AV	54.00	-17.21	1.06 H	356	30.64	6.15
5	7323.00	54.68 PK	74.00	-19.32	1.68 H	264	41.15	13.53
6	7323.00	40.06 AV	54.00	-13.94	1.68 H	264	26.53	13.53

**ANTENNA POLARITY & TEST DISTANCE: VERTICAL AT 3 M**

NO.	FREQ. (MHz)	EMISSION LEVEL (dBuV/m)	LIMIT (dBuV/m)	MARGIN (dB)	ANTENNA HEIGHT (m)	TABLE ANGLE (Degree)	RAW VALUE (dBuV)	CORRECTION FACTOR (dB/m)
1	*2441.00	95.87 PK			3.78 V	19	95.86	0.01
2	*2441.00	59.66 AV			3.78 V	19	59.65	0.01
3	4882.00	48.33 PK	74.00	-25.67	3.74 V	256	42.18	6.15
4	4882.00	35.11 AV	54.00	-18.89	3.74 V	256	28.96	6.15
5	7323.00	54.38 PK	74.00	-19.62	1.11 V	58	40.85	13.53
6	7323.00	39.68 AV	54.00	-14.32	1.11 V	58	26.15	13.53

**REMARKS:**

1. Emission Level(dBuV/m) = Raw Value(dBuV) + Correction Factor(dB/m)
2. Correction Factor(dB/m) = Antenna Factor(dB/m) + Cable Factor(dB) – Pre-Amplifier Factor(dB)
3. The other emission levels were very low against the limit.
4. Margin value = Emission Level – Limit value
5. " \* ": Fundamental frequency.

<b>CHANNEL</b>	TX Channel 78	<b>DETECTOR FUNCTION</b>	Peak (PK)
<b>FREQUENCY RANGE</b>	1GHz ~ 25GHz		Average (AV) RB=1MHz, VB=10Hz

**ANTENNA POLARITY & TEST DISTANCE: HORIZONTAL AT 3 M**

NO.	FREQ. (MHz)	EMISSION LEVEL (dBuV/m)	LIMIT (dBuV/m)	MARGIN (dB)	ANTENNA HEIGHT (m)	TABLE ANGLE (Degree)	RAW VALUE (dBuV)	CORRECTION FACTOR (dB/m)
1	*2480.00	99.73 PK			2.59 H	119	99.46	0.27
2	*2480.00	60.26 AV			2.59 H	119	59.99	0.27
3	2483.50	56.15 PK	74.00	-17.85	2.59 H	119	55.86	0.29
<b>4</b>	<b>2483.50</b>	<b>41.98 AV</b>	<b>54.00</b>	<b>-12.02</b>	<b>2.59 H</b>	<b>119</b>	<b>41.69</b>	<b>0.29</b>
5	4960.00	51.08 PK	74.00	-22.92	1.58 H	282	44.79	6.29
6	4960.00	35.95 AV	54.00	-18.05	1.58 H	282	29.66	6.29
7	7440.00	54.65 PK	74.00	-19.35	1.89 H	86	40.74	13.91
8	7440.00	39.37 AV	54.00	-14.63	1.89 H	86	25.46	13.91

**ANTENNA POLARITY & TEST DISTANCE: VERTICAL AT 3 M**

NO.	FREQ. (MHz)	EMISSION LEVEL (dBuV/m)	LIMIT (dBuV/m)	MARGIN (dB)	ANTENNA HEIGHT (m)	TABLE ANGLE (Degree)	RAW VALUE (dBuV)	CORRECTION FACTOR (dB/m)
1	*2480.00	94.90 PK			3.76 V	23	94.63	0.27
2	*2480.00	58.53 AV			3.76 V	23	58.26	0.27
3	2483.50	54.45 PK	74.00	-19.55	3.76 V	15	54.16	0.29
4	2483.50	40.35 AV	54.00	-13.65	3.76 V	15	40.06	0.29
5	4960.00	48.44 PK	74.00	-25.56	3.64 V	258	42.15	6.29
6	4960.00	34.70 AV	54.00	-19.30	3.64 V	258	28.41	6.29
7	7440.00	53.53 PK	74.00	-20.47	1.11 V	94	39.62	13.91
8	7440.00	38.49 AV	54.00	-15.51	1.11 V	94	24.58	13.91

**REMARKS:**

1. Emission Level(dBuV/m) = Raw Value(dBuV) + Correction Factor(dB/m)
2. Correction Factor(dB/m) = Antenna Factor(dB/m) + Cable Factor(dB) – Pre-Amplifier Factor(dB)
3. The other emission levels were very low against the limit.
4. Margin value = Emission Level – Limit value
5. " \* ": Fundamental frequency.

**BT\_8DPSK**

<b>CHANNEL</b>	TX Channel 0	<b>DETECTOR FUNCTION</b>	Peak (PK)
<b>FREQUENCY RANGE</b>	1GHz ~ 25GHz		Average (AV) RB=1MHz, VB=10Hz

**ANTENNA POLARITY & TEST DISTANCE: HORIZONTAL AT 3 M**

NO.	FREQ. (MHz)	EMISSION LEVEL (dBuV/m)	LIMIT (dBuV/m)	MARGIN (dB)	ANTENNA HEIGHT (m)	TABLE ANGLE (Degree)	RAW VALUE (dBuV)	CORRECTION FACTOR (dB/m)
1	2390.00	54.86 PK	74.00	-19.14	2.43 H	124	55.17	-0.31
2	2390.00	40.85 AV	54.00	-13.15	2.43 H	124	41.16	-0.31
3	*2402.00	97.88 PK			2.43 H	124	98.12	-0.24
4	*2402.00	83.54 AV			2.43 H	124	83.78	-0.24
5	4804.00	48.93 PK	74.00	-25.07	1.00 H	279	42.85	6.08
6	4804.00	37.47 AV	54.00	-16.53	1.00 H	279	31.39	6.08
7	#7206.00	53.07 PK	74.00	-20.93	1.87 H	85	39.65	13.42
8	#7206.00	37.98 AV	54.00	-16.02	1.87 H	85	24.56	13.42

**ANTENNA POLARITY & TEST DISTANCE: VERTICAL AT 3 M**

NO.	FREQ. (MHz)	EMISSION LEVEL (dBuV/m)	LIMIT (dBuV/m)	MARGIN (dB)	ANTENNA HEIGHT (m)	TABLE ANGLE (Degree)	RAW VALUE (dBuV)	CORRECTION FACTOR (dB/m)
1	2390.00	54.35 PK	74.00	-19.65	3.81 V	206	54.66	-0.31
2	2390.00	39.94 AV	54.00	-14.06	3.81 V	206	40.25	-0.31
3	*2402.00	91.80 PK			3.81 V	206	92.04	-0.24
4	*2402.00	78.82 AV			3.81 V	206	79.06	-0.24
5	4804.00	46.74 PK	74.00	-27.26	3.68 V	235	40.66	6.08
6	4804.00	34.39 AV	54.00	-19.61	3.68 V	235	28.31	6.08
7	#7206.00	51.88 PK	74.00	-22.12	1.53 V	118	38.46	13.42
8	#7206.00	37.27 AV	54.00	-16.73	1.53 V	118	23.85	13.42

**REMARKS:**

1. Emission Level(dBuV/m) = Raw Value(dBuV) + Correction Factor(dB/m)
2. Correction Factor(dB/m) = Antenna Factor(dB/m) + Cable Factor(dB) – Pre-Amplifier Factor(dB)
3. The other emission levels were very low against the limit.
4. Margin value = Emission Level – Limit value
5. " \* ": Fundamental frequency.
6. " # ": The radiated frequency is out of the restricted band.

<b>CHANNEL</b>	TX Channel 39	<b>DETECTOR FUNCTION</b>	Peak (PK)
<b>FREQUENCY RANGE</b>	1GHz ~ 25GHz		Average (AV) RB=1MHz, VB=10Hz

**ANTENNA POLARITY & TEST DISTANCE: HORIZONTAL AT 3 M**

NO.	FREQ. (MHz)	EMISSION LEVEL (dBuV/m)	LIMIT (dBuV/m)	MARGIN (dB)	ANTENNA HEIGHT (m)	TABLE ANGLE (Degree)	RAW VALUE (dBuV)	CORRECTION FACTOR (dB/m)
1	*2441.00	99.28 PK			2.63 H	129	99.27	0.01
2	*2441.00	84.87 AV			2.63 H	129	84.86	0.01
3	4882.00	48.37 PK	74.00	-25.63	1.06 H	241	42.22	6.15
4	4882.00	37.21 AV	54.00	-16.79	1.06 H	241	31.06	6.15
5	7323.00	53.68 PK	74.00	-20.32	1.96 H	79	40.15	13.53
6	7323.00	39.38 AV	54.00	-14.62	1.96 H	79	25.85	13.53

**ANTENNA POLARITY & TEST DISTANCE: VERTICAL AT 3 M**

NO.	FREQ. (MHz)	EMISSION LEVEL (dBuV/m)	LIMIT (dBuV/m)	MARGIN (dB)	ANTENNA HEIGHT (m)	TABLE ANGLE (Degree)	RAW VALUE (dBuV)	CORRECTION FACTOR (dB/m)
1	*2441.00	93.13 PK			3.73 V	197	93.12	0.01
2	*2441.00	80.55 AV			3.73 V	197	80.54	0.01
3	4882.00	47.21 PK	74.00	-26.79	1.12 V	251	41.06	6.15
4	4882.00	36.69 AV	54.00	-17.31	1.12 V	251	30.54	6.15
5	7323.00	53.31 PK	74.00	-20.69	2.03 V	84	39.78	13.53
6	7323.00	38.76 AV	54.00	-15.24	2.03 V	84	25.23	13.53

**REMARKS:**

1. Emission Level(dBuV/m) = Raw Value(dBuV) + Correction Factor(dB/m)
2. Correction Factor(dB/m) = Antenna Factor(dB/m) + Cable Factor(dB) – Pre-Amplifier Factor(dB)
3. The other emission levels were very low against the limit.
4. Margin value = Emission Level – Limit value
5. " \* ": Fundamental frequency.

<b>CHANNEL</b>	TX Channel 78	<b>DETECTOR FUNCTION</b>	Peak (PK)
<b>FREQUENCY RANGE</b>	1GHz ~ 25GHz		Average (AV) RB=1MHz, VB=10Hz

**ANTENNA POLARITY & TEST DISTANCE: HORIZONTAL AT 3 M**

NO.	FREQ. (MHz)	EMISSION LEVEL (dBuV/m)	LIMIT (dBuV/m)	MARGIN (dB)	ANTENNA HEIGHT (m)	TABLE ANGLE (Degree)	RAW VALUE (dBuV)	CORRECTION FACTOR (dB/m)
1	*2480.00	97.89 PK			2.34 H	302	97.62	0.27
2	*2480.00	83.55 AV			2.34 H	302	83.28	0.27
3	2483.50	54.97 PK	74.00	-19.03	2.34 H	302	54.68	0.29
4	2483.50	41.53 AV	54.00	-12.47	2.34 H	302	41.24	0.29
5	4960.00	47.85 PK	74.00	-26.15	1.06 H	296	41.56	6.29
6	4960.00	36.98 AV	54.00	-17.02	1.06 H	296	30.69	6.29
7	7440.00	52.37 PK	74.00	-21.63	2.04 H	46	38.46	13.91
8	7440.00	38.52 AV	54.00	-15.48	2.04 H	46	24.61	13.91

**ANTENNA POLARITY & TEST DISTANCE: VERTICAL AT 3 M**

NO.	FREQ. (MHz)	EMISSION LEVEL (dBuV/m)	LIMIT (dBuV/m)	MARGIN (dB)	ANTENNA HEIGHT (m)	TABLE ANGLE (Degree)	RAW VALUE (dBuV)	CORRECTION FACTOR (dB/m)
1	*2480.00	91.91 PK			3.51 V	223	91.64	0.27
2	*2480.00	78.73 AV			3.51 V	223	78.46	0.27
3	2483.50	53.75 PK	74.00	-20.25	3.51 V	223	53.46	0.29
4	2483.50	40.95 AV	54.00	-13.05	3.51 V	223	40.66	0.29
5	4960.00	46.54 PK	74.00	-27.46	1.19 V	241	40.25	6.29
6	4960.00	35.95 AV	54.00	-18.05	1.19 V	241	29.66	6.29
7	7440.00	51.79 PK	74.00	-22.21	1.62 V	42	37.88	13.91
8	7440.00	38.06 AV	54.00	-15.94	1.62 V	42	24.15	13.91

**REMARKS:**

1. Emission Level(dBuV/m) = Raw Value(dBuV) + Correction Factor(dB/m)
2. Correction Factor(dB/m) = Antenna Factor(dB/m) + Cable Factor(dB) – Pre-Amplifier Factor(dB)
3. The other emission levels were very low against the limit.
4. Margin value = Emission Level – Limit value
5. " \* ": Fundamental frequency.

**Mode A**

**BELOW 1GHz WORST-CASE DATA**

**BT\_GFSK**

<b>CHANNEL</b>	TX Channel 39	<b>DETECTOR FUNCTION</b>	Quasi-Peak (QP)
<b>FREQUENCY RANGE</b>	30MHz ~ 1GHz		

**ANTENNA POLARITY & TEST DISTANCE: HORIZONTAL AT 3 M**

NO.	FREQ. (MHz)	EMISSION LEVEL (dBuV/m)	LIMIT (dBuV/m)	MARGIN (dB)	ANTENNA HEIGHT (m)	TABLE ANGLE (Degree)	RAW VALUE (dBuV)	CORRECTION FACTOR (dB/m)
1	36.50	21.89 QP	40.00	-18.11	2.36 H	23	32.87	-10.98
2	163.71	19.43 QP	43.50	-24.07	1.95 H	4	28.79	-9.36
3	352.04	21.72 QP	46.00	-24.28	1.78 H	4	28.73	-7.01
4	585.66	26.73 QP	46.00	-19.27	2.20 H	76	28.59	-1.86
5	691.69	29.76 QP	46.00	-16.24	1.42 H	43	29.93	-0.17
6	809.06	31.38 QP	46.00	-14.62	1.35 H	0	29.53	1.85

**ANTENNA POLARITY & TEST DISTANCE: VERTICAL AT 3 M**

NO.	FREQ. (MHz)	EMISSION LEVEL (dBuV/m)	LIMIT (dBuV/m)	MARGIN (dB)	ANTENNA HEIGHT (m)	TABLE ANGLE (Degree)	RAW VALUE (dBuV)	CORRECTION FACTOR (dB/m)
1	36.30	22.43 QP	40.00	-17.57	2.51 V	10	33.46	-11.03
2	66.04	19.54 QP	40.00	-20.46	1.75 V	175	30.48	-10.94
3	146.01	19.21 QP	43.50	-24.29	1.66 V	167	28.91	-9.70
4	319.35	20.74 QP	46.00	-25.26	2.96 V	138	28.16	-7.42
5	504.33	25.07 QP	46.00	-20.93	1.58 V	218	28.57	-3.50
6	617.04	28.63 QP	46.00	-17.37	1.19 V	19	29.82	-1.19

**REMARKS:**

1. Emission Level(dBuV/m) = Raw Value(dBuV) + Correction Factor(dB/m)
2. Correction Factor(dB/m) = Antenna Factor(dB/m) + Cable Factor(dB) – Pre-Amplifier Factor(dB)
3. The other emission levels were very low against the limit.
4. Margin value = Emission Level – Limit value



## 4.2 Conducted Emission Measurement

### 4.2.1 Limits of Conducted Emission Measurement

Frequency (MHz)	Conducted Limit (dBuV)	
	Quasi-peak	Average
0.15 - 0.5	66 - 56	56 - 46
0.50 - 5.0	56	46
5.0 - 30.0	60	50

Note: 1. The lower limit shall apply at the transition frequencies.

2. The limit decreases in line with the logarithm of the frequency in the range of 0.15 to 0.50MHz.

### 4.2.2 Test Instruments

Description & Manufacturer	Model No.	Serial No.	Cal. Date	Cal. Due
ROHDE & SCHWARZ TEST RECEIVER	ESCS 30	100276	Apr. 12, 2016	Apr. 11, 2017
ROHDE & SCHWARZ Artificial Mains Network (for EUT)	ENV216	101197	May 04, 2016	May 03, 2017
LISN With Adapter (for EUT)	AD10	C10Ada-002	May 04, 2016	May 03, 2017
ROHDE & SCHWARZ Artificial Mains Network (for peripherals)	ESH3-Z5	100218	Nov. 25, 2015	Nov. 24, 2016
SCHWARZBECK Artificial Mains Network (For EUT)	NNLK8129	8129229	May 04, 2016	May 03, 2017
Software	Cond_V7.3.7	NA	NA	NA
RF cable (JYEBAO) With 10dB PAD	5D-FB	Cable-C10.01	Feb. 15, 2016	Feb. 14, 2017
SUHNER Terminator (For ROHDE & SCHWARZ LISN)	65BNC-5001	E1-011484	May 12, 2016	May 11, 2017
ROHDE & SCHWARZ Artificial Mains Network (For TV EUT)	ESH3-Z5	100220	Nov. 13, 2015	Nov. 12, 2016
LISN With Adapter (for TV EUT)	100220	N/A	Nov. 13, 2015	Nov. 12, 2016

Notes: 1. The calibration interval of the above test instruments is 12 months and the calibrations are traceable to NML/ROC and NIST/USA.

2. The test was performed in Shielded Room No. 10.

3. The VCCI Site Registration No. C-1852.

#### 4.2.3 Test Procedures

- a. The EUT was placed 0.4 meters from the conducting wall of the shielded room with EUT being connected to the power mains through a line impedance stabilization network (LISN). Other support units were connected to the power mains through another LISN. The two LISNs provide 50 ohm/ 50uH of coupling impedance for the measuring instrument.
- b. Both lines of the power mains connected to the EUT were checked for maximum conducted interference.
- c. The frequency range from 150kHz to 30MHz was searched. Emission levels under (Limit - 20dB) was not recorded.

**NOTE:** The resolution bandwidth and video bandwidth of test receiver is 9kHz for quasi-peak detection (QP) and average detection (AV) at frequency 0.15MHz-30MHz.

#### 4.2.4 Deviation from Test Standard

No deviation.

#### 4.2.5 Test Setup

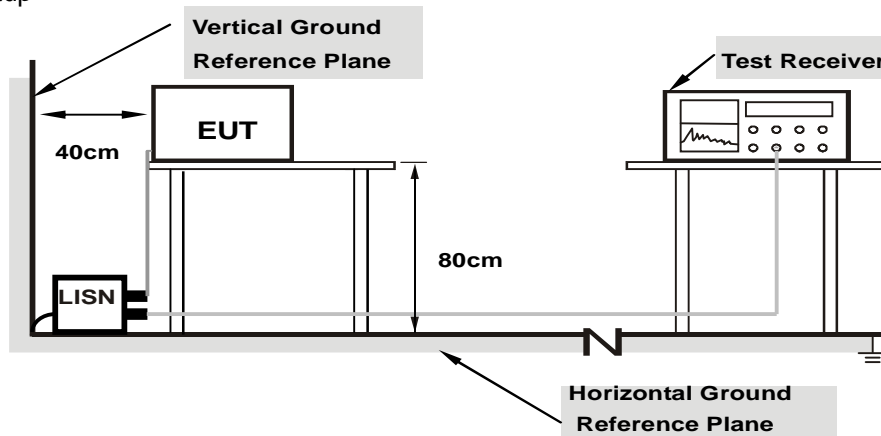

**Note:** 1.Support units were connected to second LISN.

For the actual test configuration, please refer to the attached file (Test Setup Photo).

#### 4.2.6 EUT Operating Conditions

##### Mode A

- Connected the EUT to Notebook
- Set the EUT under transmission condition continuously at specific channel frequency.

##### Mode B

- Connected the EUT to Adapter
- Set the EUT under transmission condition continuously at specific channel frequency.

4.2.7 Test Results

Mode A BT\_GFSK

Phase	Line (L)	Detector Function	Quasi-Peak (QP) / Average (AV)
-------	----------	-------------------	--------------------------------

No	Frequency (MHz)	Correction Factor (dB)	Reading Value (dBuV)		Emission Level (dBuV)		Limit (dBuV)		Margin (dB)	
			Q.P.	AV.	Q.P.	AV.	Q.P.	AV.	Q.P.	AV.
1	0.15781	9.70	25.55	4.66	35.25	14.36	65.58	55.58	-30.33	-41.22
2	0.17734	9.70	21.68	5.84	31.38	15.54	64.61	54.61	-33.23	-39.07
3	0.24766	9.70	14.44	6.96	24.14	16.66	61.84	51.84	-37.70	-35.18
4	0.40391	9.69	19.93	17.43	29.62	27.12	57.77	47.77	-28.15	-20.65
5	2.12109	9.79	18.40	11.60	28.19	21.39	56.00	46.00	-27.81	-24.61
6	16.94531	9.94	8.68	2.71	18.62	12.65	60.00	50.00	-41.38	-37.35

Remarks:

1. Q.P. and AV. are abbreviations of quasi-peak and average individually.
2. The emission levels of other frequencies were very low against the limit.
3. Margin value = Emission level – Limit value
4. Correction factor = Insertion loss + Cable loss
5. Emission Level = Correction Factor + Reading Value

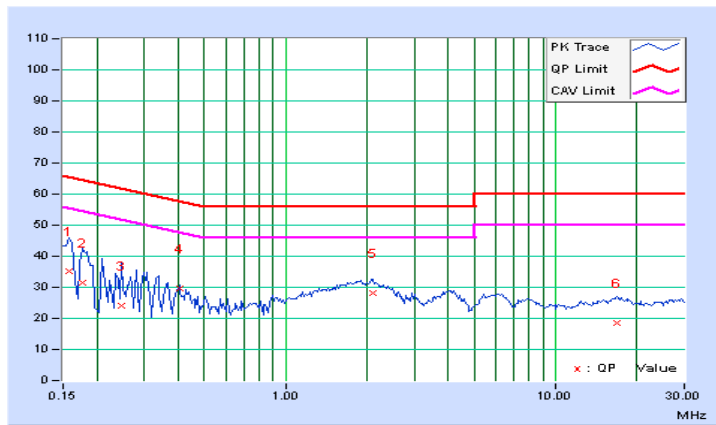

Phase	Neutral (N)	Detector Function	Quasi-Peak (QP) / Average (AV)
-------	-------------	-------------------	--------------------------------

No	Frequency (MHz)	Correction Factor (dB)	Reading Value (dBuV)		Emission Level (dBuV)		Limit (dBuV)		Margin (dB)	
			Q.P.	AV.	Q.P.	AV.	Q.P.	AV.	Q.P.	AV.
1	0.16562	9.70	27.29	7.07	36.99	16.77	65.18	55.18	-28.19	-38.41
2	0.28281	9.69	15.59	4.69	25.28	14.38	60.73	50.73	-35.45	-36.35
3	0.47422	9.69	15.30	12.82	24.99	22.51	56.44	46.44	-31.44	-23.92
4	2.35156	9.79	19.92	13.05	29.71	22.84	56.00	46.00	-26.29	-23.16
5	7.81641	9.89	13.56	7.26	23.45	17.15	60.00	50.00	-36.55	-32.85
6	18.02734	9.94	12.33	6.58	22.27	16.52	60.00	50.00	-37.73	-33.48

**Remarks:**

1. Q.P. and AV. are abbreviations of quasi-peak and average individually.
2. The emission levels of other frequencies were very low against the limit.
3. Margin value = Emission level – Limit value
4. Correction factor = Insertion loss + Cable loss
5. Emission Level = Correction Factor + Reading Value

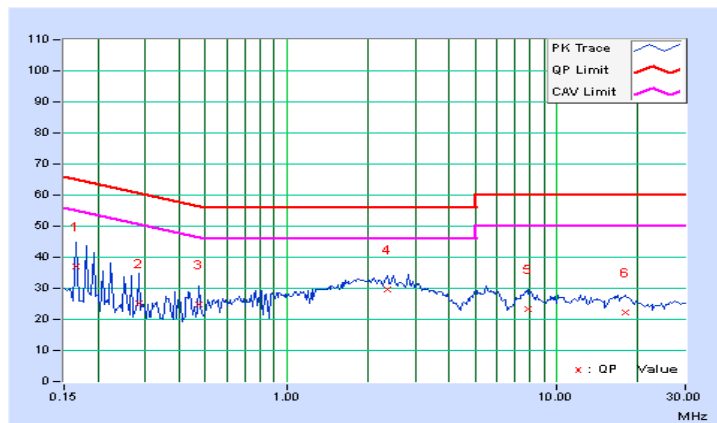

**Mode B BT\_GFSK**

Phase	Line (L)	Detector Function	Quasi-Peak (QP) / Average (AV)
-------	----------	-------------------	--------------------------------

No	Frequency (MHz)	Correction Factor (dB)	Reading Value (dBUV)		Emission Level (dBUV)		Limit (dBUV)		Margin (dB)	
			Q.P.	AV.	Q.P.	AV.	Q.P.	AV.	Q.P.	AV.
1	0.17344	9.70	31.54	18.40	41.24	28.10	64.79	54.79	-23.55	-26.69
2	0.25156	9.71	27.79	13.69	37.50	23.40	61.71	51.71	-24.21	-28.31
3	0.29453	9.71	22.58	5.31	32.29	15.02	60.40	50.40	-28.10	-35.37
4	0.75938	9.78	24.31	15.01	34.09	24.79	56.00	46.00	-21.91	-21.21
5	3.15234	10.00	12.42	6.61	22.42	16.61	56.00	46.00	-33.58	-29.39
6	22.76953	10.33	10.43	5.19	20.76	15.52	60.00	50.00	-39.24	-34.48

**Remarks:**

1. Q.P. and AV. are abbreviations of quasi-peak and average individually.
2. The emission levels of other frequencies were very low against the limit.
3. Margin value = Emission level – Limit value
4. Correction factor = Insertion loss + Cable loss
5. Emission Level = Correction Factor + Reading Value

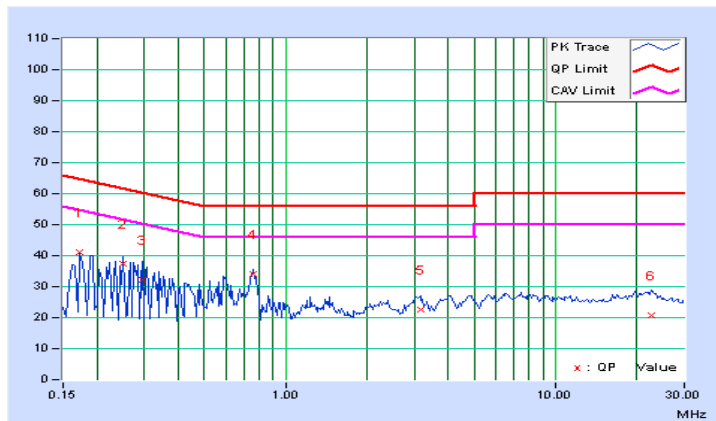

Phase	Neutral (N)	Detector Function	Quasi-Peak (QP) / Average (AV)
-------	-------------	-------------------	--------------------------------

No	Frequency (MHz)	Correction Factor (dB)	Reading Value (dBuV)		Emission Level (dBuV)		Limit (dBuV)		Margin (dB)	
			Q.P.	AV.	Q.P.	AV.	Q.P.	AV.	Q.P.	AV.
1	0.17098	9.70	32.28	20.32	41.98	30.02	64.91	54.91	-22.94	-24.90
2	0.24766	9.70	26.95	12.04	36.65	21.74	61.84	51.84	-25.19	-30.10
3	0.33750	9.72	23.40	11.64	33.12	21.36	59.26	49.26	-26.15	-27.91
<b>4</b>	<b>0.76328</b>	<b>9.78</b>	<b>25.12</b>	<b>19.89</b>	<b>34.90</b>	<b>29.67</b>	<b>56.00</b>	<b>46.00</b>	<b>-21.10</b>	<b>-16.33</b>
5	3.07813	10.01	14.19	8.13	24.20	18.14	56.00	46.00	-31.80	-27.86
6	17.01172	10.25	13.98	8.30	24.23	18.55	60.00	50.00	-35.77	-31.45

**Remarks:**

1. Q.P. and AV. are abbreviations of quasi-peak and average individually.
2. The emission levels of other frequencies were very low against the limit.
3. Margin value = Emission level – Limit value
4. Correction factor = Insertion loss + Cable loss
5. Emission Level = Correction Factor + Reading Value

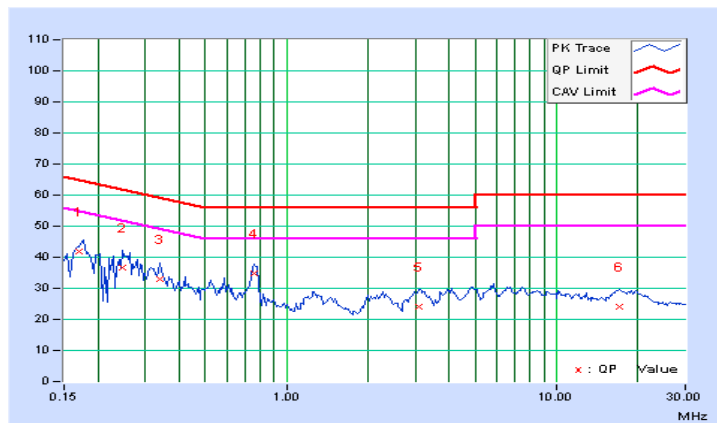

### 4.3 Number of Hopping Frequency Used

#### 4.3.1 Limits of Hopping Frequency Used Measurement

At least 15 channels frequencies, and should be equally spaced.

#### 4.3.2 Test Setup

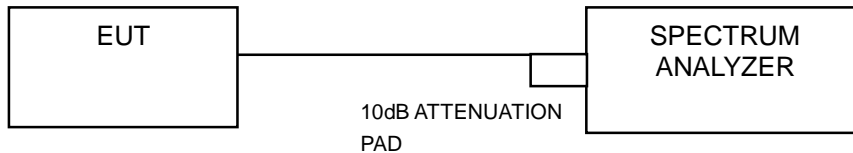

#### 4.3.3 Test Instruments

Refer to section 4.1.2 to get information of above instrument.

#### 4.3.4 Test Procedure

- Check the calibration of the measuring instrument (SA) using either an internal calibrator or a known signal from an external generator.
- Turn on the EUT and connect its antenna terminal to measurement via a low loss cable. Then set it to any one measured frequency within its operating range and make sure the instrument is operated in its linear range.
- Set the SA on MaxHold Mode, and then keep the EUT in hopping mode. Record all the signals from each channel until each one has been recorded.
- Set the SA on View mode and then plot the result on SA screen.
- Repeat above procedures until all frequencies measured were complete.

#### 4.3.5 Deviation from Test Standard

No deviation.

### 4.3.6 Test Results

There are 79 hopping frequencies in the hopping mode. Please refer to next page for the test result. On the plots, it shows that the hopping frequencies are equally spaced.

#### Mode A

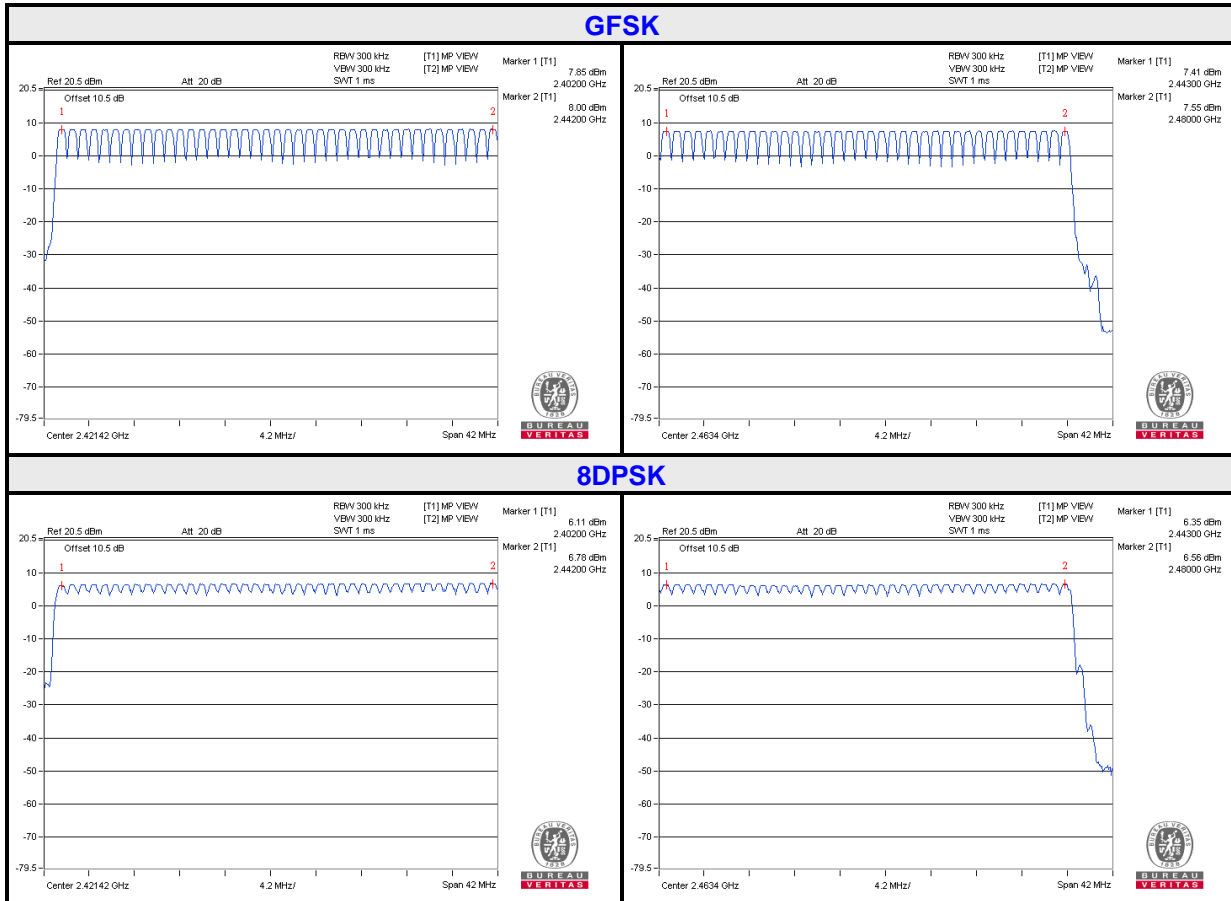



#### 4.4 Dwell Time on Each Channel

##### 4.4.1 Limits of Dwell Time on Each Channel Measurement

The average time of occupancy on any channel shall not be greater than 0.4 seconds within a period of 0.4 seconds multiplied by the number of hopping channels employed.

##### 4.4.2 Test Setup

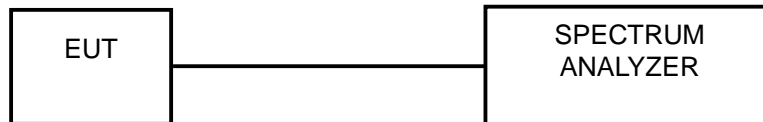

##### 4.4.3 Test Instruments

Refer to section 4.1.2 to get information of above instrument.

##### 4.4.4 Test Procedures

- Check the calibration of the measuring instrument (SA) using either an internal calibrator or a known signal from an external generator.
- Turn on the EUT and connect its antenna terminal to measurement via a low loss cable. Then set it to any one measured frequency within its operating range and make sure the instrument is operated in its linear range.
- Adjust the center frequency of SA on any frequency be measured and set SA to zero span mode. And then, set RBW and VBW of spectrum analyzer to proper value.
- Measure the time duration of one transmission on the measured frequency. And then plot the result with time difference of this time duration.
- Repeat above procedures until all different time-slot modes have been completed.

##### 4.4.5 Deviation from Test Standard

No deviation.

#### 4.4.6 Test Results

##### Mode A GFSK

Mode	Number of transmission in a 31.6 (79Hopping*0.4)	Length of transmission time (msec)	Result (msec)	Limit (msec)
DH1	50 (times / 5 sec) * 6.32 = 316.00 times	0.439	138.72	400
DH3	26 (times / 5 sec) * 6.32 = 164.32 times	1.732	284.6	400
DH5	16 (times / 5 sec) * 6.32 = 101.12 times	2.943	297.6	400

**NOTE:** Test plots of the transmitting time slot are shown on next page.



# Mode A

## DH1

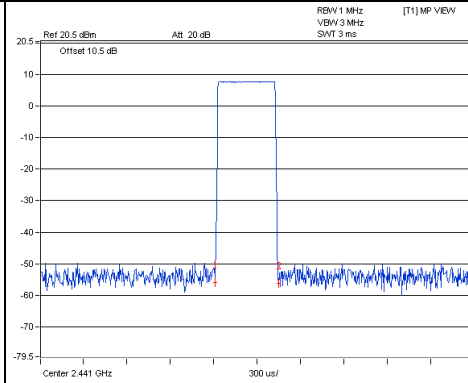
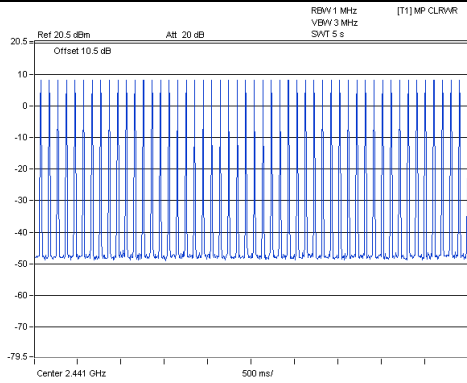

## DH3

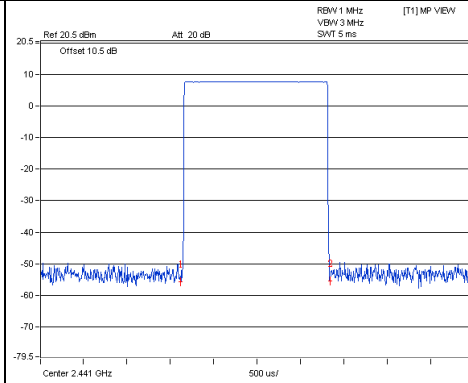
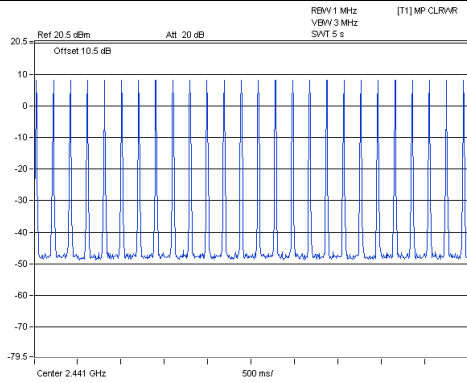

## DH5

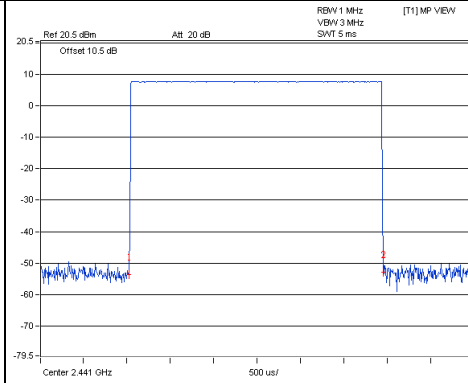
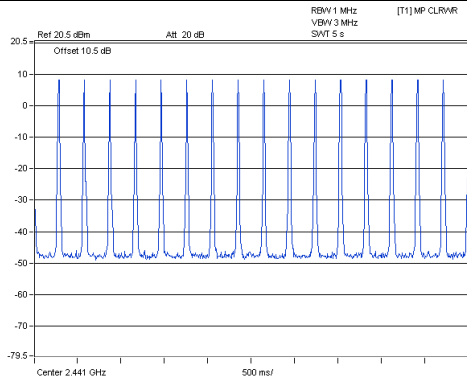

**Mode A**  
**8DPSK**

Mode	Number of transmission in a 31.6 (79Hopping*0.4)	Length of transmission time (msec)	Result (msec)	Limit (msec)
DH1	51 (times / 5 sec) * 6.32 = 322.32 times	0.465	149.88	400
DH3	25 (times / 5 sec) * 6.32 = 158 times	1.703	269.07	400
DH5	17 (times / 5 sec) * 6.32 = 107.44 times	3.008	323.18	400

**NOTE:** Test plots of the transmitting time slot are shown on next page.

### Mode A

#### DH1

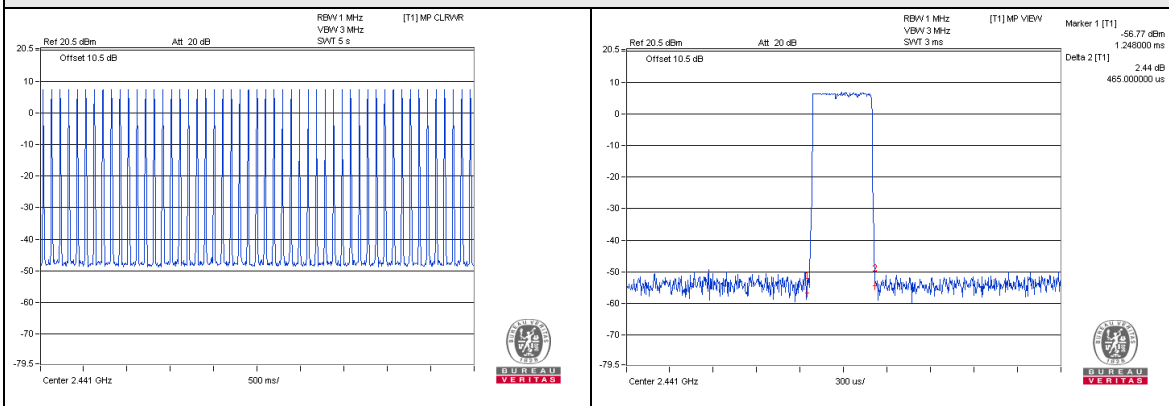

#### DH3

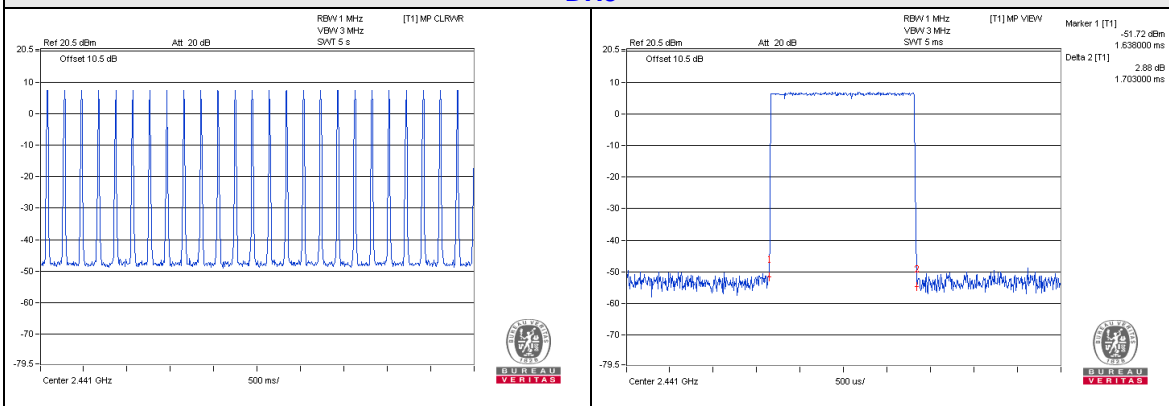

#### DH5

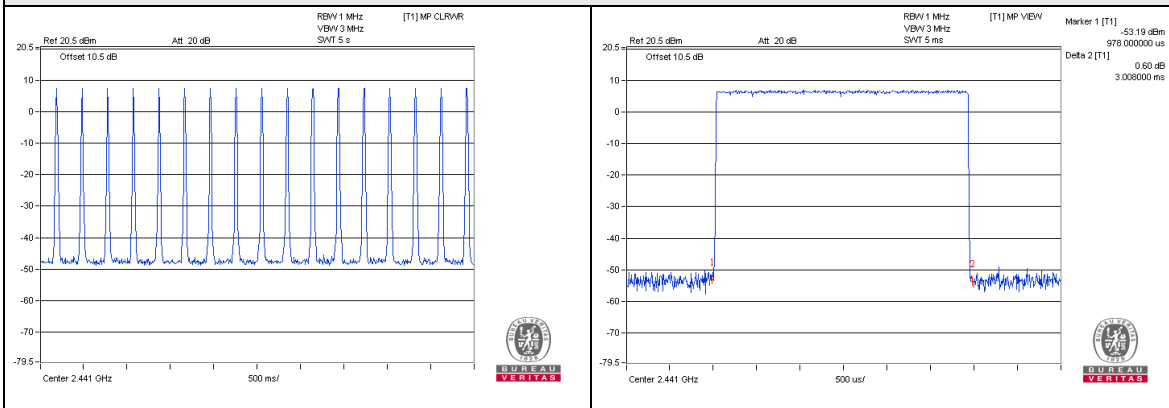

## 4.5 Channel Bandwidth

### 4.5.1 Limits of Channel Bandwidth Measurement

For frequency hopping system operating in the 2400-2483.5MHz, If the 20dB bandwidth of hopping channel is greater than 25kHz, two-thirds 20dB bandwidth of hopping channel shall be a minimum limit for the hopping channel separation.

### 4.5.2 Test Setup

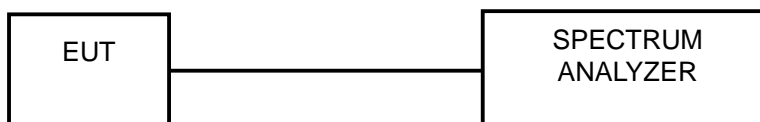

### 4.5.3 Test Instruments

Refer to section 4.1.2 to get information of above instrument.

### 4.5.4 Test Procedure

- Check the calibration of the measuring instrument using either an internal calibrator or a known signal from an external generator.
- Turn on the EUT and connect it to measurement instrument. Then set it to any one convenient frequency within its operating range. Set a reference level on the measuring instrument equal to the highest peak value.
- Measure the frequency difference of two frequencies that were attenuated 20dB from the reference level. Record the frequency difference as the emission bandwidth.
- Repeat above procedures until all frequencies measured were complete.

### 4.5.5 Deviation from Test Standard

No deviation.

### 4.5.6 EUT Operating Condition

The software provided by client enabled the EUT to transmit and receive data at lowest, middle and highest channel frequencies individually.

### 4.5.7 Test Results

#### Mode A

Channel	Frequency (MHz)	20dB Bandwidth (MHz)	
		GFSK	8DPSK
0	2402	0.87	1.21
39	2441	0.87	1.21
78	2480	0.88	1.21

**Spectrum Plot of Worst Value**

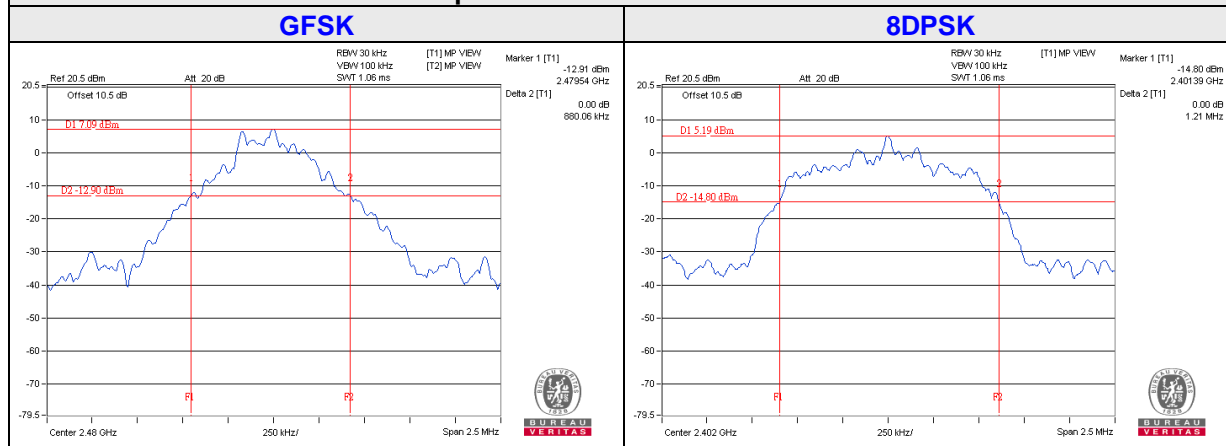

## 4.6 Hopping Channel Separation

### 4.6.1 Limits of Hopping Channel Separation Measurement

At least 25kHz or two-third of 20dB hopping channel bandwidth (whichever is greater).

### 4.6.2 Test Setup

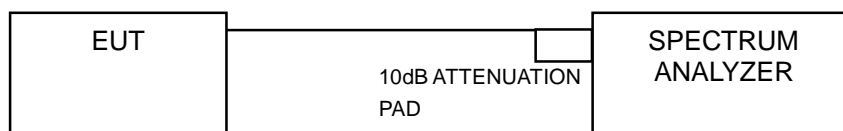

### 4.6.3 Test Instruments

Refer to section 4.1.2 to get information of above instrument.

### 4.6.4 Test Procedure

Measurement Procedure REF

- Check the calibration of the measuring instrument using either an internal calibrator or a known signal from an external generator.
- Turn on the EUT and connect it to measurement instrument. Then set it to any one convenient frequency within its operating range.
- By using the MaxHold function record the separation of two adjacent channels.
- Measure the frequency difference of these two adjacent channels by SA MARK function. And then plot the result on SA screen.
- Repeat above procedures until all frequencies measured were complete.

### 4.6.5 Deviation From Test Standard

No deviation.



#### 4.6.6 Test Results

##### Mode A

Channel	Frequency (MHz)	Adjacent Channel Separation (MHz)		20dB Bandwidth (MHz)		Minimum Limit (MHz)		Pass / Fail
		GFSK	8DPSK	GFSK	8DPSK	GFSK	8DPSK	
0	2402	1.00	1.00	0.87	1.21	0.58	0.81	Pass
39	2441	1.00	1.00	0.87	1.21	0.58	0.81	Pass
78	2480	1.00	1.00	0.88	1.21	0.59	0.81	Pass

**NOTE:** The minimum limit is two-third 20dB bandwidth.

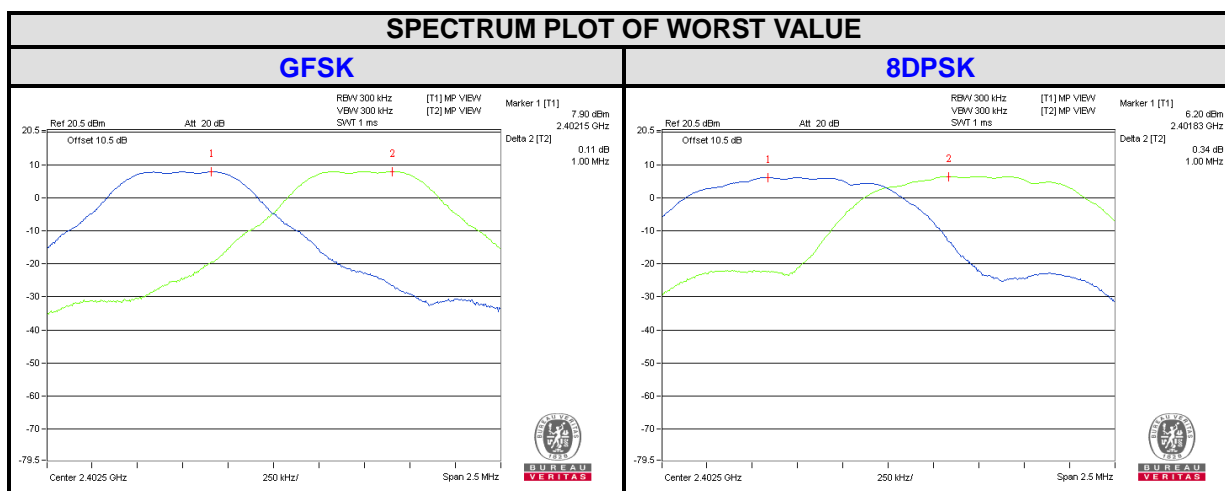

## 4.7 Maximum Output Power

### 4.7.1 Limits of Maximum Output Power Measurement

The Maximum Output Power Measurement is 125mW.

### 4.7.2 Test Setup

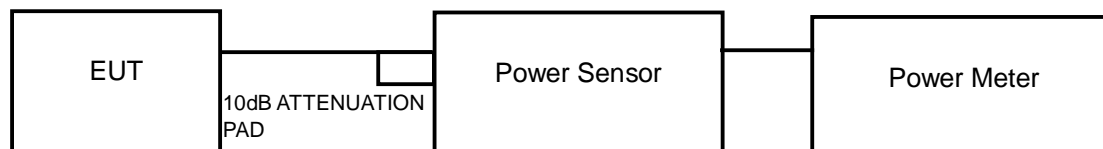

### 4.7.3 Test Instruments

Refer to section 4.1.2 to get information of above instrument.

### 4.7.4 Test Procedure

A peak power sensor was used on the output port of the EUT. A power meter was used to read the response of the peak power sensor. Record the peak power level.

### 4.7.5 Deviation from Test Standard

No deviation.

### 4.7.6 EUT Operating Condition

The software provided by client enabled the EUT to transmit and receive data at lowest, middle and highest channel frequencies individually.

#### 4.7.7 Test Results

##### Mode A

Channel	Frequency (MHZ)	Output Power (mW)		Output Power (dBm)		Power Limit (mW)	Pass / Fail
		GFSK	8DPSK	GFSK	8DPSK		
0	2402	6.966	4.753	8.43	6.77	125	Pass
39	2441	<b>6.982</b>	5.297	8.44	7.24	125	Pass
78	2480	6.934	5.445	8.41	7.36	125	Pass

## 4.8 Conducted Out of Band Emission Measurement

### 4.8.1 Limits Of Conducted Out Of Band Emission Measurement

Below  $-20\text{dB}$  of the highest emission level of operating band (in  $100\text{kHz}$  RBW).

### 4.8.2 Test Instruments

Refer to section 4.1.2 to get information of above instrument.

### 4.8.3 Test Procedure

The transmitter output was connected to the spectrum analyzer via a low lose cable. Set both RBW and VBW of spectrum analyzer to  $100\text{ kHz}$  and  $300\text{ kHz}$  with suitable frequency span including  $100\text{ MHz}$  bandwidth from band edge. The band edges was measured and recorded.

### 4.8.4 Deviation From Test Standard

No deviation.

### 4.8.5 Eut Operating Condition

The software provided by client enabled the EUT to transmit and receive data at lowest, middle and highest channel frequencies individually.

### 4.8.6 Test Results

The spectrum plots are attached on the following images. D1 line indicates the highest level, D2 line indicates the  $20\text{dB}$  offset below D1. It shows compliance with the requirement.

Mode A  
GFSK

Hopping disabled\_Low Channel

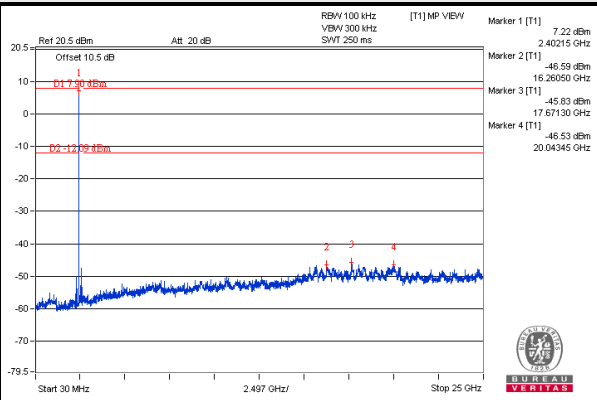
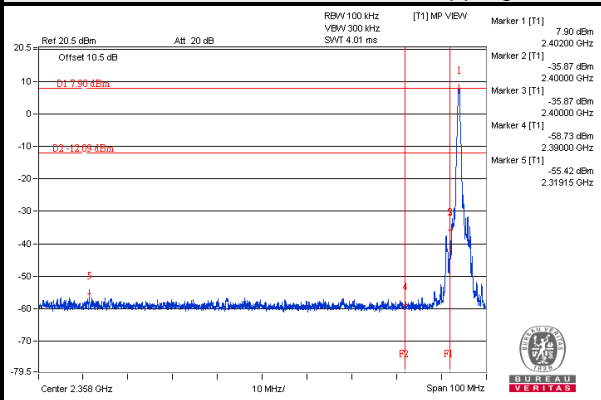

Hopping disabled\_High Channel

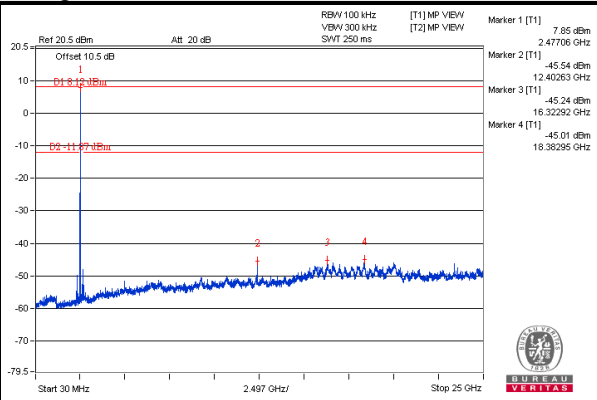
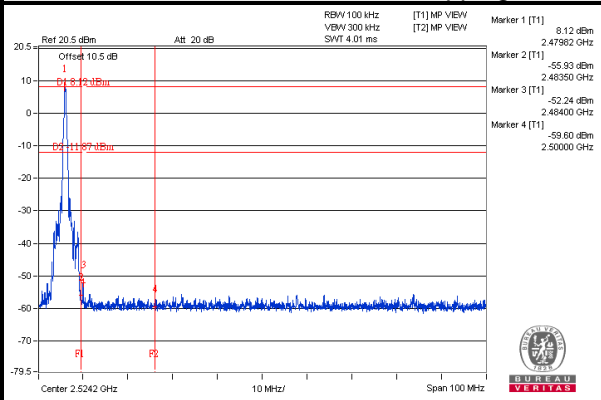

Hopping enabled\_Low Channel

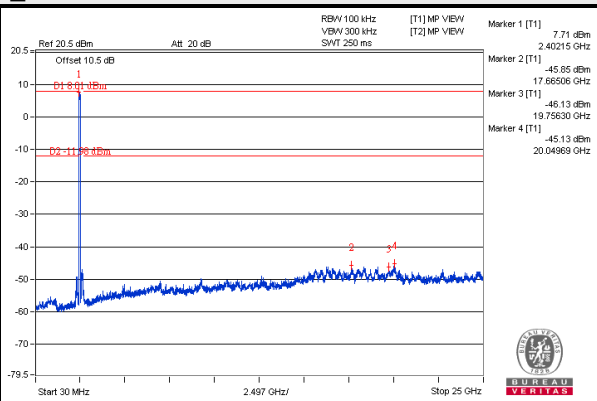
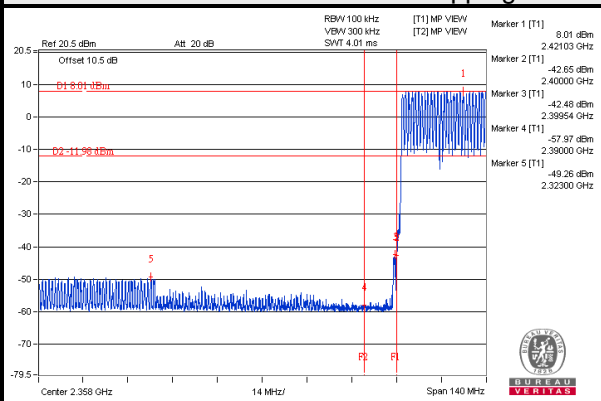

Hopping enabled\_High Channel

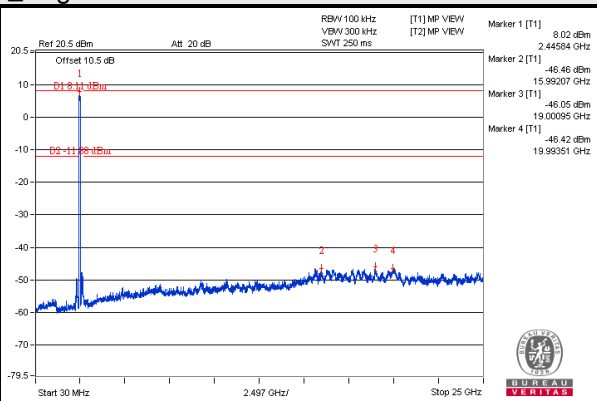
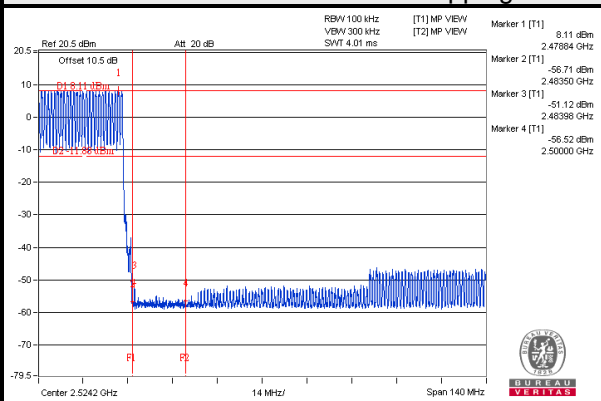

Mode A  
8DPSK

Hopping disabled\_Low Channel

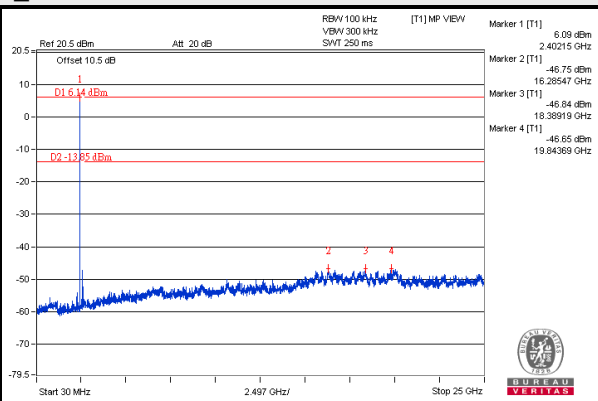
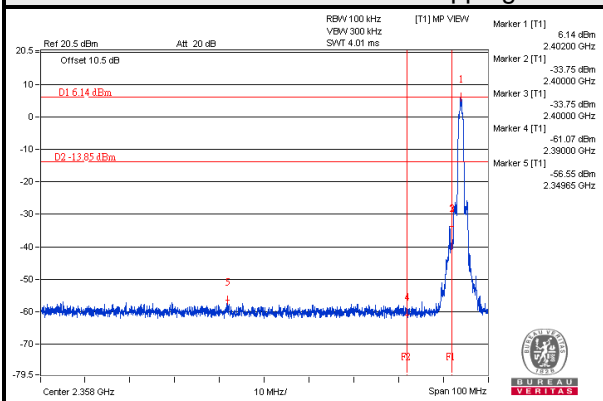

Hopping disabled\_High Channel

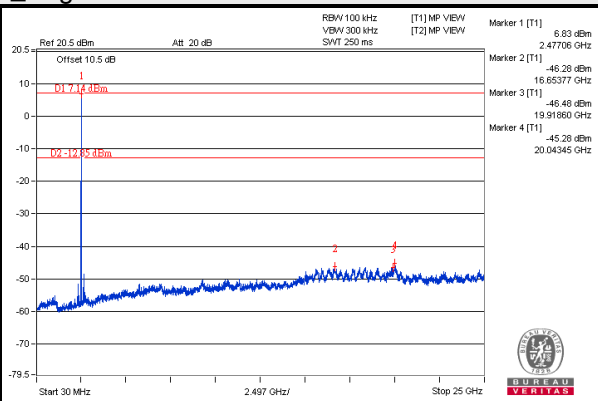
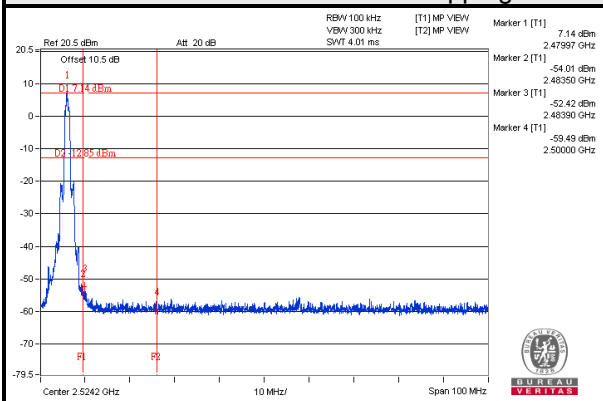

Hopping enabled\_Low Channel

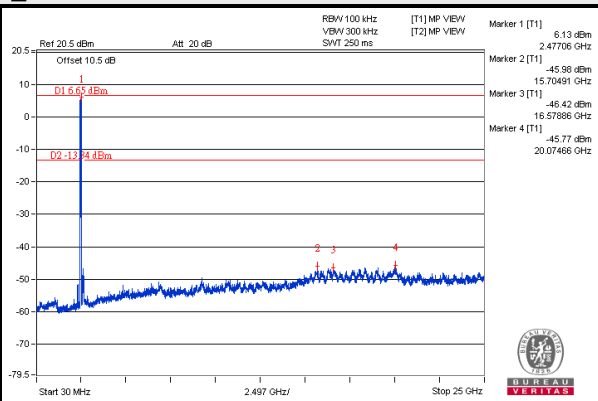
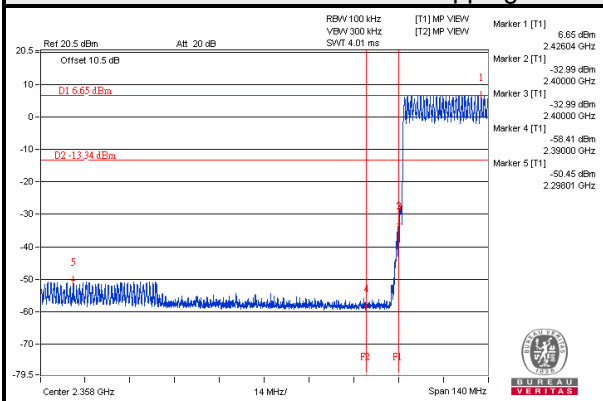

Hopping enabled\_High Channel

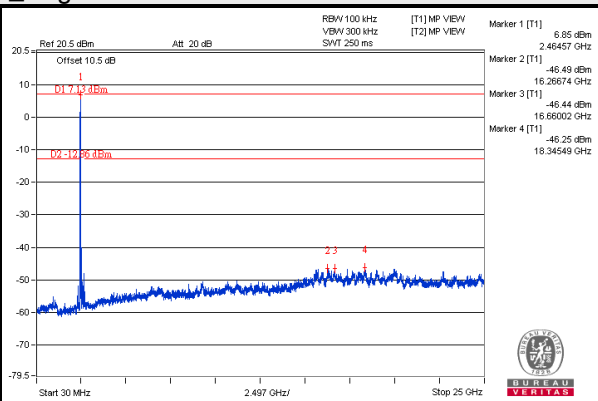
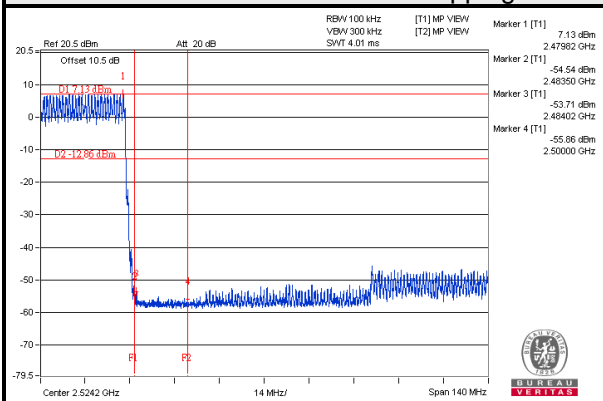

## 5 Pictures of Test Arrangements

Please refer to the attached file (Test Setup Photo).

## Appendix – Information on the Testing Laboratories

We, Bureau Veritas Consumer Products Services (H.K.) Ltd., Taoyuan Branch, were founded in 1988 to provide our best service in EMC, Radio, Telecom and Safety consultation. Our laboratories are accredited and approved according to ISO/IEC 17025.

If you have any comments, please feel free to contact us at the following:

**Linko EMC/RF Lab**

Tel: 886-2-26052180

Fax: 886-2-26051924

**Hsin Chu EMC/RF Lab/Telecom Lab**

Tel: 886-3-6668565

Fax: 886-3-6668323

**Hwa Ya EMC/RF/Safety**

Tel: 886-3-3183232

Fax: 886-3-3270892

**Email:** [service.adt@tw.bureauveritas.com](mailto:service.adt@tw.bureauveritas.com)

**Web Site:** [www.bureauveritas-adt.com](http://www.bureauveritas-adt.com)

The address and road map of all our labs can be found in our web site also.

--- END ---