



FCC/ISED RF - TEST REPORT

Report Number : **68.950.21.0474.01** Date of Issue: 2021-07-19

Model : **ACVT1**

Product Type : **Grip**

Applicant : **GoPro, Inc.**

Address : **3025 Clearview Way, San Mateo, CA 94402, USA**

Manufacturer : **GoPro, Inc.**

Address : **3025 Clearview Way, San Mateo, CA 94402, USA**

Test Result : **Positive** **Negative**

Total pages including Appendices : **45**

Any use for advertising purposes must be granted in writing. This technical report may only be quoted in full. This report is the result of a single examination of the object in question and is not generally applicable evaluation of the quality of other products in regular production. For further details, please see testing and certification regulation chapter A-3.4.

This report is the confidential property of the client. As a mutual protection to our clients, the public and ourselves, extracts from the test report shall not be reproduced except in full without our written approval.



1 Table of Contents

- 1 Table of Contents.....2
- 2 Details about the Test Laboratory3
- 3 Description of the Equipment under Test4
- 4 Summary of Test Standards.....5
- 5 Summary of Test Results6
- 6 General Remarks.....7
- 7 Test Setups.....8
- 8 Systems test configuration9
- 9 Technical Requirement10
 - 9.1 Conducted Emission10
 - 9.2 Conducted output power13
 - 9.3 6dB bandwidth14
 - 9.4 99% bandwidth18
 - 9.5 Power spectral density.....22
 - 9.6 Spurious RF conducted emissions25
 - 9.7 Band edge33
 - 9.8 Spurious radiated emissions for transmitter36
- 10 Test Equipment List.....44
- 11 System Measurement Uncertainty45



2 Details about the Test Laboratory

Details about the Test Laboratory

Test Site 1

Company name: TÜV SÜD Certification and Testing (China) Co., Ltd. Shenzhen Branch
Building 12&13, Zhiheng Wisdomland Business Park,
Nantou Checkpoint Road 2, Nanshan District,
Shenzhen City, 518052, P. R. China

FCC Designation Number: CN5009

FCC Registration No.: 514049

ISED#: 10320A

Telephone: 86 755 8828 6998
Fax: 86 755 8828 5299

3 Description of the Equipment under Test

Product:	Grip
Model no.:	ACVT1
FCC ID:	CNFACVT1
IC:	10193A-ACVT1
PMN:	ACVT1
HVIN:	ACVT1
Input:	5V \equiv 3A
Output:	5V \equiv 2.4A
RF Transmission Frequency:	2402MHz-2480MHz
No. of Operated Channel:	40
Modulation:	GFSK
Antenna Type:	Internal Integrated Antenna
Antenna Gain:	0.36dBi max for 2.4GHz
Description of the EUT:	The Equipment Under Test (EUT) is Grip supports Bluetooth Low Energy function support data rate 1 Mbps, 2 Mbps.

4 Summary of Test Standards

Test Standards	
FCC Part 15 Subpart C 10-1-2020 Edition	PART 15 - RADIO FREQUENCY DEVICES Subpart C - Intentional Radiators
RSS-Gen Issue 5, Amendment 2, February 2021	General Requirements and Information for the Certification of Radio Apparatus
RSS-247 Issue 2 February 2017	Digital Transmission Systems (DTSS), Frequency Hopping Systems (FHSS) and License-Exempt Local Area Network (LE-LAN) Devices

All the test methods were according to KDB 558074 D01 15.247 Meas Guidance v05r02 and ANSI C63.10 (2013).

5 Summary of Test Results

Technical Requirements			
FCC Part 15 Subpart C/RSS-247 Issue 2/RSS-Gen Issue 5			
Test Condition		Test Result	Test Site
§15.207 RSS-GEN 8.8	Conducted emission AC power port	Pass	Site 1
§15.247 (b) (3) & RSS-247 5.4(d)	Conducted output power	Pass	Site 1
RSS-247 5.4(d)	Equivalent Isotropic Radiated Power	Pass	Site 1
§15.247(e) RSS-247 5.2(b)	Power spectral density	Pass	Site 1
§15.247(a)(2) RSS-247 5.2(a) & RSS-GEN 6.7	6dB bandwidth	Pass	Site 1
§15.247(a)(1) RSS-247 5.1(b)	20dB Occupied bandwidth	N/A	--
RSS-GEN 6.7	99% Occupied Bandwidth	Pass	Site 1
§15.247(a)(1) §RSS-247 5.1(b)	Carrier frequency separation	N/A	--
§15.247(a)(1)(iii) RSS-247 5.1(d)	Number of hopping frequencies	N/A	--
§15.247(a)(1)(iii) RSS-247 5.1(d)	Dwell Time	N/A	--
§15.247(d) RSS-247 5.5	Spurious RF conducted emissions	Pass	Site 1
§15.247(d) RSS-247 5.5	Band edge	Pass	Site 1
§15.247(d) & §15.209 & §15.205 RSS-247 5.5 & RSS- Gen 6.13	Spurious radiated emissions for transmitter	Pass	Site 1
§15.203 RSS-Gen 6.8	Antenna requirement	Pass See note 1	--

Remark 1: N/A – Not Applicable.

Note 1: The EUT uses an Integrated antenna, which gain is 0.36dBi. In accordance to §15.203 and RSS-Gen 6.8, it is considered sufficiently to comply with the provisions of this section.



6 General Remarks

Remarks

This submittal(s) (test report) is intended for FCC ID: CNFACVT1, complies with Section 15.207, 15.209, 15.205, 15.247 of the FCC Part 15, Subpart C.

This submittal(s) (test report) is intended for IC: 10193A-ACVT1, complies with RSS-247, RSS-GEN.

The Model: ACVT1 supports 3.6Vdc, 4900mAh supplied by a rechargeable Lithium Ion Battery or 5V $\overline{\text{---}}$ 3A supplied by USB type C port.

The TX and RX range is 2402MHz-2480MHz.

This report is for the Bluetooth Low Energy.

SUMMARY:

All tests according to the regulations cited on page 6 were

- Performed

- **Not** Performed

The Equipment under Test

- **Fulfills** the general approval requirements.

- **Does not** fulfill the general approval requirements.

Sample Received Date: 2021-07-08

Testing Start Date: 2021-07-08

Testing End Date: 2021-07-16

- TÜV SÜD Certification and Testing (China) Co., Ltd. Shenzhen Branch -

Reviewed by:

Prepared by:

Tested by:

John Zhi
Project Manager



Joe Gu
Project Engineer

Carry Cai
Test Engineer

7 Test Setups

7.1 Radiated test setups

Below 1GHz

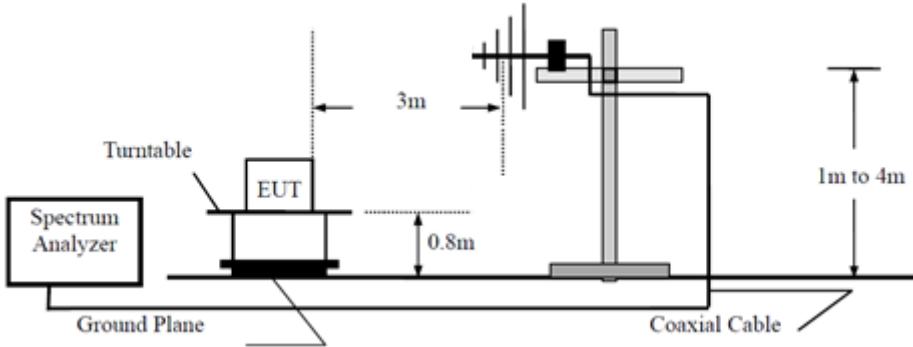

Above 1GHz

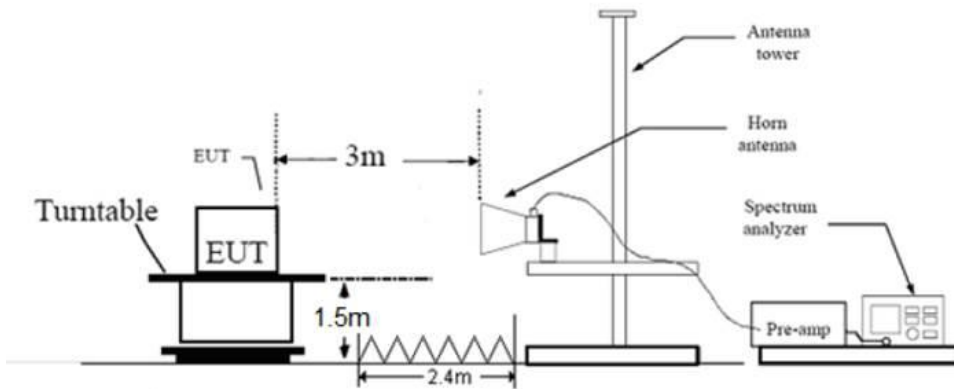

7.2 Conducted RF test setups

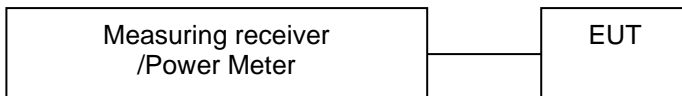

7.3 AC Power Line Conducted Emission test setups

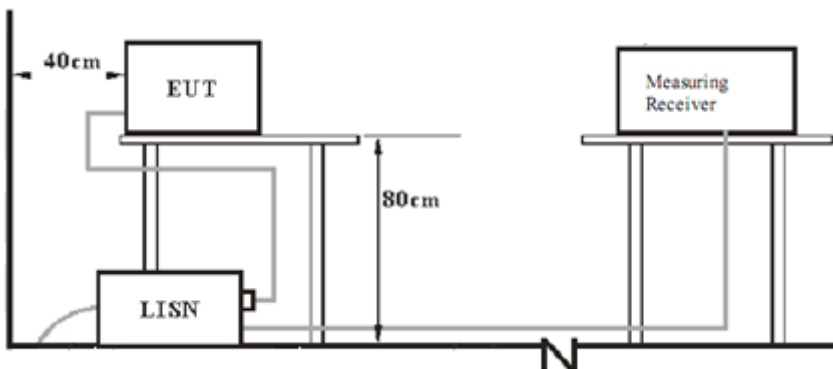

8 Systems test configuration

Auxiliary Equipment Used during Test:

DESCRIPTION	MANUFACTURER	MODEL NO.	S/N
Laptop	Lenovo	X240	---
USB Type C cable	GoPro	0.46m (Length)	---
12W USB Power Adapter	Apple	A1401	---

Test software information:

Test Software Version	STM32CubeMonitor-RF(V2.5.0)	
Modulation	Setting TX Power	Packet Type
GFSK	31(+6dBm)	Pseudo-Random bit sequence 9

The system was configured to channel 0, 19, and 39 for the test.

9 Technical Requirement

9.1 Conducted Emission

Test Method

1. The EUT was placed 0.4 meter from the conducting wall of the shielding room was kept at least 80 centimeters from any other grounded conducting surface.
2. Connect EUT to the power mains through a line impedance stabilization network (LISN).
3. All the support units are connecting to the other LISN.
4. The LISN provides 50 ohm coupling impedance for the measuring instrument.
5. Both sides of AC line were checked for maximum conducted interference.
6. The frequency range from 150 kHz to 30 MHz was searched.
7. Set the test-receiver system to Peak Detect Function and specified bandwidth (IF Bandwidth = 9kHz) with Maximum Hold Mode. Then measurement is also conducted by Average Detector and Quasi-Peak Detector Function respectively.

Limit

According to §15.207 & RSS-GEN 8.8, conducted emissions limit as below:

Frequency MHz	QP Limit dB μ V	AV Limit dB μ V
0.150-0.500	66-56*	56-46*
0.500-5	56	46
5-30	60	50

*Decreasing linearly with logarithm of the frequency

Conducted Emission

Product Type : Grip
 M/N : ACVT1
 Operating Condition : Charging + Transmit
 Test Specification : Power Line, Live
 Comment : AC 120V/60Hz (External adapter)

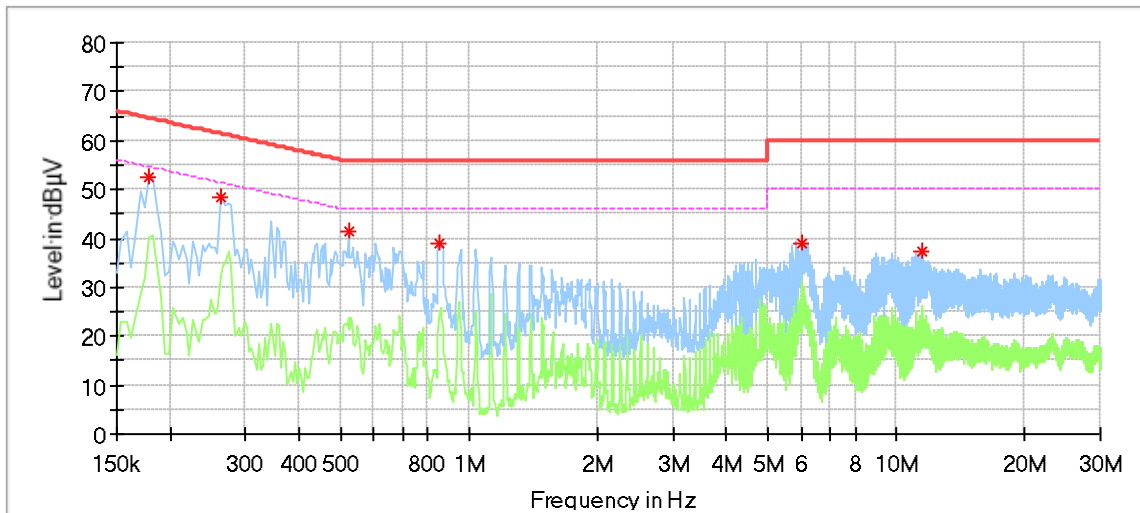

Frequency (MHz)	MaxPeak (dBµV)	Average (dBµV)	Limit (dBµV)	Margin (dB)	Line	Corr. (dB)
0.178000	52.64	---	64.58	11.94	L1	9.64
0.262000	48.25	---	61.37	13.12	L1	9.64
0.522000	41.25	---	56.00	14.76	L1	9.65
0.850000	38.98	---	56.00	17.02	L1	9.66
6.022000	38.88	---	60.00	21.12	L1	9.80
11.438000	37.51	---	60.00	22.49	L1	9.88

Remark :

Level=Reading Level + Correction Factor

Correction Factor=Cable Loss + LISN Factor

(The Reading Level is recorded by software which is not shown in the sheet)

Conducted Emission

Product Type : Grip
 M/N : ACVT1
 Operating Condition : Charging + Transmit
 Test Specification : Power Line, Neutral
 Comment : AC 120V/60Hz (External adapter)

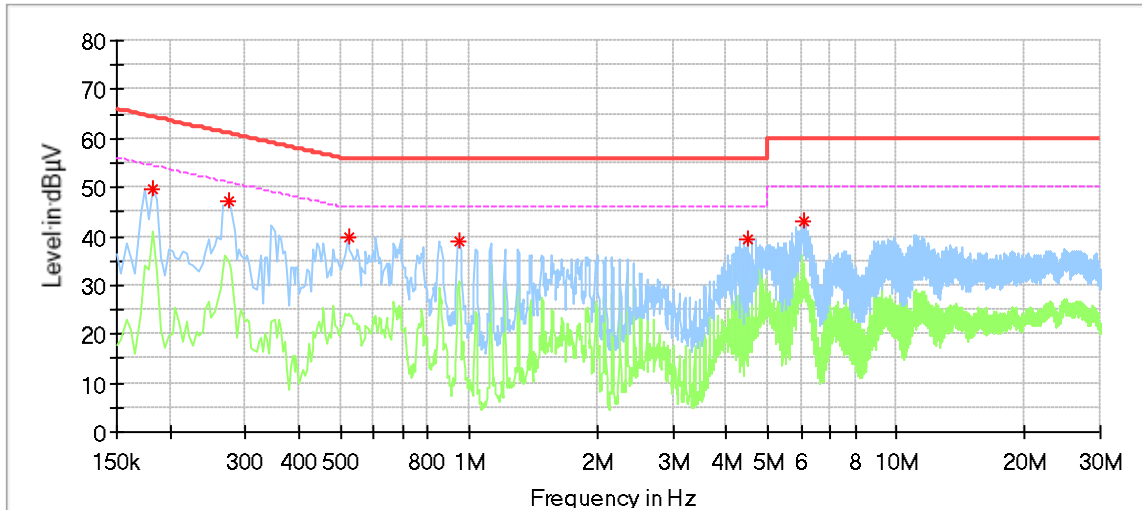

Frequency (MHz)	MaxPeak (dBµV)	Average (dBµV)	Limit (dBµV)	Margin (dB)	Line	Corr. (dB)
0.182000	49.51	---	64.39	14.89	N	9.62
0.274000	47.25	---	61.00	13.75	N	9.63
0.522000	39.84	---	56.00	16.16	N	9.65
0.954000	39.18	---	56.00	16.82	N	9.65
4.506000	39.20	---	56.00	16.80	N	9.75
6.070000	42.87	---	60.00	17.13	N	9.80

Remark :
 Level=Reading Level + Correction Factor
 Correction Factor=Cable Loss + LISN Factor
 (The Reading Level is recorded by software which is not shown in the sheet)

9.2 Conducted output power

Test Method

1. The EUT was placed on 0.8m height table, the RF output of EUT was connected to the power meter by RF cable. The path loss was compensated to the results for each measurement.
2. Setting the highest output power level of the EUT
3. Record the power value.

Limits

According to §15.247 (b) (3) & RSS-247 5.4(d), conducted output power limit as below:

Frequency Range MHz	Limit W	Limit dBm
2400-2483.5	≤1	≤30

According to & RSS-247 5.4(d), EIRP limit as below:

Frequency Range MHz	Limit W	Limit dBm
2400-2483.5	≤4	≤36.2

Test result as below table

Data rate	Frequency (MHz)	Conducted Output Power (dBm)	Antenna Gain (dBi)	EIRP (dBm)	Result
1 Mbps	Low channel 2402MHz	5.6	0.36	5.96	Pass
	Middle channel 2440MHz	5.5	0.36	5.86	Pass
	High channel 2480MHz	5.3	0.36	5.66	Pass
2 Mbps	Low channel 2402MHz	5.5	0.36	5.86	Pass
	Middle channel 2440MHz	5.4	0.36	5.76	Pass
	High channel 2480MHz	5.3	0.36	5.66	Pass

9.3 6dB bandwidth

Test Method

1. Connect EUT test port to spectrum analyzer.
2. Use the following spectrum analyzer settings:
RBW=100K, VBW≥3RBW, Sweep = auto, Detector function = peak, Trace = max hold
3. Use the automatic bandwidth measurement capability of an instrument, may be employed using the X dB bandwidth mode with X set to 6 dB, care shall be taken so that the bandwidth measurement is not influenced by any intermediate power nulls in the fundamental emission that might be ≥ 6 dB.
4. Allow the trace to stabilize, record the X dB Bandwidth value.

Limit

Limit [kHz]

≥500

Test result

Data rate	Channel (MHz)	Result (MHz)	Limit (KHz)	Verdict
1 Mbps	2402	0.664	≥500	PASS
	2440	0.664	≥500	PASS
	2480	0.664	≥500	PASS
2 Mbps	2402	1.124	≥500	PASS
	2440	1.120	≥500	PASS
	2480	1.120	≥500	PASS

Test Graphs

1 Mbps:

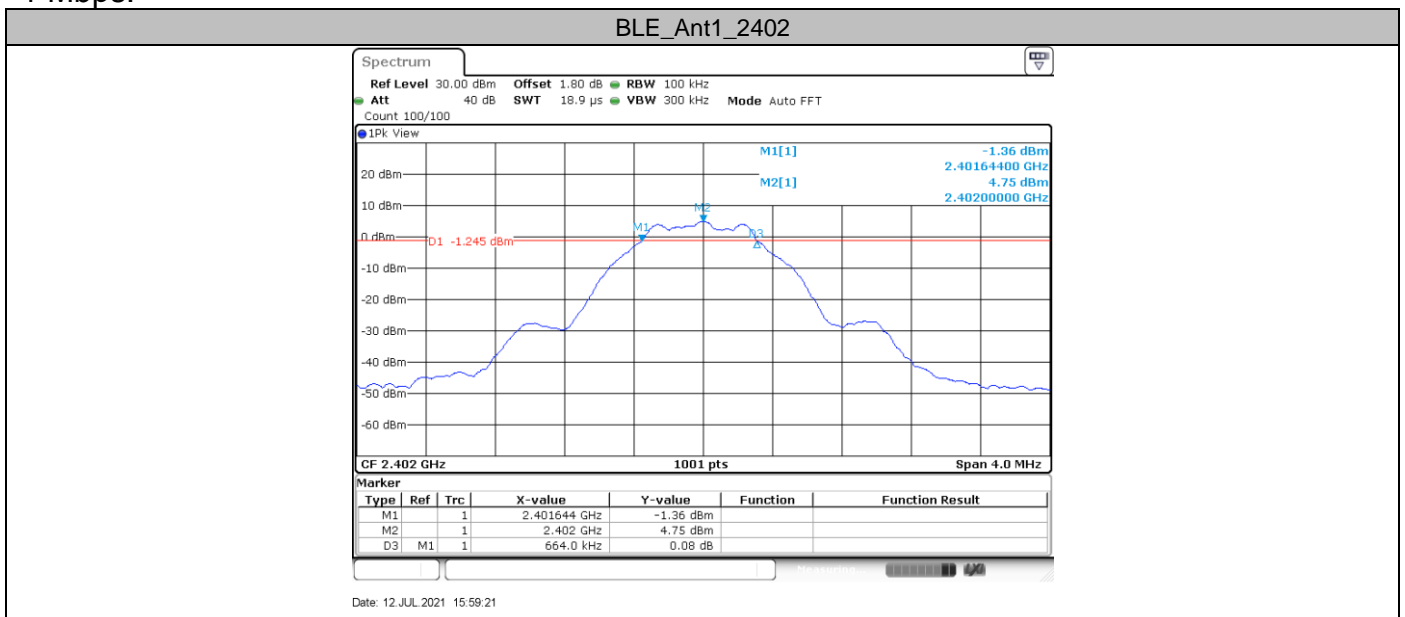

BLE_Ant1_2440

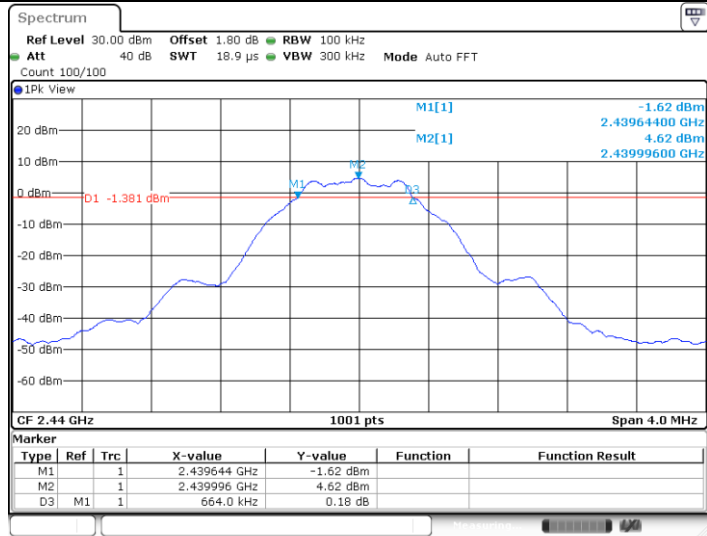

Date: 12.JUL.2021 16:01:13

BLE_Ant1_2480

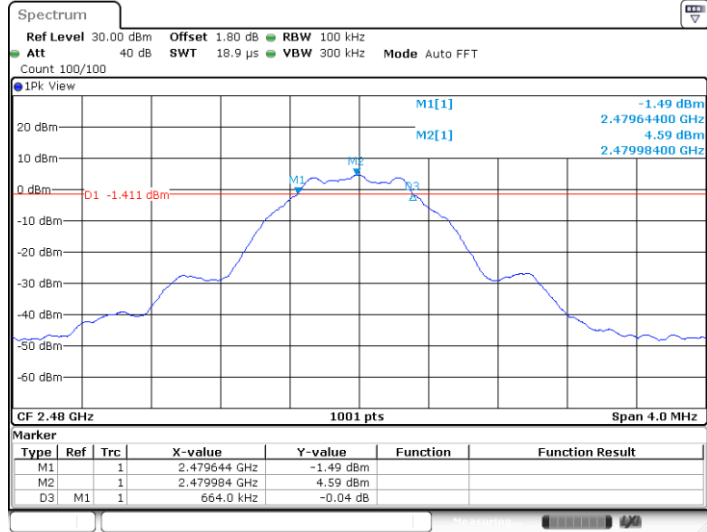

Date: 12.JUL.2021 16:02:49

2 Mbps:

BLE_Ant1_2402

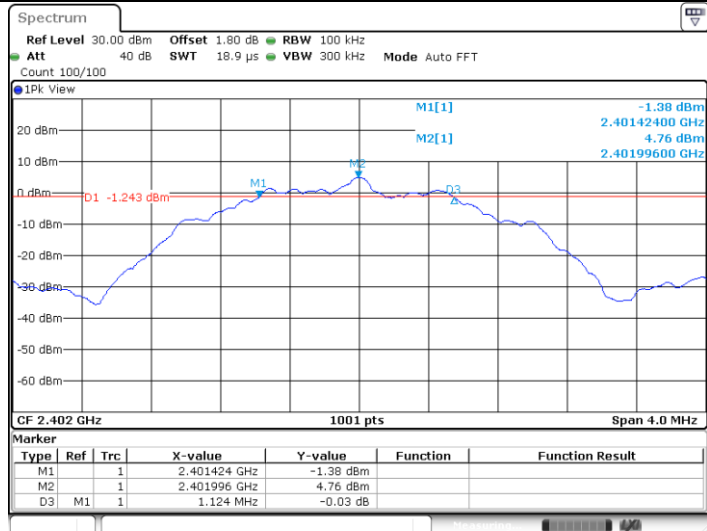

BLE_Ant1_2440

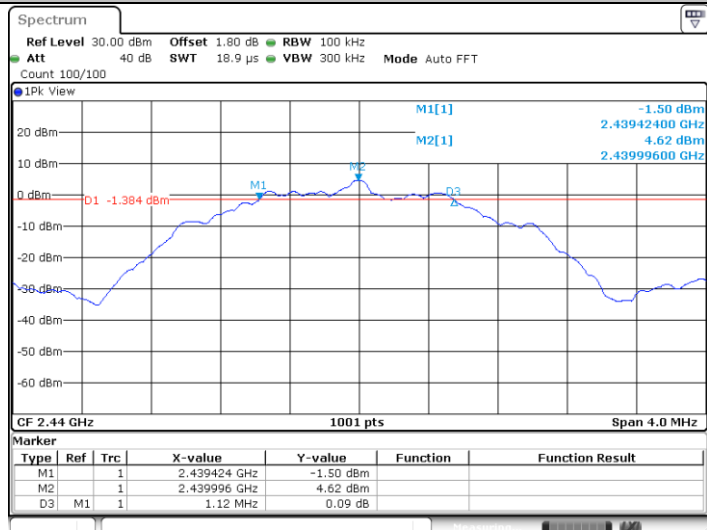

BLE_Ant1_2480

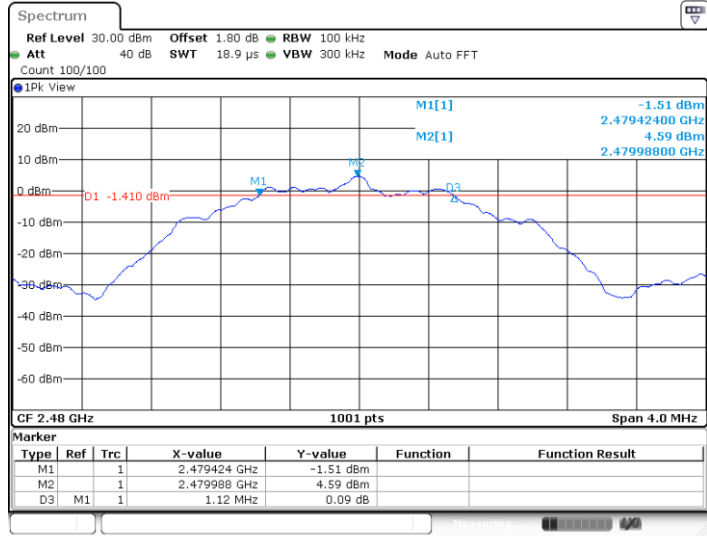

Date: 12 JUL 2021 16:10:10

9.4 99% bandwidth

Test Method

1. Connect EUT test port to spectrum analyzer.
2. Use the following spectrum analyzer settings:
 RBW=1% to 5% of the actual occupied, VBW \geq 3RBW, Sweep = auto,
 Detector function = peak, Trace = max hold
3. Use the automatic bandwidth measurement capability of an instrument, care shall be taken so that the bandwidth measurement is not influenced by any intermediate power nulls in the fundamental emission that might be ≥ 6 dB.
4. Allow the trace to stabilize, record the X dB Bandwidth value.

Limit

Limit [kHz]

--

Test result

Data rate	Channel (MHz)	Result (MHz)	Limit	Verdict
1 Mbps	2402	1.011	---	PASS
	2440	1.015	---	PASS
	2480	1.015	---	PASS
2 Mbps	2402	2.030	---	PASS
	2440	2.038	---	PASS
	2480	2.038	---	PASS

Test Graphs

1 Mbps:

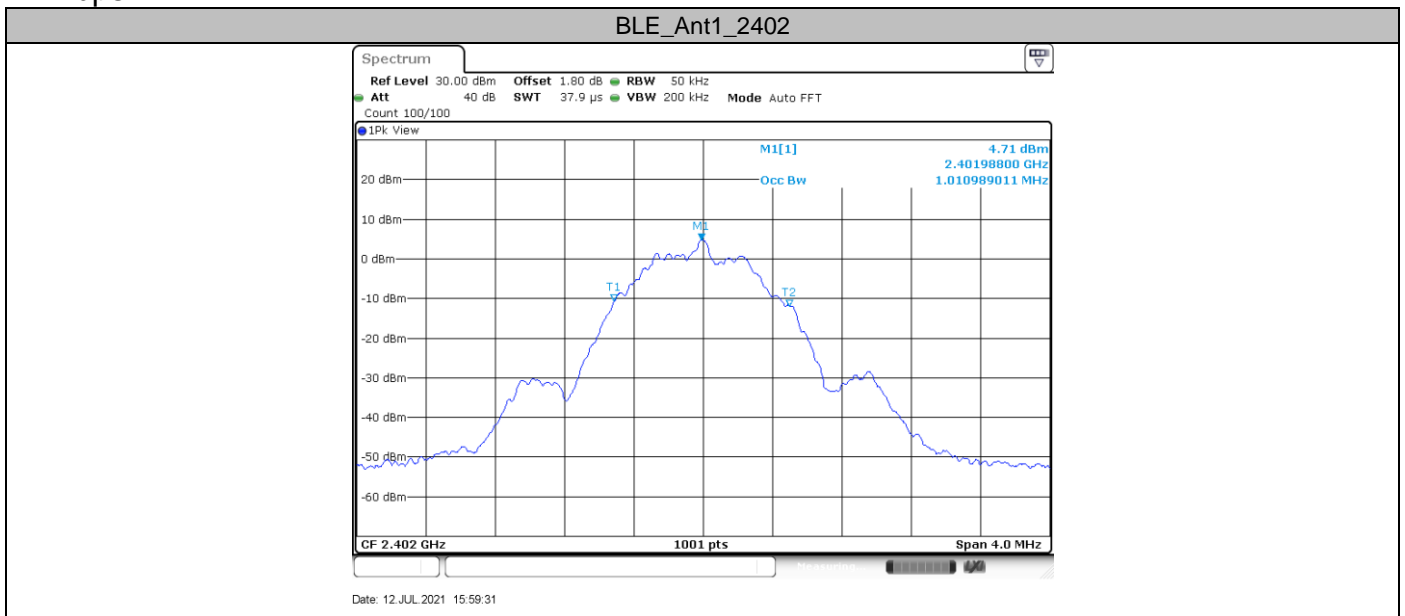

BLE_Ant1_2440

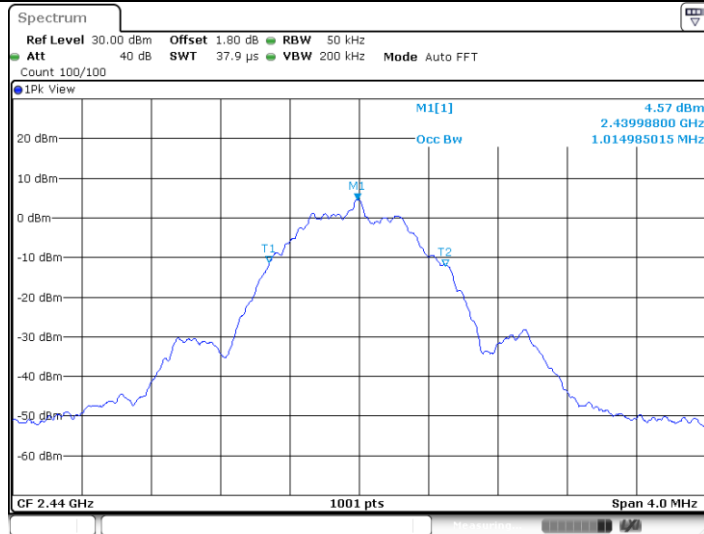

Date: 12.JUL.2021 16:01:24

BLE_Ant1_2480

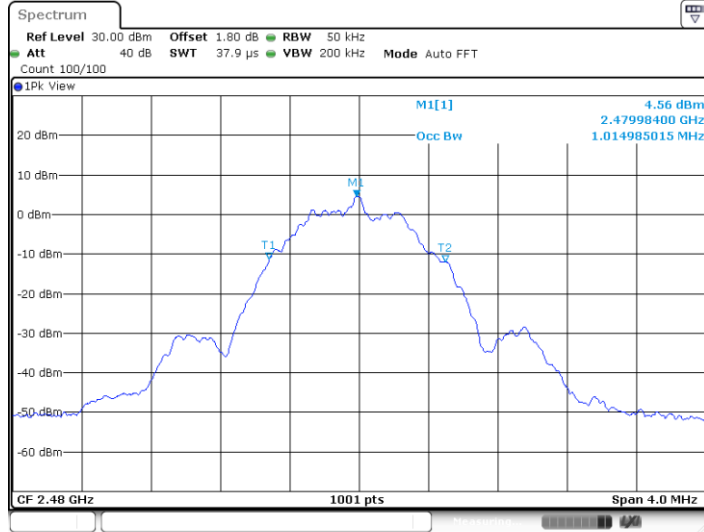

Date: 12.JUL.2021 16:03:00

2 Mbps:

BLE_Ant1_2402



Date: 12 JUL 2021 16:06:30

BLE_Ant1_2440

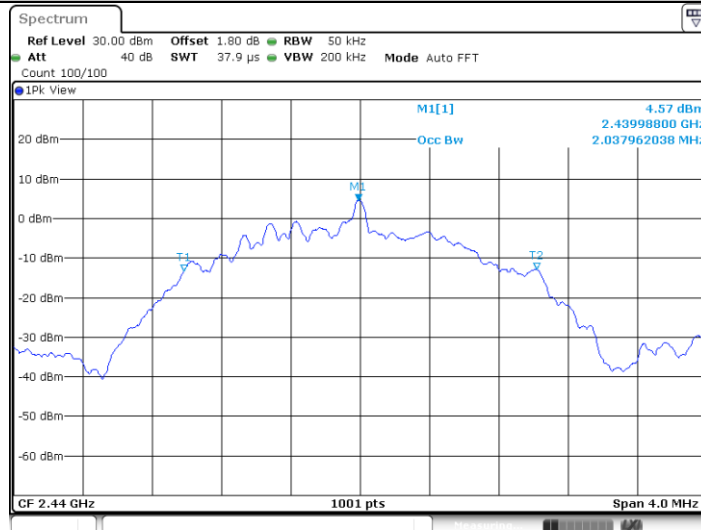

Date: 12 JUL 2021 16:08:32

BLE_Ant1_2480

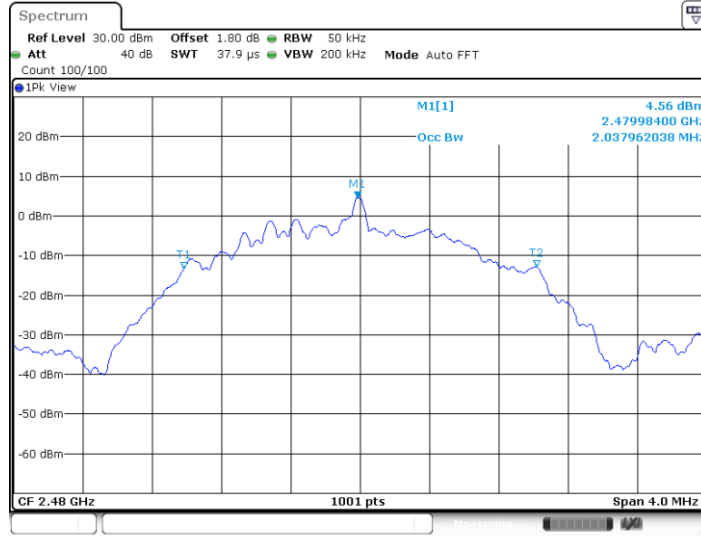

Date: 12 JUL 2021 16:10:21

9.5 Power spectral density

Test Method

This procedure shall be used if maximum peak conducted output power was used to demonstrate compliance:

1. The RF output of EUT was connected to the test receiver by RF cable. The path loss was compensated to the results for each measurement.
2. Set analyzer center frequency to DTS channel center frequency. RBW=3kHz, VBW≥3RBW, Span=1.5 times DTS bandwidth, Detector=Peak, Sweep=auto, Trace= max hold.
3. Allow trace to fully stabilize, use the peak marker function to determine the maximum amplitude level within the RBW.
4. Repeat above procedures until other frequencies measured were completed.

Limit

Limit [dBm/3KHz]

≤8

Test result

Data rate	Channel (MHz)	Result (dBm/3KHz)	Limit(dBm/3KHz)	Verdict
1 Mbps	2402	-9.44	8	PASS
	2440	-9.40	8	PASS
	2480	-9.38	8	PASS
2 Mbps	2402	-9.80	8	PASS
	2440	-9.77	8	PASS
	2480	-9.58	8	PASS

Test Graphs

1 Mbps:

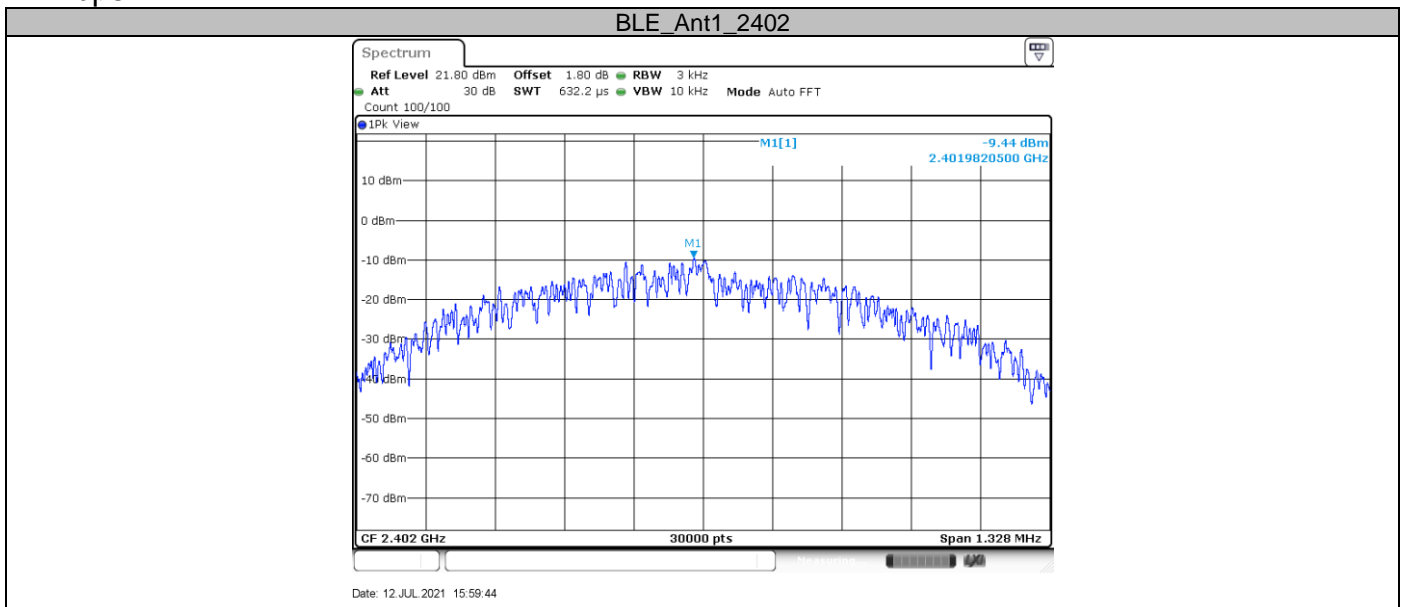

BLE_Ant1_2440

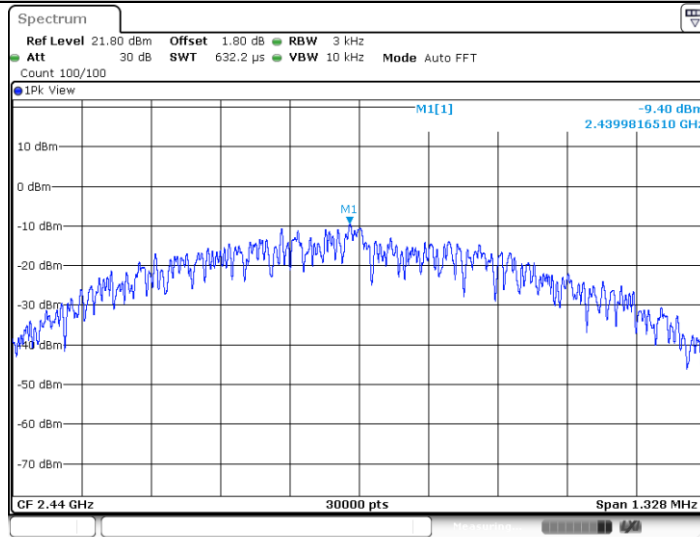

Date: 12 JUL 2021 16:01:36

BLE_Ant1_2480

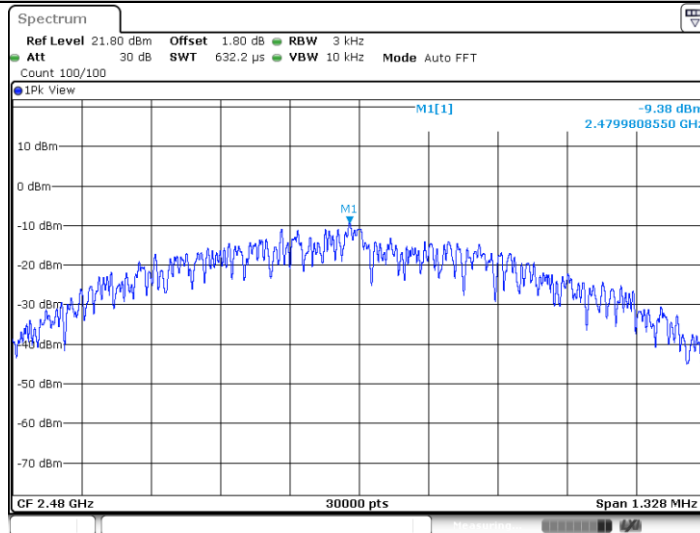

Date: 12 JUL 2021 16:03:12

2 Mbps:

BLE_Ant1_2402

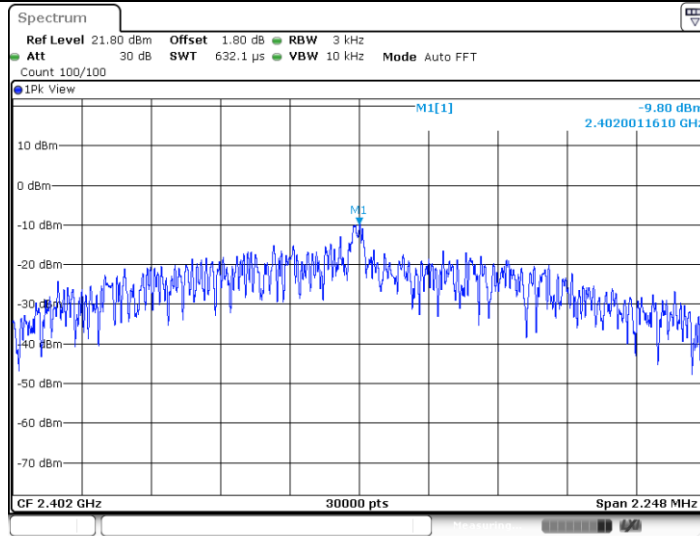

Date: 12.JUL.2021 16:06:43

BLE_Ant1_2440

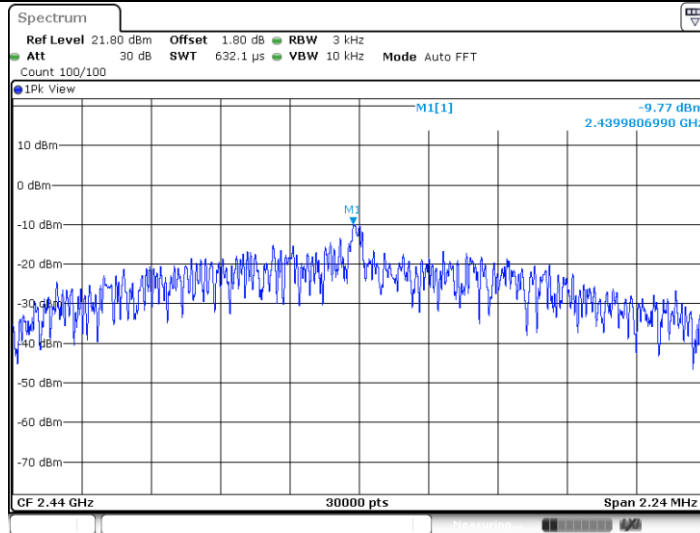

Date: 12.JUL.2021 16:08:45

BLE_Ant1_2480

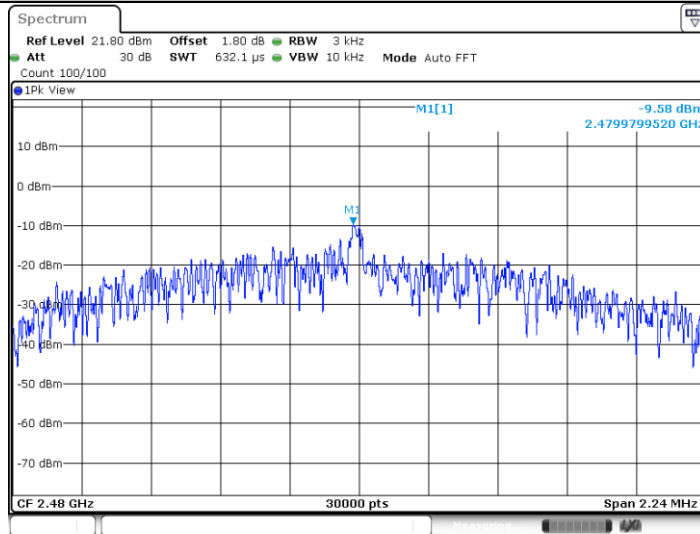

Date: 12.JUL.2021 16:10:33

9.6 Spurious RF conducted emissions

Test Method

1. The RF output of EUT was connected to the spectrum analyzer by RF cable. The path loss was compensated to the results for each measurement.
2. Use the following spectrum analyzer settings:
Span = wide enough to capture the peak level of the in-band emission and all spurious emissions (e.g., harmonics) from the lowest frequency generated in the EUT up through the 10th harmonic. Typically, several plots are required to cover this entire span.
RBW = 100 kHz, VBW ≥ RBW, Sweep = auto, Detector function = peak, Trace = max hold
3. Allow the trace to stabilize. Set the marker on the peak of any spurious emission recorded.
4. The level displayed must comply with the limit specified in this Section. Submit these plots.
5. Repeat above procedures until all frequencies measured were complete.

Limit

Frequency Range MHz	Limit (dBc)
30-25000	-20

Test Result

Remark: The emissions exceed limit is fundamental signal.

1 Mbps:

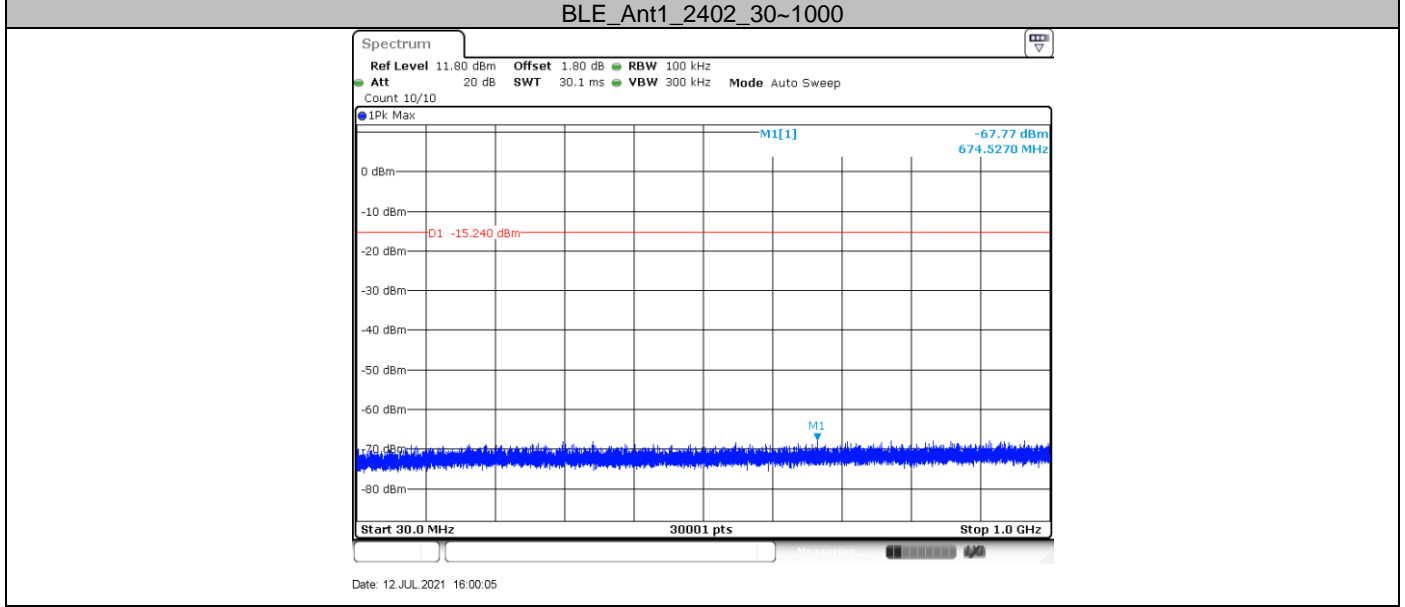
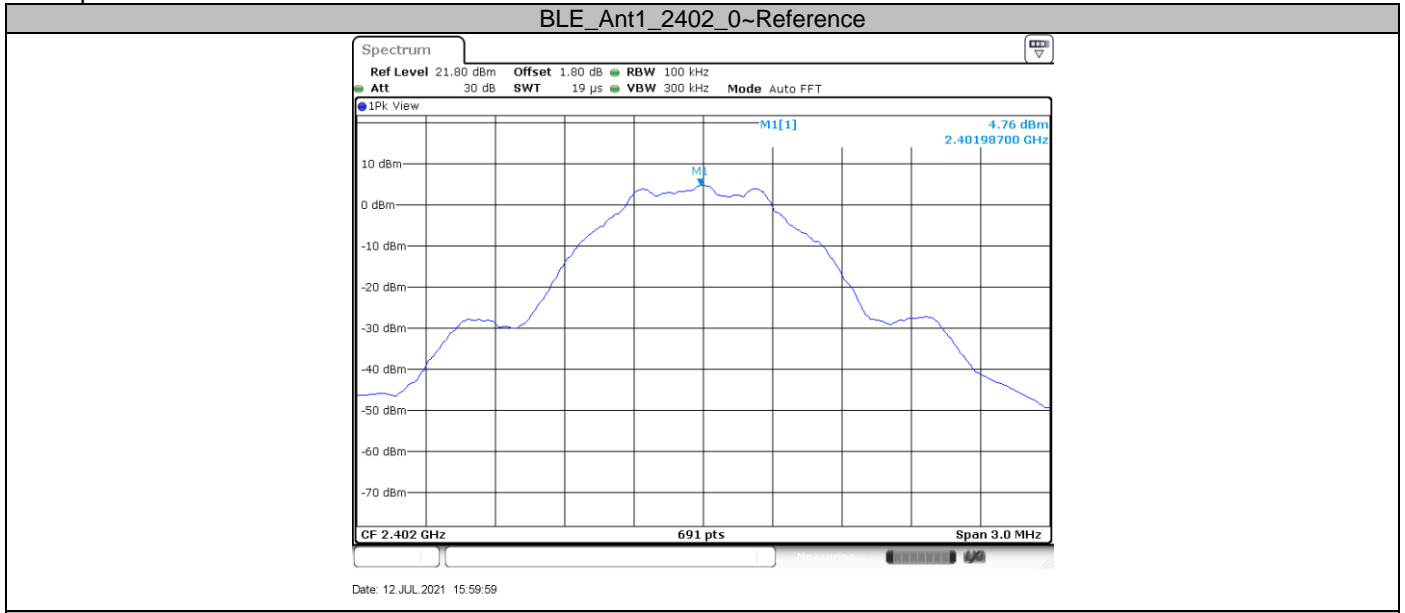

BLE_Ant1_2402_1000~26500

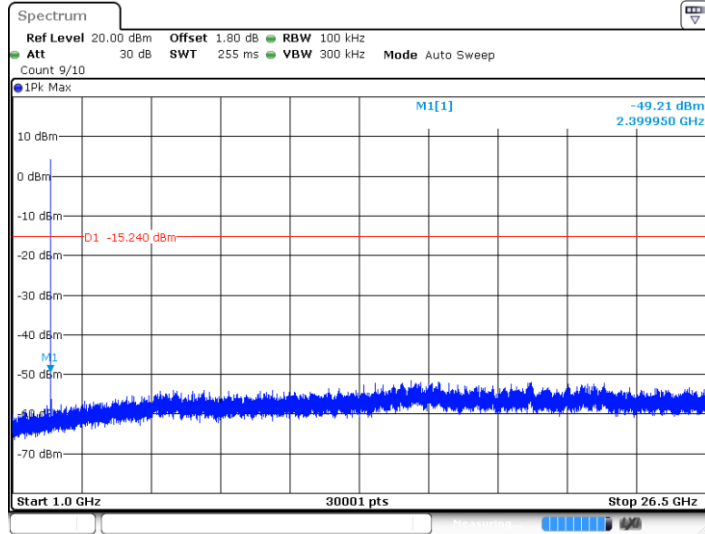

Date: 12 JUL 2021 16:00:13

BLE_Ant1_2440_0~Reference

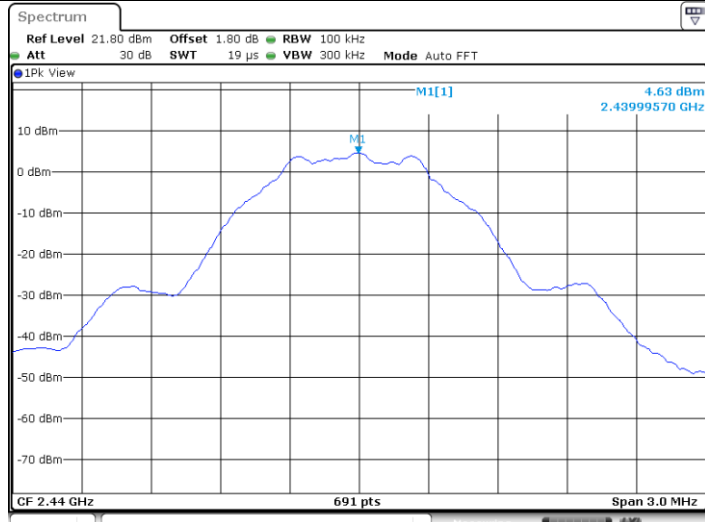

Date: 12 JUL 2021 16:01:42

BLE_Ant1_2440_30~1000

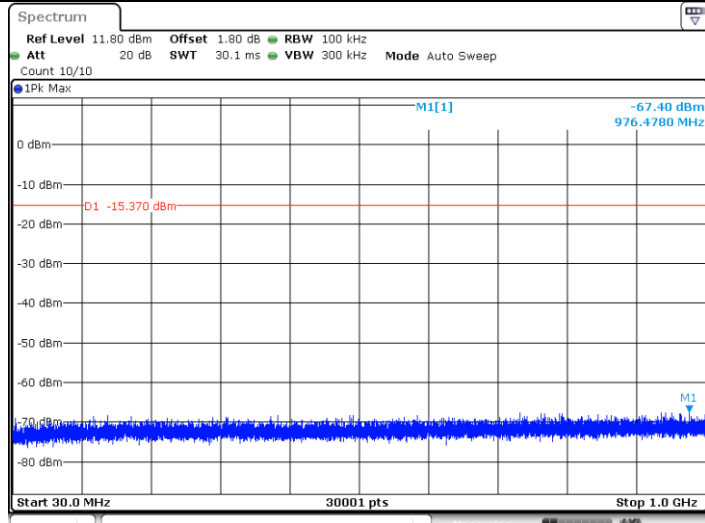

Date: 12 JUL 2021 16:01:48

BLE_Ant1_2440_1000~26500

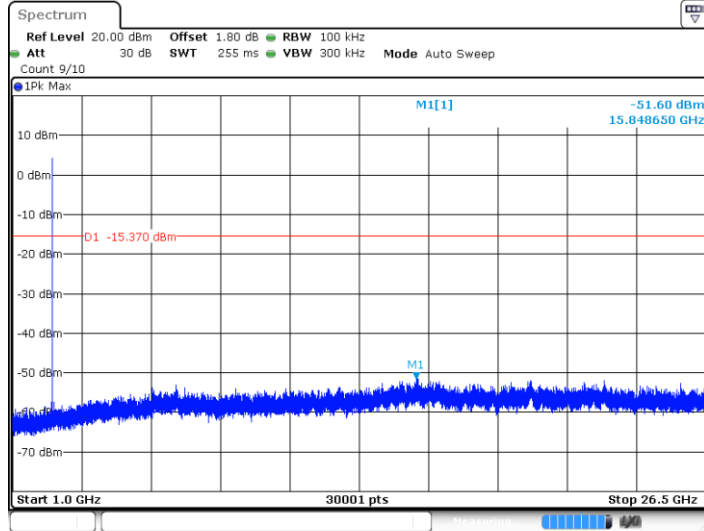

Date: 12.JUL.2021 16:01:56

BLE_Ant1_2480_0~Reference

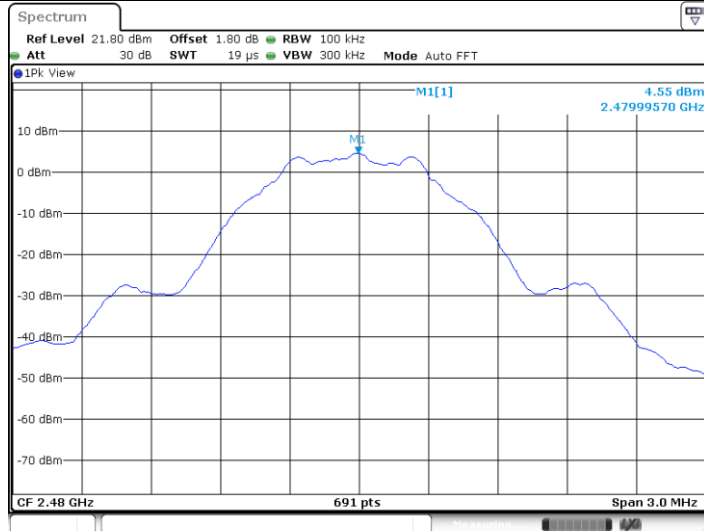

Date: 12.JUL.2021 16:03:27

BLE_Ant1_2480_30~1000

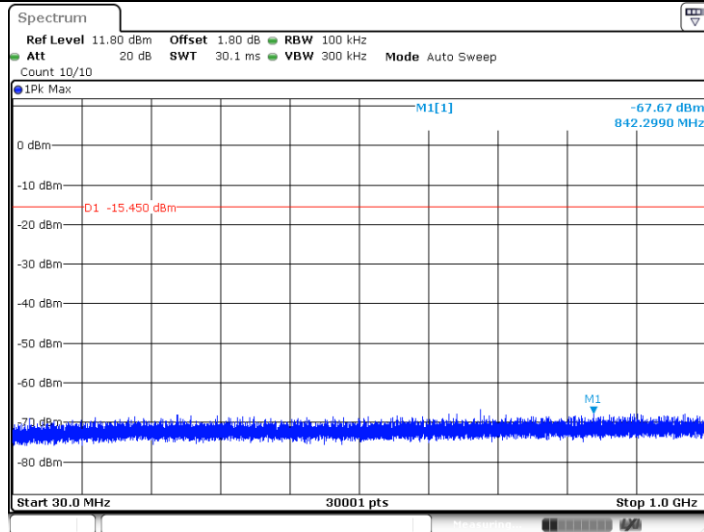

Date: 12.JUL.2021 16:03:33

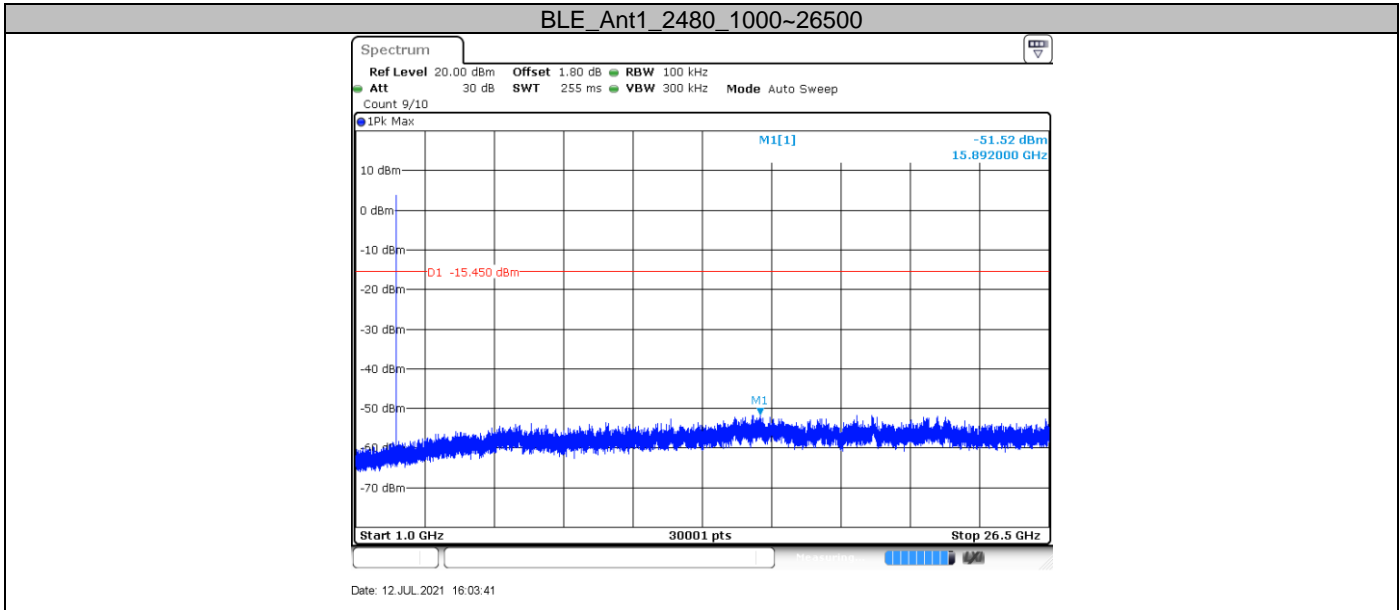

2 Mbps:

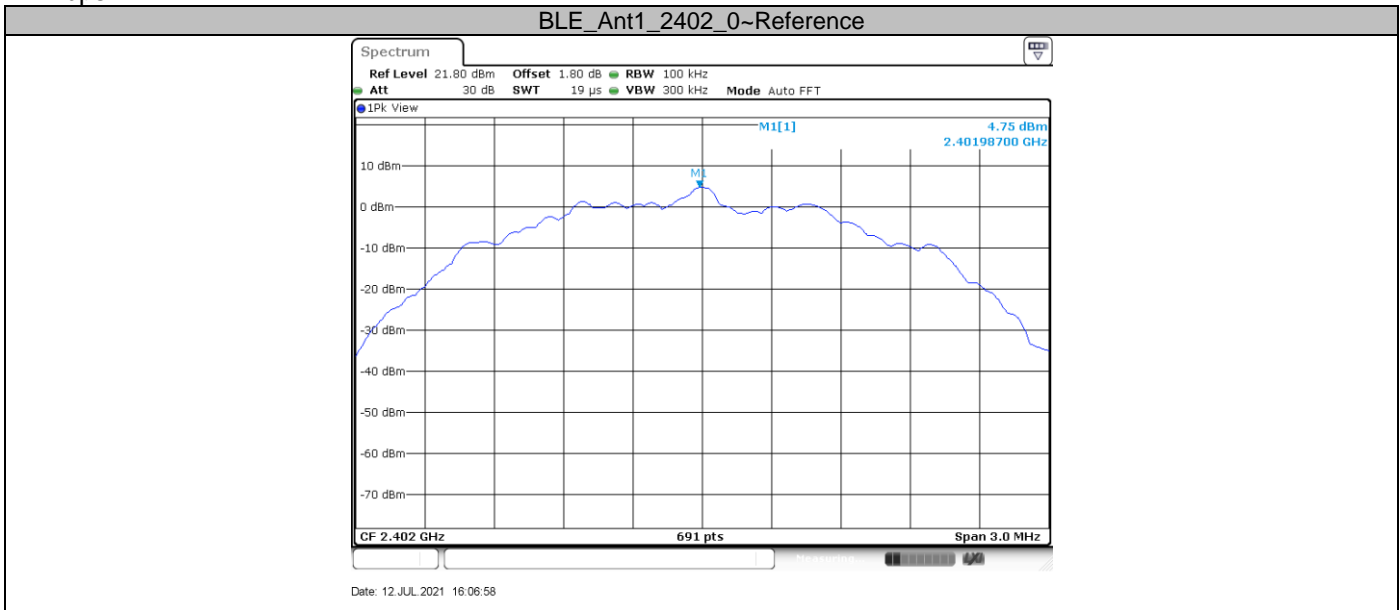

BLE_Ant1_2402_30~1000

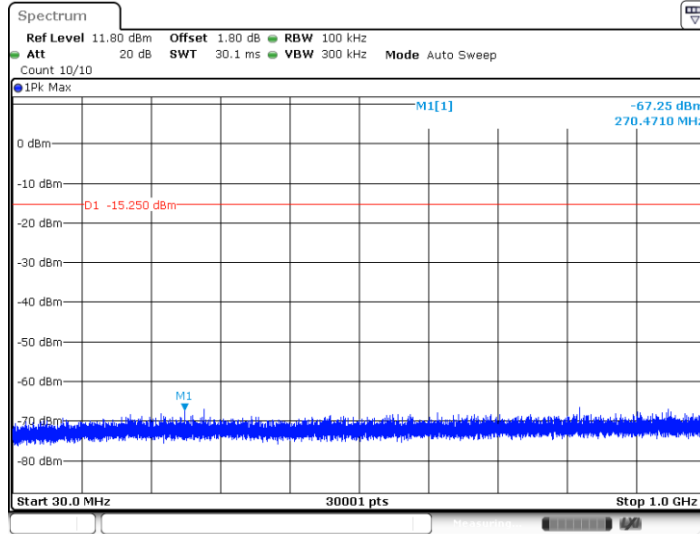

Date: 12 JUL 2021 16:07:04

BLE_Ant1_2402_1000~26500

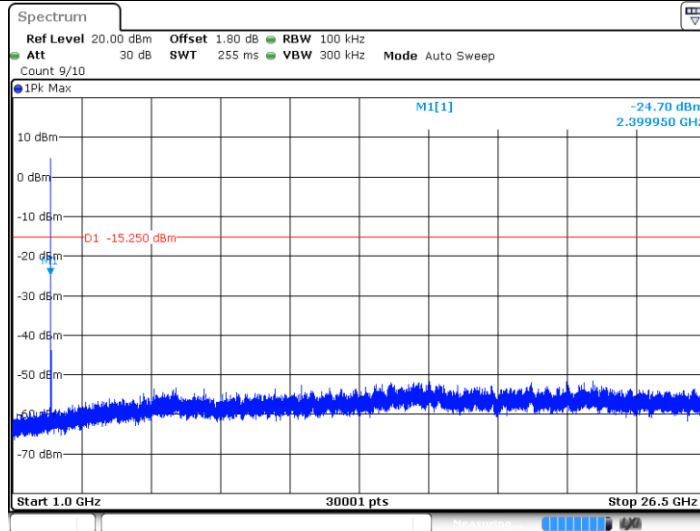

Date: 12 JUL 2021 16:07:12

BLE_Ant1_2440_0~Reference

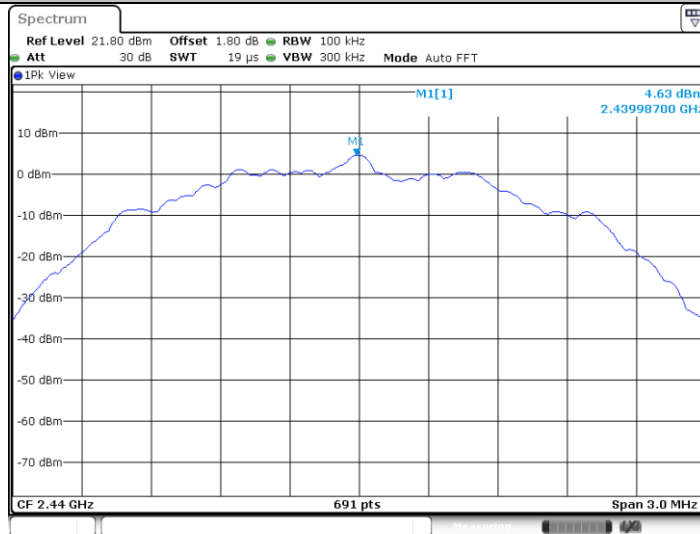

Date: 12 JUL 2021 16:08:50

BLE_Ant1_2440_30~1000

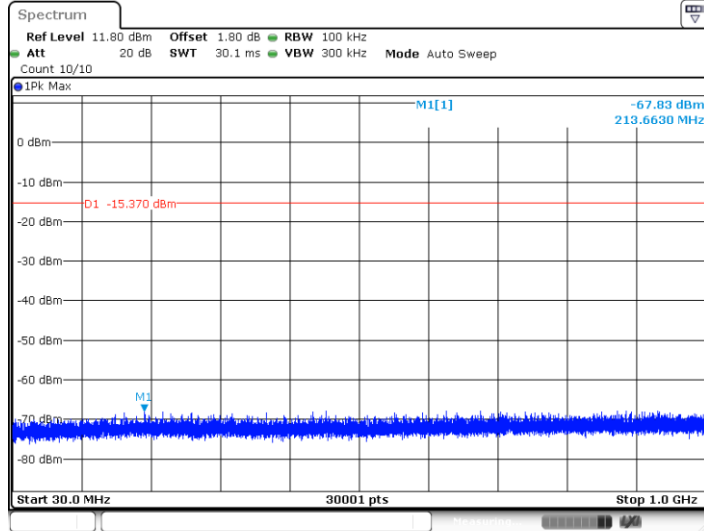

Date: 12 JUL 2021 16:08:56

BLE_Ant1_2440_1000~26500

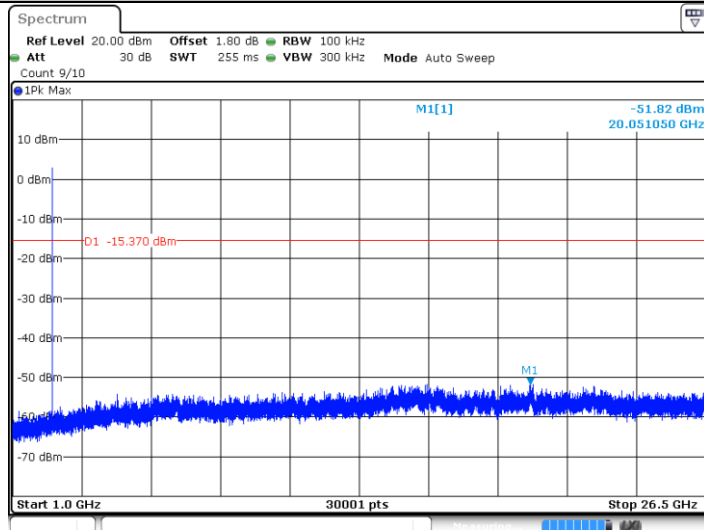

Date: 12 JUL 2021 16:09:04

BLE_Ant1_2480_0~Reference

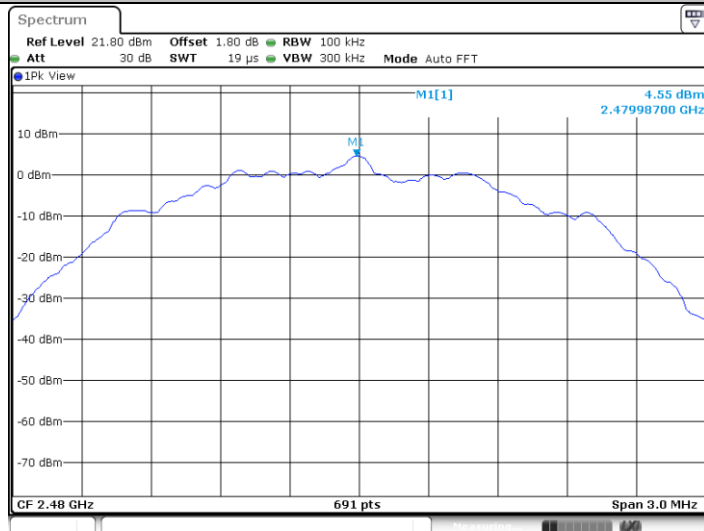

Date: 12 JUL 2021 16:10:48

BLE_Ant1_2480_30~1000

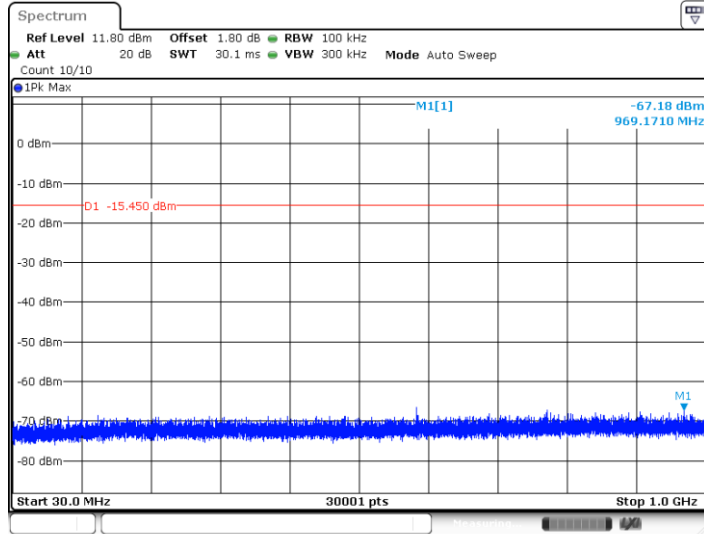

Date: 12 JUL 2021 16:10:54

BLE_Ant1_2480_1000~26500

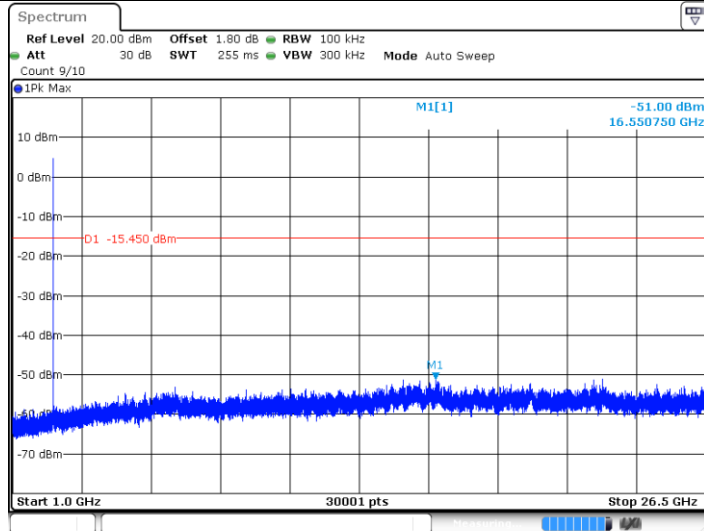

Date: 12 JUL 2021 16:11:02



9.7 Band edge

Test Method

1. The RF output of EUT was connected to the spectrum analyzer by RF cable. The path loss was compensated to the results for each measurement.
2. Use the following spectrum analyzer settings:
Span = wide enough to capture the peak level of the in-band emission and all spurious
RBW = 100 kHz, VBW ≥ RBW, Sweep = auto, Detector function = peak, Trace = max hold
3. Allow the trace to stabilize, use the peak and delta measurement to record the result.
4. The level displayed must comply with the limit specified in this Section.
5. Repeat the test at the hopping off and hopping on mode, submit all the plots.

Limit:

According to §15.247(d) and RSS-247 5.5, in any 100 kHz bandwidth outside the frequency bands in which the spread spectrum intentional radiator is operating, the radio frequency power that is produced by the intentional radiator shall be at least 20 dB below that in the 100 kHz bandwidth within the band that contains the highest level of the desired power, based on either an RF conducted or a radiated measurement, provided the transmitter demonstrates compliance with the peak conducted power limits. In addition, radiated emissions which fall in the restricted bands, as defined in §15.205(a) and RSS-Gen 8.10, must also comply with the radiated emission limits specified in 15.209(a) (see Section 15.205(c)) and RSS-Gen.

Frequency Range MHz	Limit (dBc)
30-25000	-20

Test result

1 Mbps:

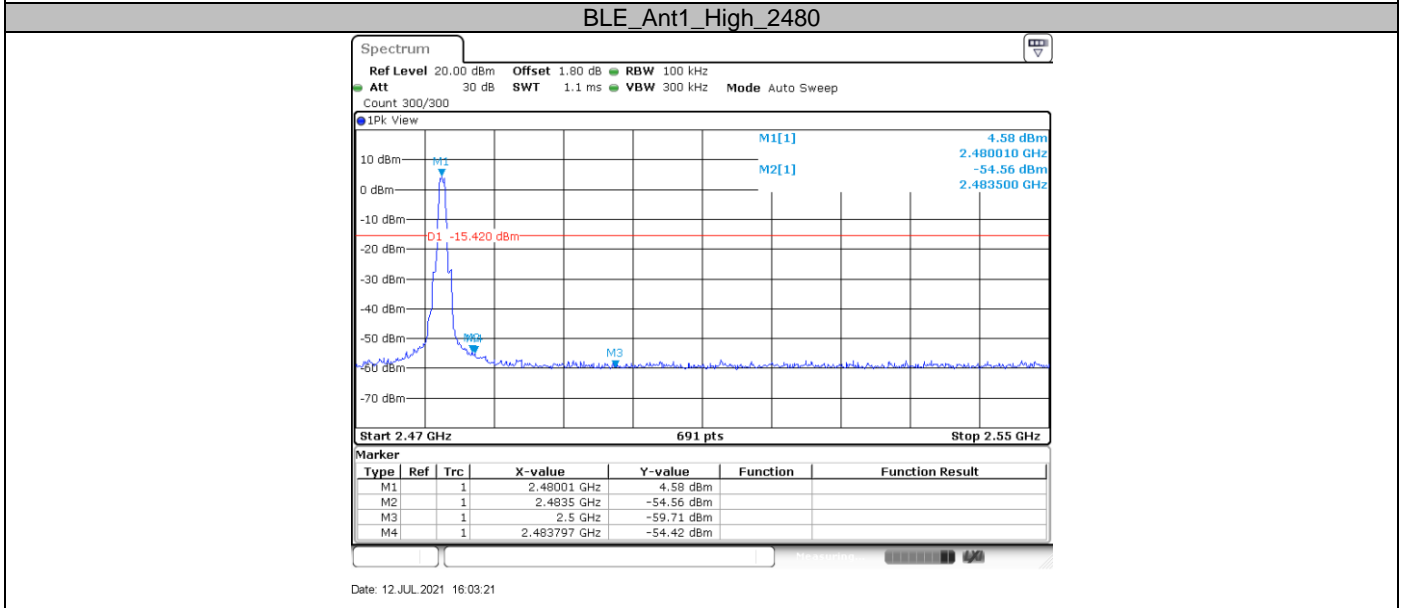
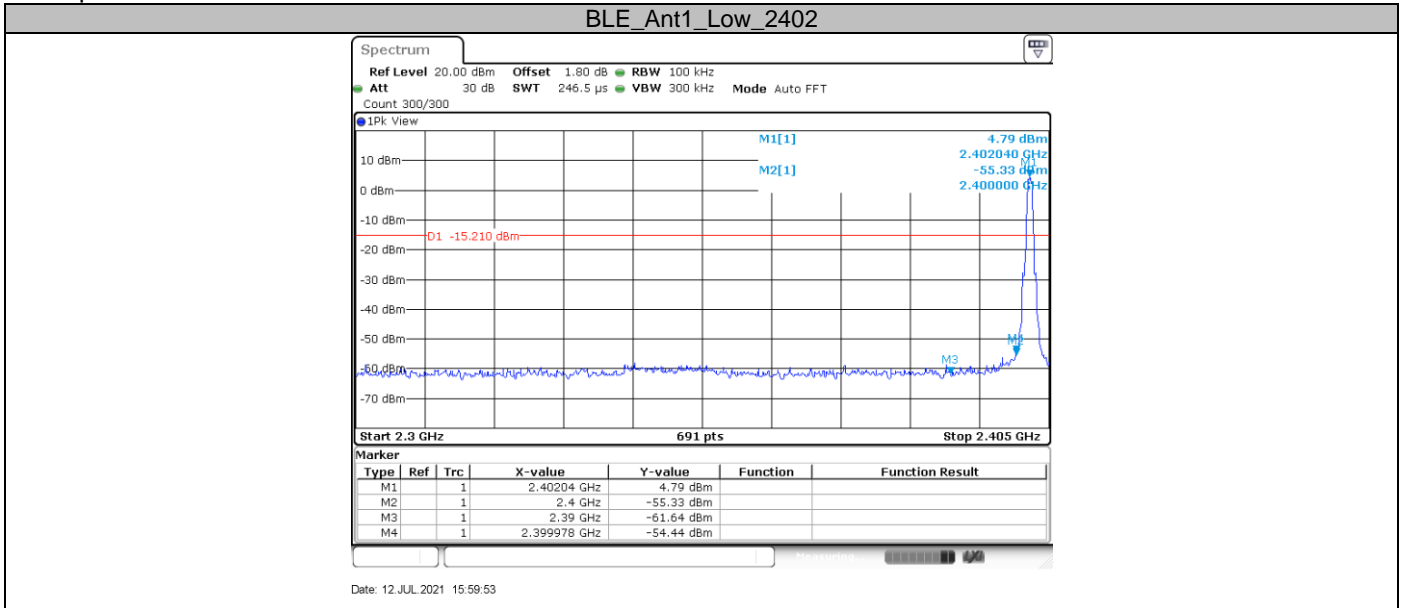

2 Mbps:

BLE_Ant1_Low_2402

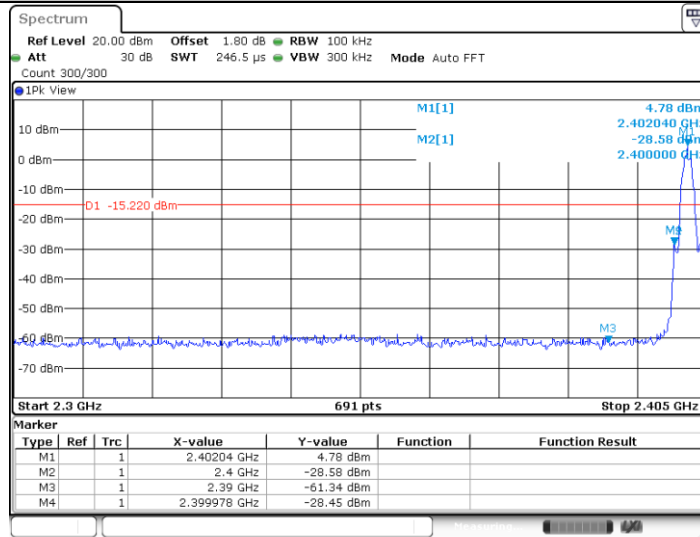

Date: 12 JUL 2021 16:06:52

BLE_Ant1_High_2480

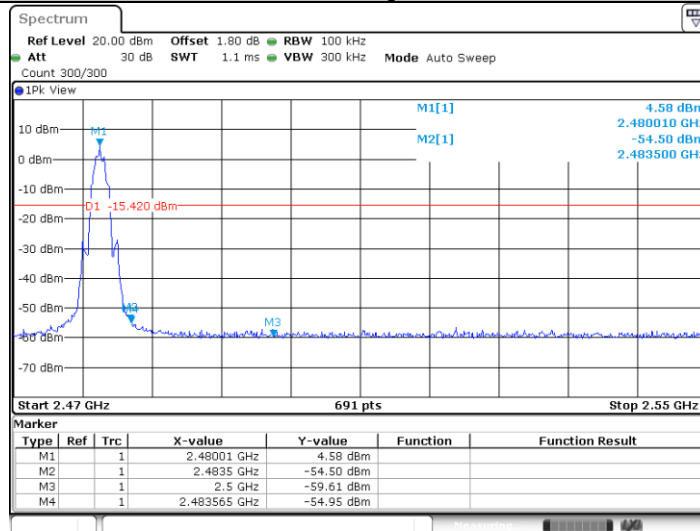

Date: 12 JUL 2021 16:10:42

9.8 Spurious radiated emissions for transmitter

Test Method

- 1: The EUT was placed on a turn table which is 1.5m above ground plane for above 1GHz and 0.8m above ground for below 1GHz at 3 meter chamber room for test. The table was rotated 360 degrees to determine the position of the highest radiation.
- 2: The EUT was set 3 meters away from the interference – receiving antenna, which was mounted on the top of a variable – height antenna tower.
- 3: The height of antenna is varied from one meter to four meters above the ground to determine the maximum value of the field strength. Both horizontal and vertical polarizations of the antenna are set to make the measurement.
- 4: For each suspected emission, the EUT was arranged to its worst case and then the antenna was tuned to heights from 1 meter to 4 meters and the rotatable table was turned from 0 degrees to 360 degrees to find the maximum reading.
- 5: Use the following spectrum analyzer settings According to C63.10:

For Below 1GHz

Use the following spectrum analyzer settings:

Span = wide enough to capture the peak level of the in-band emission and all spurious
 RBW = 100 KHz to 120KHz, VBW ≥ RBW for peak measurement, Sweep = auto, Detector function = peak, Trace = max hold.

For Peak unwanted emissions Above 1GHz:

Span = wide enough to capture the peak level of the in-band emission and all spurious
 RBW = 1MHz, VBW ≥ RBW for peak measurement, Sweep = auto, Detector function = peak, Trace = max hold.

Procedures for average unwanted emissions measurements above 1000 MHz

a) RBW = 1MHz.

b) VBW \ [3 × RBW].

c) Detector = RMS (power averaging), if [span / (# of points in sweep)] \ RBW / 2.

Satisfying this condition can require increasing the number of points in the sweep or reducing the span. If the condition is not satisfied, then the detector mode shall be set to peak.

d) Averaging type = power (i.e., rms) (As an alternative, the detector and averaging type may be set for linear voltage averaging. Some instruments require linear display mode to use linear voltage averaging. Log or dB averaging shall not be used.)

e) Sweep time = auto.

f) Perform a trace average of at least 100 traces if the transmission is continuous. If the transmission is not continuous, then the number of traces shall be increased by a factor of 1 / D, where D is the duty cycle. For example, with 50% duty cycle, at least 200 traces shall be averaged. (If a specific emission is demonstrated to be continuous—i.e., 100% duty cycle—then rather than turning ON and OFF with the transmit cycle, at least 100 traces shall be averaged.)

g) If tests are performed with the EUT transmitting at a duty cycle less than 98%, then a correction factor shall be added to the measurement results prior to comparing with the emission limit, to compute the emission level that would have been measured had the test been performed at 100% duty cycle. The correction factor is computed as follows:

1) If power averaging (rms) mode was used in the preceding step e), then the correction factor is $[10 \log (1 / D)]$, where D is the duty cycle. For example, if the transmit duty

cycle was 50%, then 3 dB shall be added to the measured emission levels.

2) If linear voltage averaging mode was used in the preceding step e), then the correction factor is $[20 \log (1 / D)]$, where D is the duty cycle. For example, if the transmit duty cycle was 50%, then 6 dB shall be added to the measured emission levels.

3) If a specific emission is demonstrated to be continuous (100% duty cycle) rather than turning ON and OFF with the transmit cycle, then no duty cycle correction is required for that emission.

Limit

The radio emission outside the operating frequency band shall be at least 20 dB below that in the 100 kHz bandwidth within the band that contains the highest level of the desired power. Radiated emissions which fall in the restricted bands, as defined in section 15.205 and RSS-GEN 8.10, must comply with the radiated emission limits specified in section 15.209.

Frequency MHz	Field Strength uV/m	Field Strength dBµV/m	Detector
30-88	100	40	QP
88-216	150	43.5	QP
216-960	200	46	QP
960-1000	500	54	QP
Above 1000	500	54	AV
Above 1000	5000	74	PK

Spurious radiated emissions for transmitter

According to C63.10, if the peak (or quasi-peak) measured value complies with the average limit, it is unnecessary to perform an average measurement, so AV emission value did not show in below table if the peak value complies with average limit.

The only worse case (1 Mbps) test result is listed in the report.

Transmitting spurious emission test result as below:

Below 1G:

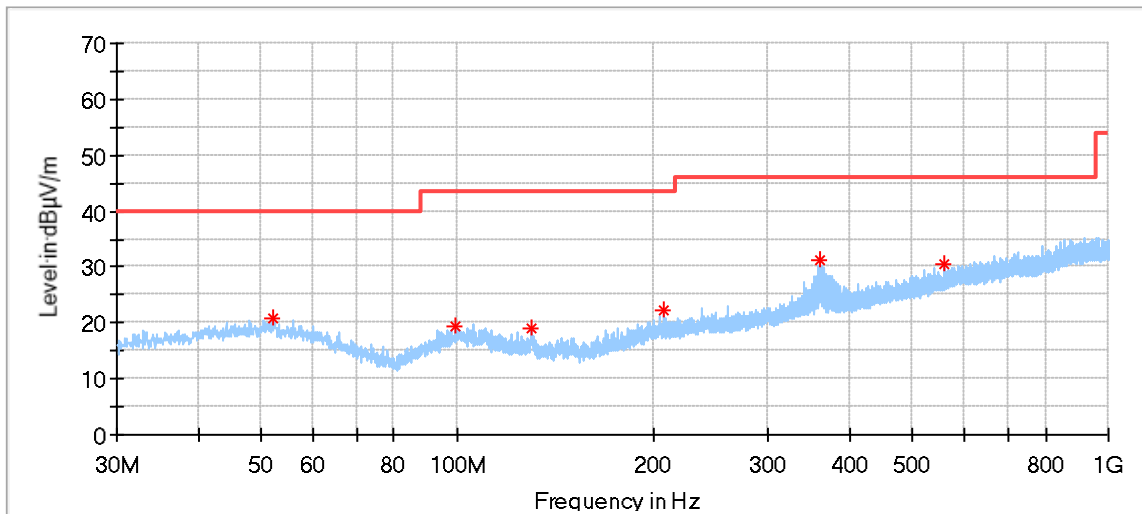

Frequency (MHz)	MaxPeak (dBµV/m)	Limit (dBµV/m)	Margin (dB)	Height (cm)	Pol	Azimuth (deg)	Corr. (dB/m)
52.202222	20.78	40.00	19.22	100.0	H	105.0	14.53
99.624444	19.38	43.50	24.12	100.0	H	11.0	12.95
130.287222	19.00	43.50	24.50	200.0	H	9.0	10.06
207.833333	22.11	43.50	21.39	100.0	H	336.0	13.07
360.985556	31.20	46.00	14.80	100.0	H	121.0	16.83
558.865556	30.44	46.00	15.56	200.0	H	318.0	21.06

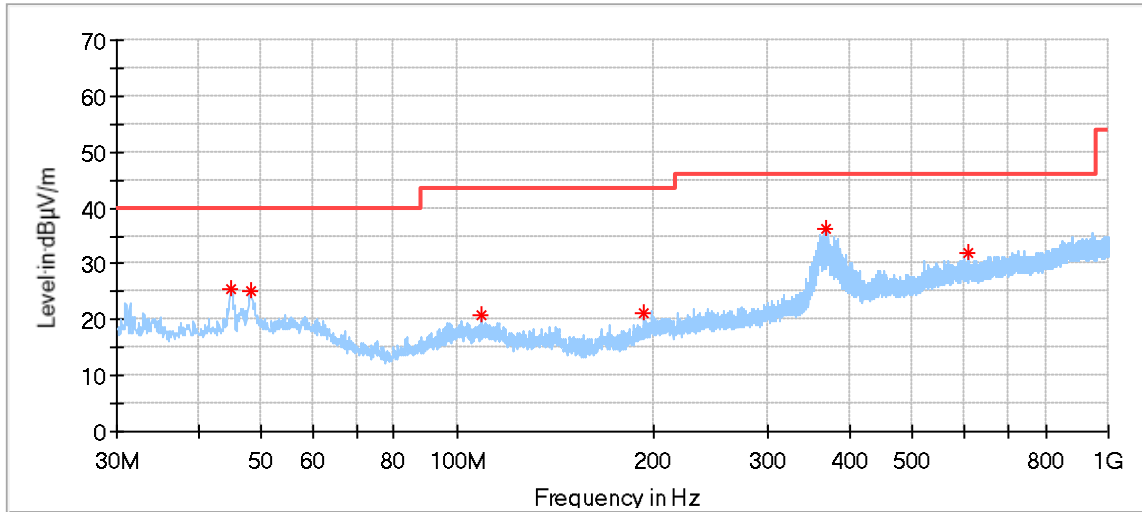

Frequency (MHz)	MaxPeak (dBµV/m)	Limit (dBµV/m)	Margin (dB)	Height (cm)	Pol	Azimuth (deg)	Corr. (dB/m)
44.873333	25.43	40.00	14.57	100.0	V	11.0	14.15
48.214444	24.99	40.00	15.01	100.0	V	247.0	14.59
109.055000	20.82	43.50	22.68	100.0	V	275.0	12.02
193.660556	21.06	43.50	22.44	200.0	V	76.0	12.46
368.045000	36.18	46.00	9.82	100.0	V	4.0	17.00
609.952222	31.83	46.00	14.17	100.0	V	137.0	22.00

Low channel 2402MHz

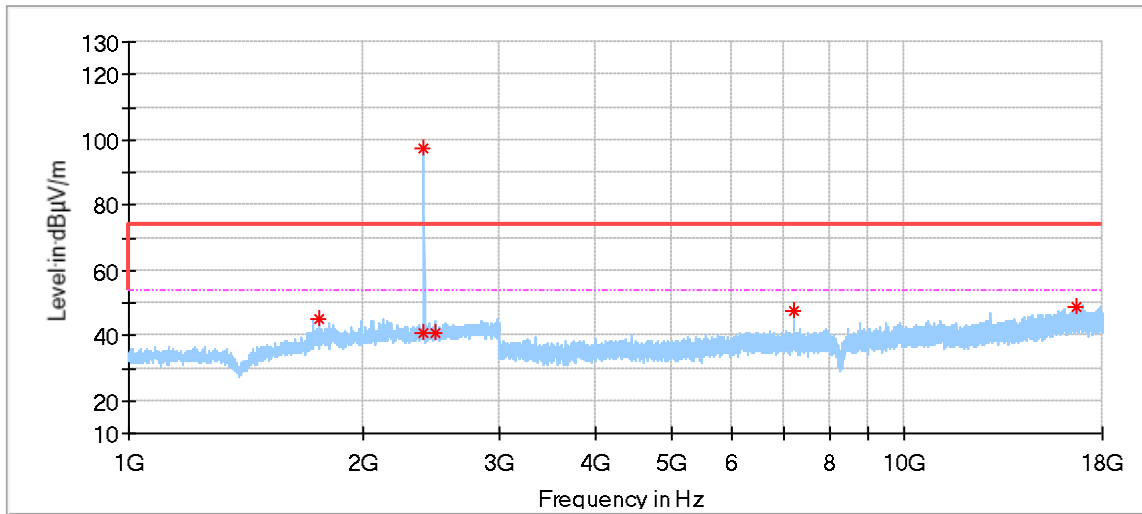

Frequency (MHz)	MaxPeak (dBµV/m)	Limit (dBµV/m)	Margin (dB)	Height (cm)	Pol	Azimuth (deg)	Corr. (dB/m)
1756.666667	45.25	74.00	28.75	150.0	H	252.0	-6.10
2390.476191	40.88	74.00	33.12	150.0	H	258.0	-2.96
2402.380952	97.31	--	--	150.0	H	114.0	--
2483.809524	40.76	74.00	33.24	150.0	H	207.0	-2.69
7205.500000	47.63	74.00	26.37	150.0	H	308.0	6.80
16665.500000	48.99	74.00	25.01	150.0	H	109.0	17.87

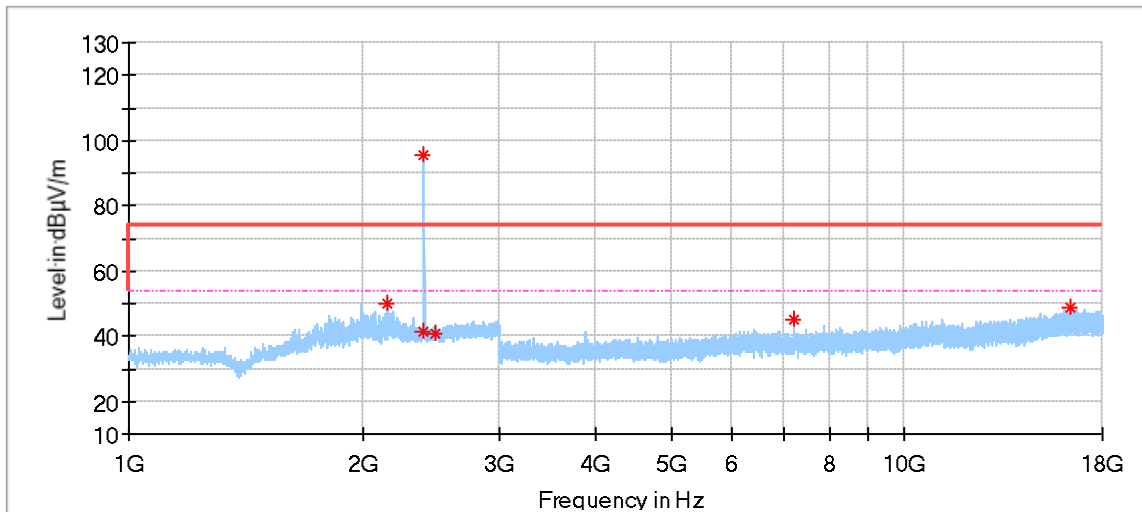

Frequency (MHz)	MaxPeak (dBµV/m)	Limit (dBµV/m)	Margin (dB)	Height (cm)	Pol	Azimuth (deg)	Corr. (dB/m)
2157.142857	49.78	74.00	24.22	150.0	V	210.0	-3.77
2390.000000	41.20	74.00	32.80	150.0	V	223.0	-2.96
2402.380952	95.53	--	--	150.0	V	81.0	--
2483.809524	40.92	74.00	33.08	150.0	V	62.0	-2.69
7206.000000	44.77	74.00	29.23	150.0	V	289.0	6.80
16413.500000	49.02	74.00	24.98	150.0	V	356.0	16.97

Middle channel 2440MHz

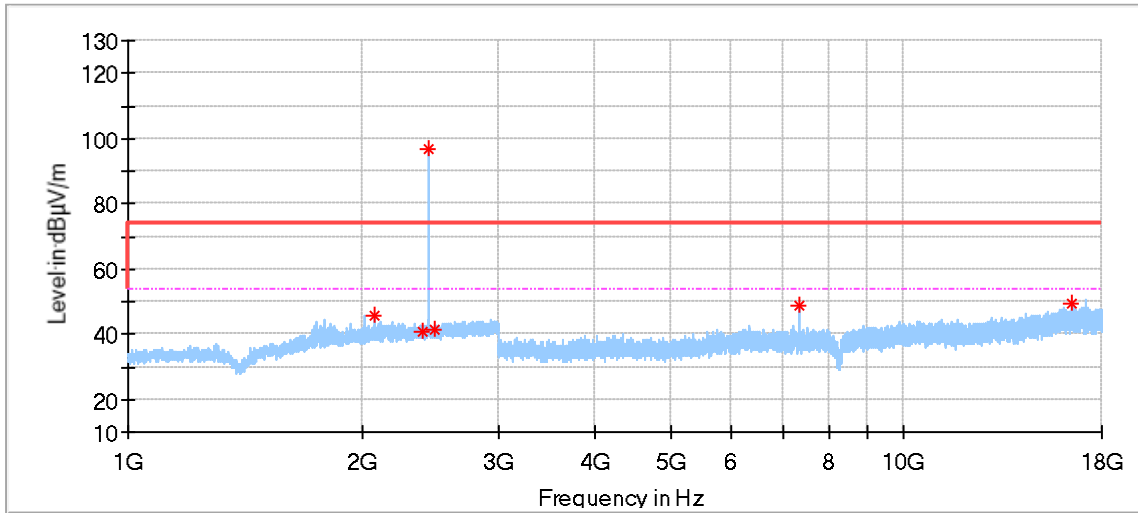

Frequency (MHz)	MaxPeak (dBµV/m)	Limit (dBµV/m)	Margin (dB)	Height (cm)	Pol	Azimuth (deg)	Corr. (dB/m)
2076.190476	45.57	74.00	28.43	150.0	H	258.0	-4.04
2390.476191	40.48	74.00	33.52	150.0	H	123.0	-2.96
2440.000000	96.69	--	--	150.0	H	53.0	--
2482.857143	41.14	74.00	32.86	150.0	H	290.0	-2.69
7320.000000	48.59	74.00	25.41	150.0	H	308.0	7.04
16449.000000	49.09	74.00	24.91	150.0	H	283.0	17.22

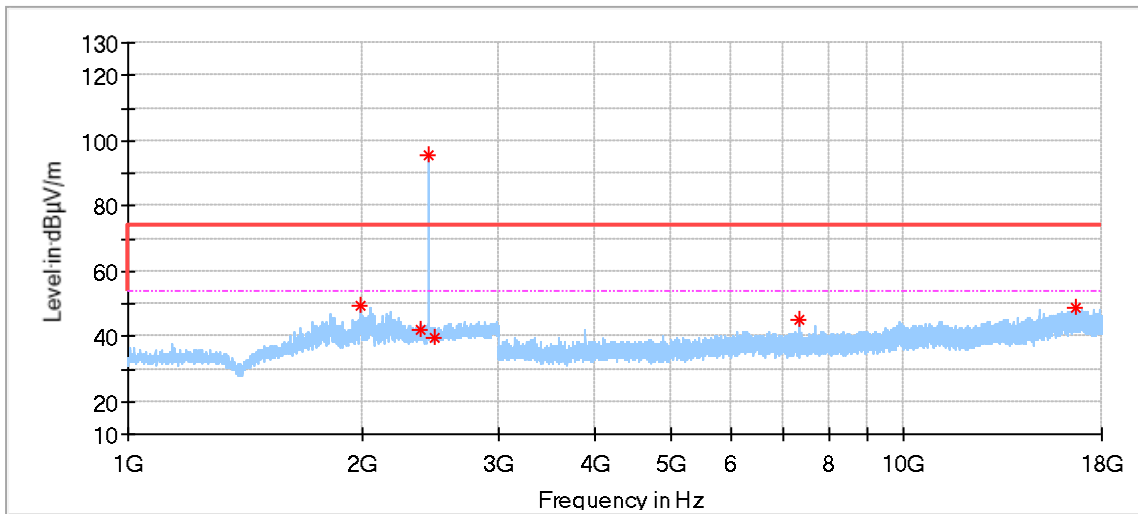

Frequency (MHz)	MaxPeak (dBµV/m)	Limit (dBµV/m)	Margin (dB)	Height (cm)	Pol	Azimuth (deg)	Corr. (dB/m)
1993.809524	49.26	74.00	24.74	150.0	V	200.0	-4.29
2389.047619	42.16	74.00	31.84	150.0	V	65.0	-2.95
2440.476191	95.77	--	--	150.0	V	194.0	--
2483.809524	39.78	74.00	34.22	150.0	V	232.0	-2.69
7319.500000	44.89	74.00	29.11	150.0	V	165.0	7.04
16618.000000	48.65	74.00	25.35	150.0	V	114.0	17.87

High channel 2480MHz

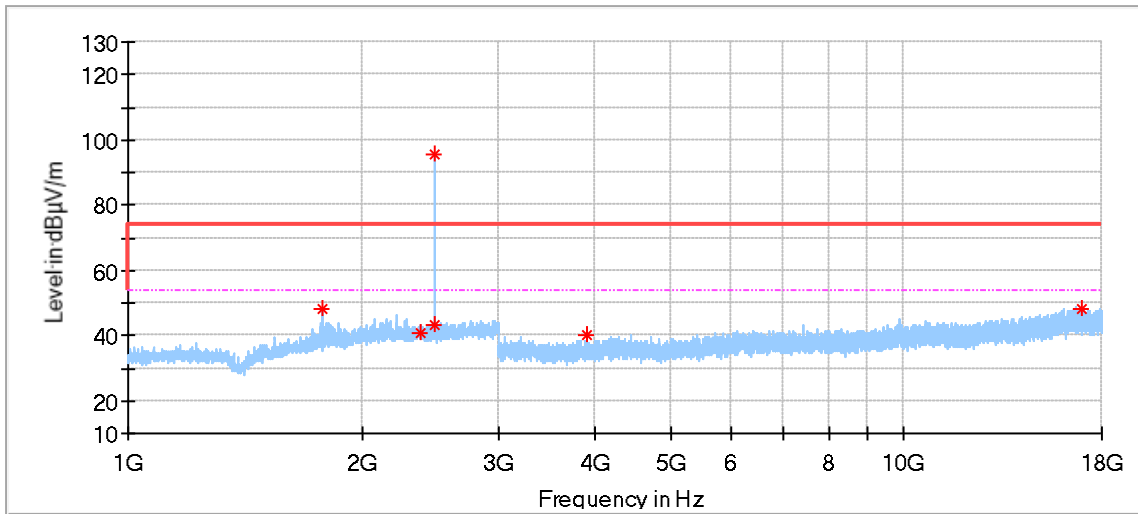

Frequency (MHz)	MaxPeak (dBµV/m)	Limit (dBµV/m)	Margin (dB)	Height (cm)	Pol	Azimuth (deg)	Corr. (dB/m)
1780.952381	48.09	74.00	25.91	150.0	H	250.0	-5.91
2389.523810	40.75	74.00	33.25	150.0	H	179.0	-2.96
2480.000000	95.55	--	--	150.0	H	51.0	--
2482.857143	43.25	74.00	30.75	150.0	H	96.0	-2.69
3900.000000	39.86	74.00	34.14	150.0	H	246.0	0.22
16916.500000	48.16	74.00	25.84	150.0	H	325.0	18.37

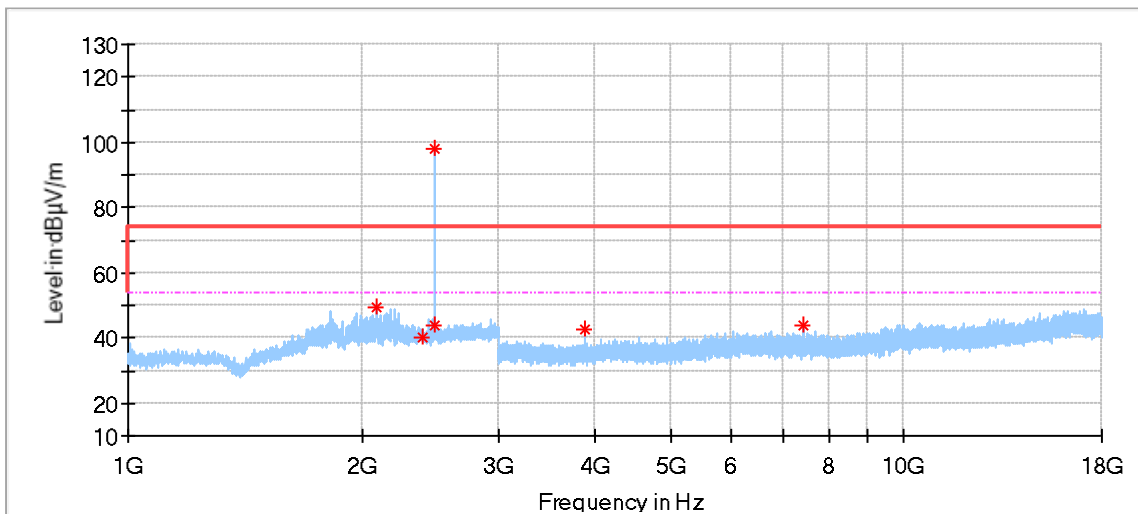

Frequency (MHz)	MaxPeak (dBµV/m)	Limit (dBµV/m)	Margin (dB)	Height (cm)	Pol	Azimuth (deg)	Corr. (dB/m)
2092.857143	49.21	74.00	24.79	150.0	V	205.0	-4.01
2390.000000	40.45	74.00	33.55	150.0	V	282.0	-2.96
2480.476191	98.06	--	--	150.0	V	128.0	--
2483.809524	43.58	74.00	30.42	150.0	V	128.0	-2.69
3883.000000	42.87	74.00	31.13	150.0	V	272.0	0.12

Remark:

- (1) Data of measurement within frequency range 18-26GHz are the noise floor or attenuated more than 20dB below the permissible limits or the field strength is too small to be measured, so test data does not present in this report,
- (2) These frequencies which exceed the limit are carrier frequency.

- (3) Level= Reading Level + Correction Factor
- (4) Above 1GHz: Corrector factor = Antenna Factor + Cable Loss- Amplifier Gain
Below 1GHz: Corrector factor = Antenna Factor + Cable Loss
(The Reading Level is recorded by software which is not shown in the sheet)

10 Test Equipment List

Conducted Emission Test

Description	Manufacturer	Model no.	Serial no.	cal. due date
EMI Test Receiver	Rohde & Schwarz	ESR 3	101782	2022-6-4
LISN	Rohde & Schwarz	ENV4200	100249	2022-6-5
Attenuator	Shanghai Huaxiang	TS2-26-3	080928189	2022-6-3
Test software	Rohde & Schwarz	EMC32	Version9.15.00	N/A

Radiated Emission Test

DESCRIPTION	MANUFACTURER	MODEL NO.	SERIAL NO.	CAL. DUE DATE
EMI Test Receiver	Rohde & Schwarz	ESR 26	101269	2022-6-4
Trilog Super Broadband Test Antenna	Schwarzbeck	VULB 9162	284	2021-8-20
Horn Antenna	Rohde & Schwarz	HF907	102295	2021-8-5
Wideband Horn Antenna	Q-PAR	QWH-SL-18-40-K-SG	12827	2021-8-5
Pre-amplifier	Rohde & Schwarz	SCU 18	102230	2022-6-6
Pre-amplifier	Rohde & Schwarz	SCU 40A	100432	2021-7-30
Attenuator	Agilent	8491A	MY39264334	2022-6-3
Test software	Rohde & Schwarz	EMC32	Version 9.15.00	N/A

RF conducted test

DESCRIPTION	MANUFACTURER	MODEL NO.	SERIAL NO.	CAL. DUE DATE
Signal Analyzer	Rohde & Schwarz	FSV40	101030	2022-6-3
RF Switch Module	Rohde & Schwarz	OSP120/OSP-B157	101226/100851	2022-6-3
Power Splitter	Weinschel	1580	SC319	2022-6-3
Test software	Tonscend	System for BT/WIFI	Version 2.6	N/A



11 System Measurement Uncertainty

For a 95% confidence level, the measurement expanded uncertainties for defined systems, in accordance with the recommendations of ISO 17025 were:

System Measurement Uncertainty	
Test Items	Extended Uncertainty
Uncertainty for Conducted Emission 150kHz-30MHz (for test using AMN ENV432 or ENV4200)	3.62dB
Uncertainty for Radiated Emission 25MHz-3000MHz	Horizontal: 4.63dB; Vertical: 4.61dB;
Uncertainty for Radiated Emission 3000MHz-18000MHz	Horizontal: 4.65dB; Vertical: 4.64dB;
Uncertainty for Radiated Emission 18000MHz-40000MHz	Horizontal: 4.89dB; Vertical: 4.87dB;
Uncertainty for Conducted RF test	RF Power Conducted: 1.16dB Frequency test involved: 0.6×10^{-7} or 1%

---The End---