

MANUAL/SPECIFICATIONS

Prepared on behalf of:

Mitsumi Electric Co., Ltd.
8-8-2 Kokuryo-cho, Chofu-shi
Tokyo 182 Japan

FCC ID #:	CMYKFK8065
Form 731 Confirmation #:	EA92817

FCC COMPLIANCE STATEMENT

The product described herein has been tested by a duly accredited laboratory and found to comply with the Class B Standards for a computing device set forth by the Federal Communications Commission in 47CFR Part 15.

Operation of this equipment is subject to the following two conditions: (1) This device may not cause harmful interference, and (2) this device must accept any interference received including interference that may cause undesirable operation.

This equipment has been tested and found to comply with the limits for a Class B digital device pursuant to Part 15 of the FCC Rules. These limits are designed to provide reasonable protection against harmful interference in a residential installation. This equipment generates, uses and can radiate radio frequency energy and if not installed and used properly, that is, in strict accordance with the manufacturer's instructions, as well as the instructions of any peripheral and accessories to be attached to this device, may cause harmful interference to radio communications. However, there is no guarantee that interference will not occur in a particular installation. If this equipment does cause interference to radio or television reception, which can be determined by turning the equipment off and on, the user is encouraged to try to correct the interference by one or more of the following measures:







- Reorient or relocate the receiving antenna
- Increase the separation between the equipment and receiver
- Connect the equipment into an outlet on a circuit different from that to which the receiver is connected
- Consult the dealer or an experienced radio/TV technician for help

Notice:

- To meet FCC requirements, shielded AC power cord and shielded interface cables are required to connect the device to a personal computer peripheral, or other Class B device.
- Any peripheral and/or accessories that will be attached to this equipment must also be compliant to Part 15 of the FCC Rules.

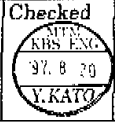
Warning to User:

Any changes or modifications not expressly approved by the party responsible for compliance could void the user's authority to operate the equipment.

 0214	キーボード製品規格書 SPECIFICATION OF KEYBOARD SWITCH KFK type	Approved 	Checked 	Drawn 
		AUG.06.1997 enact		
<p>1. Scope : This specification covers MITSUMI keyboard switch KFK series.</p> <p>2. Electrical Specifications :</p> <p>2-1. Maximum Rating : D.C. 12V (with pulse width of 200 μ sec., duty ratio 1/50), 1mA.</p> <p>2-2. Contact Bounce : 5msec. Max ... Initial 10msec. Max ... Over life (at normal pushing)</p> <p>2-3. Contact Resistance : 1.5KΩ Max (resistance value of membrane circuit board is included.)</p> <p>2-4. Insulation Resistance : 50MΩ Max (at D.C. 200V)</p> <p>2-5. Withstand voltage : A.C.250V , 1 minute.</p> <p>2-6. Circuit : Make Contact , 1 circuit.</p> <p>3. Mechanical Specifications :</p> <p>3-1. Force :</p> <p>(1) Operating Force : 30g typical (2) Maximum Force : 50\pm20g (3) Click Rate : 45\pm20% (Decline of Clicking Force after 10 millions operation : within 30%)</p> <p>3-2. Operating point : 2.2~3.5mm stroke</p> <p>3-3. Full Travel : 4.2\pm0.5mm (at 200g)</p> <p>3-4. Key Touch Feeling : Keytop must be operated without squeaking , catching , locking with normal pushing.</p>				
				
R E V			CODE S 5 6	DRAWING NO. 0214
				

MITSUMI ELECTRIC CO.,LTD.

4. Endurance Specifications :

- 4-1. Operating Life : After 10 millions pushing , the switch must be satisfied with electrical and mechanical specifications shown on item 2&3.
- 4-2. Operating Temperature Range : $-5^{\circ}\text{C} \sim +50^{\circ}\text{C}$
- 4-3. Storage Temperature Range : $-20^{\circ}\text{C} \sim +65^{\circ}\text{C}$ (1000H)
- 4-4. Shock Proof : 20G in 3 Axis

5. Test Condition :

5-1. Measuring Conditions :

Measuring conditions :

Measuring conditions must be at temperature $23 \pm 1^{\circ}\text{C}$ humidity $50 \pm 2\% \text{RH}$.

However the measurement may be conducted under condition of normal temperature ($15 \sim 35^{\circ}\text{C}$) and normal humidity ($45 \sim 75\% \text{RH}$) unless such conditions affect test results.

5-2. Contact Bounce :

Test shall be made by normal pushing at a speed of 3~5 times per second with D.C 3V, $50 \mu \text{A}$ resistance load. Contact bounce range will be measured at 80% level as shown below.

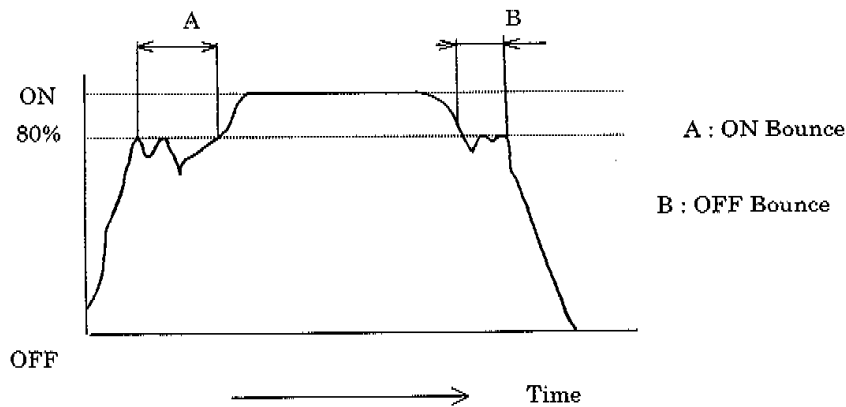



Fig.1.

0214 

MITSUMI ELECTRIC CO.,LTD.

5-3. Contact Resistance :

Contact resistance included resistance value of membrane circuit board shall be measured at D.C.24V , 0.1mA (voltage drop method) , applying static load of the keytop.

5-4. Insulation Resistance :

Measure , applying D.C.250V between the terminals.

5-5. Withstand Voltage :

After A.C.250V is applied between the terminals for 1 minute , any change and damage will not be appeared.

5-6. Force :

(1) Operating force :

Measure the operating force when switch makes contact by pushing the center of the keytop.

(2) Maximum Force :

Measure the maximum Force among the full travel except the full travel force.

(3) Minimum Force :

Measure the minimum Force among the travel after the maximum force.

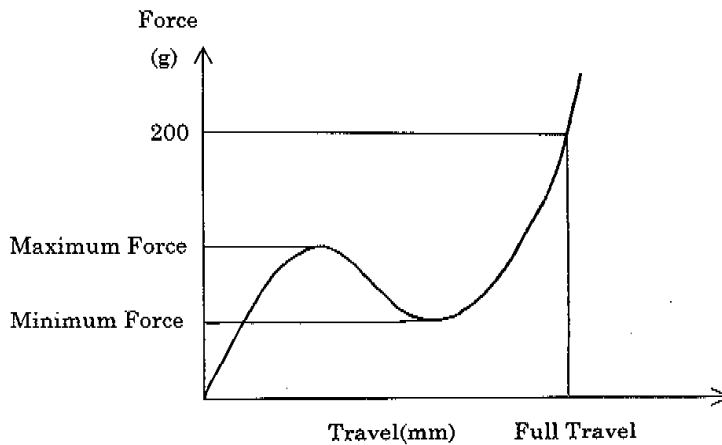



Fig.2.

0214 

MITSUMI ELECTRIC CO.,LTD.

5-7. Operating Point :

Measure the distance when switch makes contact by pushing the center of the keytop.

5-8. Full Travel :

Measure the distance when static load of 200g is to be applied onto the center of the keytop.

5-9. Key touch feeling :

Keytop must be operated , without squeaking , catching , locking with normal pushing of full travel at a speed of 3~5 times per second.

5-10. Operating Life :

As illustrated in Fig.3 , operating life test shall be made at a speed of 3~7 meter per second pushing the center of the keytop with a plunger of cam life tester.

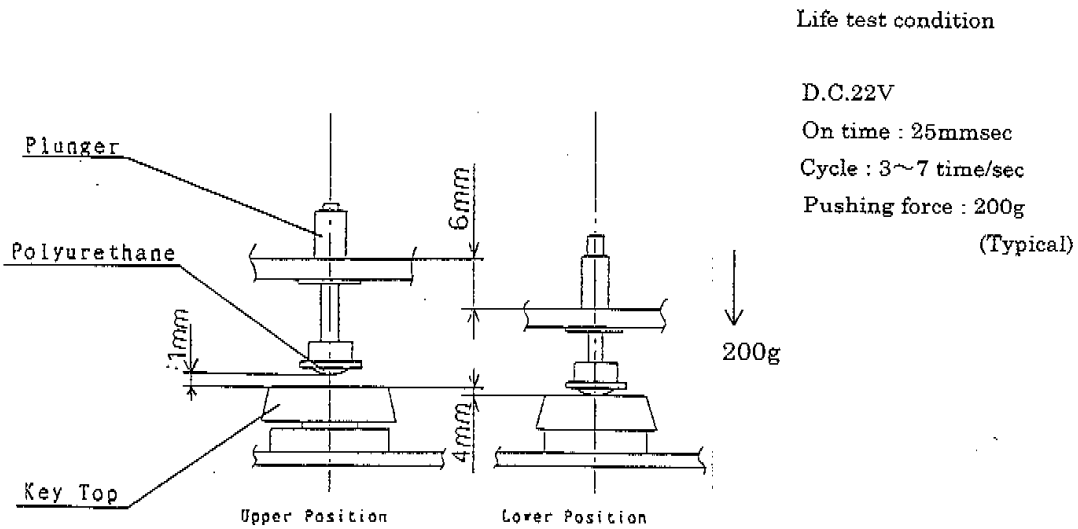



Fig.3.

0214 

MITSUMI ELECTRIC CO.,LTD.

6. Test Form :

6-1. Humidity Test :

After unit is kept for 96 hours in a chamber of temperature $+40\pm 2^{\circ}\text{C}$, and relative humidity 90~95% and then is left in ambient condition for 1 hour , electrical & mechanical specifications item 2&3 shall be satisfied.

6-2. Low Temperature Test :

After unit is kept for 96 hours in a chamber of temperature $-20\pm 2^{\circ}\text{C}$, then is left in ambient condition for 1 hour , electrical & mechanical specifications item 2&3 shall be satisfied.

6-3. High Temperature Test :

After unit is kept for 96 hours in a chamber of temperature $+70\pm 2^{\circ}\text{C}$, then is left in ambient condition for 1 hour , electrical & mechanical specifications item 2&3 shall be satisfied.

6-4. Thermal Shock Test :

After unit is kept for 5 cycles (one cycle consists of $-20\pm 2^{\circ}\text{C}$, 1 hour and $+60\pm 2^{\circ}\text{C}$, 1 hour) and then is left in ambient condition for 1 hour , electrical & mechanical specifications item 2&3 shall be satisfied.

6-5. Vibration Proof Test :

Unit shall satisfy electrical & mechanical specifications item 2&3 after the following vibration is applied.

Frepency : 10~55 Hz (cycle : 1 minute)
Full amplitude : 1.5mm
Duration : 2 hours each in 3 directions

6-6. Shock Proof Test :

After 20 G (half-sine wave) is applied to unit 3 times each in 3 directions , electrical & mechanical specifications item 2&3 shall be satisfied.

cf) The test (6-1~6-6) must be done under the open-circuit condition.

0214 

MITSUMI ELECTRIC CO.,LTD.

7. Appearance of keytop :

7-1. Disposition of keytop :

Disposition of the keytop shall be within the limit of 0.5mm as illustrated in Fig.4 in both vertical and horizontal lines.

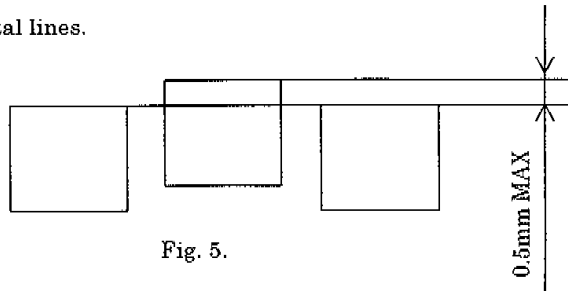

Fig. 5.

7-2. Tilt of keytop :

Tilt of keytop shall be within the limit of 0.5mm as illustrated in Fig.5.

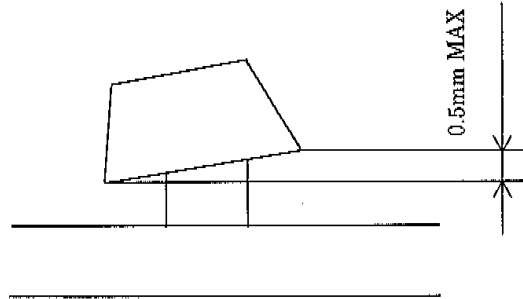

Fig. 6.

7-3. Angular deviation of keytop

Angular deviation of keytop shall be within the limit of 0.5mm as illustrated in Fig 6.

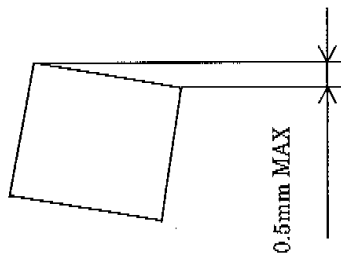



Fig. 7.

0214 

MITSUMI ELECTRIC CO.,LTD.

7-4. Uneven level of keytop :

Uneven level of keytop shall be within the limit of 0.5mm as illustrated in Fig.7.

However , exclude the bend of the frame.

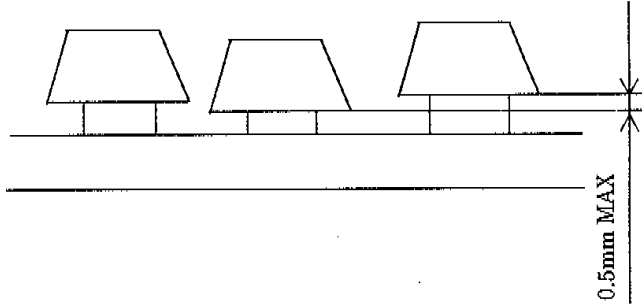

0214 

MITSUMI ELECTRIC CO.,LTD.