

# SAR Test Report

Product Name : GSM/WCDMA MOBILE PHONE  
Model No. : M4TEL SS880  
FCC ID : CLNSS880

Prepared By: : Inventec Appliances(Pudong) Corporation  
Address: : No.789 Pu Xing Road,Shanghai,PRC  
Date of Receipt : 2012.08.13  
Date of Test : 2012.08.19-2012.08.22  
Report No. : 20120813SAR



## Test Report Certification

Date of Issue : Aug.24.2012

Report No. : 20120813SAR

Product Name : GSM/WCDMA MOBILE PHONE  
Model No. : M4TEL SS880  
Trade Name : M4TEL  
Applicant : MFOURTEL MEXICO S.A. DE C.V.  
Address : Montecito 38, Piso 23, Oficina 15. Colonia Nápoles. C.P.  
03810 Mexico  
Standard : FCC 47 CFR Part2 (2.1093)  
IEEE C95.1-1999  
IEEE 1528-2003  
FCC OET Bulletin 65 supplement C  
FCC KDB 648474 D01 v01r05  
FCC KDB 941225 D01 v02  
FCC KDB 941225 D03 v01  
FCC KDB 941225 D04 v01  
FCC KDB 941225 D06 v01  
FCC KDB 248227 D01 v01r02  
Test Result : Head :1.268W/kg(1g) ; 0.719W/kg(10g)  
Body:1.361W/kg(1g); 0.757W/kg(10g)

The Test Results relate only to the samples tested.

The test report shall not be reproduced except in full without the written approval of Inventec Appliances(Pudong) Corporation

Documented By :  , Aug.24.2012  
Judy Ge/Engineer

Tested By :  , Aug.24.2012  
Alice Lee/Engineer

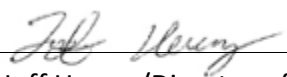
Approved By :  , Aug.24.2012  
Jeff Huang/Director of Operations

---

**TABLE OF CONTENTS**

Description	Page
<b>1. GENERAL INFORMATION.....</b>	<b>4</b>
1.1. APPLICANT.....	4
1.2. MANUFACTURER.....	4
1.3. TEST ENVIRONMENT.....	4
<b>2. SAR MEASUREMENT SYSTEM.....</b>	<b>5</b>
2.1. ALSAS-10U SYSTEM DESCRIPTION.....	5
2.2. ISOTROPIC E-FIELD PROBE.....	7
2.3. BOUNDARY DETECTION UNIT AND PROBE MOUNTING DEVICE.....	8
2.4. DAQ-PAQ (ANALOG TO DIGITAL ELECTRONICS).....	9
2.5. AXIS ARTICULATED ROBOT.....	9
2.6. ALSAS UNIVERSAL WORKSTATION.....	10
2.7. UNIVERSAL DEVICE POSITIONER.....	10
2.8. PHANTOM TYPES.....	11
<b>3. TISSUE SIMULATING LIQUID.....</b>	<b>12</b>
3.1. THE COMPOSITION OF THE TISSUE SIMULATING LIQUID.....	12
3.2. TISSUE CALIBRATION RESULT.....	13
3.3. TISSUE DIELECTRIC PARAMETERS FOR HEAD AND BODY PHANTOMS.....	15
<b>4. SAR MEASUREMENT PROCEDURE.....</b>	<b>16</b>
4.1. SAR SYSTEM VALIDATION.....	16
4.2. ARRANGEMENT ASSESSMENT SETUP.....	25
4.3. SAR MEASUREMENT PROCEDURE.....	28
<b>5. SAR EXPOSURE LIMITS.....</b>	<b>29</b>
<b>6. TEST EQUIPMENT LIST.....</b>	<b>30</b>
<b>7. MEASUREMENT UNCERTAINTY.....</b>	<b>31</b>
<b>8. SAR TEST RESULTS SUMMARY.....</b>	<b>33</b>
8.1. EXPOSURE POSITIONS CONSIDERATION.....	33
8.2. SIMULTANEOUS TRANSMITTING CONFIGURATIONS.....	34
8.3. CONDUCTED POWER(UNIT:DBM).....	35
8.4. TEST RECORDS FOR HEAD SAR TEST.....	37
8.5. TEST RECORDS FOR BODY-WORN / HOTSPOT SAR TEST.....	40
8.6. TEST RECORDS FOR BODY-WORN SAR TEST.....	43
8.7. SIMULTANEOUS MULTI-BAND TRANSMISSION.....	46
8.8. SAR MEASUREMENT DATA.....	48

**1. GENERAL INFORMATION****1.1. Applicant**

Company Name: MFOURTEL MEXICO S.A. DE C.V.

Address: Montecito 38, Piso 23, Oficina 15. Colonia Nápoles. C.P. 03810 Mexico

**1.2. Manufacturer**

Company Name: CK Telecom Limited

Address: Technology Road.High-Tech Development Zone. Heyuan, Guangdong,P.R.China.

**1.3. Test Environment**

Ambient conditions in the laboratory:

Items	Required	Actural
Temperature(°C)	15~30	21.4
Humidity(%RH)	30~70	46

## 2. SAR Measurement System

### 2.1. ALSAS-10U System Description

ALSAS-10-U is fully compliant with the technical and scientific requirements of IEEE 1528, IEC 62209, CENELEC, ARIB, ACA, and the Federal Communications Commission. The system comprises of a six axes articulated robot which utilizes a dedicated controller.

ALSAS-10U uses the latest methodologies and FDTD order to provide a platform which is repeatable with minimum uncertainty.

#### 2.1.1. Applications

Predefined measurement procedures compliant with the guidelines of CENELEC, IEEE, IEC, FCC, etc are utilized during the assessment for the device. Automatic detection for all SAR maxima are embedded within the core architecture for the system, ensuring that peak locations used for centering the zoom scan are within a 1mm resolution and a 0.05mm repeatable position. System operation range currently is available up to 6 GHz in simulated tissue.



### 2.1.2. Area Scans

Area Scans are defined prior to the measurement process being executed with a user defined variable spacing between each measurement point (integral) allowing low uncertainty measurements to be conducted. Scans defined for FCC applications utilize a 10mm<sup>2</sup> step integral, with 1mm interpolation used to locate the peak SAR area used for zoom scan assessments.

Where the system identifies multiple SAR peaks (which are within 25% of peak value) the system will provide the user with the option of assessing each peak location individually for zoom scan averaging.

### 2.1.3. Zoom Scan (Cube Scan Averaging)

The averaging zoom scan volume utilized in the ALSAS-10U software is in the shape of a cube and the side dimension of a 1g or 10g mass is dependent on the density of the liquid representing the simulated tissue. A density of 1000Kg/m<sup>3</sup> is used to represent the head and body tissue density and not the phantom liquid density, in order to be consistent with the definition of the liquid dielectric properties, i.e. the side length of the 1g cube is 10mm, with the side length of the 10g cube 21.5mm.

When the cube intersects with the surFront of the phantom, it is oriented so that 3 vertices touch the surFront of the shell or the center of a Front is tangent to the surFront.

The zoom Scan integer steps can be user defined so as to reduce uncertainty, but normal practice for typical test applications (including FCC) utilize a physical step of 5×5×8 (8mm×8mm×5mm) providing a volume of 32mm in the X & Y axis, and 35mm in the Z axis.

### 2.1.4. ALSAS-10U Interpolation and Extrapolation Uncertainty

The overall uncertainty for the methodology and algorithms the used during the SAR calculation was evaluated using the data from IEEE 1528 based on the example f3 algorithm:

$$f_3(x, y, z) = A \frac{a^2}{\frac{a^2}{4} + x'^2 + y'^2} \cdot \left( e^{-\frac{2z}{a}} + \frac{a^2}{2(a + 2z)^2} \right)$$

## 2.2. Isotropic E-Field Probe

The isotropic E-Field probe has been fully calibrated and assessed for isotropic, and boundary effect within a controlled environment. Depending on the frequency for which the probe is calibrated the method utilized for calibration will change. A number of methods is used for calibrating probes, and these are outlined in the table below:

Calibration Frequency	Air Calibration	Tissue Calibration
900MHz	TEM Cell	Temperature
1800MHz	TEM Cell	Temperature

The E-Field probe utilizes a triangular sensor arrangement as detailed in the diagram below:

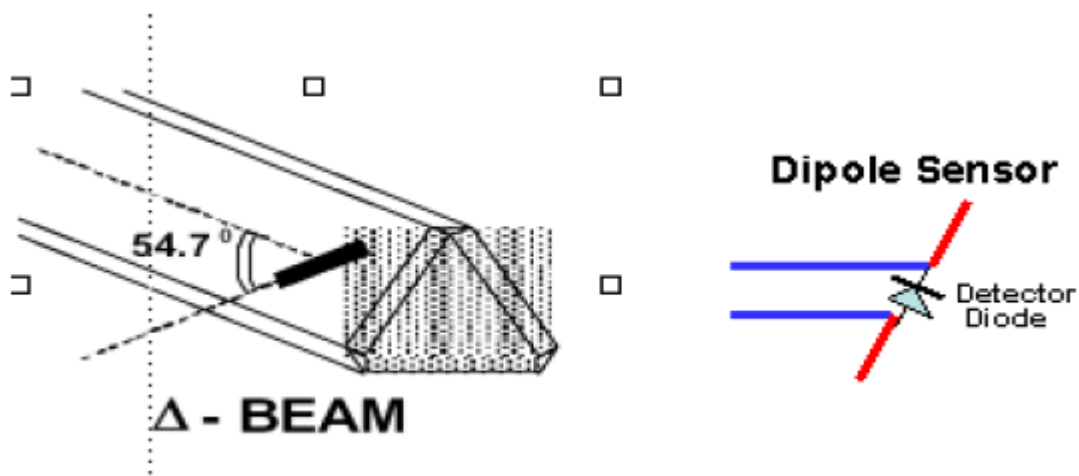

SAR is assessed with a calibrated probe which moves at a default height of 5mm from the center of the diode, which is mounted to the sensor, to the phantom surFront (in the Z Axis). The 5mm offset height has been selected so as to minimize any resultant boundary effect due to the probe being in close proximity to the phantom surFront.

The following algorithm is an example of the function used by the system for linearization of the output from the probe when measuring complex modulation schemes.

$$V_i = U_i + U_i^2 \cdot \frac{cf}{dcp_i}$$

### 2.2.1. Isotropic E-Field Probe Specification

<b>Calibration in Air</b>	Frequency Dependent Below 2GHz Calibration in air performed in a TEM Cell Above 2GHz Calibration in air performed in waveguide
<b>Sensitivity</b>	0.70 $\mu\text{V}/(\text{V/m})^2$ to 0.85 $\mu\text{V}/(\text{V/m})^2$
<b>Dynamic Range</b>	0.0005 W/kg to 100W/kg
<b>Isotropic Response</b>	Better than 0.2dB
<b>Diode Compression point (DCP)</b>	Calibration for Specific Frequency
<b>Probe Tip Radius</b>	< 5mm
<b>Sensor Offset</b>	1.56 (+/- 0.02mm)
<b>Probe Length</b>	290mm
<b>Video Bandwidth</b>	@ 500 Hz: 1dB @1.02 KHz: 3dB
<b>Boundary Effect</b>	Less than 2% for distance greater than 2.4mm
<b>Spatial Resolution</b>	Diameter less than 5mm Compliant with Standards

Probe model no: ALS-E-020, S/N:500-00273

### 2.3. Boundary detection Unit and Probe Mounting Device

ALSAS-10U incorporates a boundary detection unit with a sensitivity of 0.05mm for detecting all types of surFronts. The robust design allows for detecting during probe tilt (probe normalize) exercises, and utilizes a second stage emergency sTop. The signal electronics are directly into the robot controller for high accuracy surFront detection in lateral and axial detection modes (X, Y, &Z).

The probe is mounted directly onto the Boundary Detection unit for accurate tooling and displacement calculations controlled by the robot kinematics. The probe is connected to an isolated probe interconnect where the output stage of the probe is fed directly into the amplifier stage of the Daq-Paq.



## 2.4. Daq-Paq (Analog to Digital Electronics)

ALSAS-10U incorporates a fully calibrated Daq-Paq (analog to digital conversion system) which has a 4 channel input stage, sent via a 2 stage auto-set amplifier module. The input signal is amplified accordingly so as to offer a dynamic range from  $5 \mu\text{V}$  to 800mV. Integration of the fields measured is carried out at board level utilizing a Co-Processor which then sends the measured fields down into the main computational module in digitized form via a RS232 communications port. Probe linearity and duty cycle compensation is carried out within the main Daq-Paq module.

<b>ADC</b>	12 Bit
Amplifier Range	20mV to 200mV and 150mV to 800mV
Field Integration	Local Co-Processor utilizing proprietary integration algorithms
Number of Input Channels	4 in total 3 dedicated and 1 spare
Communication	Packet data via RS232

## 2.5. Axis Articulated Robot

ALSAS-10U utilizes a six articulated robot, which is controlled using a Pentium based real-time movement controller. The movement kinematics engine utilizes proprietary (Thermo CRS) interpolation and extrapolation algorithms, which allow full freedom of movement for each of the six joints within the working envelop. Utilization of joint 6 allows for full probe rotation with a tolerance better than 0.05mm around the central axis.



<b>Robot/Controller Manufacturer</b>	Thermo CRS
<b>Number of Axis</b>	Six independently controlled axis
<b>Positioning Repeatability</b>	0.05mm
<b>Controller Type</b>	Single phase Pentium based C500C
<b>Robot Reach</b>	710mm
<b>Communication</b>	RS232 and LAN compatible

## 2.6. ALSAS Universal Workstation

ALSAS Universal workstation allows for repeatability and fast adaptability. It allows users to do calibration, testing and measurement using different types of phantoms with one set up, which significantly speeds up the measurement process.

## 2.7. Universal Device Positioner

The universal device positioner allows complete freedom of movement of the EUT. Developed to hold a EUT in a free-space scenario any additional loading attributable to the material used in the construction of the positioner has been eliminated. Repeatability has been enhanced through the linear scales which form the design used to indicate positioning for any given test scenario in all major axes. A 15° tilt movements for head SAR analysis. Overall uncertainty for measurements has been reduced due to the design of the Universal device positioner, which allows positioning of a device in as near to a free-space scenario as possible, and by providing the means for complete repeatability.



## 2.8. Phantom Types

The ALSAS-10U allows the integration of multiple phantom types. SAM Phantoms fully compliant with IEEE 1528, Universal Phantom, and Universal Flat.

### 2.8.1. APREL SAM Phantoms

The SAM phantoms developed using the IEEE SAM CAD file. They are fully compliant with the requirements for both IEEE 1528 and FCC Supplement C. Both the left and right SAM phantoms are interchangeable, transparent and include the IEEE 1528 grid with visible NF and MB lines.

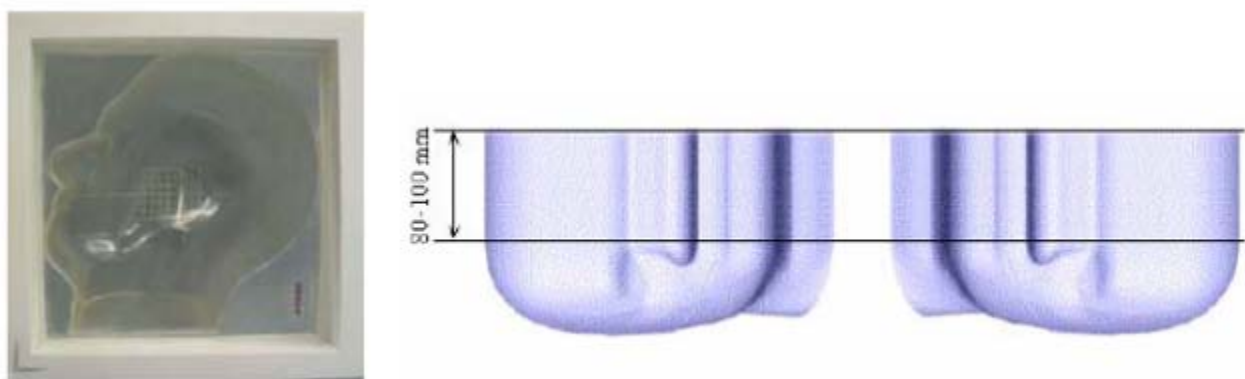

### 2.8.2. APREL Laboratories Universal Phantom

The Universal Phantom is used on the ALSAS-10U as a system validation phantom. The Universal Phantom has been fully validated both experimentally from 800MHz to 6GHz and numerically using XFDTD numerical software. The shell thickness is 2mm overall, with a 4mm spacer located at the NF/MB intersection providing an overall thickness of 6mm in line with the requirements of IEEE-1528.



The design allows for fast and accurate measurements, of handsets, by allowing the conservative SAR to be evaluated at on frequency for both left and right head experiments in one measurement.

### 3. Tissue Simulating Liquid

#### 3.1. The composition of the tissue simulating liquid

INGREDIENT (% Weight)	850MHz	1900MHZ	850MHZ	1900MHz	2450MHz	2450MHz
	Head	Head	Body	Body	Head	Body
Water	40.45%	54.9%	45.0%	70.17%	55%	73.2%
Salt	1.45%	0.18%	52.4%	0.39%	0%	0%
Sugar	57.6%	0%	1.4%	0%	0%	0%
HEC	0.4%	0%	1.0%	0%	0%	0%
Preventol	0.1%	0%	0.1%	0%	0%	0%
DGBE	0%	44.92%	0%	29.44%	45%	26.76%

### 3.2. Tissue Calibration Result

The dielectric parameters of the liquids were verified prior to SAR evaluation using APREL Dielectric Probe Kit and Agilent E5071B Vector Network Analyzer.

Head Tissue Simulate Measurement				
Frequency (MHz)	Description	Dielectric Parameters		Tissue Temp.(°C)
		$\epsilon_r$	$\sigma$ (s/m)	
850MHz	Reference result	41.5	0.90	NA
	+/-5% window	39.425to43.575	0.855to0.945	
	20-Aug-12	40.24	0.91	20.7
1900MHz	Reference result	40.0	1.40	NA
	+/-5% window	38to42	1.33 to 1.47	
	20-Aug-12	41.54	1.43	20.7
2450MHz	Reference result	39.2	1.80	NA
	+/-5% window	37.24to41.16	1.71to1.89	
	20-Aug-12	40.31	1.81	20.7

Body Tissue Simulate Measurement				
Frequency (MHz)	Description	Dielectric Parameters		Tissue Temp.(°C)
		$\epsilon_r$	$\sigma$ (s/m)	
850MHz	Reference result	55.2	0.97	NA
	+/-5% window	52.44to57.96	0.922to1.019	
	20-Aug-12	53.31	0.94	20.7
1900MHz	Reference result	53.3	1.51	NA
	+/-5% window	50.635to55.965	1.444to1.596	
	20-Aug-12	52.92	1.52	20.7
2450MHz	Reference result	52.7	1.95	NA
	+/-5% window	50.065to55.335	1.852to2.0475	
	20-Aug-12	53.43	1.94	20.7

### 3.3. Tissue Dielectric Parameters for Head and Body Phantoms

The head tissue dielectric parameters recommended by the IEEE SCC-34/SC-2 in PP1528 have been incorporated in the following table. These head parameters are derived from planar layer models simulating the highest expected SAR for the dielectric properties and tissue thickness variations in a human head. Other head and body tissue parameters that have not been specified in P1428 are derived from the tissue dielectric parameters computed from the 4-Cole-Cole equations described in Reference [12] and extrapolated according to the head parameters specified in P1528.

Target Frequency (MHz)	Head		Body	
	$\epsilon_r$	$\sigma$ (S/m)	$\epsilon_r$	$\sigma$ (S/m)
150	52.3	0.76	61.9	0.80
300	45.3	0.87	58.2	0.92
450	43.5	0.87	56.7	0.94
835	41.5	0.90	55.2	0.97
900	41.5	0.97	55.0	1.05
915	41.5	0.98	55.0	1.06
1450	40.5	1.20	54.0	1.30
1610	40.3	1.29	53.8	1.40
1800 – 2000	40.0	1.40	53.3	1.52
2450	39.2	1.80	52.7	1.95
3000	38.5	2.40	52.0	2.73
5800	35.3	5.27	48.2	6.00

( $\epsilon_r$  = relative permittivity,  $\sigma$  = conductivity and  $\rho = 1000 \text{ Kg/m}^3$ )

## 4. SAR Measurement Procedure

### 4.1. SAR System Validation

#### 4.1.1. Validation Dipoles

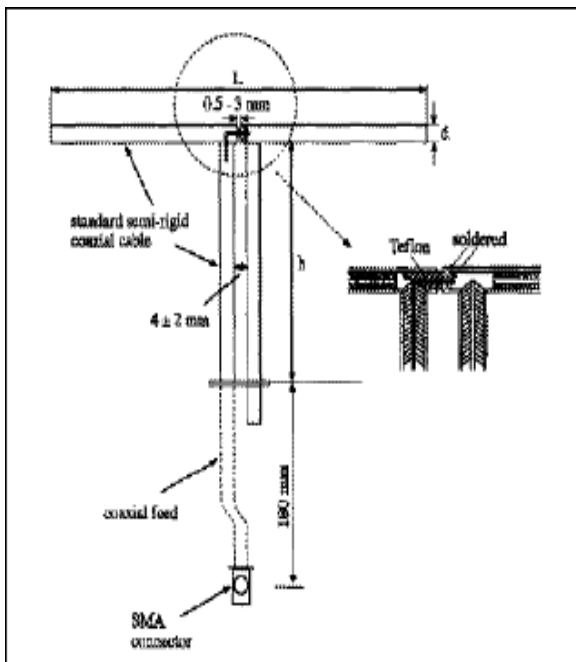

The dipoles used are based on the IEEE-1528 standard, and is complied with mechanical and electrical specifications in line with the requirements of both IEEE and FCC Supplement C. The table below provides details for the mechanical and electrical specifications for the dipoles.

Frequency	L(mm)	h(mm)	d(mm)
850MHz	161	89.8	3.6
1900MHz	67.1	38.9	3.6
2450MHz	51.5	30.4	3.6



## 4.1.2. Validation Result

Head System Performance Check at 850MHz&1900MHz&2450MHz				
Validation Kit: ASL-D-850-S-2				
Frequency(MHz)	Description	SAR(W/Kg) 1g	SAR(W/Kg) 10g	Tissue Temp.(°C)
850MHz	Reference result	9.590	6.003	N/A
	+/-5%window	9.110to10.07	5.702to6.303	
	20-Aug-12(1W)	9.458	5.861	20.7
Validation Kit: ASL-D-1900-S-2				
Frequency(MHz)	Description	SAR(W/Kg) 1g	SAR(W/Kg) 10g	Tissue Temp.(°C)
1900MHz	Reference result	39.378	19.668	N/A
	+/-5%window	37.418to41.356	18.685to20.651	
	20-Aug-12(1W)	38.649	19.232	20.7
Validation Kit: ASL-D-2450-S-2				
Frequency(MHz)	Description	SAR(W/Kg) 1g	SAR(W/Kg) 10g	Tissue Temp.(°C)
24500MHz	Reference result	52.456	23.603	N/A
	+/-5%window	49.833to55.078	22.423to24.783	
	20-Aug-12(1W)	51.879	22.738	20.7
Note: All SAR values are normalized to 1 W forward power.				

Body System Performance Check at 850MHz&1900MHz&2450MHz				
Validation Kit: ASL-D-850-S-2				
Frequency(MHz)	Description	SAR(W/Kg) 1g	SAR(W/Kg) 10g	Tissue Temp.(°C)
850MHz	Reference result	9.981	6.006	N/A
	+/-5%window	9.482to10.48	5.706to6.306	
	20-Aug-12(1W)	9.523	5.865	20.7
Validation Kit: ASL-D-1900-S-2				
Frequency(MHz)	Description	SAR(W/Kg) 1g	SAR(W/Kg) 10g	Tissue Temp.(°C)
1900MHz	Reference result	39.654	19.668	N/A
	+/-5%window	37.671to41.637	18.685to20.651	
	20-Aug-12(1W)	39.621	19.738	20.7
Validation Kit: ASL-D-2450-S-2				
Frequency(MHz)	Description	SAR(W/Kg) 1g	SAR(W/Kg) 10g	Tissue Temp.(°C)
2450MHz	Reference result	52.592	24.461	N/A
	+/-5%window	49.962to55.222	23.238to25.684	
	20-Aug-12(1W)	51.281	24.332	20.7
Note: All SAR values are normalized to 1W forward power.				

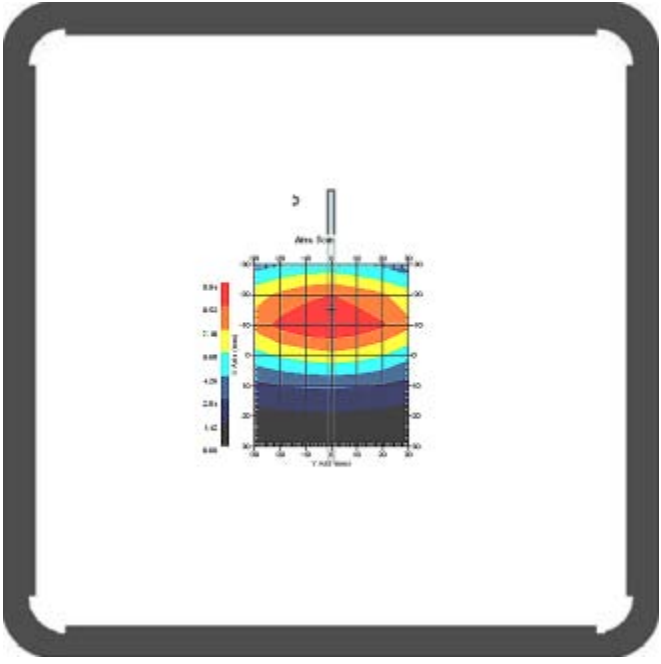
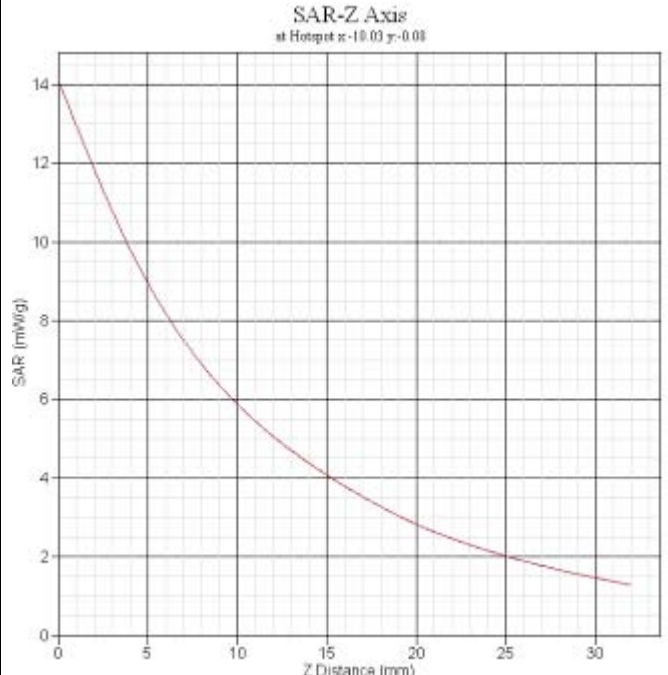
Frequency(MHz)	850
Relative permittivity(real part)	40.24
Conductivity(S/m)	0.91
Variation(%)	0.568
Duty Cycle Factor	1
Crest factor	1
Conversion Fator	6.5
Probe Sensitivity	1.20 1.20 1.20 $\mu V/(V/m)^2$
Data	2012-08-20
	
SAR 1g(W/Kg)	9.458
SAR 10g(W/Kg)	5.861

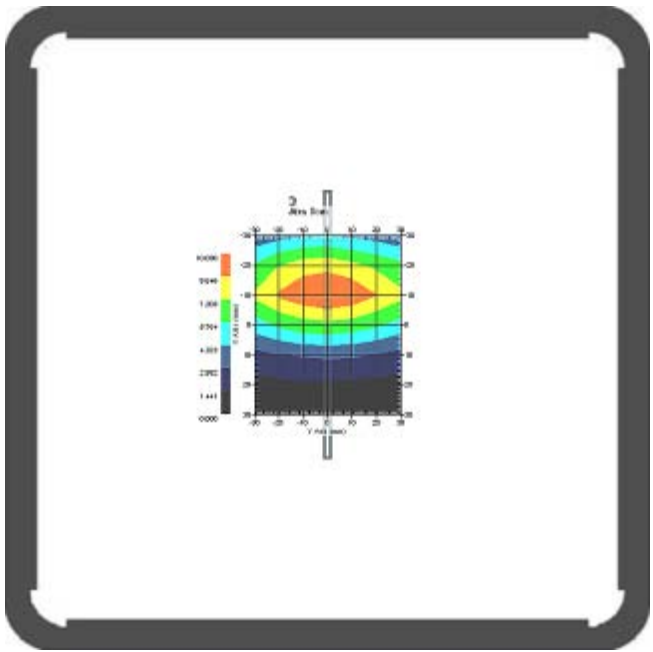
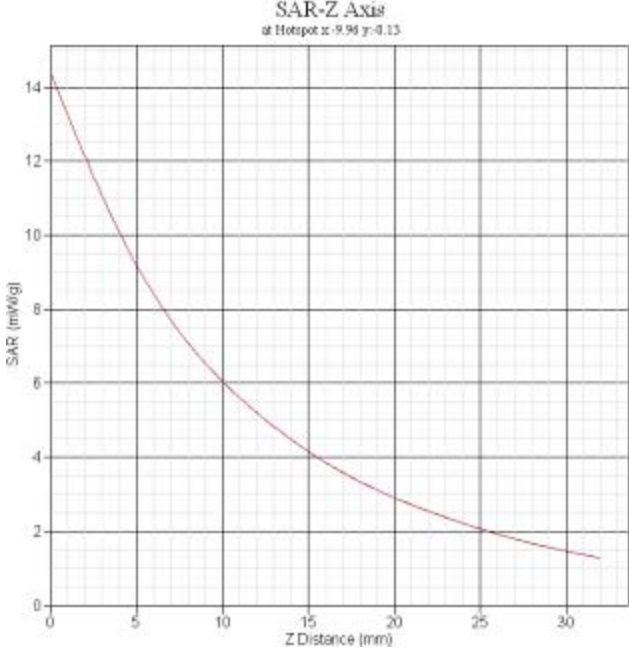
Frequency(MHz)	850
Relative permittivity(real part)	53.31
Conductivity(S/m)	0.94
Variation(%)	0.234
Duty Cycle Factor	1
Crest factor	1
Conversion Fator	6.4
Probe Sensitivity	1.20 1.20 1.20 $\mu V/(V/m)^2$
Data	2012-08-20
	
SAR 1g(W/Kg)	9.523
SAR 10g(W/Kg)	5.865

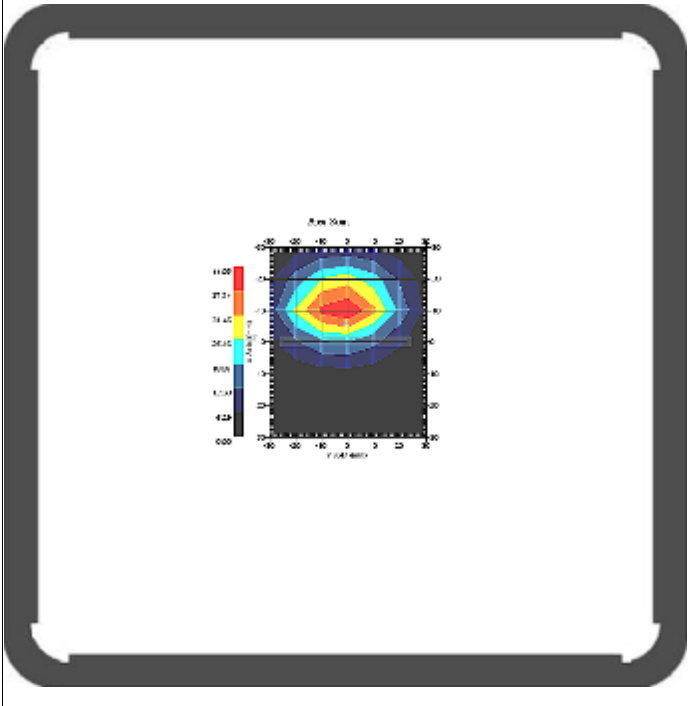
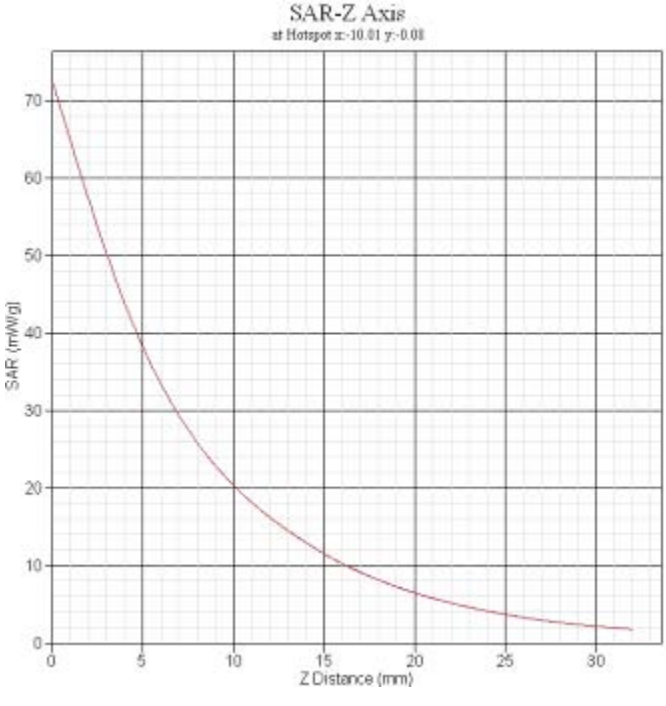
Frequency(MHz)	1900
Relative permittivity(real part)	41.54
Conductivity(S/m)	1.43
Variation(%)	1.456
Duty Cycle Factor	1
Crest factor	1
Conversion Fator	5.7
Probe Sensitivity	1.20 1.20 1.20 $\mu V/(V/m)^2$
Data	2012-08-20
	
SAR 1g(W/Kg)	38.649
SAR 10g(W/Kg)	19.232

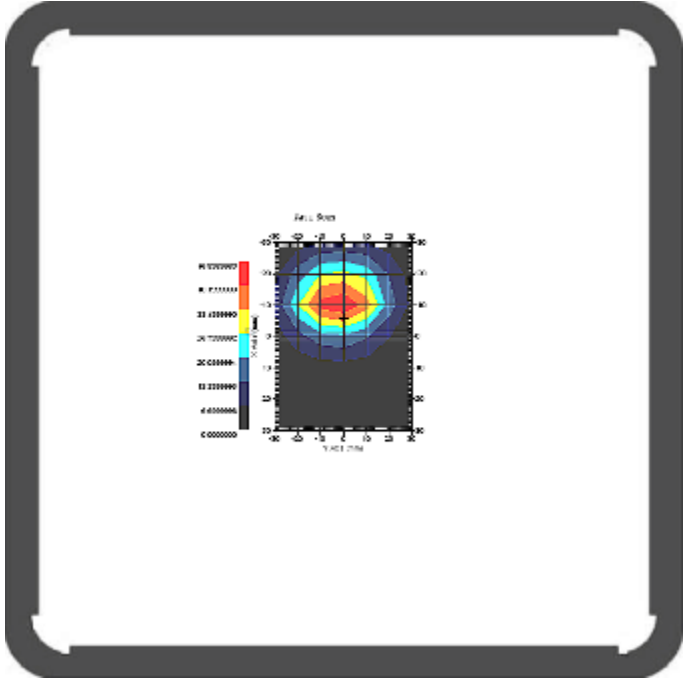
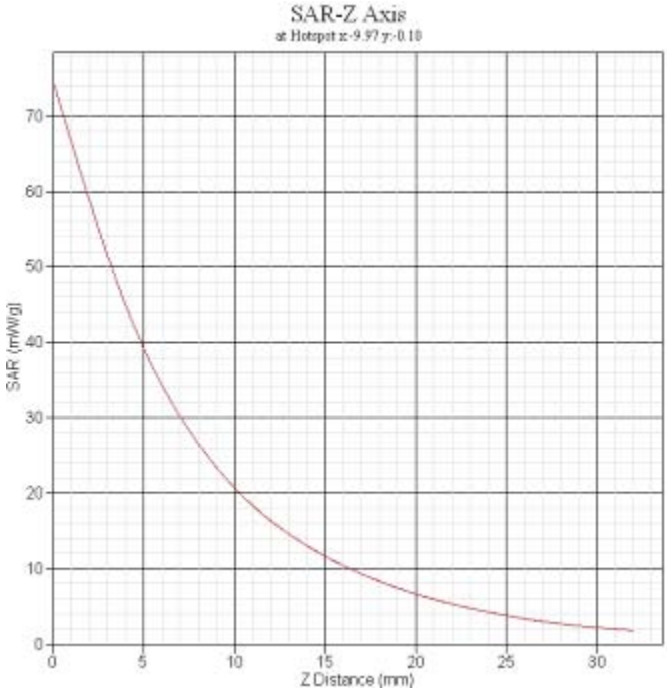
Frequency(MHz)	1900
Relative permittivity(real part)	52.92
Conductivity(S/m)	1.51
Variation(%)	-1.456
Duty Cycle Factor	1
Crest factor	1
Conversion Fator	5.4
Probe Sensitivity	1.20 1.20 1.20 $\mu V/(V/m)^2$
Data	2012-08-20
	
SAR 1g(W/Kg)	39.621
SAR 10g(W/Kg)	19.738

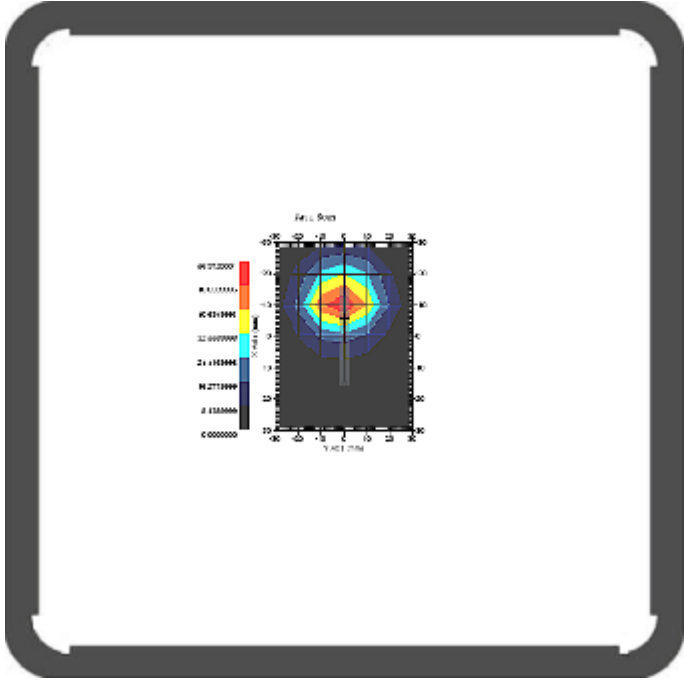
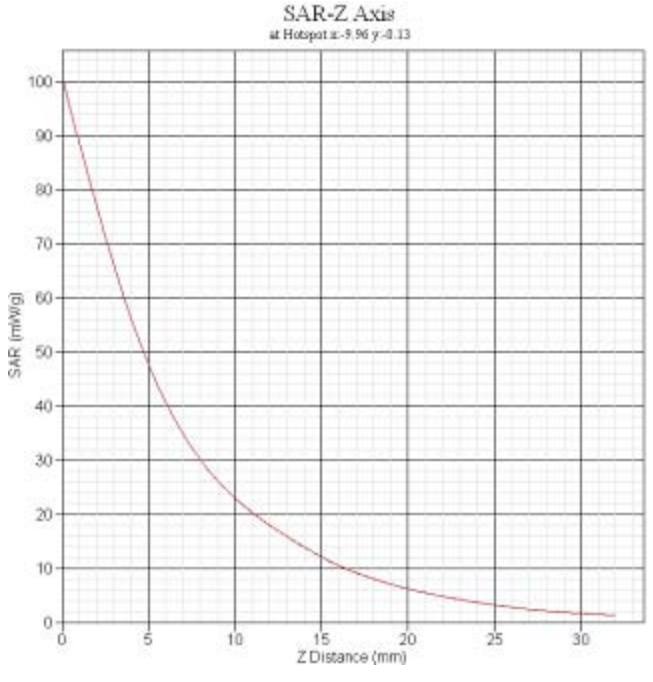
Frequency(MHz)	2450
Relative permittivity(real part)	40.31
Conductivity(S/m)	1.81
Variation(%)	-0.976
Duty Cycle Factor	1
Crest factor	1
Conversion Fator	4.65
Probe Sensitivity	1.20 1.20 1.20 $\mu V/(V/m)^2$
Data	2012-08-20
	
SAR 1g(W/Kg)	51.879
SAR 10g(W/Kg)	22.738

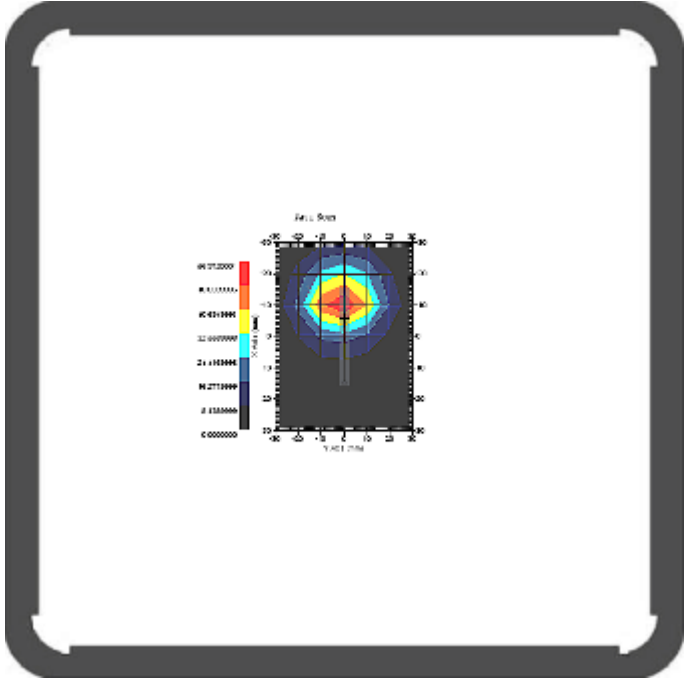
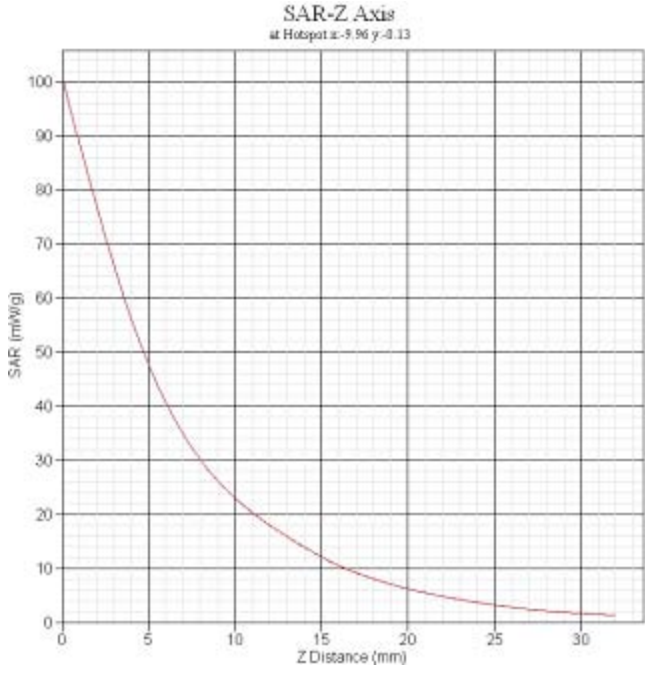
Frequency(MHz)	2450
Relative permittivity(real part)	53.43
Conductivity(S/m)	1.94
Variation(%)	0.692
Duty Cycle Factor	1
Crest factor	1
Conversion Fator	4.4
Probe Sensitivity	1.20 1.20 1.20 $\mu V/(V/m)^2$
Data	2012-08-20
	
SAR 1g(W/Kg)	51.281
SAR 10g(W/Kg)	24.332



## 4.2. Arrangement Assessment Setup

### 4.2.1. Test Positions of Device Relative to Head

This specifies exactly two test positions for the handset against the head phantom, the “cheek” position and the “tilted” position. The handset should be tested in both positions on the left and right sides of the SAM phantom. If the handset construction is such that it cannot be positioned using the handset positioning procedures described in 4.2.2.1 and 4.2.2.2 to represent normal use conditions (e.g. asymmetric handset), alternative alignment procedures should be considered with details provided in the test report.

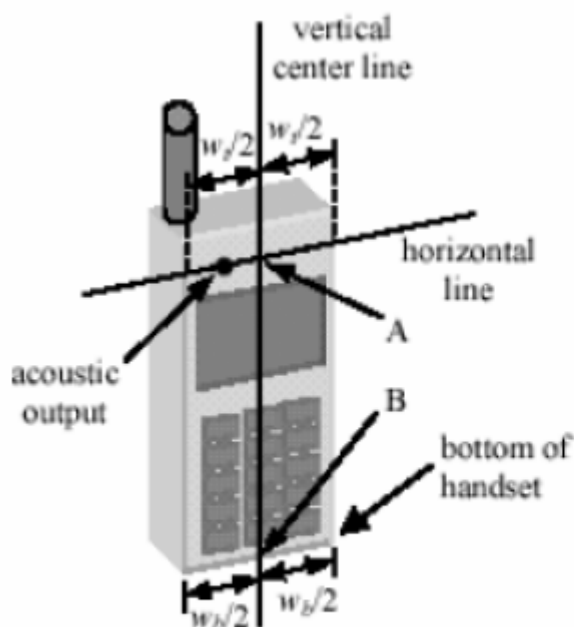

Figure 4.1a Internal Case

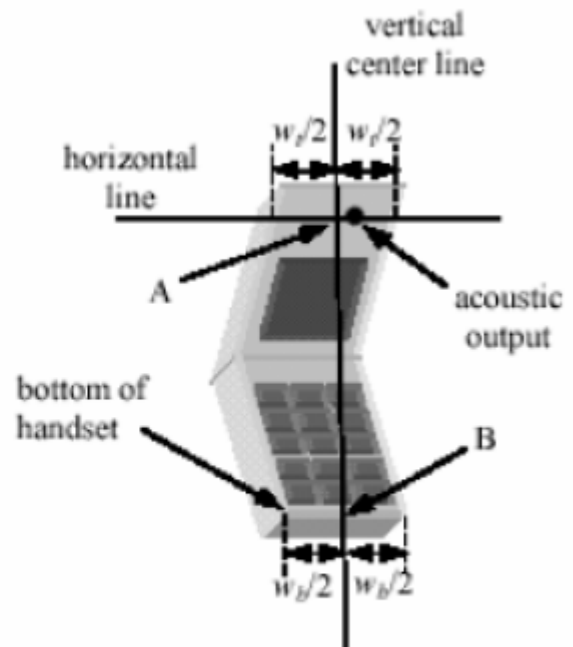

Figure 4.1b Clam Shell

#### 4.2.2.1. Definition of the “Cheek” Position

The “cheek” position is defined as follows:

- Ready the handset for talk operation, if necessary. For example, for hand sets with a cover piece, open the cover. (If the handset can also be used with the cover closed both configurations must be tested.)
- Define two imaginary lines on the handset: the vertical centerline and the horizontal line. The vertical centerline passes through two points on the front side of the handset: the midpoint of the width  $w_t$  of the handset at the level of the acoustic output (point A on Figures 4.1 a and 4.1 b), and the midpoint of the width  $w_b$  of the

- Back of the handset through the center of the acoustic output (see Figure 4.1 a). The two lines intersect at point A. Note that for many handsets, point A coincides with the center of the acoustic output. However, the acoustic output may be located elsewhere on the horizontal line. Also note that the vertical centerline is not necessarily parallel to the front of the handset (see Figure 4.1 b), especially for clamshell handsets, handsets with flip pieces, and other irregularly-shaped handsets.
- Position the handset close to the surFront of the phantom such that point A is on the (virtual) extension of the line passing through points RE and LE on the phantom (see 4.2), such that the plan defined by the vertical center line and the horizontal line of the handset is approximately parallel to the sagittal plane of the phantom.
  - Translate the handset towards the phantom along the line passing through RE and LE until the handset touches the pinna.
  - While maintaining the handset in this plane, rotate it around the LE-RE line until the vertical centerline is in the plane normal to MB-NF including the line MB (called the reference plane).
  - Rotate the handset around the vertical centerline until the handset (horizontal line) is symmetrical with respect to the line NF.

While maintaining the vertical centerline in the reference plane, keeping point A on the line passing through RE and LE and maintaining the handset contact with the pinna, rotate the handset about the line NF until any point on the handset is in contact with a phantom point below the pinna (cheek). See Figure 4.2 the physical angles of rotation should be noted.

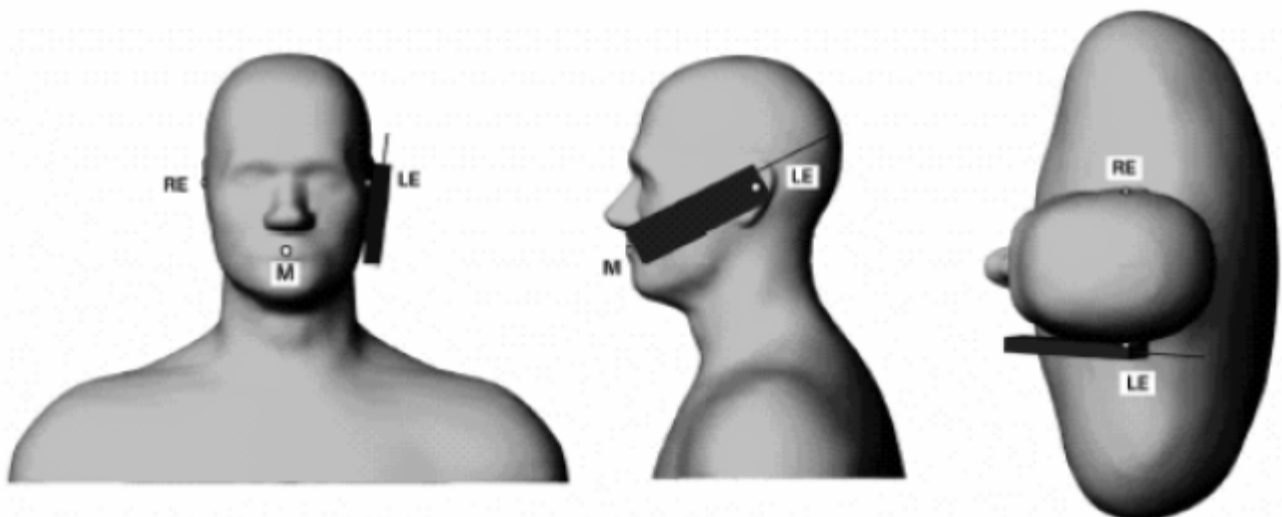

Figure 4.2 – Phone position 1, “cheek” or “touch” position.

#### 4.2.1.2 Definition of the “Tilted” Position

The “tilted” position is defined as follows:

- a. Repeat steps (a) – (g) of 4.2.1.1 to place the device in the “cheek position”.
- b. While maintaining the orientation of the handset move the handset away from the pinna along the line passing through RE and LE in order to enable a rotation of the handset by 15 degrees.
- c. Rotate the handset around the horizontal line by 15 degrees.
- d. While maintaining the orientation of the handset, move the handset towards the phantom on a line passing through RE and LE until any part of the handset touches the ear. The tilted position is obtained when the contact is on the pinna. If the contact is at any location other than the pinna (e.g. the antenna with the Back of the phantom head), the angle of the handset should be reduced. In this case, the tilted position is obtained if any part of the handset is in contact with the pinna as well as a second part of the handset is contact with the phantom (e.g. the antenna with Back of the head).

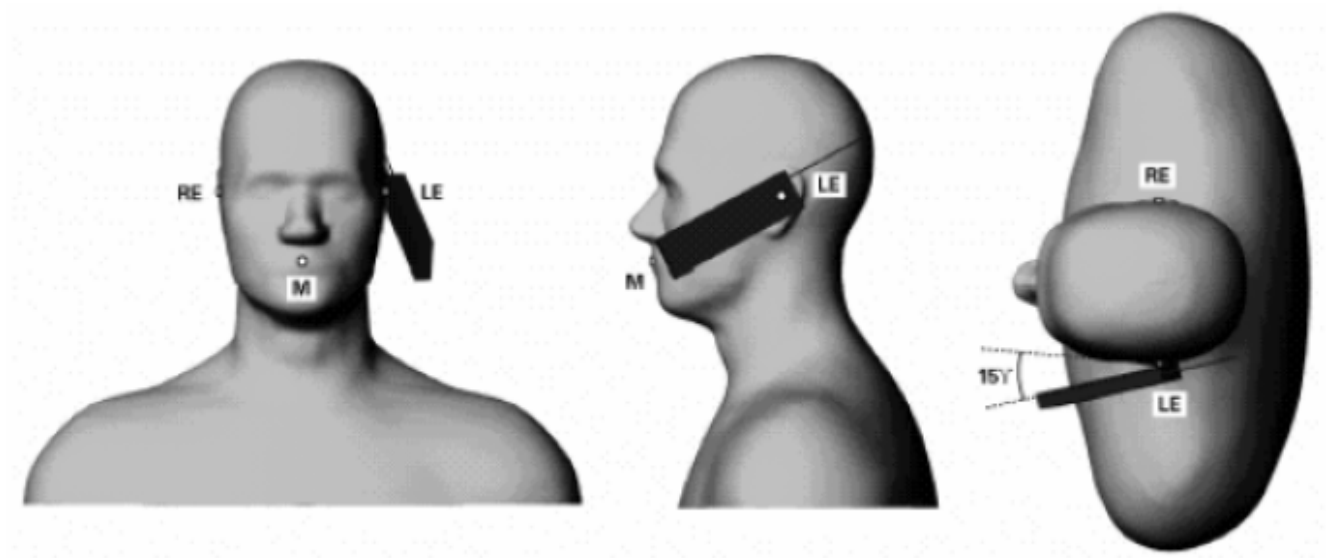

Figure 4.3 – Phone position 2, “tilted” position.

#### 4.2.2. Test Positions for body-worn

Body-worn operating configurations should be tested with the belt-clips and holsters attached to the device and positioned against a flat phantom in normal use configurations. A separation distance of 1.5 cm between the Back of the device and a flat phantom is recommended for testing body-worn SAR compliance under such circumstances. Other separation distance may be use, but not exceed 2.5cm.

#### 4.3. SAR Measurement Procedure

The ALSAS-10U calculates SAR using the following equation,

$$SAR = \frac{\sigma |E|^2}{\rho}$$

$\sigma$  :represents the simulated tissue conductivity

$\rho$  :represents the tissue density

The EUT is set to transmit at the required power in line with product specification, at each frequency relating to the LOW, MID, and HIGH channel settings.

Pre-scans are made on the device to establish the location for the transmitting antenna, using a large area scan in either air or tissue simulation fluid.

The EUT is placed against the Universal Phantom where the maximum area scan dimensions are large than the physical size of the resonating antenna. When the scan size is not large enough to cover the peak SAR distribution, it is modified by either extending the area scan size in both the X and Y directions, or the device is shifted within the predefined area.

The area scan is then run to establish the peak SAR location (interpolated resolution set at 1 mm<sup>2</sup>) which is then used to orient the center of the zoom scan. The zoom scan is then executed and the 1g and 10g averages are derived from the zoom scan volume (interpolated resolution set at 1 mm<sup>3</sup>).

## 5. SAR Exposure Limits

SAR assessments have been made in line with the requirements of IEEE C95.1-1999, IEEE 1528-2003 , FCC OET Bulletin 65 supplement C.

Type Exposure (W/kg)	Uncontrolled Environment Limit
Spatial Peak SAR (10g cube tissue for head and trunk)	1.60 W/kg
Spatial Average SAR (whole body)	0.08 W/kg
Spatial Peak SAR (10g for limb)	4.00 W/kg

## 6. Test Equipment List

Instrument	Manufacture	Model No.	Serial No.	Last Calibration
Universal Work Station	Apral	ALS-UWS	100-00154	NCR
Data Acquisition Package	Apral	ALS-DAQ-PAQ-3	110-00215	NCR
Probe Mounting Device and Boundary Detection Sensor System	Apral	ALS-PMDPS-3	120-00265	NCR
Miniature E-Field Probe	Apral	ALS-E-020	500-00282	Oct.01,2011
Left ear SAM Phantom	Apral	ALS-P-SAM-L	130-00312	NCR
Right ear SAM Phantom	Apral	ALS-P-SAM-R	140-00362	NCR
Universal SAM Phantom	Apral	ALS-P-SU-1	150-00410	NCR
Reference Validation Dipole 850MHz	Apral	ALS-D-850-S-2	180-00556	May.19,2011
Reference Validation Dipole 1900MHz	Apral	ALS-D-1900-S-2	210-00707	May.16,2011
Reference Validation Dipole 2450MHz	Apral	ALS-D-2450-S-2	220-00755	May.19,2011
Dielectric Probe Kit	Apral	ALS-PR-DIEL	260-00955	NCR
Device Holder 2.0	Apral	ALS-H-E-SET-2	170-00506	NCR
SAR software	Apral	ALS-SAR-AL-10	Ver.2.3.8	NCR
CRS C500C Controller	Thermo	ALS-C500	RCF0504291	NCR
CRS F3 Robot	Apral	ALS-F3-SW	N/A	NCR
Power Amplifier	Mini-Circuit	ZHL- 42	040306	Jul.15,2012
Directional Coupler	Agilent	778D-012	51011	Jul.15,2012
Universal Radio Communication Tester	Agilent	E5515C	104845	Mar.1,2012
Vector Network	Agilent	E5071B	MY4230146	Jul.19,2012
Signal Generator	Agilent	E8257D	N/A	Dec.05,2011
Power Meter	Rohde&Schwarz	NRP	N/A	Dec.05,2011

**Note:** All equipment upon which need to be calibrated are with calibration period of 1 year, except validation dipole antenna of every 3 years.

## 7. Measurement Uncertainty

### Exposure Assessment Measurement Uncertainty

Source of Uncertainty	Tolerance Value	Probability Distribution	Divisor	$c_i^1$ (1-g)	$c_i^1$ (10-g)	Standard Uncertainty (1-g) %	Standard Uncertainty (10-g) %
Measurement System							
Probe Calibration	3.5	normal	1	1	1	3.5	3.5
Axial Isotropy	3.7	rectangular	$\sqrt{3}$	$(1-cp)^{1/2}$	$(1-cp)^{1/2}$	1.5	1.5
Hemispherical Isotropy	10.9	rectangular	$\sqrt{3}$	$\sqrt{cp}$	$\sqrt{cp}$	4.4	4.4
Boundary Effect	1.0	rectangular	$\sqrt{3}$	1	1	0.6	0.6
Linearity	4.7	rectangular	$\sqrt{3}$	1	1	2.7	2.7
Detection Limit	1.0	rectangular	$\sqrt{3}$	1	1	0.6	0.6
Readout Electronics	1.0	normal	1	1	1	1.0	1.0
Response Time	0.8	rectangular	$\sqrt{3}$	1	1	0.5	0.5
Integration Time	1.7	rectangular	$\sqrt{3}$	1	1	1.0	1.0
RF Ambient Condition	3.0	rectangular	$\sqrt{3}$	1	1	1.7	1.7
Probe Positioner Mech.	0.4	rectangular	$\sqrt{3}$	1	1	0.2	0.2
Restriction							
Probe Positioning with respect to Phantom Shell	2.9	rectangular	$\sqrt{3}$	1	1	1.7	1.7
Extrapolation and Integration	3.7	rectangular	$\sqrt{3}$	1	1	2.1	2.1
Test Sample Positioning	4.0	normal	1	1	1	4.0	4.0
Device Holder Uncertainty	2.0	normal	1	1	1	2.0	2.0
Drift of Output Power	0.6	rectangular	$\sqrt{3}$	1	1	0.3	0.3
Phantom and Setup							
Phantom Uncertainty(shape & thickness tolerance)	3.4	rectangular	$\sqrt{3}$	1	1	2.0	2.0
Liquid Conductivity(target)	5.0	rectangular	$\sqrt{3}$	0.7	0.5	2.0	1.4

Liquid Conductivity(meas.)	0.0	normal	1	0.7	0.5	0.0	0.0
Liquid Permittivity(target)	5.0	rectangular	$\sqrt{3}$	0.6	0.5	1.7	1.4
Liquid Permittivity(meas.)	2.4	normal	1	0.6	0.5	1.4	1.2
Combined Uncertainty		RSS				9.3	9.2
Combined Uncertainty (coverage factor=2)		Normal(k=2)				18.7	18.3



## 8. SAR Test Results Summary

### 8.1. Exposure Positions Consideration

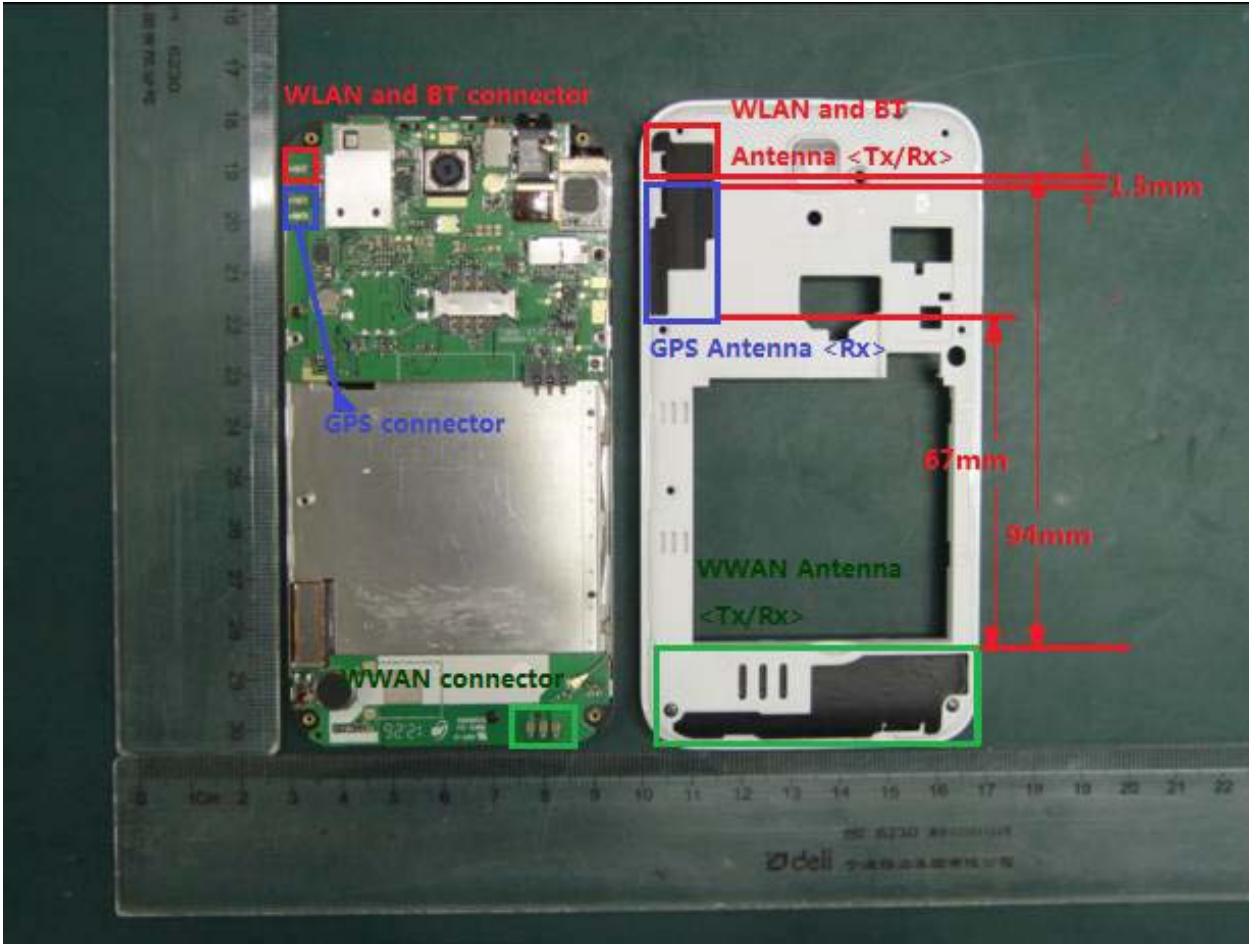

Sides for SAR tests; Hotspot mode						
Test distance: 10 mm						
Band	Back	Front	Top	Back	Right	Left
GSM 850	✓	✓	X	✓	✓	✓
GSM 1900	✓	✓	X	✓	✓	✓
WCDMA Band II	✓	✓	X	✓	✓	✓
WCDMA Band V	✓	✓	X	✓	✓	✓
WLAN 11b/g 2.4GHz	✓	✓	✓	X	✓	X

Sides for SAR tests; Body-worn mode Test distance: 10 mm						
Band	Back	Front	Top	Back	Right	Left
GSM 850	✓	X	X	X	X	X
GSM 1900	✓	X	X	X	X	X
WCDMA Band II	✓	X	X	X	X	X
WCDMA Band V	✓	X	X	X	X	X
WLAN 11b/g 2.4GHz	✓	X	X	X	X	X

Note:

1:Only Back worst Mode of Hotspot as Test Mode

2:The product supports wireless router function (hot spot )

## 8.2. Simultaneous Transmitting Configurations

Simultaneous Transmitting Configuration	Applicable Combination
Simultaneous Transmission	WWAN+BT
	WWAN+WIFI

1. WLAN and BT share the same antenna, thus they cannot transmit simultaneously.
2. Per KDB KDB 648474 D01, Bluetooth (7.18 dBm) output power  $\leq 60/f$  and the distance to other antennas  $\geq 5\text{cm}$ , therefore, stand-alone SAR is not required; the simultaneous transmission SAR for WWAN and Bluetooth were not required, because Bluetooth standalone SAR is not required

### 8.3. Conducted Power(Unit:dBm)

#### 8.3.1 WWAN Conducted Power

Band	GSM850			GSM1900		
Channel	128	190	251	512	661	810
Frequency(MHz)	824.2	836.6	848.8	1850.2	1880.0	1909.8
GSM	32.30	32.34	32.39	29.87	29.64	29.22
Band	WCDMA band II			WCDMA band V		
Channel	9262	9400	9538	4132	4183	4233
Frequency(MHz)	1852.4	1880.0	1907.6	826.4	836.6	846.6
WCDMA	21.84	22.06	21.63	22.17	22.43	21.85

Band	Conducted Power (dBm)			Factor (dB)	Average Power (dBm)		
Channel	128	190	251		128	190	251
Frequency(MHz)	824.2	836.6	848.8		824.2	836.6	848.8
GPRS8(1up)	32.27	32.32	32.35	-9.03	23.24	23.29	23.32
GPRS10(2up)	30.76	30.89	30.77	-6.02	24.74	24.87	24.75
GPRS12(4up)	28.29	28.37	28.41	-3.01	25.28	25.36	25.40

Band	Conducted Power (dBm)			Factor (dB)	Average Power (dBm)		
Channel	512	661	810		512	661	810
Frequency(MHz)	1850.2	1880.0	1909.8		1850.2	1880.0	1909.8
GPRS8(1up)	29.83	29.62	29.19	-9.03	20.80	20.59	20.16
GPRS10(2up)	27.56	27.49	27.55	-6.02	21.54	21.47	21.53
GPRS12(4up)	25.58	25.57	25.51	-3.01	22.57	22.56	22.50

#### NOTES:

Division Factors:

To average the power, the division factor is as follows:

1TX-slot = 1 transmit time slot out of 8 time slots=> conducted power divided by (8/1) => -9.03dB

2TX-slots = 2 transmit time slots out of 8 time slots=> conducted power divided by (8/2) => -6.02dB

3TX-slots = 3 transmit time slots out of 8 time slots=> conducted power divided by (8/3) => -4.26dB

4TX-slots = 4 transmit time slots out of 8 time slots=> conducted power divided by (8/4) => -3.01dB

1. For Head SAR testing, GSM should be evaluated, therefore the DUT was set in GSM for GSM850 and GSM1900 due to its highest source-based time-average power.

2. For Body-worn SAR testing, GPRS should be evaluated, therefore the DUT was set in GPRS 12 for GSM850 and set in GPRS 12 for GSM1900 due to its highest source-based time-average power.

3. Per 2010/10 workshop, the maximum output power channel is used for SAR testing and for further SAR test reduction.

4. The DUT do not support DTM and VOIP function.

## 8.3.2 BT conducted power

Channel	Frequency	Bluetooth RF Output Power (dBm)		
		Data Rate / Modulation		
		GFSK	$\pi$ /4-DQPSK	8-DPSK
		1Mbps	2Mbps	3Mbps
Ch00	2402MHz	<b>7.18</b>	6.41	6.41
Ch39	2441MHz	6.99	6.10	6.16
Ch78	2480MHz	6.96	6.12	6.09

Bluetooth standalone SAR is not required because the Bluetooth highest average power (**7.18dBm**) is less than 60/f.

## 8.3.3 WiFi conducted power

Channel	Frequency	2.4GHz 802.11b RF Power (dBm)			
		At DSSS Data Rate			
		1 Mbps	2 Mbps	5.5 Mbps	11 Mbps
CH 01	2412 MHz	<b>17.91</b>	17.77	17.86	17.79
CH 06	2437 MHz	17.75	17.55	17.74	17.44
CH 11	2462 MHz	17.56	17.34	17.53	17.22

Channel	Frequency	2.4GHz 802.11g RF Power (dBm)							
		At OFDM Data Rate							
		6	9	12	18	24	36	48	54
		Mbps	Mbps	Mbps	Mbps	Mbps	Mbps	Mbps	Mbps
CH01	2412MHz	<b>16.12</b>	16.01	15.87	15.66	15.39	15.01	14.43	14.33
CH06	2437MHz	15.86	15.71	15.59	15.33	15.09	14.71	14.35	14.23
CH11	2462MHz	15.64	15.48	15.36	15.11	14.87	14.28	13.92	13.81

Note:

1. Per KDB 248227, 11g output power is less than 1/4 dB higher than 11b mode, thus the SAR can be excluded.
2. Per 2010/4 TCB workshop, choose the highest output power channel to test SAR and determine further SAR exclusion, and CH01 is chosen here.

**8.4. Test Records for Head SAR Test**

SAR MEASUREMENT					
Ambient Temperature (°C): 21.2 ± 2			Relative Humidity (%): 46		
Liquid Temperature (°C): 20.5 ± 2			Depth of Liquid (cm):>15		
Product: GSM/WCDMA MOBILE PHONE					
Test Mode: GSM850					
Test Position Head	Antenna Position	Frequency		SAR 1g (W/kg)	Limit (W/kg)
		Channel	MHz		
Left-Cheek	Internal	251	848.8	0.518	1.6
Left-Tilted	Internal	251	848.8	0.321	1.6
Right- Cheek	Internal	251	848.8	0.502	1.6
Right - Tilted	Internal	251	848.8	0.488	1.6
Right- Cheek	Internal	128	824.2	0.365	1.6
Right- Cheek	Internal	190	836.6	0.402	1.6

SAR MEASUREMENT					
Ambient Temperature (°C): 21.2 ± 2			Relative Humidity (%): 46		
Liquid Temperature (°C): 20.5 ± 2			Depth of Liquid (cm):>15		
Product:GSM/WCDMA MOBILE PHONE					
Test Mode: PCS 1900					
Test Position Head	Antenna Position	Frequency		SAR 1g (W/kg)	Limit (W/kg)
		Channel	MHz		
Left-Cheek	Internal	512	1850.2	0.713	1.6
Left- Tilted	Internal	512	1850.2	0.423	1.6
Right-Cheek	Internal	512	1850.2	1.018	1.6
Right -Tilted	Internal	512	1850.2	0.297	1.6
Left-Cheek	Internal	661	1880.0	1.104	1.6
Left-Cheek	Internal	810	1909.8	1.065	1.6

SAR MEASUREMENT					
Ambient Temperature (°C): 21.2 ± 2			Relative Humidity (%): 46		
Liquid Temperature (°C): 20.5 ± 2			Depth of Liquid (cm):>15		
Product: GSM/WCDMA MOBILE PHONE					
Test Mode: WCDMA band II					
Test Position Head	Antenna Position	Frequency		SAR 1g (W/kg)	Limit (W/kg)
		Channel	MHz		
Left-Cheek	Internal	9400	1880.0	1.268	1.6
Left- Tilted	Internal	9400	1880.0	0.361	1.6
Right-Cheek	Internal	9400	1880.0	1.248	1.6
Right -Tilted	Internal	9400	1880.0	0.777	1.6
Left-Cheek	Internal	9262	1852.4	1.165	1.6
Left-Cheek	Internal	9538	1907.6	0.912	1.6
Right-Cheek	Internal	9262	1852.4	1.233	1.6
Right-Cheek	Internal	9538	1907.6	0.923	1.6

SAR MEASUREMENT					
Ambient Temperature (°C): 21.2 ± 2			Relative Humidity (%): 46		
Liquid Temperature (°C): 20.5 ± 2			Depth of Liquid (cm):>15		
Product: GSM/WCDMA MOBILE PHONE					
Test Mode: WCDMA band V					
Test Position Head	Antenna Position	Frequency		SAR 1g (W/kg)	Limit (W/kg)
		Channel	MHz		
Left-Cheek	Internal	4183	836.6	0.420	1.6
Left- Tilted	Internal	4183	836.6	0.315	1.6
Right-Cheek	Internal	4183	836.6	0.414	1.6
Right -Tilted	Internal	4183	836.6	0.321	1.6
Right-Cheek	Internal	4233	846.6	0.316	1.6
Right-Cheek	Internal	4132	826.4	0.411	1.6

SAR MEASUREMENT					
Ambient Temperature (°C): 21.2 ± 2			Relative Humidity (%): 46		
Liquid Temperature (°C): 20.5 ± 2			Depth of Liquid (cm):>15		
Product: GSM/WCDMA MOBILE PHONE					
Test Mode: 802.11b					
Test Position Head	Antenna Position	Frequency		SAR 1g (W/kg)	Limit (W/kg)
		Channel	MHz		
Left-Cheek	Internal	1	2412	0.168	1.6
Left- Tilted	Internal	1	2412	0.184	1.6
Right-Cheek	Internal	1	2412	0.079	1.6
Right -Tilted	Internal	1	2412	0.091	1.6

**Note:** Per KDB 648474, if the highest output channel SAR for each exposure position  $\leq 0.8$  W/kg other channels SAR tests are not necessary.

**8.5. Test Records for Body-worn / Hotspot SAR Test****DUT with Flat Phantom 10mm Gap**

SAR MEASUREMENT					
Ambient Temperature (°C): 21.2 ± 2			Relative Humidity (%): 46		
Liquid Temperature (°C): 20.5 ± 2			Depth of Liquid (cm):>15		
Product:GSM/WCDMA MOBILE PHONE					
Test Mode: GPRS850(GPRS12)					
Test Position Body	Antenna Position	Frequency		SAR 1g (W/kg)	Limit (W/kg)
		Channel	MHz		
Body Front	Internal	251	848.8	0.696	1.6
Body Back	Internal	128	824.2	1.097	1.6
Body Back	Internal	190	836.6	1.137	1.6
Body Back	Internal	251	848.8	1.169	1.6
Body Left	Internal	251	848.8	0.623	1.6
Body Right	Internal	251	848.8	0.631	1.6
Body Bottom	Internal	251	848.8	0.393	1.6

**DUT with Flat Phantom 10mm Gap**

SAR MEASUREMENT					
Ambient Temperature (°C): 21.2 ± 2			Relative Humidity (%): 46		
Liquid Temperature (°C): 20.5 ± 2			Depth of Liquid (cm):>15		
Product: GSM/WCDMA MOBILE PHONE					
Test Mode: GPRS 1900(GPRS12)					
Test Position Body	Antenna Position	Frequency		SAR 1g (W/kg)	Limit (W/kg)
		Channel	MHz		
Body Front	Internal	512	1850.2	0.553	1.6
Body Back	Internal	512	1850.2	0.998	1.6
Body Back	Internal	661	1880.0	1.230	1.6
Body Back	Internal	810	1909.8	1.361	1.6
Body Left	Internal	512	1850.2	0.230	1.6
Body Right	Internal	512	1850.2	0.102	1.6
Body Bottom	Internal	512	1850.2	0.079	1.6



**DUT with Flat Phantom 10mm Gap**

SAR MEASUREMENT					
Ambient Temperature (°C): 21.2 ± 2			Relative Humidity (%): 46		
Liquid Temperature (°C): 20.5 ± 2			Depth of Liquid (cm):>15		
Product: GSM/WCDMA MOBILE PHONE					
Test Mode: WCDMA band II					
Test Position Body	Antenna Position	Frequency		SAR 1g (W/kg)	Limit (W/kg)
		Channel	MHz		
Body Front	Internal	9400	1880.0	0.749	1.6
Body Back	Internal	9262	1852.4	1.023	1.6
Body Back	Internal	9400	1880.0	1.230	1.6
Body Back	Internal	9538	1907.6	1.179	1.6
Body Left	Internal	9400	1880.0	0.246	1.6
Body Right	Internal	9400	1880.0	0.123	1.6
Body Bottom	Internal	9400	1880.0	0.109	1.6

## Note:

Per KDB 648474, if the highest output channel SAR for each exposure position ≤ 0.8 W/kg other channels SAR tests are not necessary.

**DUT with Flat Phantom 10mm Gap**

SAR MEASUREMENT					
Ambient Temperature (°C): 21.2 ± 2			Relative Humidity (%): 46		
Liquid Temperature (°C): 20.5 ± 2			Depth of Liquid (cm):>15		
Product: GSM/WCDMA MOBILE PHONE					
Test Mode: WCDMA band V					
Test Position Body	Antenna Position	Frequency		SAR 1g (W/kg)	Limit (W/kg)
		Channel	MHz		
Body Front	Internal	4183	836.6	0.413	1.6
Body Back	Internal	4132	826.4	0.907	1.6
Body Back	Internal	4183	836.6	0.874	1.6
Body Back	Internal	4233	846.6	0.843	1.6
Body Left	Internal	4183	836.6	0.428	1.6
Body Right	Internal	4183	836.6	0.553	1.6
Body Bottom	Internal	4183	836.6	0.497	1.6

**DUT with Flat Phantom 10mm Gap**

SAR MEASUREMENT					
Ambient Temperature (°C): 21.2 ± 2			Relative Humidity (%): 46		
Liquid Temperature (°C): 20.5 ± 2			Depth of Liquid (cm):>15		
Product: GSM/WCDMA MOBILE PHONE					
Test Mode: 802.11b					
Test Position Body	Antenna Position	Frequency		SAR 1g (W/kg)	Limit (W/kg)
		Channel	MHz		
Body Front	Internal	1	2412	0.060	1.6
Body Back	Internal	1	2412	0.123	1.6
Body Right	Internal	1	2412	0.091	1.6
Body Top	Internal	1	2412	0.060	1.6

**Note:**

Per KDB 648474, if the highest output channel SAR for each exposure position  $\leq 0.8$  W/kg other channels SAR tests are not necessary.

**Note:**

- Per KDB 941225 D06, for DUT dimension  $\geq 9\text{cm} \times 5\text{cm}$ , the test distance is 1cm. SAR must be measured for all surFronts and sides with a transmitting antenna located within 2.5cm from that surFront or edge.
- As in (1), SAR for Front/Back/ Back Side/Left Side/Right Side is necessary.
- Per KDB 648474, if the highest output channel SAR for each exposure position  $\leq 0.8$  W/kg other channels SAR tests are not necessary.

**8.6. Test Records for Body-worn SAR Test****DUT with Flat Phantom 10mm Gap**

SAR MEASUREMENT					
Ambient Temperature (°C): 21.2 ± 2			Relative Humidity (%): 46		
Liquid Temperature (°C): 20.5 ± 2			Depth of Liquid (cm):>15		
Product:GSM/WCDMA MOBILE PHONE					
Test Mode: GPRS850(GPRS12)+Earphone					
Test Position Body	Antenna Position	Frequency		SAR 1g (W/kg)	Limit (W/kg)
		Channel	MHz		
Body Back	Internal	128	824.2	1.024	1.6
Body Back	Internal	190	836.6	1.079	1.6
Body Back	Internal	251	848.8	1.103	1.6

**Note:**

Per KDB 648474, if the highest output channel SAR for each exposure position ≤ 0.8 W/kg other channels SAR tests are not necessary.

Only Back worst Mode of Hotspot as Test Mode

**DUT with Flat Phantom 10mm Gap**

SAR MEASUREMENT					
Ambient Temperature (°C): 21.2 ± 2			Relative Humidity (%): 46		
Liquid Temperature (°C): 20.5 ± 2			Depth of Liquid (cm):>15		
Product: GSM/WCDMA MOBILE PHONE					
Test Mode: GPRS 1900(GPRS12)+Earphone					
Test Position Body	Antenna Position	Frequency		SAR 1g (W/kg)	Limit (W/kg)
		Channel	MHz		
Body Back	Internal	512	1850.2	0.766	1.6

**Note:**

Per KDB 648474, if the highest output channel SAR for each exposure position ≤ 0.8 W/kg other channels SAR tests are not necessary.

Only Back worst Mode of Hotspot as Test Mode

**DUT with Flat Phantom 10mm Gap**

SAR MEASUREMENT					
Ambient Temperature (°C): 21.2 ± 2			Relative Humidity (%): 46		
Liquid Temperature (°C): 20.5 ± 2			Depth of Liquid (cm):>15		
Product: GSM/WCDMA MOBILE PHONE					
Test Mode: WCDMA band II +Earphone					
Test Position Body	Antenna Position	Frequency		SAR 1g (W/kg)	Limit (W/kg)
		Channel	MHz		
Body Back	Internal	9262	1852.4	0.829	1.6
Body Back	Internal	9400	1800.0	1.239	1.6
Body Back	Internal	9400	1907.6	1.200	1.6

**Note:**

Per KDB 648474, if the highest output channel SAR for each exposure position ≤ 0.8 W/kg other channels SAR tests are not necessary.

Only Back worst Mode of Hotspot as Test Mode

**DUT with Flat Phantom 10mm Gap**

SAR MEASUREMENT					
Ambient Temperature (°C): 21.2 ± 2			Relative Humidity (%): 46		
Liquid Temperature (°C): 20.5 ± 2			Depth of Liquid (cm):>15		
Product: GSM/WCDMA MOBILE PHONE					
Test Mode: WCDMA band V +Earphone					
Test Position Body	Antenna Position	Frequency		SAR 1g (W/kg)	Limit (W/kg)
		Channel	MHz		
Body Back	Internal	4183	836.6	0.750	1.6

**Note:**

Per KDB 648474, if the highest output channel SAR for each exposure position ≤ 0.8 W/kg other channels SAR tests are not necessary.

Only Back worst Mode of Hotspot as Test Mode

**DUT with Flat Phantom 10mm Gap**

SAR MEASUREMENT					
Ambient Temperature (°C): 21.2 ± 2			Relative Humidity (%): 46		
Liquid Temperature (°C): 20.5 ± 2			Depth of Liquid (cm):>15		
Product: GSM/WCDMA MOBILE PHONE					
Test Mode: 802.11b+Earphone					
Test Position Body	Antenna Position	Frequency		SAR 1g (W/kg)	Limit (W/kg)
		Channel	MHz		
Body Back	Internal	1	2412	0.121	1.6

**Note:**

Per KDB 648474, if the highest output channel SAR for each exposure position  $\leq 0.8$  W/kg other channels SAR tests are not necessary.

Only Back worst Mode of Hotspot as Test Mode

## 8.7. Simultaneous Multi-band Transmission

Maximum SAR list for each band and position

	GSM 850	GSM 1900	WCDMA Band II	WCDMA Band V	802.11 b/g	Max.SAR Summation	Hotspot Separation	Result
Left-Cheek	0.518	0.713	<b>1.268</b>	0.420	0.168	<b>1.436</b>	<b>1</b>	pass
Left- Tilted	0.321	<b>0.423</b>	0.361	0.315	0.184	<b>0.607</b>	<b>1</b>	pass
Right-Cheek	0.502	1.018	<b>1.248</b>	0.414	0.079	<b>1.327</b>	<b>1</b>	pass
Right -Tilted	0.488	0.297	<b>0.777</b>	0.321	0.091	<b>0.868</b>	<b>1</b>	pass
Left-Cheek		1.104	1.165				<b>1</b>	pass
Left-Cheek		1.065	0.912				<b>1</b>	pass
Right-Cheek	0.365		1.233	0.316			<b>1</b>	pass
Right-Cheek	0.402		0.923	0.411			<b>1</b>	pass
Body Front	0.696	0.553	<b>0.749</b>	0.413	0.060	<b>0.809</b>	<b>1</b>	pass
Body Back	<b>1.097</b>	0.998	1.023	0.907	0.123	<b>1.220</b>	<b>1</b>	pass
Body Back	1.137	1.230	1.230	0.874			<b>1</b>	
Body Back	1.169	1.361	1.179	0.843			<b>1</b>	
Body Left	0.623	0.230	0.246	0.428			<b>1</b>	pass
Body Right	<b>0.631</b>	0.102	0.123	0.553	0.091	<b>0.795</b>	<b>1</b>	pass
Body Top					0.060		<b>1</b>	pass
Body Bottom	0.393	0.079	0.109	0.497			<b>1</b>	pass

**Note:**

1. The maximum SAR summation is calculated based on the same configuration and test position.
2. According to KDB 648474, for 1-g SAR scalar summation <1.6W/kg, simultaneous SAR measurement is not necessary.

## References:

- [1] FCC 47 CFR Part 2 “Frequency Allocations and Radio Treaty Matters; General Rules and Regulations”
- [2] IEEE Std. C95.1-1999, “IEEE Standard for Safety Levels with Respect to Human Exposure to Radio Frequency Electromagnetic Fields, 3 kHz to 300 GHz”, 1999
- [3] IEEE Std. 1528-2003, “Recommended Practice for Determining the Peak Spatial-Average Specific Absorption Rate (SAR) in the Human Head from Wireless Communications Devices: Measurement Techniques”, December 2003
- [4] FCC OET Bulletin 65 (Edition 97-01) Supplement C (Edition 01-01), “Evaluating Compliance with FCC Guidelines for Human Exposure to Radiofrequency Electromagnetic Fields”, June 2001
- [5] SPEAG DASY System Handbook
- [6] FCC KDB 248227 D01 v01r02, “SAR Measurement Procedures for 802.11 a/b/g Transmitters”, May 2007
- [7] FCC KDB 447498 D01 v04, “Mobile and Portable Device RF Exposure Procedures and Equipment Authorization Policies”, November 2009
- [8] FCC KDB 447498 D02 v02, “SAR Measurement Procedures for USB Dongle Transmitters”, November 2009
- [9] FCC KDB 616217 D01 v01r01, “SAR Evaluation Considerations for LapTop Computers with Antennas Built-in on Display Screens”, November 2009
- [10] FCC KDB 616217 D03 v01, “SAR Evaluation Considerations for LapTop/Notebook/Netbook and Tablet Computers”, November 2009
- [11] FCC KDB 648474 D01 v01r05, “SAR Evaluation Considerations for Handsets with Multiple Transmitters and Antennas”, September 2008
- [12] FCC KDB 941225 D01 v02, “SAR Measurement Procedures for 3G Devices – CDMA 2000 / Ev-Do / WCDMA / HSDPA / HSPA”, October 2007
- [13] FCC KDB 941225 D03 v01, “Recommended SAR Test Reduction Procedures for GSM / GPRS /EDGE”, December 2008
- [14] KDB 941225 D04 SAR for GSM E GPRS Dual Xfer Mode v01
- [15] 941225 D06 Hot Spot SAR v01

8.8. SAR Measurement Data

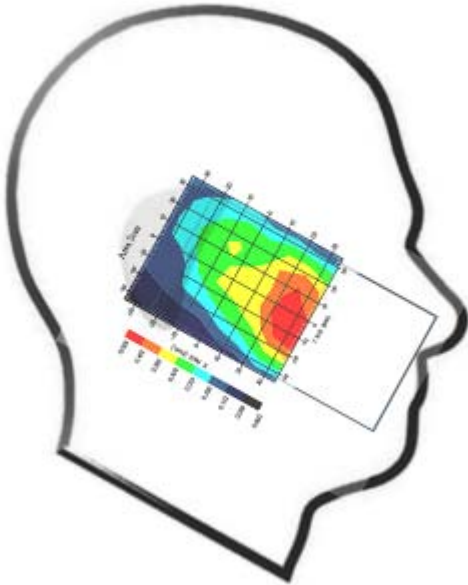
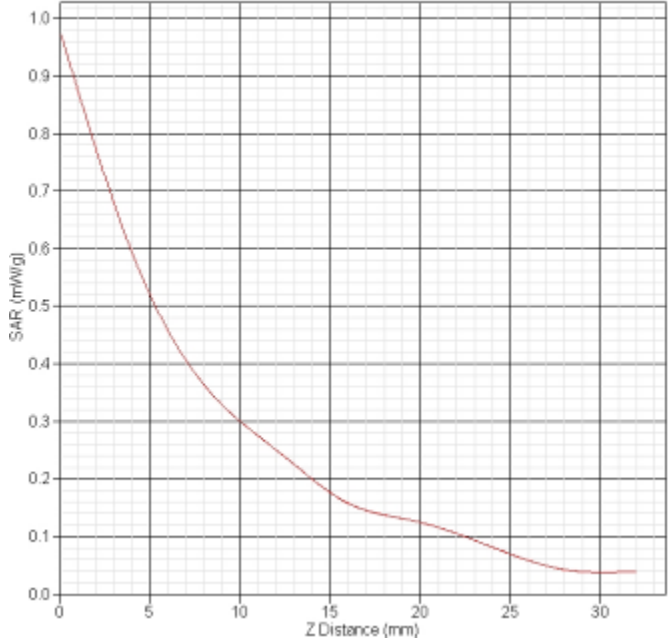
<b>GSM850 left cheek ch251</b>																	
Frequency(MHz)	848.8																
Relative permittivity(real part)	40.24																
Conductivity(S/m)	0.91																
Variation(%)	-2.908																
Duty Cycle Factor	8																
Crest factor	8																
Conversion Fator	6.5																
Probe Sensitivity	1.20 1.20 1.20 $\mu V/(V/m)^2$																
Data	2012-08-20																
	<p>SAR-Z Axis at Hotspot z:48.14 y:-13.11</p>  <table border="1"> <caption>SAR-Z Axis Data</caption> <thead> <tr> <th>Z Distance (mm)</th> <th>SAR (mW/kg)</th> </tr> </thead> <tbody> <tr><td>0</td><td>0.95</td></tr> <tr><td>5</td><td>0.55</td></tr> <tr><td>10</td><td>0.30</td></tr> <tr><td>15</td><td>0.18</td></tr> <tr><td>20</td><td>0.12</td></tr> <tr><td>25</td><td>0.08</td></tr> <tr><td>30</td><td>0.05</td></tr> </tbody> </table>	Z Distance (mm)	SAR (mW/kg)	0	0.95	5	0.55	10	0.30	15	0.18	20	0.12	25	0.08	30	0.05
Z Distance (mm)	SAR (mW/kg)																
0	0.95																
5	0.55																
10	0.30																
15	0.18																
20	0.12																
25	0.08																
30	0.05																
SAR 1g(W/Kg)	0.518																
SAR 10g(W/Kg)	0.282																

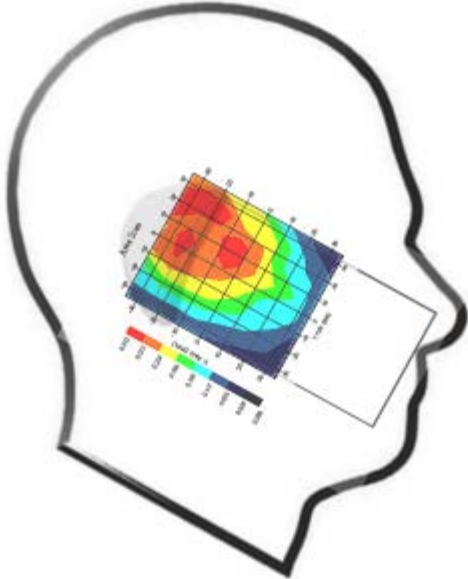
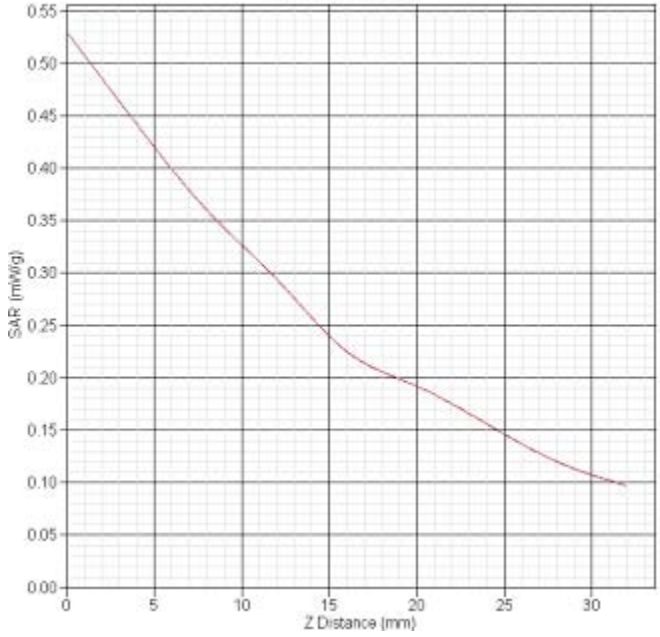

<b>GSM850 left tilt ch251</b>																	
Frequency(MHz)	848.8																
Relative permittivity(real part)	40.24																
Conductivity(S/m)	0.91																
Variation(%)	-0.480																
Duty Cycle Factor	8																
Crest factor	8																
Conversion Fator	6.5																
Probe Sensitivity	1.20 1.20 1.20 $\mu V/(V/m)^2$																
Data	2012-08-20																
	<p>SAR-Z Axis * Hotspot x:18.10 y:4.97</p>  <table border="1"> <caption>SAR vs Z Distance Data</caption> <thead> <tr> <th>Z Distance (mm)</th> <th>SAR (mW/kg)</th> </tr> </thead> <tbody> <tr><td>0</td><td>0.53</td></tr> <tr><td>5</td><td>0.42</td></tr> <tr><td>10</td><td>0.33</td></tr> <tr><td>15</td><td>0.24</td></tr> <tr><td>20</td><td>0.19</td></tr> <tr><td>25</td><td>0.15</td></tr> <tr><td>30</td><td>0.10</td></tr> </tbody> </table>	Z Distance (mm)	SAR (mW/kg)	0	0.53	5	0.42	10	0.33	15	0.24	20	0.19	25	0.15	30	0.10
Z Distance (mm)	SAR (mW/kg)																
0	0.53																
5	0.42																
10	0.33																
15	0.24																
20	0.19																
25	0.15																
30	0.10																
SAR 1g(W/Kg)	0.321																
SAR 10g(W/Kg)	0.224																

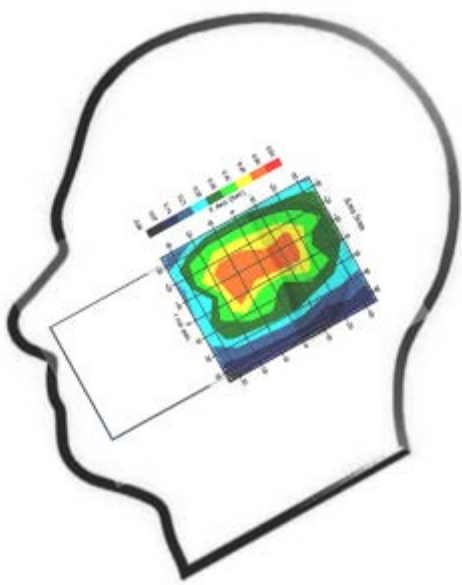
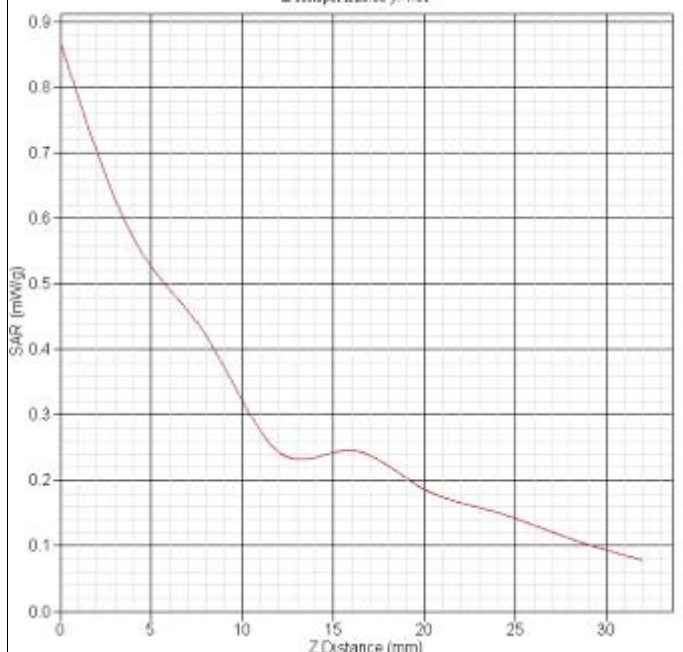
<b>GSM850 Right cheek ch251</b>																			
Frequency(MHz)	848.8																		
Relative permittivity(real part)	40.24																		
Conductivity(S/m)	0.91																		
Variation(%)	-1.148																		
Duty Cycle Factor	8																		
Crest factor	8																		
Conversion Fator	6.5																		
Probe Sensitivity	1.20 1.20 1.20 $\mu V/(V/m)^2$																		
Data	2012-08-20																		
	<p><b>SAR-Z AXIS</b> at Hotspot x:23.06 y:-7.01</p>  <table border="1"> <caption>Approximate data points from SAR-Z AXIS graph</caption> <thead> <tr> <th>Z Distance (mm)</th> <th>SAR (mW/kg)</th> </tr> </thead> <tbody> <tr><td>0</td><td>0.85</td></tr> <tr><td>5</td><td>0.55</td></tr> <tr><td>10</td><td>0.30</td></tr> <tr><td>15</td><td>0.25</td></tr> <tr><td>20</td><td>0.18</td></tr> <tr><td>25</td><td>0.14</td></tr> <tr><td>30</td><td>0.10</td></tr> <tr><td>32</td><td>0.08</td></tr> </tbody> </table>	Z Distance (mm)	SAR (mW/kg)	0	0.85	5	0.55	10	0.30	15	0.25	20	0.18	25	0.14	30	0.10	32	0.08
Z Distance (mm)	SAR (mW/kg)																		
0	0.85																		
5	0.55																		
10	0.30																		
15	0.25																		
20	0.18																		
25	0.14																		
30	0.10																		
32	0.08																		
SAR 1g(W/Kg)	0.502																		
SAR 10g(W/Kg)	0.244																		

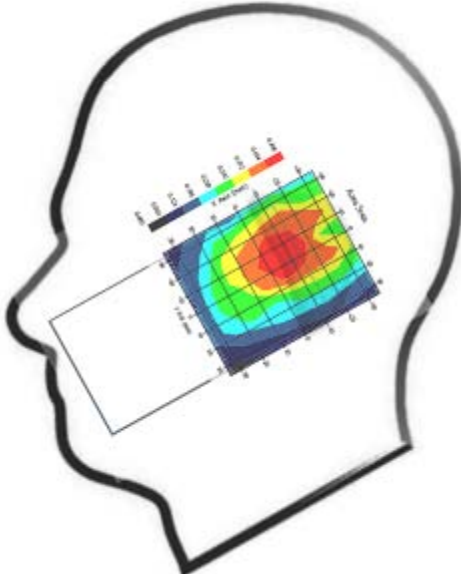
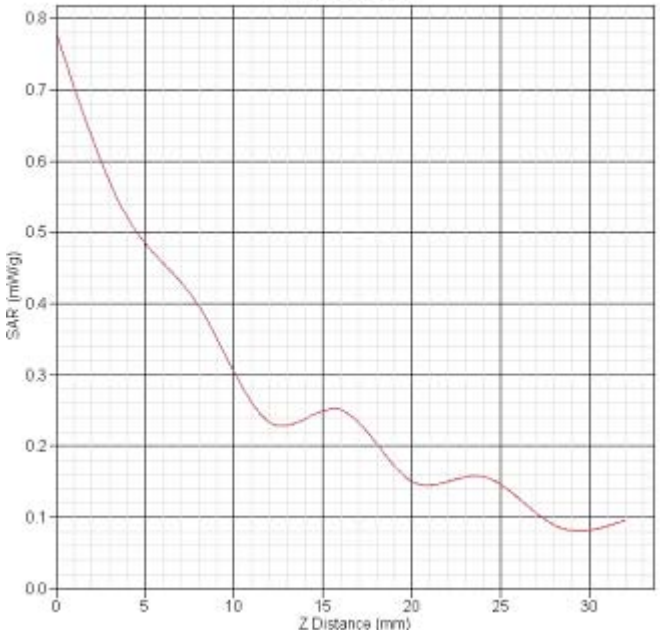
<b>GSM850 Right tilt CH251</b>	
Frequency(MHz)	848.8
Relative permittivity(real part)	40.24
Conductivity(S/m)	0.91
Variation(%)	-0.636
Duty Cycle Factor	8
Crest factor	8
Conversion Fator	6.5
Probe Sensitivity	1.20 1.20 1.20 $\mu$ V/(V/m) <sup>2</sup>
Data	2012-08-20
	<p>SAR-Z Axis at Hotspot x=0.12 y=4.92</p> 
SAR 1g(W/Kg)	0.488
SAR 10g(W/Kg)	0.324

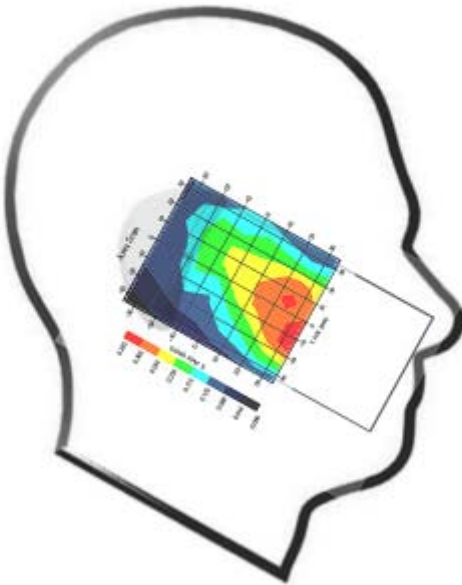
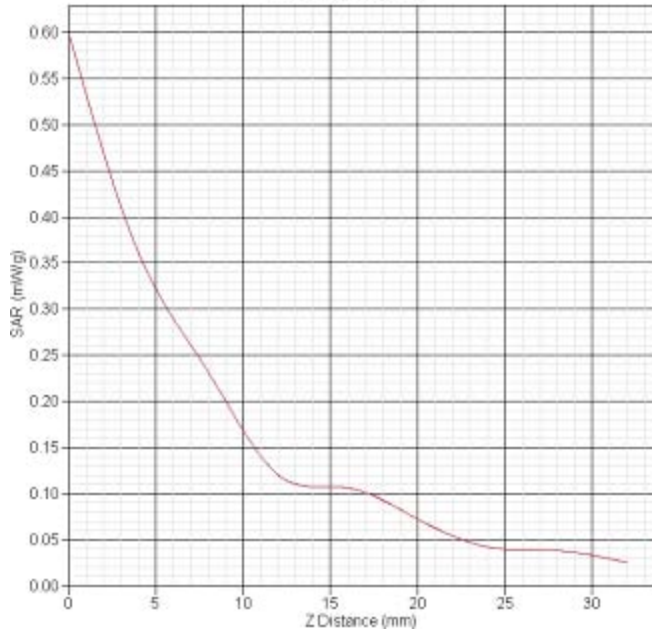
<b>GSM850 Left cheek ch128</b>	
Frequency(MHz)	824.2
Relative permittivity(real part)	40.24
Conductivity(S/m)	0.91
Variation(%)	-4.439
Duty Cycle Factor	8
Crest factor	8
Conversion Fator	6.5
Probe Sensitivity	1.20 1.20 1.20 $\mu V/(V/m)^2$
Data	2012-08-20
	<p>SAR-Z Axis at Hotspot z:48.15 y:-11.09</p> 
SAR 1g(W/Kg)	0.365
SAR 10g(W/Kg)	0.211

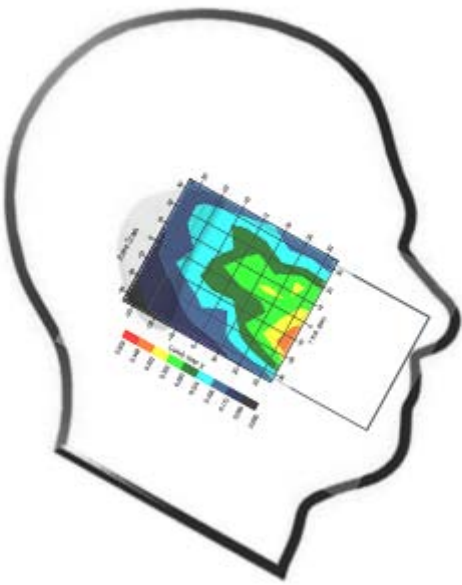
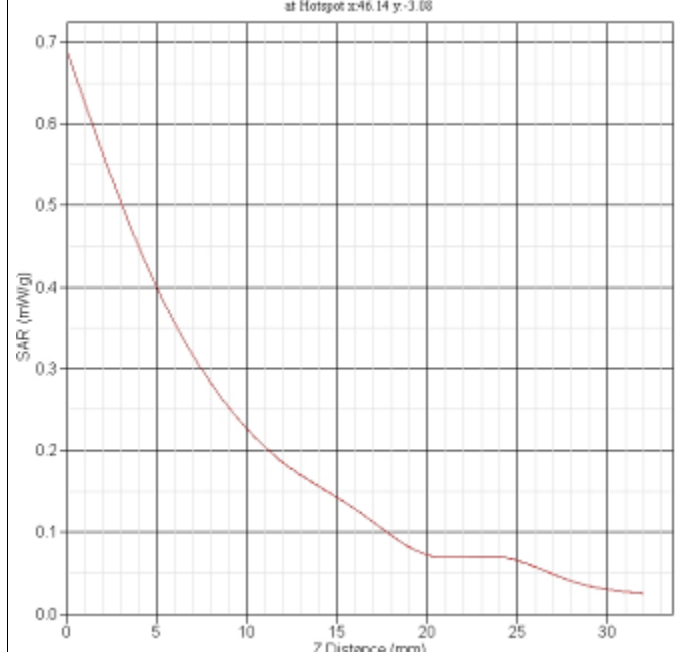
<b>GSM850 Left cheek ch190</b>	
Frequency(MHz)	836.6
Relative permittivity(real part)	40.24
Conductivity(S/m)	0.91
Variation(%)	-4.653
Duty Cycle Factor	8
Crest factor	8
Conversion Fator	6.5
Probe Sensitivity	1.20 1.20 1.20 $\mu V/(V/m)^2$
Data	2012-08-20
	<p>SAR-Z Axis at Hotspot x:46.14 y:-3.08</p> 
SAR 1g(W/Kg)	0.402
SAR 10g(W/Kg)	0.251

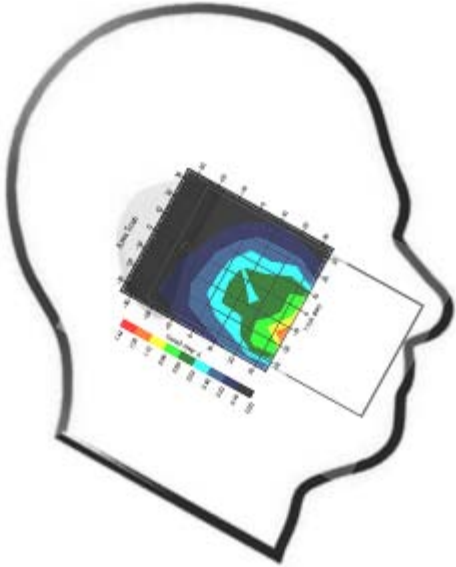
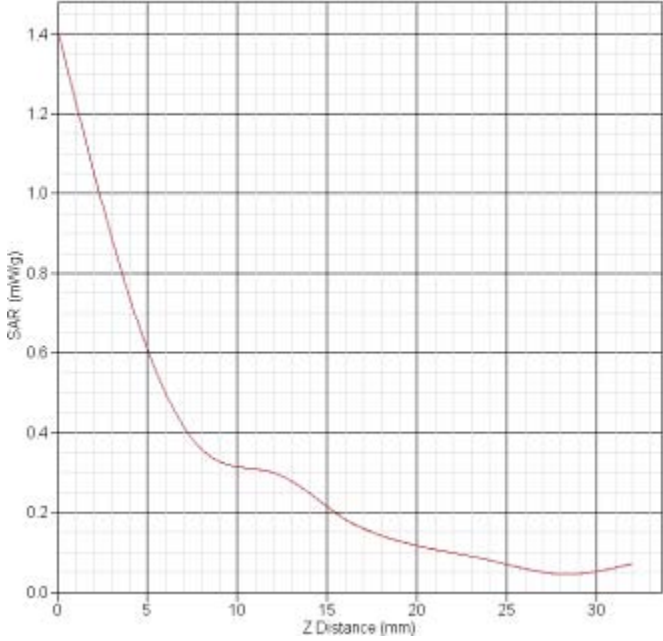
<b>GSM1900 Left cheek CH512</b>																	
Frequency(MHz)	1850.2																
Relative permittivity(real part)	41.54																
Conductivity(S/m)	1.43																
Variation(%)	-4.922																
Duty Cycle Factor	8																
Crest factor	8																
Conversion Fator	5.7																
Probe Sensitivity	1.20 1.20 1.20 $\mu V/(V/m)^2$																
Data	2012-08-20																
	<p>SAR-Z Axis at Hotspot x:28.12 y:-21.08</p>  <table border="1"> <caption>SAR-Z Axis Data Points (Estimated)</caption> <thead> <tr> <th>Z Distance (mm)</th> <th>SAR (mW/kg)</th> </tr> </thead> <tbody> <tr><td>0</td><td>1.4</td></tr> <tr><td>5</td><td>0.6</td></tr> <tr><td>10</td><td>0.35</td></tr> <tr><td>15</td><td>0.25</td></tr> <tr><td>20</td><td>0.18</td></tr> <tr><td>25</td><td>0.12</td></tr> <tr><td>30</td><td>0.1</td></tr> </tbody> </table>	Z Distance (mm)	SAR (mW/kg)	0	1.4	5	0.6	10	0.35	15	0.25	20	0.18	25	0.12	30	0.1
Z Distance (mm)	SAR (mW/kg)																
0	1.4																
5	0.6																
10	0.35																
15	0.25																
20	0.18																
25	0.12																
30	0.1																
SAR 1g(W/Kg)	0.713																
SAR 10g(W/Kg)	0.419																

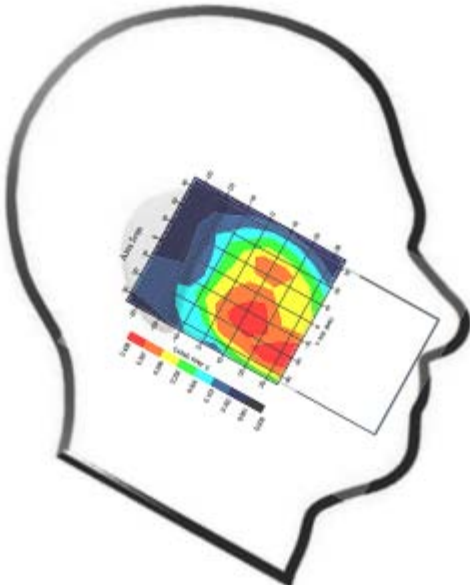
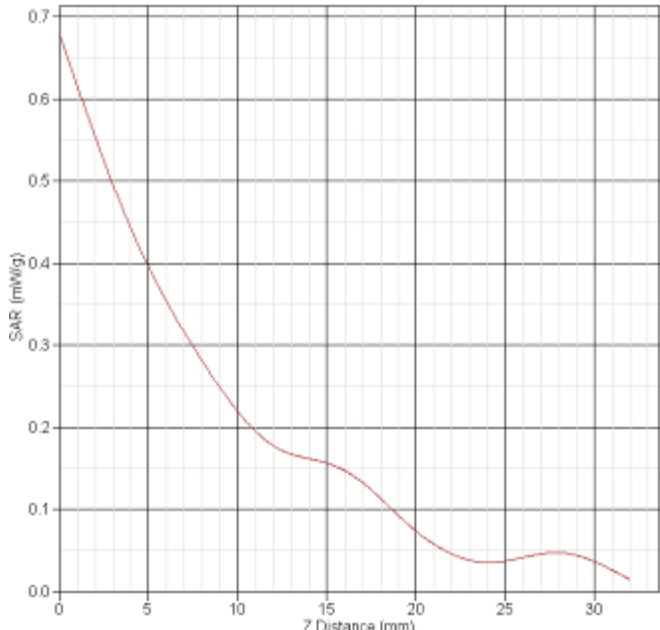
<b>GSM1900 Left tilt CH512</b>																	
Frequency(MHz)	1850.2																
Relative permittivity(real part)	41.54																
Conductivity(S/m)	1.43																
Variation(%)	-2.318																
Duty Cycle Factor	8																
Crest factor	8																
Conversion Fator	5.7																
Probe Sensitivity	1.20 1.20 1.20 $\mu V/(V/m)^2$																
Data	2012-08-20																
	<p>SAR-Z Axis at Hotspot: 38.13 y: -23.09</p>  <table border="1"> <caption>SAR-Z Axis Data</caption> <thead> <tr> <th>Z Distance (mm)</th> <th>SAR (mW/kg)</th> </tr> </thead> <tbody> <tr><td>0</td><td>0.68</td></tr> <tr><td>5</td><td>0.40</td></tr> <tr><td>10</td><td>0.22</td></tr> <tr><td>15</td><td>0.16</td></tr> <tr><td>20</td><td>0.08</td></tr> <tr><td>25</td><td>0.04</td></tr> <tr><td>30</td><td>0.02</td></tr> </tbody> </table>	Z Distance (mm)	SAR (mW/kg)	0	0.68	5	0.40	10	0.22	15	0.16	20	0.08	25	0.04	30	0.02
Z Distance (mm)	SAR (mW/kg)																
0	0.68																
5	0.40																
10	0.22																
15	0.16																
20	0.08																
25	0.04																
30	0.02																
SAR 1g(W/Kg)	0.423																
SAR 10g(W/Kg)	0.243																

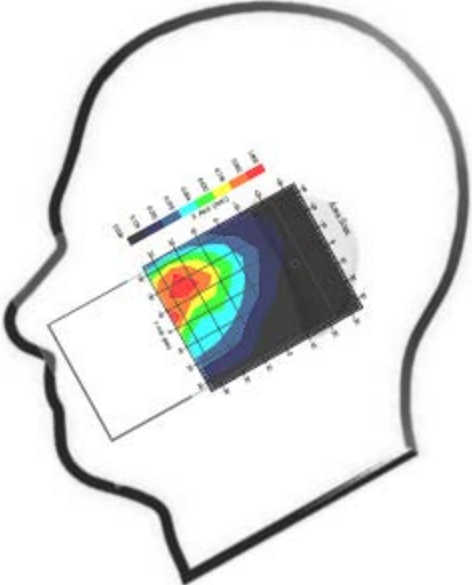
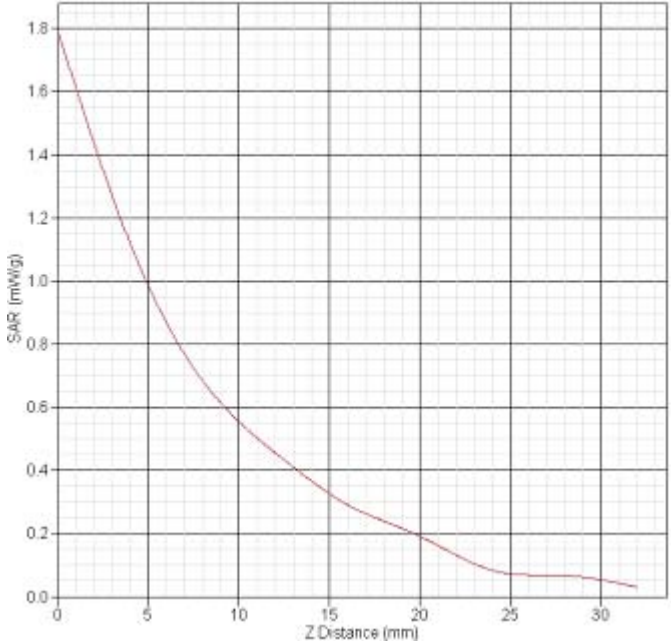
<b>GSM1900 Right cheek CH512</b>																	
Frequency(MHz)	1850.2																
Relative permittivity(real part)	41.54																
Conductivity(S/m)	1.43																
Variation(%)	-2.376																
Duty Cycle Factor	8																
Crest factor	8																
Conversion Fator	5.7																
Probe Sensitivity	1.20 1.20 1.20 $\mu V/(V/m)^2$																
Data	2012-08-20																
	<p>SAR-Z Axis at Hotspot x=48.09 y=-14.96</p>  <table border="1"> <caption>SAR-Z Axis Data</caption> <thead> <tr> <th>Z Distance (mm)</th> <th>SAR (mW/kg)</th> </tr> </thead> <tbody> <tr><td>0</td><td>1.75</td></tr> <tr><td>5</td><td>1.00</td></tr> <tr><td>10</td><td>0.60</td></tr> <tr><td>15</td><td>0.35</td></tr> <tr><td>20</td><td>0.20</td></tr> <tr><td>25</td><td>0.10</td></tr> <tr><td>30</td><td>0.05</td></tr> </tbody> </table>	Z Distance (mm)	SAR (mW/kg)	0	1.75	5	1.00	10	0.60	15	0.35	20	0.20	25	0.10	30	0.05
Z Distance (mm)	SAR (mW/kg)																
0	1.75																
5	1.00																
10	0.60																
15	0.35																
20	0.20																
25	0.10																
30	0.05																
SAR 1g(W/Kg)	1.018																
SAR 10g(W/Kg)	0.527																

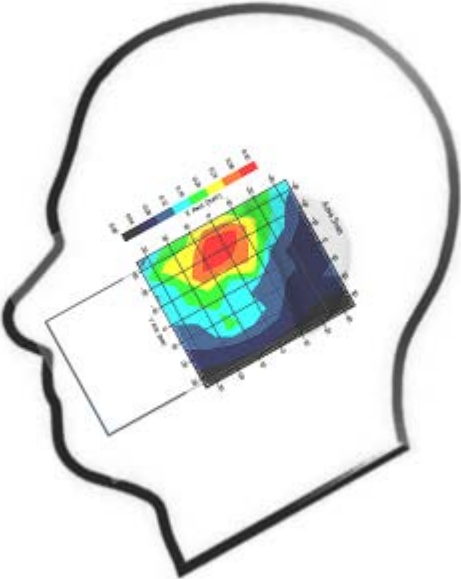
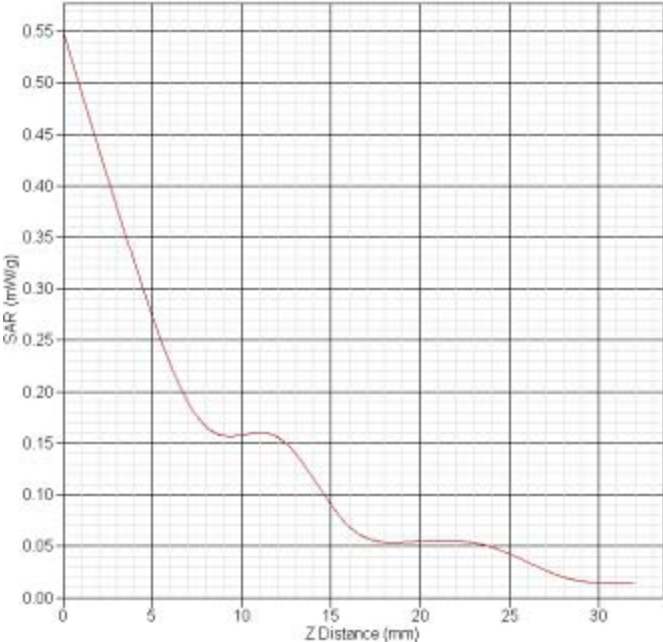

<b>GSM1900 Right tilt CH512</b>	
Frequency(MHz)	1850.2
Relative permittivity(real part)	41.54
Conductivity(S/m)	1.43
Variation(%)	-1.817
Duty Cycle Factor	8
Crest factor	8
Conversion Fator	5.7
Probe Sensitivity	1.20 1.20 1.20 $\mu V/(V/m)^2$
Data	2012-08-20
	<p>SAR-Z Axis at Hotspot x: 20.12 y: -16.95</p> 
SAR 1g(W/Kg)	0.297
SAR 10g(W/Kg)	0.168

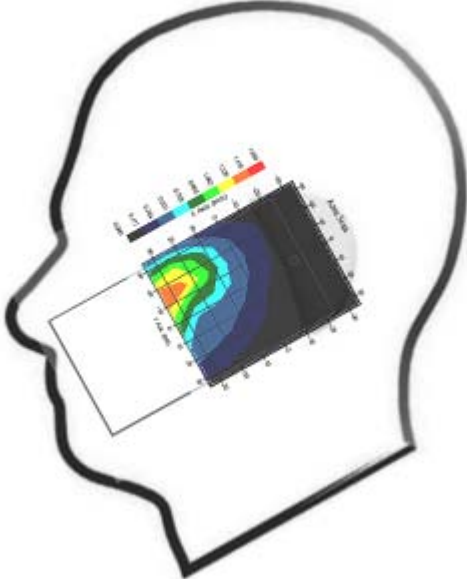
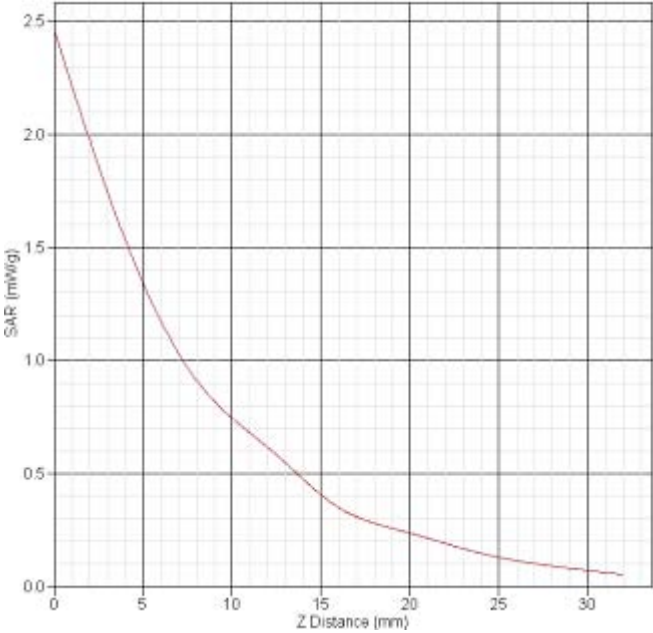
<b>GSM1900 Right cheek CH661</b>																	
Frequency(MHz)	1880.0																
Relative permittivity(real part)	41.54																
Conductivity(S/m)	1.43																
Variation(%)	3.005																
Duty Cycle Factor	8																
Crest factor	8																
Conversion Fator	5.7																
Probe Sensitivity	1.20 1.20 1.20 $\mu V/(V/m)^2$																
Data	2012-08-20																
	<p>SAR-Z Axis at Hotpot x:56.08 y:-6.96</p>  <table border="1"> <caption>SAR-Z Axis Data</caption> <thead> <tr> <th>Z Distance (mm)</th> <th>SAR (mW/kg)</th> </tr> </thead> <tbody> <tr><td>0</td><td>2.4</td></tr> <tr><td>5</td><td>1.4</td></tr> <tr><td>10</td><td>0.8</td></tr> <tr><td>15</td><td>0.4</td></tr> <tr><td>20</td><td>0.25</td></tr> <tr><td>25</td><td>0.15</td></tr> <tr><td>30</td><td>0.1</td></tr> </tbody> </table>	Z Distance (mm)	SAR (mW/kg)	0	2.4	5	1.4	10	0.8	15	0.4	20	0.25	25	0.15	30	0.1
Z Distance (mm)	SAR (mW/kg)																
0	2.4																
5	1.4																
10	0.8																
15	0.4																
20	0.25																
25	0.15																
30	0.1																
SAR 1g(W/Kg)	1.104																
SAR 10g(W/Kg)	0.562																

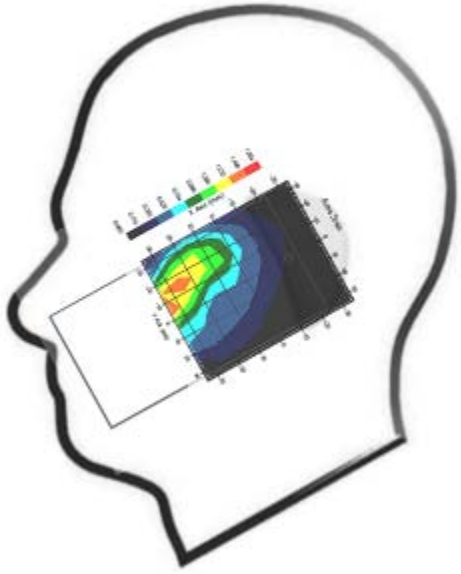
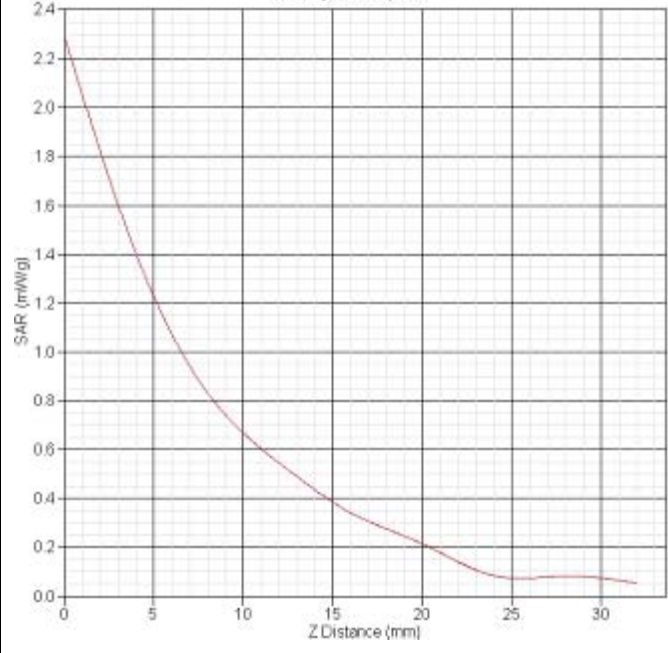
<b>GSM1900 Right cheek CH810</b>	
Frequency(MHz)	1909.8
Relative permittivity(real part)	41.54
Conductivity(S/m)	1.43
Variation(%)	-1.788
Duty Cycle Factor	8
Crest factor	8
Conversion Fator	5.7
Probe Sensitivity	1.20 1.20 1.20 $\mu V/(V/m)^2$
Data	2012-08-20
	<p>SAR-Z Axis at Hotspot x:48.10 y:-6.92</p> 
SAR 1g(W/Kg)	1.065
SAR 10g(W/Kg)	0.547

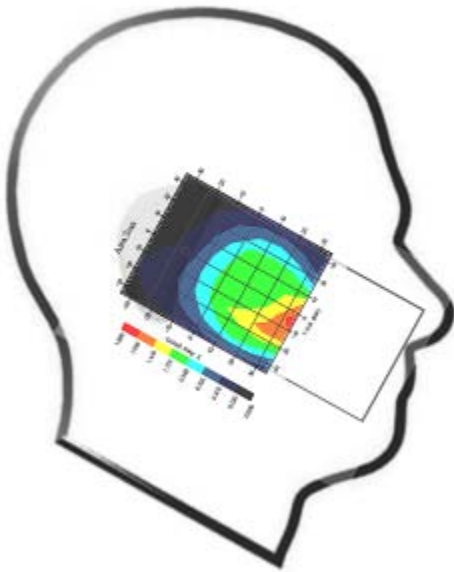
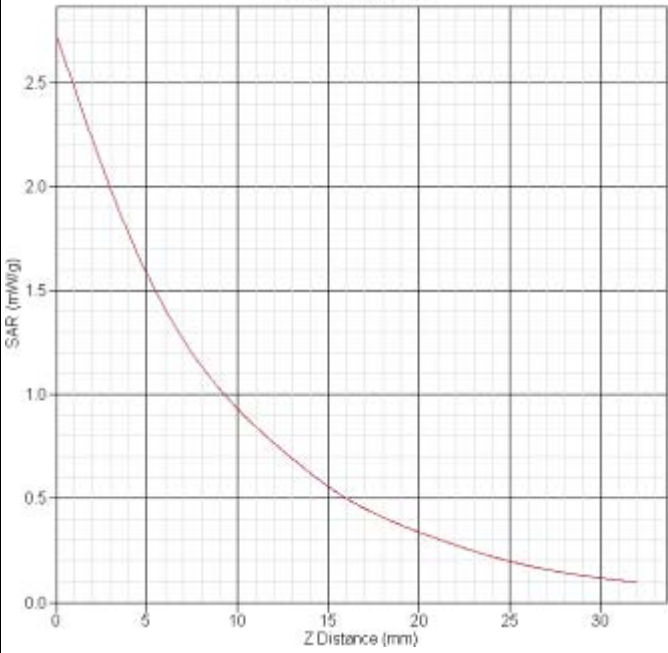
<b>WCDMA Band II Left cheek CH9400</b>	
Frequency(MHz)	1800.0
Relative permittivity(real part)	41.54
Conductivity(S/m)	1.43
Variation(%)	2.031
Duty Cycle Factor	1
Crest factor	1
Conversion Fator	5.7
Probe Sensitivity	1.20 1.20 1.20 $\mu V/(V/m)^2$
Data	2012-08-21
	<p>SAR-Z Axis at Hotspot x:46.13 y:-1.10</p> 
SAR 1g(W/Kg)	1.268
SAR 10g(W/Kg)	0.719

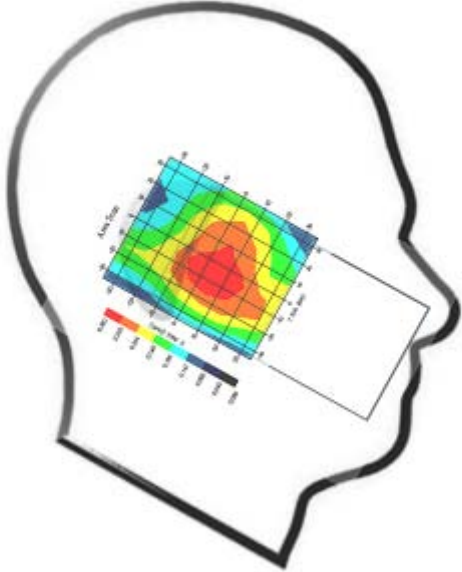
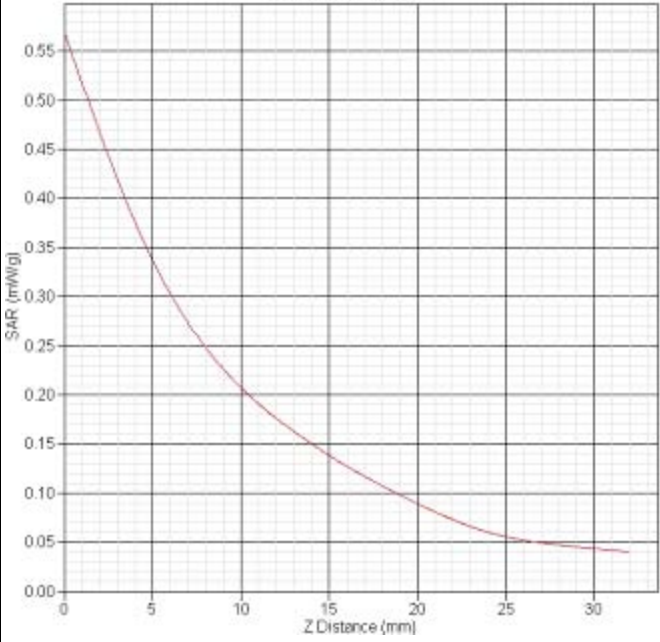
<b>WCDMA Band II Left tilt CH9400</b>																	
Frequency(MHz)	1800.0																
Relative permittivity(real part)	41.54																
Conductivity(S/m)	1.43																
Variation(%)	-1.846																
Duty Cycle Factor	1																
Crest factor	1																
Conversion Fator	5.7																
Probe Sensitivity	1.20 1.20 1.20 $\mu$ V/(V/m) <sup>2</sup>																
Data	2012-08-21																
	<p>SAR-Z AXIS at Hotspot x:20.19 y:-13.17</p>  <table border="1"> <caption>SAR-Z Axis Data</caption> <thead> <tr> <th>Z Distance (mm)</th> <th>SAR (mW/kg)</th> </tr> </thead> <tbody> <tr><td>0</td><td>0.55</td></tr> <tr><td>5</td><td>0.35</td></tr> <tr><td>10</td><td>0.22</td></tr> <tr><td>15</td><td>0.14</td></tr> <tr><td>20</td><td>0.09</td></tr> <tr><td>25</td><td>0.06</td></tr> <tr><td>30</td><td>0.04</td></tr> </tbody> </table>	Z Distance (mm)	SAR (mW/kg)	0	0.55	5	0.35	10	0.22	15	0.14	20	0.09	25	0.06	30	0.04
Z Distance (mm)	SAR (mW/kg)																
0	0.55																
5	0.35																
10	0.22																
15	0.14																
20	0.09																
25	0.06																
30	0.04																
SAR 1g(W/Kg)	0.361																
SAR 10g(W/Kg)	0.226																

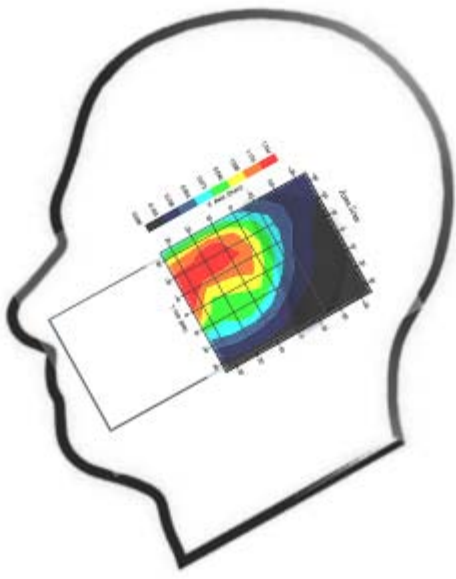
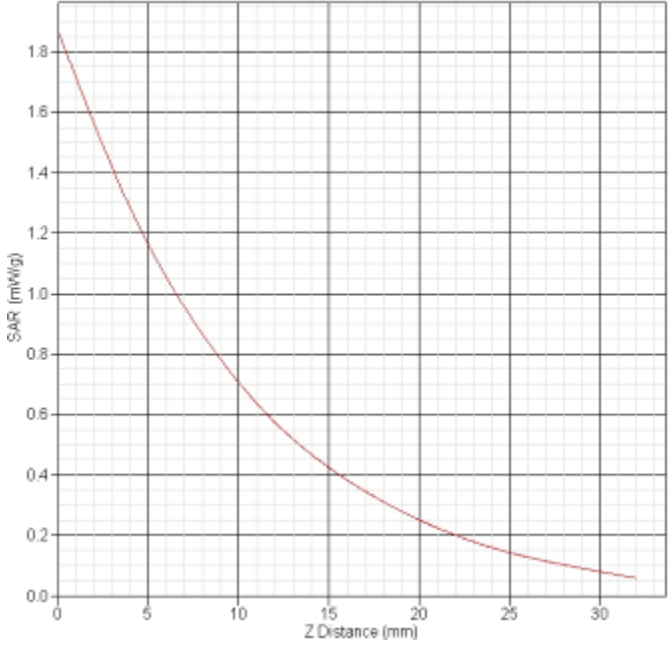
<b>WCDMA Band II Right cheek CH9400</b>	
Frequency(MHz)	1800.0
Relative permittivity(real part)	41.54
Conductivity(S/m)	1.43
Variation(%)	2.343
Duty Cycle Factor	1
Crest factor	1
Conversion Fator	5.7
Probe Sensitivity	1.20 1.20 1.20 $\mu V/(V/m)^2$
Data	2012-08-21
	<p><b>SAR-Z Axis</b> at Hotspot x:26.09 y:-20.96</p> 
SAR 1g(W/Kg)	1.248
SAR 10g(W/Kg)	0.815

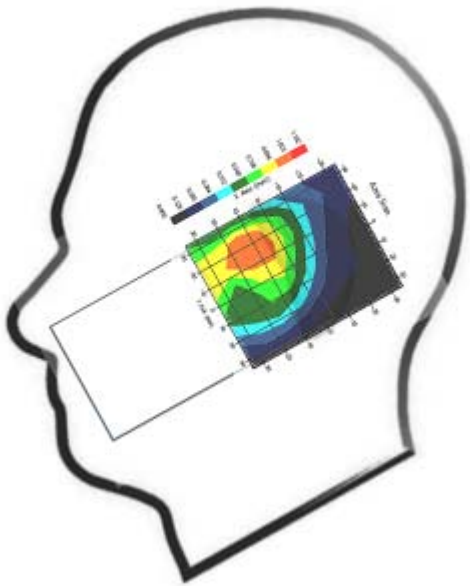
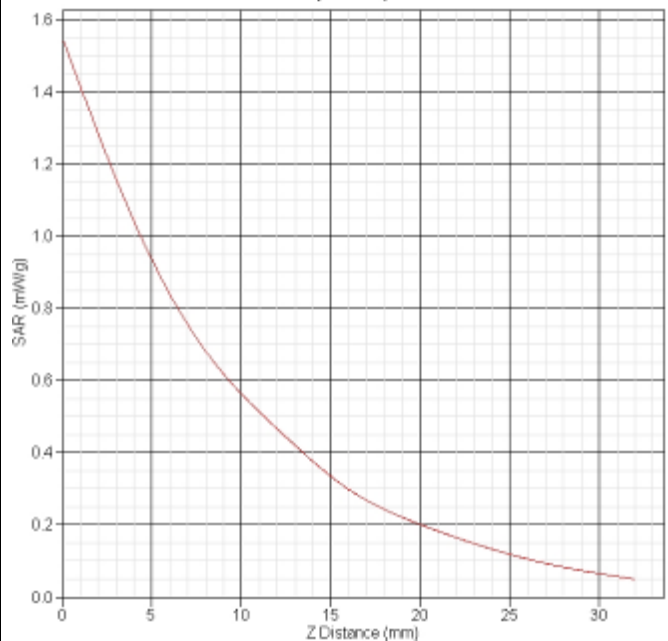
<b>WCDMA Band II Right tilt CH9400</b>	
Frequency(MHz)	1800.0
Relative permittivity(real part)	41.54
Conductivity(S/m)	1.43
Variation(%)	0.534
Duty Cycle Factor	1
Crest factor	1
Conversion Fator	5.7
Probe Sensitivity	1.20 1.20 1.20 $\mu$ V/(V/m) <sup>2</sup>
Data	2012-08-21
	<p>SAR-Z Axis at Hotspot x:30.89 y:-14.97</p> 
SAR 1g(W/Kg)	0.777
SAR 10g(W/Kg)	0.579

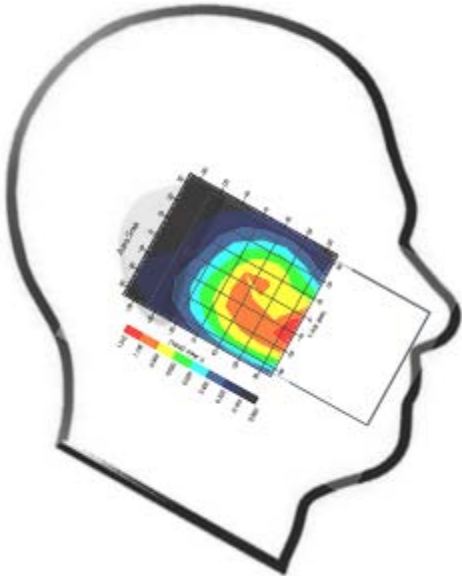
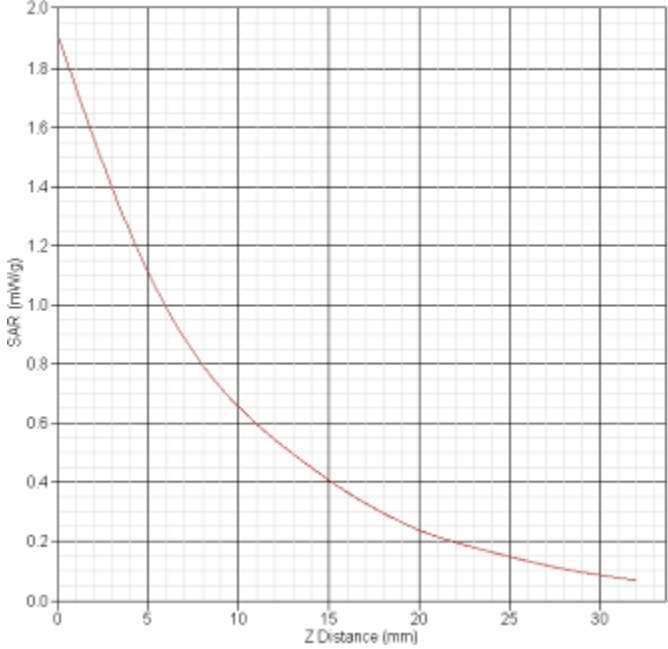
<b>WCDMA Band II Left cheek CH9262</b>																	
Frequency(MHz)	1852.4																
Relative permittivity(real part)	41.54																
Conductivity(S/m)	1.43																
Variation(%)	-2.035																
Duty Cycle Factor	1																
Crest factor	1																
Conversion Fator	5.7																
Probe Sensitivity	1.20 1.20 1.20 $\mu V/(V/m)^2$																
Data	2012-08-21																
	<p><b>SAR-Z Axis</b> at Hotspot x=6.15 y=-11.11</p>  <table border="1"> <caption>Approximate data points from the SAR-Z Axis graph</caption> <thead> <tr> <th>Z Distance (mm)</th> <th>SAR (mW/g)</th> </tr> </thead> <tbody> <tr><td>0</td><td>1.9</td></tr> <tr><td>5</td><td>1.1</td></tr> <tr><td>10</td><td>0.7</td></tr> <tr><td>15</td><td>0.45</td></tr> <tr><td>20</td><td>0.3</td></tr> <tr><td>25</td><td>0.2</td></tr> <tr><td>30</td><td>0.15</td></tr> </tbody> </table>	Z Distance (mm)	SAR (mW/g)	0	1.9	5	1.1	10	0.7	15	0.45	20	0.3	25	0.2	30	0.15
Z Distance (mm)	SAR (mW/g)																
0	1.9																
5	1.1																
10	0.7																
15	0.45																
20	0.3																
25	0.2																
30	0.15																
SAR 1g(W/Kg)	1.165																
SAR 10g(W/Kg)	0.642																

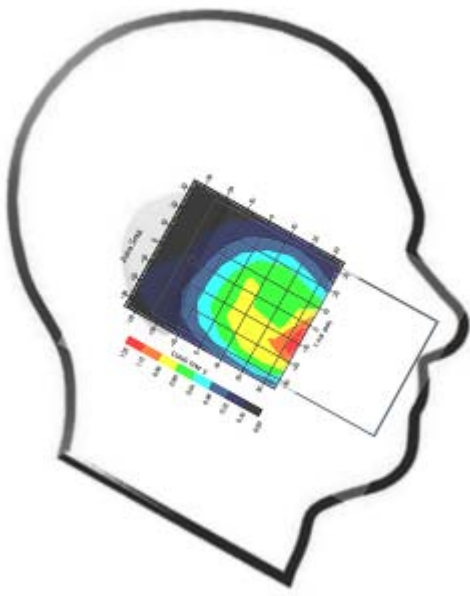
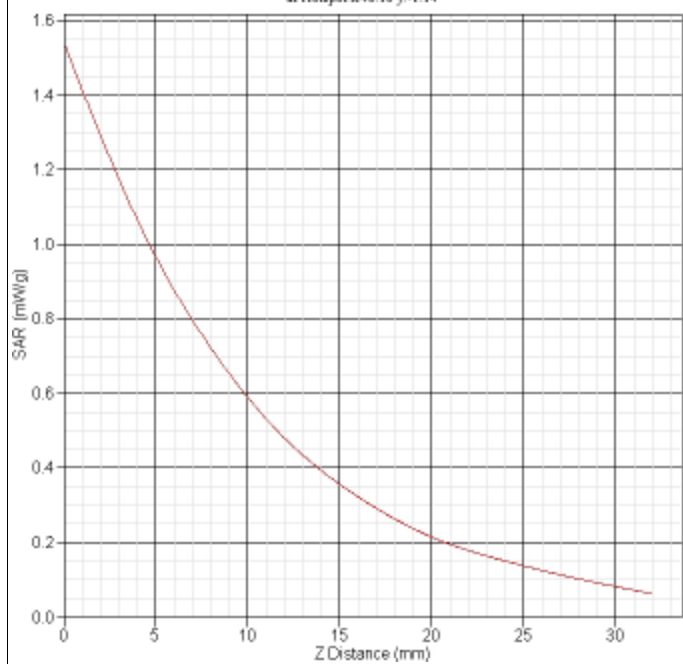

<b>WCDMA Band II Left cheek CH9538</b>																	
Frequency(MHz)	1907.6																
Relative permittivity(real part)	41.54																
Conductivity(S/m)	1.43																
Variation(%)	4.037																
Duty Cycle Factor	1																
Crest factor	1																
Conversion Fator	5.7																
Probe Sensitivity	1.20 1.20 1.20 $\mu V/(V/m)^2$																
Data	2012-08-21																
	<p><b>SAR-Z Axis</b> at Hotspot x:46.16 y:-1.14</p>  <table border="1"> <caption>SAR-Z Axis Data</caption> <thead> <tr> <th>Z Distance (mm)</th> <th>SAR (mW/kg)</th> </tr> </thead> <tbody> <tr><td>0</td><td>1.5</td></tr> <tr><td>5</td><td>1.0</td></tr> <tr><td>10</td><td>0.6</td></tr> <tr><td>15</td><td>0.4</td></tr> <tr><td>20</td><td>0.25</td></tr> <tr><td>25</td><td>0.18</td></tr> <tr><td>30</td><td>0.12</td></tr> </tbody> </table>	Z Distance (mm)	SAR (mW/kg)	0	1.5	5	1.0	10	0.6	15	0.4	20	0.25	25	0.18	30	0.12
Z Distance (mm)	SAR (mW/kg)																
0	1.5																
5	1.0																
10	0.6																
15	0.4																
20	0.25																
25	0.18																
30	0.12																
SAR 1g(W/Kg)	0.912																
SAR 10g(W/Kg)	0.460																

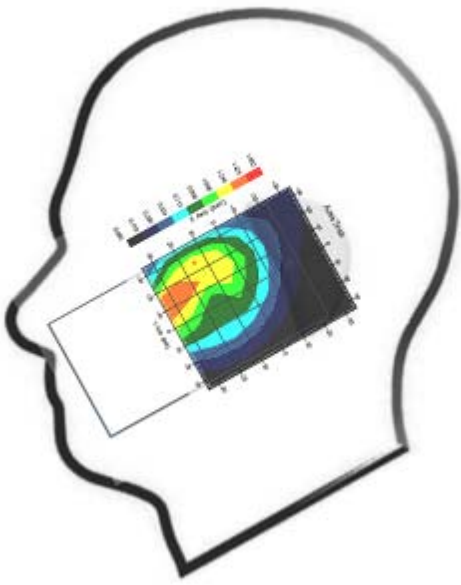
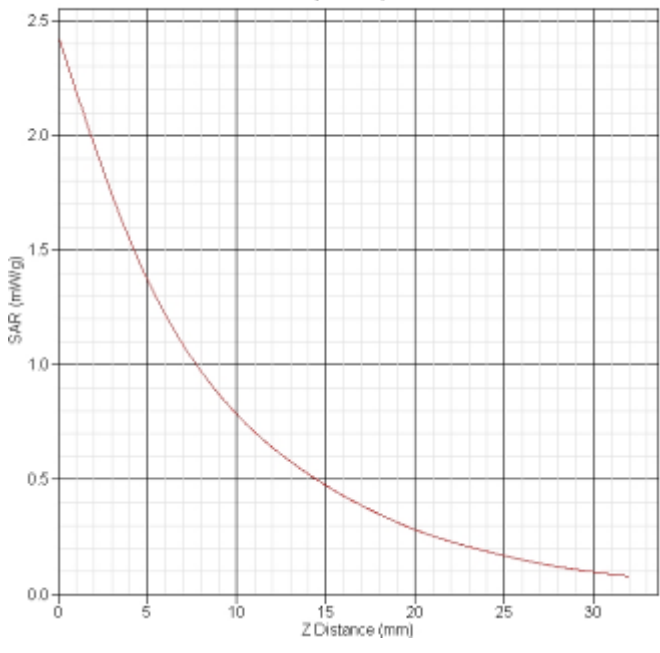
<b>WCDMA Band II Right cheek CH9262</b>																	
Frequency(MHz)	1852.4																
Relative permittivity(real part)	41.54																
Conductivity(S/m)	1.43																
Variation(%)	0.958																
Duty Cycle Factor	1																
Crest factor	1																
Conversion Fator	5.7																
Probe Sensitivity	1.20 1.20 1.20 $\mu V/(V/m)^2$																
Data	2012-08-21																
	<p>SAR-Z Axis at Hotspot x:48.06 y:-6.99</p>  <table border="1"> <caption>SAR-Z Axis Data Points (Estimated)</caption> <thead> <tr> <th>Z Distance (mm)</th> <th>SAR (mW/kg)</th> </tr> </thead> <tbody> <tr><td>0</td><td>2.4</td></tr> <tr><td>5</td><td>1.4</td></tr> <tr><td>10</td><td>0.8</td></tr> <tr><td>15</td><td>0.5</td></tr> <tr><td>20</td><td>0.3</td></tr> <tr><td>25</td><td>0.2</td></tr> <tr><td>30</td><td>0.1</td></tr> </tbody> </table>	Z Distance (mm)	SAR (mW/kg)	0	2.4	5	1.4	10	0.8	15	0.5	20	0.3	25	0.2	30	0.1
Z Distance (mm)	SAR (mW/kg)																
0	2.4																
5	1.4																
10	0.8																
15	0.5																
20	0.3																
25	0.2																
30	0.1																
SAR 1g(W/Kg)	1.233																
SAR 10g(W/Kg)	0.660																

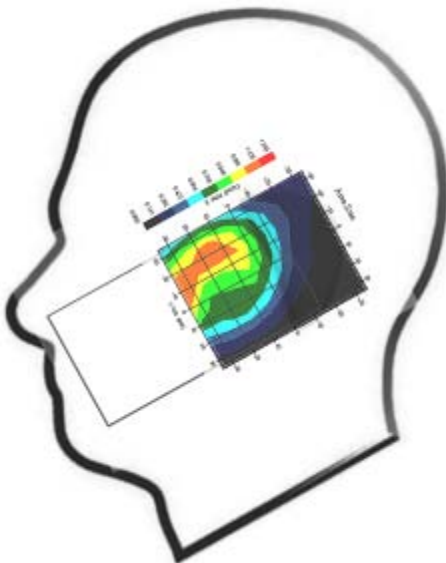
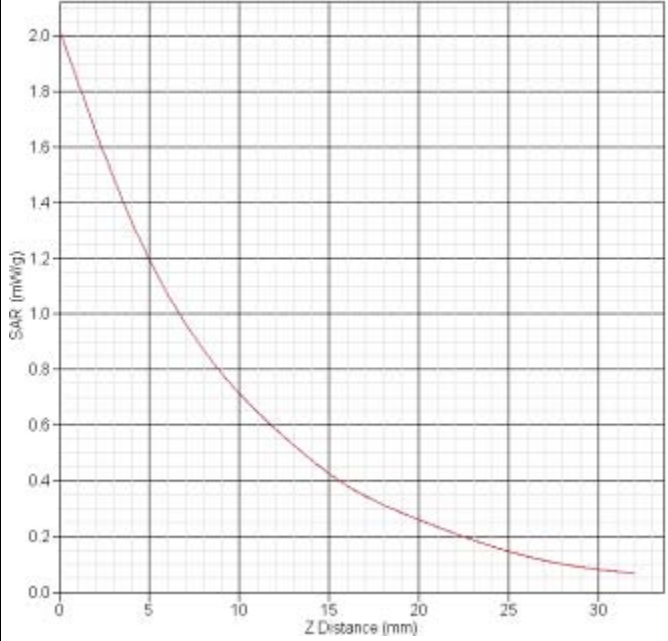
<b>WCDMA Band II Right cheek CH9538</b>	
Frequency(MHz)	1907.6
Relative permittivity(real part)	41.54
Conductivity(S/m)	1.43
Variation(%)	-1.297
Duty Cycle Factor	1
Crest factor	1
Conversion Fator	5.7
Probe Sensitivity	1.20 1.20 1.20 $\mu$ V/(V/m) <sup>2</sup>
Data	2012-08-21
	<p>SAR-Z Axis at Hotspot z46.13 y-8.96</p> 
SAR 1g(W/Kg)	0.923
SAR 10g(W/Kg)	0.725

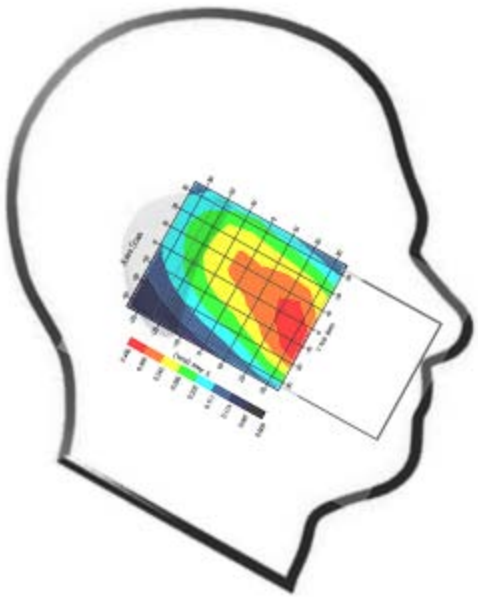
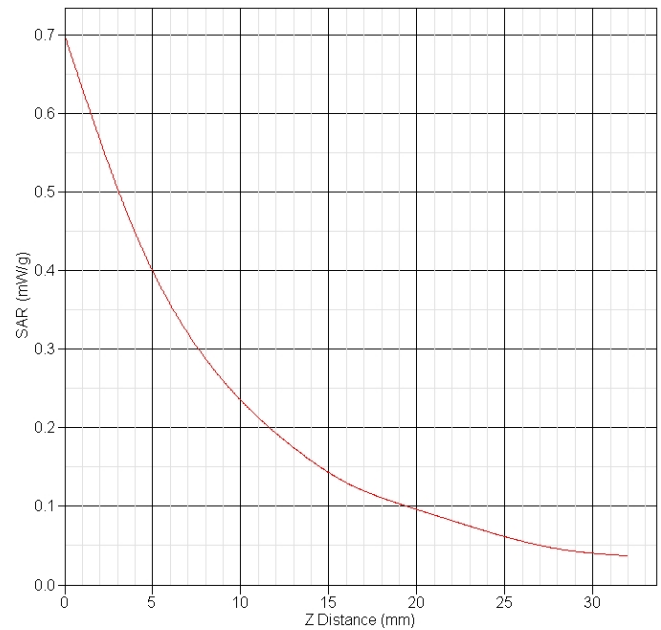
<b>WCDMA Band V Left cheek CH4183</b>																	
Frequency(MHz)	836.6																
Relative permittivity(real part)	40.24																
Conductivity(S/m)	0.91																
Variation(%)	-0.455																
Duty Cycle Factor	1																
Crest factor	1																
Conversion Fator	6.5																
Probe Sensitivity	1.20 1.20 1.20 $\mu V/(V/m)^2$																
Data	2012-08-20																
	<p>SAR-Z Axis at Hotspot x:48.18 y:-13.17</p>  <table border="1"> <caption>SAR-Z Axis Data</caption> <thead> <tr> <th>Z Distance (mm)</th> <th>SAR (mW/g)</th> </tr> </thead> <tbody> <tr><td>0</td><td>0.70</td></tr> <tr><td>5</td><td>0.40</td></tr> <tr><td>10</td><td>0.25</td></tr> <tr><td>15</td><td>0.15</td></tr> <tr><td>20</td><td>0.10</td></tr> <tr><td>25</td><td>0.07</td></tr> <tr><td>30</td><td>0.05</td></tr> </tbody> </table>	Z Distance (mm)	SAR (mW/g)	0	0.70	5	0.40	10	0.25	15	0.15	20	0.10	25	0.07	30	0.05
Z Distance (mm)	SAR (mW/g)																
0	0.70																
5	0.40																
10	0.25																
15	0.15																
20	0.10																
25	0.07																
30	0.05																
SAR 1g(W/Kg)	0.420																
SAR 10g(W/Kg)	0.245																

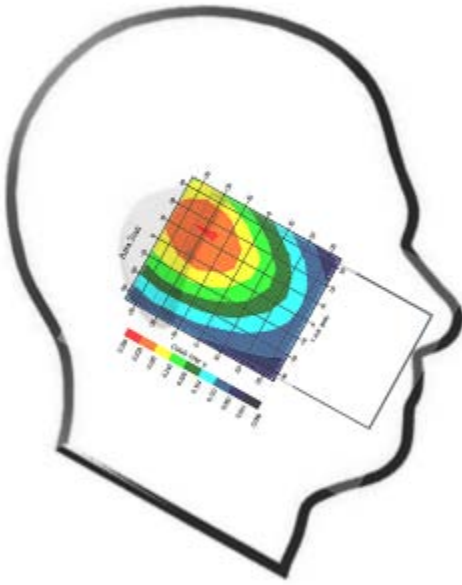
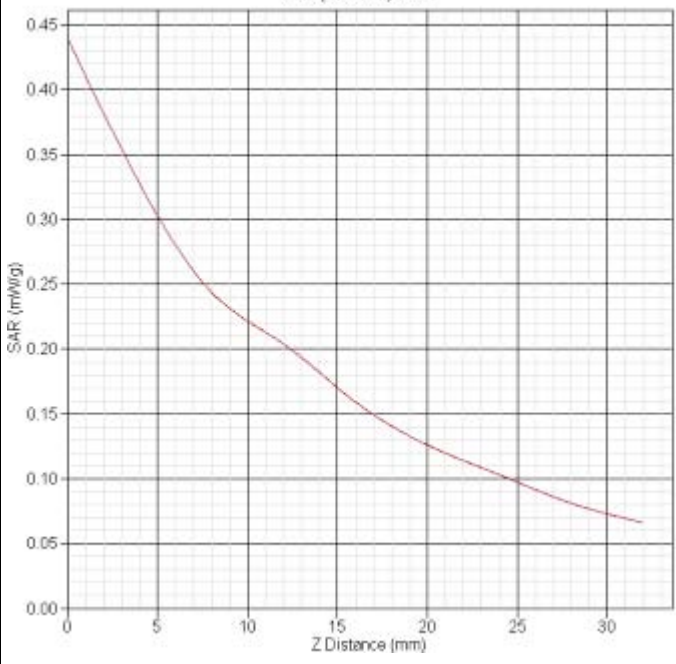
<b>WCDMA Band V Left tilt CH4183</b>	
Frequency(MHz)	836.6
Relative permittivity(real part)	40.24
Conductivity(S/m)	0.91
Variation(%)	-3.363
Duty Cycle Factor	1
Crest factor	1
Conversion Fator	6.5
Probe Sensitivity	1.20 1.20 1.20 $\mu V/(V/m)^2$
Data	2012-08-20
	<p>SAR-Z Axis at Hotspot of x:-7.86 y:14.98</p> 
SAR 1g(W/Kg)	0.315
SAR 10g(W/Kg)	0.223

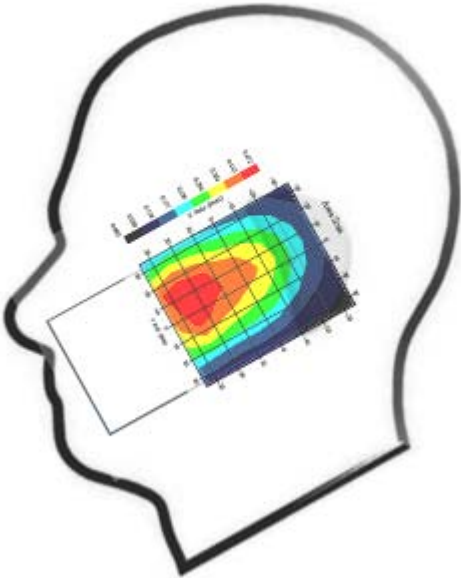
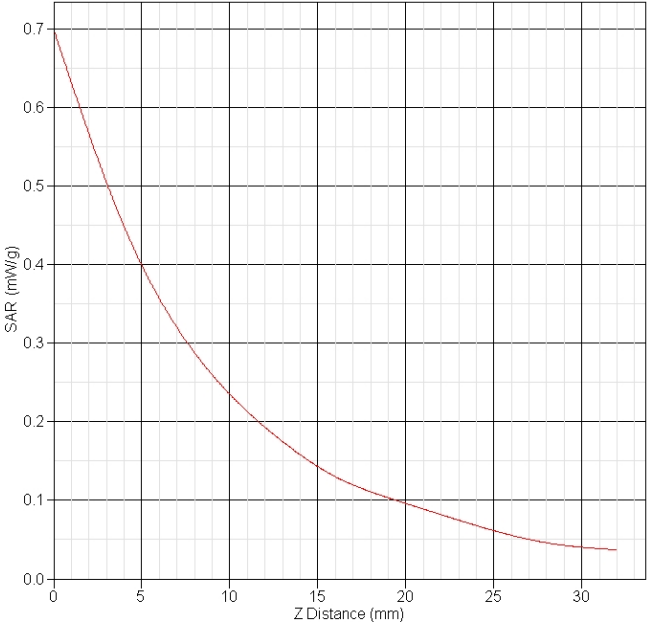
<b>WCDMA Band V Right cheek CH4183</b>	
Frequency(MHz)	836.6
Relative permittivity(real part)	40.24
Conductivity(S/m)	0.91
Variation(%)	-0.846
Duty Cycle Factor	1
Crest factor	1
Conversion Fator	6.5
Probe Sensitivity	1.20 1.20 1.20 $\mu V/(V/m)^2$
Data	2012-08-20
	<p>SAR-Z Axis at Hotspot x:48.18 y:-13.17</p> 
SAR 1g(W/Kg)	0.414
SAR 10g(W/Kg)	0.239

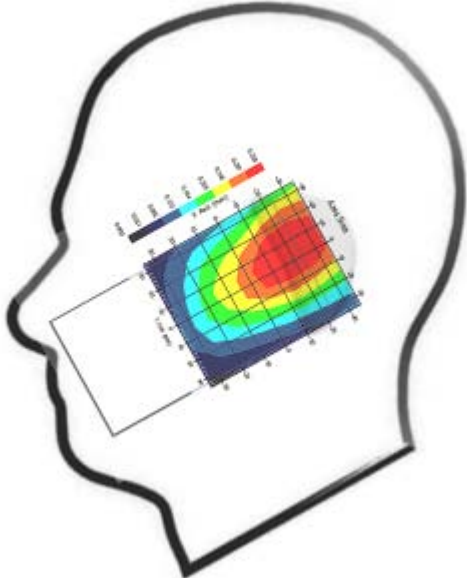
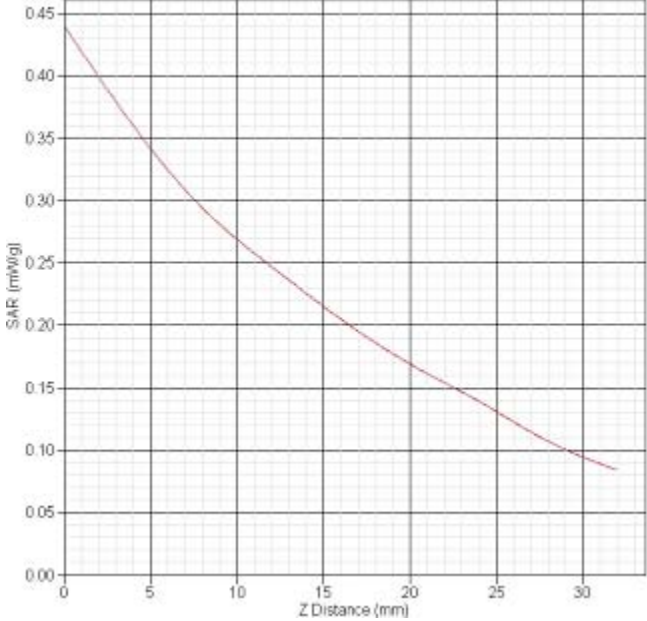
<b>WCDMA Band V Right tilt CH4183</b>																	
Frequency(MHz)	836.6																
Relative permittivity(real part)	40.24																
Conductivity(S/m)	0.91																
Variation(%)	1.466																
Duty Cycle Factor	1																
Crest factor	1																
Conversion Fator	6.5																
Probe Sensitivity	1.20 1.20 1.20 $\mu V/(V/m)^2$																
Data	2012-08-20																
	<p>SAR-Z Axis at Hotspot x: 30.09 y: -4.97</p>  <table border="1"> <caption>SAR-Z Axis Data</caption> <thead> <tr> <th>Z Distance (mm)</th> <th>SAR (mW/kg)</th> </tr> </thead> <tbody> <tr><td>0</td><td>0.44</td></tr> <tr><td>5</td><td>0.35</td></tr> <tr><td>10</td><td>0.27</td></tr> <tr><td>15</td><td>0.21</td></tr> <tr><td>20</td><td>0.16</td></tr> <tr><td>25</td><td>0.12</td></tr> <tr><td>30</td><td>0.09</td></tr> </tbody> </table>	Z Distance (mm)	SAR (mW/kg)	0	0.44	5	0.35	10	0.27	15	0.21	20	0.16	25	0.12	30	0.09
Z Distance (mm)	SAR (mW/kg)																
0	0.44																
5	0.35																
10	0.27																
15	0.21																
20	0.16																
25	0.12																
30	0.09																
SAR 1g(W/Kg)	0.321																
SAR 10g(W/Kg)	0.227																

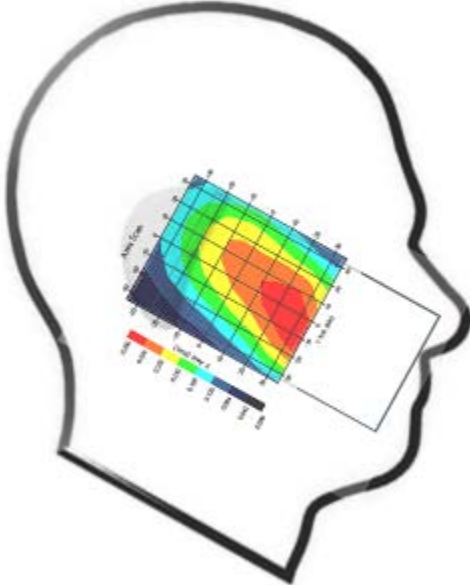
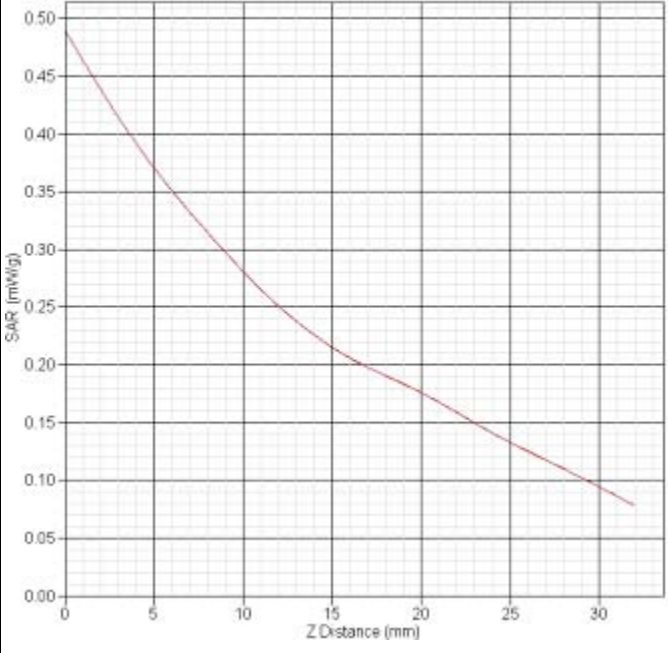
<b>WCDMA Band V Left cheek CH4132</b>	
Frequency(MHz)	826.4
Relative permittivity(real part)	40.24
Conductivity(S/m)	0.91
Variation(%)	-0.691
Duty Cycle Factor	1
Crest factor	1
Conversion Fator	6.5
Probe Sensitivity	1.20 1.20 1.20 $\mu V/(V/m)^2$
Data	2012-08-20
	<p><b>SAR-Z Axis</b> at Hotspot x:30.11 y:4.93</p> 
SAR 1g(W/Kg)	0.316
SAR 10g(W/Kg)	0.189

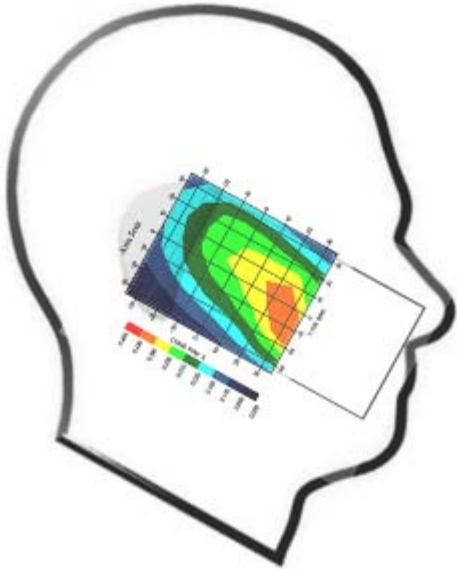
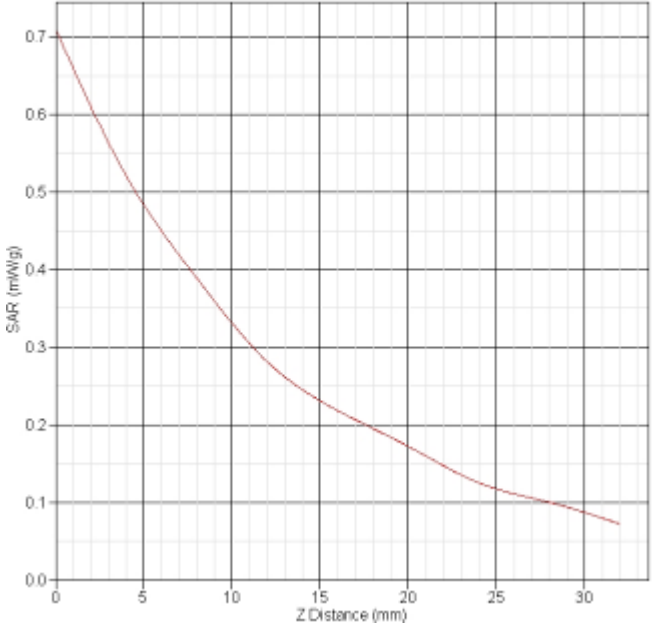

<b>WCDMA Band V Left cheek CH4233</b>																			
Frequency(MHz)	846.6																		
Relative permittivity(real part)	40.24																		
Conductivity(S/m)	0.91																		
Variation(%)	-0.771																		
Duty Cycle Factor	1																		
Crest factor	1																		
Conversion Fator	6.5																		
Probe Sensitivity	1.20 1.20 1.20 $\mu V/(V/m)^2$																		
Data	2012-08-20																		
	<p>SAR-Z Axis at Hotspot x:8.89 y:-12.97</p>  <table border="1"> <caption>SAR vs Z Distance Data</caption> <thead> <tr> <th>Z Distance (mm)</th> <th>SAR (mW/kg)</th> </tr> </thead> <tbody> <tr><td>0</td><td>0.70</td></tr> <tr><td>5</td><td>0.48</td></tr> <tr><td>10</td><td>0.32</td></tr> <tr><td>15</td><td>0.23</td></tr> <tr><td>20</td><td>0.17</td></tr> <tr><td>25</td><td>0.12</td></tr> <tr><td>30</td><td>0.09</td></tr> <tr><td>32</td><td>0.08</td></tr> </tbody> </table>	Z Distance (mm)	SAR (mW/kg)	0	0.70	5	0.48	10	0.32	15	0.23	20	0.17	25	0.12	30	0.09	32	0.08
Z Distance (mm)	SAR (mW/kg)																		
0	0.70																		
5	0.48																		
10	0.32																		
15	0.23																		
20	0.17																		
25	0.12																		
30	0.09																		
32	0.08																		
SAR 1g(W/Kg)	0.411																		
SAR 10g(W/Kg)	0.239																		

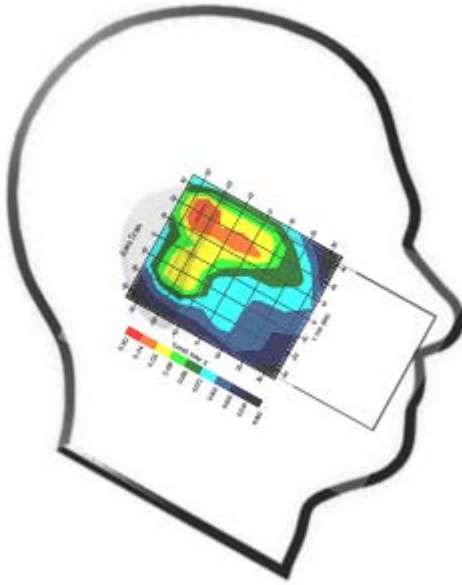
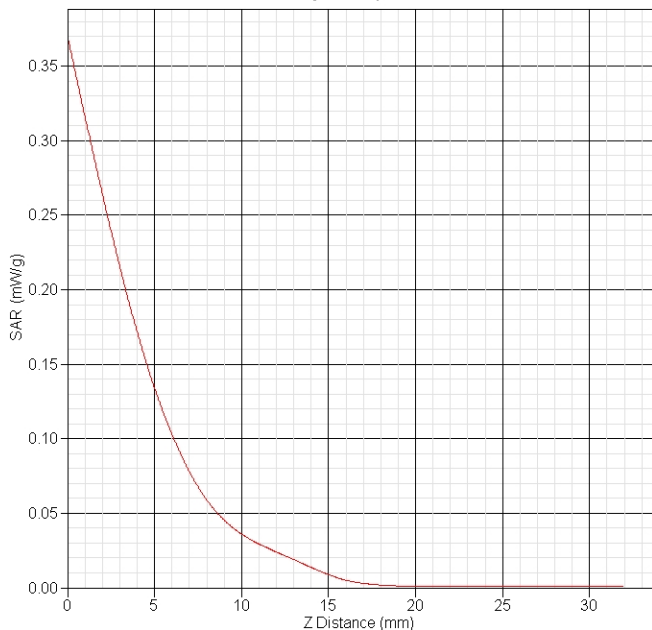
<b>802.11b Left cheek CH1</b>																	
Frequency(MHz)	2412																
Relative permittivity(real part)	40.31																
Conductivity(S/m)	1.81																
Variation(%)	2.997																
Duty Cycle Factor	1																
Crest factor	1																
Conversion Fator	4.65																
Probe Sensitivity	1.20 1.20 1.20 $\mu V/(V/m)^2$																
Data	2012-08-21																
	<p>SAR-Z Axis at Hotspot x=-5.85 y=22.88</p>  <table border="1"> <caption>SAR-Z Axis Data</caption> <thead> <tr> <th>Z Distance (mm)</th> <th>SAR (mW/g)</th> </tr> </thead> <tbody> <tr><td>0</td><td>0.35</td></tr> <tr><td>5</td><td>0.15</td></tr> <tr><td>10</td><td>0.05</td></tr> <tr><td>15</td><td>0.01</td></tr> <tr><td>20</td><td>0.00</td></tr> <tr><td>25</td><td>0.00</td></tr> <tr><td>30</td><td>0.00</td></tr> </tbody> </table>	Z Distance (mm)	SAR (mW/g)	0	0.35	5	0.15	10	0.05	15	0.01	20	0.00	25	0.00	30	0.00
Z Distance (mm)	SAR (mW/g)																
0	0.35																
5	0.15																
10	0.05																
15	0.01																
20	0.00																
25	0.00																
30	0.00																
SAR 1g(W/Kg)	0.168																
SAR 10g(W/Kg)	0.076																

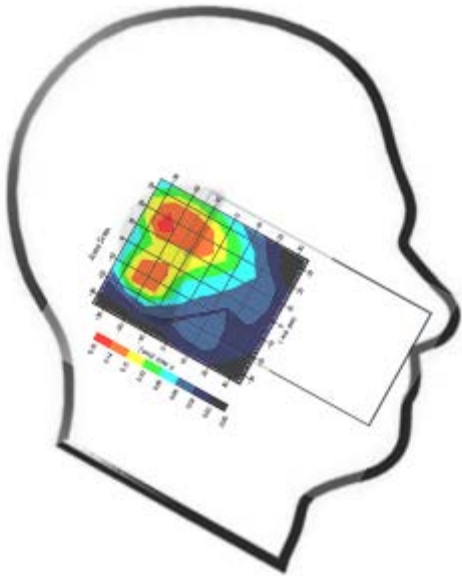
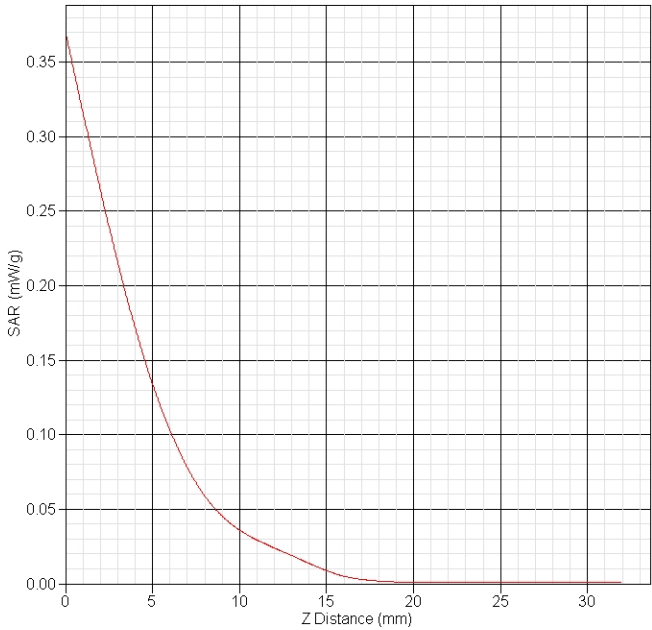
<b>802.11b Left tilt CH1</b>	
Frequency(MHz)	2412
Relative permittivity(real part)	40.31
Conductivity(S/m)	1.81
Variation(%)	-1.319
Duty Cycle Factor	1
Crest factor	1
Conversion Fator	4.65
Probe Sensitivity	1.20 1.20 1.20 $\mu V/(V/m)^2$
Data	2012-08-21
	<p>SAR-Z Axis at Hotspot x:-5.85 y:22.88</p> 
SAR 1g(W/Kg)	0.184
SAR 10g(W/Kg)	0.083

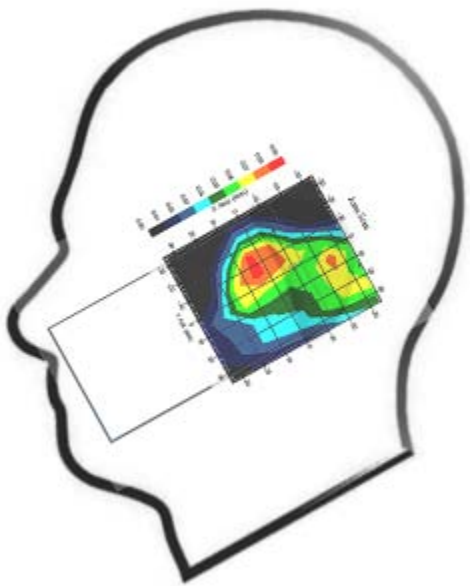
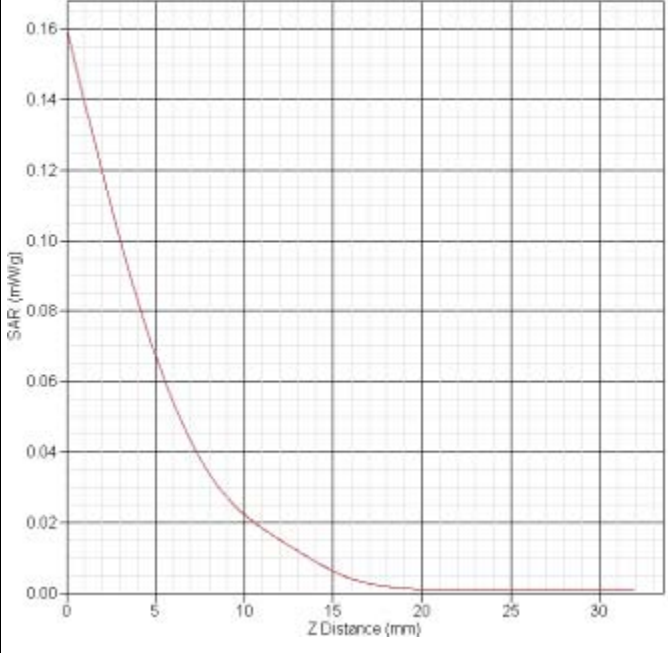
<b>802.11b Right cheek CH1</b>	
Frequency(MHz)	2412
Relative permittivity(real part)	40.31
Conductivity(S/m)	1.81
Variation(%)	2.842
Duty Cycle Factor	1
Crest factor	1
Conversion Fator	4.65
Probe Sensitivity	1.20 1.20 1.20 $\mu V/(V/m)^2$
Data	2012-08-21
	<p>SAR-Z AXIS at Hotspot x:20.08 y:-4.98</p> 
SAR 1g(W/Kg)	0.079
SAR 10g(W/Kg)	0.035

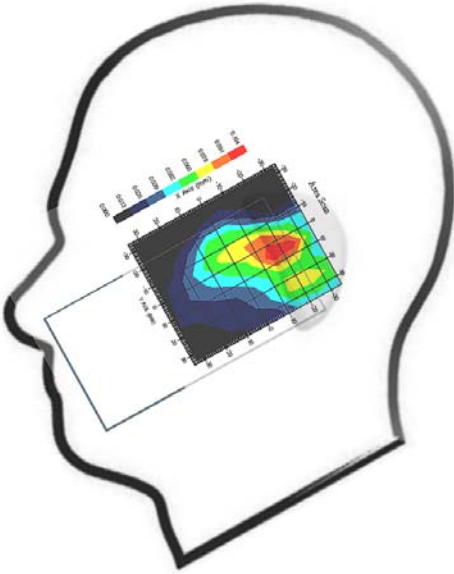
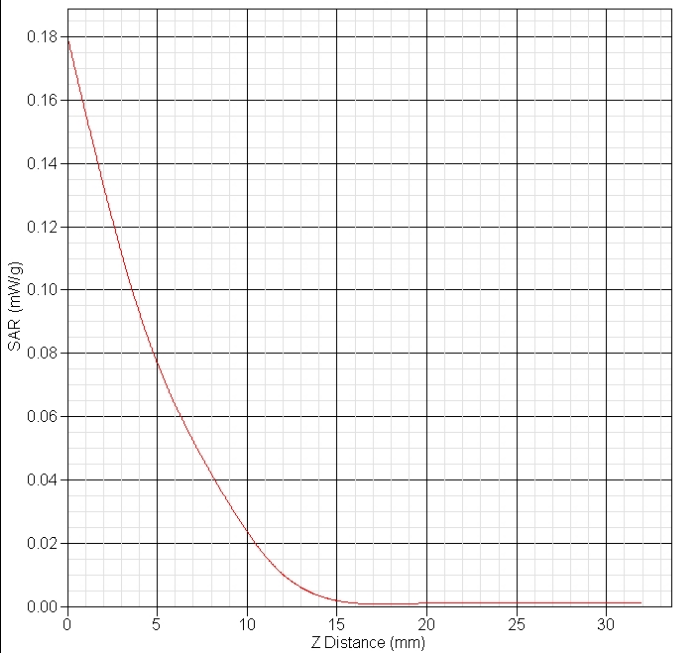
<b>802.11b Right tilt CH1</b>	
Frequency(MHz)	2412
Relative permittivity(real part)	40.31
Conductivity(S/m)	1.81
Variation(%)	2.513
Duty Cycle Factor	1
Crest factor	1
Conversion Fator	4.65
Probe Sensitivity	1.20 1.20 1.20 $\mu V/(V/m)^2$
Data	2012-08-21
	<p>SAR-Z Axis at Hotspot x:0.06 y:-3.00</p> 
SAR 1g(W/Kg)	0.091
SAR 10g(W/Kg)	0.040

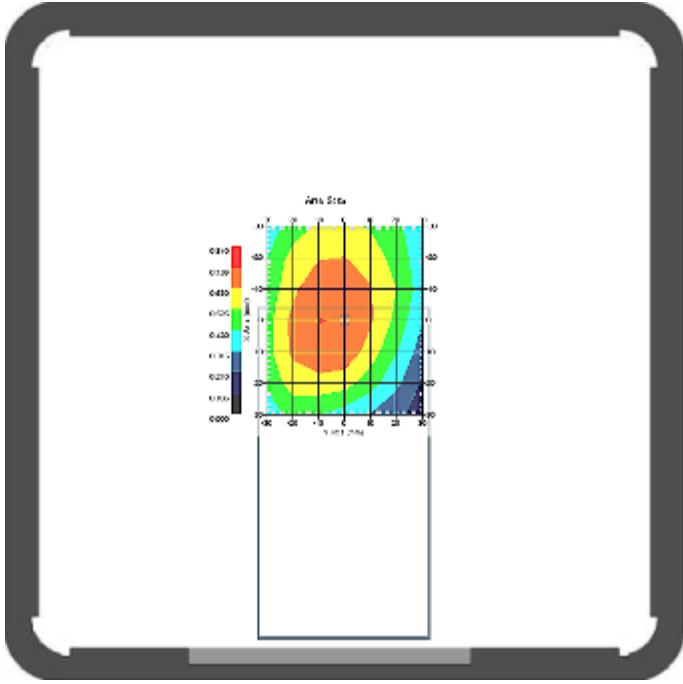
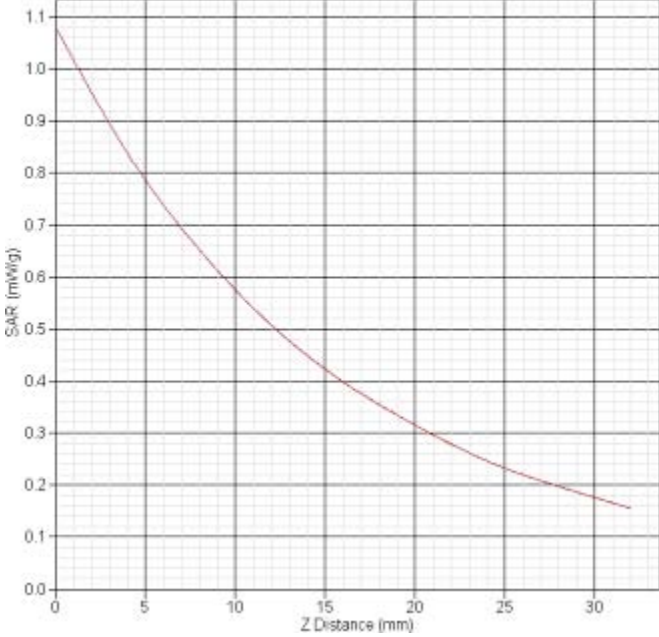
<b>GPRS850 body Front CH251(Hotspot)</b>																			
Frequency(MHz)	848.8																		
Relative permittivity(real part)	53.31																		
Conductivity(S/m)	0.94																		
Variation(%)	1.740																		
Duty Cycle Factor	2																		
Crest factor	2																		
Conversion Fator	6.4																		
Probe Sensitivity	1.20 1.20 1.20 $\mu V/(V/m)^2$																		
Data	2012-08-22																		
	<p>SAR-Z Axis at Hotspot x: 7.83 y: 9.86</p>  <table border="1"> <caption>SAR-Z Axis Data</caption> <thead> <tr> <th>Z Distance (mm)</th> <th>SAR (mW/kg)</th> </tr> </thead> <tbody> <tr><td>0</td><td>1.08</td></tr> <tr><td>5</td><td>0.80</td></tr> <tr><td>10</td><td>0.60</td></tr> <tr><td>15</td><td>0.45</td></tr> <tr><td>20</td><td>0.32</td></tr> <tr><td>25</td><td>0.22</td></tr> <tr><td>30</td><td>0.16</td></tr> <tr><td>32</td><td>0.15</td></tr> </tbody> </table>	Z Distance (mm)	SAR (mW/kg)	0	1.08	5	0.80	10	0.60	15	0.45	20	0.32	25	0.22	30	0.16	32	0.15
Z Distance (mm)	SAR (mW/kg)																		
0	1.08																		
5	0.80																		
10	0.60																		
15	0.45																		
20	0.32																		
25	0.22																		
30	0.16																		
32	0.15																		
SAR 1g(W/Kg)	0.696																		
SAR 10g(W/Kg)	0.491																		

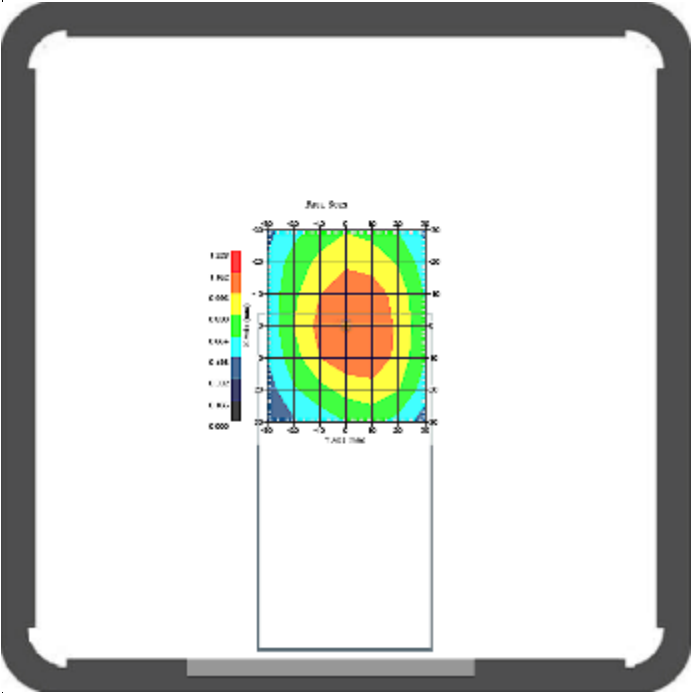
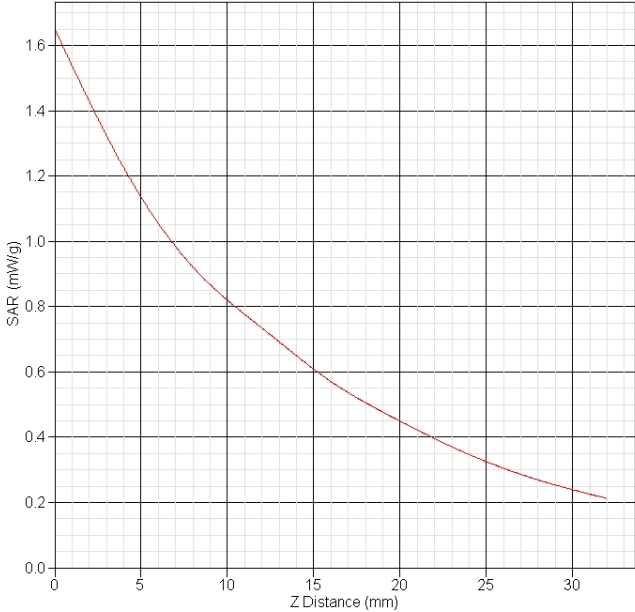
<b>GPRS850 body Back CH128(Hotspot)</b>	
Frequency(MHz)	824.2
Relative permittivity(real part)	53.31
Conductivity(S/m)	0.94
Variation(%)	-2.496
Duty Cycle Factor	2
Crest factor	2
Conversion Fator	6.4
Probe Sensitivity	1.20 1.20 1.20 $\mu V/(V/m)^2$
Data	2012-08-22
	<p>SAR-Z Axis at Hotspot x:-9.94 y:-10.14</p> 
SAR 1g(W/Kg)	1.097
SAR 10g(W/Kg)	0.739

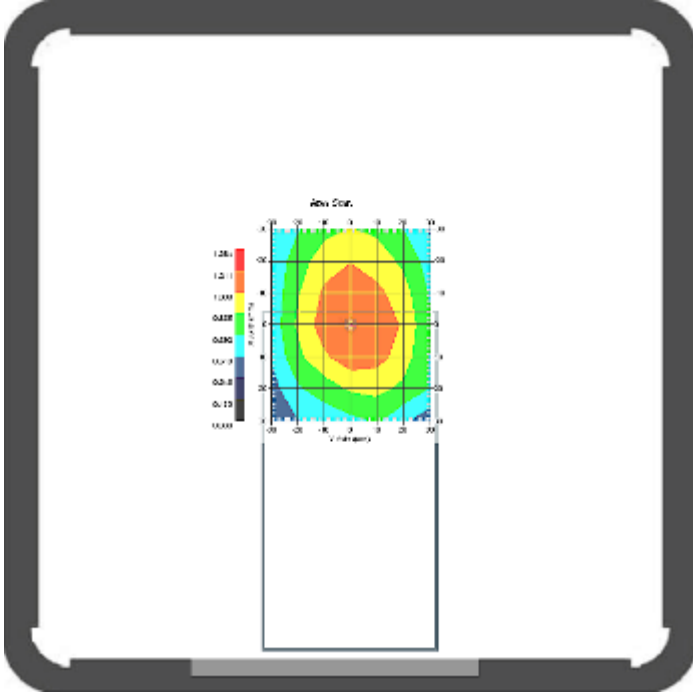
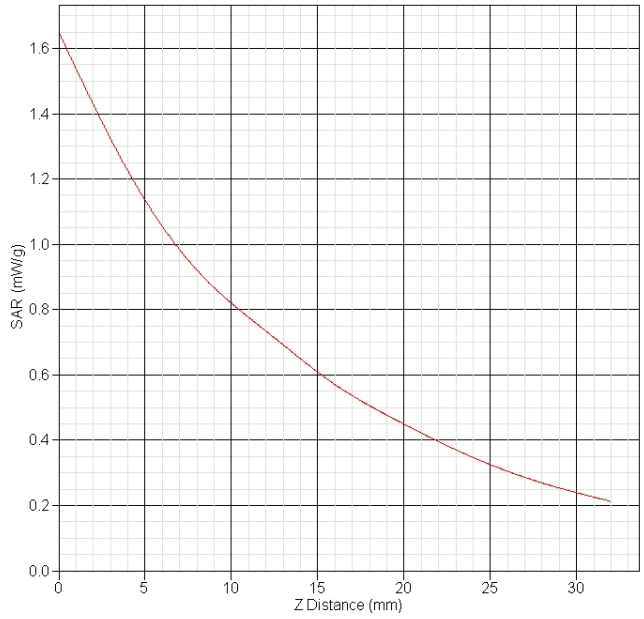
<b>GPRS850 body Back CH190(Hotspot)</b>																	
Frequency(MHz)	836.6																
Relative permittivity(real part)	53.31																
Conductivity(S/m)	0.94																
Variation(%)	-1.991																
Duty Cycle Factor	2																
Crest factor	2																
Conversion Fator	6.4																
Probe Sensitivity	1.20 1.20 1.20 $\mu V/(V/m)^2$																
Data	2012-08-22																
	<p>SAR-Z Axis at Hotspot x:-9.94 y:-10.14</p>  <table border="1"> <caption>SAR-Z Axis Data</caption> <thead> <tr> <th>Z Distance (mm)</th> <th>SAR (mW/kg)</th> </tr> </thead> <tbody> <tr><td>0</td><td>1.6</td></tr> <tr><td>5</td><td>1.1</td></tr> <tr><td>10</td><td>0.8</td></tr> <tr><td>15</td><td>0.6</td></tr> <tr><td>20</td><td>0.45</td></tr> <tr><td>25</td><td>0.35</td></tr> <tr><td>30</td><td>0.25</td></tr> </tbody> </table>	Z Distance (mm)	SAR (mW/kg)	0	1.6	5	1.1	10	0.8	15	0.6	20	0.45	25	0.35	30	0.25
Z Distance (mm)	SAR (mW/kg)																
0	1.6																
5	1.1																
10	0.8																
15	0.6																
20	0.45																
25	0.35																
30	0.25																
SAR 1g(W/Kg)	1.137																
SAR 10g(W/Kg)	0.803																

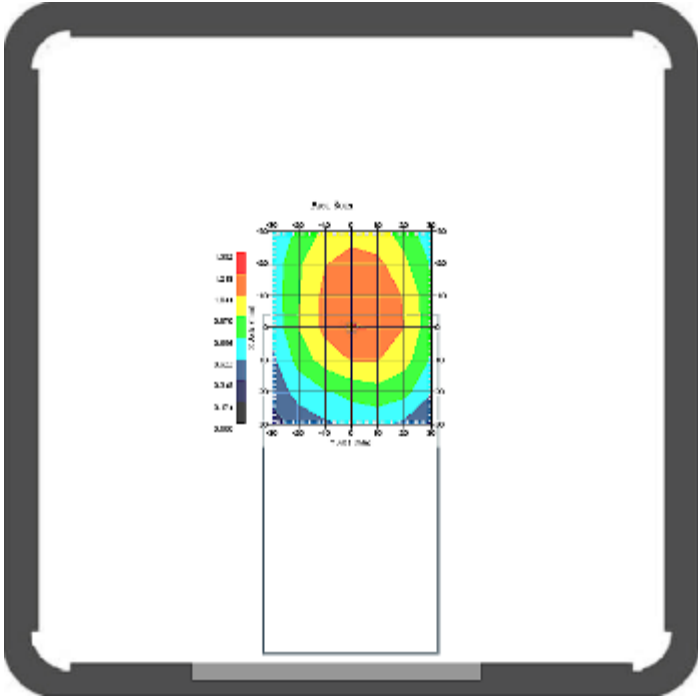
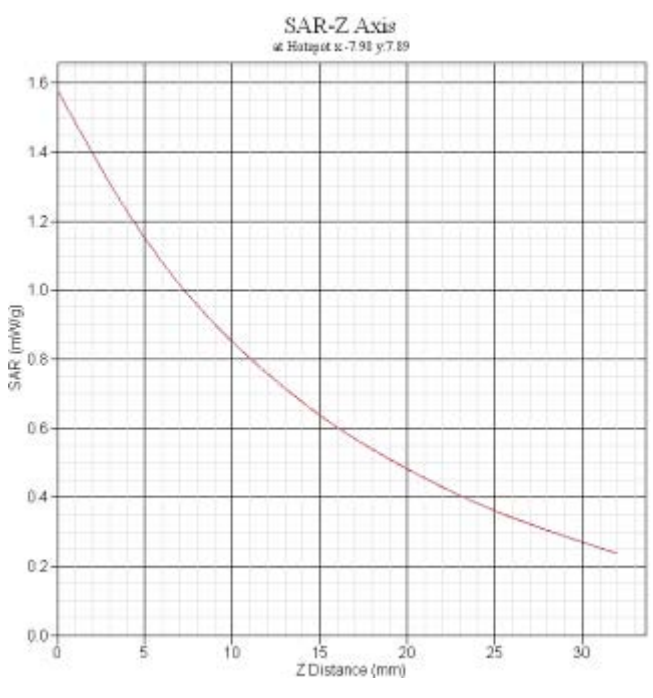

<b>GPRS850 body Back CH251(Hotspot)</b>	
Frequency(MHz)	836.6
Relative permittivity(real part)	53.31
Conductivity(S/m)	0.94
Variation(%)	-1.773
Duty Cycle Factor	2
Crest factor	2
Conversion Fator	6.4
Probe Sensitivity	1.20 1.20 1.20 $\mu V/(V/m)^2$
Data	2012-08-22
	
SAR 1g(W/Kg)	1.169
SAR 10g(W/Kg)	0.803

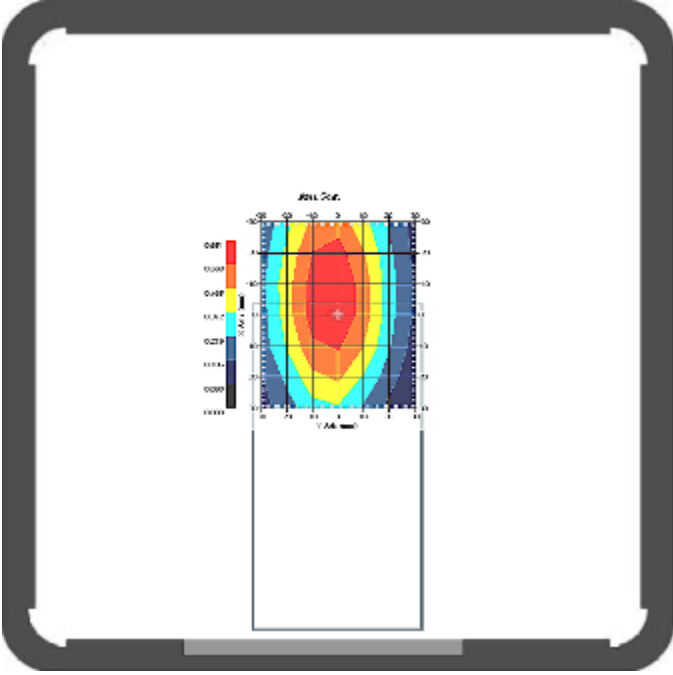
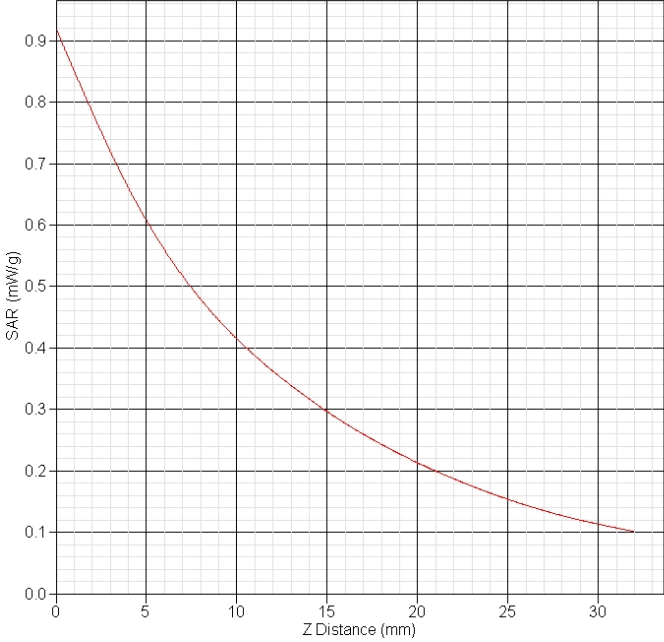
<b>GPRS850 body left CH251(Hotspot)</b>																	
Frequency(MHz)	848.8																
Relative permittivity(real part)	53.31																
Conductivity(S/m)	0.94																
Variation(%)	0.436																
Duty Cycle Factor	2																
Crest factor	2																
Conversion Fator	6.4																
Probe Sensitivity	1.20 1.20 1.20 $\mu V/(V/m)^2$																
Data	2012-08-22																
	<p>SAR-Z Axis at Hotspot x:-1.95 y:-0.14</p>  <table border="1"> <caption>SAR-Z Axis Data</caption> <thead> <tr> <th>Z Distance (mm)</th> <th>SAR (mW/kg)</th> </tr> </thead> <tbody> <tr><td>0</td><td>0.9</td></tr> <tr><td>5</td><td>0.6</td></tr> <tr><td>10</td><td>0.4</td></tr> <tr><td>15</td><td>0.3</td></tr> <tr><td>20</td><td>0.2</td></tr> <tr><td>25</td><td>0.15</td></tr> <tr><td>30</td><td>0.1</td></tr> </tbody> </table>	Z Distance (mm)	SAR (mW/kg)	0	0.9	5	0.6	10	0.4	15	0.3	20	0.2	25	0.15	30	0.1
Z Distance (mm)	SAR (mW/kg)																
0	0.9																
5	0.6																
10	0.4																
15	0.3																
20	0.2																
25	0.15																
30	0.1																
SAR 1g(W/Kg)	0.623																
SAR 10g(W/Kg)	0.406																

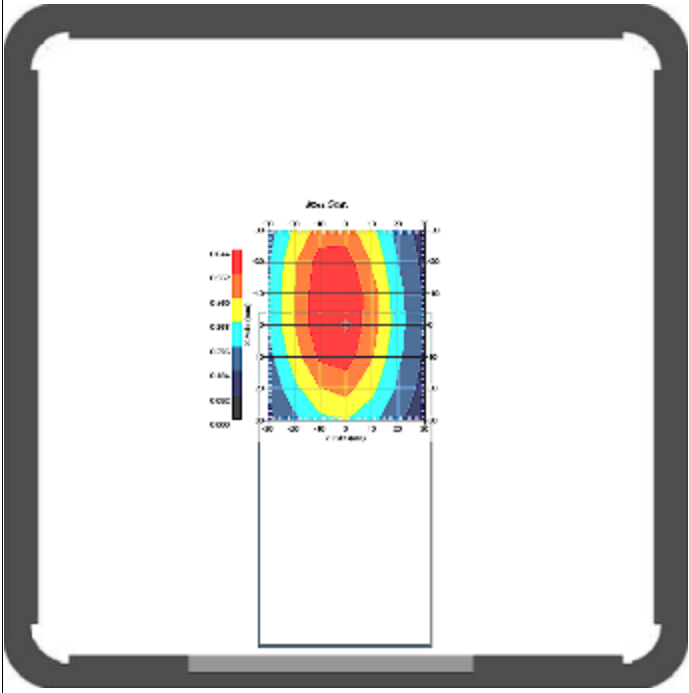
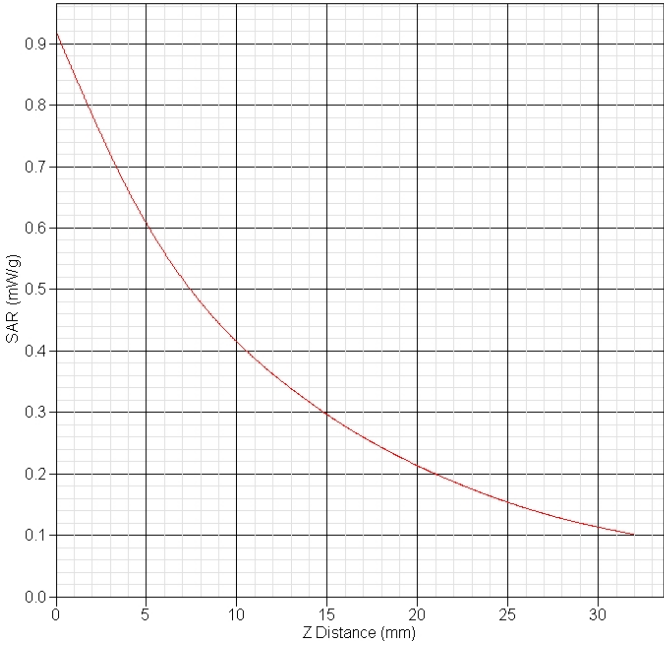
<b>GPRS850 body Right CH251(Hotspot)</b>																	
Frequency(MHz)	848.8																
Relative permittivity(real part)	53.31																
Conductivity(S/m)	0.94																
Variation(%)	-2.809																
Duty Cycle Factor	2																
Crest factor	2																
Conversion Fator	6.4																
Probe Sensitivity	1.20 1.20 1.20 $\mu$ V/(V/m) <sup>2</sup>																
Data	2012-08-22																
	<p>SAR-Z Axis at Hotspot x:-1.95 y:-0.14</p>  <table border="1"> <caption>SAR-Z Axis Data</caption> <thead> <tr> <th>Z Distance (mm)</th> <th>SAR (mW/kg)</th> </tr> </thead> <tbody> <tr><td>0</td><td>0.9</td></tr> <tr><td>5</td><td>0.6</td></tr> <tr><td>10</td><td>0.4</td></tr> <tr><td>15</td><td>0.3</td></tr> <tr><td>20</td><td>0.2</td></tr> <tr><td>25</td><td>0.15</td></tr> <tr><td>30</td><td>0.1</td></tr> </tbody> </table>	Z Distance (mm)	SAR (mW/kg)	0	0.9	5	0.6	10	0.4	15	0.3	20	0.2	25	0.15	30	0.1
Z Distance (mm)	SAR (mW/kg)																
0	0.9																
5	0.6																
10	0.4																
15	0.3																
20	0.2																
25	0.15																
30	0.1																
SAR 1g(W/Kg)	0.631																
SAR 10g(W/Kg)	0.415																

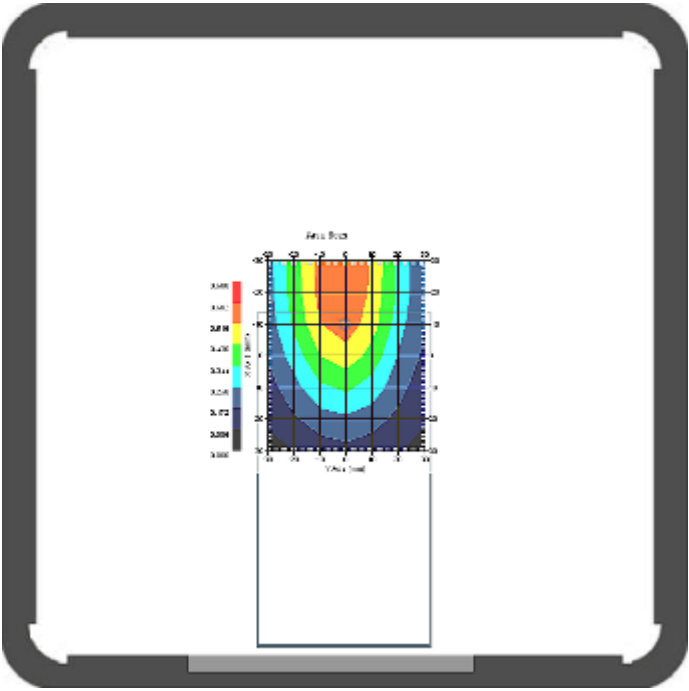
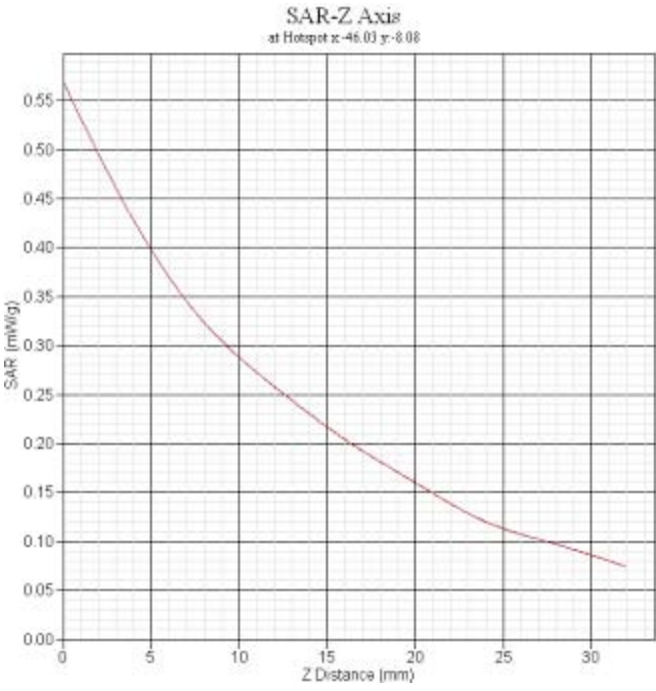
<b>GPRS850 body bottom CH251(Hotspot)</b>	
Frequency(MHz)	848.8
Relative permittivity(real part)	53.31
Conductivity(S/m)	0.94
Variation(%)	-0.822
Duty Cycle Factor	2
Crest factor	2
Conversion Fator	6.4
Probe Sensitivity	1.20 1.20 1.20 $\mu V/(V/m)^2$
Data	2012-08-22
	
SAR 1g(W/Kg)	0.393
SAR 10g(W/Kg)	0.285

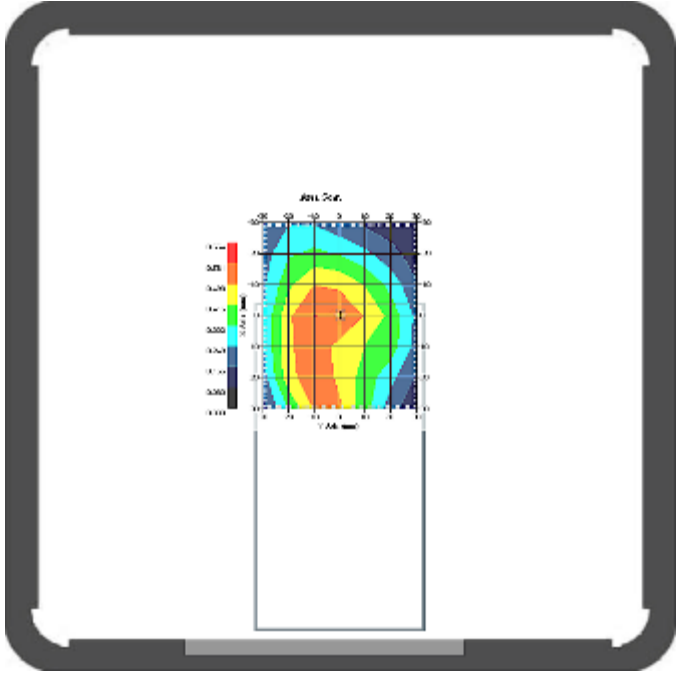
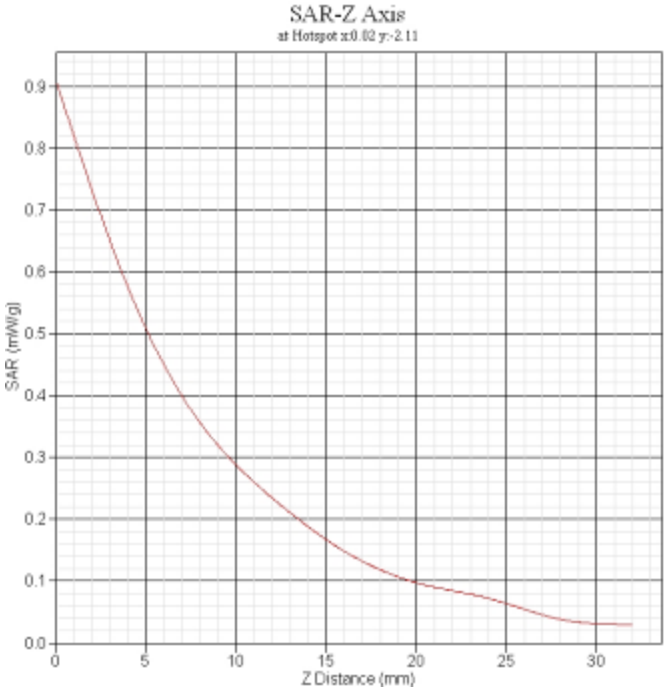
<b>GPRS1900 body Front CH512(Hotspot)</b>	
Frequency(MHz)	1850.2
Relative permittivity(real part)	52.92
Conductivity(S/m)	1.51
Variation(%)	-3.936
Duty Cycle Factor	2
Crest factor	2
Conversion Fator	5.4
Probe Sensitivity	1.20 1.20 1.20 $\mu$ V/(V/m) <sup>2</sup>
Data	2012-08-22
	
SAR 1g(W/Kg)	0.553
SAR 10g(W/Kg)	0.317

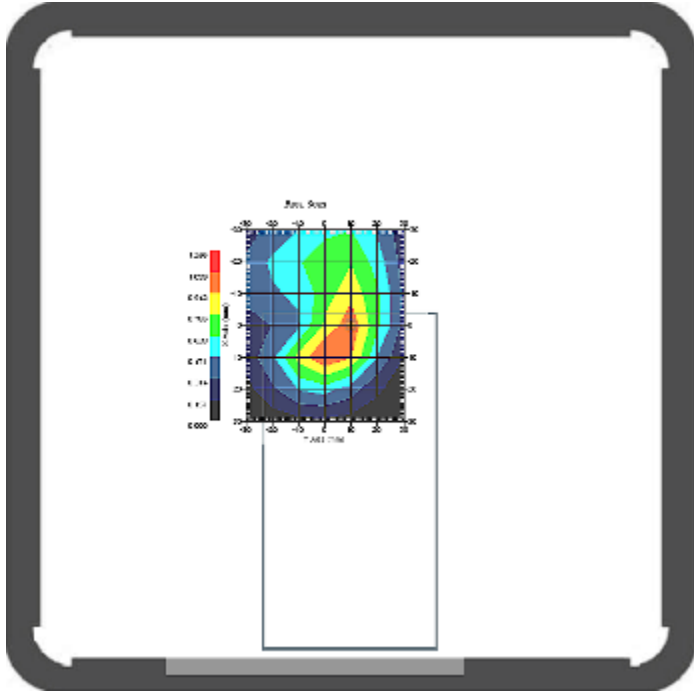
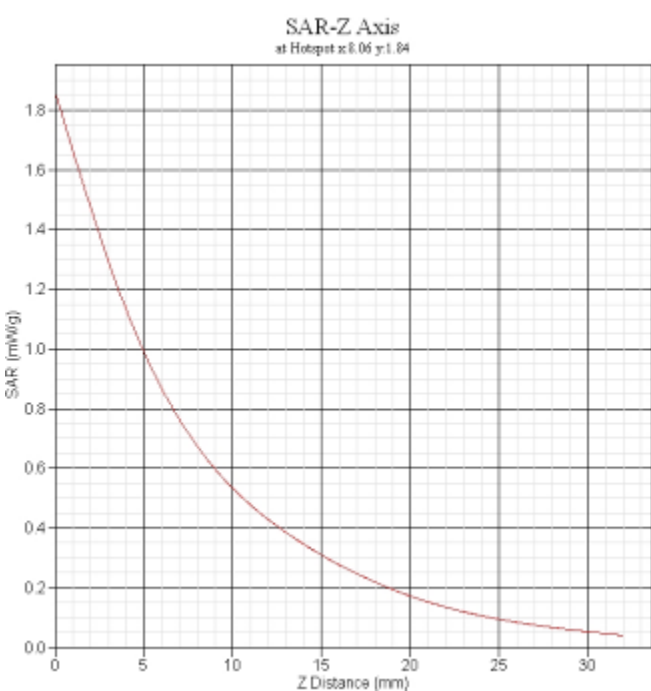
<b>GPRS1900 body Back CH512(Hotspot)</b>	
Frequency(MHz)	1850.2
Relative permittivity(real part)	52.92
Conductivity(S/m)	1.51
Variation(%)	0.050
Duty Cycle Factor	2
Crest factor	2
Conversion Fator	5.4
Probe Sensitivity	1.20 1.20 1.20 $\mu V/(V/m)^2$
Data	2012-08-22
	
SAR 1g(W/Kg)	0.998
SAR 10g(W/Kg)	0.499

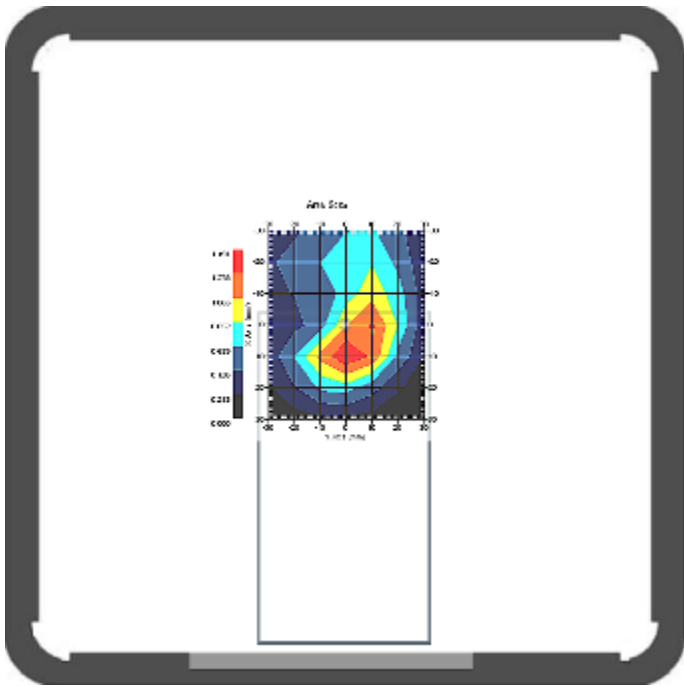
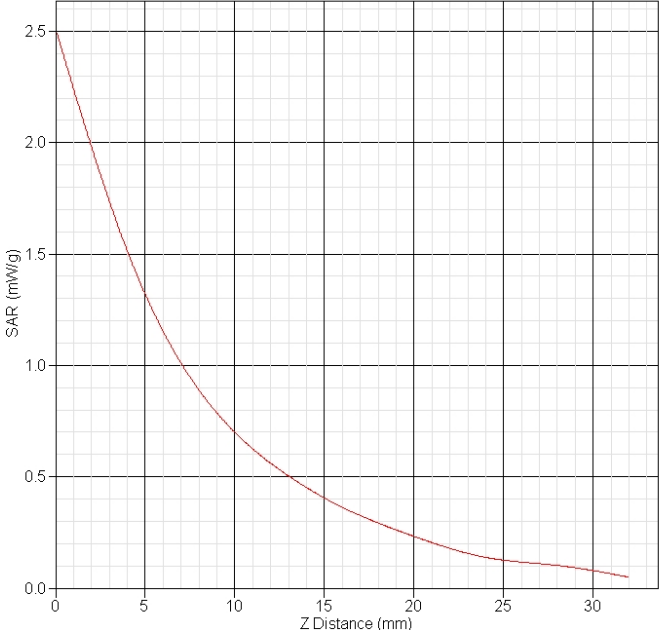
<b>GPRS1900 body Back CH661(Hotspot)</b>	
Frequency(MHz)	1880.0
Relative permittivity(real part)	52.92
Conductivity(S/m)	1.51
Variation(%)	-1.058
Duty Cycle Factor	2
Crest factor	2
Conversion Fator	5.4
Probe Sensitivity	1.20 1.20 1.20 $\mu V/(V/m)^2$
Data	2012-08-22
	<p>SAR-Z Axis at Hotspot x:8.04 y:1.89</p> 
SAR 1g(W/Kg)	1.230
SAR 10g(W/Kg)	0.658

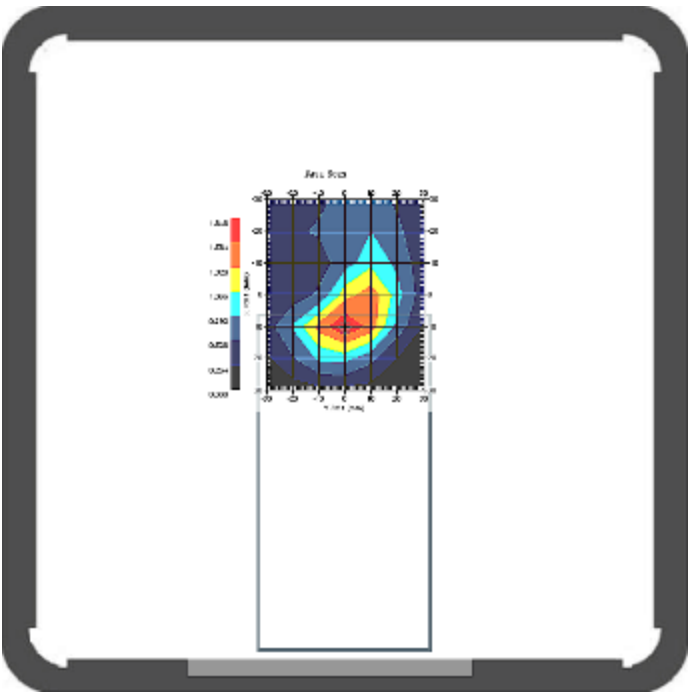
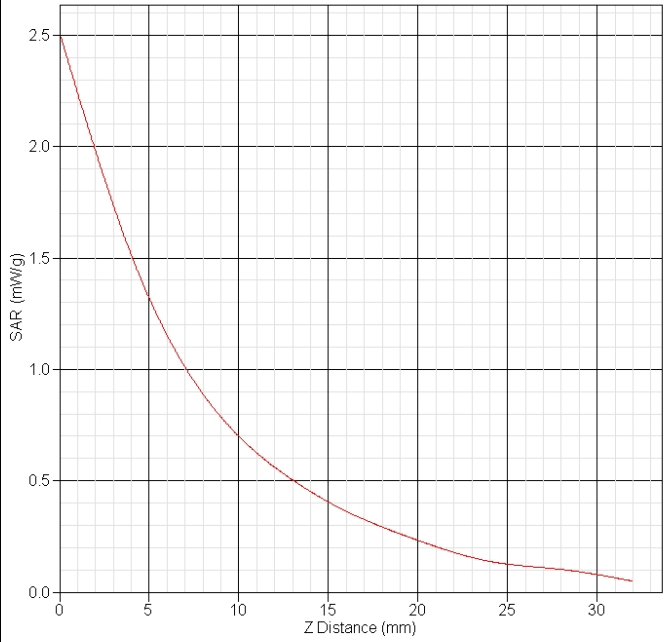
<b>GPRS1900 body Back CH810(Hotspot)</b>																	
Frequency(MHz)	1909.8																
Relative permittivity(real part)	52.92																
Conductivity(S/m)	1.51																
Variation(%)	-3.859																
Duty Cycle Factor	2																
Crest factor	2																
Conversion Fator	5.4																
Probe Sensitivity	1.20 1.20 1.20 $\mu V/(V/m)^2$																
Data	2012-08-22																
	<p>SAR-Z Axis at Hotspot x:8.04 y:1.89</p>  <table border="1"> <caption>SAR-Z Axis Data</caption> <thead> <tr> <th>Z Distance (mm)</th> <th>SAR (mW/g)</th> </tr> </thead> <tbody> <tr><td>0</td><td>2.5</td></tr> <tr><td>5</td><td>1.4</td></tr> <tr><td>10</td><td>0.8</td></tr> <tr><td>15</td><td>0.5</td></tr> <tr><td>20</td><td>0.3</td></tr> <tr><td>25</td><td>0.2</td></tr> <tr><td>30</td><td>0.1</td></tr> </tbody> </table>	Z Distance (mm)	SAR (mW/g)	0	2.5	5	1.4	10	0.8	15	0.5	20	0.3	25	0.2	30	0.1
Z Distance (mm)	SAR (mW/g)																
0	2.5																
5	1.4																
10	0.8																
15	0.5																
20	0.3																
25	0.2																
30	0.1																
SAR 1g(W/Kg)	1.361																
SAR 10g(W/Kg)	0.757																

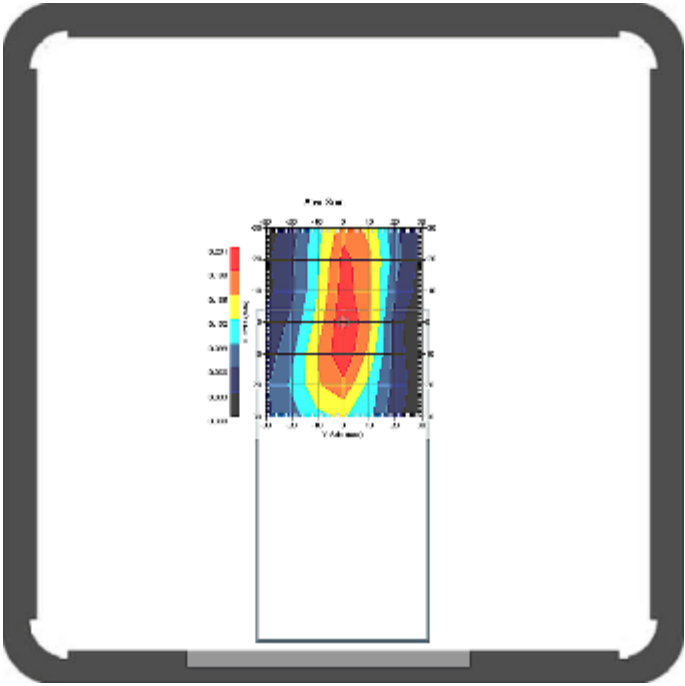
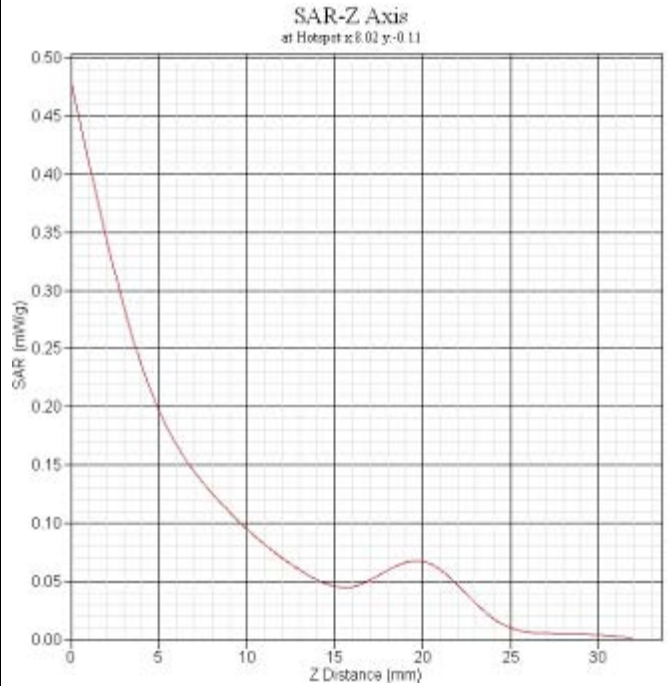

<b>GPRS1900 body left CH512(Hotspot)</b>	
Frequency(MHz)	1850.2
Relative permittivity(real part)	52.92
Conductivity(S/m)	1.51
Variation(%)	-3.895
Duty Cycle Factor	2
Crest factor	2
Conversion Fator	5.4
Probe Sensitivity	1.20 1.20 1.20 $\mu$ V/(V/m) <sup>2</sup>
Data	2012-08-22
	
SAR 1g(W/Kg)	0.230
SAR 10g(W/Kg)	0.112

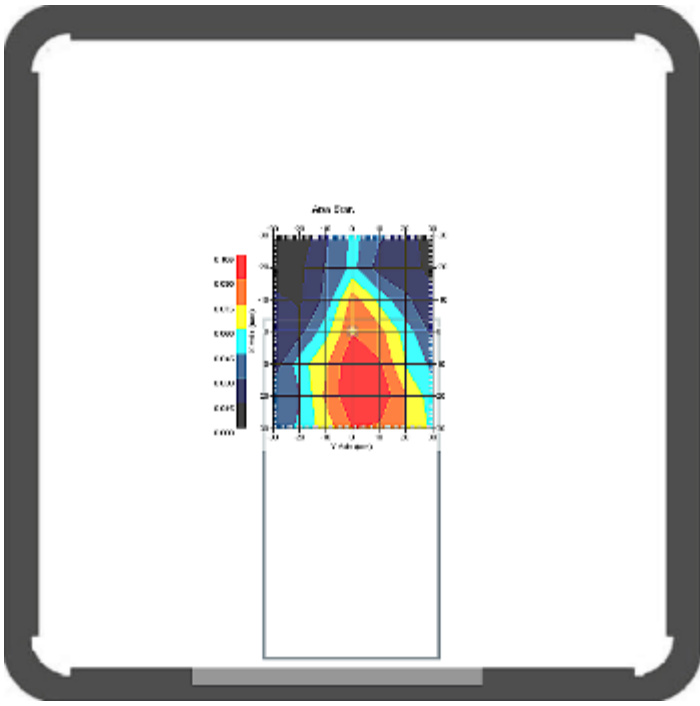
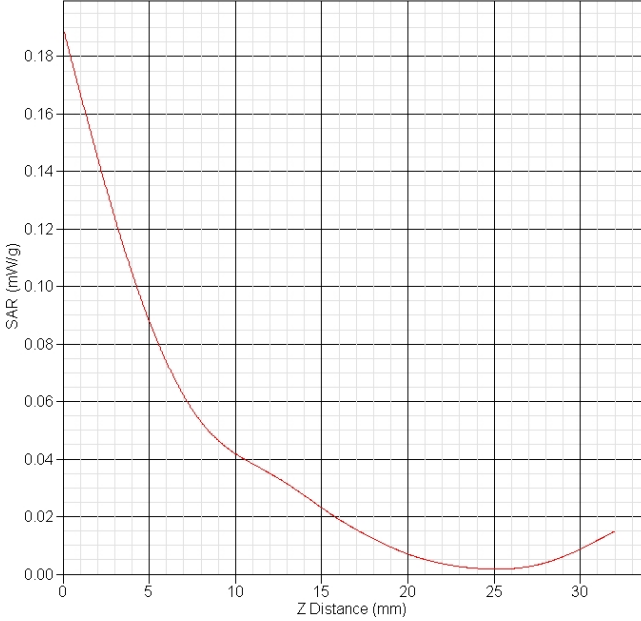
<b>GPRS1900 body Right CH512(Hotspot)</b>	
Frequency(MHz)	1850.2
Relative permittivity(real part)	52.92
Conductivity(S/m)	1.51
Variation(%)	-4.853
Duty Cycle Factor	2
Crest factor	2
Conversion Fator	5.4
Probe Sensitivity	1.20 1.20 1.20 $\mu V/(V/m)^2$
Data	2012-08-22
	<p>SAR-Z Axis at Hotspot x:18.10 y:-0.13</p> 
SAR 1g(W/Kg)	0.102
SAR 10g(W/Kg)	0.052

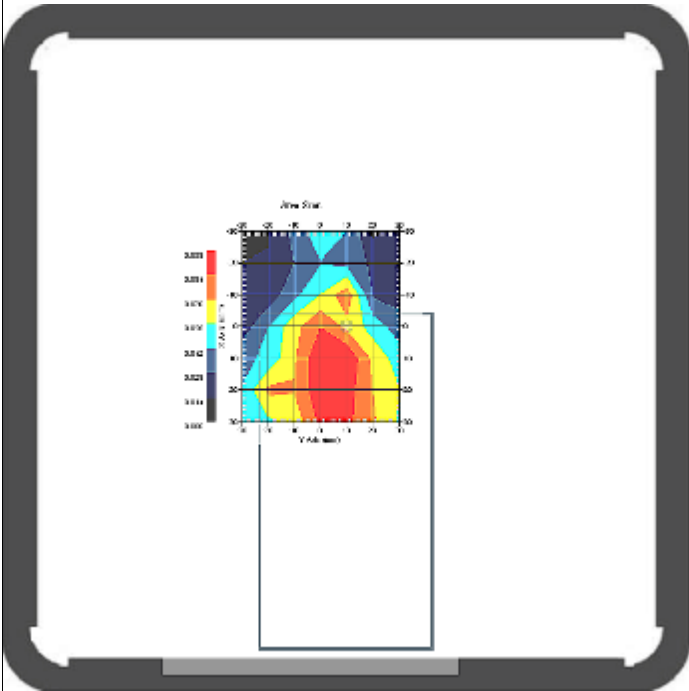
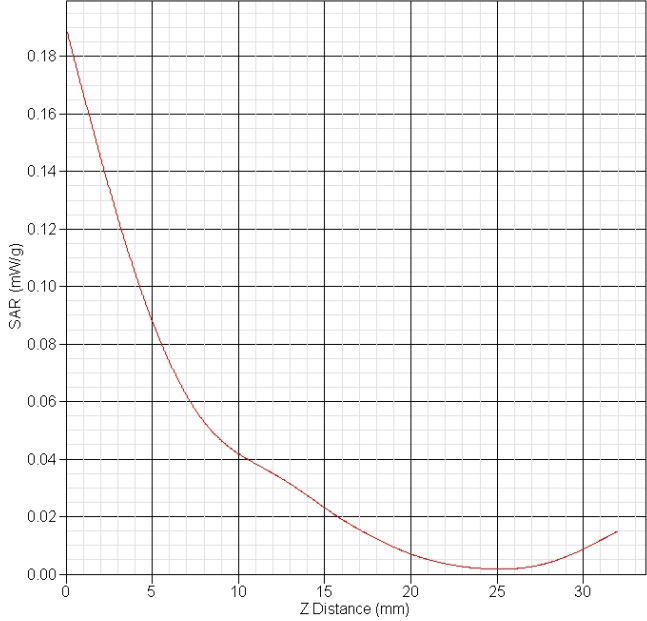
<b>GPRS1900 body bottom CH512(Hotspot)</b>	
Frequency(MHz)	1850.2
Relative permittivity(real part)	52.92
Conductivity(S/m)	1.51
Variation(%)	2.646
Duty Cycle Factor	2
Crest factor	2
Conversion Fator	5.4
Probe Sensitivity	1.20 1.20 1.20 $\mu$ V/(V/m) <sup>2</sup>
Data	2012-08-22
	<p>SAR-Z Axis at Hotspot x:18.10 y:-0.13</p> 
SAR 1g(W/Kg)	0.079
SAR 10g(W/Kg)	0.038

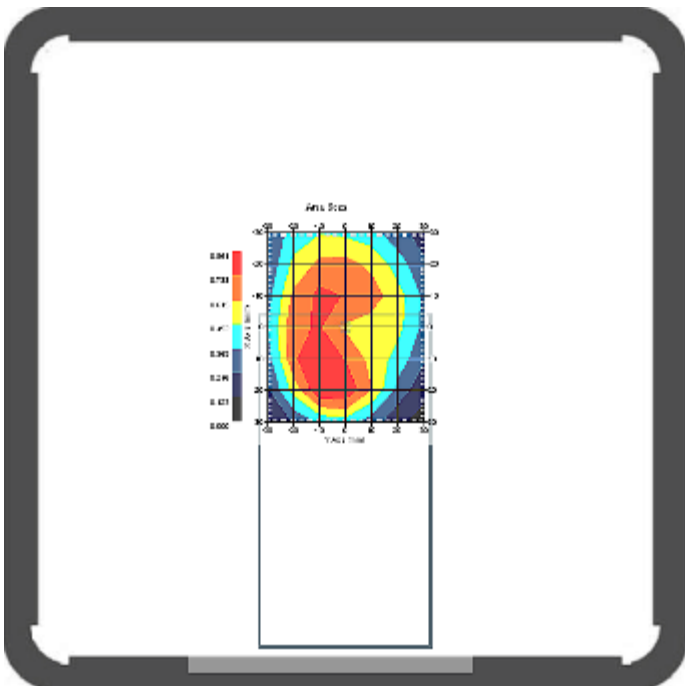
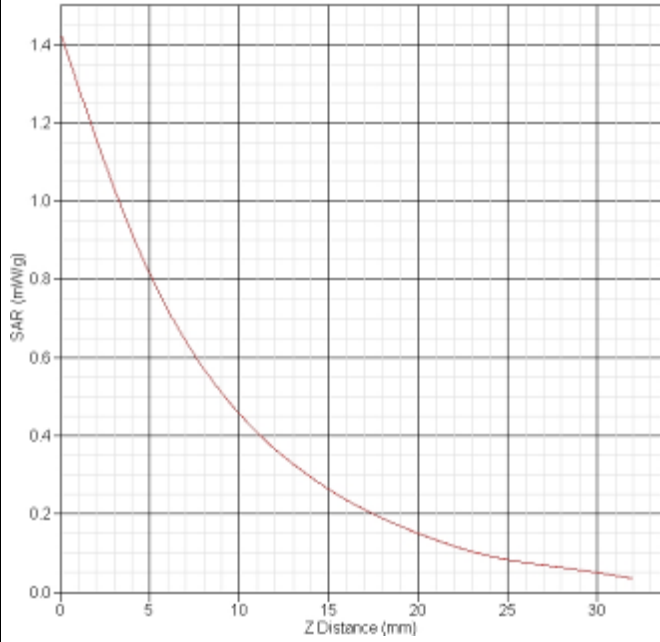
<b>WCDMA Band II body Front CH9400(Hotspot)</b>	
Frequency(MHz)	1800.0
Relative permittivity(real part)	52.92
Conductivity(S/m)	1.51
Variation(%)	2.758
Duty Cycle Factor	1
Crest factor	1
Conversion Fator	5.4
Probe Sensitivity	1.20 1.20 1.20 $\mu V/(V/m)^2$
Data	2012-08-22
	<p>SAR-Z Axis at Hotspot x:11.99 y:-8.11</p> 
SAR 1g(W/Kg)	0.749
SAR 10g(W/Kg)	0.471

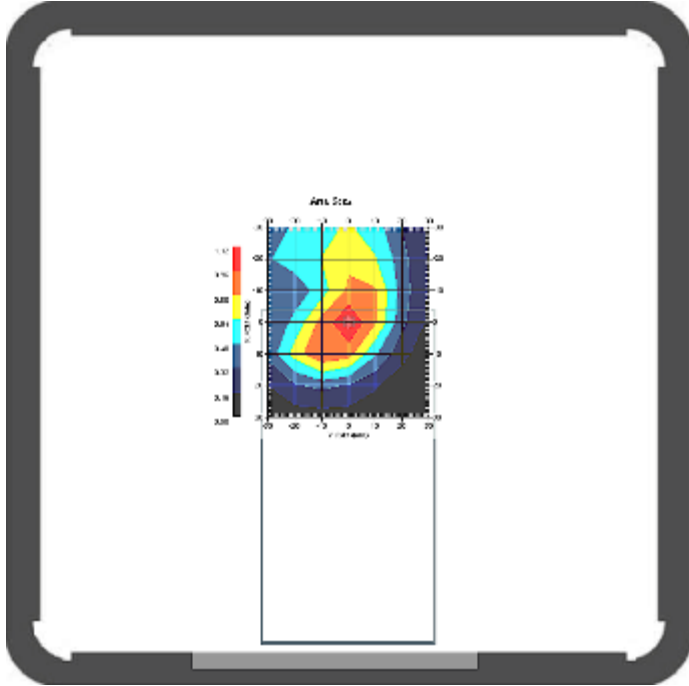
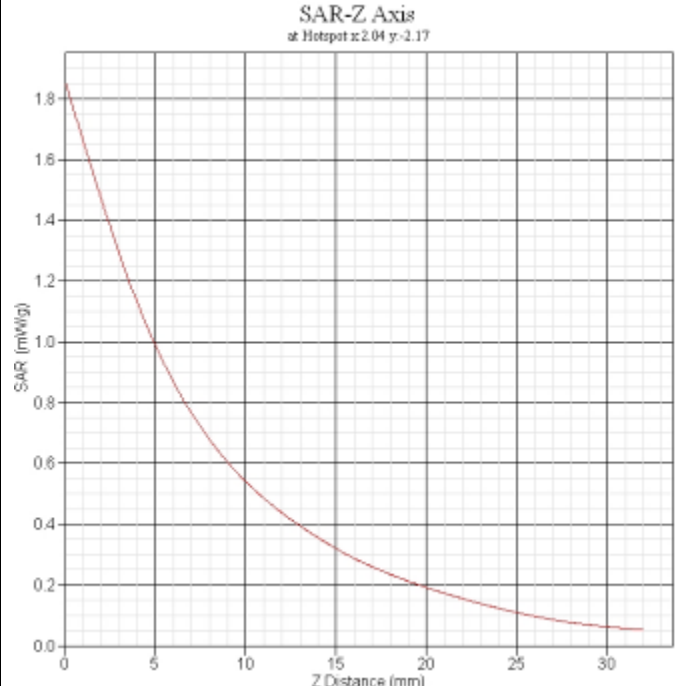
<b>WCDMA Band II body back CH9262(Hotspot)</b>	
Frequency(MHz)	1852.4
Relative permittivity(real part)	52.92
Conductivity(S/m)	1.51
Variation(%)	-1.175
Duty Cycle Factor	1
Crest factor	1
Conversion Fator	5.4
Probe Sensitivity	1.20 1.20 1.20 $\mu V/(V/m)^2$
Data	2012-08-22
	
SAR 1g(W/Kg)	1.023
SAR 10g(W/Kg)	0.533

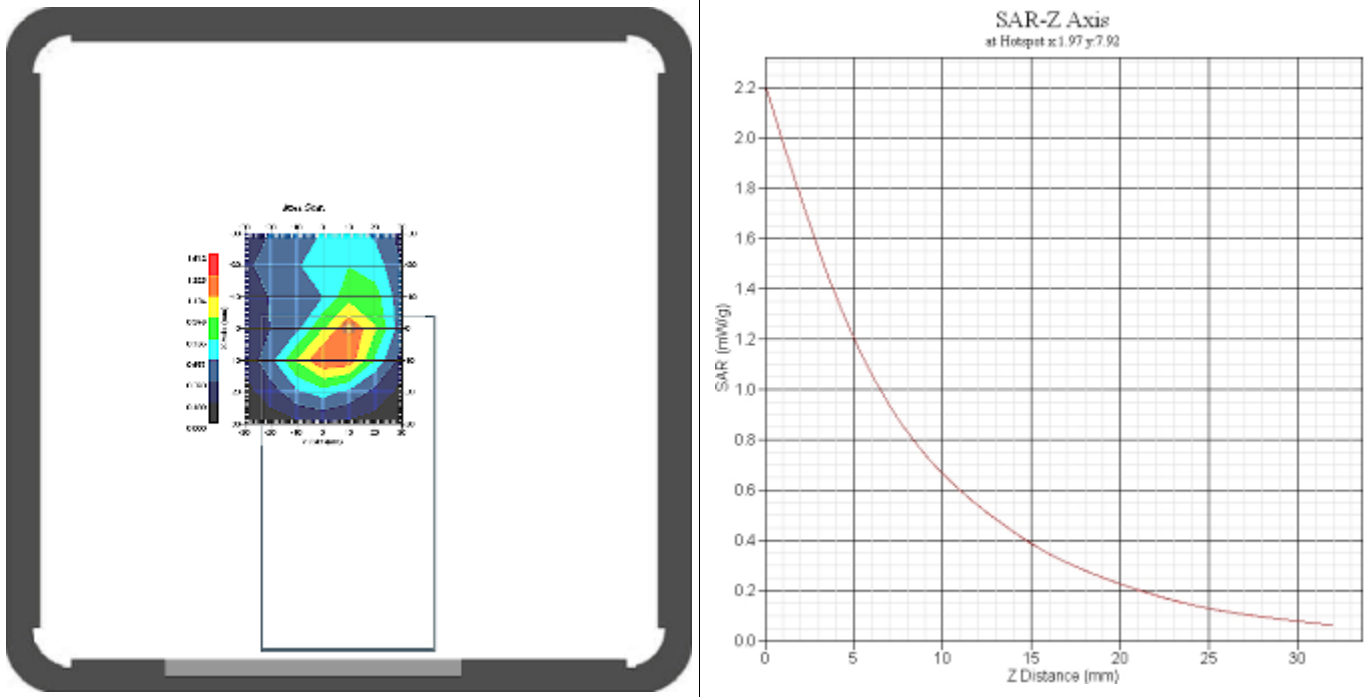
<b>WCDMA Band II body Back CH9400(Hotspot)</b>	
Frequency(MHz)	1800.0
Relative permittivity(real part)	52.92
Conductivity(S/m)	1.51
Variation(%)	3.271
Duty Cycle Factor	1
Crest factor	1
Conversion Fator	5.4
Probe Sensitivity	1.20 1.20 1.20 $\mu$ V/(V/m) <sup>2</sup>
Data	2012-08-22
	
SAR 1g(W/Kg)	1.230
SAR 10g(W/Kg)	0.640

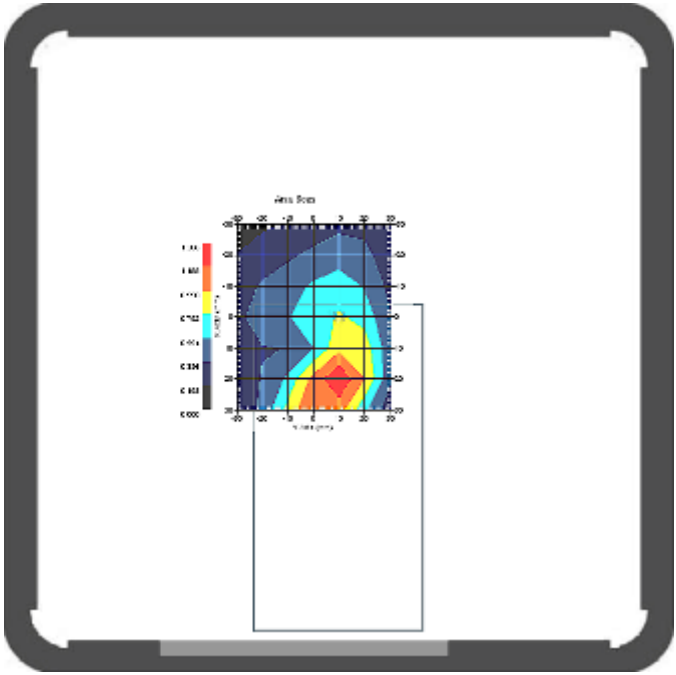
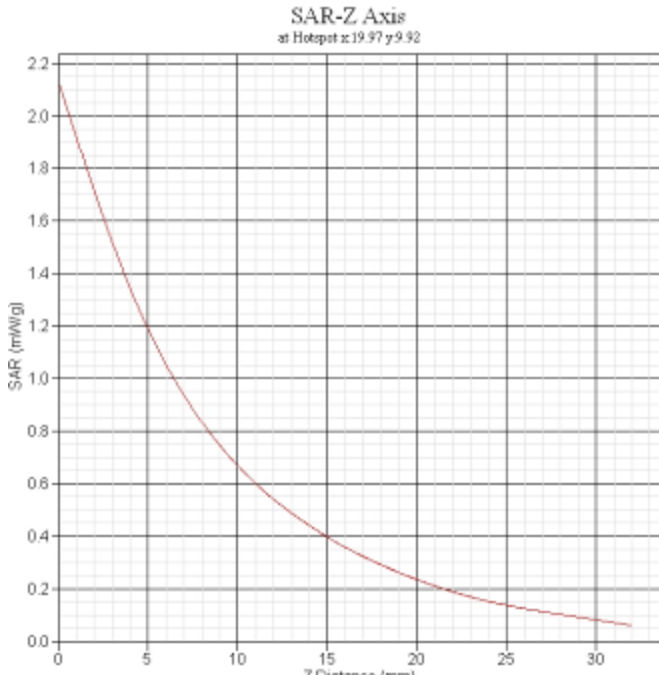
<b>WCDMA Band II body back CH9538(Hotspot)</b>	
Frequency(MHz)	1907.6
Relative permittivity(real part)	52.92
Conductivity(S/m)	1.51
Variation(%)	2.701
Duty Cycle Factor	1
Crest factor	1
Conversion Fator	5.4
Probe Sensitivity	1.20 1.20 1.20 $\mu$ V/(V/m) <sup>2</sup>
Data	2012-08-22
	
SAR 1g(W/Kg)	1.179
SAR 10g(W/Kg)	0.577

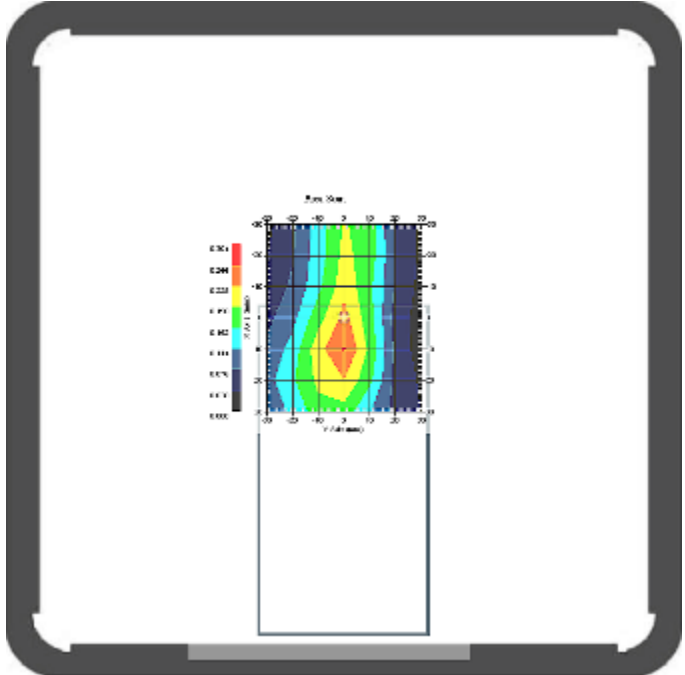
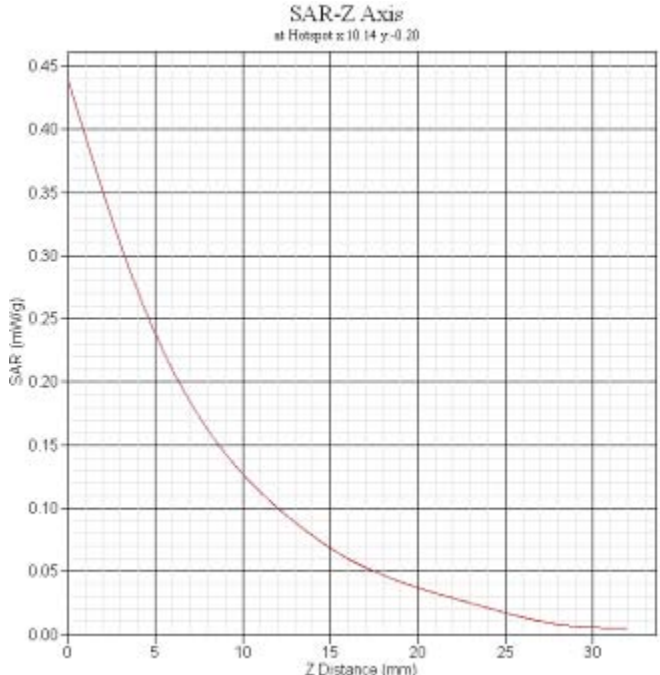
<b>WCDMA Band II body left CH9400(Hotspot)</b>	
Frequency(MHz)	1800.0
Relative permittivity(real part)	52.92
Conductivity(S/m)	1.51
Variation(%)	-2.232
Duty Cycle Factor	1
Crest factor	1
Conversion Fator	5.4
Probe Sensitivity	1.20 1.20 1.20 $\mu V/(V/m)^2$
Data	2012-08-22
	
SAR 1g(W/Kg)	0.246
SAR 10g(W/Kg)	0.130

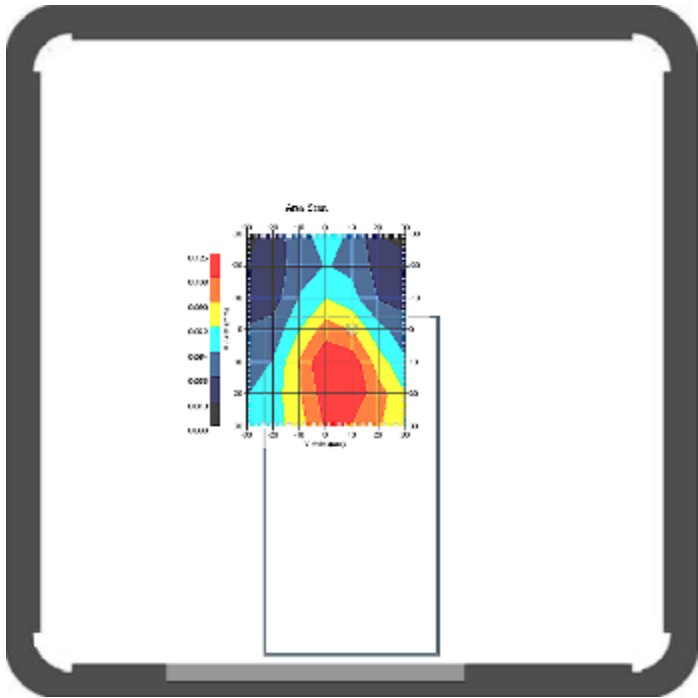
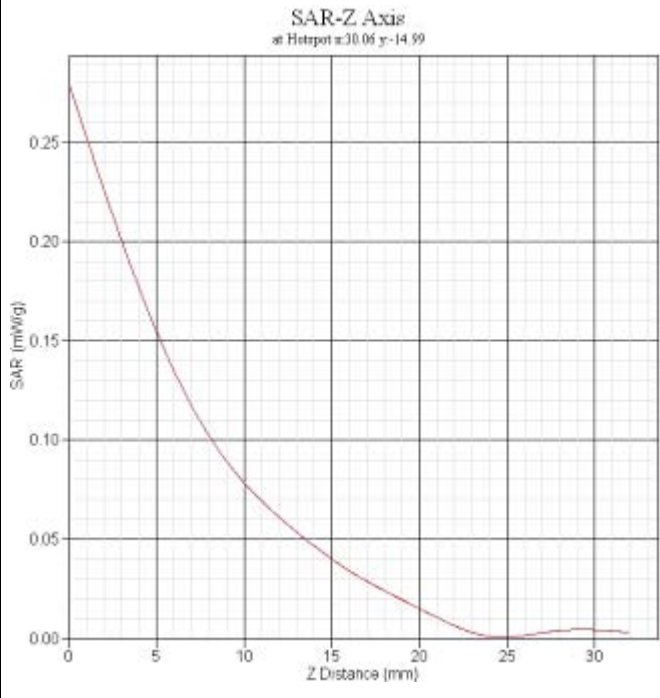

<b>WCDMA Band II body Right CH9400(Hotspot)</b>	
Frequency(MHz)	1800.0
Relative permittivity(real part)	52.92
Conductivity(S/m)	1.51
Variation(%)	1.995
Duty Cycle Factor	1
Crest factor	1
Conversion Fator	5.4
Probe Sensitivity	1.20 1.20 1.20 $\mu$ V/(V/m) <sup>2</sup>
Data	2012-08-22
	
SAR 1g(W/Kg)	0.123
SAR 10g(W/Kg)	0.063

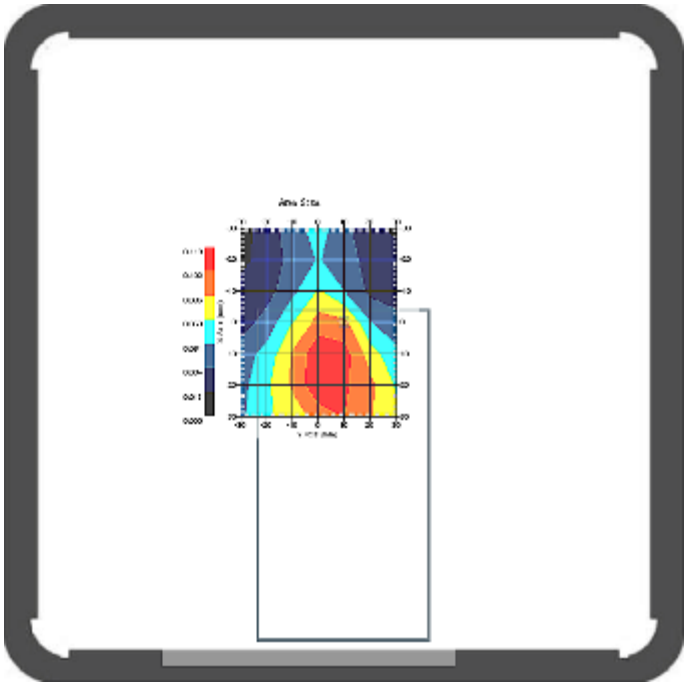
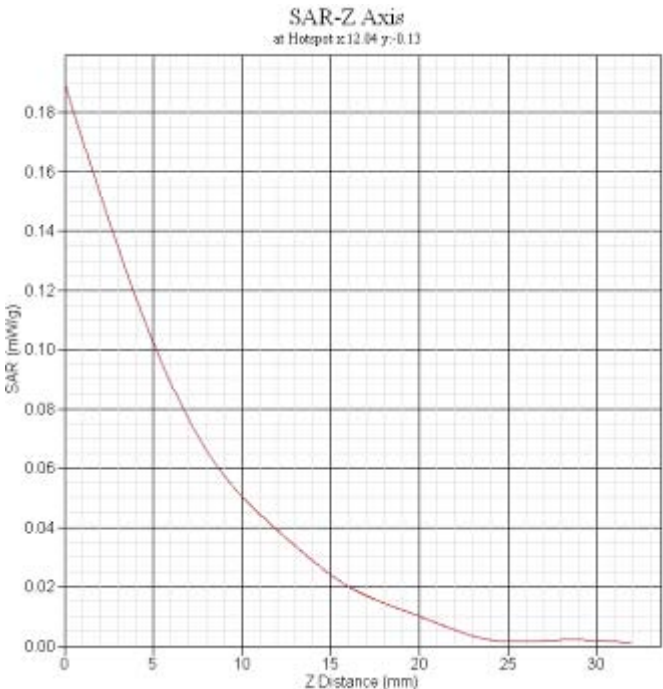
<b>WCDMA Band II body bottom CH9400(Hotspot)</b>	
Frequency(MHz)	1800.0
Relative permittivity(real part)	52.92
Conductivity(S/m)	1.51
Variation(%)	-2.093
Duty Cycle Factor	1
Crest factor	1
Conversion Fator	5.4
Probe Sensitivity	1.20 1.20 1.20 $\mu$ V/(V/m) <sup>2</sup>
Data	2012-08-22
	
SAR 1g(W/Kg)	0.109
SAR 10g(W/Kg)	0.057

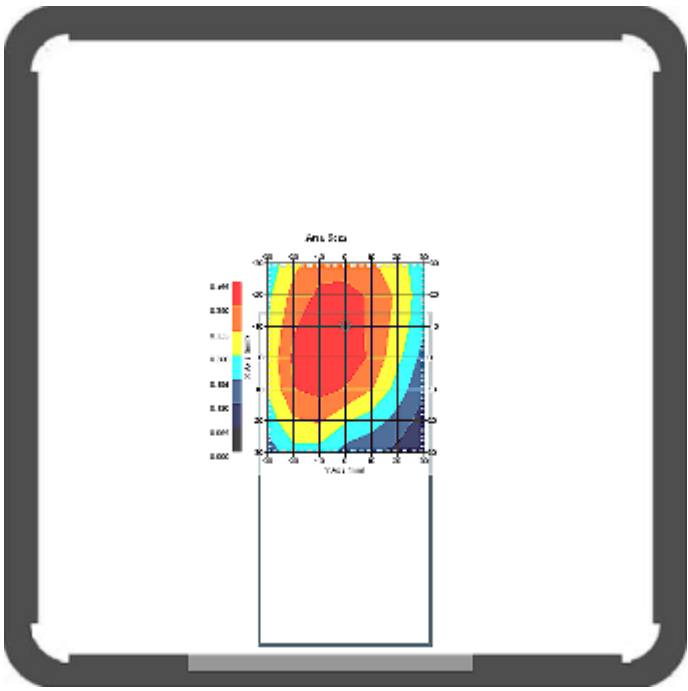
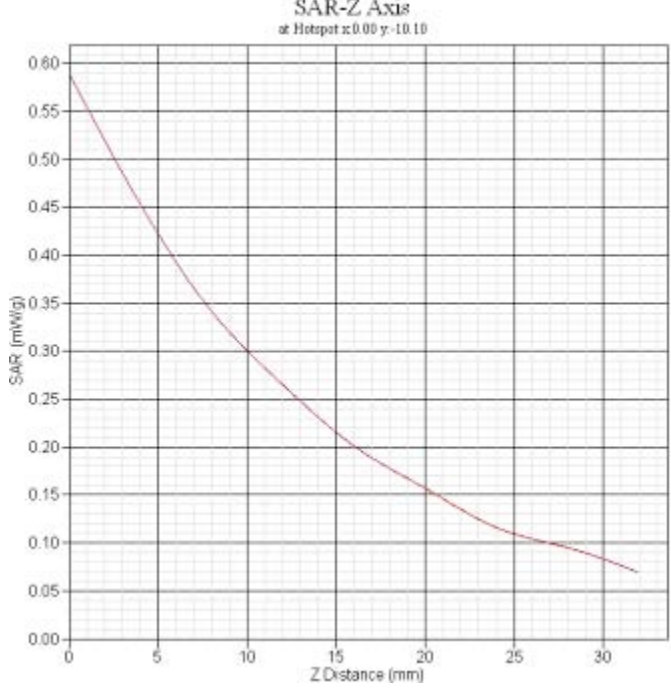
<b>WCDMA Band V body Front CH4183(Hotspot)</b>	
Frequency(MHz)	836.6
Relative permittivity(real part)	53.31
Conductivity(S/m)	0.94
Variation(%)	-1.275
Duty Cycle Factor	1
Crest factor	1
Conversion Fator	6.4
Probe Sensitivity	1.20 1.20 1.20 $\mu V/(V/m)^2$
Data	2012-08-22
	
SAR 1g(W/Kg)	0.413
SAR 10g(W/Kg)	0.271

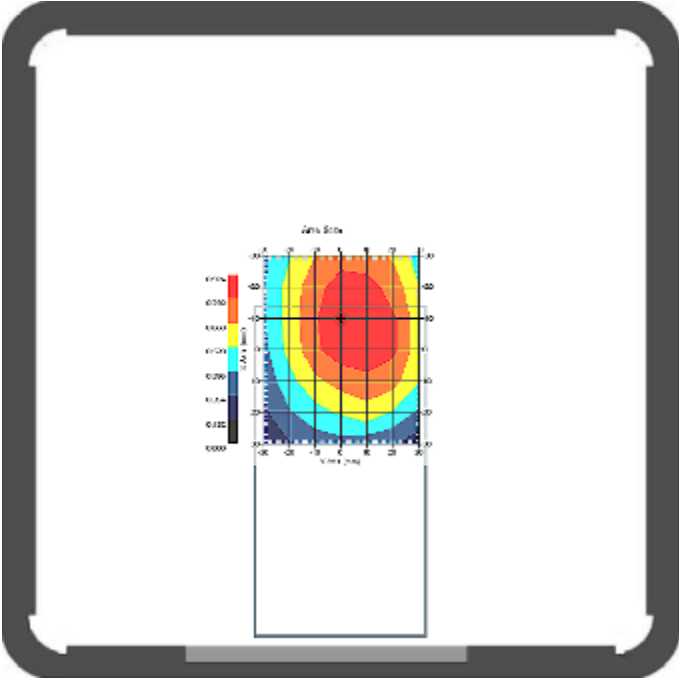
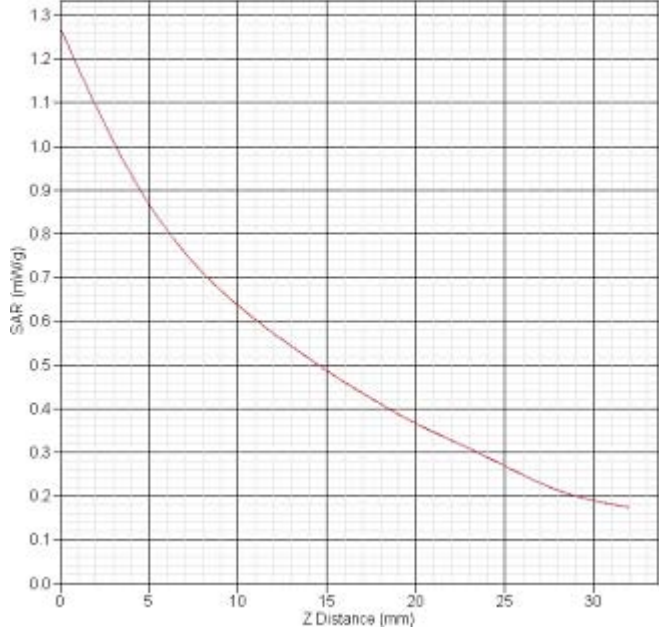
<b>WCDMA Band V body Back CH4132(Hotspot)</b>																	
Frequency(MHz)	826.4																
Relative permittivity(real part)	53.31																
Conductivity(S/m)	0.94																
Variation(%)	2.298																
Duty Cycle Factor	1																
Crest factor	1																
Conversion Fator	6.4																
Probe Sensitivity	1.20 1.20 1.20 $\mu V/(V/m)^2$																
Data	2012-08-22																
	<p>SAR-Z Axis at Hotspot x: 9.93 y: 9.84</p>  <table border="1"> <caption>SAR-Z Axis Data</caption> <thead> <tr> <th>Z Distance (mm)</th> <th>SAR (mW/kg)</th> </tr> </thead> <tbody> <tr><td>0</td><td>1.25</td></tr> <tr><td>5</td><td>0.85</td></tr> <tr><td>10</td><td>0.65</td></tr> <tr><td>15</td><td>0.50</td></tr> <tr><td>20</td><td>0.38</td></tr> <tr><td>25</td><td>0.28</td></tr> <tr><td>30</td><td>0.18</td></tr> </tbody> </table>	Z Distance (mm)	SAR (mW/kg)	0	1.25	5	0.85	10	0.65	15	0.50	20	0.38	25	0.28	30	0.18
Z Distance (mm)	SAR (mW/kg)																
0	1.25																
5	0.85																
10	0.65																
15	0.50																
20	0.38																
25	0.28																
30	0.18																
SAR 1g(W/Kg)	0.907																
SAR 10g(W/Kg)	0.637																

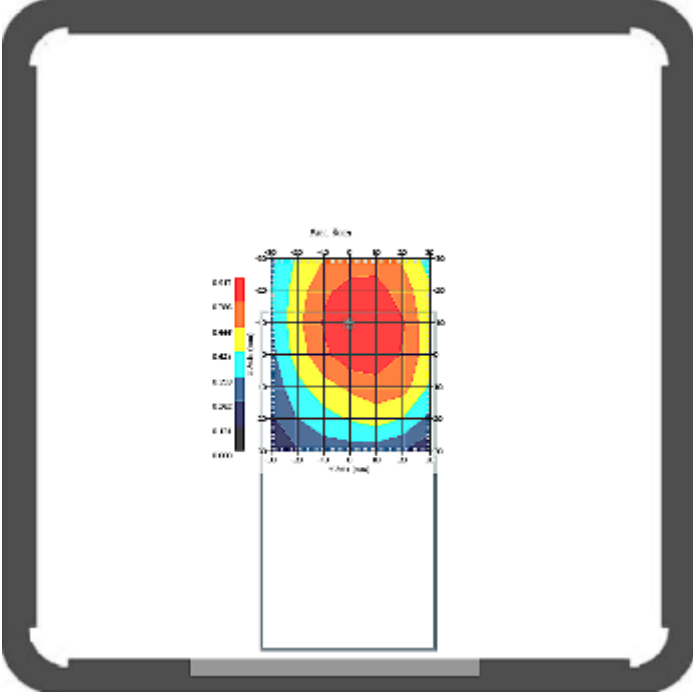
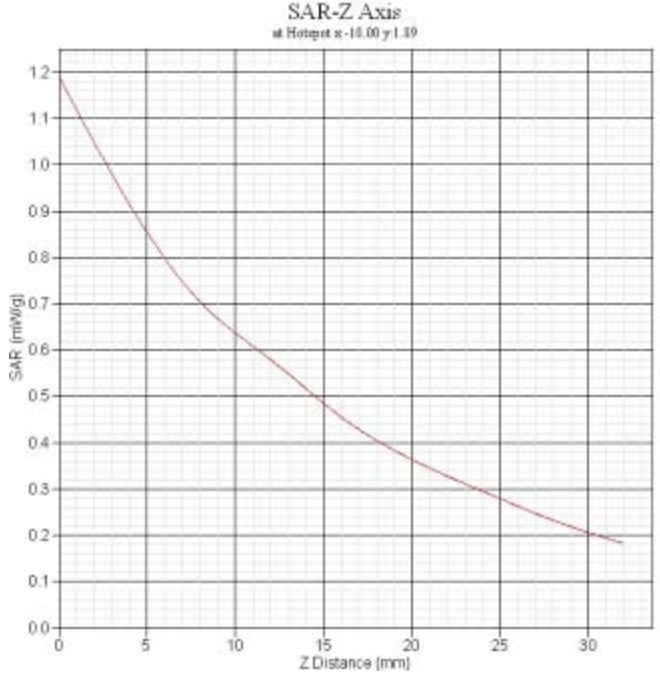
<b>WCDMA Band V body Back CH4183(Hotspot)</b>	
Frequency(MHz)	836.6
Relative permittivity(real part)	53.31
Conductivity(S/m)	0.94
Variation(%)	-1.407
Duty Cycle Factor	1
Crest factor	1
Conversion Fator	6.4
Probe Sensitivity	1.20 1.20 1.20 $\mu V/(V/m)^2$
Data	2012-08-22
	
SAR 1g(W/Kg)	0.874
SAR 10g(W/Kg)	0.586

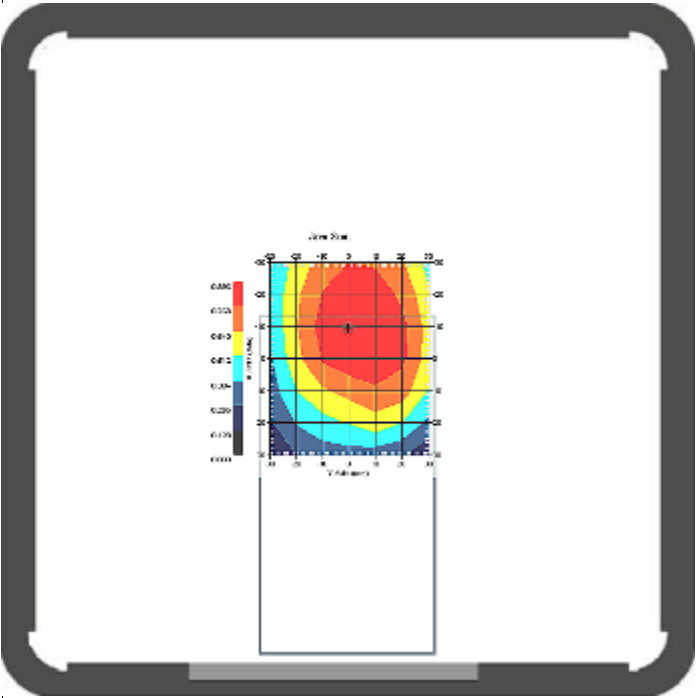
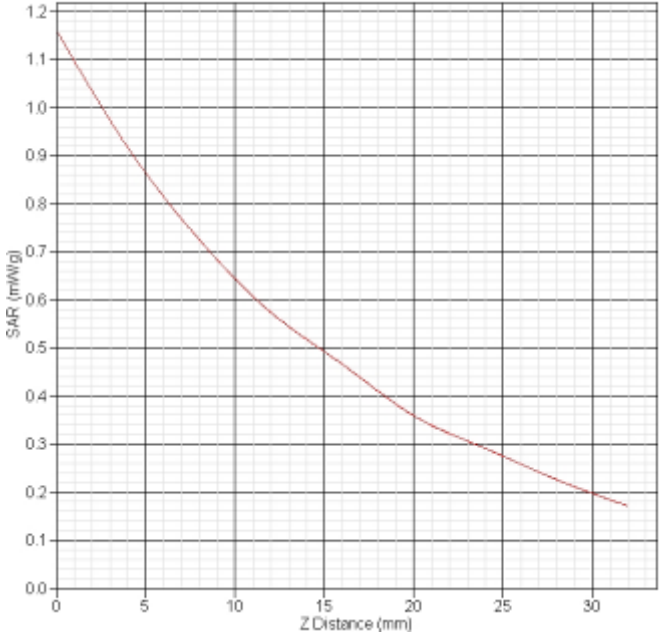
<b>WCDMA Band V body Back CH4233(Hotspot)</b>																			
Frequency(MHz)	846.6																		
Relative permittivity(real part)	53.31																		
Conductivity(S/m)	0.94																		
Variation(%)	2.298																		
Duty Cycle Factor	1																		
Crest factor	1																		
Conversion Fator	6.4																		
Probe Sensitivity	1.20 1.20 1.20 $\mu$ V/(V/m) <sup>2</sup>																		
Data	2012-08-22																		
	<p><b>SAR-Z Axis</b> at Hotspot x:-7.89 y:1.86</p>  <table border="1"> <caption>SAR-Z Axis Data</caption> <thead> <tr> <th>Z Distance (mm)</th> <th>SAR (mW/kg)</th> </tr> </thead> <tbody> <tr><td>0</td><td>1.15</td></tr> <tr><td>5</td><td>0.85</td></tr> <tr><td>10</td><td>0.65</td></tr> <tr><td>15</td><td>0.50</td></tr> <tr><td>20</td><td>0.38</td></tr> <tr><td>25</td><td>0.28</td></tr> <tr><td>30</td><td>0.20</td></tr> <tr><td>32</td><td>0.18</td></tr> </tbody> </table>	Z Distance (mm)	SAR (mW/kg)	0	1.15	5	0.85	10	0.65	15	0.50	20	0.38	25	0.28	30	0.20	32	0.18
Z Distance (mm)	SAR (mW/kg)																		
0	1.15																		
5	0.85																		
10	0.65																		
15	0.50																		
20	0.38																		
25	0.28																		
30	0.20																		
32	0.18																		
SAR 1g(W/Kg)	0.843																		
SAR 10g(W/Kg)	0.578																		

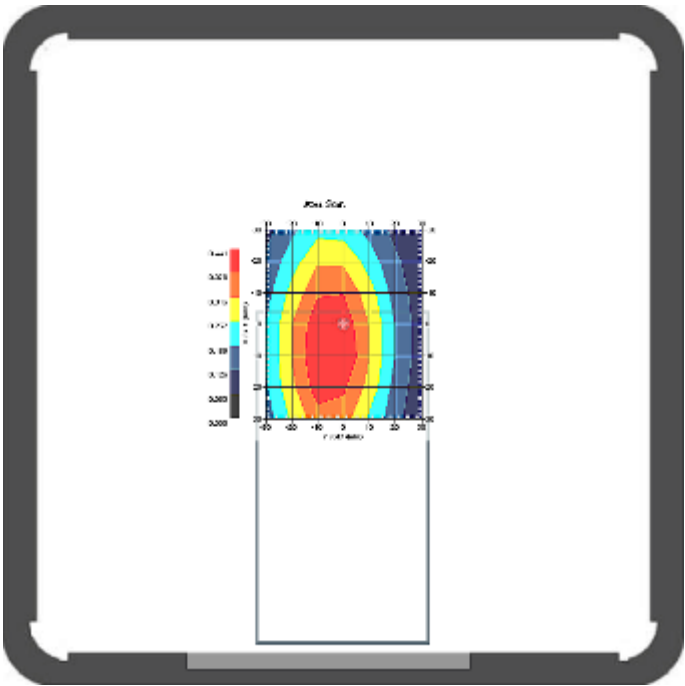
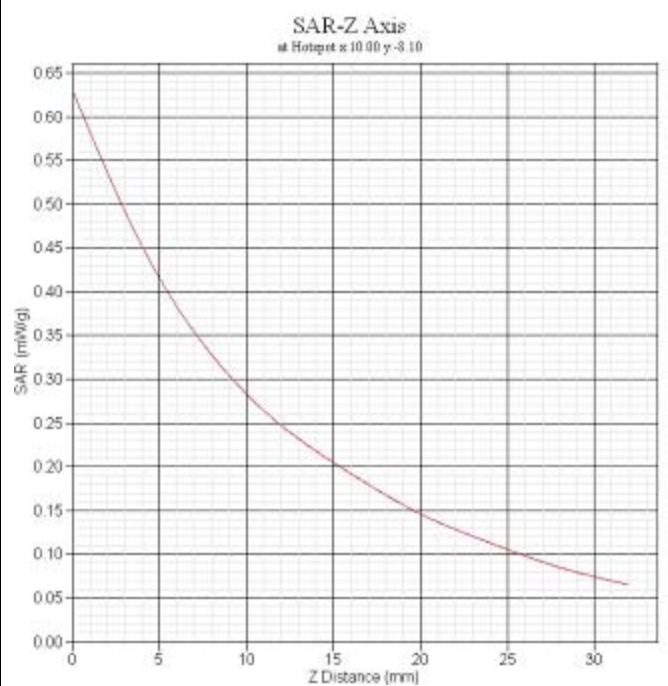
<b>WCDMA Band V body left CH4183 (Hotspot)</b>	
Frequency(MHz)	836.6
Relative permittivity(real part)	53.31
Conductivity(S/m)	0.94
Variation(%)	-3.123
Duty Cycle Factor	1
Crest factor	1
Conversion Fator	6.4
Probe Sensitivity	1.20 1.20 1.20 $\mu$ V/(V/m) <sup>2</sup>
Data	2012-08-22
	
SAR 1g(W/Kg)	0.428
SAR 10g(W/Kg)	0.282

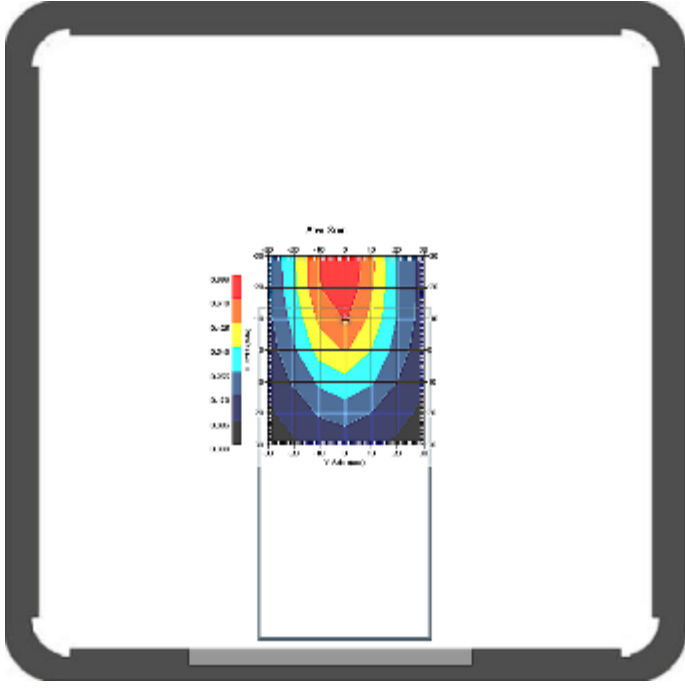
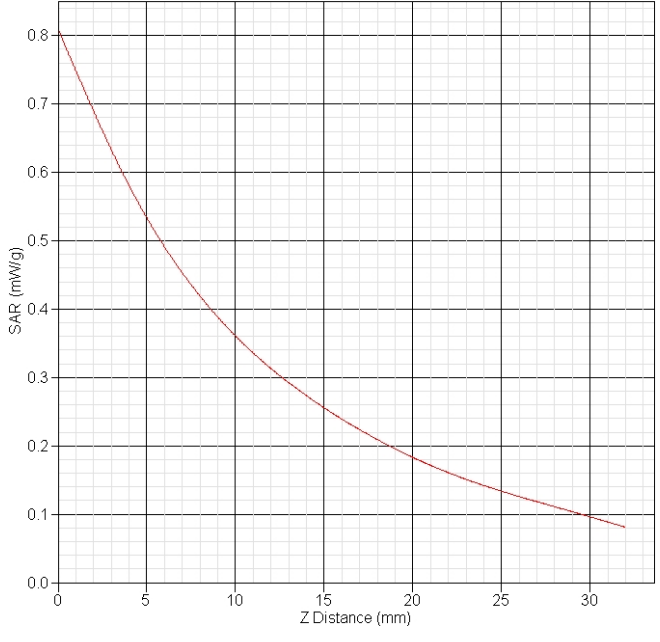
<b>WCDMA Band V body Right CH4183(Hotspot)</b>																	
Frequency(MHz)	836.6																
Relative permittivity(real part)	53.31																
Conductivity(S/m)	0.94																
Variation(%)	0.605																
Duty Cycle Factor	1																
Crest factor	1																
Conversion Fator	6.4																
Probe Sensitivity	1.20 1.20 1.20 $\mu V/(V/m)^2$																
Data	2012-08-22																
	<p>SAR-Z Axis at Hotspot x:-29.99 y:-0.10</p>  <table border="1"> <caption>SAR-Z Axis Data</caption> <thead> <tr> <th>Z Distance (mm)</th> <th>SAR (mW/kg)</th> </tr> </thead> <tbody> <tr><td>0</td><td>0.80</td></tr> <tr><td>5</td><td>0.55</td></tr> <tr><td>10</td><td>0.38</td></tr> <tr><td>15</td><td>0.28</td></tr> <tr><td>20</td><td>0.20</td></tr> <tr><td>25</td><td>0.15</td></tr> <tr><td>30</td><td>0.10</td></tr> </tbody> </table>	Z Distance (mm)	SAR (mW/kg)	0	0.80	5	0.55	10	0.38	15	0.28	20	0.20	25	0.15	30	0.10
Z Distance (mm)	SAR (mW/kg)																
0	0.80																
5	0.55																
10	0.38																
15	0.28																
20	0.20																
25	0.15																
30	0.10																
SAR 1g(W/Kg)	0.553																
SAR 10g(W/Kg)	0.360																

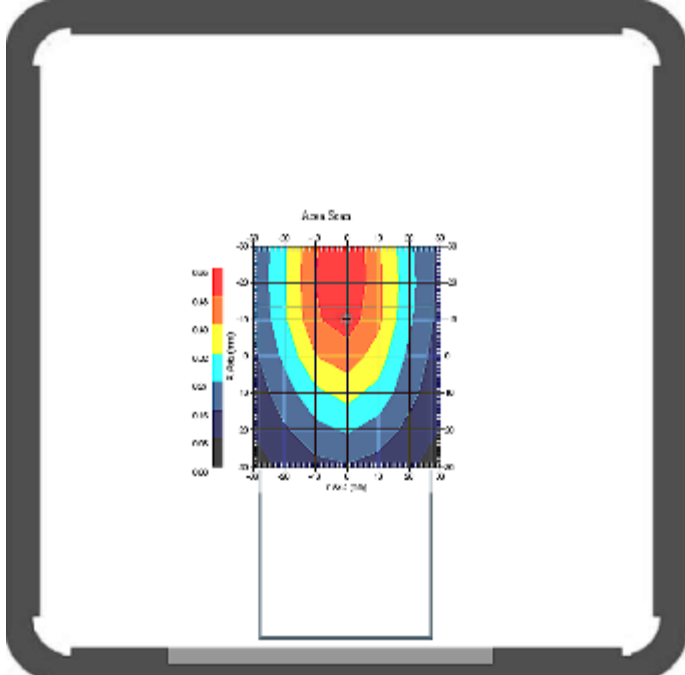
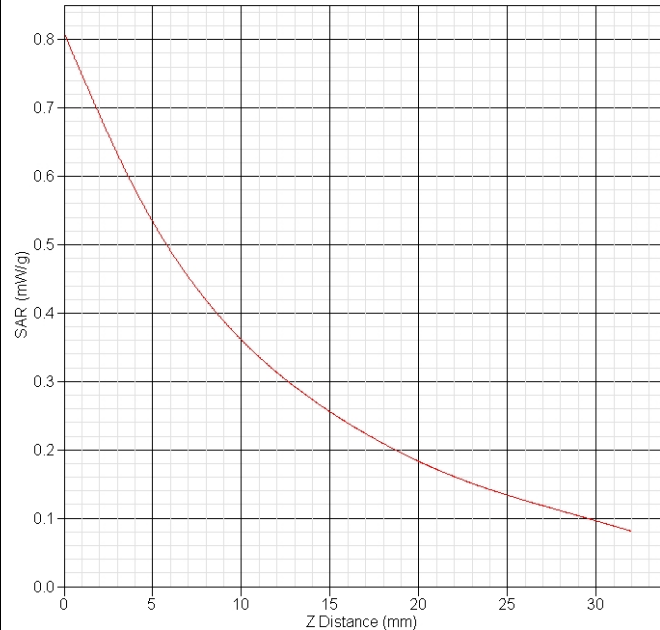

<b>WCDMA Band V body bottom CH4183(Hotspot)</b>	
Frequency(MHz)	836.6
Relative permittivity(real part)	53.31
Conductivity(S/m)	0.94
Variation(%)	-3.834
Duty Cycle Factor	1
Crest factor	1
Conversion Fator	6.4
Probe Sensitivity	1.20 1.20 1.20 $\mu V/(V/m)^2$
Data	2012-08-22
	<p>SAR-Z Axis at Hotspot x:-29.99 y:-0.10</p> 
SAR 1g(W/Kg)	0.497
SAR 10g(W/Kg)	0.324

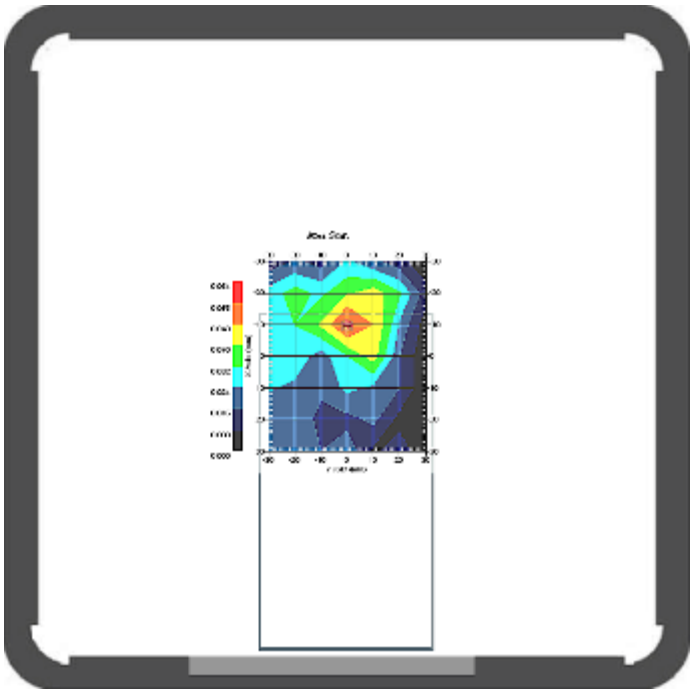
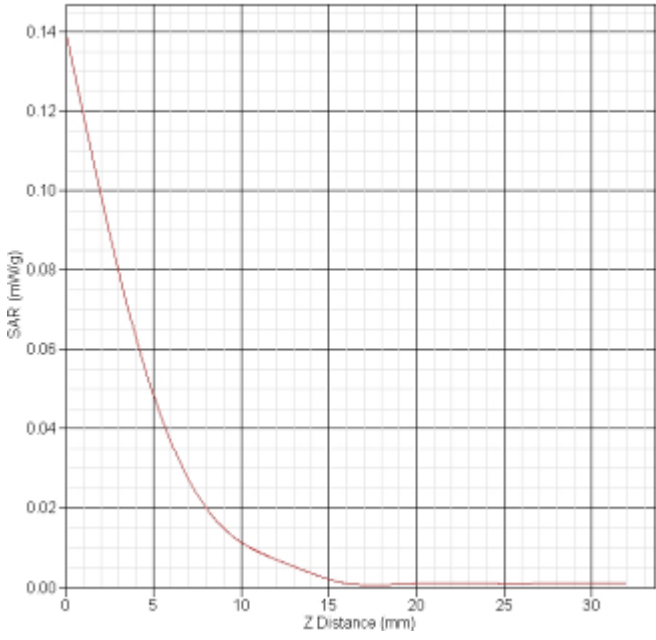
<b>802.11b body Front CH1(Hotspot)</b>	
Frequency(MHz)	2412
Relative permittivity(real part)	53.43
Conductivity(S/m)	1.94
Variation(%)	-2.427
Duty Cycle Factor	1
Crest factor	1
Conversion Fator	4.4
Probe Sensitivity	1.20 1.20 1.20 $\mu V/(V/m)^2$
Data	2012-08-22
	<p>SAR-Z Axis at Hotspot x:-17.98 y:7.89</p> 
SAR 1g(W/Kg)	0.060
SAR 10g(W/Kg)	0.024

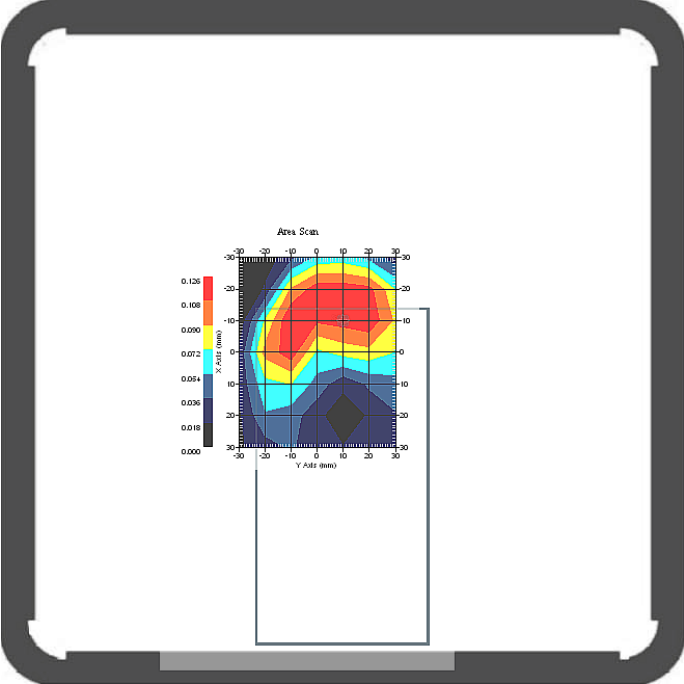
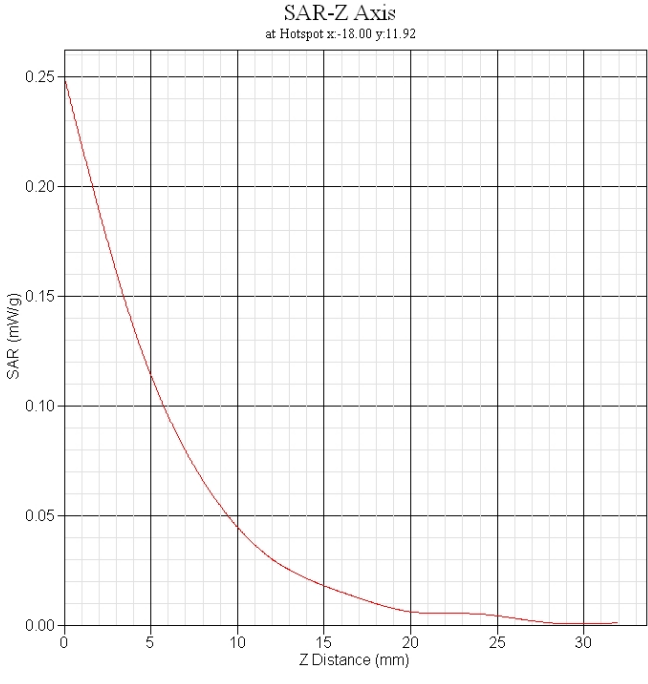
<b>802.11b body Back CH1(Hotspot)</b>	
Frequency(MHz)	2412
Relative permittivity(real part)	53.43
Conductivity(S/m)	1.94
Variation(%)	-0.251
Duty Cycle Factor	1
Crest factor	1
Conversion Fator	4.4
Probe Sensitivity	1.20 1.20 1.20 $\mu V/(V/m)^2$
Data	2012-08-22
	
SAR 1g(W/Kg)	0.123
SAR 10g(W/Kg)	0.056

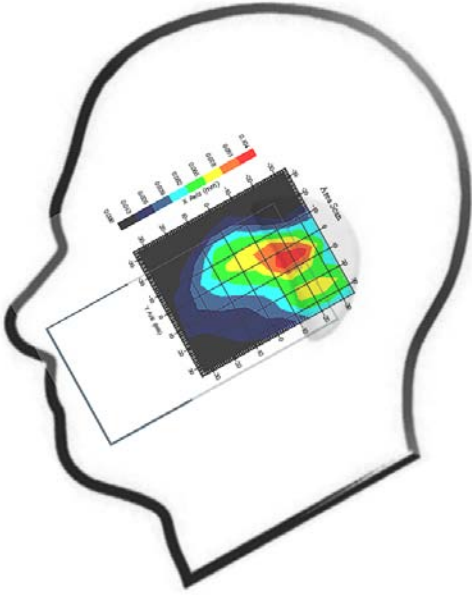
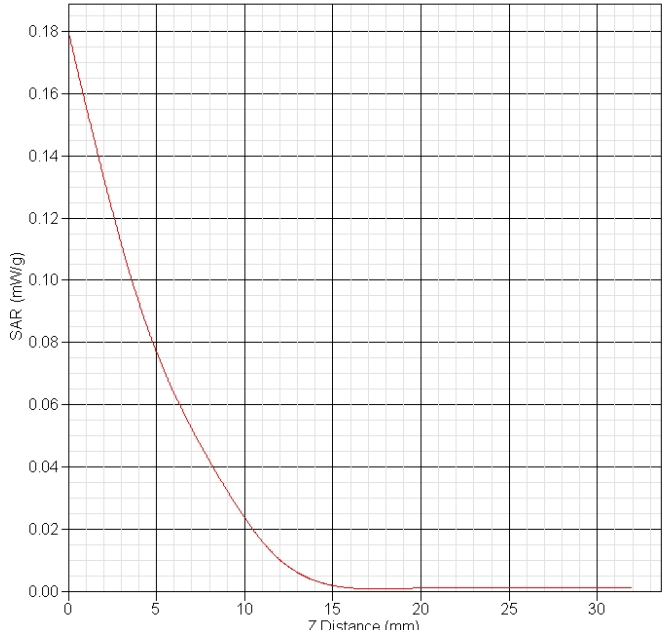
<b>802.11b body Right CH1(Hotspot)</b>	
Frequency(MHz)	2412
Relative permittivity(real part)	53.43
Conductivity(S/m)	1.94
Variation(%)	2.513
Duty Cycle Factor	1
Crest factor	1
Conversion Fator	4.4
Probe Sensitivity	1.20 1.20 1.20 $\mu V/(V/m)^2$
Data	2012-08-22
	<p>SAR-Z Axis at Hotspot x:0.06 y:-3.00</p> 
SAR 1g(W/Kg)	0.091
SAR 10g(W/Kg)	0.040

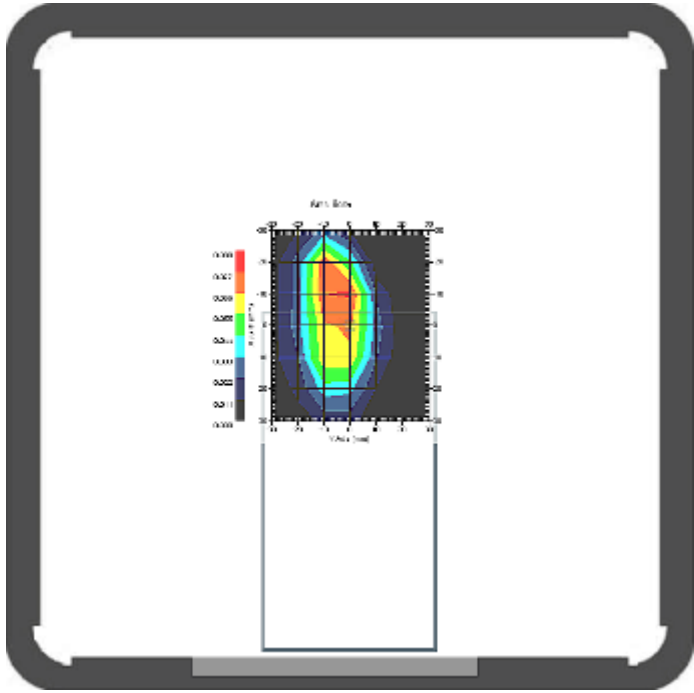
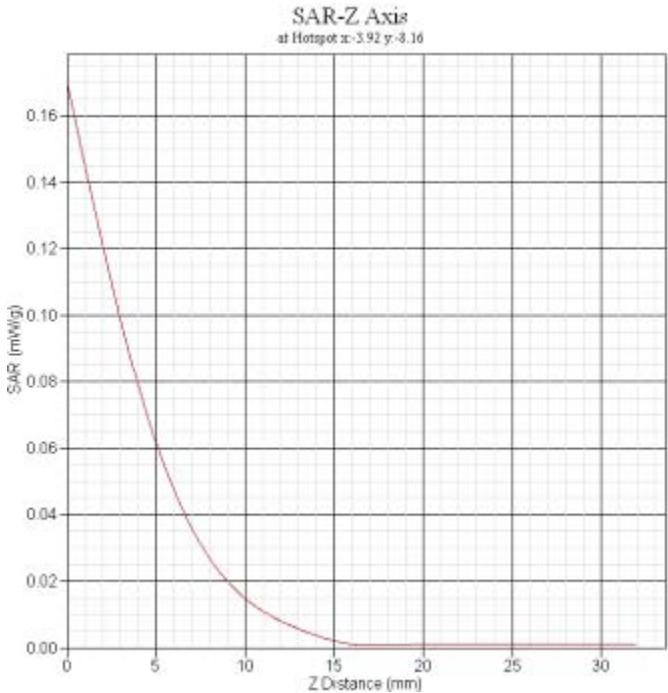
<b>802.11b body Top ch1(Hotspot)</b>	
Frequency(MHz)	2412
Relative permittivity(real part)	53.43
Conductivity(S/m)	1.94
Variation(%)	3.994
Duty Cycle Factor	1
Crest factor	1
Conversion Fator	4.4
Probe Sensitivity	1.20 1.20 1.20 $\mu V/(V/m)^2$
Data	2012-08-22
	
SAR 1g(W/Kg)	0.060
SAR 10g(W/Kg)	0.023

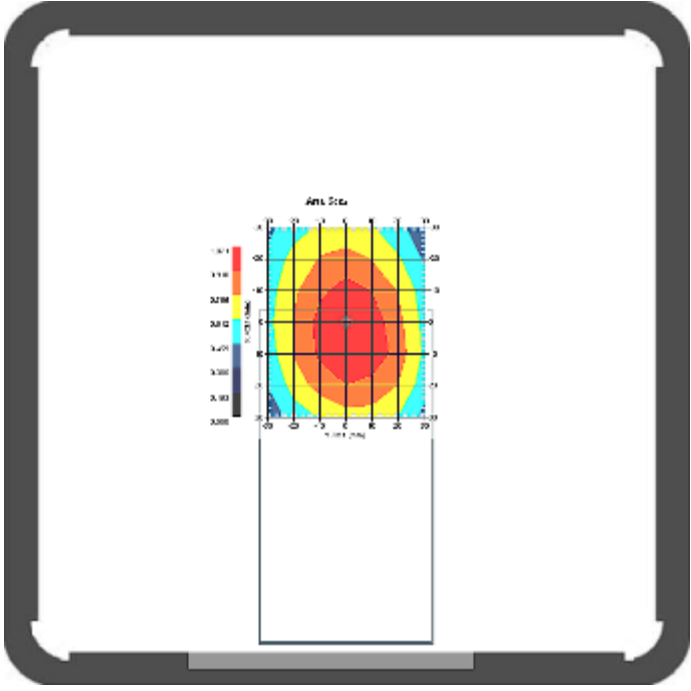
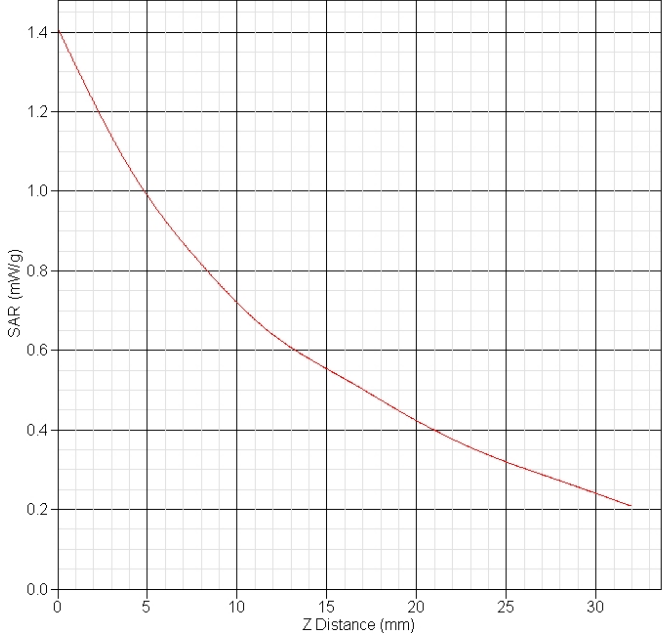
<b>GPRS850 body Back CH128</b>																			
Frequency(MHz)	824.2																		
Relative permittivity(real part)	53.31																		
Conductivity(S/m)	0.94																		
Variation(%)	0.250																		
Duty Cycle Factor	2																		
Crest factor	2																		
Conversion Fator	6.4																		
Probe Sensitivity	1.20 1.20 1.20 $\mu V/(V/m)^2$																		
Data	2012-08-22																		
	<p>SAR-Z Axis at Hotspot x:8.04 y:-0.13</p>  <table border="1"> <caption>SAR-Z Axis Data</caption> <thead> <tr> <th>Z Distance (mm)</th> <th>SAR (mW/g)</th> </tr> </thead> <tbody> <tr><td>0</td><td>1.400</td></tr> <tr><td>5</td><td>1.000</td></tr> <tr><td>10</td><td>0.750</td></tr> <tr><td>15</td><td>0.580</td></tr> <tr><td>20</td><td>0.450</td></tr> <tr><td>25</td><td>0.350</td></tr> <tr><td>30</td><td>0.280</td></tr> <tr><td>32</td><td>0.200</td></tr> </tbody> </table>	Z Distance (mm)	SAR (mW/g)	0	1.400	5	1.000	10	0.750	15	0.580	20	0.450	25	0.350	30	0.280	32	0.200
Z Distance (mm)	SAR (mW/g)																		
0	1.400																		
5	1.000																		
10	0.750																		
15	0.580																		
20	0.450																		
25	0.350																		
30	0.280																		
32	0.200																		
SAR 1g(W/Kg)	1.024																		
SAR 10g(W/Kg)	0.713																		

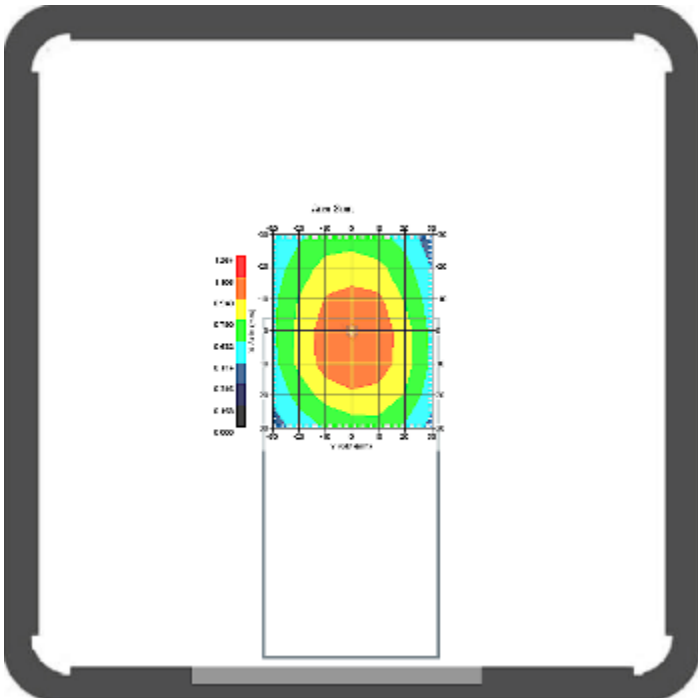
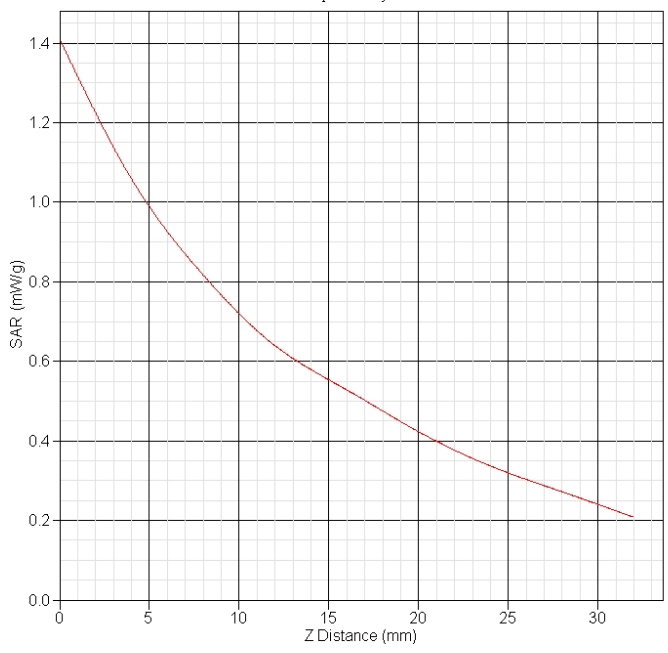
<b>GPRS850 body Back CH190</b>																	
Frequency(MHz)	836.6																
Relative permittivity(real part)	53.31																
Conductivity(S/m)	0.94																
Variation(%)	-4.909																
Duty Cycle Factor	2																
Crest factor	2																
Conversion Fator	6.4																
Probe Sensitivity	1.20 1.20 1.20 $\mu V/(V/m)^2$																
Data	2012-08-22																
	<p>SAR-Z Axis at Hotspot x:8.04 y:-0.13</p>  <table border="1"> <caption>SAR-Z Axis Data</caption> <thead> <tr> <th>Z Distance (mm)</th> <th>SAR (mW/kg)</th> </tr> </thead> <tbody> <tr><td>0</td><td>1.4</td></tr> <tr><td>5</td><td>1.0</td></tr> <tr><td>10</td><td>0.75</td></tr> <tr><td>15</td><td>0.55</td></tr> <tr><td>20</td><td>0.4</td></tr> <tr><td>25</td><td>0.3</td></tr> <tr><td>30</td><td>0.2</td></tr> </tbody> </table>	Z Distance (mm)	SAR (mW/kg)	0	1.4	5	1.0	10	0.75	15	0.55	20	0.4	25	0.3	30	0.2
Z Distance (mm)	SAR (mW/kg)																
0	1.4																
5	1.0																
10	0.75																
15	0.55																
20	0.4																
25	0.3																
30	0.2																
SAR 1g(W/Kg)	1.079																
SAR 10g(W/Kg)	0.769																

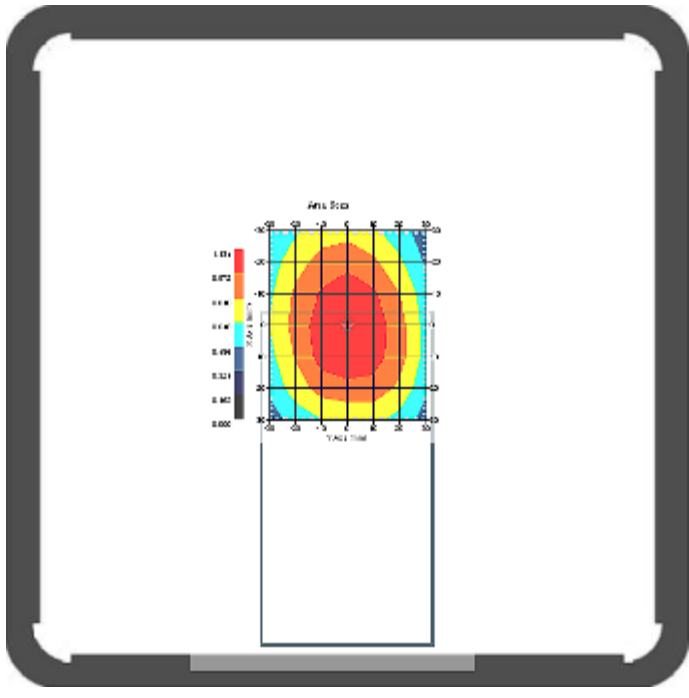
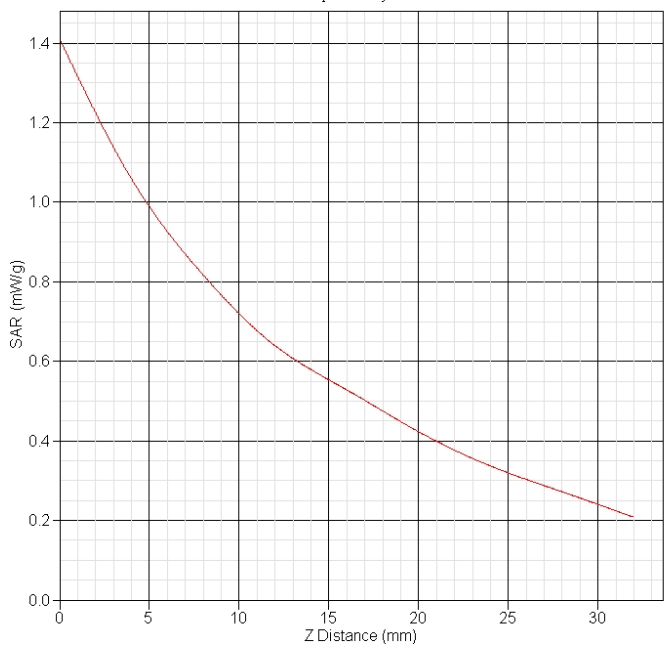
<b>GPRS850 body Back CH251</b>	
Frequency(MHz)	848.8
Relative permittivity(real part)	53.31
Conductivity(S/m)	0.94
Variation(%)	-4.909
Duty Cycle Factor	2
Crest factor	2
Conversion Fator	6.4
Probe Sensitivity	1.20 1.20 1.20 $\mu V/(V/m)^2$
Data	2012-08-22
	<p>SAR-Z Axis at Hotspot x:8.04 y:-0.13</p> 
SAR 1g(W/Kg)	1.103
SAR 10g(W/Kg)	0.783

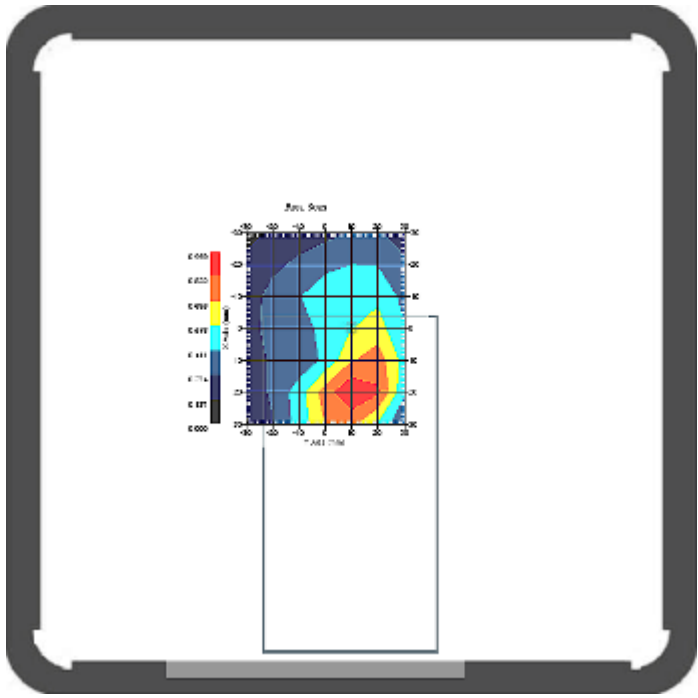
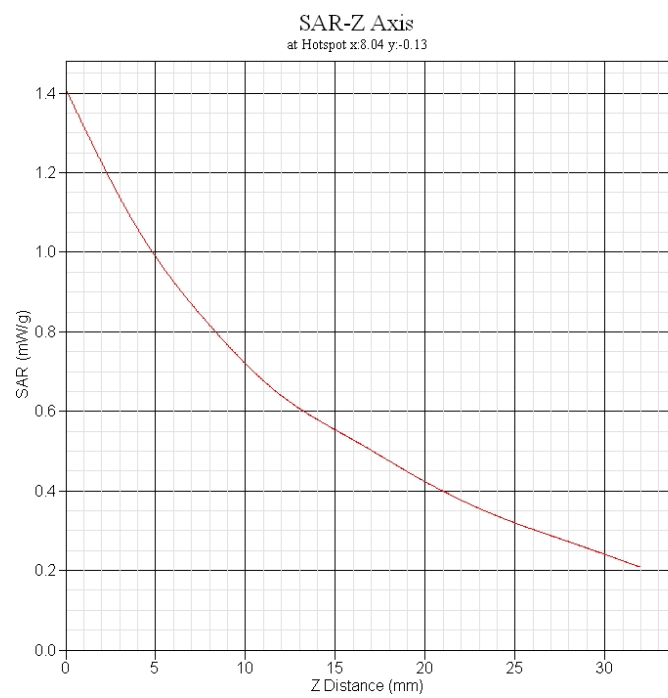

<b>GPRS1900 body Back CH512</b>	
Frequency(MHz)	1850.2
Relative permittivity(real part)	52.92
Conductivity(S/m)	1.51
Variation(%)	-0.781
Duty Cycle Factor	2
Crest factor	2
Conversion Fator	5.4
Probe Sensitivity	1.20 1.20 1.20 $\mu V/(V/m)^2$
Data	2012-08-22
	
SAR 1g(W/Kg)	0.766
SAR 10g(W/Kg)	0.470

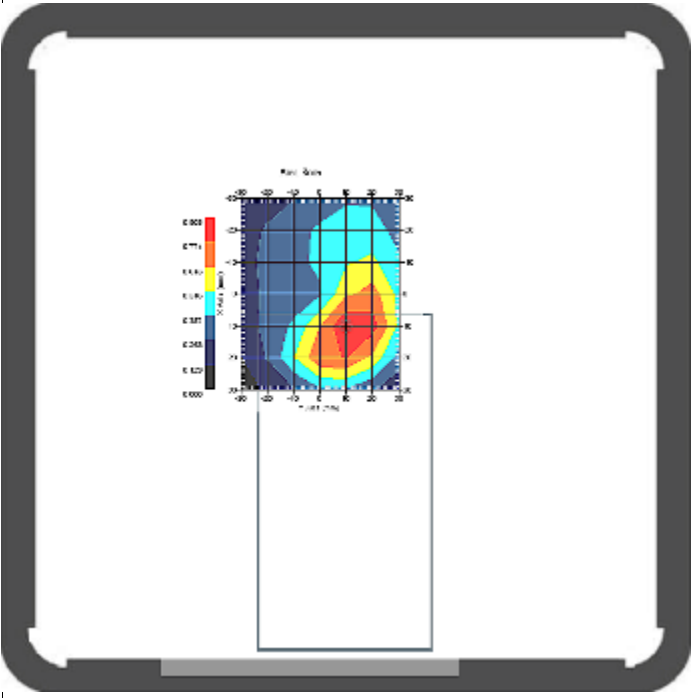
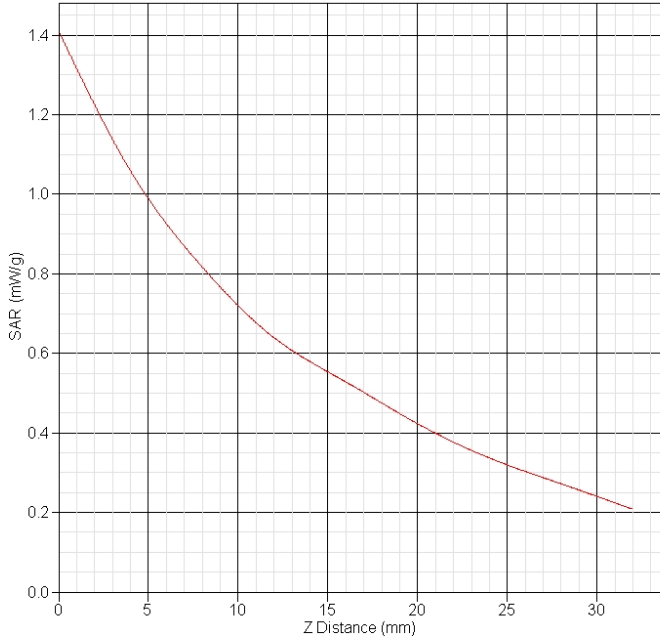
<b>WCDMA Band II body Back CH9262</b>	
Frequency(MHz)	1852.4
Relative permittivity(real part)	52.92
Conductivity(S/m)	1.51
Variation(%)	1.912
Duty Cycle Factor	1
Crest factor	1
Conversion Fator	5.4
Probe Sensitivity	1.20 1.20 1.20 $\mu V/(V/m)^2$
Data	2012-08-22
	<p>SAR-Z Axis at Hotspot x:8.04 y:-0.13</p> 
SAR 1g(W/Kg)	0.829
SAR 10g(W/Kg)	0.456

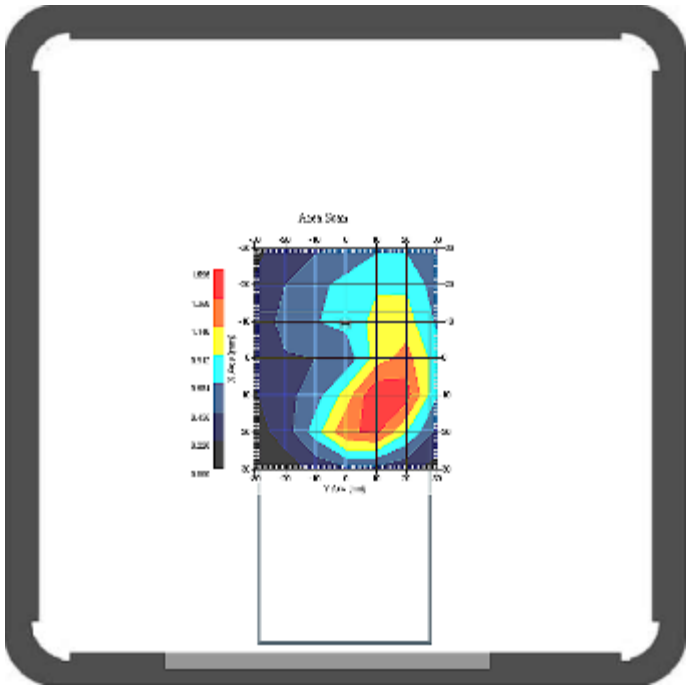
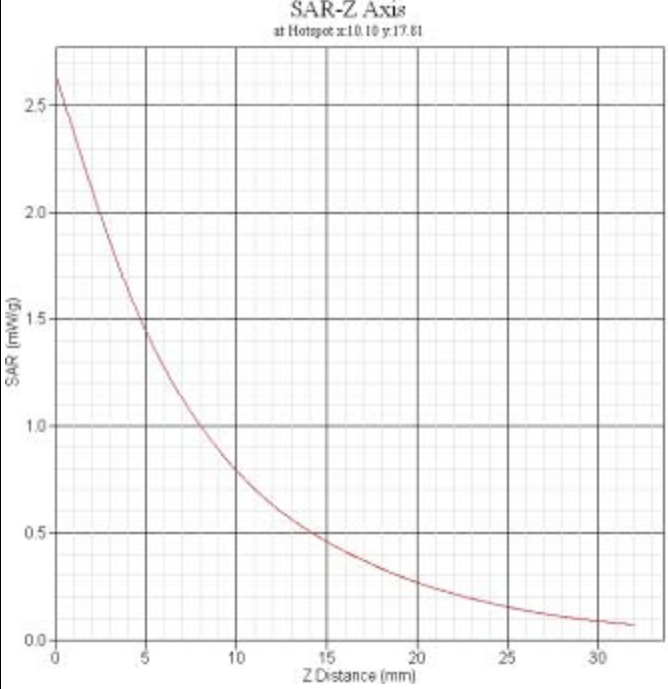
<b>WCDMA Band II body Back CH9400</b>	
Frequency(MHz)	1852.4
Relative permittivity(real part)	52.92
Conductivity(S/m)	1.51
Variation(%)	1.529
Duty Cycle Factor	1
Crest factor	1
Conversion Fator	5.4
Probe Sensitivity	1.20 1.20 1.20 $\mu V/(V/m)^2$
Data	2012-08-22
	
SAR 1g(W/Kg)	1.239
SAR 10g(W/Kg)	0.730

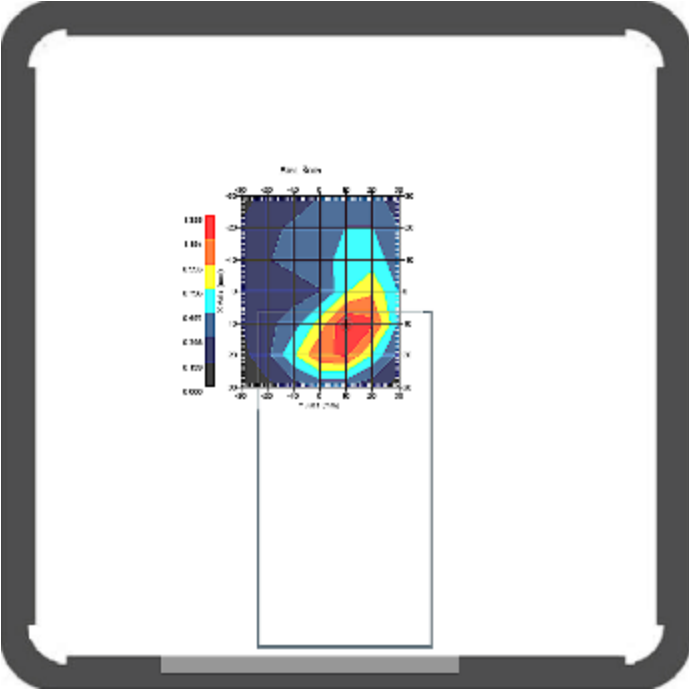
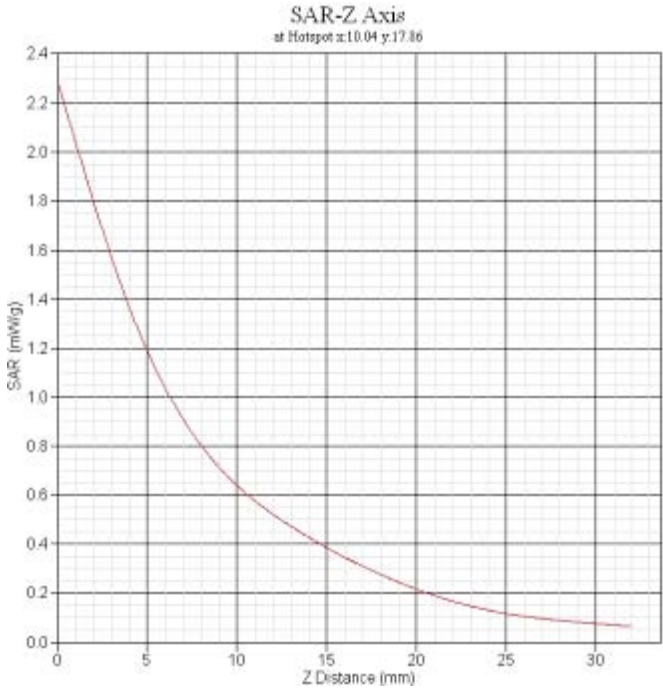
<b>WCDMA Band II body Back CH9538</b>	
Frequency(MHz)	1852.4
Relative permittivity(real part)	52.92
Conductivity(S/m)	1.51
Variation(%)	-4.767
Duty Cycle Factor	1
Crest factor	1
Conversion Fator	5.4
Probe Sensitivity	1.20 1.20 1.20 $\mu V/(V/m)^2$
Data	2012-08-22
	
SAR 1g(W/Kg)	1.200
SAR 10g(W/Kg)	0.596

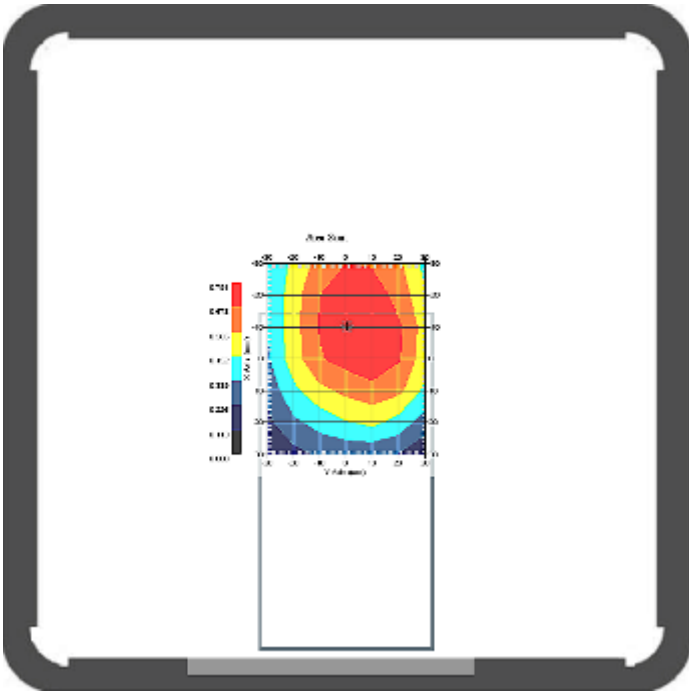
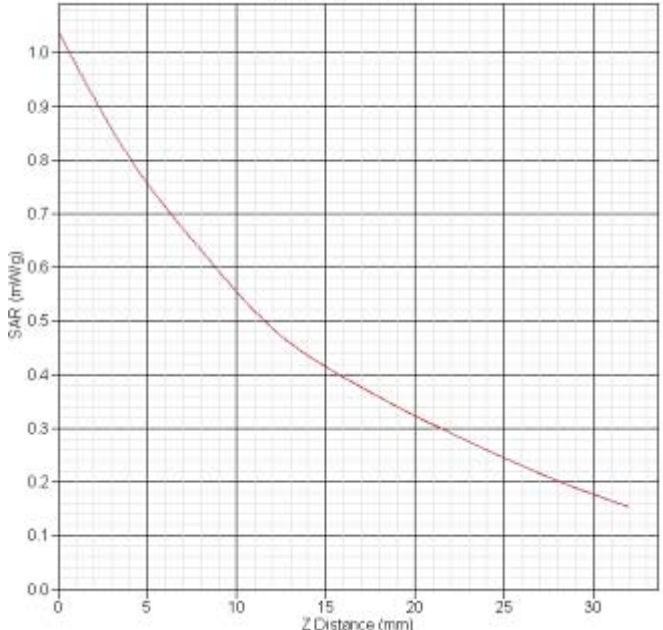
<b>WCDMA Band V body Back CH4183</b>																			
Frequency(MHz)	836.6																		
Relative permittivity(real part)	53.31																		
Conductivity(S/m)	0.94																		
Variation(%)	-2.890																		
Duty Cycle Factor	1																		
Crest factor	1																		
Conversion Fator	6.4																		
Probe Sensitivity	1.20 1.20 1.20 $\mu$ V/(V/m) <sup>2</sup>																		
Data	2012-08-22																		
	<p>SAR-Z Axis at Hotspot x:-10.01 y:1.89</p>  <table border="1"> <caption>SAR-Z Axis Data</caption> <thead> <tr> <th>Z Distance (mm)</th> <th>SAR (mW/kg)</th> </tr> </thead> <tbody> <tr><td>0</td><td>1.05</td></tr> <tr><td>5</td><td>0.75</td></tr> <tr><td>10</td><td>0.55</td></tr> <tr><td>15</td><td>0.42</td></tr> <tr><td>20</td><td>0.32</td></tr> <tr><td>25</td><td>0.25</td></tr> <tr><td>30</td><td>0.18</td></tr> <tr><td>32</td><td>0.15</td></tr> </tbody> </table>	Z Distance (mm)	SAR (mW/kg)	0	1.05	5	0.75	10	0.55	15	0.42	20	0.32	25	0.25	30	0.18	32	0.15
Z Distance (mm)	SAR (mW/kg)																		
0	1.05																		
5	0.75																		
10	0.55																		
15	0.42																		
20	0.32																		
25	0.25																		
30	0.18																		
32	0.15																		
SAR 1g(W/Kg)	0.750																		
SAR 10g(W/Kg)	0.513																		

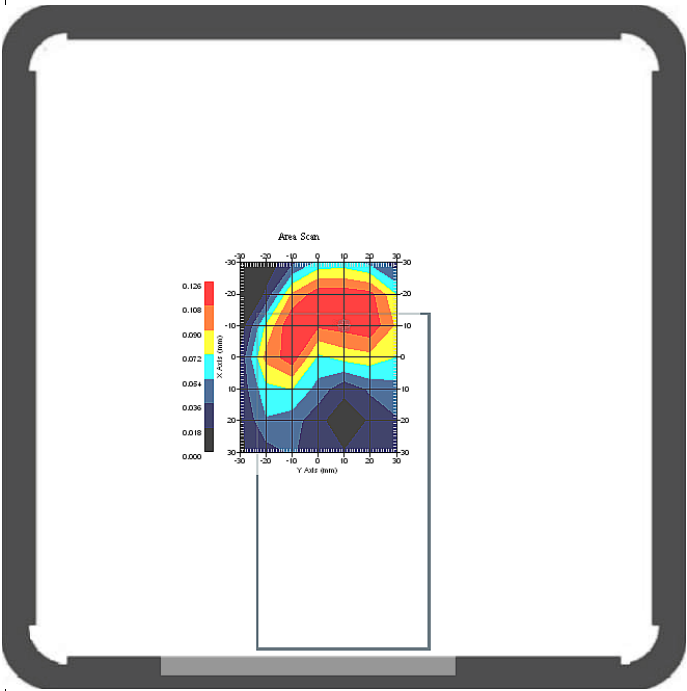
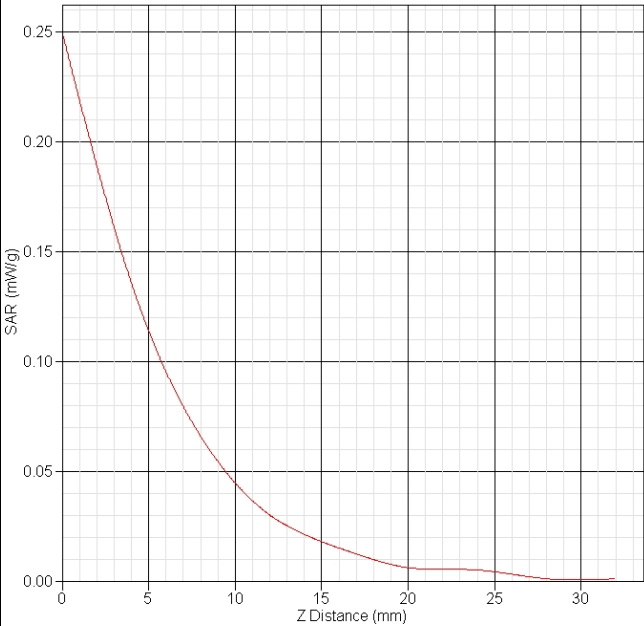
<b>802.11b body Back ch1</b>	
Frequency(MHz)	2412
Relative permittivity(real part)	53.43
Conductivity(S/m)	1.94
Variation(%)	0.326
Duty Cycle Factor	1
Crest factor	1
Conversion Fator	4.4
Probe Sensitivity	1.20 1.20 1.20 $\mu$ V/(V/m) <sup>2</sup>
Data	2012-08-22
	<p>SAR-Z Axis at Hotspot x:-18.00 y:11.92</p> 
SAR 1g(W/Kg)	0.121
SAR 10g(W/Kg)	0.049

ValidationDipole Calibration

Electrical Specification 835MHz

Tissue Type	Return Loss(dB)	Impedance(ohm)
Head(2011)	-26.655	51.666
Head(2012 recent)	-26.669	52.536
Body(2011)	-22.106	57.482
Body(2012 recent)	-22.595	54.711

## Head Tissue of Return Loss(2011)

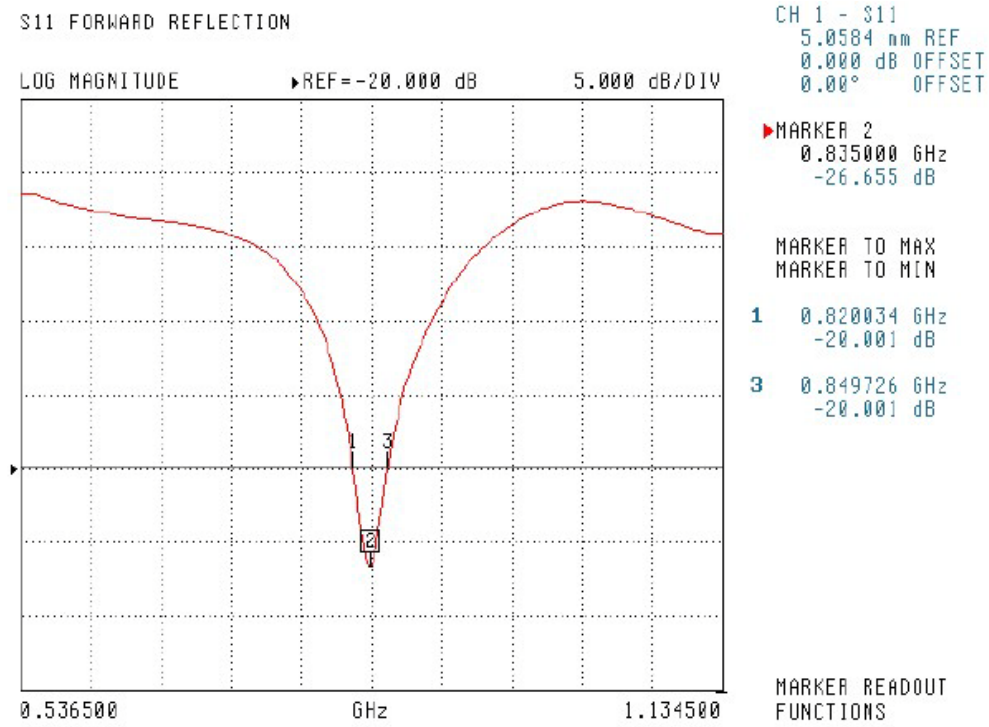

## Head Tissue of Return Loss(2012 recent)

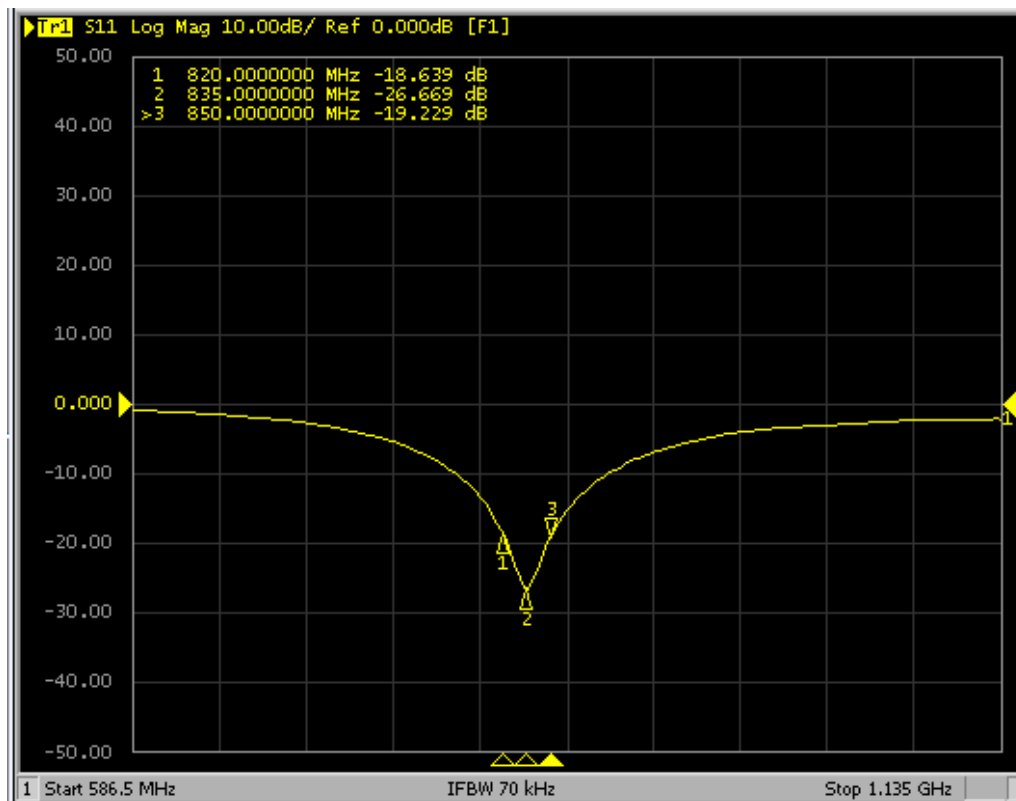



### Body Tissue of Return Loss(2011)

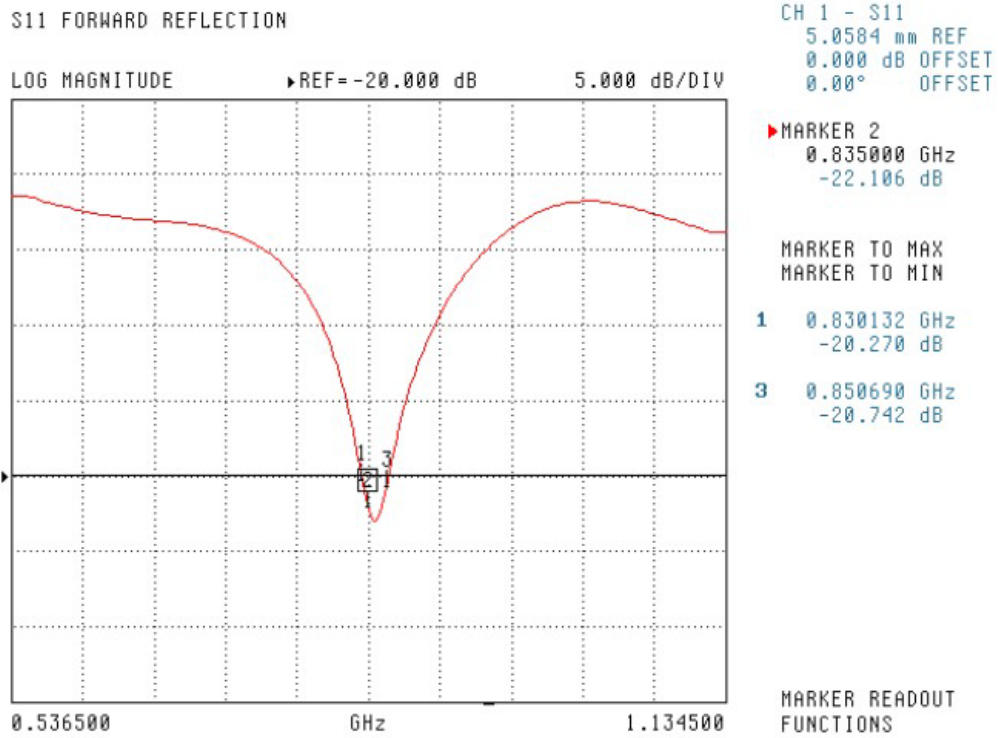

### Body Tissue of Return Loss(2012 recent)

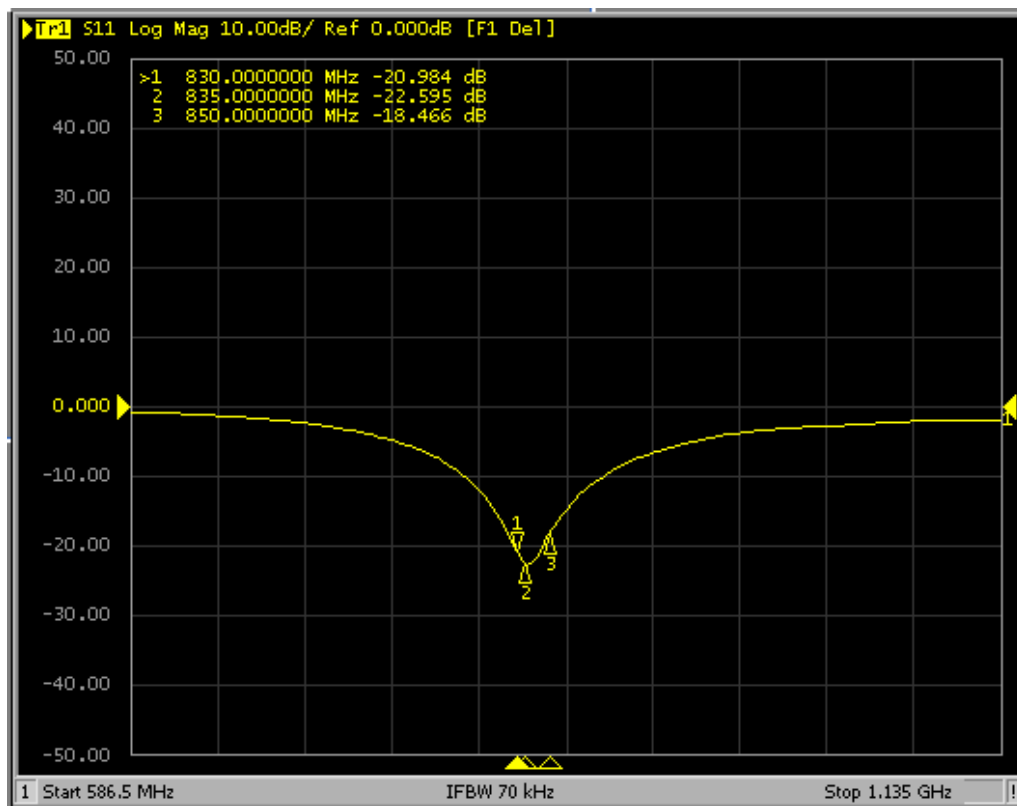

### Head Tissue of Impedance(2011)

S11 FORWARD REFLECTION  
IMPEDANCE

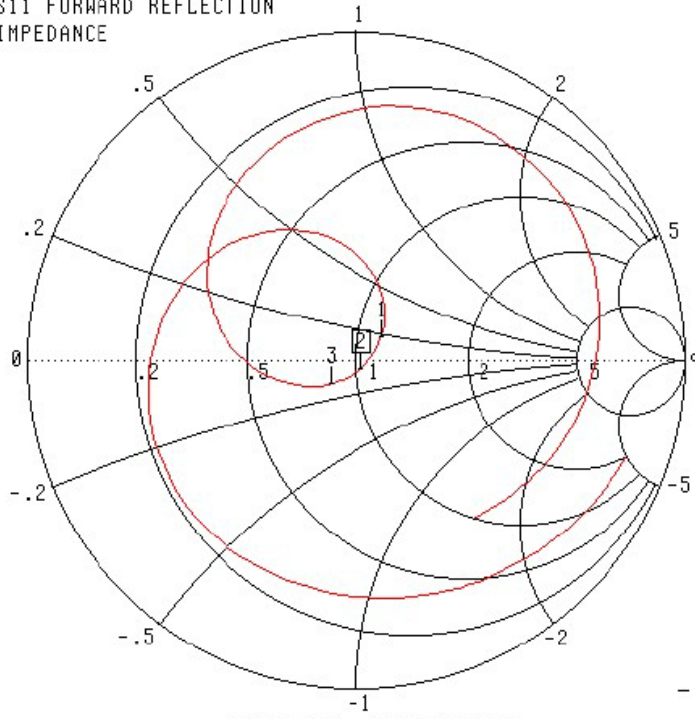

CH 1 - S11  
5.0584 mm REF  
0.000 dB OFFSET  
0.00° OFFSET

▶ MARKER 2  
0.835000 GHz  
51.666 Ω  
-3.088 jΩ

MARKER TO MAX  
MARKER TO MIN

1 0.820034 GHz  
58.289 Ω  
7.884 jΩ  
3 0.849726 GHz  
42.682 Ω  
-6.400 jΩ

MARKER READOUT  
FUNCTIONS

### Head Tissue of Impedance(2012 recent)

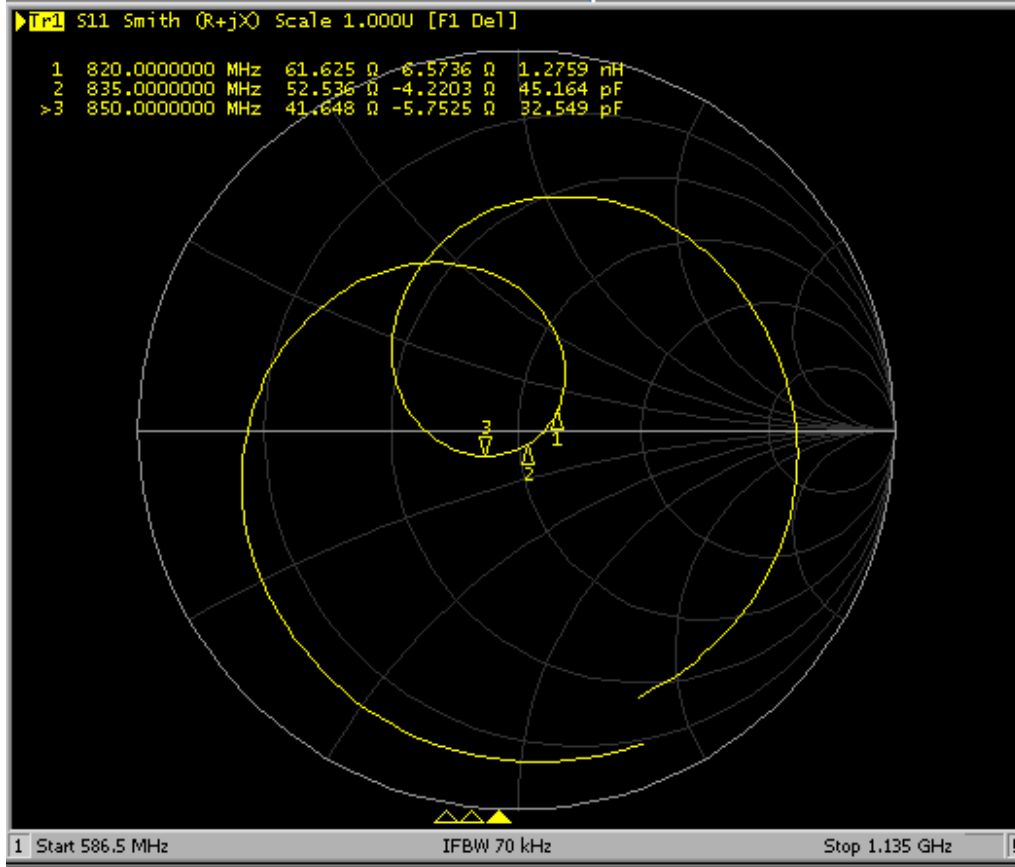

## Body Tissue of Impedance(2011)

S11 FORWARD REFLECTION  
IMPEDANCE

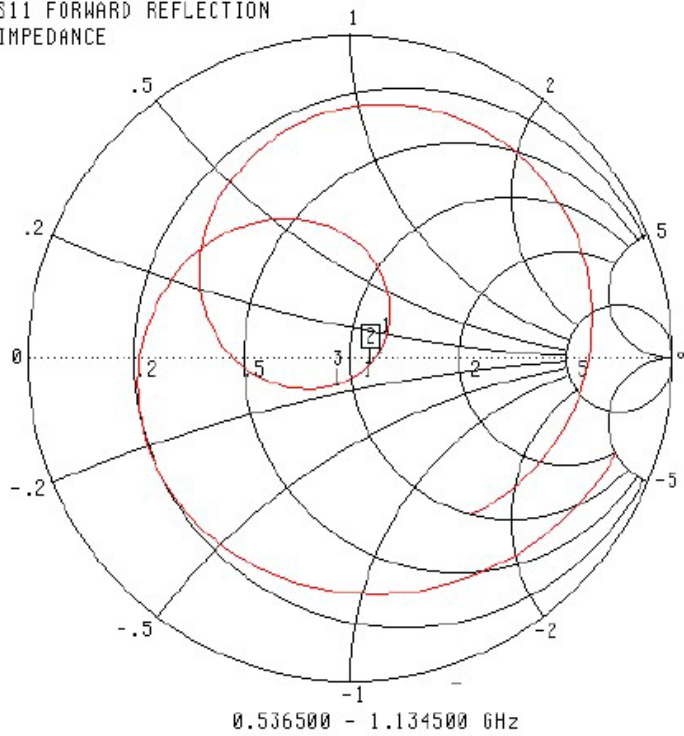

CH 1 - S11  
5.0584 mm REF  
0.000 dB OFFSET  
0.00° OFFSET

▶ MARKER 2  
0.835000 GHz  
57.482 Ω  
-2.174 jΩ

MARKER TO MAX  
MARKER TO MIN

1 0.830132 GHz  
60.468 Ω  
1.077 jΩ  
3 0.850690 GHz  
46.231 Ω  
-7.943 jΩ

MARKER READOUT  
FUNCTIONS

## Body Tissue of Impedance(2012 recent)

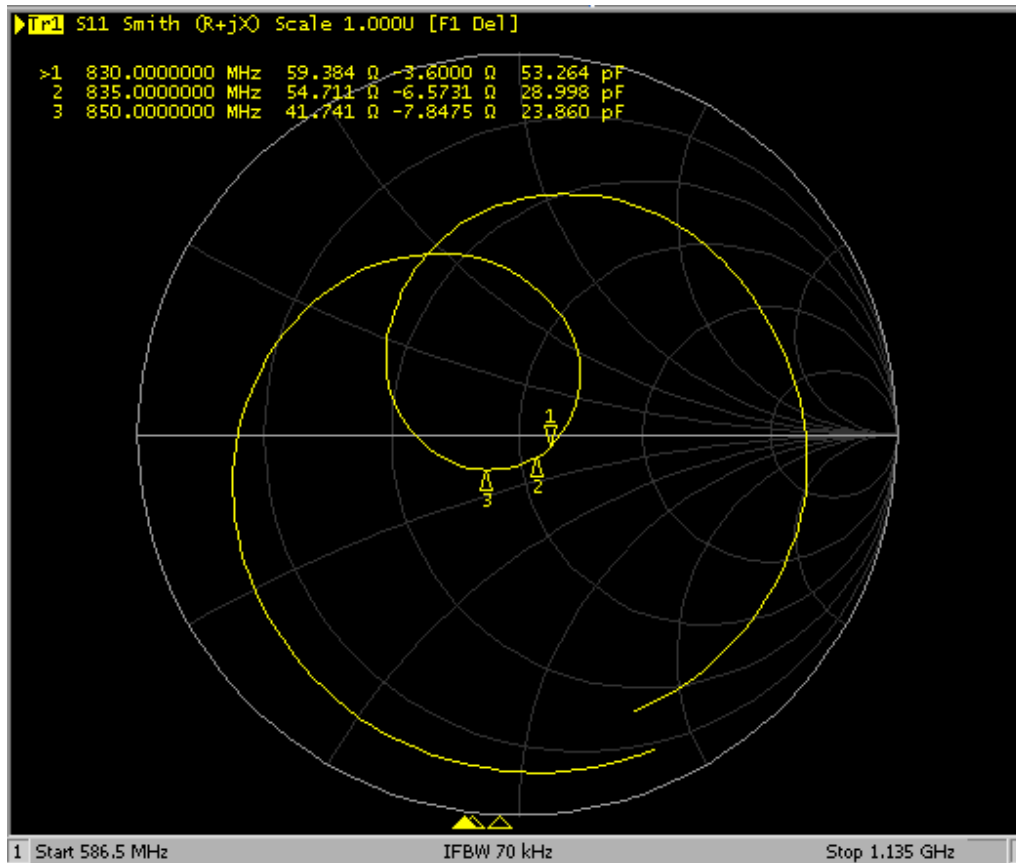

## Validation Dipole Calibration

### Electrical Specification 1900MHz

Tissue Type	Return Loss(dB)	Impedance(ohm)
Head(2011)	-31.943	51.262
Head(2012 recent)	-33.275	49.302
Body(2011)	-25.099	53.750
Body(2012 recent)	-25.606	50.197

### Head Tissue of Return Loss(2011)

S11 FORWARD REFLECTION

LOG MAGNITUDE      REF=-20.000 dB      6.000 dB/DIV

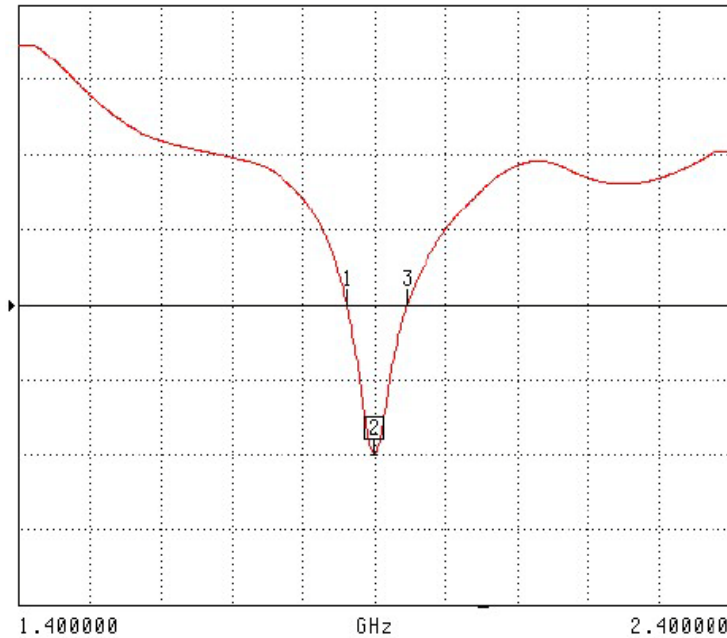

CH 1 - S11  
5.0584 mm REF  
0.000 dB OFFSET  
0.00° OFFSET

▶ MARKER 2  
1.900000 GHz  
-31.943 dB

MARKER TO MAX  
MARKER TO MIN

1 1.861600 GHz  
-20.021 dB

3 1.946000 GHz  
-20.003 dB

MARKER READOUT  
FUNCTIONS

### Head Tissue of Return Loss(2012 recent)

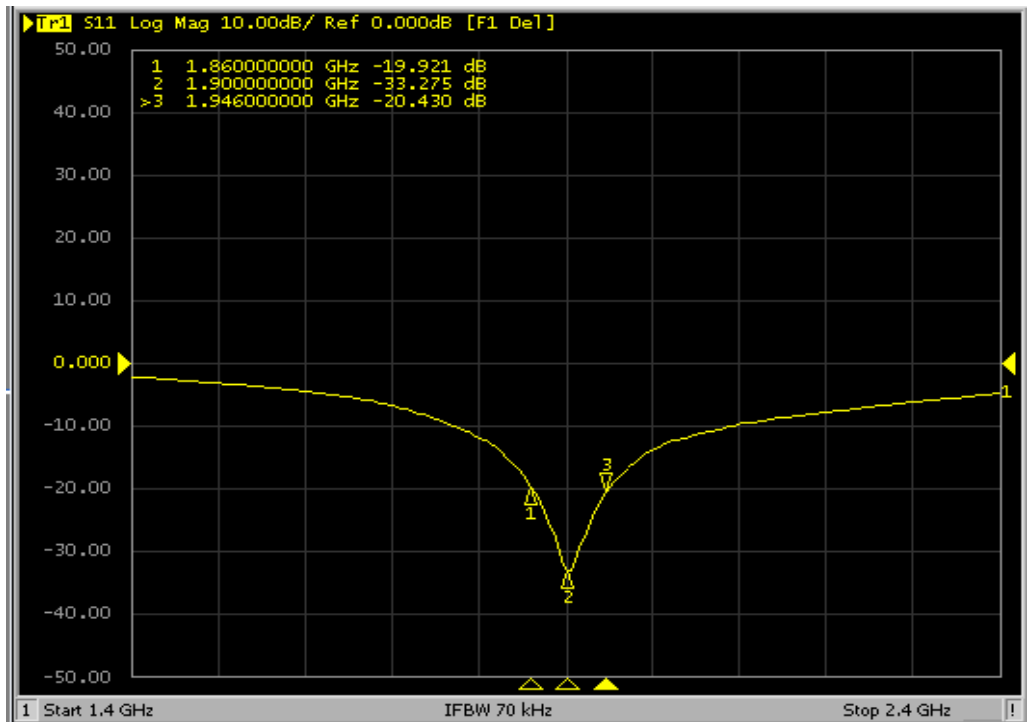

Body Tissue of Return Loss(2011)

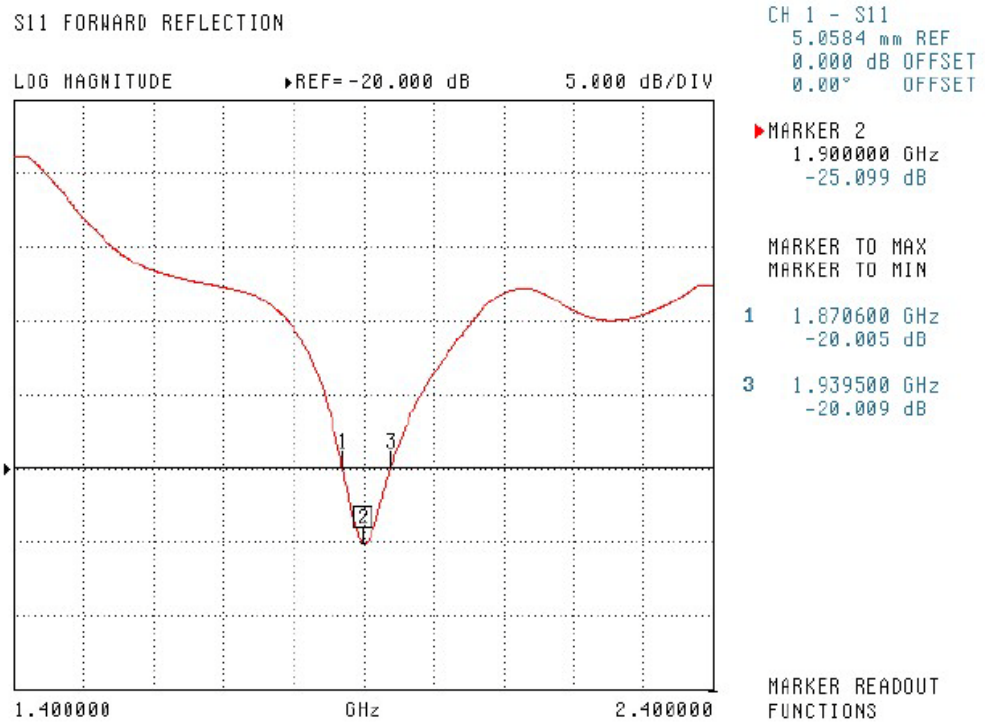

Body Tissue of Return Loss(2012 recent)

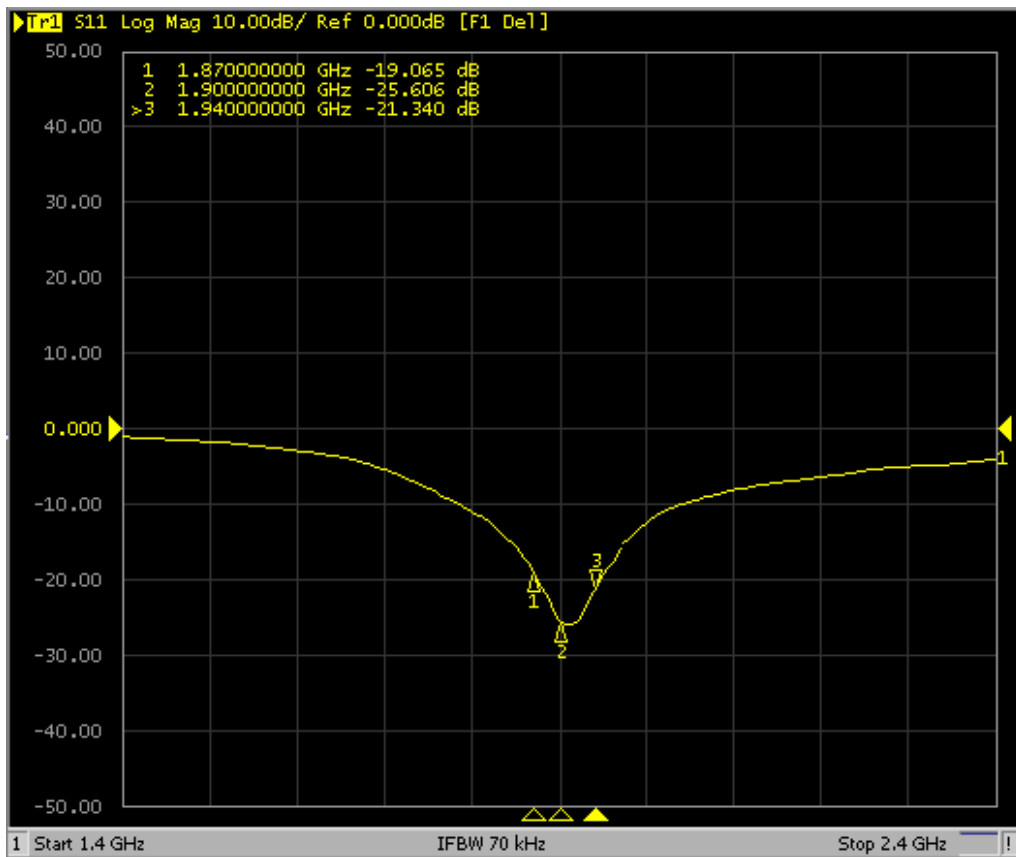

### Head Tissue of Impedance(2011)

S11 FORWARD REFLECTION  
IMPEDANCE

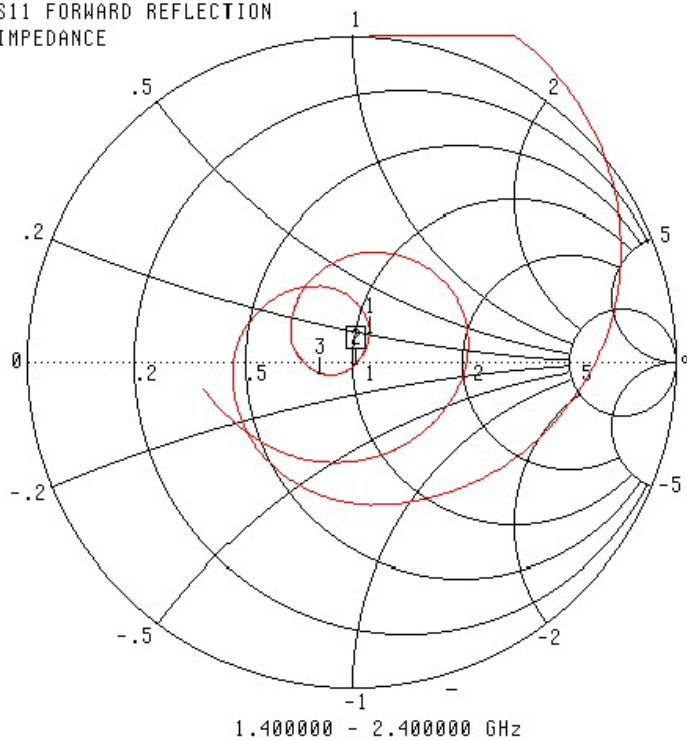

CH 1 - S11  
5.0584 mm REF  
0.000 dB OFFSET  
0.00° OFFSET

▶ MARKER 2  
1.900000 GHz  
51.262 Ω  
-1.179 jΩ

MARKER TO MAX  
MARKER TO MIN

1 1.861600 GHz  
55.137 Ω  
9.602 jΩ  
3 1.946000 GHz  
41.175 Ω  
-3.077 jΩ

MARKER READOUT  
FUNCTIONS

### Head Tissue of Impedance(2012 recent)

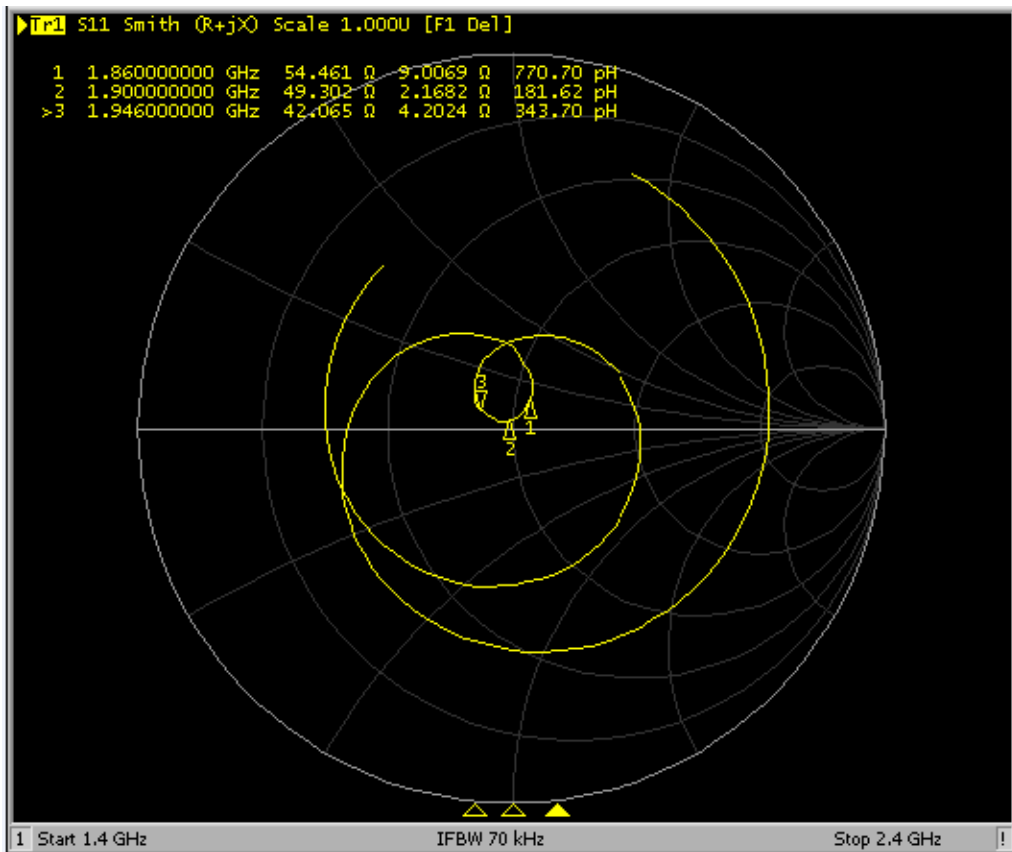

Body Tissue of Impedance(2011)

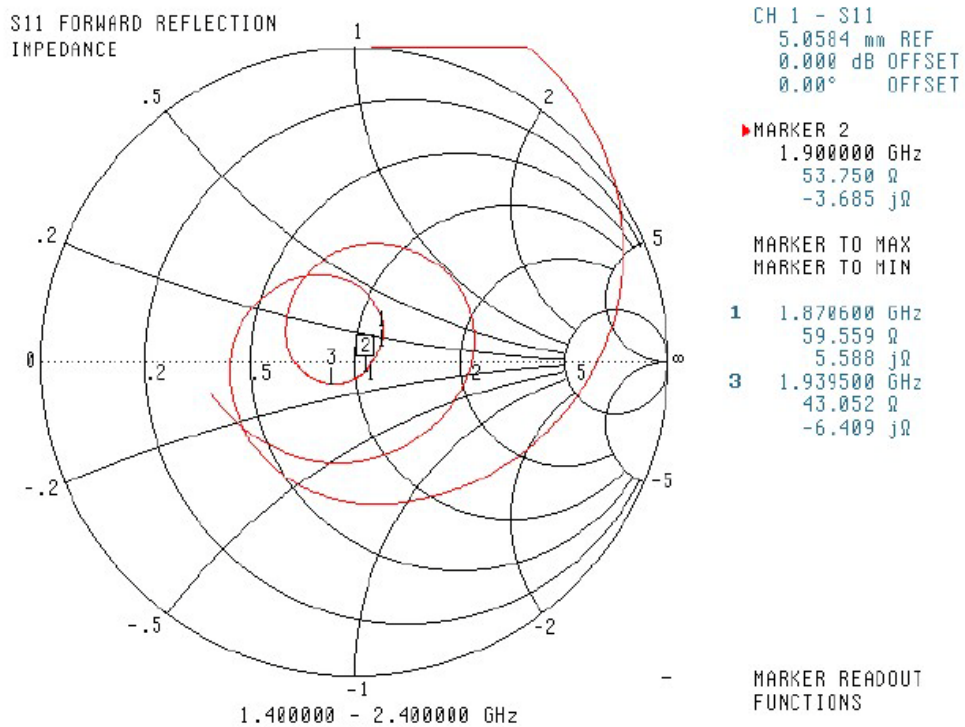

Body Tissue of Impedance(2012 recent)

