

# SAR TEST REPORT



Report No: 17070523-FCC-H

Supersede Report No.: N/A

Applicant	MFOURTEL MEXICO S.A. DE C.V.	
Product Name	LTE Mobile Phone	
Model No.	M4 SS4453-R	
Standards	FCC 47 CFR Part2(2.1093) ANSI/IEEE C95.1-1999 IEEE 1528-2013 & Published RF Exposure KDB Procedures	
Test Date	Jun 23 to Jul 5, 2017	
Issue Date	Jul 28, 2017	
Test Result	PASS	
Equipment complied with the specification	<input checked="" type="checkbox"/>	
Equipment did not comply with the specification	<input type="checkbox"/>	
		
York Liu Test Engineer	Wiky Zhang Checked By	
This test report may be reproduced in full only Test result presented in this test report is applicable to the tested sample only		

Issued by:

**SIEMIC (SHENZHEN-CHINA) LABORATORIES**

Zone A, Floor 1, Building 2 Wan Ye Long Technology Park

South Side of Zhoushi Road, Bao'an District, Shenzhen, Guangdong China 518108

Phone: +86 0755 2601 4629801 Email: [China@siemic.com.cn](mailto:China@siemic.com.cn)

## Laboratory Introduction

SIEMIC, headquartered in the heart of Silicon Valley, with superior facilities in US and Asia, is one of the leading independent testing and certification facilities providing customers with one-stop shop services for Compliance Testing and Global Certifications.



In addition to testing and certification, SIEMIC provides initial design reviews and compliance management throughout a project. Our extensive experience with China, Asia Pacific, North America, European, and International compliance requirements, assures the fastest, most cost effective way to attain regulatory compliance for the global markets.

### Accreditations for Conformity Assessment

Country/Region	Scope
USA	EMC, RF/Wireless, SAR, Telecom
Canada	EMC, RF/Wireless, SAR, Telecom
Taiwan	EMC, RF, Telecom, SAR, Safety
Hong Kong	RF/Wireless, SAR, Telecom
Australia	EMC, RF, Telecom, SAR, Safety
Korea	EMI, EMS, RF, SAR, Telecom, Safety
Japan	EMI, RF/Wireless, SAR, Telecom
Singapore	EMC, RF, SAR, Telecom
Europe	EMC, RF, SAR, Telecom, Safety

Test Report	17070523-FCC-H
Page	3 of 176

This page has been left blank intentionally.

Test Report	17070523-FCC-H
Page	4 of 176

**CONTENTS**

1	EUT INFORMATION.....	5
2	TECHNICAL DETAILS .....	7
3	INTRODUCTION .....	8
4	SAR MEASUREMENT SETUP .....	9
5	ANSI/IEEE C95.1 – 1999 RF EXPOSURE LIMIT .....	20
6	SYSTEM AND LIQUID VERIFICATION .....	21
7	UNCERTAINTY ASSESSMENT .....	37
8	TEST INSTRUMENT .....	40
9	OUTPUT POWER VERIFICATION .....	41
10	SAR TEST RESULTS.....	67
11	SAR MEASUREMENT REFERENCES.....	76
	ANNEX A CALIBRATION REPORTS .....	95
	ANNEX B SAR SYSTEM PHOTOGRAPHS.....	171
	ANNEX C SETUP PHOTOGRAPHS .....	172

# 1 EUT INFORMATION

<u>EUT Information</u>	
<b>EUT Description</b>	LTE Mobile Phone
<b>Model No</b>	M4 SS4453-R
<b>Input Power</b>	Lithium-polymer Model: M3000A Spec: 3.85V,3000mAh,11.55Wh Limited charge voltage:4.4V
<b>Maximum Conducted Output Power to Antenna</b>	GSM 850 Voice : 32.18dBm PCS1900 Voice: 30.28dBm WCDMA Band V (Class 3): 22.30dBm WCDMA Band II (Class 3): 22.94dBm LTE Band 2(Class 3): 23.61dBm LTE Band 4(Class 3): 23.67dBm LTE Band 7(Class 3): 22.67dBm LTE Band 13(Class 3): 23.38dBm 2.4G WIFI:12.40dBm
<b>LTE Bandwidths</b>	LTE Band 2(PCS):1.4MHz, 3MHz, 5MHz, 10MHz, 15MHz, 20MHz LTE Band 4(AWS): 1.4MHz, 3MHz, 5MHz, 10MHz, 15MHz, 20MHz LTE Band 7(IMT-E): 5MHz, 10MHz, 15MHz, 20MHz LTE Band13(IMT-E): 5MHz, 10MHz
<b>Highest Reported SAR Level(s)</b>	0.82W/Kg 1g Head Tissue 1.16W/Kg 1g Body Tissue
<b>Classification Per Stipulated Test Standard</b>	Portable Device, Class B, No DTM Mode
<b>Multi-SIM</b>	Support dual-SIM, dual standby, the multiple SIM card with two lines cannot transmitting at the same time.
<b>Co-located TX</b>	WWAN can transmit simultaneously with Bluetooth WIFI cannot transmit simultaneously with Bluetooth WWAN can transmit simultaneously with WiFi
<b>Antenna Separation distances</b>	12.7cm - WWAN antenna-to-WIFI/Bluetooth antenna
<b>Antenna Type(s)</b>	PIFA Antenna(WWAN)
<b>Accessory</b>	N/A

### SAR Test Result

Equipment Class	Frequency Band		Highest 1g SAR Summary			Highest Simultaneous Transmission 1g SAR(W/kg)
			Head (Separation 0mm)	Body (Separation 10mm)	Hotspot (Separation 10mm)	
			1g SAR(W/kg)			
Licensed	GSM	GSM850	0.44	<b>1.16</b>	<b>1.16</b>	<b>1.58</b>
		GSM1900	0.37	0.63	0.63	
	WCDMA	WCDMA II	0.41	0.72	0.72	
		WCDMA V	0.25	0.41	0.41	
	LTE	LTE Band 2	0.46	1.07	1.07	
		LTE Band 4	0.37	1.02	1.02	
		LTE Band 7	0.49	0.86	0.86	
	LTE Band 13	0.15	0.33	0.33		
DTS	WIFI	2.4G	<b>0.82</b>	0.42	0.42	
Date of Testing:			Jun 23 , 2017~ Jul 5 , 2017			

## 2 TECHNICAL DETAILS

<b>Purpose</b>	Compliance testing of LTE Mobile Phone model M4 SS4453-R with stipulated standard
<b>Applicant / Client</b>	MFOURTEL MEXICO S.A. DE C.V. Av. Ejército Nacional 436 Piso 3 Chapultepec Morales Miguel Hidalgo Distrito Federal 11570.
<b>Manufacturer</b>	CK Telecom Limited Technology Road.High-Tech Development Zone. Heyuan, Guangdong,P.R.China.
<b>Laboratory performing the tests</b>	SIEMIC(Shenzhen-China) Laboratories Zone A, Floor 1, Building 2, Wan Ye Long Technology Park, South Side of Zhoushi Road, Bao'an District, Shenzhen 518108, Guangdong, P.R.C. Tel: +(86) 0755-26014629 VIP Line:950-4038-0435
<b>Software Version</b>	OpenSAR V4_02_31
<b>Test report reference number</b>	17070523-FCC-H
<b>Date EUT received</b>	Jun 22 , 2017
<b>Standard applied</b>	See Page 76
<b>Dates of test (from – to)</b>	Jun 23, 2017 to Jul 5, 2017
<b>No of Units:</b>	1
<b>Equipment Category:</b>	PCE
<b>Trade Name:</b>	M4
<b>Model Name:</b>	M4 SS4453-R
<b>RF Operating Frequency (ies)</b>	GSM850 TX : 824.2 ~ 848.8 MHz; RX : 869.2 ~ 893.8 MHz PCS1900 TX : 1850.2 ~ 1909.8 MHz; RX : 1930.2 ~ 1989.8 MHz UMTS-FDD Band V TX : 826.4 ~ 846.6 MHz; RX : 871.4 ~ 891.6 MHz UMTS-FDD Band II TX :1852.4 ~ 1907.6 MHz; RX : 1932.4 ~ 1987.6 MHz LTE Band 2 TX: 1850.7 ~ 1909.3MHz; RX : 1930.7 ~ 1989.3 MHz LTE Band 4 TX: 1710.7 ~ 1754.3 MHz; RX : 2110.7~ 2154.3 MHz LTE Band 7 TX: 2500~2570MHz; RX : 2620~2690 MHz LTE Band 13 TX: 777~787MHz; RX : 746~756MHz BT& BLE:2402~ 2480MHz(TX/RX) WIFI:802.11b/g/n(20M): 2412-2462 MHz(TX/RX) WIFI: 802.11n(40M): 2422-2452 MHz(TX/RX) GPS:1575.42MHz(Rx)
<b>Modulation:</b>	GSM / GPRS: GMSK EGPRS: GMSK,8PSK UMTS-FDD: QPSK LTE Band: QPSK, 16QAM 802.11b/g/n: DSSS, OFDM Bluetooth: GFSK, $\pi$ /4-DQPSK, 8DPSK BLE: GFSK WIFI: DSSS, OFDM GPS:BPSK
<b>GPRS/EGPRS Multi-slot class</b>	8/10/12
<b>FCC ID</b>	CLNSS4453-R

## 3 INTRODUCTION

### Introduction

This measurement report shows compliance of the EUT with ANSI/IEEE C95.1-1999 and FCC 47 CFR Part2 (2.1093)

The test procedures, as described in IEEE 1528-2013 Standard for IEEE Recommended Practice for Determining the Peak Spatial-Average Specific Absorption Rate (SAR) in the Human Head from Wireless Communications Devices: Measurement Techniques(300MHz~6GHz) and Published RF Exposure KDB Procedures

### SAR Definition

Specific Absorption Rate is defined as the time derivative (rate) of the incremental energy (dW) absorbed by (dissipated in) an incremental mass (dm) contained in a volume element (dV) of a given density ( $\rho$ ).

$$SAR = \frac{d}{dt} \left( \frac{dW}{dm} \right) = \frac{d}{dt} \left( \frac{dW}{\rho dV} \right)$$

SAR is expressed in units of watts per kilogram (W/kg). SAR can be related to the electric field at a point by

$$SAR = \frac{\sigma |E|^2}{\rho}$$

where:

- $\sigma$  = conductivity of the tissue (S/m)
- $\rho$  = mass density of the tissue (kg/m<sup>3</sup>)
- E = rms electric field strength (V/m)



## 4 SAR MEASUREMENT SETUP

### Dosimetric Assessment System

These measurements were performed with the automated near-field scanning system OPENSAR from SATIMO. The system is based on a high precision robot (working range: 850 mm), which positions the probes with a positional repeatability of better than  $\pm 0.02$  mm. Special E- and H-field probes have been developed for measurements close to material discontinuity, the sensors of which are directly loaded with a Schottky diode and connected via highly resistive lines to the data acquisition unit.

The SAR measurements were conducted with dosimetric probe (manufactured by SATIMO), designed in the classical triangular configuration and optimized for dosimetric evaluation. The probe has been calibrated according to the procedure described in SAR standard with accuracy of better than  $\pm 10\%$ . The spherical isotropy was evaluated with the procedure described in SAR standard and found to be better than  $\pm 0.25$  dB. The phantom used was the SAM Phantom as described in FCC supplement C, IEEE P1528 and CENELEC EN62209-1.

### Measurement System Diagram

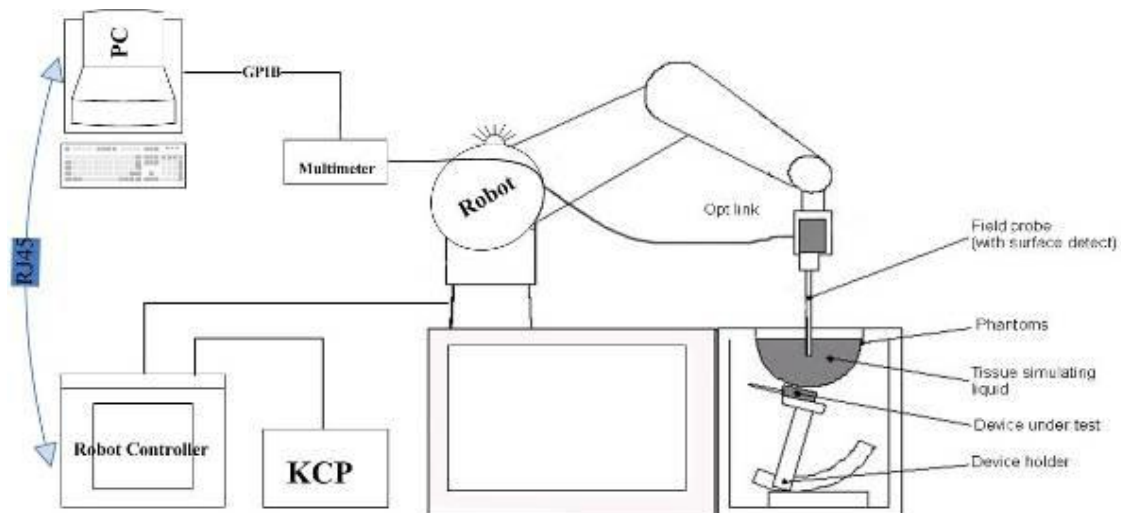

**The OPENSAR system for performing compliance tests consist of the following items:**

1. A standard high precision 6-axis robot (KUKA) with controller and software.
2. KUKA Control Panel (KCP).
3. A dosimetric probe, i.e., an isotropic E-field probe optimized and calibrated for usage in tissue simulating liquid. The probe is equipped with an optical surface detector system.
4. The functions of the PC plug-in card are to perform the time critical task such as signal filtering, surveillance of the robot operation fast movement interrupts.

5. A computer operating Windows XP.
6. OPENSAR software.
7. Remote control with teaches pendant and additional circuitry for robot safety such as warning lamps, etc.
8. The SAM phantom enabling testing left-hand right-hand and body usage.
9. The Position device for handheld EUT.
10. Tissue simulating liquid mixed according to the given recipes (see Application Note).
11. System validation dipoles to validate the proper functioning of the system.

## EP100 Probe



Construction Symmetrical design with triangular Core. Built-in shielding against static charges Calibration in air from 100 MHz to 2.5 GHz. In brain and muscle simulating tissue at frequencies from 800 to 6000 MHz (accuracy of 8%) .

Frequency 100 MHz to 6 GHz;

Linearity ; 0.25 dB (100 MHz to 6 GHz) ,

Directivity : 0.25 dB in brain tissue (rotation around probe axis) 0.5 dB in brain tissue (rotation normal probe axis)

Dynamic : 0.001W/kg to > 100W/kg;

Range Linearity: 0.25 dB

Surface : 0.2 mm repeatability in air and liquids

Dimensions Overall length: 330 mm

Tip length: 16 mm

Body diameter: 8 mm

Tip diameter: 2.6 mm

Distance from probe tip to dipole centers: <1.5 mm

Application General dosimetric up to 6 GHz

Compliance tests of GSM 5.0' ' LTE LTE Mobile Phones

Fast automatic scanning in arbitrary phantoms

The SAR measurements were conducted with the dosimetric probe designed in the classical triangular configuration and optimized for dosimetric evaluation. The probe is constructed using the thick film technique, with printed resistive lines on ceramic substrates.

It is connected to the KRC box on the robot arm and provides an automatic detection of the phantom surface. The 3D file of the phantom is include in OpenSAR software. The Video Positioning System allow the system to take the automatic reference and to move the probe safely and accurately on the phantom.

### E-Field Probe Calibration Process

Probe calibration is realized, in compliance with CENELEC EN50361; CEI/IEC 62209 and IEEE 1528 std, with CALISAR, SATIMO proprietary calibration system. The calibration is performed with the technique using reference waveguide.

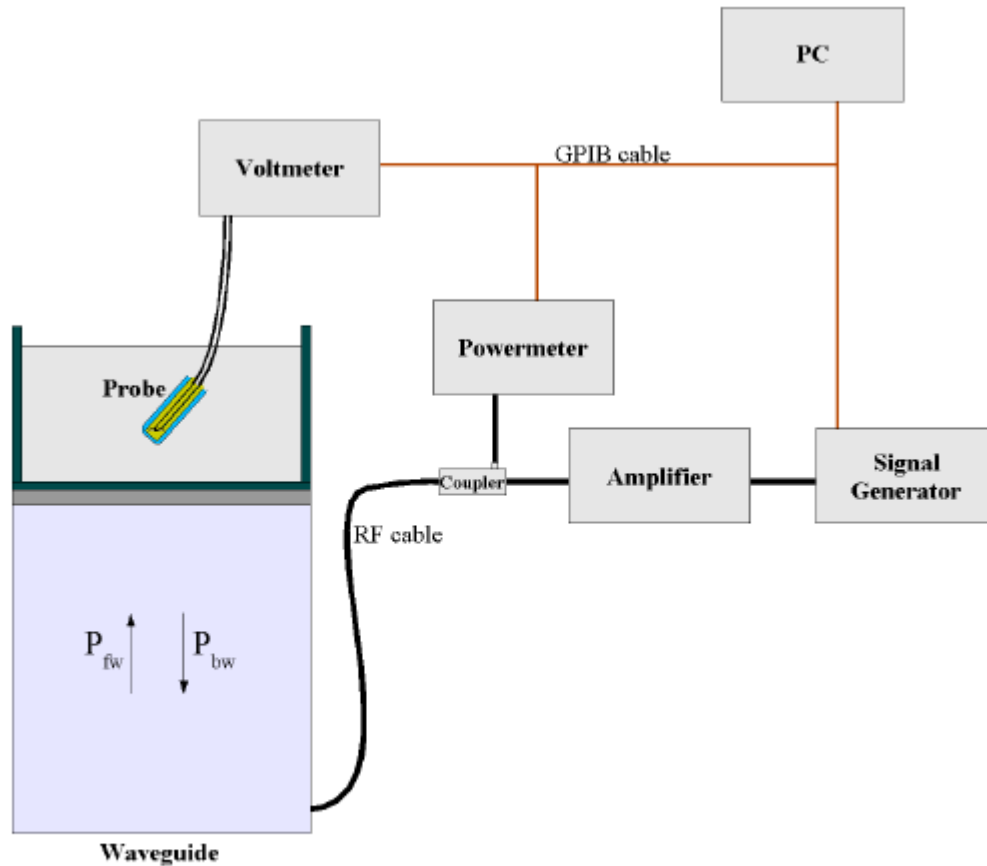

$$SAR = \frac{4(P_{fw} - P_{bw})}{ab\delta} \cos^2\left(\pi \frac{y}{a}\right) e^{-(2z/\delta)}$$

Where :

- $P_{fw}$  = Forward Power
- $P_{bw}$  = Backward Power
- a and b = Waveguide dimensions
- $\delta$  = Skin depth

*Keithley configuration:*

Rate = Medium; Filter =ON; RDGS=10; FILTER TYPE =MOVING AVERAGE; RANGE AUTO

*After each calibration, a SAR measurement is performed on a validation dipole and compared with a NPL calibrated probe, to verify it.*

Each probe is calibrated according to a dosimetric assessment procedure described in SAR standard with accuracy better than +/- 10%. The spherical isotropy was evaluated with the procedure described in SAR standard and found to be better than +/-0.25dB. The sensitivity parameters (NormX, NormY, NormZ), the diode compression parameter (DCP) and the conversion factor (ConvF) of the probe are tested.

The free space E-field from probe outputs is determined in a test chamber. This is performed in a TEM cell for frequencies below 0.8 GHz, and in a waveguide above 0.8 GHz for free space. For the free space calibration, the probe is placed in the volumetric center of the cavity and at the proper orientation with the field. E-field correlation calibration is performed in a flat phantom filled with the appropriate simulated brain tissue.

## SAM Phantom

The SAM Phantom SAM29 is constructed of a fiberglass shell integrated in a wooden table. The shape of the shell is in compliance with the specification set in IEEE 1528 and CENELEC EN62209-1, IEC62209-2.

The phantom enables the dosimetric evaluation of left and right hand phone usage as well as body mounted usage at the flat phantom region.

A cover prevents the evaporation of the liquid.

Reference markings on the Phantom allow the complete setup of all predefined phantom positions and measurement grids by manually teaching three points in the robot.

Shell Thickness: 2 0.2 mm

Filling Volume: Approx. 25 liters

Dimensions (H x L x W): 810 x 1000 x 500 mm

Liquid is filled to at least 15mm from the bottom of Phantom.



## Device Holder

In combination with the Generic Twin Phantom V3.0, the Mounting Device enables the rotation of the mounted transmitter in spherical coordinates whereby the rotation points is the ear opening. The devices can be easily, accurately, and repeatedly positioned according to the FCC and CENELEC specifications. The device holder can be locked at different phantom locations (left head, right head, flat phantom).



**Note:** A simulating human hand is not used due to the complex anatomical and geometrical structure of the hand that may produced infinite number of configurations [10]. To produce the worst-case condition (the hand absorbs antenna output power), the hand is omitted during the tests.

## Data Evaluation

The OPENSAR software automatically executes the following procedure to calculate the field units from the microvolt readings at the probe connector. The parameters used in the valuation are stored in the configuration modules of the software:

Probe Parameters	- Sensitivity	Norm <sub>i</sub>
	- Conversion factor	ConvFi
	- Diode compression point Dcpi	
Device Parameter	- Frequency	f
	- Crest factor	cf
Media Parametrs	- Conductivity	σ
	- Density	ρ

These parameters must be set correctly in the software. They can either be found in the component documents or be imported into the software from the configuration files issued for the OPENSAR components.

The first step of the evaluation is a linearization of the filtered input signal to account for the compression characteristics of the detector diode. The compensation depends on the input signal, the diode type and the DC-transmission factor from the diode to the evaluation electronics. If the exciting field is pulsed, the crest factor of the signal must be known to correctly compensate for peak power. The formula for each channel can be given as

$$V_i = U_i + U_i^2 \cdot \frac{cf}{dcp_i}$$

Where  $V_i$  = Compensated signal of channel  $i$  ( $i = x, y, z$ )

$U_i$  = Input signal of channel  $i$  ( $i = x, y, z$ )

$cf$  = Crest factor of exciting field (DASY parameter)

$dcp_i$  = Diode compression point (DASY parameter)

From the compensated input signals the primary field data for each channel can be evaluated:

$$E\text{-field probes: } E_i = \sqrt{\frac{V_i}{\text{Norm}_i \cdot \text{ConvF}}}$$

$$H\text{-field probes: } H_i = \sqrt{V_i} \cdot \frac{a_{i0} + a_{i1}f + a_{i2}f^2}{f}$$

Where  $V_i$  = Compensated signal of channel  $i$  ( $i = x, y, z$ )  
 $\text{Norm}_i$  = Sensor sensitivity of channel  $i$  ( $i = x, y, z$ )  
 $\mu\text{V}/(\text{V/m})^2$  for E0field Probes  
 $\text{ConvF}$  = Sensitivity enhancement in solution  
 $a_{ij}$  = Sensor sensitivity factors for H-field probes

$f$  = Carrier frequency (GHz)  
 $E_i$  = Electric field strength of channel  $i$  in V/m  
 $H_i$  = Magnetic field strength of channel  $i$  in A/m

The RSS value of the field components gives the total field strength (Hermitian magnitude):

$$E_{\text{tot}} = \sqrt{E_x^2 + E_y^2 + E_z^2}$$

The primary field data are used to calculate the derived field units.

$$SAR = E_{\text{tot}}^2 \cdot \frac{\sigma}{\rho \cdot 1000}$$

where  $SAR$  = local specific absorption rate in mW/g  
 $E_{\text{tot}}$  = total field strength in V/m  
 $\sigma$  = conductivity in [mho/m] or [siemens/m]  
 $\rho$  = equivalent tissue density in g/cm<sup>3</sup>

Note that the density is normally set to 1 (or 1.06), to account for actual brain density rather than the density of the simulation liquid.

The power flow density is calculated assuming the excitation field as a free space field.

$$P_{\text{pwe}} = \frac{E_{\text{tot}}^2}{3770} \quad \text{or} \quad P_{\text{pwe}} = H_{\text{tot}}^2 \cdot 37.7$$

where  $P_{\text{pwe}}$  = Equivalent power density of a plane wave in mW/cm<sup>2</sup>  
 $E_{\text{tot}}$  = total electric field strength in V/m  
 $H_{\text{tot}}$  = total magnetic field strength in A/m

## SAR Evaluation – Peak Spatial - Average

The procedure for assessing the peak spatial-average SAR value consists of the following steps

- **Power Reference Measurement**

The reference and drift jobs are useful jobs for monitoring the power drift of the device under test in the batch process. Both jobs measure the field at a specified reference position, at a selectable distance from the phantom surface. The reference position can be either the selected section's grid reference point or a user point in this section. The reference job projects the selected point onto the phantom surface, orients the probe perpendicularly to the surface, and approaches the surface using the selected detection method.

- **Area Scan**

The area scan is used as a fast scan in two dimensions to find the area of high field values, before doing a finer measurement around the hot spot. The sophisticated interpolation routines implemented in OPENSAR software can find the maximum locations even in relatively coarse grids. The scan area is defined by an editable grid. This grid is anchored at the grid reference point of the selected section in the phantom. When the area scan's property sheet is brought-up, grid was at to 15 mm by 15 mm and can be edited by a user.

- **Zoom Scan**

Zoom scans are used to assess the peak spatial SAR values within a cubic averaging volume containing 1 g and 10 g of simulated tissue. The default zoom scan measures 5 x 5 x 7 points within a cube whose base faces are centered around the maximum found in a preceding area scan job within the same procedure. If the preceding Area Scan job indicates more than one maximum, the number of Zoom Scans has to be enlarged accordingly (The default number inserted is 1).

- **Power Drift measurement**

The drift job measures the field at the same location as the most recent reference job within the same procedure, and with the same settings. The drift measurement gives the field difference in dB from the reading conducted within the last reference measurement. Several drift measurements are possible for one reference measurement. This allows a user to monitor the power drift of the device under test within a batch process. In the properties of the Drift job, the user can specify a limit for the drift and have OPENSAR software stop the measurements if this limit is exceeded.

## SAR Evaluation – Peak SAR

The procedure for spatial peak SAR evaluation has been implemented according to the IEEE1529 standard. It can be conducted for 1 g and 10 g. The OPENSAR system allows evaluations that combine measured data and robot positions, such as:

- maximum search
- extrapolation
- boundary correction
- peak search for averaged SAR

During a maximum search, global and local maximum searches are automatically performed in 2-D after each Area Scan measurement with at least 6 measurement points. It is based on the evaluation of the local SAR gradient calculated by the Quadratic Shepard's method. The algorithm will find the global maximum and all local maxima within -2 dB of the global maxima for all SAR distributions.



## Extrapolation

Extrapolation routines are used to obtain SAR values between the lowest measurement points and the inner phantom surface. The extrapolation distance is determined by the surface detection distance and the probe sensor offset. Several measurements at different distances are necessary for the extrapolation.

They are used in the Cube Scan to obtain SAR values between the lowest measurement points and the inner phantom surface. The routine uses the fourth order least square polynomial method for extrapolation. For a grid using 5x5x7 measurement points with 5mm resolution amounting to 343 measurement points, the uncertainty of the extrapolation routines is less than 1% for 1 g and 10 g cubes.

## Definition of Reference Points

### Ear Reference Point

Figure 6.2 shows the front, back and side views of the SAM Phantom. The point "M" is the reference point for the center of the mouth, "LE" is the left ear reference point (ERP), and "RE" is the right ERP. The ERPs are 15mm posterior to the entrance to the ear canal (EEC) along the B-M line (Back-Mouth), as shown in Figure 6.1. The plane passing through the two ear canals and M is defined as the Reference Plane. The line N-F (Neck-Front) is perpendicular to the reference plane and passing through the RE (or LE) is called the Reference Pivoting Line (see Figure 6.1). Line B-M is perpendicular to the N-F line. Both N-F and B-M lines are marked on the external phantom shell to facilitate handset positioning [5].

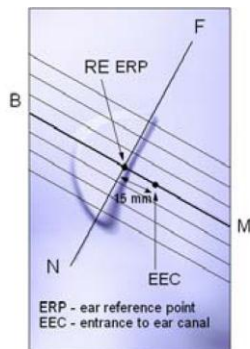

**Figure 6.1 Close-up side view of ERP's**



**Figure 6.2 Front, back and side view of SAM**

## Device Reference Points

Two imaginary lines on the device need to be established: the vertical centerline and the horizontal line. The test device is placed in a normal operating position with the "test device reference point" located along the "vertical centerline" on the front of the device aligned to the "ear reference point" (See Fig. 6.3). The "test device reference point" is then located at the same level as the center of the ear reference point. The test device is positioned so that the "vertical centerline" is bisecting the front surface of the device at its top and bottom edges, positioning the "ear reference point" on the outer surface of both the left and right head phantoms on the ear reference point [5].

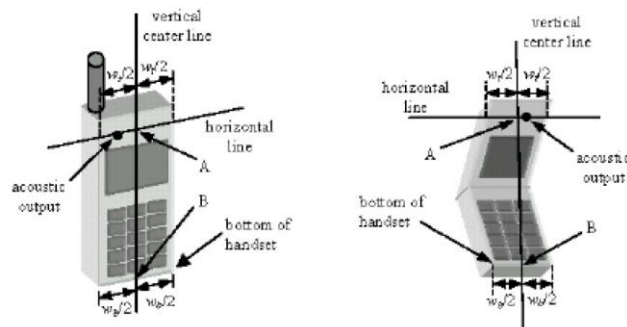

**Figure 6.3 Handset Vertical Center & Horizontal Line Reference Points**

## Test Configuration – Positioning for Cheek / Touch

1. Position the device close to the surface of the phantom such that point A is on the (virtual) extension of the line passing through points RE and LE on the phantom (see Figure below), such that the plane defined by the vertical center line and the horizontal line of the device is approximately parallel to the sagittal plane of the phantom

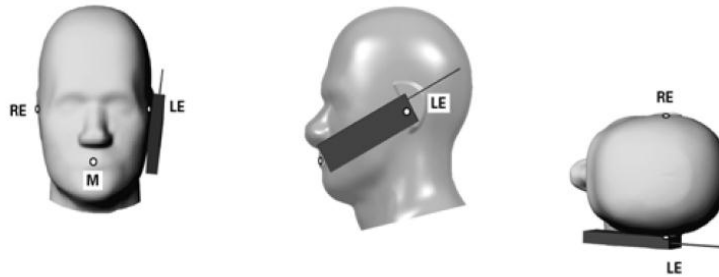

**Figure 7.1 Front, Side and Top View of Cheek/Touch Position**

2. Translate the device towards the phantom along the line passing through RE and LE until the device touches the ear.
3. While maintaining the device in this plane, rotate it around the LE-RE line until the vertical centerline is in the plane normal to MB-NF including the line MB (called the reference plane).
4. Rotate the device around the vertical centerline until the device (horizontal line) is symmetrical with respect to the line NF.
5. While maintaining the vertical centerline in the reference plane, keeping point A on the line passing through RE and LE and maintaining the device contact with the ear, rotate the device about the line NF until any point on the device is in contact with a phantom point below the ear (cheek). See Figure below.

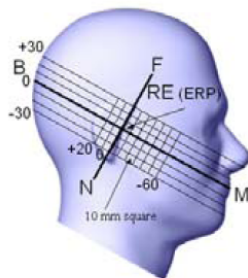
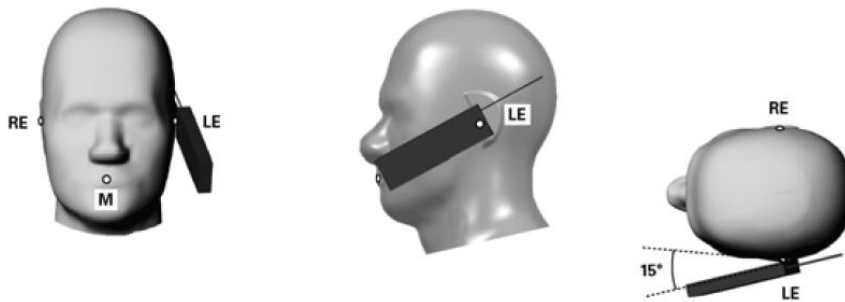

**Figure 7.2 Side view w/ relevant markings**

## Test Configuration – Positioning for Ear / 15° Tilt

With the test device aligned in the Cheek/Touch Position”:

1. While maintaining the orientation of the device, retracted the device parallel to the reference plane far enough to enable a rotation of the device by 15 degrees.
2. Rotate the device around the horizontal line by 15 degrees.
3. While maintaining the orientation of the device, move the device parallel to the reference plane until any part of the device touches the head. (In this position, point A is located on the line RE-LE). The tilted position is obtained when the contact is on the pinna. If the contact is at any location other than the pinna, the angle of the device shall be reduced. The tilted position is obtained when any part of the device is in contact with the ear as well as a second part of the device is in contact with the head (see Figure below).

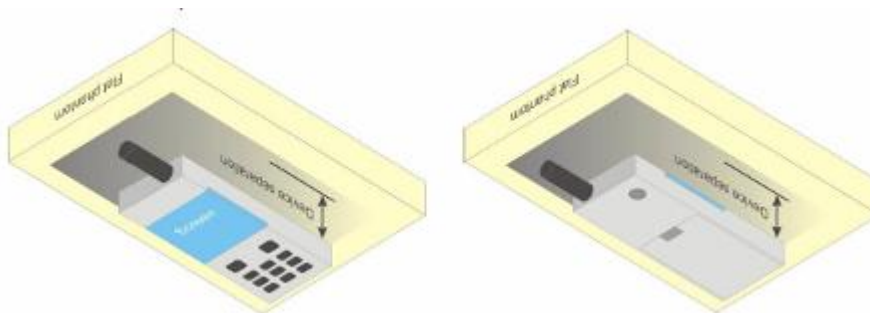

**Figure 7.3 Front, Side and Top View of Ear/15° Tilt Position**

## Test Position – Body Configurations

Body Worn Position

- (a) To position the device parallel to the phantom surface with either keypad up or down.
- (b) To adjust the device parallel to the flat phantom.
- (c) To adjust the distance between the device surface and the flat phantom to 1.0 cm or holster surface and the flat phantom to 0 cm.



## **5 ANSI/IEEE C95.1 – 1999 RF EXPOSURE LIMIT**

In order for users to be aware of the body-worn operating requirements for meeting RF exposure compliance, operating instructions and cautions statements are included in the user's manual.

### **Uncontrolled Environment**

Uncontrolled Environments are defined as locations where there is the exposure of individuals who have no knowledge or control of their exposure. The general population/uncontrolled exposure limits are applicable to situations in which the general public may be exposed or in which persons who are exposed as a consequence of their employment may not be made fully aware of the potential for exposure or cannot exercise control over their exposure. Members of the general public would come under this category when exposure is not employment-related; for example, in the case of a wireless transmitter that exposes persons in its vicinity.

### **Controlled Environment**

Controlled Environments are defined as locations where there is exposure that may be incurred by persons who are aware of the potential for exposure, (i.e. as a result of employment or occupation). In general, occupational/controlled exposure limits are applicable to situations in which persons are exposed as a consequence of their employment, who have been made fully aware of the potential for exposure and can exercise control over their exposure. This exposure category is also applicable when the exposure is of a transient nature due to incidental passage through a location where the exposure levels may be higher than the general population/uncontrolled limits, but the exposed person is fully aware of the potential for exposure and can exercise control over his or her exposure by leaving the area or by some other appropriate means.

**Table 8.1 Human Exposure Limits**

	UNCONTROLLED ENVIRONMENT General Population (W/kg) or (mW/g)	CONTROLLED ENVIROMENT Professional Population (W/kg) or (mW/g)
SPATIAL PEAK SAR <sup>1</sup> Brain	1.60	8.00
SPATIAL AVERAGE SAR <sup>2</sup> Whole Body	0.08	0.40
SPATIAL PEAK SAR <sup>3</sup> Hands, Feet, Ankles, Wrists	4.00	20.00

<sup>1</sup> The Spatial Peak value of the SAR averaged over any 1 gram of tissue (defined as a tissue volume in the shape of a cube) and over the appropriate averaging time.

<sup>2</sup> The Spatial Average value of the SAR averaged over the whole body.

<sup>3</sup> The Spatial Peak value of the SAR averaged over any 10 grams of tissue (defined as a tissue volume in the shape of a cube) and over the appropriate averaging time.

## 6 SYSTEM AND LIQUID VERIFICATION

### Basic SAR system validation requirements

The SAR system must be validated against its performance specifications before it is deployed. When SAR probes, system components or software are changed, upgraded or recalibrated, these must be validated with the SAR system(s) that operates with such components. Reference dipoles are used with the required tissue-equivalent media for system validation,

The detailed system validation results are maintained by each test laboratory, which are normally not required for equipment approval. Only a tabulated summary of the system validation status, according to the validation date(s), measurement frequencies, SAR probes and tissue dielectric parameters is required in the SAR report.

### System Setup

The system performance check verifies that the system operates within its specifications. System and operator errors can be detected and corrected. It is recommended that the system performance check be performed prior to any usage of the system in order to guarantee reproducible results. The system performance check uses normal SAR measurements in a simplified setup with a well characterized source. This setup was selected to give a high sensitivity to all parameters that might fail or vary over time. The system check does not intend to replace the calibration of the components, but indicates situations where the system uncertainty is exceeded due to drift or failure.

In the simplified setup for system evaluation, the DUT is replaced by a calibrated dipole and the power source is replaced by a continuous wave that comes from a signal generator. The calibrated dipole must be placed beneath the flat phantom section of the SAM twin phantom with the correct distance holder. The distance holder should touch the phantom surface with a light pressure at the reference marking and be oriented parallel to the long side of the phantom. The equipment setup is shown below:

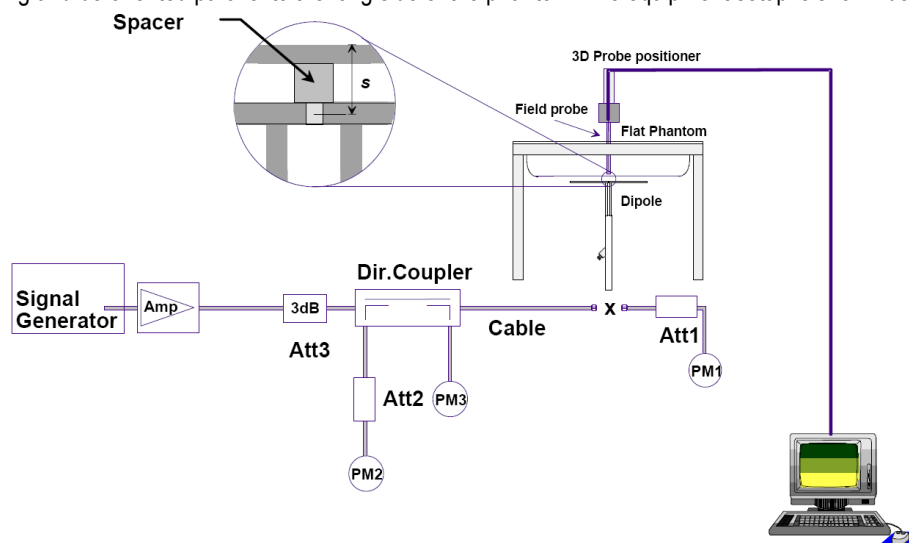

Fig 8.1 System Setup for System Evaluation

1. Signal Generator
2. Amplifier
3. Directional Coupler
4. Power Meter
5. Calibrated Dipole

Note: The output power on dipole port must be calibrated to 30 dBm (1000 mW) before dipole is connected.

## System Verification Results

Prior to SAR assessment, the system is verified to 10% of the SAR measurement on the reference dipole at the time of calibration by the calibration facility. Full system validation status and result summary can be found in ANNEX A

### Target and measurement SAR after Normalized (1W):

Measurement Date	Frequency (MHz)	Liquid Type (head/body)	Target SAR1g (W/kg)	Measured SAR1g (W/kg)	Normalized SAR1g (W/kg)	Deviation (%)
Jun 23,2017	750	head	8.55	0.837	8.37	-2.11
Jun 23,2017	750	Body	8.75	0.902	9.02	3.09
Jun 26,2017	835	head	9.64	0.993	9.93	3.01
Jun 26,2017	835	body	9.96	0.961	9.61	-3.51
Jun 28,2017	1800	head	37.99	3.554	35.54	-6.45
Jun 28,2017	1800	body	39.62	3.933	39.33	-0.73
Jun 30,2017	1900	head	39.88	3.699	36.99	-7.25
Jun 30,2017	1900	body	40.38	4.054	40.45	0.17
Jul 3,2017	2450	head	53.18	5.376	53.76	1.09
Jul 3,2017	2450	body	52.73	5.151	51.51	-2.31
Jul 5,2017	2600	head	54.89	5.307	53.07	-3.32
Jul 5,2017	2600	body	54.23	5.644	56.44	4.08

Note: system check input power 100mW

## **Liquid Verification**

The dielectric parameters were checked prior to assessment using the HP85070C dielectric probe kit. The dielectric parameters measured are reported in each correspondent section.

### **KDB 865664 recommended Tissue Dielectric Parameters**

The head and body tissue parameters given in this below table should be used to measure the SAR of transmitters operating in 100 MHz to 6 GHz frequency range. The tissue dielectric parameters of the tissue medium at the test frequency should be within the tolerance required in this document. The dielectric parameters should be linearly interpolated between the closest pair of target frequencies to determine the applicable dielectric parameters corresponding to the device test frequency.

The head tissue dielectric parameters recommended by IEEE Std 1528-2013 have been incorporated in the following table. These head parameters are derived from planar layer models simulating the highest expected SAR for the dielectric properties and tissue thickness variations in a human head. Other head and body tissue parameters that have not been specified in 1528 are derived from tissue dielectric parameters computed from the 4-Cole-Cole equations described above and extrapolated according to the head parameters specified in 1528.

### Liquid Confirmation Result:

#### 1. Measured Head liquid Properties

Date	Freq.(MHz)	Liquid Parameters	Measured	Target	Delta (%)	Limit ± (%)
Jun 23,2017	750	Relative Permittivity ( $\epsilon_r$ ):	41.96	42.0	-0.10	5
		Conductivity ( $\sigma$ ):	0.90	0.89	1.12	5
Jun 26,2017	835	Relative Permittivity ( $\epsilon_r$ ):	41.2	41.5	-0.72	5
		Conductivity ( $\sigma$ ):	0.91	0.90	1.11	5
Jun 28,2017	1800	Relative Permittivity ( $\epsilon_r$ ):	39.96	40.0	-0.10	5
		Conductivity ( $\sigma$ ):	1.42	1.40	1.43	5
Jun 30,2017	1900	Relative Permittivity ( $\epsilon_r$ ):	40.02	40.0	0.05	5
		Conductivity ( $\sigma$ ):	1.37	1.40	-2.14	5
Jul 3,2017	2450	Relative Permittivity ( $\epsilon_r$ ):	40.42	39.2	0.26	5
		Conductivity ( $\sigma$ ):	1.77	1.80	0.51	5
Jul 5,2017	2600	Relative Permittivity ( $\epsilon_r$ ):	39.1	39.0	0.26	5
		Conductivity ( $\sigma$ ):	1.97	1.96	0.51	5

#### 2. Measured Body liquid Properties

Date	Freq.(MHz)	Liquid Parameters	Measured	Target	Delta (%)	Limit ± (%)
Jun 23,2017	750	Relative Permittivity ( $\epsilon_r$ ):	55.55	55.60	-0.09	5
		Conductivity ( $\sigma$ ):	0.98	0.96	2.08	5
Jun 26,2017	835	Relative Permittivity ( $\epsilon_r$ ):	55.17	55.20	-0.05	5
		Conductivity ( $\sigma$ ):	0.99	0.97	2.06	5
Jun 28,2017	1800	Relative Permittivity ( $\epsilon_r$ ):	53.26	53.3	-0.08	5
		Conductivity ( $\sigma$ ):	1.55	1.52	1.97	5
Jun 30,2017	1900	Relative Permittivity ( $\epsilon_r$ ):	53.29	53.3	-0.02	5
		Conductivity ( $\sigma$ ):	1.51	1.52	-0.66	5
Jul 3,2017	2450	Relative Permittivity ( $\epsilon_r$ ):	52.78	52.70	0.31	5
		Conductivity ( $\sigma$ ):	1.97	1.95	-0.91	5
Jul 5,2017	2600	Relative Permittivity ( $\epsilon_r$ ):	51.96	51.80	0.31	5
		Conductivity ( $\sigma$ ):	2.17	2.19	-0.91	5



## System Verification Plots

Product Description: Dipole

Model: SID750

Test Date: Jun 23,2017

Medium(liquid type)	HSL_750
Frequency (MHz)	750.000000
Relative permittivity (real part)	41.96
Conductivity (S/m)	0.90
Input power	100mW
E-Field Probe	SN 27/15 EPGO262
Crest factor	1.0
Conversion Factor	1.57
Sensor-surface	4mm
Area Scan	dx=8mm dy=8mm
Zoom Scan	5x5x7,dx=8mm dy=8mm dz=5mm
Variation (%)	0.720000
SAR 10g (W/Kg)	0.574668
SAR 1g (W/Kg)	0.837214

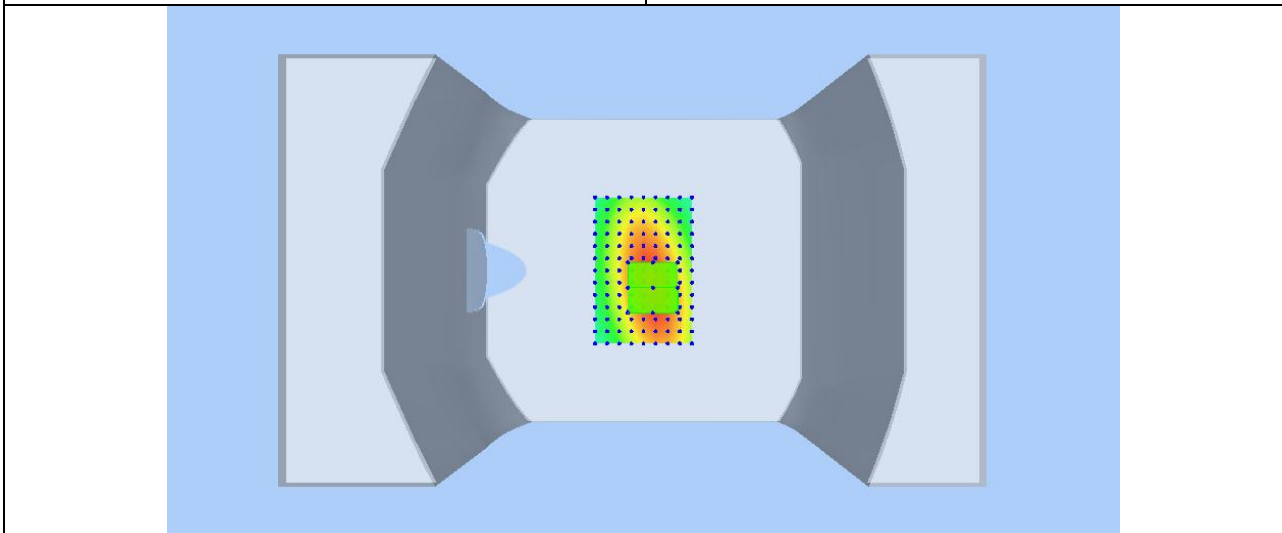
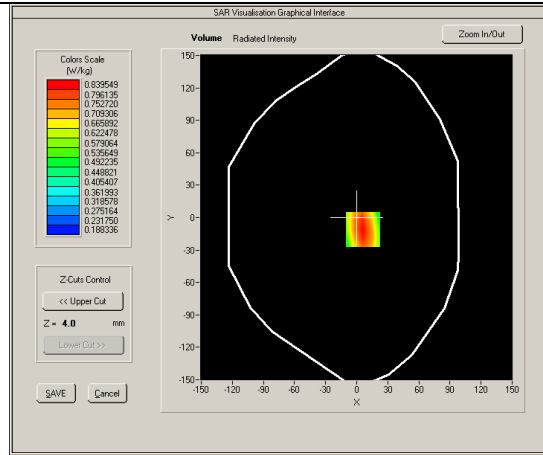
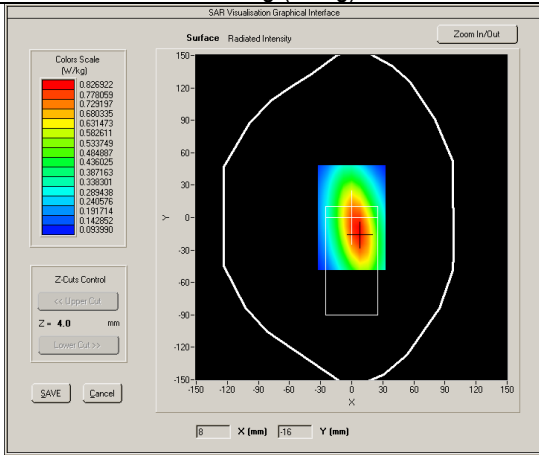

**Product Description: Dipole**  
**Model: SID750**  
**Test Date: Jun 23,2017**

Medium(liquid type)	MSL_750
Frequency (MHz)	750.000000
Relative permittivity (real part)	55.55
Conductivity (S/m)	0.98
Input power	100mW
E-Field Probe	SN 27/15 EPGO262
Crest factor	1.0
Conversion Factor	1.62
Sensor-surface	4mm
Area Scan	dx=8mm dy=8mm
Zoom Scan	5x5x7,dx=8mm dy=8mm dz=5mm
Variation (%)	0.230000
SAR 10g (W/Kg)	0.617568
SAR 1g (W/Kg)	0.901559

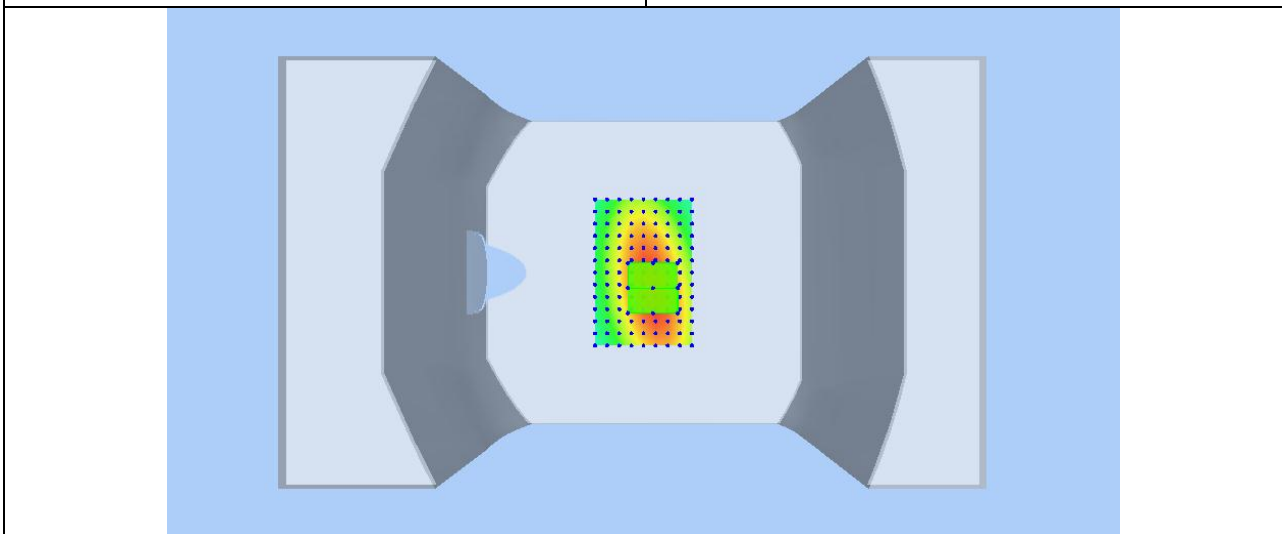
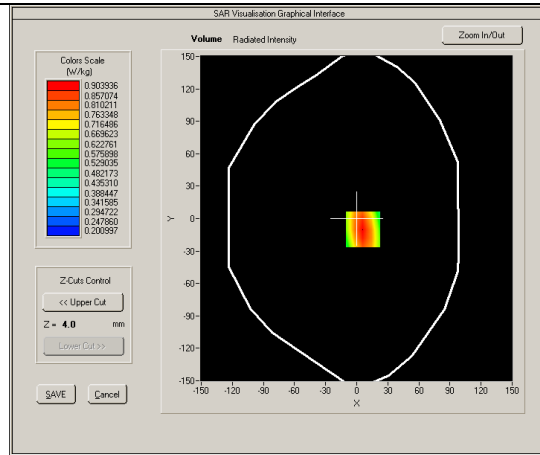
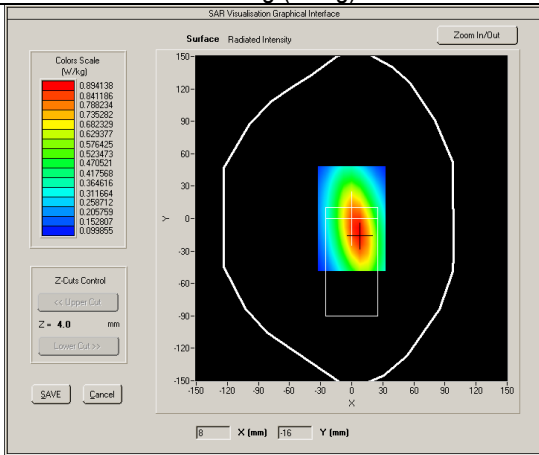

Product Description: Dipole  
Model: SID835  
Test Date: Jun 26,2017

Medium(liquid type)	HSL 835
Frequency (MHz)	835.000000
Relative permittivity (real part)	41.2
Conductivity (S/m)	0.91
Input power	100mW
E-Field Probe	SN 27/15 EPGO262
Crest factor	1.0
Conversion Factor	1.74
Sensor-surface	4mm
Area Scan	dx=8mm dy=8mm
Zoom Scan	5x5x7,dx=8mm dy=8mm dz=5mm
Variation (%)	0.390000
SAR 10g (W/Kg)	0.657447
SAR 1g (W/Kg)	0.992786

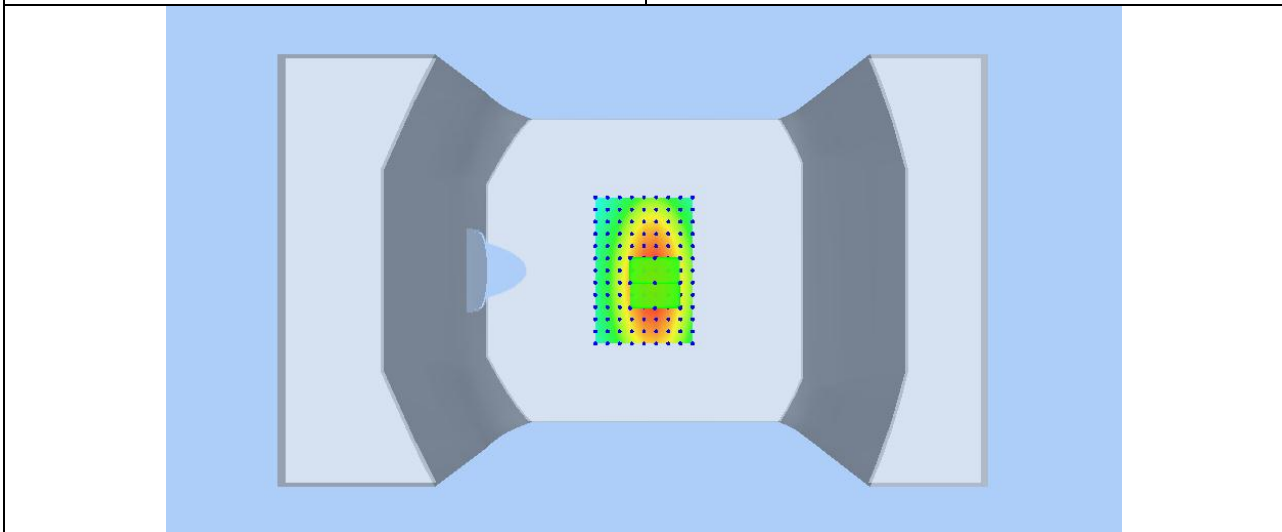
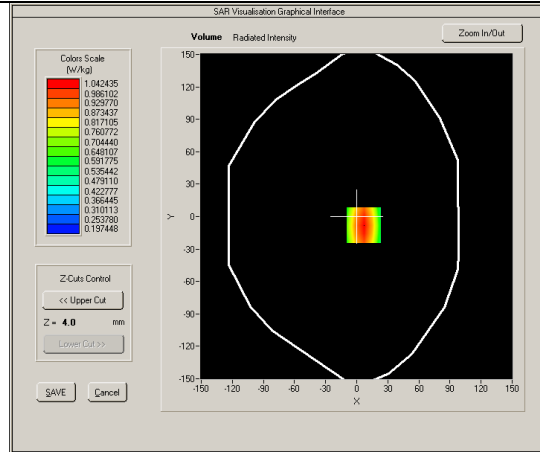
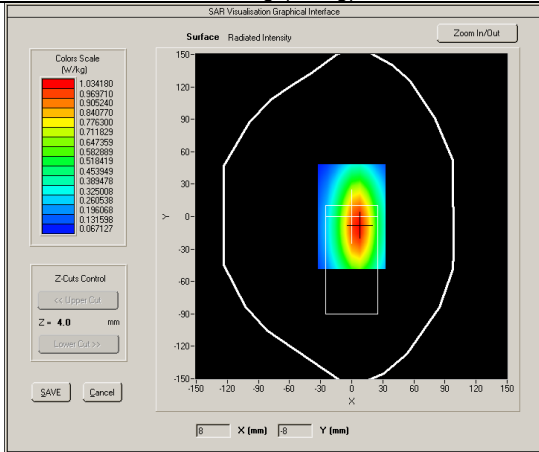

**Product Description: Dipole**  
**Model: SID835**  
**Test Date: Jun 26,2017**

Medium(liquid type)	MSL_835
Frequency (MHz)	835.000000
Relative permittivity (real part)	55.17
Conductivity (S/m)	0.99
Input power	100mW
E-Field Probe	SN 27/15 EPGO262
Crest factor	1.0
Conversion Factor	1.81
Sensor-surface	4mm
Area Scan	dx=8mm dy=8mm
Zoom Scan	5x5x7,dx=8mm dy=8mm dz=5mm
Variation (%)	0.360000
SAR 10g (W/Kg)	0.635967
SAR 1g (W/Kg)	0.961231

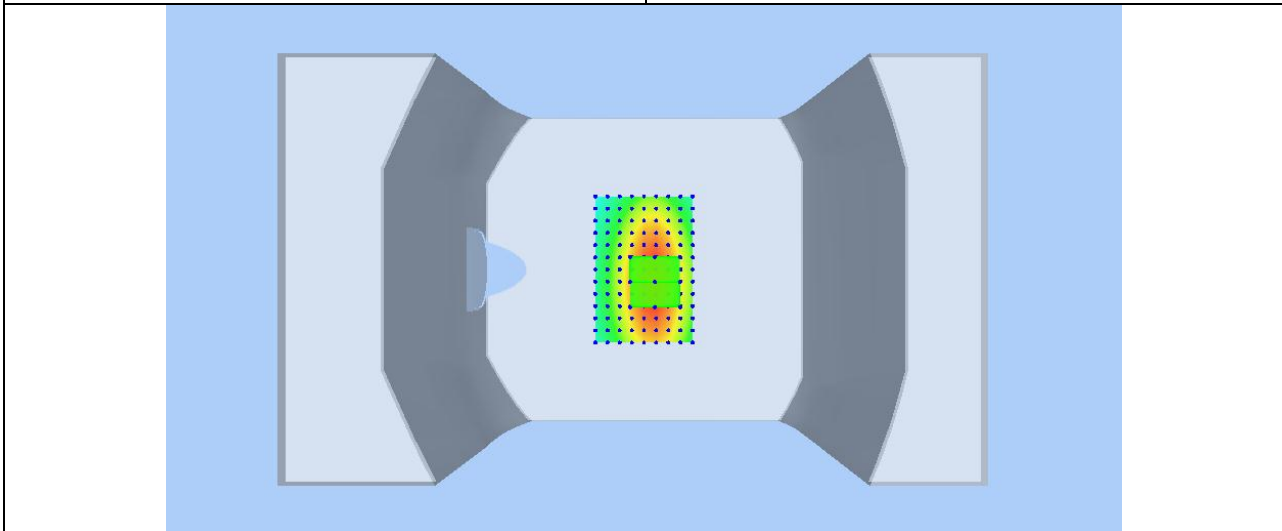
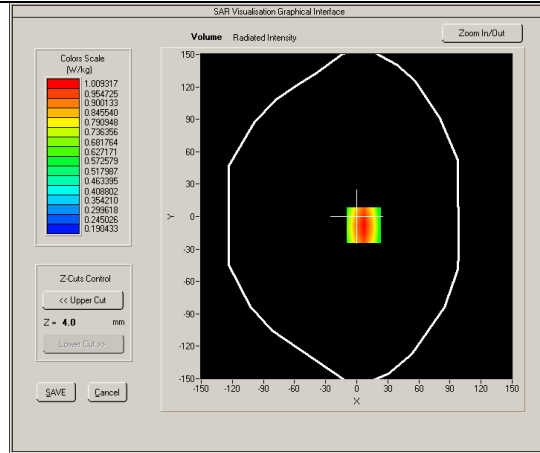
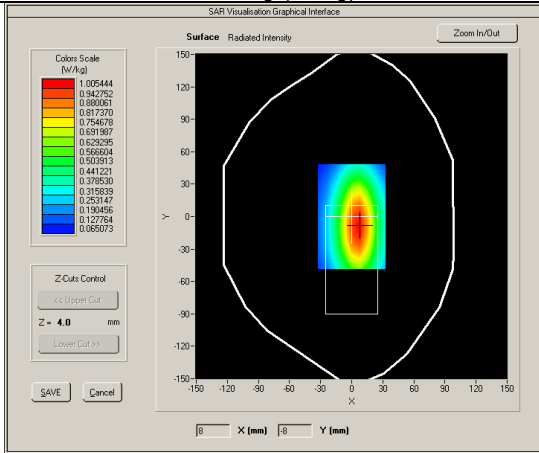

Product Description: Dipole  
Model: SID1800  
Test Date: Jun 28,2017

Medium(liquid type)	HSL_1800
Frequency (MHz)	1800.000
Relative permittivity (real part)	39.96
Conductivity (S/m)	1.42
Input power	100mW
E-Field Probe	SN 27/15 EPGO262
Crest factor	1.0
Conversion Factor	1.81
Sensor-Surface	4mm
Area Scan	dx=8mm dy=8mm
Zoom Scan	5x5x7,dx=8mm dy=8mm dz=5mm
Variation (%)	-0.230000
SAR 10g (W/Kg)	1.957404
SAR 1g (W/Kg)	3.553730

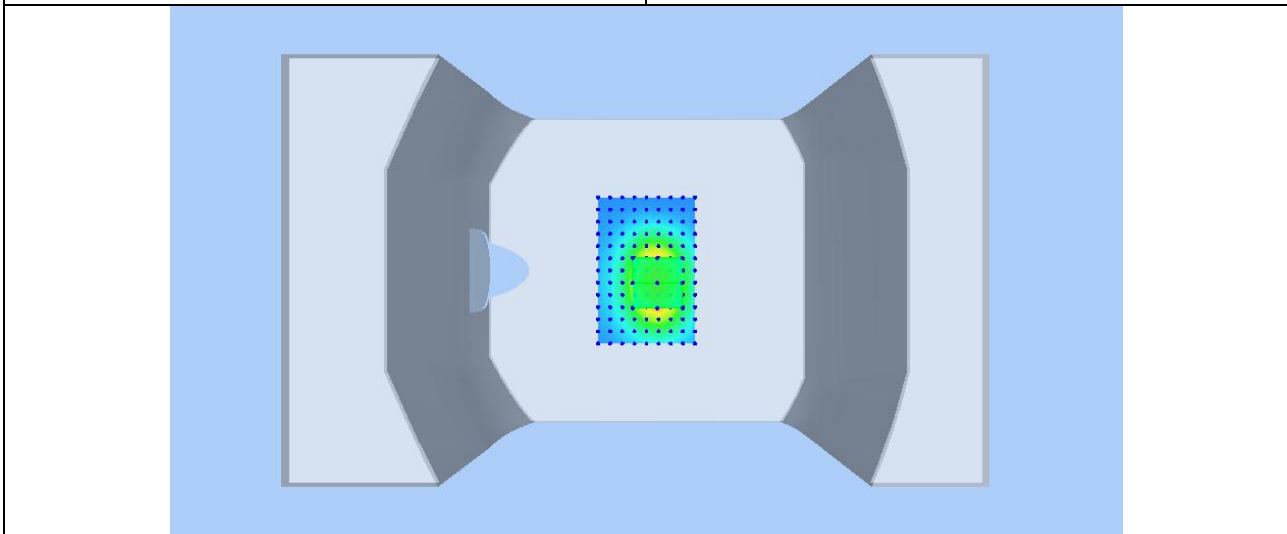
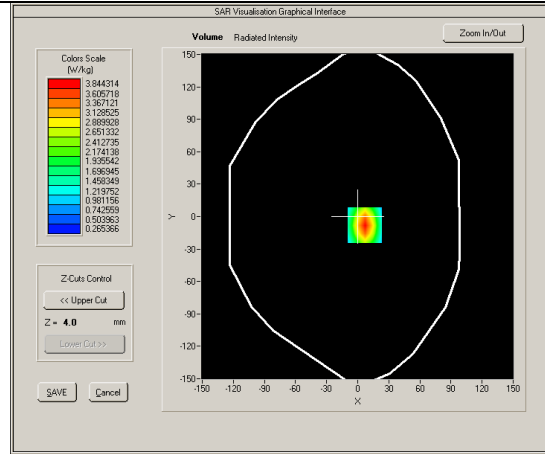
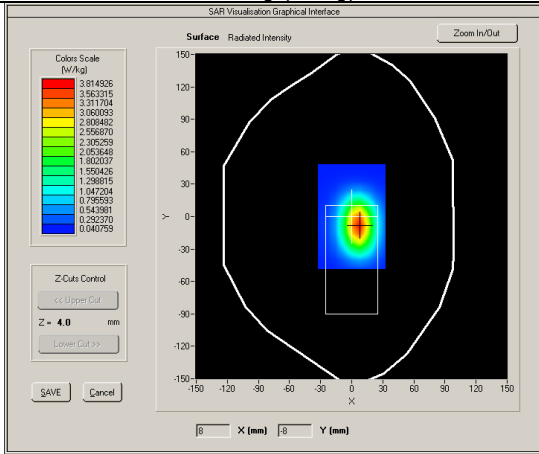

Product Description: Dipole  
Model: SID1800  
Test Date: Jun 28,2017

Medium(liquid type)	MSL_1800
Frequency (MHz)	1800.000
Relative permittivity (real part)	53.26
Conductivity (S/m)	1.55
Input power	100mW
E-Field Probe	SN 27/15 EPGO262
Crest factor	1.0
Conversion Factor	1.87
Sensor-Surface	4mm
Area Scan	dx=8mm dy=8mm
Zoom Scan	5x5x7,dx=8mm dy=8mm dz=5mm
Variation (%)	0.080000
SAR 10g (W/Kg)	2.175818
SAR 1g (W/Kg)	3.932880

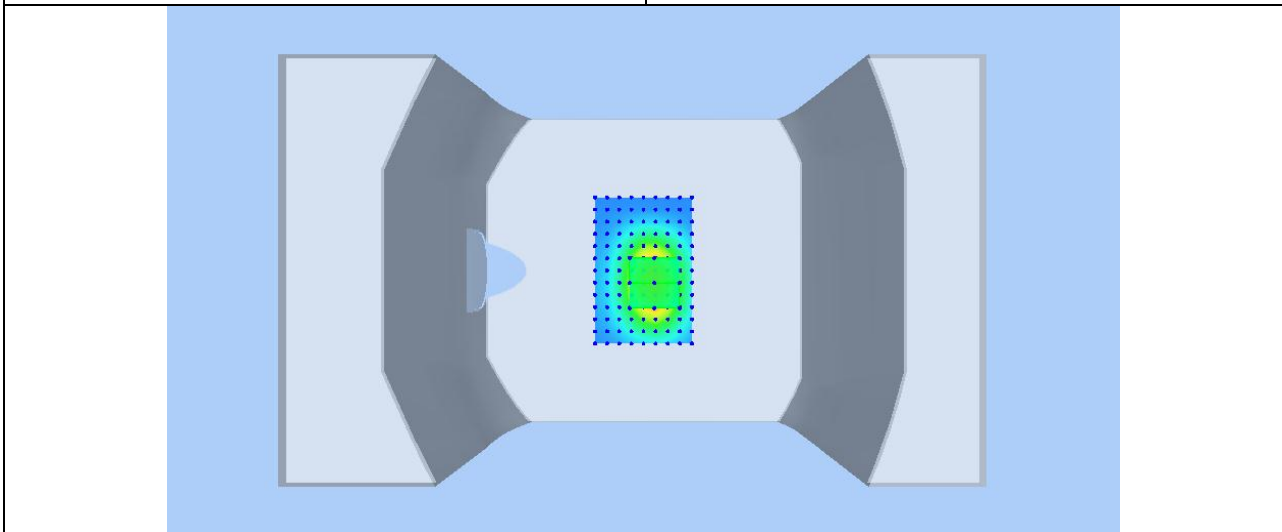
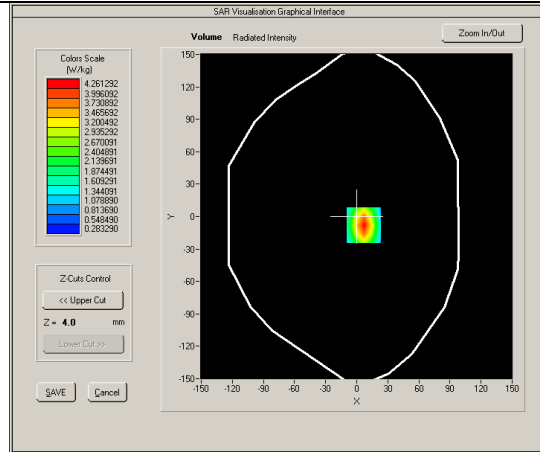
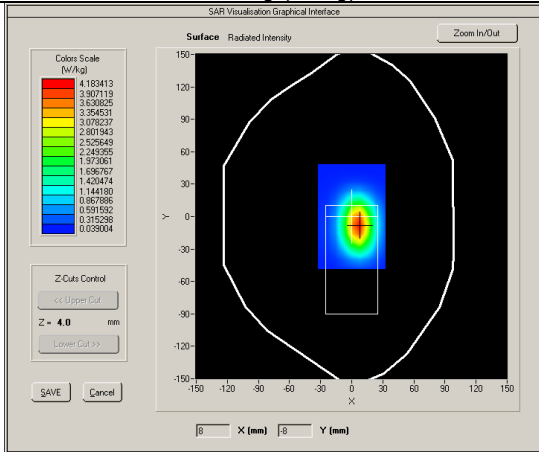

Product Description: Dipole  
Model: SID1900  
Test Date: Jun 30,2017

Medium(liquid type)	HSL_1900
Frequency (MHz)	1900.000
Relative permittivity (real part)	40.02
Conductivity (S/m)	1.37
Input power	100mW
E-Field Probe	SN 27/15 EPGO262
Crest factor	1.0
Conversion Factor	2.01
Sensor-Surface	4mm
Area Scan	dx=8mm dy=8mm
Zoom Scan	5x5x7,dx=8mm dy=8mm dz=5mm
Variation (%)	-0.630000
SAR 10g (W/Kg)	1.986748
SAR 1g (W/Kg)	3.699097

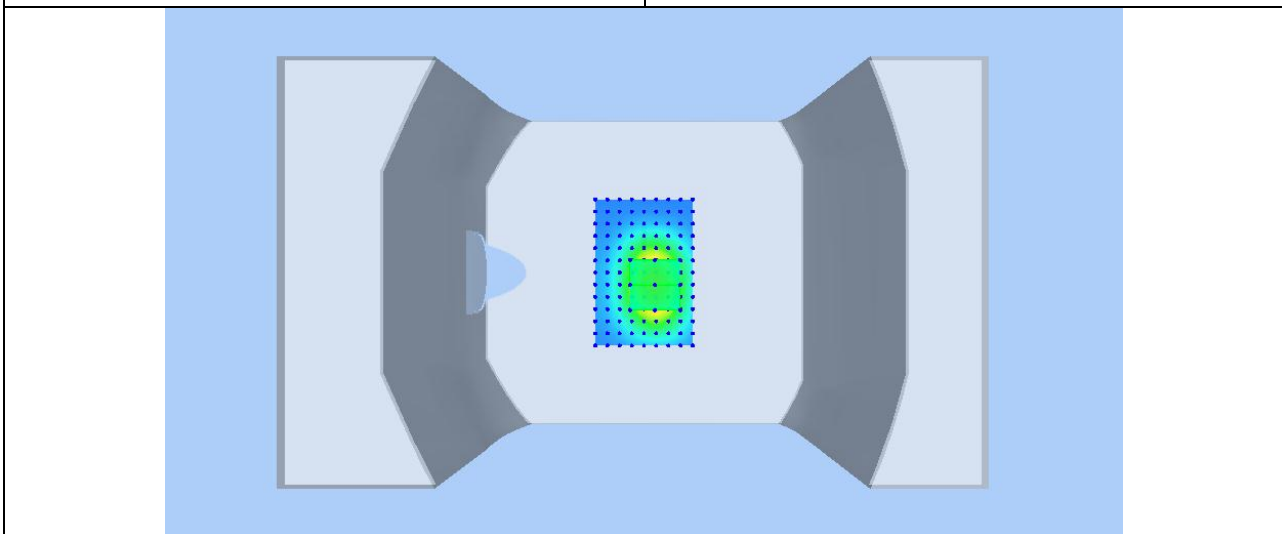
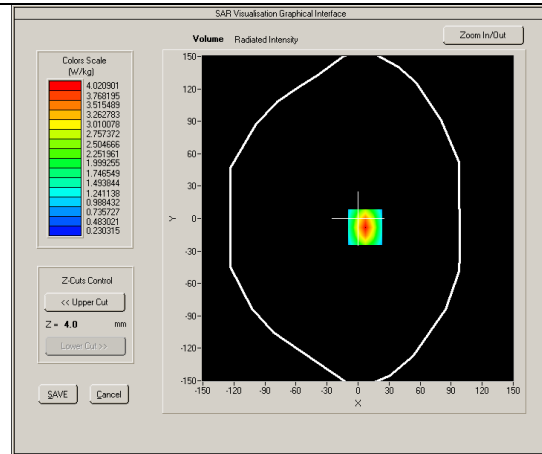
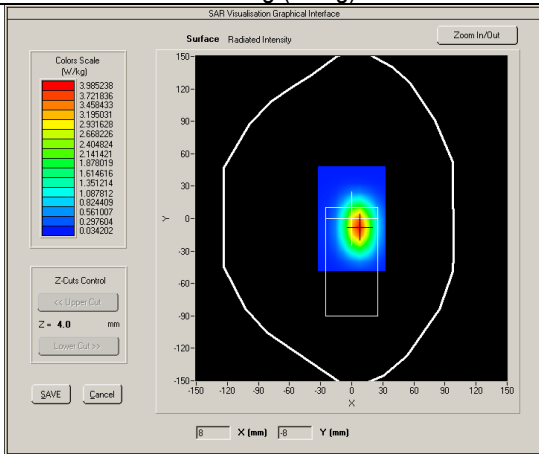

Product Description: Dipole  
Model: SID1900  
Test Date: Jun 30, 2017

Medium(liquid type)	MSL_1900
Frequency (MHz)	1900.000
Relative permittivity (real part)	53.29
Conductivity (S/m)	1.51
Input power	100mW
E-Field Probe	SN 27/15 EPGO262
Crest factor	1.0
Conversion Factor	2.05
Sensor-Surface	4mm
Area Scan	dx=8mm dy=8mm
Zoom Scan	5x5x7,dx=8mm dy=8mm dz=5mm
Variation (%)	-0.820000
SAR 10g (W/Kg)	2.151455
SAR 1g (W/Kg)	4.054408

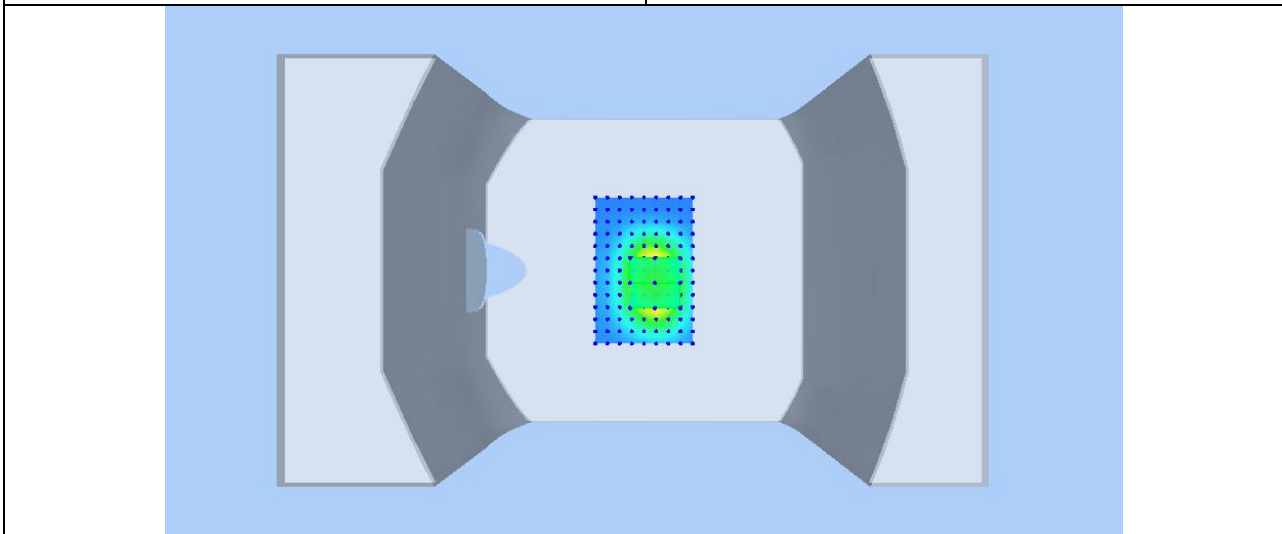
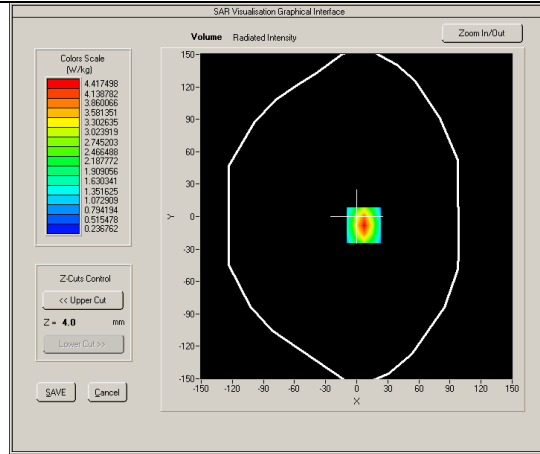
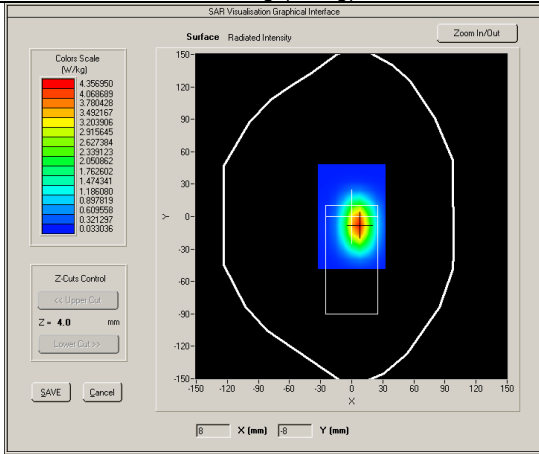



**Product Description: Dipole**  
**Model: SID2450**  
**Test Date: Jul 3,2017**

Medium(liquid type)	HSL_2450
Frequency (MHz)	2450.000
Relative permittivity (real part)	40.42
Conductivity (S/m)	1.77
Input power	100mW
Crest factor	1.0
E-Field Probe	SN 27/15 EPGO262
Conversion Factor	2.04
Area Scan	dx=8mm dy=8mm
Zoom Scan	5x5x7,dx=8mm dy=8mm dz=5mm
Variation (%)	-0.520000
SAR 10g (W/Kg)	2.516026
SAR 1g (W/Kg)	5.375823

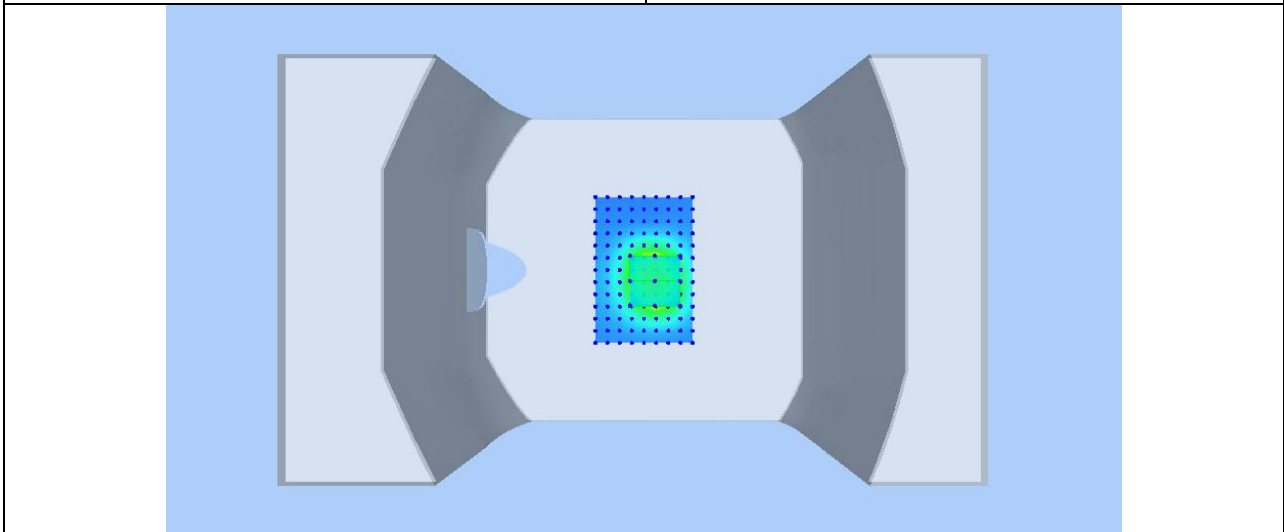
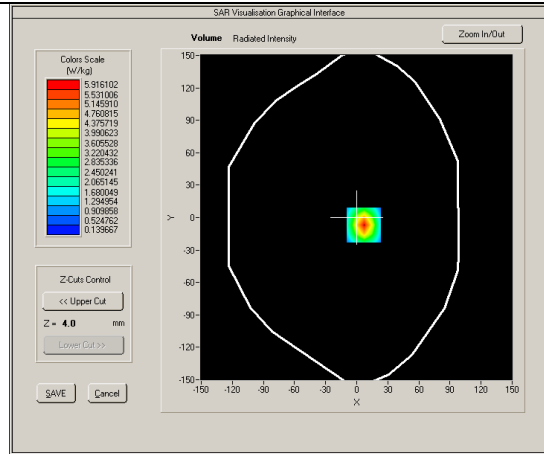
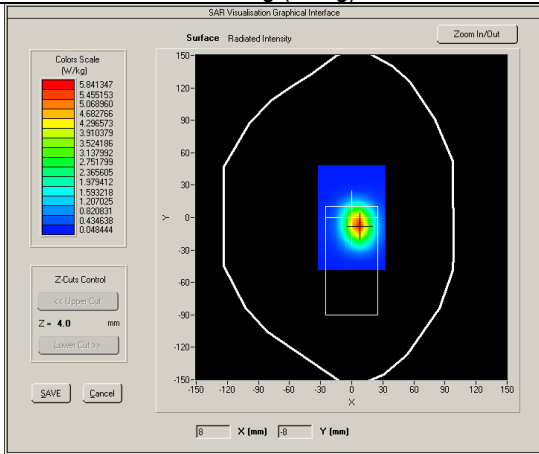

**Product Description: Dipole**  
**Model: SID2450**  
**Test Date: Jul 3,2017**

Medium(liquid type)	MSL_2450
Frequency (MHz)	2450.00
Relative permittivity (real part)	52.78
Conductivity (S/m)	1.97
Input power	100mW
Crest factor	1.0
E-Field Probe	SN 27/15 EPGO262
Conversion Factor	2.12
Area Scan	dx=8mm dy=8mm
Zoom Scan	5x5x7,dx=8mm dy=8mm dz=5mm
Variation (%)	-1.150000
SAR 10g (W/Kg)	2.408050
SAR 1g (W/Kg)	5.150584

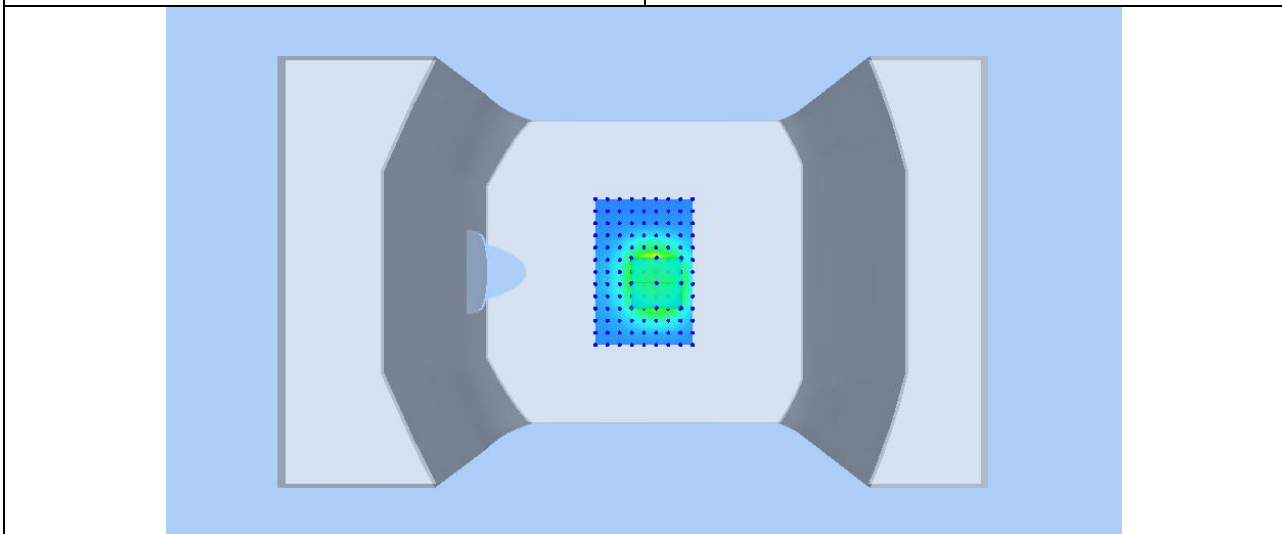
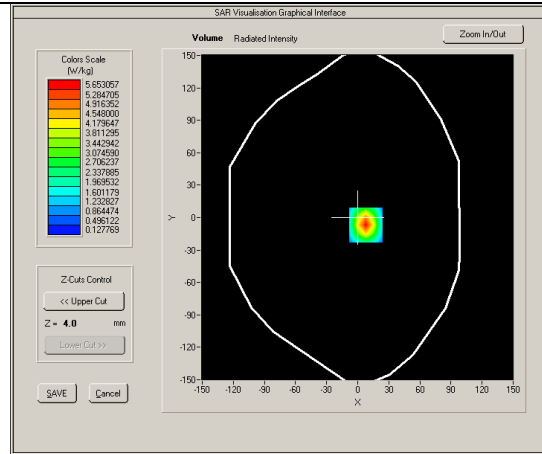
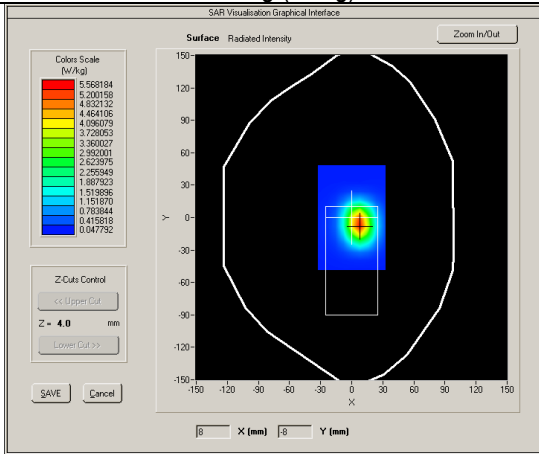

Product Description: Dipole  
Model: SID2600  
Test Date: Jul 5,2017

Medium(liquid type)	HSL_2600
Frequency (MHz)	2600.000
Relative permittivity (real part)	39.1
Conductivity (S/m)	1.97
Input power	100mW
E-Field Probe	SN 27/15 EPGO262
Crest factor	1.0
Conversion Factor	2.05
Sensor-Surface	4mm
Area Scan	dx=8mm dy=8mm
Zoom Scan	5x5x7,dx=8mm dy=8mm dz=5mm
Variation (%)	-0.250000
SAR 10g (W/Kg)	2.426663
SAR 1g (W/Kg)	5.306658

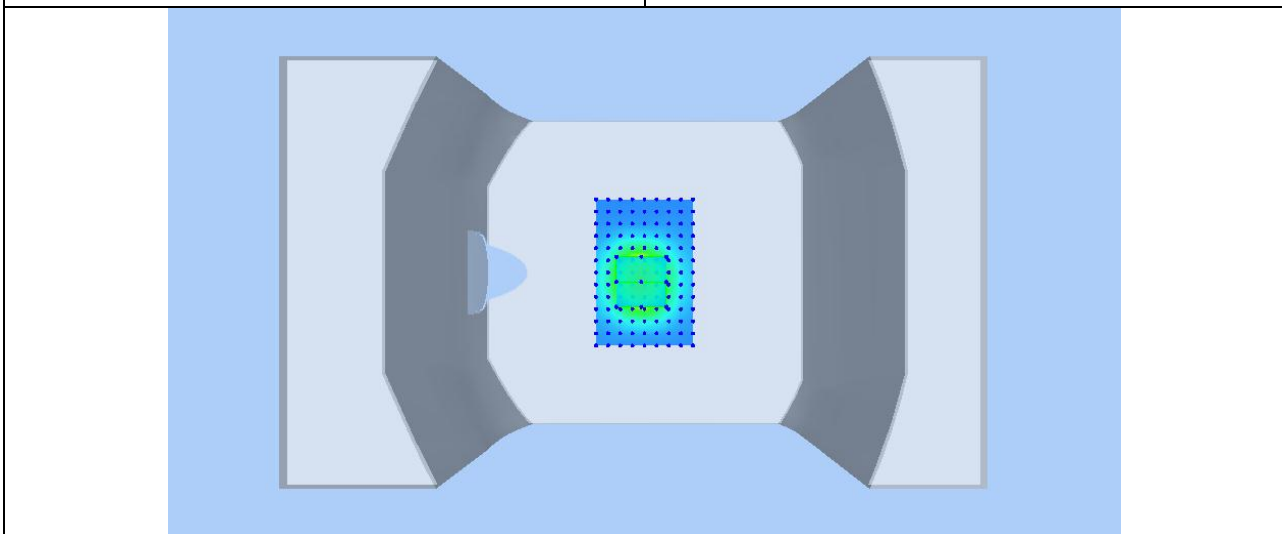
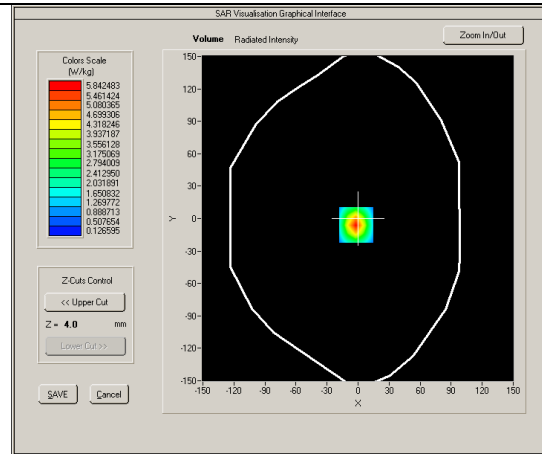
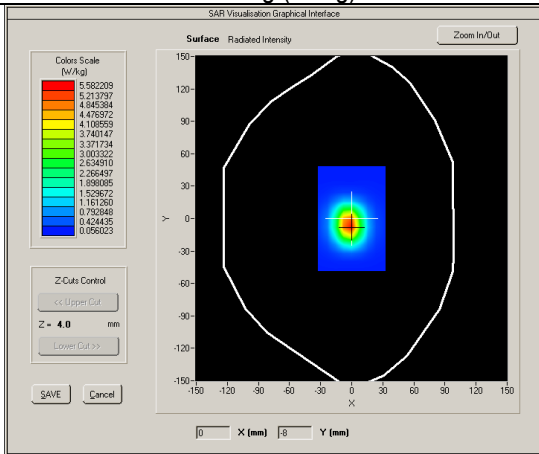

Product Description: Dipole  
Model: SID2600  
Test Date: Jul 5, 2017

Medium (liquid type)	MSL_2600
Frequency (MHz)	2600.000
Relative permittivity (real part)	51.96
Conductivity (S/m)	2.17
Input power	100mW
E-Field Probe	SN 27/15 EPGO262
Crest factor	1.0
Conversion Factor	2.12
Sensor-Surface	4mm
Area Scan	dx=8mm dy=8mm
Zoom Scan	5x5x7, dx=8mm dy=8mm dz=5mm
Variation (%)	-0.080000
SAR 10g (W/Kg)	2.582561
SAR 1g (W/Kg)	5.643963

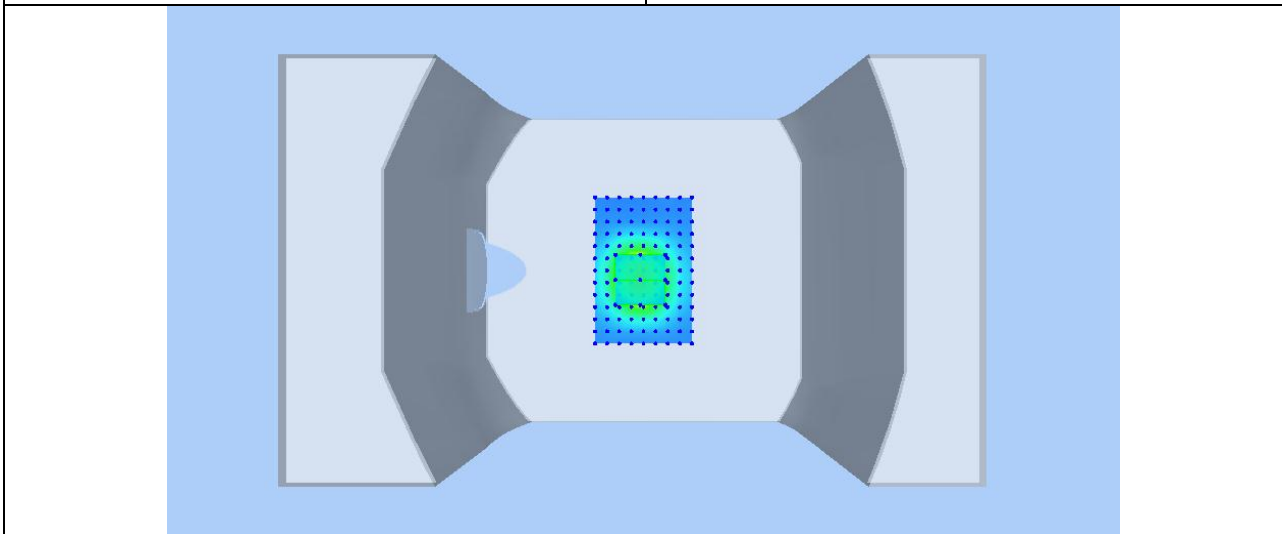
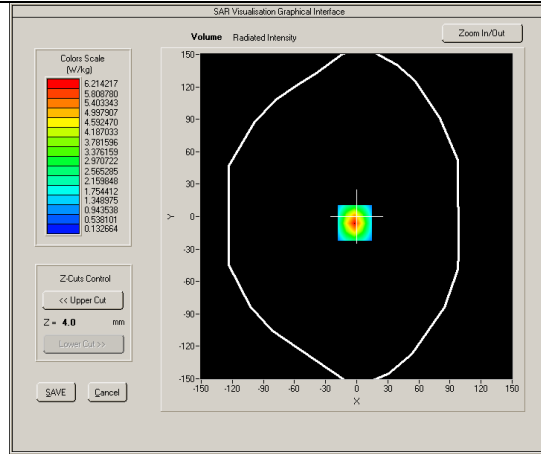
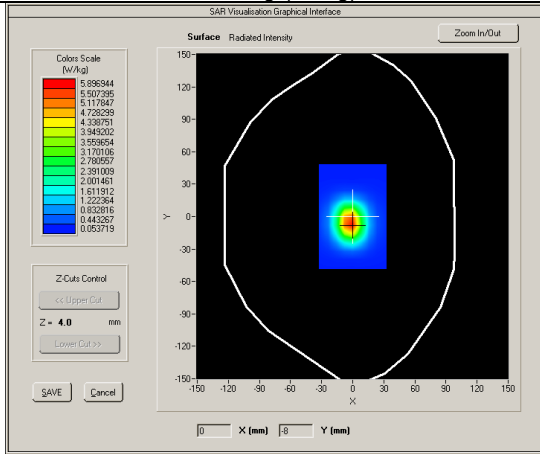

## 7 UNCERTAINTY ASSESSMENT

The component of uncertainty may generally be categorized according to the methods used to evaluate them. The evaluation of uncertainty by the statistical analysis of a series of observations is termed a Type A evaluation of uncertainty. The evaluation of uncertainty by means other than the statistical analysis of a series of observation is termed a Type B evaluation of uncertainty. Each component of uncertainty, however evaluated, is represented by an estimated standard deviation, termed standard uncertainty, which is determined by the positive square root of the estimated variance

A Type A evaluation of standard uncertainty may be based on any valid statistical method for treating data. This includes calculating the standard deviation of the mean of a series of independent observations; using the method of least squares to fit a curve to the data in order to estimate the parameter of the curve and their standard deviations; or carrying out an analysis of variance in order to identify and quantify random effects in certain kinds of measurement.

A type B evaluation of standard uncertainty is typically based on scientific judgment using all of the relevant information available. These may include previous measurement data, experience and specification, data provided in calibration reports and uncertainties assigned to reference data taken from handbooks. Broadly speaking, the uncertainty is either obtained from an outdoor source or obtained from an assumed distribution, such as the normal distribution, rectangular or triangular distributions indicated in Table below :

Uncertainty Distribution	Normal	Rectangle	Triangular	U Shape
Multi-plying Factor <sup>(a)</sup>	1/k <sup>(b)</sup>	1 / $\sqrt{3}$	1 / $\sqrt{6}$	1 / $\sqrt{2}$

(a) standard uncertainty is determined as the product of the multiplying factor and the estimated range of variations in the measured quantity

(b)  $\kappa$  is the coverage factor

### Standard Uncertainty for Assumed Distribution

The combined standard uncertainty of the measurement result represents the estimated standard deviation of the result. It is obtained by combining the individual standard uncertainties of both Type A and Type -sum-by taking the positive square root of the estimated variances.

Expanded uncertainty is a measure of uncertainty that defines an interval about the measurement result within which the measured value is confidently believed to lie. It is obtained by multiplying the combined standard uncertainty by a coverage factor. Typically, the coverage factor ranges from 2 to 3. Using a coverage factor allows the true value of a measured quantity to be specified with a defined probability within the specified uncertainty range. For purpose of this document, a coverage factor two is used, which corresponds to confidence interval of about 95 %.

The COMOSAR Uncertainty Budget is show in below table:

The following table includes the uncertainty table of the IEEE 1528 from 300MHz to 3GHz and KDB865664 to 6GHZ too, The values are determined by Satimo.

## UNCERTAINTY FOR SYSTEM PERFORMANCE CHECK

Uncertainty Component	Tol. (± %)	Prob. Dist.	Div.	c <sub>i</sub> (1 g)	c <sub>i</sub> (10 g)	1 g u <sub>i</sub> (± %)	10 g u <sub>i</sub> (± %)	V <sub>i</sub>
<b>Measurement System</b>								
Probe Calibration	5,8	N	1	1	1	5,8	5,8	∞
Axial Isotropy	3,5	R	√3	(1-cp) <sup>1/2</sup>	(1-cp) <sup>1/2</sup>	1,42887	1,42887	∞
Hemispherical Isotropy	5,9	R	√3	√Cp	√Cp	2,40866	2,40866	∞
Boundary Effect	1	R	√3	1	1	0,57735	0,57735	∞
Linearity	4,7	R	√3	1	1	2,71355	2,71355	∞
System Detection Limits	1	R	√3	1	1	0,57735	0,57735	∞
Readout Electronics	0,5	N	1	1	1	0,5	0,5	∞
Response Time	0	R	√3	1	1	0	0	∞
Integration Time	1,4	R	√3	1	1	0,80829	0,80829	∞
RF Ambient Conditions	3	R	√3	1	1	1,73205	1,73205	∞
Probe Positioner Mechanical Tolerance	1,4	R	√3	1	1	0,80829	0,80829	∞
Probe Positioning with respect to Phantom Shell	1,4	R	√3	1	1	0,80829	0,80829	∞
Extrapolation, interpolation and Integration Algorithms for Max. SAR Evaluation	2,3	R	√3	1	1	1,32791	1,32791	∞
<b>Dipole</b>								
Dipole Axis to Liquid Distance	2	N	√3	1	1	1,1547	1,1547	N-1
Input Power and SAR drift measurement	5	R	√3	1	1	2,88675	2,88675	∞
<b>Phantom and Tissue Parameters</b>								
Phantom Uncertainty (shape and thickness tolerances)	4	R	√3	1	1	2,3094	2,3094	∞
Liquid Conductivity - deviation from target values	5	R	√3	0,64	0,43	1,84752	1,2413	∞
Liquid Conductivity - measurement uncertainty	4	N	1	0,64	0,43	2,56	1,72	M
Liquid Permittivity - deviation from target values	5	R	√3	0,6	0,49	1,73205	1,41451	∞
Liquid Permittivity - measurement uncertainty	5	N	1	0,6	0,49	3	2,45	M
Combined Standard Uncertainty		RSS				9,6671	9,1645	
Expanded Uncertainty (95% CONFIDENCE INTERVAL)		k				19,3342	18,3290	

## UNCERTAINTY EVALUATION FOR HANDSET SAR TEST

Uncertainty Component	Tol. (± %)	Prob. Dist.	Div.	$c_i$ (1 g)	$c_i$ (10 g)	1 g $u_i$ (± %)	10 g $u_i$ (± %)	$v_i$
<b>Measurement System</b>								
Probe Calibration	5,8	N	1	1	1	5,8	5,8	∞
Axial Isotropy	3,5	R	$\sqrt{3}$	$(1-c_p)^{1/2}$	$(1-c_p)^{1/2}$	1,43	1,43	∞
Hemispherical Isotropy	5,9	R	$\sqrt{3}$	$\sqrt{C_p}$	$\sqrt{C_p}$	2,41	2,41	∞
Boundary Effect	1	R	$\sqrt{3}$	1	1	0,58	0,58	∞
Linearity	4,7	R	$\sqrt{3}$	1	1	2,71	2,71	∞
System Detection Limits	1	R	$\sqrt{3}$	1	1	0,58	0,58	∞
Readout Electronics	0,5	N	1	1	1	0,50	0,50	∞
Response Time	0	R	$\sqrt{3}$	1	1	0,00	0,00	∞
Integration Time	1,4	R	$\sqrt{3}$	1	1	0,81	0,81	∞
RF Ambient Conditions	3	R	$\sqrt{3}$	1	1	1,73	1,73	∞
Probe Positioner Mechanical Tolerance	1,4	R	$\sqrt{3}$	1	1	0,81	0,81	∞
Probe Positioning with respect to Phantom Shell	1,4	R	$\sqrt{3}$	1	1	0,81	0,81	∞
Extrapolation, interpolation and Integration Algorithms for Max. SAR Evaluation	2,3	R	$\sqrt{3}$	1	1	1,33	1,33	∞
<b>Test sample Related</b>								
Test Sample Positioning	2,6	N	1	1	1	2,60	2,60	N-1
Device Holder Uncertainty	3	N	1	1	1	3,00	3,00	N-1
Output Power Variation - SAR drift measurement	5	R	$\sqrt{3}$	1	1	2,89	2,89	∞
<b>Phantom and Tissue Parameters</b>								
Phantom Uncertainty (shape and thickness tolerances)	4	R	$\sqrt{3}$	1	1	2,31	2,31	∞
Liquid Conductivity - deviation from target values	5	R	$\sqrt{3}$	0,64	0,43	1,85	1,24	∞
Liquid Conductivity - measurement uncertainty	4	N	1	0,64	0,43	2,56	1,72	M
Liquid Permittivity - deviation from target values	5	R	$\sqrt{3}$	0,6	0,49	1,73	1,41	∞
Liquid Permittivity - measurement uncertainty	5	N	1	0,6	0,49	3,00	2,45	M
Combined Standard Uncertainty		RSS				10,39	9,92	
Expanded Uncertainty (95% CONFIDENCE INTERVAL)		k				20,78	19,84	

## 8 TEST INSTRUMENT

### TEST INSTRUMENTATION

Name of Equipment	Manufacturer	Type/Model	Serial Number	Calibration Date	Calibration Due
P C	Compaq	PV 3.06GHz	375052-AA1	N/A	N/A
Signal Generator	Agilent	8665B-008	3744A10293	05/15/2017	05/15/2018
MultiMeter	Keithley	MiltiMeter 2000	1259033	06/21/2017	06/21/2018
S-Parameter Network Analyzer	Agilent	8753ES	US39173518	08/04/2016	08/04/2017
Wireless Communication Test Set	R & S	CMU200	111078	07/22/2016	07/22/2017
Wideband Radio Communication Tester	R & S	CMW500	120906	03/29/2017	03/28/2018
Power Meter	HP	437B	3038A03648	05/17/2017	05/17/2018
E-field PROBE	MVG	SSE2	SN 27/15 EPGO262	09/20/2016	09/20/2017
DIPOLE 750	SATIMO	SID 750	SN26/14 DIP 0G750-325	06/8/2017	06/8/2018
DIPOLE 835	SATIMO	SID 835	SN 18/11 DIPC 150	06/8/2017	06/8/2018
DIPOLE 1800	SATIMO	SID 1800	SN 18/11 DIPF 152	06/8/2017	06/8/2018
DIPOLE 1900	SATIMO	SID 1900	SN 18/11 DIPG 153	06/8/2017	06/8/2018
DIPOLE 2450	SATIMO	SID 2450	SN 31/10 DIPJ138	06/8/2017	06/8/2018
DIPOLE 2600	SATIMO	SID 2600	SN 26/14 DIP 2G600-326	06/8/2017	06/8/2018
Communication Antenna	SATIMO	ANTA3	SN 20/11 ANTA 3	06/21/2017	06/20/2018
Laptop POSITIONING DEVICE	SATIMO	LSH15	SN 24/11 LSH15	N/A	N/A
e\POSITIONING DEVICE	SATIMO	MSH73	SN 24/11 MSH73	N/A	N/A
DUMMY PROBE	ANTENNESSA		DP41	N/A	N/A
SAM PHANTOM	SATIMO	SAM87	SN 24/11 SAM87	N/A	N/A
Elliptic Phantom	SATIMO	ELLI20	SN 20/11ELLI20	N/A	N/A
PHANTOM TABLE	SATIMO	N/A	N/A	N/A	N/A
6 AXIS ROBOT	KUKA	KR5	949272	N/A	N/A
high Power Solid State Amplifier (80MHz~1000MHz)	Instruments for Industry	CMC150	M631-0408	05/16/2017	05/16/2018
Medium Power Solid State Amplifier (0.8~4.2GHz)	Instruments for Industry	S41-25	M629-0408	06/28/2017	06/28/2018
Wave Tube Amplifier 4-8 GHz at 20Watt	Hughes Aircraft Company	1277H02F000	81	08/22/2016	08/22/2017



## 9 OUTPUT POWER VERIFICATION

### Test Condition:

1. Conducted Measurement  
EUT was set for low, mid, high channel with modulated mode and highest RF output power.  
The base station simulator was connected to the antenna terminal.
2. Conducted Emissions Measurement Uncertainty  
All test measurements carried out are traceable to national standards. The uncertainty of the measurement at a confidence level of approximately 95% (in the case where distributions are normal), with a coverage factor of 2, in the range 30MHz – 40GHz is  $\pm 1.5$ dB.
3. Environmental Conditions
 

Temperature	23°C
Relative Humidity	53%
Atmospheric Pressure	1019mbar
4. Test Date : Jun 23,2017  
Tested By : York Liu

### Test Procedures:

#### LTE Mobile Phone radio output power measurement

1. The transmitter output port was connected to base station emulator.
2. Establish communication link between emulator and EUT and set EUT to operate at maximum output power all the time.
3. Select lowest, middle, and highest channels for each band and different possible test mode.
4. Measure the conducted peak burst power and conducted average burst power from EUT antenna port.

#### Other radio output power measurement

The output power was measured using power meter at low, mid, and hi channels.

### Source-based Time Averaged Burst Power Calculation:

For TDMA, the following duty cycle factor was used to calculate the source-based time average power

Number of Time slot	1	2	3	4
Duty Cycle	1:8	1:4	1:2.66	1:2
Duty cycle factor	-9.03 dB	-6.02 dB	-4.26 dB	-3.01 dB
Crest Factor	8	4	2.66	2

**Remark:** *Time slot duty cycle factor =  $10 * \log (1 / \text{Time Slot Duty Cycle})$*

*Source based time averaged power = Maximum burst averaged power (1 Uplink) – 9.03 dB*

*Source based time averaged power = Maximum burst averaged power (2 Uplink) – 6.02 dB*

*Source based time averaged power = Maximum burst averaged power (4 Uplink) – 3.01 dB*

**Test Result:**

**GSM:**

Burst Average Power (dBm);								
Band	GSM850				PCS1900			
Channel	128	190	251	Tune up Power tolerant	512	661	810	Tune up Power tolerant
Frequency (MHz)	824.2	836.6	848.8	/	1850.2	1880	1909.8	/
GSM Voice (1 uplink),GMSK	32.18	32.07	32.14	32±1	30.28	30.23	30.2	30±1
GPRS Multi-Slot Class 8 (1 uplink),GMSK	32.16	32.12	32.15	32±1	30.29	30.23	30.18	30±1
GPRS Multi-Slot Class 10 (2 uplink),GMSK	30.45	30.38	30.41	30±1	28.72	28.72	28.8	28±1
GPRS Multi-Slot Class 12 (4 uplink),GMSK	28.09	28.01	28.04	28±1	25.83	25.87	25.87	25±1
EGPRS Multi-Slot Class 8 (1 uplink) GMSK MCS1	32.07	32.11	32.16	32±1	30.35	30.3	30.27	30±1
EGPRS Multi-Slot Class 10 (2 uplink) GMSK MCS1	30.49	30.44	30.5	30±1	28.82	28.84	28.89	28±1
EGPRS Multi-Slot Class 12 (4 uplink) GMSK MCS1	28.06	28.07	28.11	28±1	25.88	25.9	25.96	25±1
EGPRS Multi-Slot Class 8 (1 uplink) 8PSK MCS5	27.33	27.36	27.27	27±1	26.93	26.75	26.78	26±1
EGPRS Multi-Slot Class 10 (2 uplink) 8PSK MCS5	26.35	26.32	26.2	26±1	26.05	25.67	25.8	26±1
EGPRS Multi-Slot Class 12 (4 uplink) 8PSK MCS5	22.4	22.36	22.26	22±1	22.03	21.65	21.68	22±1

Remark :  
 GPRS, CS1 coding scheme.  
 EGPRS, MCS1 coding scheme.  
 EGPRS, MCS5 coding scheme.  
 Multi-Slot Class 8 , Support Max 4 downlink, 1 uplink , 5 working link  
 Multi-Slot Class 10 , Support Max 4 downlink, 2 uplink , 5 working link  
 Multi-Slot Class 12 , Support Max 4 downlink, 4 uplink , 5 working link

Source Based time Average Power (dBm)								
Band	GSM850				PCS1900			
Channel	128	190	251	Time Average factor	512	661	810	Time Average factor
Frequency (MHz)	824.2	836.6	848.8	/	1850.2	1880	1909.8	/
GSM Voice (1 uplink),GMSK	23.15	23.04	23.11	-9.03	21.25	21.20	21.17	-9.03
GPRS Multi-Slot Class 8 (1 uplink),GMSK	23.13	23.09	23.12	-9.03	21.26	21.20	21.15	-9.03
GPRS Multi-Slot Class 10 (2 uplink),GMSK	24.43	24.36	24.39	-6.02	22.70	22.70	22.78	-6.02
GPRS Multi-Slot Class 12 (4 uplink),GMSK	25.08	25.00	25.03	-3.01	22.82	22.86	22.86	-3.01
EGPRS Multi-Slot Class 8 (1 uplink) GMSK MCS1	23.04	23.08	23.13	-9.03	21.32	21.27	21.24	-9.03
EGPRS Multi-Slot Class 10 (2 uplink) GMSK MCS1	24.47	24.42	24.48	-6.02	22.80	22.82	22.87	-6.02
EGPRS Multi-Slot Class 12 (4 uplink) GMSK MCS1	25.05	25.06	25.10	-3.01	22.87	22.89	22.95	-3.01
EGPRS Multi-Slot Class 8 (1 uplink) 8PSK MCS5	18.30	18.33	18.24	-9.03	17.90	17.72	17.75	-9.03
EGPRS Multi-Slot Class 10 (2 uplink) 8PSK MCS5	20.33	20.30	20.18	-6.02	20.03	19.65	19.78	-6.02
EGPRS Multi-Slot Class 12 (4 uplink) 8PSK MCS5	19.39	19.35	19.25	-3.01	19.02	18.64	18.67	-3.01

Remark :

Time average factor = 1 uplink ,  $10 \cdot \log(1/8) = -9.03\text{dB}$  , 2 uplink ,  $10 \cdot \log(2/8) = -6.02\text{dB}$  , 4 uplink ,  $10 \cdot \log(4/8) = -3.01\text{dB}$   
 Source based time average power = Burst Average power + Time Average factor

**Note:** 1. due to the source based time average power; Body SAR was performed at EGPRS Multi-slot class 12 (MCS1).

**WCDMA BAND V**

Band/ Time Slot configuration	Channel	Frequency	Average power (dBm)	Tune up Power tolerant
RMC 12.2kbps	4132	826.4	22.16	22 ± 1
	4175	835	22.18	22 ± 1
	4233	846.6	22.3	22 ± 1
HSDPA Subtest1	4132	826.4	21.36	21.3 ± 1
	4175	835	21.45	21.3 ± 1
	4233	846.6	21.42	21.3 ± 1
HSDPA Subtest2	4132	826.4	21.39	21.3 ± 1
	4175	835	21.26	21.3 ± 1
	4233	846.6	21.42	21.3 ± 1
HSDPA Subtest3	4132	826.4	21.23	21.3 ± 1
	4175	835	21.16	21.3 ± 1
	4233	846.6	21.19	21.3 ± 1
HSDPA Subtest4	4132	826.4	21.34	21.3 ± 1
	4175	835	21.26	21.3 ± 1
	4233	846.6	21.26	21.3 ± 1
HSUPA Subtest1	4132	826.4	21.16	21.3 ± 1
	4175	835	21.26	21.3 ± 1
	4233	846.6	21.13	21.3 ± 1
HSUPA Subtest2	4132	826.4	21.19	21.3 ± 1
	4175	835	21.14	21.3 ± 1
	4233	846.6	21.18	21.3 ± 1
HSUPA Subtest3	4132	826.4	21.26	21.3 ± 1
	4175	835	21.25	21.3 ± 1
	4233	846.6	21.28	21.3 ± 1
HSUPA Subtest4	4132	826.4	21.16	21.3 ± 1
	4175	835	21.25	21.3 ± 1
	4233	846.6	21.16	21.3 ± 1
HSUPA Subtest5	4132	826.4	21.16	21.3 ± 1
	4175	835	21.23	21.3 ± 1
	4233	846.6	21.18	21.3 ± 1

**Note:** 1. Due to the maximum SAR for 12.2kbps RMC < 75% of the SAR limit, SAR was performed at RMC 12.2kbps.

**WCDMA Band II :**

Band/ Time Slot configuration	Channel	Frequency	Average power (dBm)	Tune up Power tolerant
RMC 12.2kbps	9262	1852.4	22.85	22 ± 1
	9400	1880	22.94	22 ± 1
	9538	1907.6	22.61	22 ± 1
HSDPA Subtest1	9262	1852.4	21.62	21.3 ± 1
	9400	1880	21.63	21.3 ± 1
	9538	1907.6	21.64	21.3 ± 1
HSDPA Subtest2	9262	1852.4	21.65	21.3 ± 1
	9400	1880	21.63	21.3 ± 1
	9538	1907.6	21.71	21.3 ± 1
HSDPA Subtest3	9262	1852.4	21.56	21.3 ± 1
	9400	1880	21.52	21.3 ± 1
	9538	1907.6	21.61	21.3 ± 1
HSDPA Subtest4	9262	1852.4	21.72	21.3 ± 1
	9400	1880	21.76	21.3 ± 1
	9538	1907.6	21.49	21.3 ± 1
HSUPA Subtest1	9262	1852.4	21.69	21.3 ± 1
	9400	1880	21.68	21.3 ± 1
	9538	1907.6	21.66	21.3 ± 1
HSUPA Subtest2	9262	1852.4	21.74	21.3 ± 1
	9400	1880	21.56	21.3 ± 1
	9538	1907.6	21.74	21.3 ± 1
HSUPA Subtest3	9262	1852.4	21.56	21.3 ± 1
	9400	1880	21.52	21.3 ± 1
	9538	1907.6	21.63	21.3 ± 1
HSUPA Subtest4	9262	1852.4	21.6	21.3 ± 1
	9400	1880	21.65	21.3 ± 1
	9538	1907.6	21.49	21.3 ± 1
HSUPA Subtest5	9262	1852.4	21.58	21.3 ± 1
	9400	1880	21.64	21.3 ± 1
	9538	1907.6	21.66	21.3 ± 1

**Note:** 1. Due to the maximum SAR for 12.2kbps RMC < 75% of the SAR limit, SAR was performed at RMC 12.2kbps.

### LTE Power Reduction

The following tests were conducted according to the test requirements outlined in section 6.2 of the 3GPP TS36.101 specification.

The allowed Maximum Power Reduction (MPR) for the maximum output power due to higher order modulation and transmit bandwidth configuration (resource blocks) is specified in Table 6.2.3-1 of the 3GPP TS36.101.

**Table 6.2.3-1: Maximum Power Reduction (MPR) for Power Class 3**

Modulation	Channel bandwidth / Transmission bandwidth (RB)						MPR (dB)
	1.4 MHz	3.0 MHz	5 MHz	10 MHz	15 MHz	20 MHz	
QPSK	> 5	> 4	> 8	> 12	> 16	> 18	≤ 1
16 QAM	≤ 5	≤ 4	≤ 8	≤ 12	≤ 16	≤ 18	≤ 1
16 QAM	> 5	> 4	> 8	> 12	> 16	> 18	≤ 2

The allowed A-MPR values specified below in Table 6.2.4-1 of 3GPP TS36.101 are in addition to the allowed MPR requirements. All the measurements below were performed with A-MPR disabled, by using Network Signalling Value of "NS\_01".

**Table 6.2.4-1: Additional Maximum Power Reduction (A-MPR)**

Network Signalling value	Requirements (sub-clause)	E-UTRA Band	Channel bandwidth (MHz)	Resources Blocks ( $N_{RB}$ )	A-MPR (dB)
NS_01	6.6.2.1.1	Table 5.5-1	1.4, 3, 5, 10, 15, 20	Table 5.6-1	NA
NS_03	6.6.2.2.1	2, 4, 10, 23, 25, 35, 36	3	>5	≤ 1
			5	>6	≤ 1
			10	>6	≤ 1
			15	>8	≤ 1
			20	>10	≤ 1
NS_04	6.6.2.2.2	41	5	>6	≤ 1
			10, 15, 20	See Table 6.2.4-4	
NS_05	6.6.3.3.1	1	10,15,20	≥ 50	≤ 1
NS_06	6.6.2.2.3	12, 13, 14, 17	1.4, 3, 5, 10	Table 5.6-1	n/a
NS_07	6.6.2.2.3	13	10	Table 6.2.4-2	Table 6.2.4-2
	6.6.3.3.2				
NS_08	6.6.3.3.3	19	10, 15	> 44	≤ 3
NS_09	6.6.3.3.4	21	10, 15	> 40	≤ 1
				> 55	≤ 2
NS_10		20	15, 20	Table 6.2.4-3	Table 6.2.4-3
NS_11	6.6.2.2.1	23 <sup>1</sup>	1.4, 3, 5, 10	Table 6.2.4-5	Table 6.2.4-5
..					
NS_32	-	-	-	-	-

Note 1: Applies to the lower block of Band 23, i.e. a carrier placed in the 2000-2010 MHz region.

**LTE Band II:**

BW (MHz)	Ch	Freq. (MHz)	Mode	UL RB Allocation	UL RB Offset	MPR	Average power (dBm)	Tune up Power tolerant
20MHz	18700	1860.0	QPSK	1	0	0	23.51	23±1
				1	49	0	23.5	23±1
				1	99	0	23.46	23±1
				50	0	1	22.4	23±1
				50	24	1	22.24	23±1
				50	49	1	22.37	23±1
				100	0	1	22.38	23±1
			16QAM	1	0	1	22.41	21.8±1
				1	49	1	22.28	21.8±1
				1	99	1	22.51	21.8±1
				50	0	2	21.22	21.8±1
				50	24	2	21.09	21.8±1
				50	49	2	21.16	21.8±1
				100	0	2	21.36	21.8±1
	18900	1880.0	QPSK	1	0	0	23.31	23±1
				1	49	0	23.6	23±1
				1	99	0	23.4	23±1
				50	0	1	22.29	23±1
				50	24	1	22.29	23±1
				50	49	1	22.5	23±1
				100	0	1	22.3	23±1
			16QAM	1	0	1	22.7	21.8±1
				1	49	1	22.55	21.8±1
				1	99	1	22.7	21.8±1
				50	0	2	21.57	21.8±1
				50	24	2	21.31	21.8±1
				50	49	2	21.14	21.8±1
				100	0	2	21.3	21.8±1
	19100	1900.0	QPSK	1	0	0	23.18	22.6±1
				1	49	0	22.94	22.6±1
1				99	0	23	22.6±1	
50				0	1	22.3	22.6±1	
50				24	1	22.52	22.6±1	
50				49	1	22.53	22.6±1	
100				0	1	22.26	22.6±1	
16QAM			1	0	1	22.5	21.8±1	
			1	49	1	22.38	21.8±1	
			1	99	1	22.43	21.8±1	
			50	0	2	21.34	21.8±1	
			50	24	2	21.11	21.8±1	
			50	49	2	21.19	21.8±1	
			100	0	2	21.31	21.8±1	

BW (MHz)	Ch	Freq. (MHz)	Mode	UL RB Allocation	UL RB Offset	MPR	Average power (dBm)	Tune up Power tolerant
15MHz	18675	1857.5	QPSK	1	0	0	23.29	22.8±1
				1	37	0	23.24	22.8±1
				1	74	0	23.27	22.8±1
				36	0	1	22.37	22.8±1
				36	16	1	22.51	22.8±1
				36	35	1	22.29	22.8±1
				75	0	1	22.33	22.8±1
			16QAM	1	0	1	22.86	22±1
				1	37	1	22.85	22±1
				1	74	1	22.81	22±1
				36	0	2	21.43	22±1
				36	16	2	21.27	22±1
				36	35	2	21.17	22±1
				75	0	2	21.35	22±1
	18900	1880.0	QPSK	1	0	0	23.35	22.8±1
				1	37	0	23.42	22.8±1
				1	74	0	23.41	22.8±1
				36	0	1	22.32	22.8±1
				36	16	1	22.17	22.8±1
				36	35	1	22.6	22.8±1
				75	0	1	22.3	22.8±1
			16QAM	1	0	1	22.16	21.3±1
				1	37	1	21.93	21.3±1
				1	74	1	21.87	21.3±1
				36	0	2	21.05	21.3±1
				36	16	2	21.06	21.3±1
				36	35	2	21.32	21.3±1
75				0	2	21.27	21.3±1	
19125	1902.5	QPSK	1	0	0	23.2	22.8±1	
			1	37	0	22.95	22.8±1	
			1	74	0	22.95	22.8±1	
			36	0	1	22.27	22.8±1	
			36	16	1	22.54	22.8±1	
			36	35	1	22.37	22.8±1	
			75	0	1	22.28	22.8±1	
		16QAM	1	0	1	22.53	21.8±1	
			1	37	1	22.37	21.8±1	
			1	74	1	22.57	21.8±1	
			36	0	2	21.2	21.8±1	
			36	16	2	21.36	21.8±1	
			36	35	2	21.03	21.8±1	
			75	0	2	21.26	21.8±1	



BW (MHz)	Ch	Freq. (MHz)	Mode	UL RB Allocation	UL RB Offset	MPR	Average power (dBm)	Tune up Power tolerant
10MHz	18650	1855	QPSK	1	0	0	23.28	23±1
				1	24	0	23.27	23±1
				1	49	0	23.09	23±1
				25	0	1	22.33	23±1
				25	12	1	22.5	23±1
				25	24	1	22.59	23±1
				50	0	1	22.32	23±1
			16QAM	1	0	1	22.88	22±1
				1	24	1	22.8	22±1
				1	49	1	22.85	22±1
				25	0	2	21.54	22±1
				25	12	2	21.42	22±1
				25	24	2	21.47	22±1
				50	0	2	21.34	22±1
	18900	1880.0	QPSK	1	0	0	23.34	22.8±1
				1	24	0	23.26	22.8±1
				1	49	0	23.61	22.8±1
				25	0	1	22.26	22.8±1
				25	12	1	22.13	22.8±1
				25	24	1	22.3	22.8±1
				50	0	1	22.25	22.8±1
			16QAM	1	0	1	22.13	21.3±1
				1	24	1	21.93	21.3±1
				1	49	1	22.04	21.3±1
				25	0	2	21.39	21.3±1
				25	12	2	20.94	21.3±1
				25	24	2	21.3	21.3±1
				50	0	2	21.21	21.3±1
	19150	1905	QPSK	1	0	0	23.3	22.8±1
				1	24	0	23.24	22.8±1
1				49	0	23.49	22.8±1	
25				0	1	22.24	22.8±1	
25				12	1	22.3	22.8±1	
25				24	1	21.95	22.8±1	
50				0	1	22.23	22.8±1	
16QAM			1	0	1	22.24	21.5±1	
			1	24	1	22.21	21.5±1	
			1	49	1	22.44	21.5±1	
			25	0	2	21.41	21.5±1	
			25	12	2	21.4	21.5±1	
			25	24	2	21.02	21.5±1	
			50	0	2	21.25	21.5±1	

BW (MHz)	Ch	Freq. (MHz)	Mode	UL RB Allocation	UL RB Offset	MPR	Average power (dBm)	Tune up Power tolerant
5MHz	18625	1852.5	QPSK	1	0	0	23.43	23±1
				1	12	0	23.41	23±1
				1	24	0	23.3	23±1
				12	0	1	22.41	23±1
				12	6	1	22.53	23±1
				12	11	1	22.53	23±1
				25	0	1	22.34	23±1
			16QAM	1	0	1	22.36	21.8±1
				1	12	1	22.25	21.8±1
				1	24	1	22.08	21.8±1
				12	0	2	21.51	21.8±1
				12	6	2	21.22	21.8±1
				12	11	2	21.47	21.8±1
				25	0	2	21.44	21.8±1
	18900	1880.0	QPSK	1	0	0	23.41	22.5±1
				1	12	0	23.17	22.5±1
				1	24	0	23.24	22.5±1
				12	0	1	22.31	22.5±1
				12	6	1	22.44	22.5±1
				12	11	1	22.56	22.5±1
				25	0	1	22.26	22.5±1
			16QAM	1	0	1	22.35	21.8±1
				1	12	1	22.18	21.8±1
				1	24	1	22.55	21.8±1
				12	0	2	21.46	21.8±1
				12	6	2	20.97	21.8±1
				12	11	2	21.25	21.8±1
25				0	2	21.21	21.8±1	
19175	1907.5	QPSK	1	0	0	23.27	22.5±1	
			1	12	0	23.29	22.5±1	
			1	24	0	23.15	22.5±1	
			12	0	1	22.28	22.5±1	
			12	6	1	22.16	22.5±1	
			12	11	1	22.4	22.5±1	
			25	0	1	22.22	22.5±1	
		16QAM	1	0	1	22.54	21.5±1	
			1	12	1	22.48	21.5±1	
			1	24	1	22.3	21.5±1	
			12	0	2	21.19	21.5±1	
			12	6	2	21.07	21.5±1	
			12	11	2	21.22	21.5±1	
			25	0	2	21.19	21.5±1	

BW (MHz)	Ch	Freq. (MHz)	Mode	UL RB Allocation	UL RB Offset	MPR	Average power (dBm)	Tune up Power tolerant
3MHz	18625	1852.5	QPSK	1	0	0	23.2	22.5±1
				1	7	0	23.38	22.5±1
				1	14	0	23.14	22.5±1
				8	0	1	22.33	22.5±1
				8	4	1	22.58	22.5±1
				8	7	1	22.22	22.5±1
				15	0	1	22.35	22.5±1
			16QAM	1	0	1	22.79	22.3±1
				1	7	1	22.67	22.3±1
				1	14	1	22.73	22.3±1
				8	0	2	21.48	22.3±1
				8	4	2	21.43	22.3±1
				8	7	2	21.43	22.3±1
				15	0	2	21.42	22.3±1
	18900	1880.0	QPSK	1	0	0	23.26	22.5±1
				1	7	0	23.26	22.5±1
				1	14	0	23.23	22.5±1
				8	0	1	22.26	22.5±1
				8	4	1	22.41	22.5±1
				8	7	1	22.49	22.5±1
				15	0	1	22.22	22.5±1
			16QAM	1	0	1	22.08	21.5±1
				1	7	1	22.21	21.5±1
				1	14	1	22.26	21.5±1
				8	0	2	21.19	21.5±1
				8	4	2	21.33	21.5±1
				8	7	2	21.44	21.5±1
				15	0	2	21.15	21.5±1
	19175	1907.5	QPSK	1	0	0	23.23	22.5±1
				1	7	0	23.31	22.5±1
1				14	0	22.98	22.5±1	
8				0	1	22.2	22.5±1	
8				4	1	21.98	22.5±1	
8				7	1	22.19	22.5±1	
15				0	1	22.21	22.5±1	
16QAM			1	0	1	22.18	21.5±1	
			1	7	1	22.1	21.5±1	
			1	14	1	22.34	21.5±1	
			8	0	2	21.05	21.5±1	
			8	4	2	21.21	21.5±1	
			8	7	2	21.08	21.5±1	
			15	0	2	21.21	21.5±1	

BW (MHz)	Ch	Freq. (MHz)	Mode	UL RB Allocation	UL RB Offset	MPR	Average power (dBm)	Tune up Power tolerant
1.4MHz	18607	1850.7	QPSK	1	0	0	23.27	22.5±1
				1	2	0	23.04	22.5±1
				1	5	0	23.29	22.5±1
				3	0	0	23.38	22.5±1
				3	1	0	23.15	22.5±1
				3	2	0	23.33	22.5±1
			6	0	1	22.33	22.5±1	
			16QAM	1	0	1	21.96	21.3±1
				1	2	1	22.1	21.3±1
				1	5	1	22.1	21.3±1
				3	0	1	21.34	21.3±1
				3	1	1	21.17	21.3±1
	3	2		1	21.25	21.3±1		
	18900	1880.0	QPSK	1	0	0	23.27	23±1
				1	2	0	23.25	23±1
				1	5	0	23.3	23±1
				3	0	0	23.31	23±1
				3	1	0	23.5	23±1
				3	2	0	23.5	23±1
			6	0	1	22.25	23±1	
			16QAM	1	0	1	22.09	21.8±1
				1	2	1	22.02	21.8±1
				1	5	1	22.3	21.8±1
				3	0	1	21.23	21.8±1
				3	1	1	21.48	21.8±1
	3	2		1	21.37	21.8±1		
	19193	1909.3	QPSK	1	0	0	23.24	23±1
				1	2	0	23.35	23±1
				1	5	0	23.02	23±1
				3	0	0	23.23	23±1
3				1	0	22.96	23±1	
3				2	0	23.25	23±1	
6			0	1	22.23	23±1		
16QAM			1	0	1	22.18	21.5±1	
			1	2	1	22.34	21.5±1	
			1	5	1	22.4	21.5±1	
			3	0	1	20.96	21.5±1	
			3	1	1	21.24	21.5±1	
	3	2	1	21.35	21.5±1			
6	0	2	21.07	21.5±1				

**LTE Band IV:**

BW (MHz)	Ch	Freq. (MHz)	Mode	UL RB Allocation	UL RB Offset	MPR	Average power (dBm)	Tune up Power tolerant
20MHz	20050	1720.0	QPSK	1	0	0	23.56	23±1
				1	49	0	23.6	23±1
				1	99	0	23.58	23±1
				50	0	1	22.54	23±1
				50	24	1	22.61	23±1
				50	49	1	22.59	23±1
				100	0	1	22.53	23±1
			16QAM	1	0	1	22.9	21.8±1
				1	49	1	22.84	21.8±1
				1	99	1	22.84	21.8±1
				50	0	2	21.46	21.8±1
				50	24	2	21.47	21.8±1
				50	49	2	21.38	21.8±1
				100	0	2	21.51	21.8±1
	20175	1732.5	QPSK	1	0	0	23.61	23±1
				1	49	0	23.52	23±1
				1	99	0	23.58	23±1
				50	0	1	22.51	23±1
				50	24	1	22.44	23±1
				50	49	1	22.46	23±1
				100	0	1	22.49	23±1
			16QAM	1	0	1	22.52	22±1
				1	49	1	22.46	22±1
				1	99	1	22.45	22±1
				50	0	2	21.67	22±1
				50	24	2	21.66	22±1
				50	49	2	21.76	22±1
				100	0	2	21.48	22±1
	20300	1745.0	QPSK	1	0	0	23.43	22.5±1
				1	49	0	23.39	22.5±1
1				99	0	23.46	22.5±1	
50				0	1	22.47	22.5±1	
50				24	1	22.48	22.5±1	
50				49	1	22.42	22.5±1	
100				0	1	22.47	22.5±1	
16QAM			1	0	1	22.66	21.8±1	
			1	49	1	22.71	21.8±1	
			1	99	1	22.68	21.8±1	
			50	0	2	21.44	21.8±1	
			50	24	2	21.53	21.8±1	
			50	49	2	21.36	21.8±1	
			100	0	2	21.44	21.8±1	

BW (MHz)	Ch	Freq. (MHz)	Mode	UL RB Allocation	UL RB Offset	MPR	Average power (dBm)	Tune up Power tolerant
15MHz	20025	1717.5	QPSK	1	0	0	23.5	22.8±1
				1	37	0	23.54	22.8±1
				1	74	0	23.55	22.8±1
				36	0	1	22.6	22.8±1
				36	16	1	22.54	22.8±1
				36	35	1	22.51	22.8±1
				75	0	1	22.57	22.8±1
			16QAM	1	0	1	23	22±1
				1	37	1	22.97	22±1
				1	74	1	22.97	22±1
				36	0	2	21.75	22±1
				36	16	2	21.83	22±1
				36	35	2	21.7	22±1
				75	0	2	21.58	22±1
	20175	1732.5	QPSK	1	0	0	23.57	23±1
				1	37	0	23.64	23±1
				1	74	0	23.67	23±1
				36	0	1	22.53	23±1
				36	16	1	22.45	23±1
				36	35	1	22.48	23±1
				75	0	1	22.57	23±1
			16QAM	1	0	1	22.38	22±1
				1	37	1	22.42	22±1
				1	74	1	22.44	22±1
				36	0	2	21.81	22±1
				36	16	2	21.88	22±1
				36	35	2	21.9	22±1
				75	0	2	21.55	22±1
20325	1747.5	QPSK	1	0	0	23.5	22.8±1	
			1	37	0	23.57	22.8±1	
			1	74	0	23.51	22.8±1	
			36	0	1	22.56	22.8±1	
			36	16	1	22.59	22.8±1	
			36	35	1	22.64	22.8±1	
			75	0	1	22.56	22.8±1	
		16QAM	1	0	1	22.61	22±1	
			1	37	1	22.66	22±1	
			1	74	1	22.65	22±1	
			36	0	2	21.25	22±1	
			36	16	2	21.31	22±1	
			36	35	2	21.34	22±1	
			75	0	2	21.48	22±1	

BW (MHz)	Ch	Freq. (MHz)	Mode	UL RB Allocation	UL RB Offset	MPR	Average power (dBm)	Tune up Power tolerant
10MHz	20000	1715.0	QPSK	1	0	0	23.49	23±1
				1	24	0	23.4	23±1
				1	49	0	23.47	23±1
				25	0	1	22.52	23±1
				25	12	1	22.59	23±1
				25	24	1	22.49	23±1
				50	0	1	22.51	23±1
			16QAM	1	0	1	23	22.3±1
				1	24	1	22.97	22.3±1
				1	49	1	23.07	22.3±1
				25	0	2	21.66	22.3±1
				25	12	2	21.59	22.3±1
				25	24	2	21.67	22.3±1
				50	0	2	21.51	22.3±1
	20175	1732.5	QPSK	1	0	0	23.57	23±1
				1	24	0	23.65	23±1
				1	49	0	23.55	23±1
				25	0	1	22.52	23±1
				25	12	1	22.6	23±1
				25	24	1	22.5	23±1
				50	0	1	22.48	23±1
			16QAM	1	0	1	22.36	21.5±1
				1	24	1	22.3	21.5±1
				1	49	1	22.37	21.5±1
				25	0	2	21.23	21.5±1
				25	12	2	21.29	21.5±1
				25	24	2	21.24	21.5±1
50				0	2	21.46	21.5±1	
20350	1750.0	QPSK	1	0	0	23.53	23±1	
			1	24	0	23.62	23±1	
			1	49	0	23.63	23±1	
			25	0	1	22.47	23±1	
			25	12	1	22.51	23±1	
			25	24	1	22.42	23±1	
			50	0	1	22.45	23±1	
		16QAM	1	0	1	22.44	21.8±1	
			1	24	1	22.49	21.8±1	
			1	49	1	22.42	21.8±1	
			25	0	2	21.23	21.8±1	
			25	12	2	21.15	21.8±1	
			25	24	2	21.15	21.8±1	
			50	0	2	21.44	21.8±1	

BW (MHz)	Ch	Freq. (MHz)	Mode	UL RB Allocation	UL RB Offset	MPR	Average power (dBm)	Tune up Power tolerant
5MHz	20000	1715.0	QPSK	1	0	0	23.6	23±1
				1	12	0	23.54	23±1
				1	24	0	23.67	23±1
				12	0	1	22.57	23±1
				12	6	1	22.48	23±1
				12	11	1	22.5	23±1
			25	0	1	22.5	23±1	
			16QAM	1	0	1	22.49	21.8±1
				1	12	1	22.58	21.8±1
				1	24	1	22.48	21.8±1
				12	0	2	21.58	21.8±1
				12	6	2	21.64	21.8±1
	12	11		2	21.63	21.8±1		
	25	0	2	21.58	21.8±1			
	20175	1732.5	QPSK	1	0	0	23.67	23±1
				1	12	0	23.64	23±1
				1	24	0	23.58	23±1
				12	0	1	22.55	23±1
				12	6	1	22.64	23±1
				12	11	1	22.57	23±1
			25	0	1	22.47	23±1	
			16QAM	1	0	1	22.58	21.8±1
				1	12	1	22.56	21.8±1
				1	24	1	22.6	21.8±1
12				0	2	21.28	21.8±1	
12				6	2	21.29	21.8±1	
12	11	2		21.28	21.8±1			
25	0	2	21.45	21.8±1				
20350	1750.0	QPSK	1	0	0	23.53	23±1	
			1	12	0	23.46	23±1	
			1	24	0	23.47	23±1	
			12	0	1	22.54	23±1	
			12	6	1	22.55	23±1	
			12	11	1	22.49	23±1	
		25	0	1	22.5	23±1		
		16QAM	1	0	1	22.73	23±1	
			1	12	1	22.81	23±1	
			1	24	1	22.68	23±1	
			12	0	2	21.61	23±1	
			12	6	2	21.56	23±1	
12	11		2	21.56	23±1			
25	0	2	21.43	23±1				



BW (MHz)	Ch	Freq. (MHz)	Mode	UL RB Allocation	UL RB Offset	MPR	Average power (dBm)	Tune up Power tolerant
3MHz	19965	1711.5	QPSK	1	0	0	23.41	23±1
				1	7	0	23.5	23±1
				1	14	0	23.49	23±1
				8	0	1	22.54	23±1
				8	4	1	22.6	23±1
				8	7	1	22.62	23±1
				15	0	1	22.52	23±1
			16QAM	1	0	1	22.93	22.3±1
				1	7	1	22.95	22.3±1
				1	14	1	22.84	22.3±1
				8	0	2	21.49	22.3±1
				8	4	2	21.52	22.3±1
				8	7	2	21.47	22.3±1
				15	0	2	21.56	22.3±1
	20175	1732.5	QPSK	1	0	0	23.48	23±1
				1	7	0	23.54	23±1
				1	14	0	23.57	23±1
				8	0	1	22.47	23±1
				8	4	1	22.52	23±1
				8	7	1	22.37	23±1
				15	0	1	22.45	23±1
			16QAM	1	0	1	22.29	21.8±1
				1	7	1	22.25	21.8±1
				1	14	1	22.35	21.8±1
				8	0	2	21.42	21.8±1
				8	4	2	21.33	21.8±1
				8	7	2	21.42	21.8±1
				15	0	2	21.39	21.8±1
	20385	1753.5	QPSK	1	0	0	23.5	23±1
				1	7	0	23.54	23±1
1				14	0	23.5	23±1	
8				0	1	22.46	23±1	
8				4	1	22.41	23±1	
8				7	1	22.52	23±1	
15				0	1	22.47	23±1	
16QAM			1	0	1	22.43	22±1	
			1	7	1	22.47	22±1	
			1	14	1	22.48	22±1	
			8	0	2	21.29	22±1	
			8	4	2	21.27	22±1	
			8	7	2	21.32	22±1	
			15	0	2	21.45	22±1	

BW (MHz)	Ch	Freq. (MHz)	Mode	UL RB Allocation	UL RB Offset	MPR	Average power (dBm)	Tune up Power tolerant
1.4MHz	19957	1710.7	QPSK	1	0	0	23.56	23±1
				1	2	0	23.52	23±1
				1	5	0	23.62	23±1
				3	0	0	23.58	23±1
				3	1	0	23.5	23±1
				3	2	0	23.58	23±1
			6	0	1	22.55	23±1	
			16QAM	1	0	1	22.36	21.8±1
				1	2	1	22.4	21.8±1
				1	5	1	22.38	21.8±1
				3	0	1	21.18	21.8±1
				3	1	1	21.18	21.8±1
	3	2		1	21.13	21.8±1		
	20175	1732.5	QPSK	1	0	0	23.39	23±1
				1	2	0	23.34	23±1
				1	5	0	23.48	23±1
				3	0	0	23.49	23±1
				3	1	0	23.54	23±1
				3	2	0	23.43	23±1
			6	0	1	22.46	23±1	
			16QAM	1	0	1	22.05	22±1
				1	2	1	22.12	22±1
				1	5	1	22.06	22±1
				3	0	1	21.19	22±1
				3	1	1	21.16	22±1
	3	2		1	21.24	22±1		
	20393	1754.3	QPSK	1	0	0	23.48	23±1
				1	2	0	23.5	23±1
				1	5	0	23.42	23±1
				3	0	0	23.48	23±1
3				1	0	23.45	23±1	
3				2	0	23.45	23±1	
6			0	1	22.47	23±1		
16QAM			1	0	1	22.41	21.5±1	
			1	2	1	22.35	21.5±1	
			1	5	1	22.46	21.5±1	
			3	0	1	21.04	21.5±1	
			3	1	1	20.95	21.5±1	
	3	2	1	21.11	21.5±1			
6	0	2	21.29	21.5±1				

**LTE Band VII:**

BW (MHz)	Ch	Freq. (MHz)	Mode	UL RB Allocation	UL RB Offset	MPR	Average power (dBm)	Tune up Power tolerant
20MHz	20850	2510	QPSK	1	0	0	22.51	22±1
				1	49	0	22.42	22±1
				1	99	0	22.5	22±1
				50	0	1	21.56	22±1
				50	24	1	21.5	22±1
				50	49	1	21.58	22±1
				100	0	1	21.52	22±1
			16QAM	1	0	1	21.74	21.1±1
				1	49	1	21.81	21.1±1
				1	99	1	21.65	21.1±1
				50	0	2	20.49	21.1±1
				50	24	2	20.44	21.1±1
				50	49	2	20.58	21.1±1
				100	0	2	20.53	21.1±1
	21100	2535	QPSK	1	0	0	22.45	21.9±1
				1	49	0	22.51	21.9±1
				1	99	0	22.38	21.9±1
				50	0	1	21.45	21.9±1
				50	24	1	21.37	21.9±1
				50	49	1	21.37	21.9±1
				100	0	1	21.44	21.9±1
			16QAM	1	0	1	21.87	21.1±1
				1	49	1	21.87	21.1±1
				1	99	1	21.8	21.1±1
				50	0	2	20.4	21.1±1
				50	24	2	20.46	21.1±1
				50	49	2	20.46	21.1±1
				100	0	2	20.46	21.1±1
	21350	2560	QPSK	1	0	0	22.53	22±1
				1	49	0	22.6	22±1
1				99	0	22.55	22±1	
50				0	1	21.46	22±1	
50				24	1	21.46	22±1	
50				49	1	21.54	22±1	
100				0	1	21.45	22±1	
16QAM			1	0	1	21.43	21.3±1	
			1	49	1	21.45	21.3±1	
			1	99	1	21.47	21.3±1	
			50	0	2	20.48	21.3±1	
			50	24	2	20.4	21.3±1	
			50	49	2	20.55	21.3±1	
			100	0	2	20.41	21.3±1	

BW (MHz)	Ch	Freq. (MHz)	Mode	UL RB Allocation	UL RB Offset	MPR	Average power (dBm)	Tune up Power tolerant
15MHz	20825	1717.5	QPSK	1	0	0	22.54	22.1±1
				1	37	0	22.59	22.1±1
				1	74	0	22.59	22.1±1
				36	0	1	21.64	22.1±1
				36	16	1	21.64	22.1±1
				36	35	1	21.67	22.1±1
				75	0	1	21.63	22.1±1
			16QAM	1	0	1	22.04	21.3±1
				1	37	1	22.01	21.3±1
				1	74	1	21.97	21.3±1
				36	0	2	20.65	21.3±1
				36	16	2	20.6	21.3±1
				36	35	2	20.72	21.3±1
				75	0	2	20.61	21.3±1
	21100	1732.5	QPSK	1	0	0	22.49	22±1
				1	37	0	22.43	22±1
				1	74	0	22.53	22±1
				36	0	1	21.48	22±1
				36	16	1	21.46	22±1
				36	35	1	21.52	22±1
				75	0	1	21.47	22±1
			16QAM	1	0	1	21.27	21.3±1
				1	37	1	21.35	21.3±1
				1	74	1	21.33	21.3±1
				36	0	2	20.46	21.3±1
				36	16	2	20.37	21.3±1
				36	35	2	20.41	21.3±1
75				0	2	20.49	21.3±1	
21375	1747.5	QPSK	1	0	0	22.47	22±1	
			1	37	0	22.54	22±1	
			1	74	0	22.44	22±1	
			36	0	1	21.54	22±1	
			36	16	1	21.55	22±1	
			36	35	1	21.53	22±1	
			75	0	1	21.59	22±1	
		16QAM	1	0	1	21.64	21.3±1	
			1	37	1	21.61	21.3±1	
			1	74	1	21.7	21.3±1	
			36	0	2	20.63	21.3±1	
			36	16	2	20.56	21.3±1	
			36	35	2	20.63	21.3±1	
			75	0	2	20.52	21.3±1	

BW (MHz)	Ch	Freq. (MHz)	Mode	UL RB Allocation	UL RB Offset	MPR	Average power (dBm)	Tune up Power tolerant
10MHz	20800	2502	QPSK	1	0	0	22.52	22±1
				1	24	0	22.48	22±1
				1	49	0	22.57	22±1
				25	0	1	21.54	22±1
				25	12	1	21.62	22±1
				25	24	1	21.48	22±1
				50	0	1	21.56	22±1
			16QAM	1	0	1	22	21.3±1
				1	24	1	21.91	21.3±1
				1	49	1	22.01	21.3±1
				25	0	2	20.55	21.3±1
				25	12	2	20.59	21.3±1
				25	24	2	20.61	21.3±1
				50	0	2	20.54	21.3±1
	21100	2535	QPSK	1	0	0	22.5	21.9±1
				1	24	0	22.49	21.9±1
				1	49	0	22.48	21.9±1
				25	0	1	21.43	21.9±1
				25	12	1	21.34	21.9±1
				25	24	1	21.35	21.9±1
				50	0	1	21.45	21.9±1
			16QAM	1	0	1	21.28	21.3±1
				1	24	1	21.2	21.3±1
				1	49	1	21.34	21.3±1
				25	0	2	20.63	21.3±1
				25	12	2	20.64	21.3±1
				25	24	2	20.65	21.3±1
				50	0	2	20.43	21.3±1
	21400	2565	QPSK	1	0	0	22.53	22±1
				1	24	0	22.51	22±1
1				49	0	22.54	22±1	
25				0	1	21.46	22±1	
25				12	1	21.53	22±1	
25				24	1	21.49	22±1	
50				0	1	21.49	22±1	
16QAM			1	0	1	21.41	21.3±1	
			1	24	1	21.43	21.3±1	
			1	49	1	21.44	21.3±1	
			25	0	2	20.57	21.3±1	
			25	12	2	20.55	21.3±1	
			25	24	2	20.49	21.3±1	
			50	0	2	20.47	21.3±1	

BW (MHz)	Ch	Freq. (MHz)	Mode	UL RB Allocation	UL RB Offset	MPR	Average power (dBm)	Tune up Power tolerant
5MHz	19975	1712.5	QPSK	1	0	0	22.62	22.1±1
				1	12	0	22.57	22.1±1
				1	24	0	22.58	22.1±1
				12	0	1	21.57	22.1±1
				12	6	1	21.53	22.1±1
				12	11	1	21.52	22.1±1
			25	0	1	21.51	22.1±1	
			16QAM	1	0	1	21.51	21.3±1
			1	12	1	21.48	21.3±1	
			1	24	1	21.53	21.3±1	
			12	0	2	20.69	21.3±1	
			12	6	2	20.75	21.3±1	
	12	11	2	20.78	21.3±1			
	25	0	2	20.6	21.3±1			
	20175	1732.5	QPSK	1	0	0	22.54	22±1
	1			12	0	22.63	22±1	
	1			24	0	22.46	22±1	
	12			0	1	21.48	22±1	
	12			6	1	21.48	22±1	
	12			11	1	21.48	22±1	
	25		0	1	21.43	22±1		
	16QAM		1	0	1	21.48	21.3±1	
	1		12	1	21.5	21.3±1		
	1		24	1	21.45	21.3±1		
	12		0	2	20.56	21.3±1		
	12		6	2	20.5	21.3±1		
	12	11	2	20.55	21.3±1			
25	0	2	20.42	21.3±1				
20375	1752.5	QPSK	1	0	0	22.61	22±1	
1			12	0	22.64	22±1		
1			24	0	22.67	22±1		
12			0	1	21.5	22±1		
12			6	1	21.41	22±1		
12			11	1	21.56	22±1		
25		0	1	21.42	22±1			
16QAM		1	0	1	21.51	21.3±1		
1		12	1	21.41	21.3±1			
1		24	1	21.6	21.3±1			
12		0	2	20.74	21.3±1			
12		6	2	20.75	21.3±1			
12	11	2	20.76	21.3±1				
25	0	2	20.44	21.3±1				

**LTE Band XIII:**

BW (MHz)	Ch	Freq. (MHz)	Mode	UL RB Allocation	UL RB Offset	MPR	Average power (dBm)	Tune up Power tolerant
10MHz	23230	782	QPSK	1	0	0	23.14	22.8±1
				1	24	0	23.12	22.8±1
				1	49	0	23.09	22.8±1
				25	0	1	22.26	22.8±1
				25	12	1	22.2	22.8±1
				25	24	1	22.28	22.8±1
				50	0	1	22.28	22.8±1
			16QAM	1	0	1	22.87	22±1
				1	24	1	22.94	22±1
				1	49	1	22.93	22±1
				25	0	2	21.09	22±1
				25	12	2	21.02	22±1
				25	24	2	21.18	22±1
				50	0	2	21.34	22±1

BW (MHz)	Ch	Freq. (MHz)	Mode	UL RB Allocation	UL RB Offset	MPR	Average power (dBm)	Tune up Power tolerant
5MHz	23755	706.5	QPSK	1	0	0	23.38	22.8±1
				1	12	0	23.36	22.8±1
				1	24	0	23.3	22.8±1
				12	0	1	22.33	22.8±1
				12	6	1	22.29	22.8±1
				12	11	1	22.33	22.8±1
			25	0	1	22.26	22.8±1	
			1	0	1	22.42	21.8±1	
			1	12	1	22.5	21.8±1	
			1	24	1	22.44	21.8±1	
			12	0	2	21.13	21.8±1	
			12	6	2	21.17	21.8±1	
	12	11	2	21.08	21.8±1			
	25	0	2	21.31	21.8±1			
	1	0	0	23.25	22.8±1			
	1	12	0	23.33	22.8±1			
	1	24	0	23.33	22.8±1			
	12	0	1	22.3	22.8±1			
	12	6	1	22.39	22.8±1			
	12	11	1	22.29	22.8±1			
	25	0	1	22.26	22.8±1			
	1	0	1	22.21	21.8±1			
	1	12	1	22.16	21.8±1			
	1	24	1	22.14	21.8±1			
	12	0	2	21.39	21.8±1			
	12	6	2	21.44	21.8±1			
	12	11	2	21.4	21.8±1			
25	0	2	21.41	21.8±1				
1	0	0	23.19	22.8±1				
1	12	0	23.25	22.8±1				
1	24	0	23.26	22.8±1				
12	0	1	22.3	22.8±1				
12	6	1	22.35	22.8±1				
12	11	1	22.3	22.8±1				
25	0	1	22.26	22.8±1				
1	0	1	22.61	21.8±1				
1	12	1	22.55	21.8±1				
1	24	1	22.62	21.8±1				
12	0	2	21.02	21.8±1				
12	6	2	21.01	21.8±1				
12	11	2	21.05	21.8±1				
25	0	2	21.28	21.8±1				



### WIFI Mode (2.4G)

Mode	Channel number	Frequency (MHz)	Data rate(Mbps)	Average Output Power(dBm)	Average Tune up limited(dBm)
802.11b	1	2412	1	11.53	12 ± 1
	6	2437	1	11.27	12 ± 1
	11	2462	1	12.40	12 ± 1
802.11g	1	2412	6	7.11	8 ± 1
	6	2437	6	8.81	8 ± 1
	11	2462	6	8.68	8 ± 1
802.11n(HT20)	1	2412	MCS0	7.11	8 ± 1
	6	2437	MCS0	8.95	8 ± 1
	11	2462	MCS0	8.58	8 ± 1
802.11n(HT40)	3	2422	MCS0	10.60	11 ± 1
	6	2437	MCS0	10.56	11 ± 1
	9	2452	MCS0	11.12	11 ± 1

### Bluetooth Measurement Result

Mode	Frequency (MHz)	Output Power(dBm)	Tune up limited(dBm)
GFSK	2402	0.224	1.1 ± 1
	2441	0.506	1.1 ± 1
	2480	2.030	1.1 ± 1
$\pi/4$ DQPSK	2402	-0.551	0 ± 1
	2441	-0.128	0 ± 1
	2480	1.345	1 ± 1
8DPSK	2402	-0.446	0 ± 1
	2441	-0.061	0 ± 1
	2480	1.457	1 ± 1

### BLE Measurement Result

Channel number	Frequency (MHz)	Output Power(dBm)	Tune up limited(dBm)
0	2402	0.066	1 ± 1
19	2440	0.677	1 ± 1
39	2480	2.059	2 ± 1

**Note:** 1. Both WIFI and BT power was test and only Maximum Power was provide here.

2. SAR Test Exclusion Threshold for WIFI&BT is about 9.6mW, the maximum tune up power of WIFI is 13dBm=19.95mW, BT is 3dBm=2mW, WIFI SAR is required.

### Antenna Separation Information:

EUT antenna location:

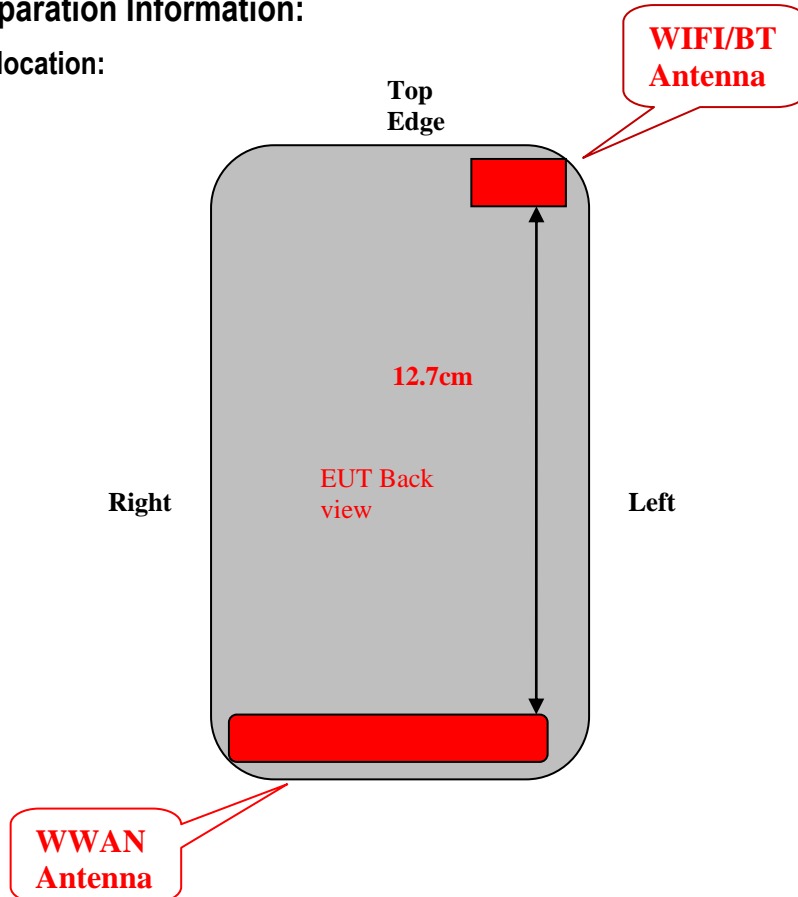

### Test position consideration:

Distance of EUT antenna-to-edge/surface(mm), Test distance: 10mm						
Antennas	Back side	Front side	Left Edge	Right Edge	Top Edge	Bottom Edge
WWAN	2	2	6	2	137	2
WLAN	2	2	2	48	2	133
Bluetooth	2	2	2	48	2	133

Test distance:10mm						
Antennas	Back side	Front side	Left Edge	Right Edge	Top Edge	Bottom Edge
WWAN	YES	YES	YES	YES	NO	YES
WLAN	YES	YES	YES	NO	YES	NO
Bluetooth	NO	NO	NO	NO	NO	NO

Note:

1. Head/Body-worn/Hotspot mode SAR assessments are required.
2. Referring to KDB 941225 D06v02, when the overall device length and width are  $\geq 9\text{cm} * 5\text{cm}$ , the test distance is 10mm. SAR must be measured for all sides and surfaces with a transmitting antenna located within 25mm from that surface or edge.
3. Per KDB 447498 D01v05r02, for handsets the test separation distance is determined by the smallest distance between the outer surface of the device and the user, which is 0 mm for head SAR, 10 mm for hotspot SAR, and 10 mm for body-worn SAR.
4. BT SAR is not required due to the low power.

## 10 SAR TEST RESULTS

### Test Condition:

1.	SAR Measurement The distance between the EUT and the antenna of the emulator is more than 50 cm and the output power radiated from the emulator antenna is at least 30 dB less than the output power of EUT.		
2	Measurement Uncertainty: See page 37 for detail		
3	Environmental Conditions	Temperature	23°C
		Relative Humidity	53%
		Atmospheric Pressure	1019mbar
4	Test Date : Jun 23, 2017 to Jul 5, 2017 Tested By : York Liu		

### Generally Test Procedures:

1. Establish communication link between EUT and base station emulation by air link.
2. Place the EUT in the selected test position. (Cheek, tilt or flat)
3. Perform SAR testing at middle or highest output power channel under the selected test mode. If the measured 1-g SAR is  $\leq 0.8$  W/kg, then testing for the other channel will not be performed.
4. When SAR is  $< 0.8$  W/kg, no repeated SAR measurement is required

### For WCDMA test:

1. KDB941225 D01-Body SAR is not required for HSDPA when the average output of each RF channel with HSDPA active is less than 0.25dB higher than measured without HSDPA using 12.2kbps RMC or the maximum SAR for 12.2kbps RMC  $< 75\%$  of the SAR limit.
2. KDB941225 D01-Body SAR is not required for handset with HSPA capabilities when the maximum average output of each RF channel with HSUPA/HSDPA active is less than 0.25dB higher than that measure without HSUPA/HSDPA using 12.2kbps RMC or the maximum SAR for 12.2kbps RMC is  $< 75\%$  of the SAR limit

### For LTE test:

1. According to FCC KDB 941225 D05v02r01:
  - a. Per Section 5.2.1, SAR is required for QPSK 1 RB Allocation for the largest bandwidth
    - i. The required channel and offset combination with the highest maximum output power is required for SAR.
    - ii. When the reported SAR is  $\leq 0.8$  W/kg, testing of the remaining RB offset configurations and required test channels is not required. Otherwise, SAR is required for the remaining required test channels using the RB offset configuration with highest output power for that channel.
    - iii. When the reported SAR for a required test channel is  $> 1.45$  W/kg, SAR is required for all RB offset configurations for that channel.
  - b. Per Section 5.2.2, SAR is required for 50% RB allocation using the largest bandwidth following the same procedures outlined in Section 5.2.1.
  - c. Per Section 5.2.3, QPSK SAR is not required for the 100% allocation when the highest maximum output power for the 100% allocation is less than the highest maximum output power of the 1 RB and 50% RB allocations and the reported SAR for the 1 RB and 50% RB allocations is  $< 0.8$  W/kg.
  - d. Per Section 5.2.4 and 5.3, SAR tests for higher order modulations and lower bandwidths configurations are not required when the conducted power of the required test configurations determined by Sections 5.2.1 through 5.2.3 is less than or equal to  $\frac{1}{2}$  dB higher than the equivalent configuration using QPSK modulation and when the QPSK SAR for those configurations is  $< 1.45$  W/kg.

### SAR Summary Test Result:

#### GSM850

Date of Measured : Jun 26,2017			Body-worn /Hotspot Separation Distance:1.0cm					
Position	Channel	Mode	SAR 1g(W/kg)	Limit (W/kg)	Power Drift (%)	Maximum Turn-up Power(dBm)	measured output power (dBm)	Scaled Maximum SAR(W/kg)
Right Head Cheek	Mid	GSM voice	0.337	1.6	0.28	33	32.07	0.42
Right Head Tilt	Mid	GSM voice	0.241	1.6	-0.12	33	32.07	0.30
Left Head Cheek	Mid	GSM voice	0.352	1.6	-0.93	33	32.07	0.44
Left Head Tilt	Mid	GSM voice	0.265	1.6	-0.16	33	32.07	0.33
Body Front-side	Mid	EGPRS Class12	0.739	1.6	-0.74	29	28.07	0.92
Body Back-side	Low	EGPRS Class12	0.876	1.6	0.98	29	28.06	1.09
Body Back-side	Mid	EGPRS Class12	0.936	1.6	0.98	29	28.07	1.16
Body Back-side	Mid	EGPRS Class12	0.918	1.6	0.36	29	28.07	1.14
Body Back-side	High	EGPRS Class12	0.889	1.6	-0.51	29	28.11	1.09
Body Left-edge	Mid	EGPRS Class12	0.322	1.6	-0.84	29	28.07	0.40
Body Right-edge	Mid	EGPRS Class12	0.242	1.6	-1.78	29	28.07	0.30
Body Bottom-edge	Mid	EGPRS Class12	0.149	1.6	1.01	29	28.07	0.18

#### WCDMA BAND V (850)

Date of Measured : Jun 26,2017			Body-worn /Hotspot Separation Distance: 1.0cm					
Position	Channel	Mode	SAR 1g(W/kg)	Limit (W/kg)	Power Drift (%)	Maximum Turn-up Power(dBm)	measured output power (dBm)	Scaled Maximum SAR(W/kg)
Right Head Cheek	Mid	RMC 12.2kbps	0.203	1.6	0.57	23	22.18	0.25
Right Head Tilt	Mid	RMC 12.2kbps	0.139	1.6	0.52	23	22.18	0.17
Left Head Cheek	Mid	RMC 12.2kbps	0.211	1.6	0.54	23	22.18	0.25
Left Head Tilt	Mid	RMC 12.2kbps	0.151	1.6	-2.15	23	22.18	0.18
Body Front-side	Mid	RMC 12.2kbps	0.283	1.6	-0.99	23	22.18	0.34
Body Back-side	Mid	RMC 12.2kbps	0.336	1.6	-0.11	23	22.18	0.41
Body Left-edge	Mid	RMC 12.2kbps	0.252	1.6	-2.55	23	22.18	0.30
Body Right-edge	Mid	RMC 12.2kbps	0.161	1.6	0.72	23	22.18	0.19
Body Bottom-edge	Mid	RMC 12.2kbps	0.080	1.6	-1.50	23	22.18	0.10

**PCS1900:**

Date of Measured : Jun 30,2017			Body-worn /Hotspot Separation Distance: 1.0cm					
Position	Channel	Mode	SAR 1g(W/kg)	Limit (W/kg)	Power Drift (%)	Maximum Turn-up Power(dBm)	measured output power (dBm)	Scaled Maximum SAR(W/kg)
Right Head Cheek	Mid	GSM voice	0.289	1.6	1.12	31	30.23	0.35
Right Head Tilt	Mid	GSM voice	0.168	1.6	0.13	31	30.23	0.20
Left Head Cheek	Mid	GSM voice	0.309	1.6	1.60	31	30.23	0.37
Left Head Tilt	Mid	GSM voice	0.248	1.6	1.11	31	30.23	0.30
Body Front-side	Mid	EGPRS Class12	0.612	1.6	-0.03	26	25.9	0.63
Body Back-side	Mid	EGPRS Class12	0.454	1.6	2.18	26	25.9	0.46
Body Left-edge	Mid	EGPRS Class12	0.280	1.6	-1.22	26	25.9	0.29
Body Right-edge	Mid	EGPRS Class12	0.286	1.6	1.25	26	25.9	0.29
Body Bottom-edge	Mid	EGPRS Class12	0.210	1.6	0.13	26	25.9	0.21

**WCDMA BAND II (1900):**

Date of Measured : Jun 30,2017			Body-worn /Hotspot Separation Distance:1.0cm					
Position	Channel	Mode	SAR 1g(W/kg)	Limit (W/kg)	Power Drift (%)	Maximum Turn-up Power(dBm)	measured output power (dBm)	Scaled Maximum SAR(W/kg)
Right Head Cheek	Mid	RMC 12.2kbps	0.321	1.6	0.57	23	22.94	0.33
Right Head Tilt	Mid	RMC 12.2kbps	0.238	1.6	0.14	23	22.94	0.24
Left Head Cheek	Mid	RMC 12.2kbps	0.401	1.6	-0.21	23	22.94	0.41
Left Head Tilt	Mid	RMC 12.2kbps	0.331	1.6	0.25	23	22.94	0.34
Body Front-side	Mid	RMC 12.2kbps	0.706	1.6	-0.82	23	22.94	0.72
Body Back-side	Mid	RMC 12.2kbps	0.564	1.6	-0.89	23	22.94	0.57
Body Left-edge	Mid	RMC 12.2kbps	0.218	1.6	0.23	23	22.94	0.22
Body Right-edge	Mid	RMC 12.2kbps	0.234	1.6	0.75	23	22.94	0.24
Body Bottom-edge	Mid	RMC 12.2kbps	0.149	1.6	1.04	23	22.94	0.15

**LTE Band 13 (700):**

Date of Measured : Jun 23,2017						Body-worn/Hotspot Separation Distance: 1.0cm				
Position	Channel	Bandwidth (MHz)	MPR (dB)	RB Size	RB Offset	SAR 1g(W/kg)	Power Drift (%)	Maximum Turn-up Power (dBm)	measured output power (dBm)	Scaled Maximum SAR(W/kg)
Right Head Cheek	Mid	10	0	1	24	0.112	1.76	23.8	23.12	0.13
Right Head Cheek	Mid	10	1	25	12	0.100	-1.13	23.8	22.2	0.14
Right Head Tilt	Mid	10	0	1	24	0.077	-1.31	23.8	23.12	0.09
Right Head Tilt	Mid	10	1	25	12	0.072	1.76	23.8	22.2	0.10
Left Head Cheek	Mid	10	0	1	24	0.106	-2.27	23.8	23.12	0.12
Left Head Cheek	Mid	10	1	25	12	0.102	1.18	23.8	22.2	0.15
Left Head Tilt	Mid	10	0	1	24	0.059	-0.36	23.8	23.12	0.07
Left Head Tilt	Mid	10	1	25	12	0.054	1.28	23.8	22.2	0.08
Body-worn LCD up	Mid	10	0	1	24	0.149	-0.65	23.8	23.12	0.17
Body-worn LCD up	Mid	10	1	25	12	0.104	0.16	23.8	22.2	0.15
Body-worn LCD Down	Mid	10	0	1	24	0.236	0.20	23.8	23.12	0.28
Body-worn LCD Down	Mid	10	1	25	12	0.231	1.48	23.8	22.2	0.33
Body Left EDGE	Mid	10	0	1	24	0.124	0.46	23.8	23.12	0.15
Body Left EDGE	Mid	10	1	25	12	0.119	0.32	23.8	22.2	0.17
Body Right EDGE	Mid	10	0	1	24	0.114	0.18	23.8	23.12	0.13
Body Right EDGE	Mid	10	1	25	12	0.107	2.36	23.8	22.2	0.15
Body Bottom EDGE	Mid	10	0	1	24	0.117	-1.47	23.8	23.12	0.14
Body Bottom EDGE	Mid	10	1	25	12	0.090	-1.02	23.8	22.2	0.13
Modulation: QPSK						Limit: 1.6W/kg averaged over 1gram				

**LTE Band 7 (2600):**

Date of Measured : Jul 5,2017						Body-worn/Hotspot Separation Distance: 1.0cm				
Position	Channel	Bandwidth (MHz)	MPR (dB)	RB Size	RB Offset	SAR 1g(W/kg)	Power Drift (%)	Maximum Turn-up Power (dBm)	measured output power (dBm)	Scaled Maximum SAR(W/kg)
Right Head Cheek	Mid	20	0	1	49	0.324	-0.28	22.9	22.51	0.35
Right Head Cheek	Mid	20	1	50	24	0.302	-1.02	22.9	21.37	0.43
Right Head Tilt	Mid	20	0	1	49	0.268	1.92	22.9	22.51	0.29
Right Head Tilt	Mid	20	1	50	24	0.251	0.69	22.9	21.37	0.36
Left Head Cheek	Mid	20	0	1	49	0.355	0.99	22.9	22.51	0.39
Left Head Cheek	Mid	20	1	50	24	0.344	0.51	22.9	21.37	0.49
Left Head Tilt	Mid	20	0	1	49	0.295	-0.71	22.9	22.51	0.32
Left Head Tilt	Mid	20	1	50	24	0.282	-0.27	22.9	21.37	0.40
Body-worn LCD up	Mid	20	0	1	49	0.481	-1.69	22.9	22.51	0.53
Body-worn LCD up	Mid	20	1	50	24	0.479	1.76	22.9	21.37	0.68
Body-worn LCD Down	Mid	20	0	1	49	0.647	0.15	22.9	22.51	0.71
Body-worn LCD Down	Mid	20	1	50	24	0.602	1.23	22.9	21.37	0.86
Body Left EDGE	Mid	20	0	1	49	0.330	0.26	22.9	22.51	0.36
Body Left EDGE	Mid	20	1	50	24	0.326	-0.36	22.9	21.37	0.46
Body Right EDGE	Mid	20	0	1	49	0.212	0.20	22.9	22.51	0.23
Body Right EDGE	Mid	20	1	50	24	0.209	0.28	22.9	21.37	0.30
Body Bottom EDGE	Mid	20	0	1	49	0.299	0.31	22.9	22.51	0.33
Body Bottom EDGE	Mid	20	1	50	24	0.229	-2.10	22.9	21.37	0.33
Modulation: QPSK						Limit: 1.6W/kg averaged over 1gram				

**LTE Band 4 (1700):**

Date of Measured : Jun 28,2017						Body-worn/Hotspot Separation Distance: 1.0cm				
Position	Channel	Bandwidth (MHz)	MPR (dB)	RB Size	RB Offset	SAR 1g(W/kg)	Power Drift (%)	Maximum Turn-up Power (dBm)	measured output power (dBm)	Scaled Maximum SAR(W/kg)
Right Head Cheek	Mid	20	0	1	49	0.296	0.20	24	23.52	0.33
Right Head Cheek	Mid	20	1	50	24	0.231	-0.42	24	22.44	0.33
Right Head Tilt	Mid	20	0	1	49	0.122	-2.62	24	23.52	0.14
Right Head Tilt	Mid	20	1	50	24	0.114	-0.45	24	22.44	0.16
Left Head Cheek	Mid	20	0	1	49	0.288	-0.05	24	23.52	0.32
Left Head Cheek	Mid	20	1	50	24	0.261	-0.27	24	22.44	0.37
Left Head Tilt	Mid	20	0	1	49	0.145	1.27	24	23.52	0.16
Left Head Tilt	Mid	20	1	50	24	0.138	-0.44	24	22.44	0.20
Body-worn LCD up	Mid	20	0	1	49	0.765	-0.07	24	23.52	0.85
Body-worn LCD up	Mid	20	1	50	24	0.715	0.09	24	22.44	1.02
Body-worn LCD Down	Mid	20	0	1	49	0.591	-0.37	24	23.52	0.66
Body-worn LCD Down	Mid	20	1	50	24	0.516	0.34	24	22.44	0.74
Body Left EDGE	Mid	20	0	1	49	0.158	0.24	24	23.52	0.18
Body Left EDGE	Mid	20	1	50	24	0.112	-1.17	24	22.44	0.16
Body Right EDGE	Mid	20	0	1	49	0.289	-0.19	24	23.52	0.32
Body Right EDGE	Mid	20	1	50	24	0.225	-2.10	24	22.44	0.32
Body Bottom EDGE	Mid	20	0	1	49	0.571	-0.06	24	23.52	0.64
Body Bottom EDGE	Mid	20	1	50	24	0.506	1.17	24	22.44	0.72
Modulation: QPSK						Limit: 1.6W/kg averaged over 1gram				



**LTE Band 2 (1900):**

Date of Measured : Jun 30,2017						Body-worn/Hotspot Separation Distance: 1.0cm				
Position	Channel	Bandwidth (MHz)	MPR (dB)	RB Size	RB Offset	SAR 1g(W/kg)	Power Drift (%)	Maximum Turn-up Power (dBm)	measured output power (dBm)	Scaled Maximum SAR(W/kg)
Right Head Cheek	Mid	20	0	1	49	0.312	-0.07	24	23.6	0.34
Right Head Cheek	Mid	20	1	50	24	0.301	-0.53	24	22.29	0.45
Right Head Tilt	Mid	20	0	1	49	0.256	-1.71	24	23.6	0.28
Right Head Tilt	Mid	20	1	50	24	0.252	-0.55	24	22.29	0.37
Left Head Cheek	Mid	20	0	1	49	0.321	0.21	24	23.6	0.35
Left Head Cheek	Mid	20	1	50	24	0.312	-0.35	24	22.29	0.46
Left Head Tilt	Mid	20	0	1	49	0.235	-1.02	24	23.6	0.26
Left Head Tilt	Mid	20	1	50	24	0.221	-1.26	24	22.29	0.33
Body-worn LCD up	Mid	20	0	1	49	0.767	-0.19	24	23.6	0.84
Body-worn LCD up	Mid	20	1	50	24	0.721	0.29	24	22.29	1.07
Body-worn LCD Down	Mid	20	0	1	49	0.557	-1.24	24	23.6	0.61
Body-worn LCD Down	Mid	20	1	50	24	0.527	-1.41	24	22.29	0.78
Body Left EDGE	Mid	20	0	1	49	0.281	-2.16	24	23.6	0.31
Body Left EDGE	Mid	20	1	50	24	0.277	0.42	24	22.29	0.41
Body Right EDGE	Mid	20	0	1	49	0.363	0.01	24	23.6	0.40
Body Right EDGE	Mid	20	1	50	24	0.350	0.17	24	22.29	0.52
Body Bottom EDGE	Mid	20	0	1	49	0.285	-0.58	24	23.6	0.31
Body Bottom EDGE	Mid	20	1	50	24	0.264	-0.32	24	22.29	0.39
Modulation: QPSK						Limit: 1.6W/kg averaged over 1gram				

## 2.4 G (802.11b)

Date of Measured : Jul 3,2017			Body-worn/Hotspot Separation Distance: 1.0cm					
Position	Channel	Mode	SAR 1g(W/kg)	Limit (W/kg)	Power Drift (%)	Maximum Turn-up Power(dBm)	measured output power (dBm)	Scaled Maximum SAR(W/kg)
Right Head Cheek	Mid	802.11b	0.551	1.6	-0.04	13	11.27	0.82
Right Head Tilt	Mid	802.11b	0.442	1.6	0.36	13	11.27	0.66
Left Head Cheek	Mid	802.11b	0.432	1.6	-3.33	13	11.27	0.64
Left Head Tilt	Mid	802.11b	0.336	1.6	0.03	13	11.27	0.50
Body Front-side	Mid	802.11b	0.121	1.6	-1.44	13	11.27	0.18
Body Back-side	Mid	802.11b	0.281	1.6	-0.38	13	11.27	0.42
Body Left-edge	Mid	802.11b	0.124	1.6	0.21	13	11.27	0.18
Body Top-edge	Mid	802.11b	0.194	1.6	-0.54	13	11.27	0.29

### Measurement variability consideration

According to KDB 865664 D01v01 section 2.8.1, repeated measurements are required following the procedures as below:

1. Repeated measurement is not required when the original highest measured SAR is  $< 0.80\text{W/kg}$ ; steps 2) through 4) do not apply.
2. When the original highest measured SAR is  $\geq 0.80\text{ W/kg}$ , repeat that measurement once.
3. Perform a second repeated measurement only if the ratio of largest to smallest SAR for the original and first repeated measurements is  $> 1.20$  or when the original or repeated measurement is  $\geq 1.45\text{ W/kg}$  (~ 10% from the 1-g SAR limit).
4. Perform a third repeated measurement only if the original, first or second repeated measurement is  $\geq 1.5\text{ W/kg}$  and the ratio of largest to smallest SAR for the original, first and second repeated measurements is  $> 1.20$ .

Measured SAR (W/Kg)

### Repeated SAR:

Band	Position	Channel	Mode	measured SAR( W/kg)				
				Original	1st Repeated		2nd Repeated	
					Value	Ratio	Value	Ratio
GSM850	Body Back-side	Mid	EGPRS Class12	0.936	0.918	1.02	NA	NA

### Simultaneous Transmission SAR Analysis.

No.	Applicable Simultaneous Transmission Combination
1.	WWAN+BT
2.	WWAN+WIFI

Note:

1. For simultaneous transmission analysis, WiFi and Bluetooth SAR is estimated per KDB 447498 D01 v06 base on the formula below:

Test Report	17070523-FCC-H
Page	75 of 176

- $(\text{max. power of channel, including tune-up tolerance, mW}) / (\text{min. test separation distance, mm}) \cdot [\sqrt{f_{\text{GHz}}/x}]$  W/kg for test separation distances  $\leq 50$  mm;  
where  $x = 7.5$  for 1-g SAR, and  $x = 18.75$  for 10-g SAR.
  - 0.4 W/kg for 1-g SAR and 1.0 W/kg for 10-g SAR, when the test separation distances is  $> 50$  mm.<sup>21</sup>
2. If the test separation distances is  $\leq 5$ mm, 5mm is used for estimated SAR calculation.
  3. WIFI maximum tune up power is 13dBm, BT's maximum tune up power is 3dBm and the estimated SAR is listed below.

Test position	Head(0.5cm)	Body (1.0cm)
WIFI SAR(W/kg)	0.82	0.42
BT Estimated SAR(W/kg)	0.08	0.04

**Maximum Summation:**

	WWAN	WIFI	BT	WWAN+WIFI	WWAN+BT
position	Max. Scaled SAR	Max. Scaled SAR	Max. Scaled SAR		
Head 0cm	0.49	0.82	0.08	1.31	0.57
Body 1.0cm	1.16	0.42	0.04	1.58	1.20

Note: 1g-SAR scalar summation  $< 1.6$ W/kg, so no simultaneous SAR is required.

## **11 SAR MEASUREMENT REFERENCES**

### **References**

1. FCC 47 CFR Part 2 “Frequency Allocations and Radio Treaty Matters; General Rules and Regulations”
2. IEEE Std. C95.1-1999, “IEEE Standard for Safety Levels with Respect to Human Exposure to Radio Frequency Electromagnetic Fields, 3kHz to 300GHz”, 1999
3. IEEE Std. 1528-2013, “IEEE Recommended Practice for Determining the Peak Spatial-Average Specific Absorption Rate (SAR) in the Human Head from Wireless Communications Devices: Measurement Techniques”, June 2013
4. IEC 62209-2, “Human exposure to radio frequency fields from hand-held and body-mounted wireless communication devices—Human models, instrumentation, and procedures – Part 2: Procedure to determine the specific absorption rate(SAR) for wireless communication devices used in close proximity to the human body(frequency range of 30MHz to 6GHz)”, March 2010
5. FCC KDB 447498 D01 v06, “RF Exposure Procedures and Equipment Authorization Policies For Mobile and Portable Device”, October 23, 2015
6. FCC KDB 941225 D01 v03r01, “3G SAR Measurement Procedures”, October 23, 2015
7. FCC KDB 865664 D01 v01r04, “SAR Measurement Requirements For 100MHz to 6GHz”, August 7, 2015
8. FCC KDB648474 D04 v01r03, “SAR Evaluation Considerations for Wireless Handsets”. October 23, 2015
9. FCC KDB 941225 D06 v02r01, Hot Spot SAR ,October 23, 2015
10. FCC KDB 941225 D05 v02r04, “SAR Evaluation Considerations for LTE Devices”, October 23, 2015

### Maximum SAR measurement Plots

Test mode: GSM850, Middle channel (Left Head Cheek)

Product Description: LTE Mobile Phone

Model: M4 SS4453-R

Test Date: Jun 26,2017

Medium(liquid type)	HSL_835
Frequency (MHz)	836.6000
Relative permittivity (real part)	41.2
Conductivity (S/m)	0.91
E-Field Probe	SN 27/15 EPGO262
Crest factor	8.0
Conversion Factor	1.74
Sensor-Surface	4mm
Area Scan	dx=8mm dy=8mm
Zoom Scan	5x5x7,dx=8mm dy=8mm dz=5mm
Variation (%)	-0.930000
SAR 10g (W/Kg)	0.278739
SAR 1g (W/Kg)	0.352265
<b>SURFACE SAR</b>	<b>VOLUME SAR</b>

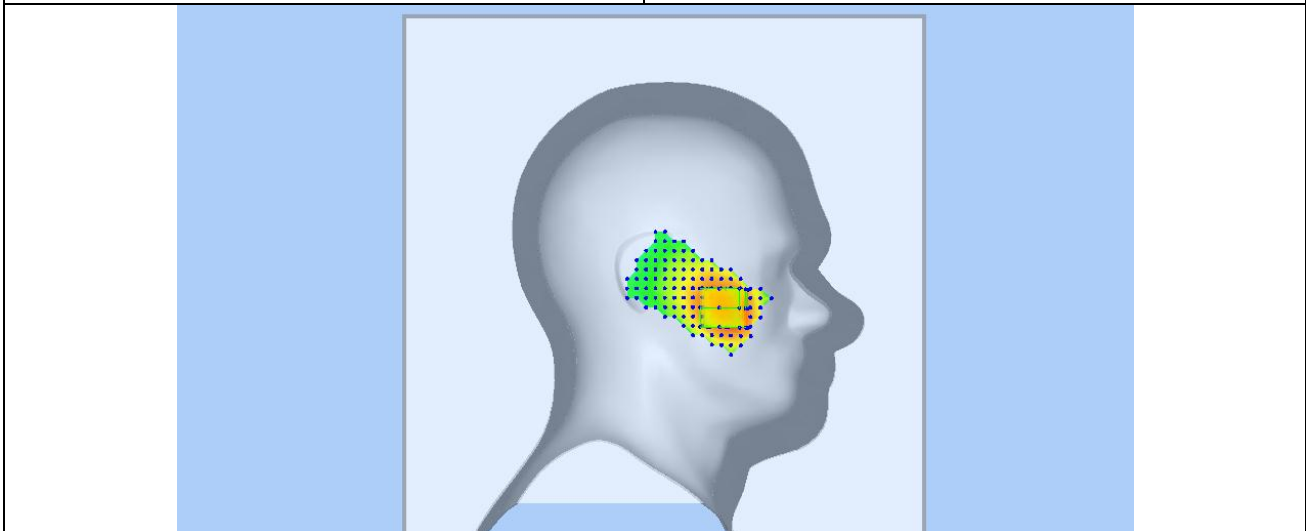
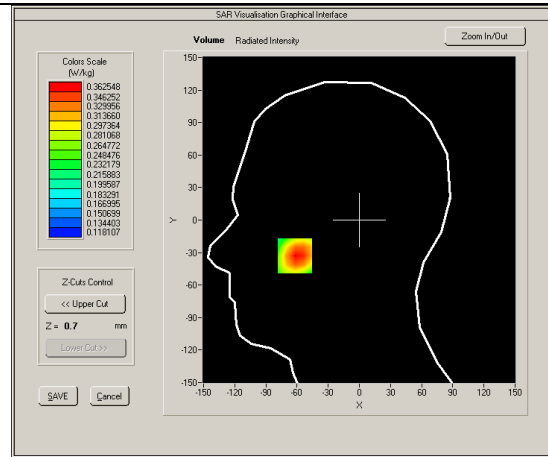
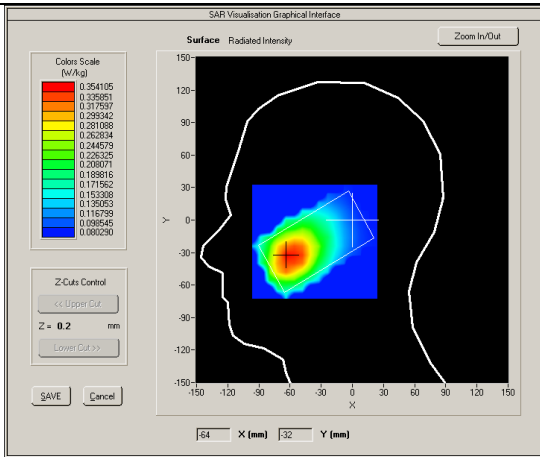

Test mode: GPRS850, Middle channel (Body Back Side)  
 Product Description: LTE Mobile Phone  
 Model: M4 SS4453-R  
 Test Date: Jun 26,2017

Medium(liquid type)	MSL_835
Frequency (MHz)	836.6000
Relative permittivity (real part)	55.17
Conductivity (S/m)	0.99
E-Field Probe	SN 27/15 EPGO262
Crest factor	2.0
Conversion Factor	1.81
Sensor-Surface	4mm
Area Scan	dx=8mm dy=8mm
Zoom Scan	5x5x7,dx=8mm dy=8mm dz=5mm
Variation (%)	0.980000
SAR 10g (W/Kg)	0.577984
SAR 1g (W/Kg)	0.935582

**SURFACE SAR**

**VOLUME SAR**

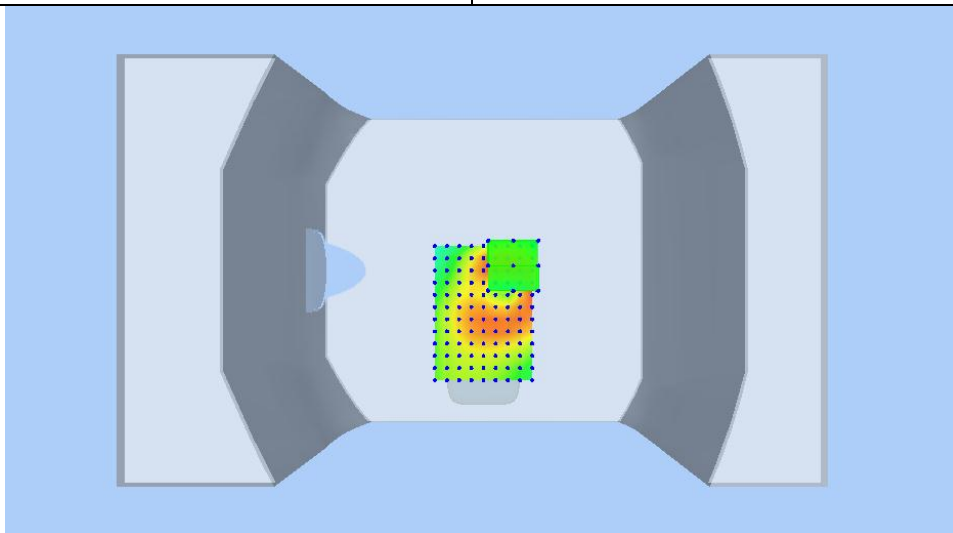
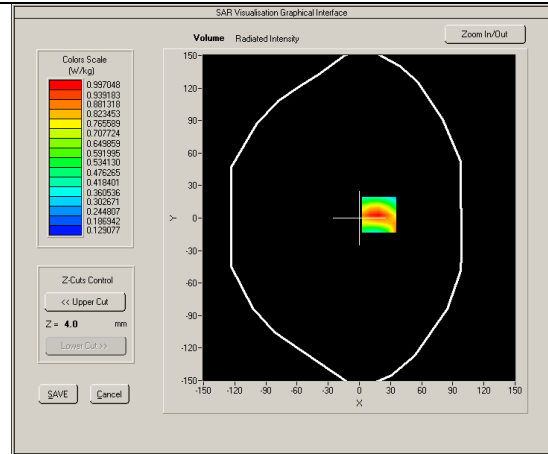
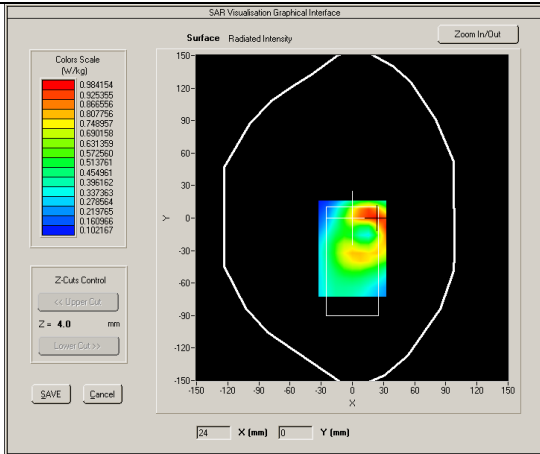

Test mode: WCDMA Band V, Middle channel (Left Head Cheek)

Product Description: LTE Mobile Phone

Model: M4 SS4453-R

Test Date: Jun 26,2017

Medium(liquid type)	HSL_835
Frequency (MHz)	835.0000
Relative permittivity (real part)	41.2
Conductivity (S/m)	0.91
E-Field Probe	SN 27/15 EPGO262
Crest factor	1.0
Conversion Factor	1.74
Sensor-Surface	4mm
Area Scan	dx=8mm dy=8mm
Zoom Scan	5x5x7, dx=8mm dy=8mm dz=5mm
Variation (%)	0.540000
SAR 10g (W/Kg)	0.178390
SAR 1g (W/Kg)	0.210966

**SURFACE SAR**

**VOLUME SAR**

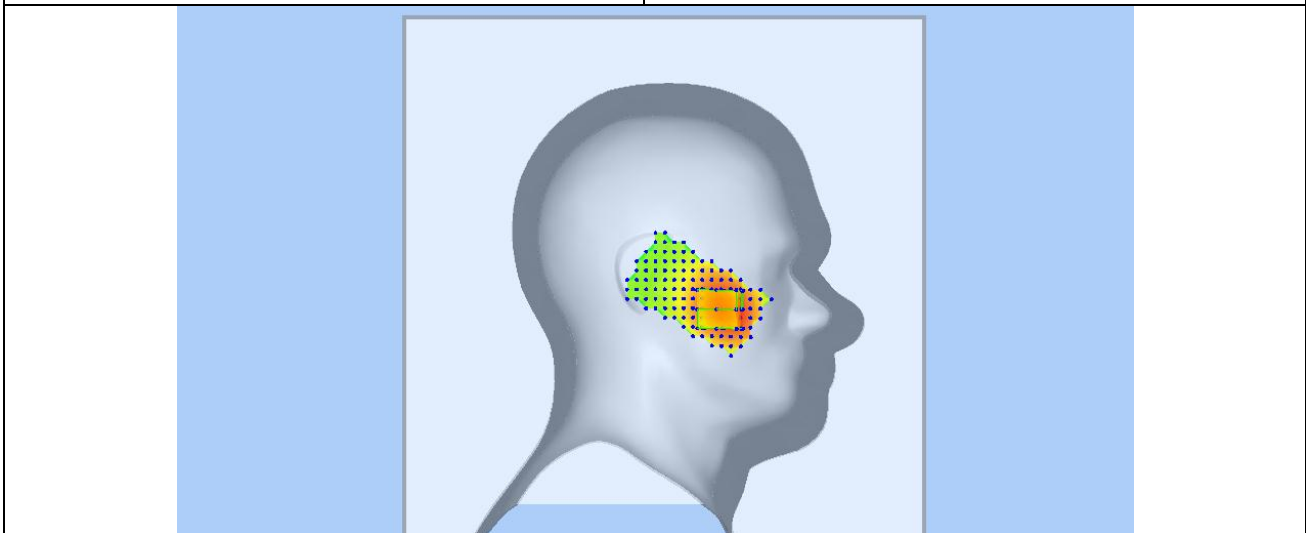
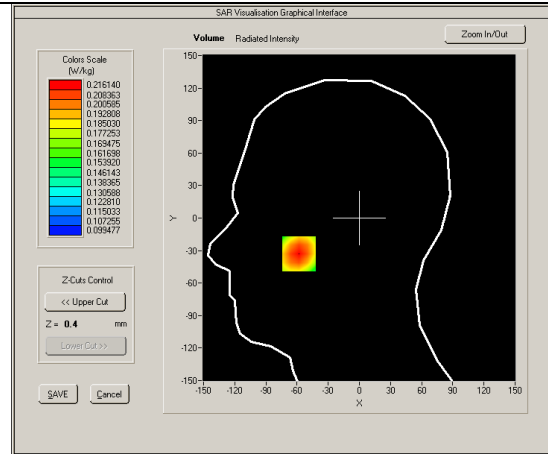
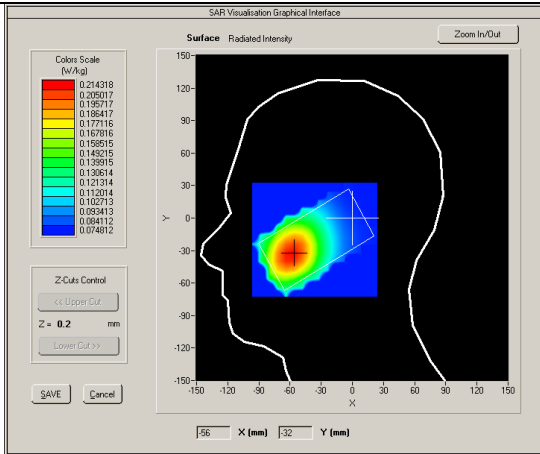

Test mode: WCDMA Band V, Middle channel (Body Back Side)

Product Description: LTE Mobile Phone

Model: M4 SS4453-R

Test Date: Jun 26,2017

Medium(liquid type)	MSL_835
Frequency (MHz)	835.0000
Relative permittivity (real part)	55.17
Conductivity (S/m)	0.99
E-Field Probe	SN 27/15 EPGO262
Crest factor	1.0
Conversion Factor	1.81
Sensor-Surface	4mm
Area Scan	dx=8mm dy=8mm
Zoom Scan	5x5x7,dx=8mm dy=8mm dz=5mm
Variation (%)	-0.110000
SAR 10g (W/Kg)	0.231749
SAR 1g (W/Kg)	0.336340

**SURFACE SAR**

**VOLUME SAR**

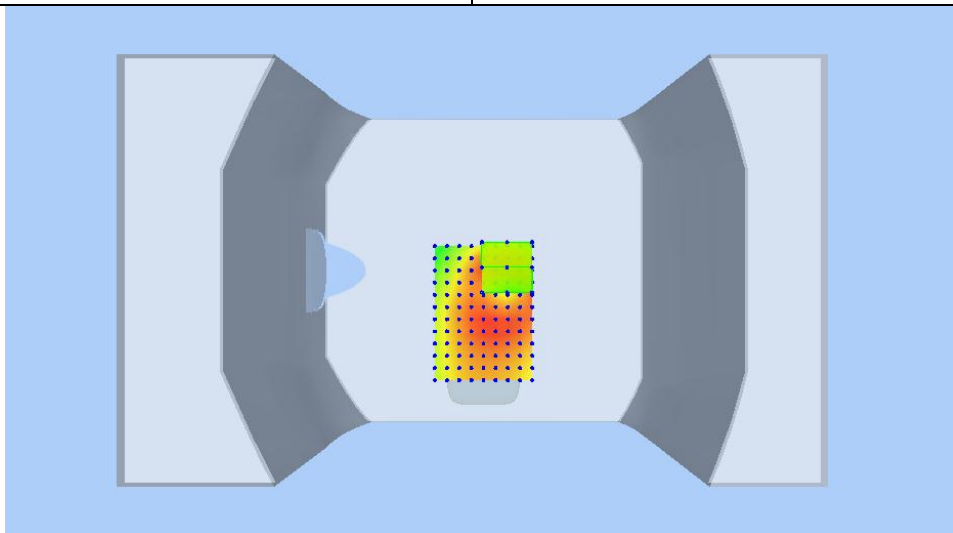
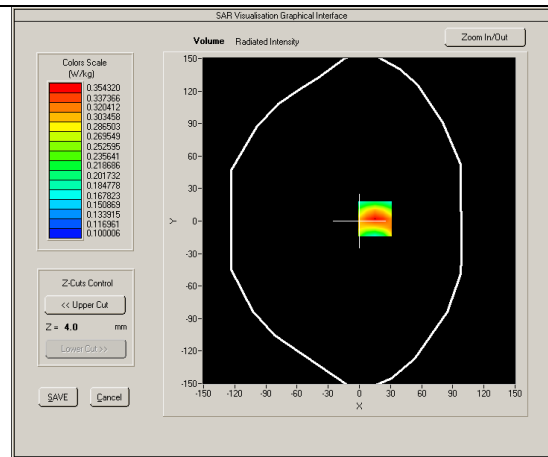
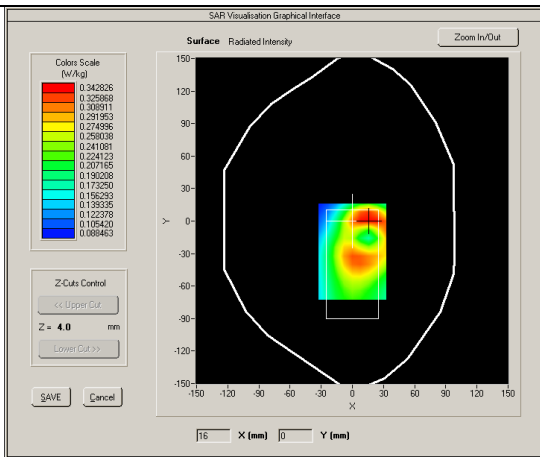



Test mode: PCS1900, Middle channel (Left Head Cheek)  
 Product Description: LTE Mobile Phone  
 Model: M4 SS4453-R  
 Test Date: Jun 30,2017

Medium(liquid type)	HSL 1900
Frequency (MHz)	1880.000
Relative permittivity (real part)	40.02
Conductivity (S/m)	1.37
E-Field Probe	SN 27/15 EPGO262
Crest factor	8.0
Conversion Factor	2.01
Sensor-Surface	4mm
Area Scan	dx=8mm dy=8mm
Zoom Scan	5x5x7,dx=8mm dy=8mm dz=5mm
Variation (%)	1.600000
SAR 10g (W/Kg)	0.229177
SAR 1g (W/Kg)	0.309280

**SURFACE SAR**

**VOLUME SAR**

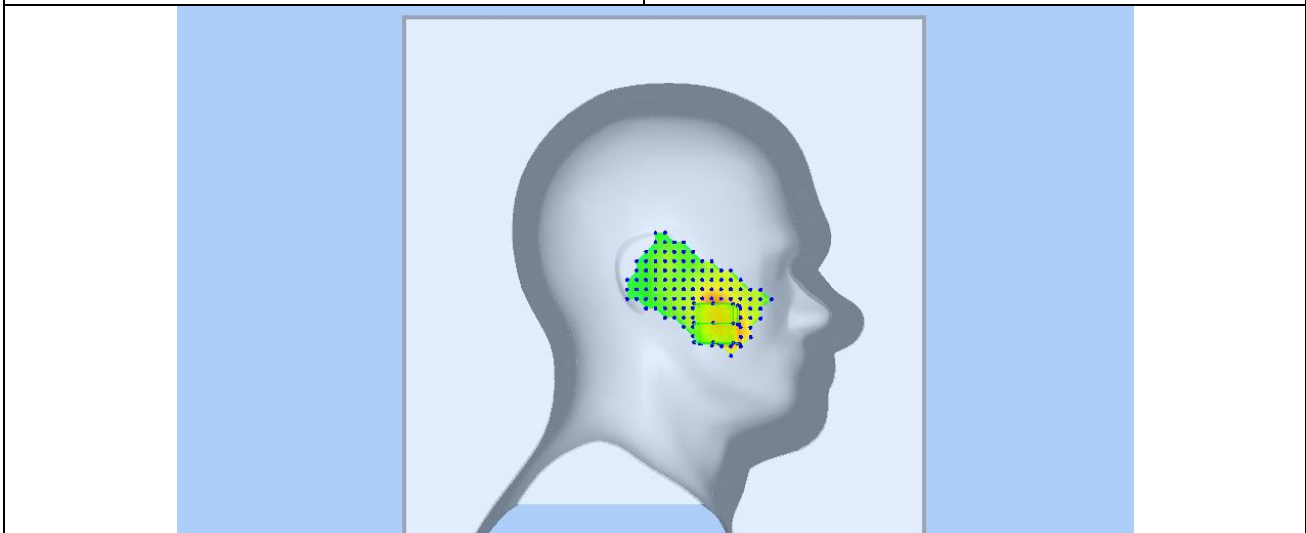
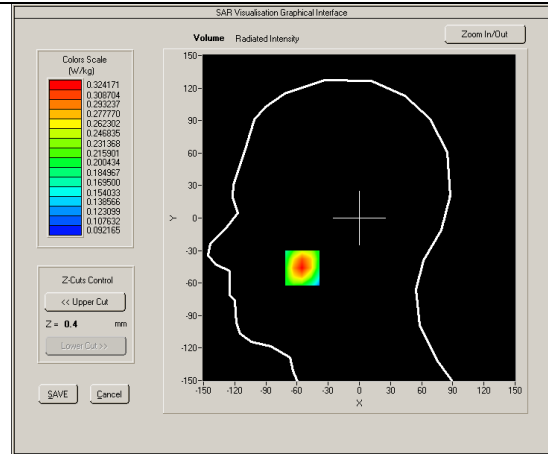
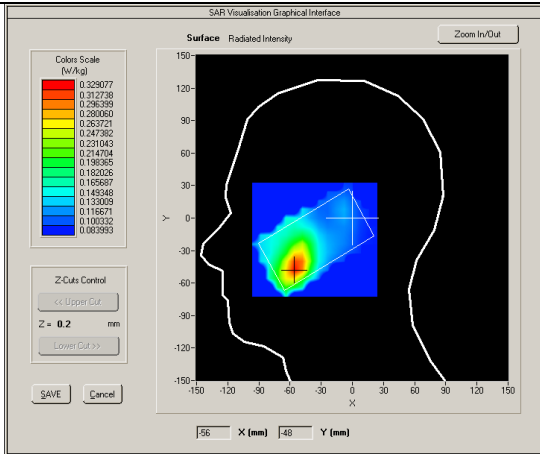

Test mode: GPRS1900, Middle channel (Body Front Side)  
 Product Description: LTE Mobile Phone  
 Model: M4 SS4453-R  
 Test Date: Jun 30,2017

Medium(liquid type)	MSL_1900
Frequency (MHz)	1880.000
Relative permittivity (real part)	53.29
Conductivity (S/m)	1.51
E-Field Probe	SN 27/15 EPGO262
Crest factor	2.0
Conversion Factor	2.05
Sensor-Surface	4mm
Area Scan	dx=8mm dy=8mm
Zoom Scan	5x5x7,dx=8mm dy=8mm dz=5mm
Variation (%)	-0.030000
SAR 10g (W/Kg)	0.417670
SAR 1g (W/Kg)	0.611592

**SURFACE SAR**

**VOLUME SAR**

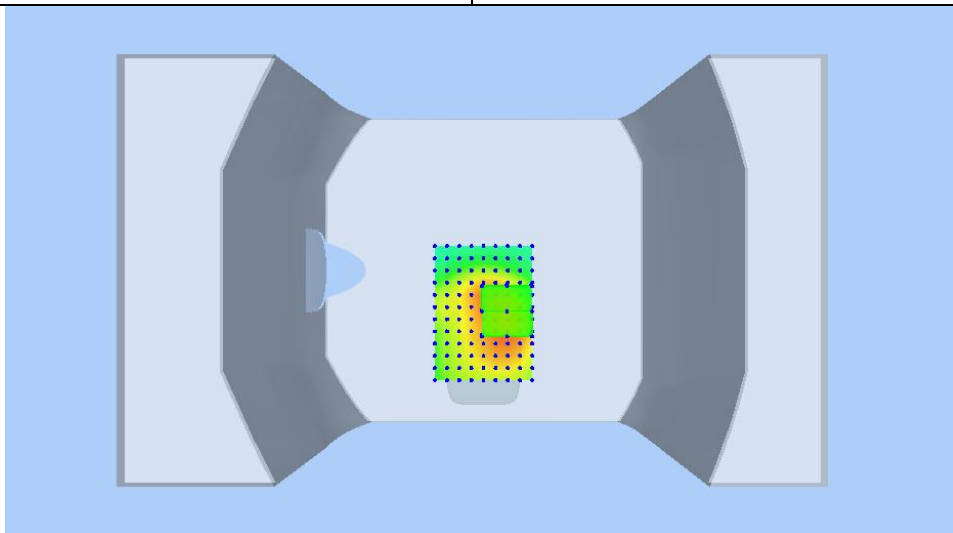
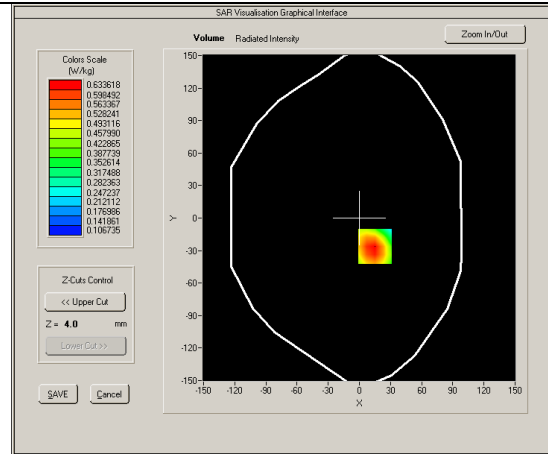
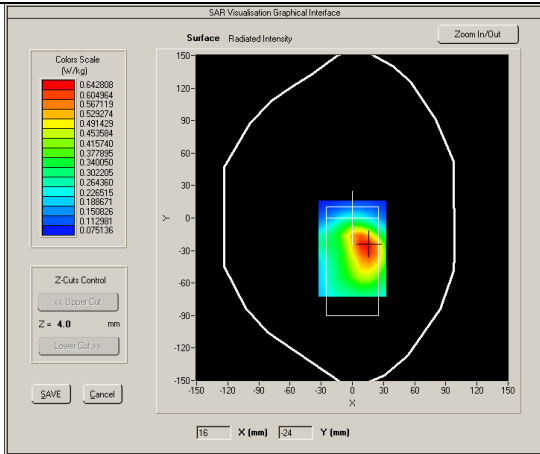

Test mode: WCDMA Band II , Middle channel (Left Head Cheek)

Product Description: LTE Mobile Phone

Model: M4 SS4453-R

Test Date: Jun 30,2017

Medium(liquid type)	HSL_1900
Frequency (MHz)	1880.000
Relative permittivity (real part)	40.02
Conductivity (S/m)	1.37
E-Field Probe	SN 27/15 EPGO262
Crest factor	1.0
Conversion Factor	2.01
Sensor-Surface	4mm
Area Scan	dx=8mm dy=8mm
Zoom Scan	5x5x7,dx=8mm dy=8mm dz=5mm
Variation (%)	-0.210000
SAR 10g (W/Kg)	0.286107
SAR 1g (W/Kg)	0.401158

**SURFACE SAR**

**VOLUME SAR**

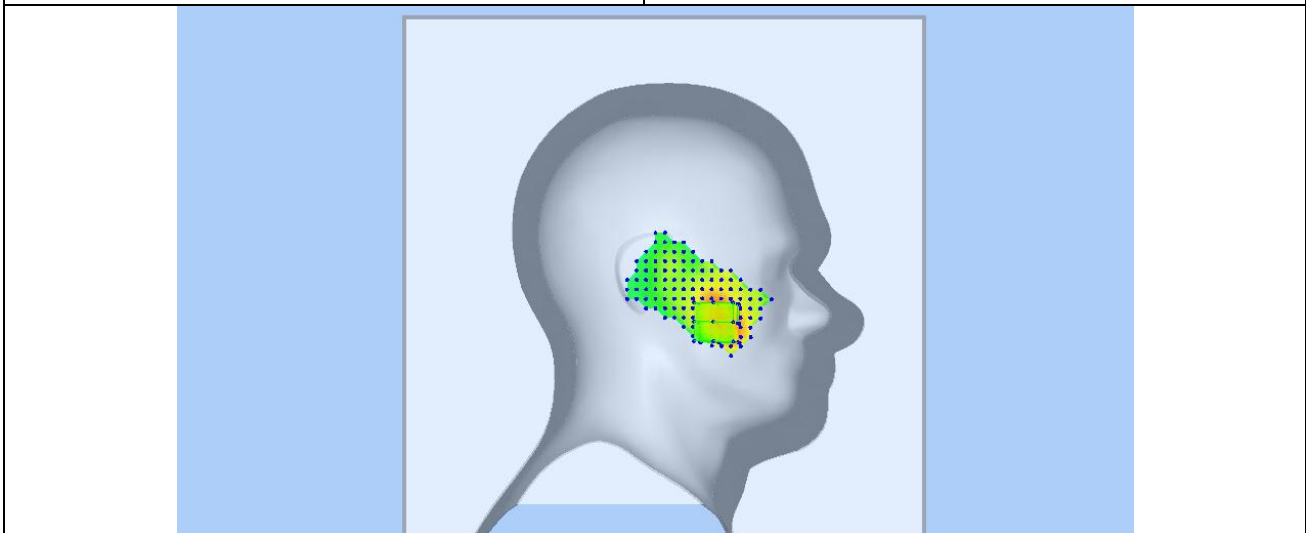
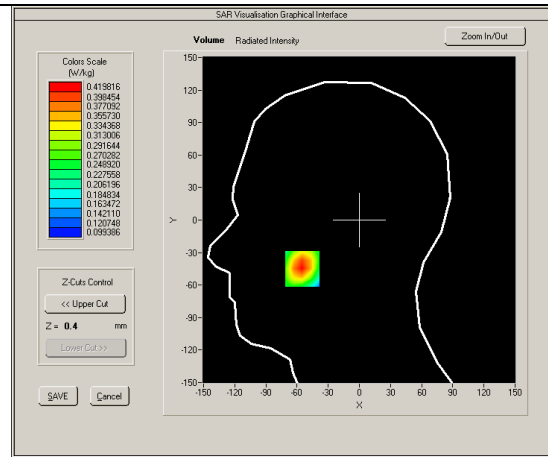
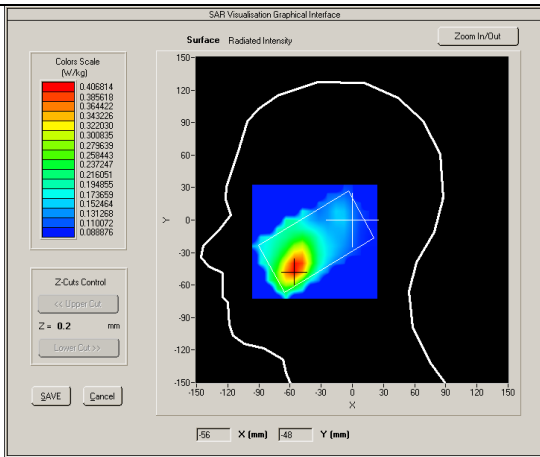

Test mode: WCDMA Band II , Middle channel (Body Front Side)

Product Description: LTE Mobile Phone

Model: M4 SS4453-R

Test Date: Jun 30,2017

Medium(liquid type)	MSL_1900
Frequency (MHz)	1880.000
Relative permittivity (real part)	53.29
Conductivity (S/m)	1.51
E-Field Probe	SN 27/15 EPGO262
Crest factor	1.0
Conversion Factor	2.05
Sensor-Surface	4mm
Area Scan	dx=8mm dy=8mm
Zoom Scan	5x5x7,dx=8mm dy=8mm dz=5mm
Variation (%)	-0.820000
SAR 10g (W/Kg)	0.483579
SAR 1g (W/Kg)	0.706183

**SURFACE SAR**

**VOLUME SAR**

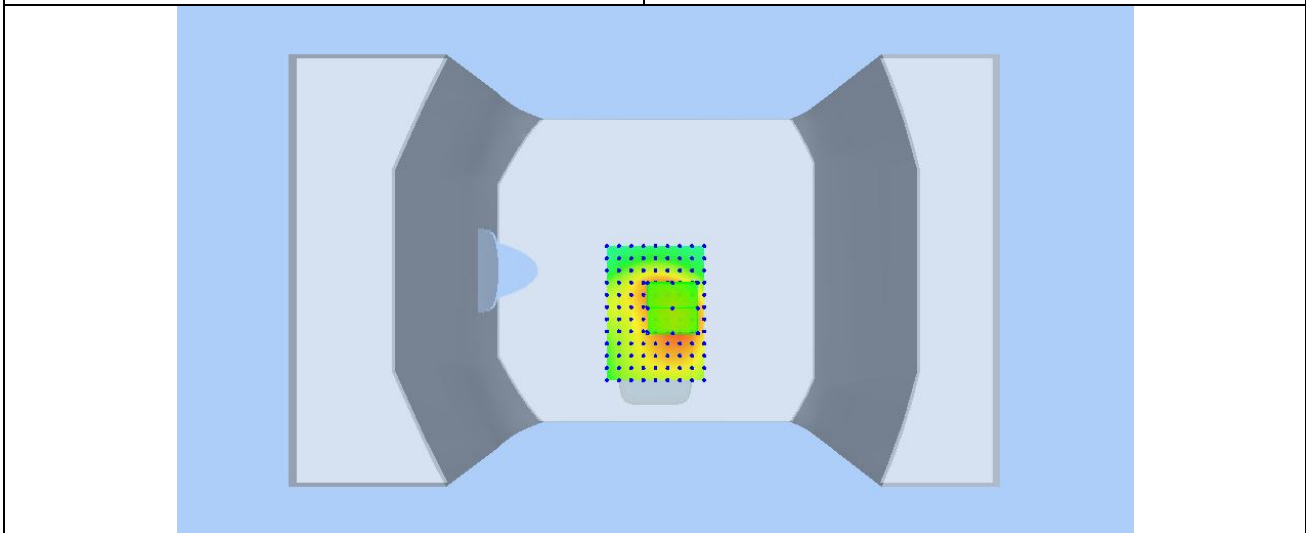
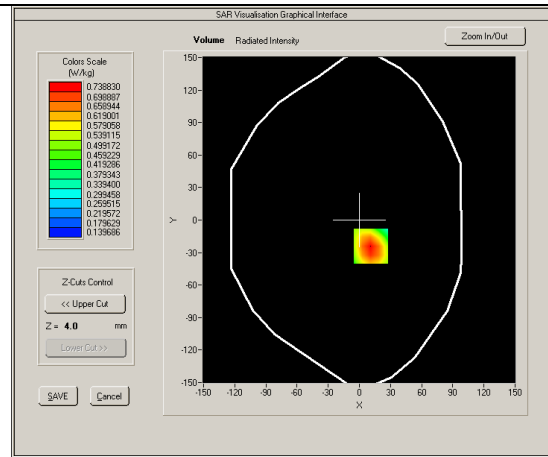
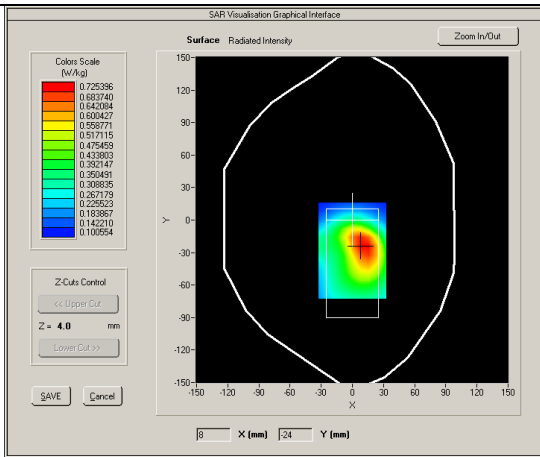

Test mode: LTE BAND 13, Middle channel (Right Head Cheek)

Product Description: LTE Mobile Phone

Model: M4 SS4453-R

Test Date: Jun 23,2017

Medium(liquid type)	HSL_750
Frequency (MHz)	782.0000
Relative permittivity (real part)	41.95
Conductivity (S/m)	0.91
E-Field Probe	SN 27/15 EPGO262
Crest factor	1.0
Conversion Factor	1.57
Sensor-Surface	4mm
Bandwidth(MHz)	10
RB Allocation	1
RB Offset	24
Area Scan	dx=8mm dy=8mm
Zoom Scan	5x5x7,dx=8mm dy=8mm dz=5mm
Variation (%)	1.760000
SAR 10g (W/Kg)	0.101439
SAR 1g (W/Kg)	0.112341

**SURFACE SAR**

**VOLUME SAR**

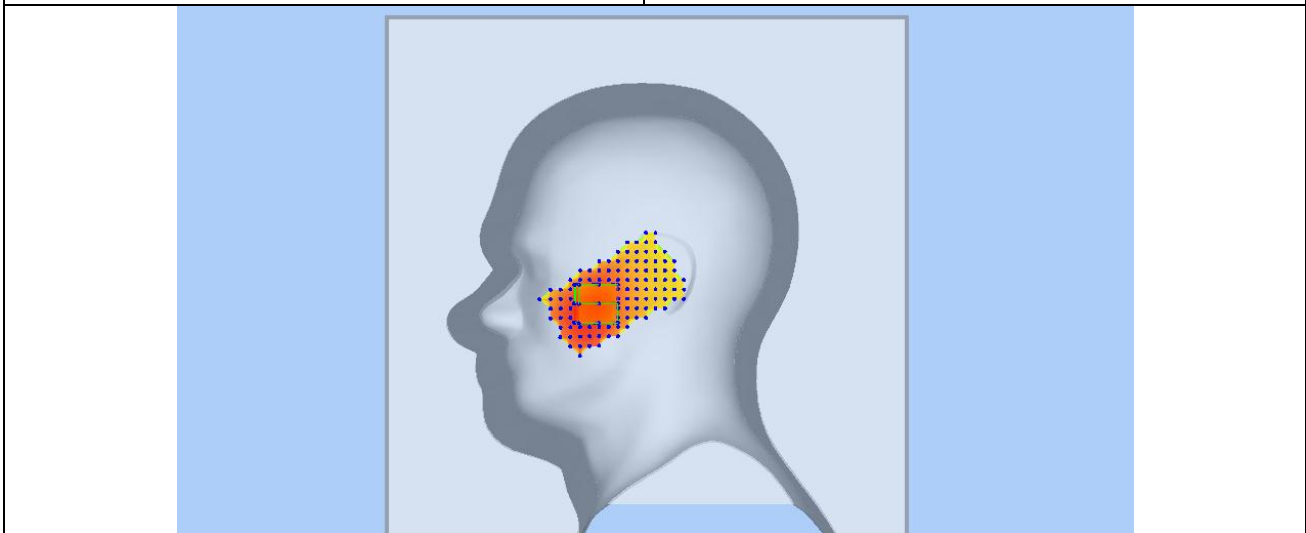
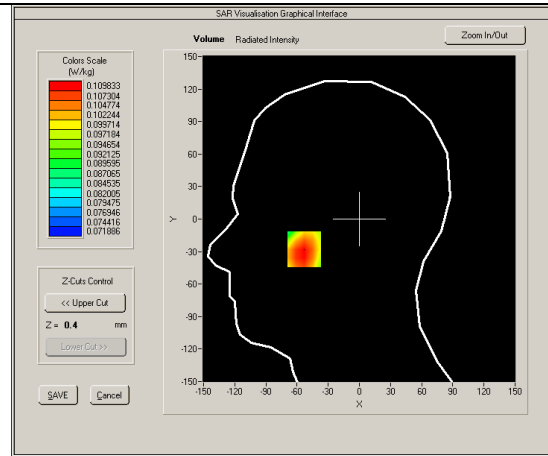
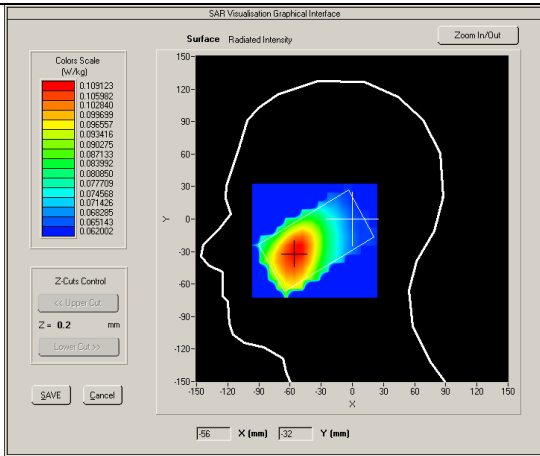

Test mode: LTE BAND 13, Middle channel (Body Back Side)

Product Description: LTE Mobile Phone

Model: M4 SS4453-R

Test Date: Jun 23,2017

Medium(liquid type)	MSL_750
Frequency (MHz)	782.0000
Relative permittivity (real part)	55.56
Conductivity (S/m)	0.97
E-Field Probe	SN 27/15 EPGO262
Crest factor	1.0
Conversion Factor	1.62
Sensor-Surface	4mm
Bandwidth(MHz)	10
RB Allocation	1
RB Offset	24
Area Scan	dx=8mm dy=8mm
Zoom Scan	5x5x7,dx=8mm dy=8mm dz=5mm
Variation (%)	0.200000
SAR 10g (W/Kg)	0.168938
SAR 1g (W/Kg)	0.235605
<b>SURFACE SAR</b>	<b>VOLUME SAR</b>

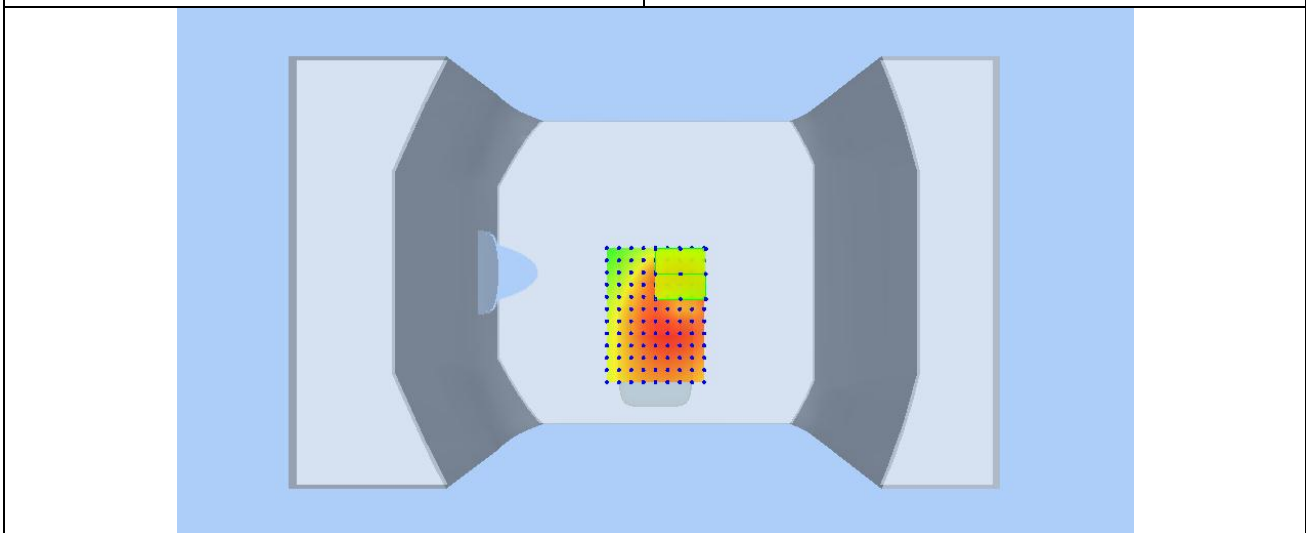
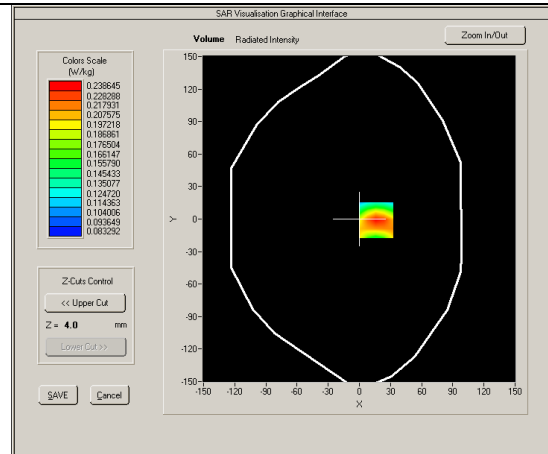
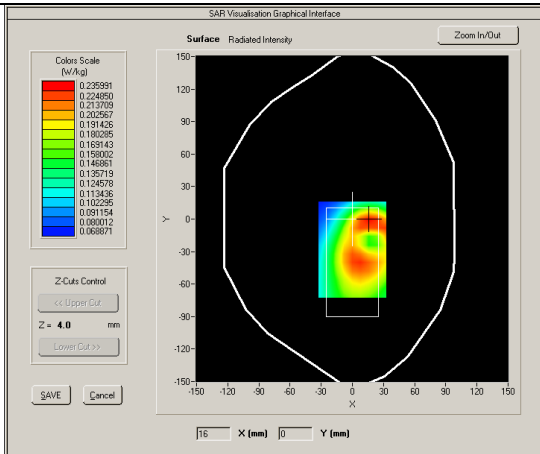

Test mode: LTE BAND 7, Middle channel (Left Head Cheek)  
 Product Description: LTE Mobile Phone  
 Model: M4 SS4453-R  
 Test Date: Jul 5,2017

Medium(liquid type)	HSL 2600
Frequency (MHz)	2535.0000
Relative permittivity (real part)	55.29
Conductivity (S/m)	1.97
E-Field Probe	SN 27/15 EPGO262
Crest factor	1.0
Conversion Factor	2.05
Sensor-Surface	4mm
Bandwidth(MHz)	20
RB Allocation	1
RB Offset	49
Area Scan	dx=8mm dy=8mm
Zoom Scan	5x5x7,dx=8mm dy=8mm dz=5mm
Variation (%)	0.990000
SAR 10g (W/Kg)	0.242141
SAR 1g (W/Kg)	0.354617

**SURFACE SAR**

**VOLUME SAR**

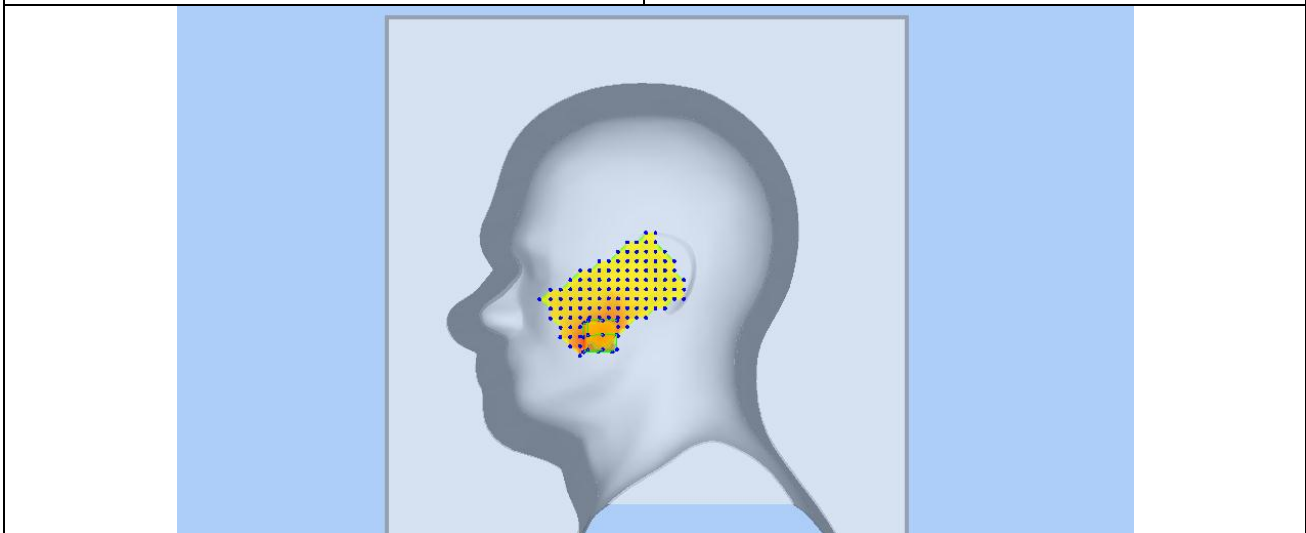
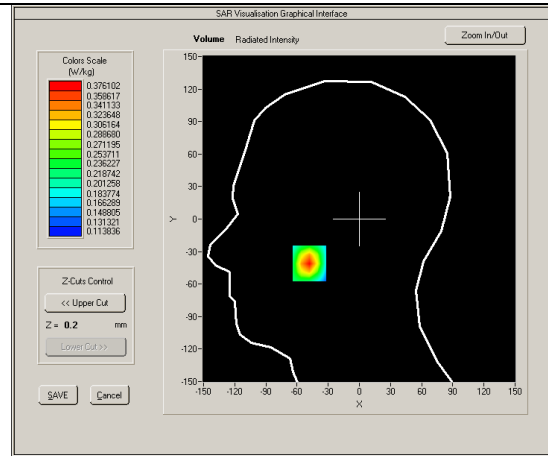
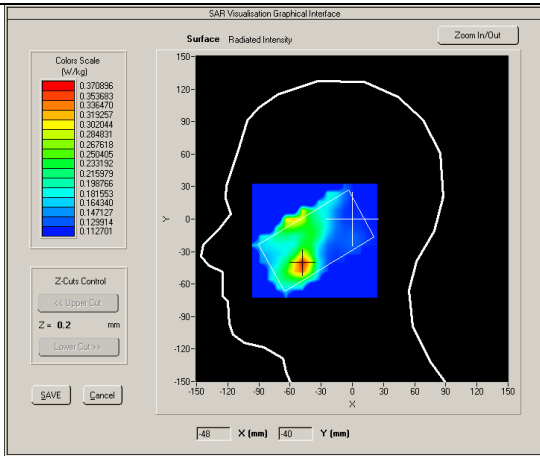

Test mode: LTE BAND 7, Mid channel (Body Down Side)

Product Description: LTE Mobile Phone

Model: M4 SS4453-R

Test Date: Jul 5,2017

Medium(liquid type)	MSL 2600
Frequency (MHz)	2535.0000
Relative permittivity (real part)	51.96
Conductivity (S/m)	2.17
E-Field Probe	SN 27/15 EPGO262
Crest factor	1.0
Conversion Factor	2.12
Sensor-Surface	4mm
Bandwidth(MHz)	20
RB Allocation	1
RB Offset	49
Area Scan	dx=8mm dy=8mm
Zoom Scan	5x5x7,dx=8mm dy=8mm dz=5mm
Variation (%)	0.150000
SAR 10g (W/Kg)	0.394551
SAR 1g (W/Kg)	0.647126

**SURFACE SAR**

**VOLUME SAR**

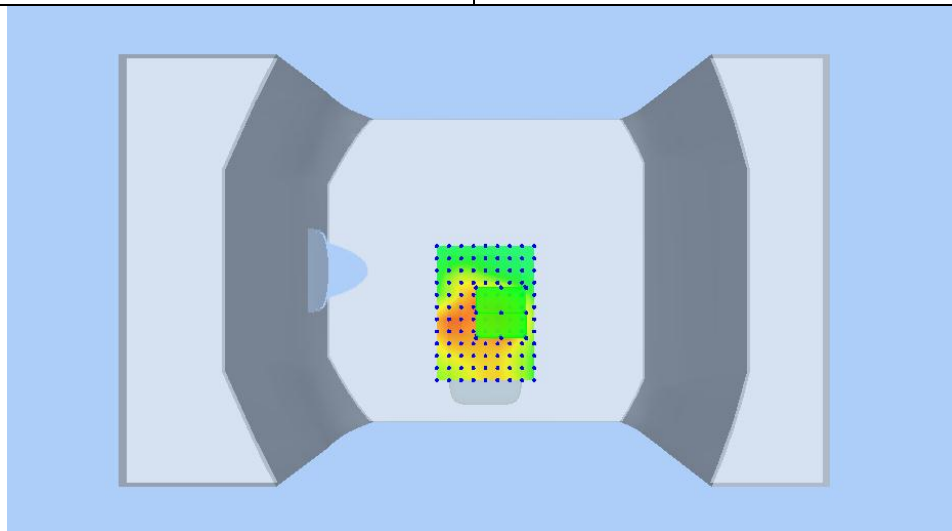
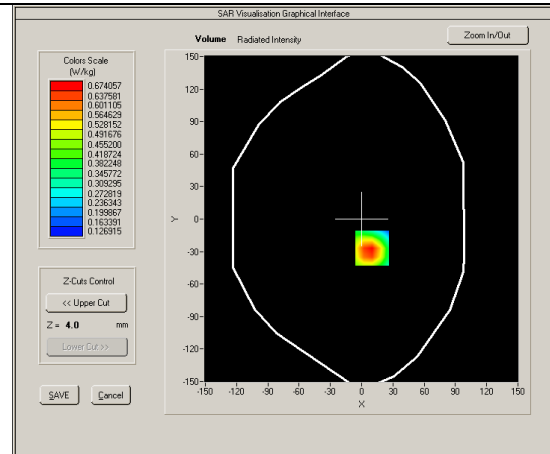
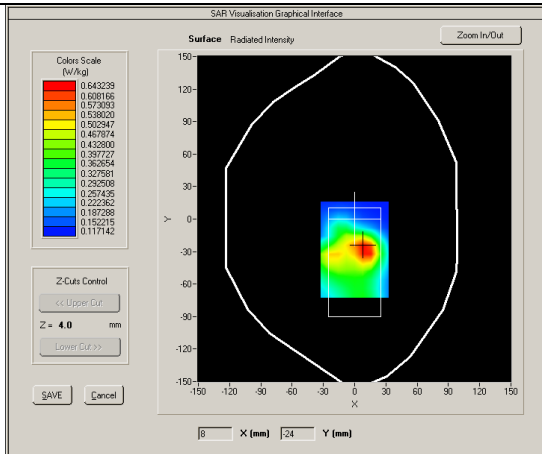



Test mode: LTE BAND 4, Middle channel (Right Head Cheek)  
 Product Description: LTE Mobile Phone  
 Model: M4 SS4453-R  
 Test Date: Jun 28,2017

Medium(liquid type)	HSL 1800
Frequency (MHz)	1732.5000
Relative permittivity (real part)	39.98
Conductivity (S/m)	1.41
E-Field Probe	SN 27/15 EPGO262
Crest factor	1.0
Conversion Factor	1.81
Sensor-Surface	4mm
Bandwidth(MHz)	20
RB Allocation	1
RB Offset	49
Area Scan	dx=8mm dy=8mm
Zoom Scan	5x5x7,dx=8mm dy=8mm dz=5mm
Variation (%)	0.200000
SAR 10g (W/Kg)	0.232007
SAR 1g (W/Kg)	0.295847

**SURFACE SAR**

**VOLUME SAR**

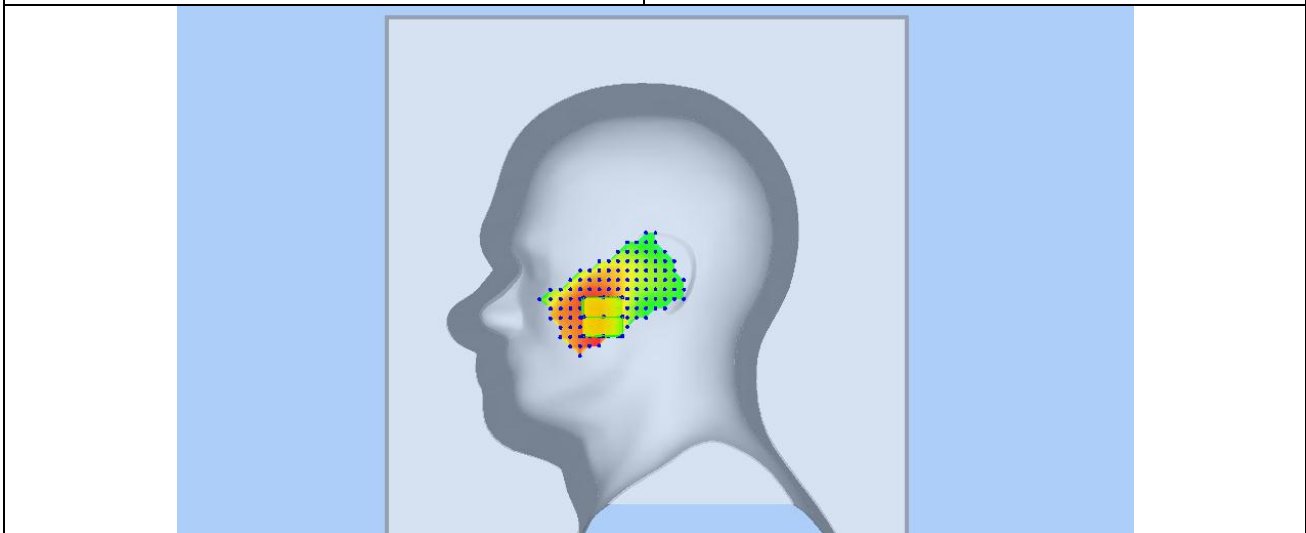
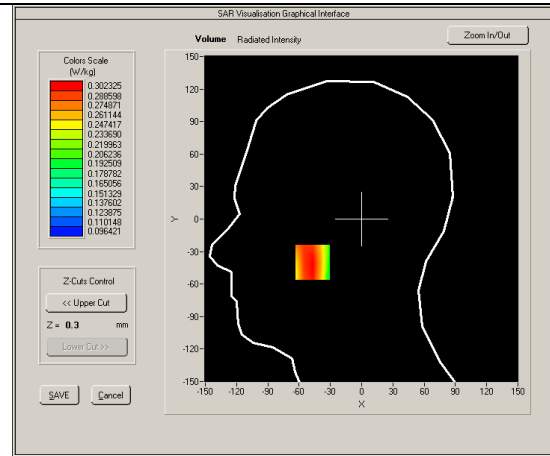
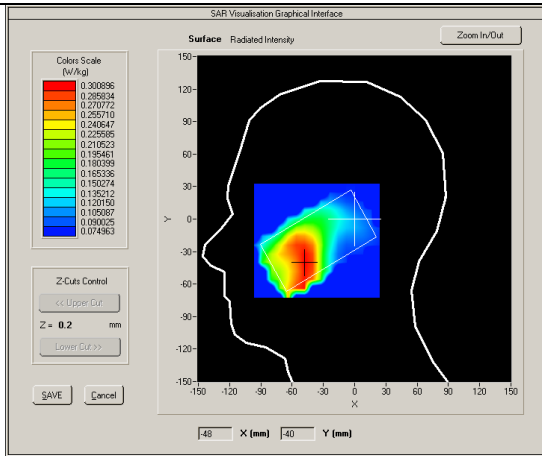

Test mode: LTE BAND 4, Middle channel (Body Front Side)

Product Description: LTE Mobile Phone

Model: M4 SS4453-R

Test Date: Jun 28,2017

Medium(liquid type)	MSL 1800
Frequency (MHz)	1732.5000
Relative permittivity (real part)	53.25
Conductivity (S/m)	1.56
E-Field Probe	SN 27/15 EPGO262
Crest factor	1.0
Conversion Factor	1.87
Sensor-Surface	4mm
Bandwidth(MHz)	20
RB Allocation	1
RB Offset	49
Area Scan	dx=8mm dy=8mm
Zoom Scan	5x5x7,dx=8mm dy=8mm dz=5mm
Variation (%)	-0.070000
SAR 10g (W/Kg)	0.515099
SAR 1g (W/Kg)	0.764830

**SURFACE SAR**

**VOLUME SAR**

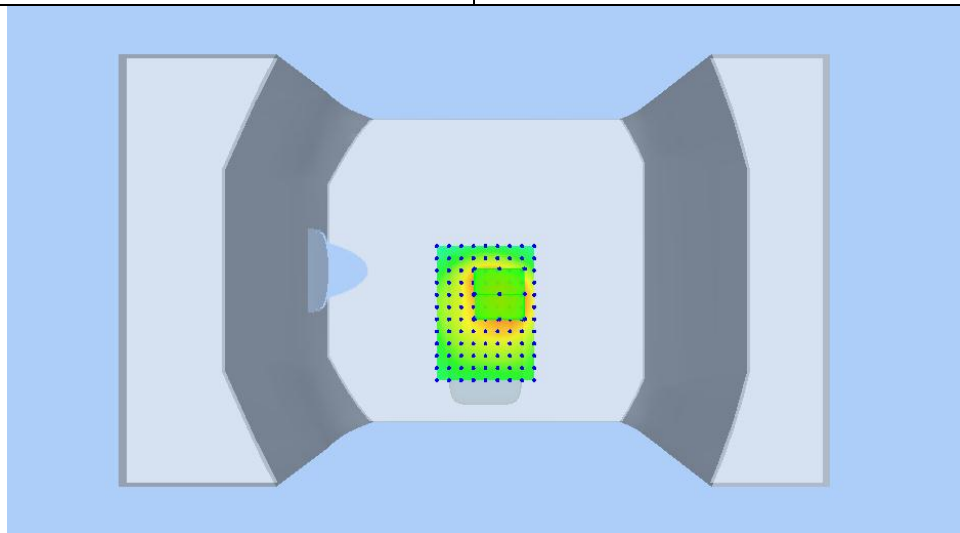
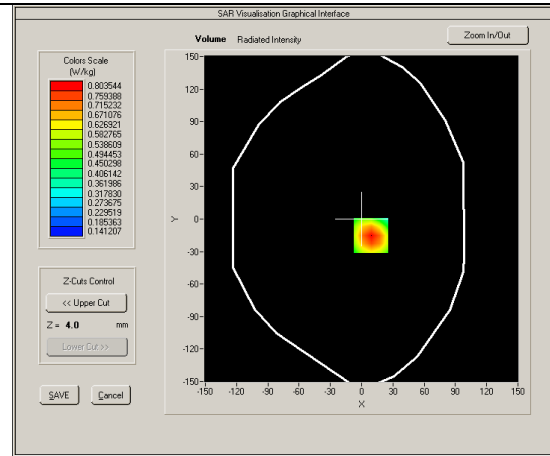
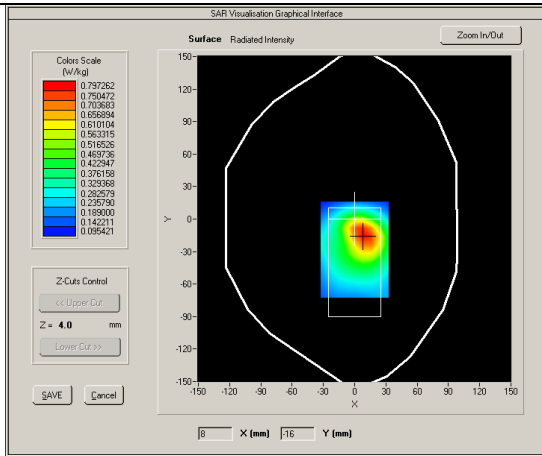

Test mode: LTE BAND 2, Middle channel (Left Head Cheek)  
 Product Description: LTE Mobile Phone  
 Model: M4 SS4453-R  
 Test Date: Jun 30,2017

Medium(liquid type)	HSL 1900
Frequency (MHz)	1880.0000
Relative permittivity (real part)	40.03
Conductivity (S/m)	1.39
E-Field Probe	SN 27/15 EPGO262
Crest factor	1.0
Conversion Factor	2.01
Sensor-Surface	4mm
Bandwidth(MHz)	20
RB Allocation	1
RB Offset	49
Area Scan	dx=8mm dy=8mm
Zoom Scan	5x5x7,dx=8mm dy=8mm dz=5mm
Variation (%)	0.210000
SAR 10g (W/Kg)	0.226596
SAR 1g (W/Kg)	0.320843

**SURFACE SAR**

**VOLUME SAR**

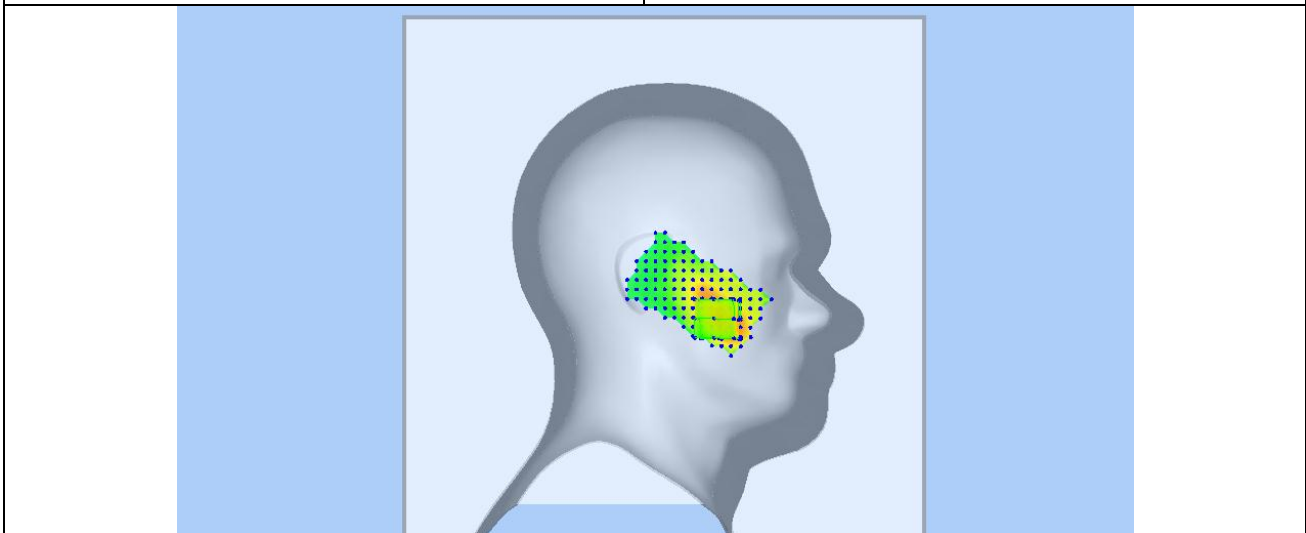
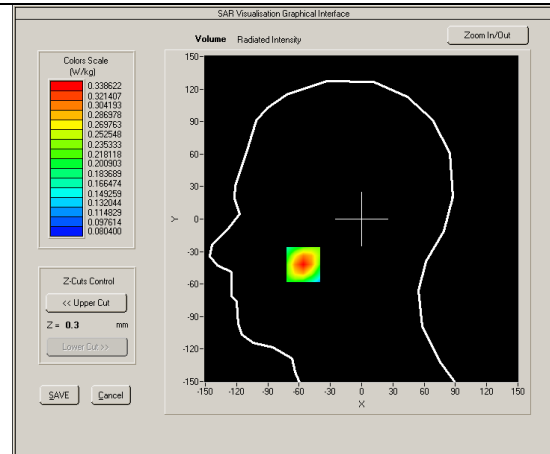
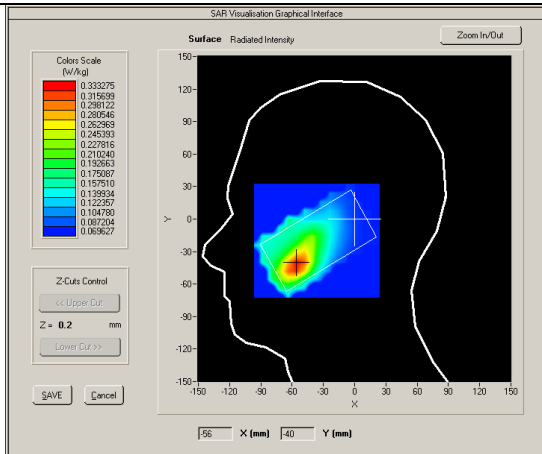

Test mode: LTE BAND 2, Middle channel (Body Front Side)

Product Description: LTE Mobile Phone

Model: M4 SS4453-R

Test Date: Jun 30,2017

Medium(liquid type)	MSL 1900
Frequency (MHz)	1880.0000
Relative permittivity (real part)	53.28
Conductivity (S/m)	1.53
E-Field Probe	SN 27/15 EPGO262
Crest factor	1.0
Conversion Factor	2.05
Sensor-Surface	4mm
Bandwidth(MHz)	20
RB Allocation	1
RB Offset	49
Area Scan	dx=8mm dy=8mm
Zoom Scan	5x5x7,dx=8mm dy=8mm dz=5mm
Variation (%)	-0.190000
SAR 10g (W/Kg)	0.516140
SAR 1g (W/Kg)	0.766739
<b>SURFACE SAR</b>	<b>VOLUME SAR</b>

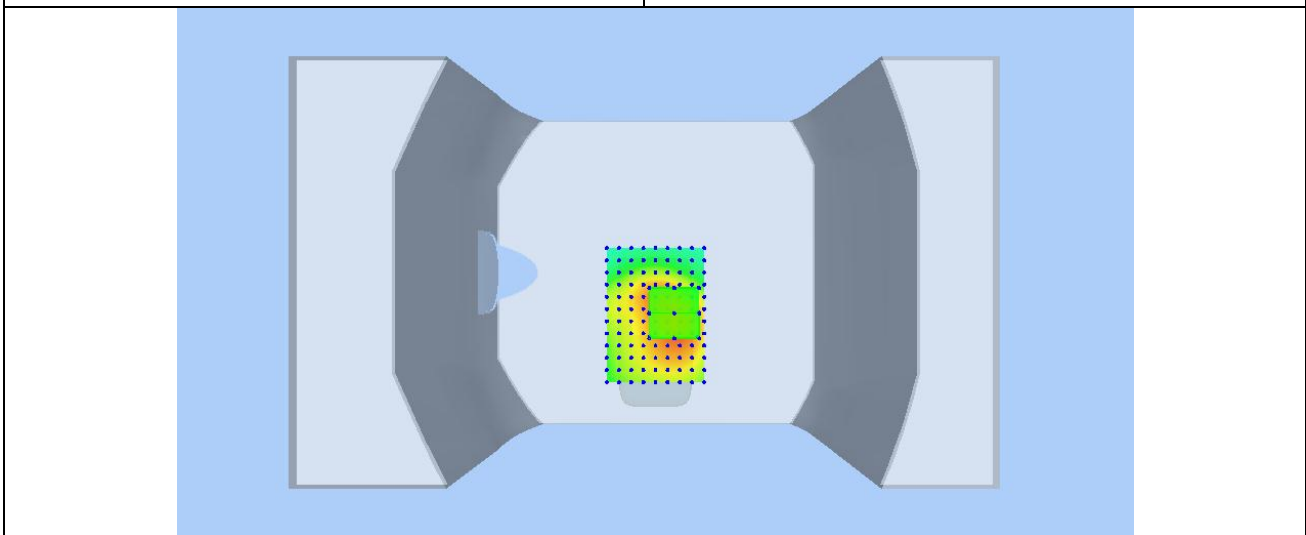
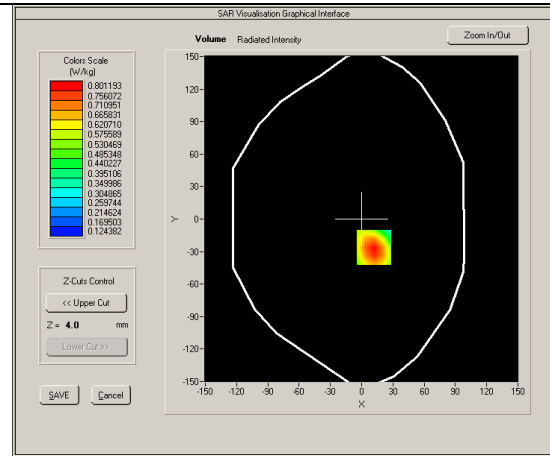
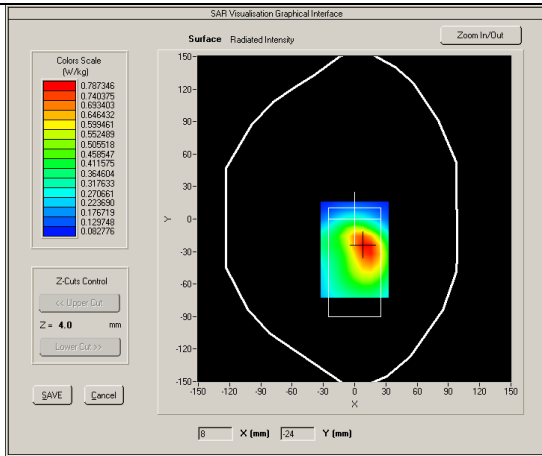

Test mode: 802.11b, Middle channel (Right Head Cheek)  
 Product Description: LTE Mobile Phone  
 Model: M4 SS4453-R  
 Test Date: Jul 3,2017

Medium(liquid type)	HSL 2450
Frequency (MHz)	2437.000
Relative permittivity (real part)	40.42
Conductivity (S/m)	1.77
E-Field Probe	SN 27/15 EPGO262
Crest factor	1.0
Conversion Factor	2.04
Sensor-Surface	4mm
Area Scan	dx=8mm dy=8mm
Zoom Scan	5x5x7,dx=8mm dy=8mm dz=5mm
Variation (%)	-0.040000
SAR 10g (W/Kg)	0.339034
SAR 1g (W/Kg)	0.550747

**SURFACE SAR**

**VOLUME SAR**

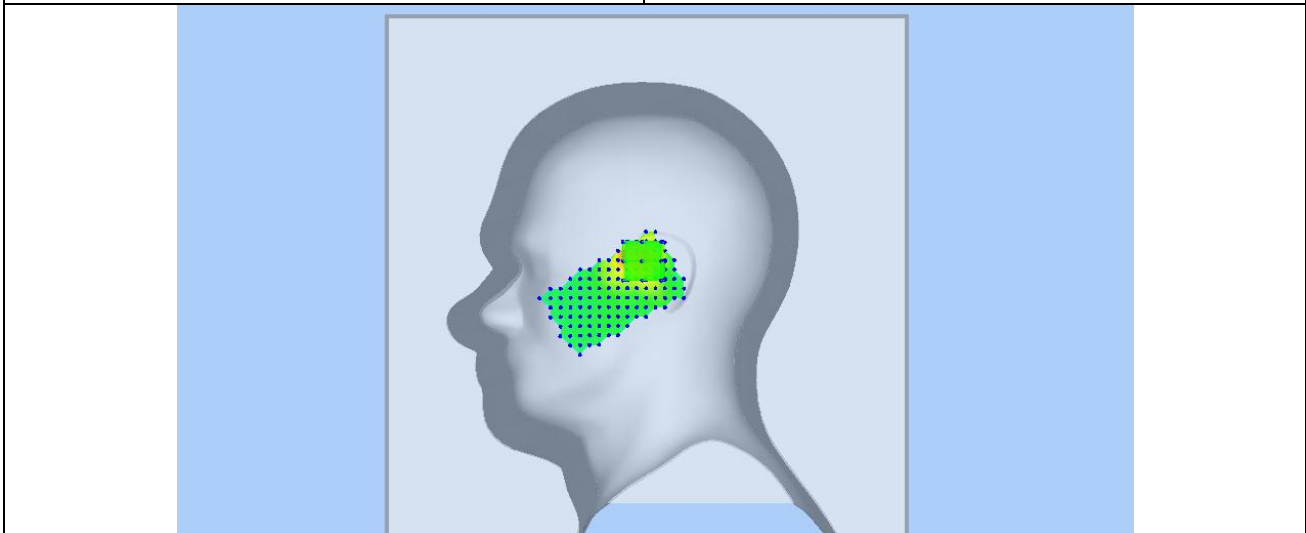
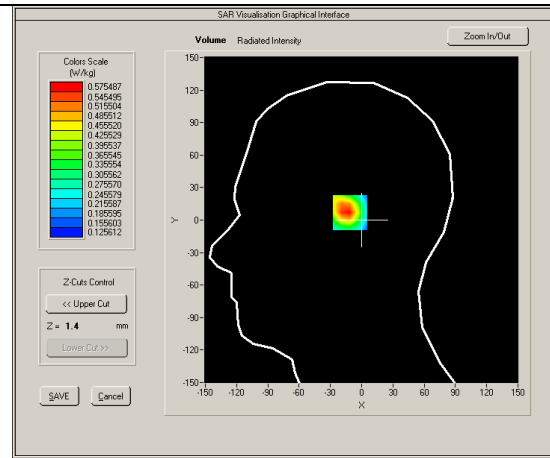
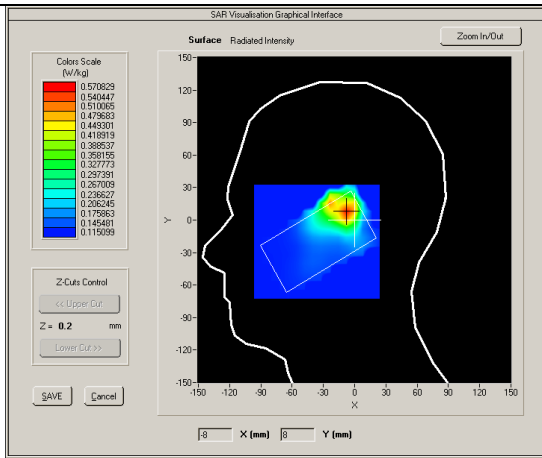

Test mode: 802.11b, Middle channel (Body Back Side)  
 Product Description: LTE Mobile Phone  
 Model: M4 SS4453-R  
 Test Date: Jul 3,2017

Medium(liquid type)	MSL_2450
Frequency (MHz)	2437.000
Relative permittivity (real part)	52.78
Conductivity (S/m)	1.97
E-Field Probe	SN 27/15 EPGO262
Crest factor	1.0
Conversion Factor	2.12
Sensor-Surface	4mm
Area Scan	dx=8mm dy=8mm
Zoom Scan	5x5x7,dx=8mm dy=8mm dz=5mm
Variation (%)	-0.380000
SAR 10g (W/Kg)	0.197204
SAR 1g (W/Kg)	0.281335

**SURFACE SAR**

**VOLUME SAR**

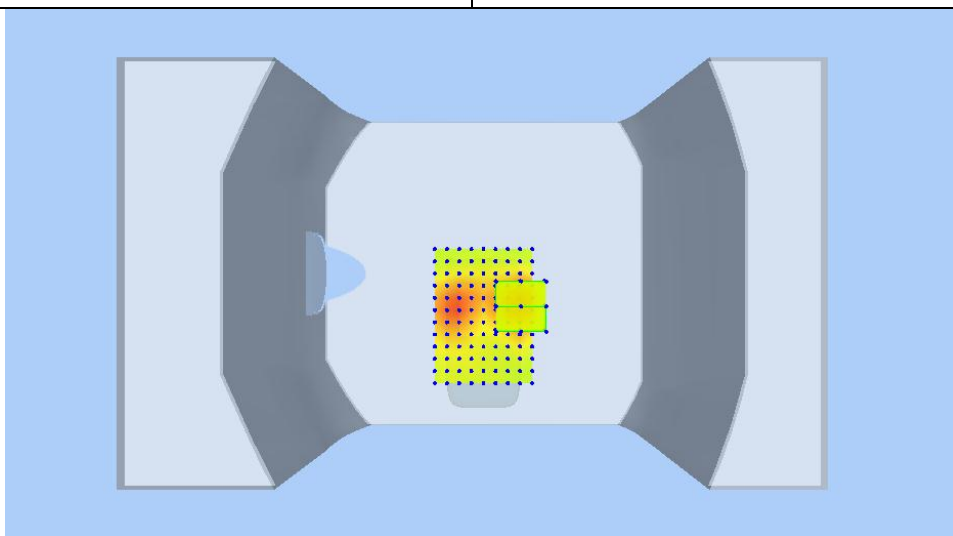
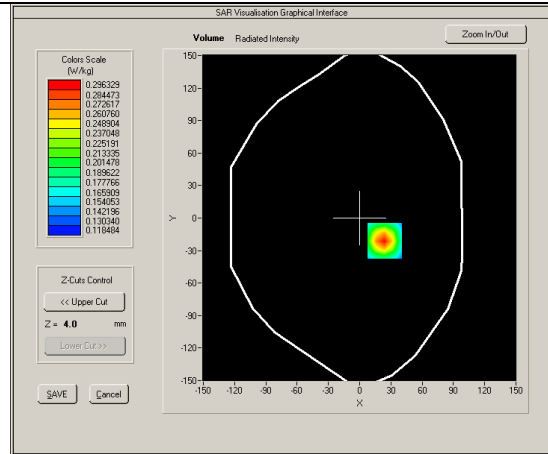
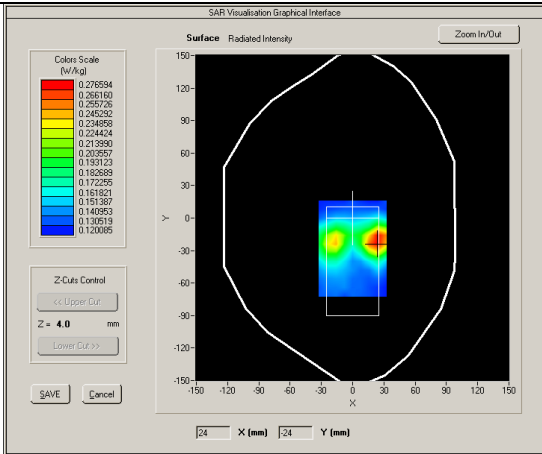

**Annex A CALIBRATION REPORTS**



**COMOSAR E-Field Probe Calibration Report**

Ref : ACR.264.3.16.SATU.A

**SIEMIC TESTING AND CERTIFICATION SERVICES**  
**ZONE A,FLOOR 1,BUILDING 2,WAN YE LONG TECHNOLOGY PARK,SOUTH SIDE OF ZHOUSHI ROAD, SHIYAN STREET,BAO'AN DISTRICT, SHENZHEN 518108 , GUANGDONG , P.R.C.**  
**MVG COMOSAR DOSIMETRIC E-FIELD PROBE**  
**SERIAL NO.: SN 27/15 EPGO262**

**Calibrated at MVG US**  
**2105 Barrett Park Dr. - Kennesaw, GA 30144**  
  
**Calibration Date: 09/20/2016**

*Summary:*  
This document presents the method and results from an accredited COMOSAR Dosimetric E-Field Probe calibration performed in MVG USA using the CALISAR / CALIBAIR test bench, for use with a COMOSAR system only. All calibration results are traceable to national metrology institutions.

Test Report	17070523-FCC-H
Page	96 of 176



**COMOSAR E-FIELD PROBE CALIBRATION REPORT**

Ref: ACR.264.3.16.SATU.A

	<i>Name</i>	<i>Function</i>	<i>Date</i>	<i>Signature</i>
<i>Prepared by :</i>	Jérôme LUC	Product Manager	9/20/2016	<i>JS</i>
<i>Checked by :</i>	Jérôme LUC	Product Manager	9/20/2016	<i>JS</i>
<i>Approved by :</i>	Kim RUTKOWSKI	Quality Manager	9/20/2016	<i>Kim Rutkowski</i>

	<i>Customer Name</i>
<i>Distribution :</i>	SIEMIC Testing and Certification Services

<i>Issue</i>	<i>Date</i>	<i>Modifications</i>
A	9/20/2016	Initial release





**TABLE OF CONTENTS**

1	Device Under Test .....	4
2	Product Description .....	4
2.1	General Information _____	4
3	Measurement Method .....	4
3.1	Linearity _____	4
3.2	Sensitivity _____	5
3.3	Lower Detection Limit _____	5
3.4	Isotropy _____	5
3.5	Boundary Effect _____	5
4	Measurement Uncertainty .....	5
5	Calibration Measurement Results .....	6
5.1	Sensitivity in air _____	6
5.2	Linearity _____	7
5.3	Sensitivity in liquid _____	7
5.4	Isotropy _____	8
6	List of Equipment .....	10



## 1 DEVICE UNDER TEST

Device Under Test	
Device Type	COMOSAR DOSIMETRIC E FIELD PROBE
Manufacturer	MVG
Model	SSE2
Serial Number	SN 27/15 EPGO262
Product Condition (new / used)	Used
Frequency Range of Probe	0.7 GHz-6GHz
Resistance of Three Dipoles at Connector	Dipole 1: R1=0.221 MΩ Dipole 2: R2=0.199 MΩ Dipole 3: R3=0.199 MΩ

A yearly calibration interval is recommended.

## 2 PRODUCT DESCRIPTION

### 2.1 GENERAL INFORMATION

MVG's COMOSAR E field Probes are built in accordance to the IEEE 1528, OET 65 Bulletin C and CEI/IEC 62209 standards.



Figure 1 – MVG COMOSAR Dosimetric E field Dipole

Probe Length	330 mm
Length of Individual Dipoles	2 mm
Maximum external diameter	8 mm
Probe Tip External Diameter	2.5 mm
Distance between dipoles / probe extremity	1 mm

## 3 MEASUREMENT METHOD

The IEEE 1528, OET 65 Bulletin C, CENELEC EN50361 and CEI/IEC 62209 standards provide recommended practices for the probe calibrations, including the performance characteristics of interest and methods by which to assess their affect. All calibrations / measurements performed meet the fore mentioned standards.

### 3.1 LINEARITY

The evaluation of the linearity was done in free space using the waveguide, performing a power sweep to cover the SAR range 0.01W/kg to 100W/kg.



### 3.2 SENSITIVITY

The sensitivity factors of the three dipoles were determined using a two step calibration method (air and tissue simulating liquid) using waveguides as outlined in the standards.

### 3.3 LOWER DETECTION LIMIT

The lower detection limit was assessed using the same measurement set up as used for the linearity measurement. The required lower detection limit is 10 mW/kg.

### 3.4 ISOTROPY

The axial isotropy was evaluated by exposing the probe to a reference wave from a standard dipole with the dipole mounted under the flat phantom in the test configuration suggested for system validations and checks. The probe was rotated along its main axis from 0 - 360 degrees in 15 degree steps. The hemispherical isotropy is determined by inserting the probe in a thin plastic box filled with tissue-equivalent liquid, with the plastic box illuminated with the fields from a half wave dipole. The dipole is rotated about its axis (0°–180°) in 15° increments. At each step the probe is rotated about its axis (0°–360°).

### 3.5 BOUNDARY EFFECT

The boundary effect is defined as the deviation between the SAR measured data and the expected exponential decay in the liquid when the probe is oriented normal to the interface. To evaluate this effect, the liquid filled flat phantom is exposed to fields from either a reference dipole or waveguide. With the probe normal to the phantom surface, the peak spatial average SAR is measured and compared to the analytical value at the surface.

## 4 MEASUREMENT UNCERTAINTY

The guidelines outlined in the IEEE 1528, OET 65 Bulletin C, CENELEC EN50361 and CEI/IEC 62209 standards were followed to generate the measurement uncertainty associated with an E-field probe calibration using the waveguide technique. All uncertainties listed below represent an expanded uncertainty expressed at approximately the 95% confidence level using a coverage factor of k=2, traceable to the Internationally Accepted Guides to Measurement Uncertainty.

Uncertainty analysis of the probe calibration in waveguide					
ERROR SOURCES	Uncertainty value (%)	Probability Distribution	Divisor	ci	Standard Uncertainty (%)
Incident or forward power	3.00%	Rectangular	$\sqrt{3}$	1	1.732%
Reflected power	3.00%	Rectangular	$\sqrt{3}$		1.732%
Liquid conductivity	5.00%	Rectangular	$\sqrt{3}$		2.887%
Liquid permittivity	4.00%	Rectangular	$\sqrt{3}$		2.309%
Field homogeneity	3.00%	Rectangular	$\sqrt{3}$		1.732%
Field probe positioning	5.00%	Rectangular	$\sqrt{3}$		2.887%



COMOSAR E-FIELD PROBE CALIBRATION REPORT

Ref: ACR.264.3.16.SATU.A

Field probe linearity	3.00%	Rectangular	$\sqrt{3}$	1	1.732%
<b>Combined standard uncertainty</b>					5.831%
<b>Expanded uncertainty</b> 95 % confidence level k = 2					12.0%

5 CALIBRATION MEASUREMENT RESULTS

Calibration Parameters	
Liquid Temperature	21 °C
Lab Temperature	21 °C
Lab Humidity	45 %

5.1 SENSITIVITY IN AIR

Normx dipole 1 ( $\mu\text{V}/(\text{V}/\text{m})^2$ )	Normy dipole 2 ( $\mu\text{V}/(\text{V}/\text{m})^2$ )	Normz dipole 3 ( $\mu\text{V}/(\text{V}/\text{m})^2$ )
0.80	0.71	0.72

DCP dipole 1 (mV)	DCP dipole 2 (mV)	DCP dipole 3 (mV)
92	90	91

Calibration curves  $e_i=f(V)$  ( $i=1,2,3$ ) allow to obtain H-field value using the formula:

$$E = \sqrt{E_1^2 + E_2^2 + E_3^2}$$

