

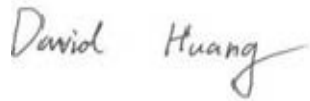

RF TEST REPORT



Report No.: 16070559-FCC-R1

Supersede Report No.: N/A

Applicant	MFOURTEL MEXICO S.A. DE C.V.	
Product Name	LTE Mobile Phone	
Model No.	M4 SS4450	
Serial No.	N/A	
Test Standard	FCC Part 22(H):2015 ;FCC Part 24(E):2015; ANSI/TIA-603-D: 2010	
Test Date	June 07 to 24, 2016	
Issue Date	June 25, 2016	
Test Result	<input checked="" type="checkbox"/> Pass <input type="checkbox"/> Fail	
Equipment complied with the specification	<input checked="" type="checkbox"/>	
Equipment did not comply with the specification	<input type="checkbox"/>	
		
Loren Luo Test Engineer	David Huang Checked By	
This test report may be reproduced in full only Test result presented in this test report is applicable to the tested sample only		

Issued by:

SIEMIC (SHENZHEN-CHINA) LABORATORIES

Zone A, Floor 1, Building 2 Wan Ye Long Technology Park

South Side of Zhoushi Road, Bao' an District, Shenzhen, Guangdong China 518108

Phone: +86 0755 2601 4629801 Email: China@siemic.com.cn

Laboratories Introduction

SIEMIC, headquartered in the heart of Silicon Valley, with superior facilities in US and Asia, is one of the leading independent testing and certification facilities providing customers with one-stop shop services for Compliance Testing and Global Certifications.



In addition to testing and certification, SIEMIC provides initial design reviews and compliance management throughout a project. Our extensive experience with China, Asia Pacific, North America, European, and International compliance requirements, assures the fastest, most cost effective way to attain regulatory compliance for the global markets.

Accreditations for Conformity Assessment

Country/Region	Scope
USA	EMC, RF/Wireless, SAR, Telecom
Canada	EMC, RF/Wireless, SAR, Telecom
Taiwan	EMC, RF, Telecom, SAR, Safety
Hong Kong	RF/Wireless, SAR, Telecom
Australia	EMC, RF, Telecom, SAR, Safety
Korea	EMI, EMS, RF, SAR, Telecom, Safety
Japan	EMI, RF/Wireless, SAR, Telecom
Singapore	EMC, RF, SAR, Telecom
Europe	EMC, RF, SAR, Telecom, Safety

Test Report	16070559-FCC-R1
Page	3 of 88

This page has been left blank intentionally.

CONTENTS

1. REPORT REVISION HISTORY	5
2. CUSTOMER INFORMATION	5
3. TEST SITE INFORMATION.....	5
4. EQUIPMENT UNDER TEST (EUT) INFORMATION.....	6
5. TEST SUMMARY	10
6. MEASUREMENTS, EXAMINATION AND DERIVED RESULTS	11
6.1 RF EXPOSURE (SAR).....	11
6.2 RF OUTPUT POWER.....	12
6.3 PEAK-AVERAGE RATIO.....	24
6.4 OCCUPIED BANDWIDTH.....	28
6.5 SPURIOUS EMISSIONS AT ANTENNA TERMINALS.....	39
6.6 SPURIOUS RADIATED EMISSIONS.....	52
6.7 BAND EDGE.....	58
6.8 FREQUENCY STABILITY	68
ANNEX A. TEST INSTRUMENT.....	76
ANNEX B. EUT AND TEST SETUP PHOTOGRAPHS.....	78
ANNEX C. TEST SETUP AND SUPPORTING EQUIPMENT.....	84
ANNEX C.II. EUT OPERATING CONKITIONS.....	86
ANNEX D. USER MANUAL / BLOCK DIAGRAM / SCHEMATICS / PARTLIST.....	87
ANNEX E. DECLARATION OF SIMILARITY.....	88

1. Report Revision History

Report No.	Report Version	Description	Issue Date
16070559-FCC-R1	NONE	Original	June 25, 2016

2. Customer information

Applicant Name	MFOURTEL MEXICO S.A. DE C.V.
Applicant Add	Av. Ejercito Nacional 436 Piso 3 Chapultepec Morales Miguel Hidalgo D.F 11570
Manufacturer	CK Telecom Limited
Manufacturer Add	Technology Road.High-Tech Development Zone. Heyuan, Guangdong,P.R.China.

3. Test site information

Lab performing tests	SIEMIC (Shenzhen-China) LABORATORIES
Lab Address	Zone A, Floor 1, Building 2 Wan Ye Long Technology Park South Side of Zhoushi Road, Bao' an District, Shenzhen, Guangdong China 518108
FCC Test Site No.	718246
IC Test Site No.	4842E-1
Test Software	Radiated Emission Program-To Shenzhen v2.0

4. Equipment under Test (EUT) Information

Description of EUT:	LTE Mobile Phone
Main Model:	M4 SS4450
Serial Model:	N/A
Date EUT received:	June 06, 2016
Test Date(s):	June 07 to 24, 2016
Equipment Category :	PCE
Antenna Gain:	GSM850: -3.5dBi PCS1900: -3.5dBi UMTS-FDD Band 5: -3.5dBi UMTS-FDD Band 2: -3.5dBi LTE Band 2: -3.5dBi LTE Band 4: -3.5dBi LTE Band 7: -5.5dBi LTE Band 17: -6.5dBi Bluetooth/BLE/WIFI:-3.5dBi GPS: -2.5dBi
Antenna Type:	PIFA antenna
Type of Modulation:	GSM / GPRS: GMSK EGPRS: GMSK,8PSK UMTS-FDD: QPSK LTE Band: QPSK, 16QAM 802.11b/g/n: DSSS, OFDM Bluetooth: GFSK, π /4DQPSK, 8DPSK BLE: GFSK GPS:BPSK

RF Operating Frequency (ies):

GSM850 TX: 824.2 ~ 848.8 MHz; RX: 869.2 ~ 893.8 MHz
 PCS1900 TX: 1850.2 ~ 1909.8 MHz; RX: 1930.2 ~ 1989.8 MHz
 UMTS-FDD Band 5 TX: 826.4 ~ 846.6 MHz; RX: 871.4 ~ 891.6 MHz
 UMTS-FDD Band 2 TX: 1852.4 ~ 1907.6 MHz;
 RX: 1932.4 ~ 1987.6 MHz
 LTE Band 2 TX: 1852.5 ~ 1907.5 MHz; RX : 1932.5 ~ 1987.5 MHz
 LTE Band 4 TX: 1712.5 ~ 1752.5 MHz; RX : 2112.5 ~ 2152.5 MHz
 LTE Band 7 TX: 2502.5 ~ 2567.5 MHz; RX : 2622.5 ~ 2687.5 MHz
 LTE Band 17 TX: 706.5 ~ 713.5 MHz; RX : 736.5 ~ 743.5 MHz
 WIFI: 802.11b/g/n(20M): 2412-2462 MHz
 WIFI: 802.11n(40M): 2422-2452 MHz
 Bluetooth& BLE: 2402-2480 MHz
 GPS: 1575.42 MHz

Maximum Conducted
 AV Power to Antenna:

GSM Voice:GSM850: 32.18 dBm
 PCS1900: 28.80 dBm
 GPRS:GSM850: 32.12 dBm
 PCS1900: 28.74 dBm
 MCS1:GSM850: 32.07 dBm
 PCS1900: 28.68 dBm
 MCS5:GSM850: 26.70 dBm
 PCS1900: 25.47 dBm
 RMC:UMTS-FDD Band 5: 21.59 dBm
 UMTS-FDD Band 2: 20.32dBm
 HSUPA:UMTS-FDD Band 5: 21.42dBm
 UMTS-FDD Band 2: 21.41 dBm
 HSDPA:UMTS-FDD Band 5: 21.11dBm
 UMTS-FDD Band 2: 21.43 dBm

ERP/EIRP:

GSM Voice:GSM850: 26.54 dBm / ERP
 PCS1900: 25.46 dBm / EIRP
 GPRS:GSM850: 26.30 dBm / ERP
 PCS1900: 25.24 dBm / EIRP
 EGPRS:GSM850: 23.16 dBm / ERP
 PCS1900: 23.15 dBm / EIRP
 RMC:UMTS-FDD Band 5: 16.05 dBm / ERP
 UMTS-FDD Band 2: 16.97 dBm / EIRP
 HSUPA:UMTS-FDD Band 5: 16.28 dBm / ERP
 UMTS-FDD Band 2: 16.73 dBm / EIRP
 HSDPA:UMTS-FDD Band 5: 16.32 dBm / ERP
 UMTS-FDD Band 2: 16.84 dBm / EIRP

Number of Channels:

GSM 850: 124CH
 PCS1900: 299CH
 UMTS-FDD Band 5: 102CH
 UMTS-FDD Band 2: 277CH
 WIFI :802.11b/g/n(20M): 11CH
 WIFI :802.11n(40M): 7CH
 Bluetooth: 79CH
 BLE: 40CH
 GPS:1CH

Port: Power Port, Earphone Port, USB Port

Input Power:

Adapter:
 Model: A8-501000
 Input: AC100-240V,50/60Hz;150mA
 Output: DC 5.0V,1000mA(5.00Wh)
 Battery:
 Model: M2250A
 Spec: 3.7V,2250mAh(8.33Wh)
 Charge limited voltage: 4.2V

Trade Name : M4

Test Report	16070559-FCC-R1
Page	9 of 88

GPRS/EGPRS Multi-slot class 8/10/12

FCC ID: CLNSS4450

5. Test Summary

The product was tested in accordance with the following specifications.

All testing has been performed according to below product classification:

FCC Rules	Description of Test	Result
§ 1.1307; § 2.1093	RF Exposure (SAR)	Compliance
§2.1046; § 22.913(a); § 24.232(c); § 27.50(c.10) ;	RF Output Power	Compliance
§ 24.232 (d) ;	Peak-Average Ratio	Compliance
§ 2.1049; § 22.905; § 22.917; § 24.238;	99% & -26 dB Occupied Bandwidth	Compliance
§ 2.1051; § 22.917(a); § 24.238(a);	Spurious Emissions at Antenna Terminal	Compliance
§ 2.1053; § 22.917(a); § 24.238(a);	Field Strength of Spurious Radiation	Compliance
§ 22.917(a); § 24.238(a);	Out of band emission, Band Edge	Compliance
§ 2.1055; § 22.355; § 24.235;	Frequency stability vs. temperature Frequency stability vs. voltage	Compliance

Note: Testing was performed by configuring EUT to maximum output power status, the declared output power class for different

Measurement Uncertainty

Emissions		
Test Item	Description	Uncertainty
Band Edge and Radiated Spurious Emissions	Confidence level of approximately 95% (in the case where distributions are normal), with a coverage factor of 2 (for EUTs < 0.5m X 0.5m X 0.5m)	+5.6dB/-4.5dB
-	-	-

6. MEASUREMENTS, EXAMINATION AND DERIVED RESULTS

6.1 RF Exposure (SAR)

Test Result: Pass

The EUT is a portable device, thus requires SAR evaluation;

Please refer to RF Exposure Evaluation Report: 16070559-FCC-H.

6.2 RF Output Power

Temperature	25°C
Relative Humidity	53%
Atmospheric Pressure	1020mbar
Test date :	June 20, 2016
Tested By :	Loren Luo

Requirement(s):

Spec	Item	Requirement	Applicable
§22.913 (a)	a)	ERP:38.45dBm	<input checked="" type="checkbox"/>
§24.232 (c)	b)	EIRP:33dBm	<input checked="" type="checkbox"/>

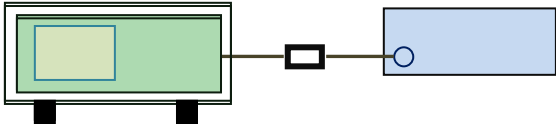
Test Setup	
------------	---

Test Procedure	<p>For Conducted Power:</p> <ul style="list-style-type: none"> - The transmitter output port was connected to base station. - Set EUT at maximum power through base station. - Select lowest, middle, and highest channels for each band and different test mode. <p>For ERP/EIRP:</p> <p>According with KDB 971168 v02r02</p> <ul style="list-style-type: none"> - The transmitter was placed on a wooden turntable, and it was transmitting into a non-radiating load which was also placed on the turntable. - The measurement antenna was placed at a distance of 3 meters from the EUT. During the tests, the antenna height and polarization as well as EUT azimuth were varied in order to identify the maximum level of emissions from the EUT. The test was performed by placing the EUT on 3-orthogonal axis. - The frequency range up to tenth harmonic of the fundamental frequency was investigated.
----------------	---

Test Report	16070559-FCC-R1
Page	13 of 88

	<ul style="list-style-type: none"> - Remove the EUT and replace it with substitution antenna. A signal generator was connected to the substitution antenna by a non-radiating cable. The absolute levels of the spurious emissions were measured by the substitution. - Spurious emissions in dB = 10 log (TX power in Watts/0.001) – the absolute level - Spurious attenuation limit in dB = 43 + 10 Log10 (power out in Watts).
Remark	
Result	<input checked="" type="checkbox"/> Pass <input type="checkbox"/> Fail

Test Data Yes N/A
Test Plot Yes (See below) N/A

Conducted Power

GSM Mode:

Burst Average Power (dBm);								
Band	GSM850				PCS1900			
Channel	128	190	251	Tune up Power tolerant	512	661	810	Tune up Power tolerant
Frequency (MHz)	824.2	836.6	848.8	/	1850.2	1880	1909.8	/
GSM Voice (1 uplink),GMSK	32.18	32.05	32.02	32±1	28.77	28.80	28.76	28.5±1
GPRS Multi-Slot Class 8 (1 uplink),GMSK	32.12	32.00	32.02	32±1	28.64	28.74	28.72	28.5±1
GPRS Multi-Slot Class 10 (2 uplink) GMSK	30.68	30.56	30.57	30.5±1	27.35	27.31	27.35	27±1
GPRS Multi-Slot Class 12 (4 uplink) GMSK	28.51	28.39	28.35	28±1	23.99	24.48	24.67	24.5±1
EGPRS Multi-Slot Class 8 (1 uplink) GMSK MCS1	32.07	31.98	31.95	32±1	28.56	28.68	28.67	28.5±1
EGPRS Multi-Slot Class 10 (2 uplink) GMSK MCS1	30.64	30.51	30.54	30.5±1	27.30	27.47	27.59	27.5±1
EGPRS Multi-Slot Class 12 (4 uplink) GMSK MCS1	28.52	28.40	28.36	28±1	24.36	24.51	24.68	24.5±1
EGPRS Multi-Slot Class 8 (1 uplink) 8PSK MCS5	26.70	26.64	26.53	26.5±1	25.24	25.26	25.47	25±1
EGPRS Multi-Slot Class 10 (2 uplink) 8PSK MCS5	24.78	24.75	24.52	24.5±1	23.14	23.18	23.22	23±1
EGPRS Multi-Slot Class 12 (4 uplink) 8PSK MCS5	21.73	21.68	21.54	21.5±1	19.74	19.68	19.93	19.5±1

Test Report	16070559-FCC-R1
Page	15 of 88

Remark :

GPRS, CS1 coding scheme.

EGPRS, MCS1 coding scheme.

EGPRS, MCS5 coding scheme.

Multi-Slot Class 8 , Support Max 4 downlink, 1 uplink , 5 working link

Multi-Slot Class 10 , Support Max 4 downlink, 2 uplink , 5 working link

Multi-Slot Class 12 , Support Max 4 downlink, 4 uplink , 5 working link

UMTS Mode:

UMTS-FDD Band V

Band/ Time Slot configuration	Channel	Frequency	Average power (dBm)	Tune up Power tolerant
RMC 12.2kbps	4132	826.4	21.25	21±1
	4175	835	21.23	21±1
	4233	846.6	21.59	21±1
HSDPA Subtest1	4132	826.4	21.36	20.5±1
	4175	835	21.42	20.5±1
	4233	846.6	21.26	20.5±1
HSDPA Subtest2	4132	826.4	20.96	20.5±1
	4175	835	21.15	20.5±1
	4233	846.6	19.96	20.5±1
HSDPA Subtest3	4132	826.4	21.19	20.5±1
	4175	835	20.98	20.5±1
	4233	846.6	20.56	20.5±1
HSDPA Subtest4	4132	826.4	20.36	20.5±1
	4175	835	20.56	20.5±1
	4233	846.6	20.42	20.5±1
HSUPA Subtest1	4132	826.4	20.41	20.5±1
	4175	835	20.03	20.5±1
	4233	846.6	20.93	20.5±1
HSUPA Subtest2	4132	826.4	21.00	20.5±1
	4175	835	20.66	20.5±1
	4233	846.6	20.46	20.5±1
HSUPA Subtest3	4132	826.4	21.09	20.5±1
	4175	835	20.69	20.5±1
	4233	846.6	21.11	20.5±1
HSUPA Subtest4	4132	826.4	21.05	20.5±1
	4175	835	20.36	20.5±1
	4233	846.6	20.00	20.5±1
HSUPA Subtest5	4132	826.4	19.36	20.5±1
	4175	835	19.69	20.5±1
	4233	846.6	20.55	20.5±1

UMTS-FDD Band II

Band/ Time Slot configuration	Channel	Frequency	Average power (dBm)	Tune up Power tolerant
RMC 12.2kbps	9262	1852.4	20.31	20.5±1
	9400	1880	20.32	20.5±1
	9538	1907.6	20.30	20.5±1
HSDPA Subtest1	9262	1852.4	20.36	20.5±1
	9400	1880	21.41	20.5±1
	9538	1907.6	20.56	20.5±1
HSDPA Subtest2	9262	1852.4	20.45	20.5±1
	9400	1880	21.32	20.5±1
	9538	1907.6	20.96	20.5±1
HSDPA Subtest3	9262	1852.4	20.31	20.5±1
	9400	1880	21.06	20.5±1
	9538	1907.6	21.22	20.5±1
HSDPA Subtest4	9262	1852.4	21.07	20.5±1
	9400	1880	20.96	20.5±1
	9538	1907.6	20.63	20.5±1
HSUPA Subtest1	9262	1852.4	20.42	20.5±1
	9400	1880	20.45	20.5±1
	9538	1907.6	21.05	20.5±1
HSUPA Subtest2	9262	1852.4	21.00	20.5±1
	9400	1880	20.32	20.5±1
	9538	1907.6	21.36	20.5±1
HSUPA Subtest3	9262	1852.4	20.12	20.5±1
	9400	1880	21.43	20.5±1
	9538	1907.6	20.60	20.5±1
HSUPA Subtest4	9262	1852.4	20.59	20.5±1
	9400	1880	21.43	20.5±1
	9538	1907.6	21.26	20.5±1
HSUPA Subtest5	9262	1852.4	21.06	20.5±1
	9400	1880	21.33	20.5±1
	9538	1907.6	21.36	20.5±1

ERP & EIRP

GSM Voice

ERP for Cellular Band (Part 22H)

Frequency (MHz)	Substituted level (dBm)	Antenna Polarization	Antenna Gain correction (dBi)	Cable Loss (dB)	Absolute Level (dBm)	Limit (dBm)
824.2	20.14	V	6.8	0.53	26.41	38.45
824.2	19.39	H	6.8	0.53	25.66	38.45
836.6	20.21	V	6.8	0.53	26.48	38.45
836.6	19.45	H	6.8	0.53	25.72	38.45
848.8	20.17	V	6.9	0.53	26.54	38.45
848.8	19.31	H	6.9	0.53	25.68	38.45

EIRP for PCS Band (Part 24E)

Frequency (MHz)	Substituted level (dBm)	Antenna Polarization	Antenna Gain correction (dBi)	Cable Loss (dB)	Absolute Level (dBm)	Limit (dBm)
1850.2	18.38	V	7.88	0.85	25.41	33
1850.2	17.84	H	7.88	0.85	24.87	33
1880	18.41	V	7.88	0.85	25.44	33
1880	17.88	H	7.88	0.85	24.91	33
1909.8	18.45	V	7.86	0.85	25.46	33
1909.8	17.92	H	7.86	0.85	24.93	33

GPRS:

ERP for Cellular Band (Part 22H)

Frequency (MHz)	Substituted level (dBm)	Antenna Polarization	Antenna Gain correction (dBi)	Cable Loss (dB)	Absolute Level (dBm)	Limit (dBm)
824.2	19.88	V	6.8	0.53	26.15	38.45
824.2	19.35	H	6.8	0.53	25.62	38.45
836.6	19.81	V	6.8	0.53	26.08	38.45
836.6	19.27	H	6.8	0.53	25.54	38.45
848.8	19.93	V	6.9	0.53	26.30	38.45
848.8	19.34	H	6.9	0.53	25.71	38.45

EIRP for PCS Band (Part 24E)

Frequency (MHz)	Substituted level (dBm)	Antenna Polarization	Antenna Gain correction (dBi)	Cable Loss (dB)	Absolute Level (dBm)	Limit (dBm)
1850.2	18.17	V	7.88	0.85	25.20	33
1850.2	17.63	H	7.88	0.85	24.66	33
1880	18.21	V	7.88	0.85	25.24	33
1880	17.68	H	7.88	0.85	24.71	33
1909.8	18.14	V	7.86	0.85	25.15	33
1909.8	17.65	H	7.86	0.85	24.66	33

EGPRS (MCS5):

ERP for Cellular Band (Part 22H)

Frequency (MHz)	Substituted level (dBm)	Antenna Polarization	Antenna Gain correction (dBi)	Cable Loss (dB)	Absolute Level (dBm)	Limit (dBm)
824.2	16.78	V	6.8	0.53	23.05	38.45
824.2	16.42	H	6.8	0.53	22.69	38.45
836.6	16.83	V	6.8	0.53	23.10	38.45
836.6	16.37	H	6.8	0.53	22.64	38.45
848.8	16.79	V	6.9	0.53	23.16	38.45
848.8	16.41	H	6.9	0.53	22.78	38.45

EIRP for PCS Band (Part 24E)

Frequency (MHz)	Substituted level (dBm)	Antenna Polarization	Antenna Gain correction (dBi)	Cable Loss (dB)	Absolute Level (dBm)	Limit (dBm)
1850.2	16.04	V	7.88	0.85	23.07	33
1850.2	15.59	H	7.88	0.85	22.62	33
1880	16.12	V	7.88	0.85	23.15	33
1880	15.64	H	7.88	0.85	22.67	33
1909.8	16.08	V	7.86	0.85	23.09	33
1909.8	15.57	H	7.86	0.85	22.58	33

RMC

ERP for UMTS-FDD Band V (Part 22H)

Frequency (MHz)	Substituted level (dBm)	Antenna Polarization	Antenna Gain correction (dBi)	Cable Loss (dB)	Absolute Level (dBm)	Limit (dBm)
826.4	9.67	V	6.8	0.53	15.94	38.45
826.4	9.13	H	6.8	0.53	15.40	38.45
835	9.74	V	6.8	0.53	16.01	38.45
835	9.09	H	6.8	0.53	15.36	38.45
846.6	9.68	V	6.9	0.53	16.05	38.45
846.6	9.11	H	6.9	0.53	15.48	38.45

EIRP for UMTS-FDD Band II (Part 24E)

Frequency (MHz)	Substituted level (dBm)	Antenna Polarization	Antenna Gain correction (dBi)	Cable Loss (dB)	Absolute Level (dBm)	Limit (dBm)
1852.4	9.86	V	7.88	0.85	16.89	33
1852.4	9.33	H	7.88	0.85	16.36	33
1880	9.91	V	7.88	0.85	16.94	33
1880	9.37	H	7.88	0.85	16.40	33
1907.6	9.96	V	7.86	0.85	16.97	33
1907.6	9.42	H	7.86	0.85	16.43	33

HSDPA

ERP for UMTS-FDD Band V (Part 22H)

Frequency (MHz)	Substituted level (dBm)	Antenna Polarization	Antenna Gain correction (dBi)	Cable Loss (dB)	Absolute Level (dBm)	Limit (dBm)
826.4	9.78	V	6.8	0.53	16.05	38.45
826.4	9.22	H	6.8	0.53	15.49	38.45
835	9.83	V	6.8	0.53	16.10	38.45
835	9.27	H	6.8	0.53	15.54	38.45
846.6	9.91	V	6.9	0.53	16.28	38.45
846.6	9.35	H	6.9	0.53	15.72	38.45

EIRP for UMTS-FDD Band II (Part 24E)

Frequency (MHz)	Substituted level (dBm)	Antenna Polarization	Antenna Gain correction (dBi)	Cable Loss (dB)	Absolute Level (dBm)	Limit (dBm)
1852.4	9.68	V	7.88	0.85	16.71	33
1852.4	9.13	H	7.88	0.85	16.16	33
1880	9.64	V	7.88	0.85	16.67	33
1880	9.07	H	7.88	0.85	16.10	33
1907.6	9.72	V	7.86	0.85	16.73	33
1907.6	9.14	H	7.86	0.85	16.15	33

HSUPA

ERP for UMTS-FDD Band V (Part 22H)

Frequency (MHz)	Substituted level (dBm)	Antenna Polarization	Antenna Gain correction (dBi)	Cable Loss (dB)	Absolute Level (dBm)	Limit (dBm)
826.4	9.85	V	6.8	0.53	16.12	38.45
826.4	9.33	H	6.8	0.53	15.60	38.45
835	9.91	V	6.8	0.53	16.18	38.45
835	9.36	H	6.8	0.53	15.63	38.45
846.6	9.95	V	6.9	0.53	16.32	38.45
846.6	9.42	H	6.9	0.53	15.79	38.45

EIRP for UMTS-FDD Band II (Part 24E)

Frequency (MHz)	Substituted level (dBm)	Antenna Polarization	Antenna Gain correction (dBi)	Cable Loss (dB)	Absolute Level (dBm)	Limit (dBm)
1852.4	9.74	V	7.88	0.85	16.77	33
1852.4	9.18	H	7.88	0.85	16.21	33
1880	9.81	V	7.88	0.85	16.84	33
1880	9.22	H	7.88	0.85	16.25	33
1907.6	9.78	V	7.86	0.85	16.79	33
1907.6	9.15	H	7.86	0.85	16.16	33

6.3 Peak-Average Ratio

Temperature	25°C
Relative Humidity	53%
Atmospheric Pressure	1020mbar
Test date :	June 20, 2016
Tested By :	Loren Luo

Requirement(s):

Spec	Item	Requirement	Applicable
§24.232(d)	a)	The peak-to-average ratio (PAR) of the transmission may not exceed 13dB.	<input checked="" type="checkbox"/>

Test Setup	
------------	--

Test Procedure	<p>According with KDB 971168 v02r02</p> <p>5.7.2 Alternate procedure for PAPR</p> <p>5.1.2 Peak power measurements with a peak power meter</p> <p>The total peak output power may be measured using a broadband peak RF power meter. The power meter must have a video bandwidth that is greater than or equal to the emission bandwidth and utilize a fast-responding diode detector.</p> <p>5.2.3 Average power measurement with average power meter</p> <p>As an alternative to the use of a spectrum/signal analyzer or EMI receiver to perform a measurement of the total in-band average output power, a wideband RF average power meter with a thermocouple detector or equivalent can be used under certain conditions</p> <p>If the EUT can be configured to transmit continuously (i.e., the burst duty cycle $\geq 98\%$) and at all times the EUT is transmitting at its maximum output</p>
----------------	--

Test Report	16070559-FCC-R1
Page	25 of 88

	<p>power level, then a conventional wide-band RF power meter can be used.</p> <p>If the EUT cannot be configured to transmit continuously (i.e., the burst duty cycle < 98%), then there are two options for the use of an average power meter. First, a gated average power meter can be used to perform the measurement if the gating parameters can be adjusted such that the power is measured only over active transmission bursts at maximum output power levels. A conventional average power meter can also be used if the measured burst duty cycle is constant (i.e., duty cycle variations are less than ± 2 percent) by performing the measurement over the on/off burst cycles and then correcting (increasing) the measured level by a factor equal to $10\log(1/\text{duty cycle})$</p>
Remark	
Result	<input checked="" type="checkbox"/> Pass <input type="checkbox"/> Fail

Test Data Yes N/A
Test Plot Yes (See below) N/A

GSM : GSM 1900 PK-AV POWER (PART 24E)

Frequency (MHz)	Conducted power(dBm)		Peak-Average Ratio(PAR)
	Peak	Average	
1850.2	31.09	28.77	2.32
1880	30.25	28.8	1.45
1909.8	30	28.76	1.24

GPRS 1900 PK-AV POWER (PART 24E)

Frequency (MHz)	Conducted power(dBm)		Peak-Average Ratio(PAR)
	Peak	Average	
1850.2	31.12	28.64	2.48
1880	30.68	28.74	1.94
1909.8	30.79	28.72	2.07

EGPRS (MSC5) 1900 PK-AV POWER (PART 24E)

Frequency (MHz)	Conducted power(dBm)		Peak-Average Ratio(PAR)
	Peak	Average	
1850.2	29.54	25.24	4.30
1880	29.32	25.26	4.06
1909.8	29.3	25.47	3.83

RMC : UMTS-FDD Band 2 PK-AV POWER (PART 24E)

Frequency (MHz)	Conducted power(dBm)		Peak-Average Ratio(PAR)
	Peak	Average	
1852.4	25	20.31	4.69
1880	25.45	20.32	5.13
1907.6	25.59	20.3	5.29

HSUPA : UMTS-FDD Band 2 PK-AV POWER (PART 24E)

Frequency (MHz)	Conducted power(dBm)		Peak-Average Ratio(PAR)
	Peak	Average	
1852.4	25.32	20.42	4.90
1880	25.01	20.45	4.56
1907.6	25.96	21.05	4.91

HSDPA : UMTS-FDD Band 2 PK-AV POWER (PART 24E)

Frequency (MHz)	Conducted power(dBm)		Peak-Average Ratio(PAR)
	Peak	Average	
1852.4	24.95	20.36	4.59
1880	25.33	21.41	3.92
1907.6	25.49	20.56	4.93

6.4 Occupied Bandwidth

Temperature	25°C
Relative Humidity	53%
Atmospheric Pressure	1020mbar
Test date :	June 20, 2016
Tested By :	Loren Luo

Requirement(s):

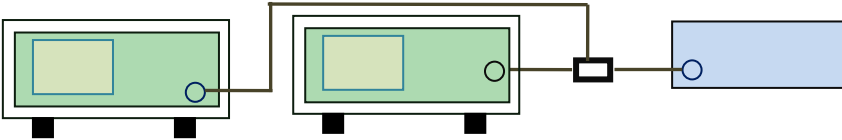
Spec	Item	Requirement	Applicable
§2.1049, §22.917, §22.905 §24.238	a)	99% Occupied Bandwidth(kHz)	<input checked="" type="checkbox"/>
	b)	26 dB Bandwidth(kHz)	<input checked="" type="checkbox"/>
Test Setup			
Test Procedure	<ul style="list-style-type: none"> - The EUT was connected to Spectrum Analyzer and Base Station via power divider. - The 99% and 26 dB occupied bandwidth (BW) of the middle channel for the highest RF powers. 		
Remark			
Result	<input checked="" type="checkbox"/> Pass <input type="checkbox"/> Fail		

Test Data Yes N/A

Test Plot Yes (See below) N/A

GSM Voice:

Cellular Band (Part 22H) result

Channel	Frequency (MHz)	99% Occupied Bandwidth (kHz)	26 dB Bandwidth (kHz)
128	824.2	246.67	318.1
190	836.6	255.20	321.0
251	848.8	252.43	327.8

PCS Band (Part 24E) result

Channel	Frequency (MHz)	99% Occupied Bandwidth (kHz)	26 dB Bandwidth (kHz)
512	1850.2	245.72	319.4
661	1880.0	245.09	320.5
810	1909.8	246.81	325.4

GPRS:

Cellular Band (Part 22H) result

Channel	Frequency (MHz)	99% Occupied Bandwidth (kHz)	26 dB Bandwidth (kHz)
128	824.2	253.14	324.4
190	836.6	252.27	328.8
251	848.8	250.82	320.3

PCS Band (Part 24E) result

Channel	Frequency (MHz)	99% Occupied Bandwidth (kHz)	26 dB Bandwidth (kHz)
512	1850.2	244.13	319.5
661	1880.0	247.46	321.8
810	1909.8	250.26	317.7

EGPRS (MCS 5):

Cellular Band (Part 22H) result

Channel	Frequency (MHz)	99% Occupied Bandwidth (kHz)	26 dB Bandwidth (kHz)
128	824.2	250.91	319.6
190	836.6	254.61	326.0
251	848.8	250.17	328.5

PCS Band (Part 24E) result

Channel	Frequency (MHz)	99% Occupied Bandwidth (kHz)	26 dB Bandwidth (kHz)
512	1850.2	244.83	318.5
661	1880.0	247.48	319.1
810	1909.8	246.38	318.7

RMC:

UMTS-FDD Band V (Part 22H)

Channel	Frequency (MHz)	99% Occupied Bandwidth (MHz)	26 dB Bandwidth (MHz)
4132	826.4	4.4385	5.054
4175	835.0	4.4516	5.046
4233	846.6	4.4782	6.886

UMTS-FDD Band II (Part 24E)

Channel	Frequency (MHz)	99% Occupied Bandwidth (MHz)	26 dB Bandwidth (MHz)
9262	1852.4	4.3363	4.961
9400	1880.0	4.3435	4.934
9538	1907.6	4.3460	4.983

HSUPA:

UMTS-FDD Band V (Part 22H)

Channel	Frequency (MHz)	99% Occupied Bandwidth (MHz)	26 dB Bandwidth (MHz)
4132	826.4	4.4499	5.089
4175	835.0	4.4396	5.042
4233	846.6	4.4752	6.914

UMTS-FDD Band II (Part 24E)

Channel	Frequency (MHz)	99% Occupied Bandwidth (MHz)	26 dB Bandwidth (MHz)
9262	1852.4	4.3459	4.971
9400	1880.0	4.3535	4.946
9538	1907.6	4.3495	4.961

HSDPA:

UMTS-FDD Band V (Part 22H)

Channel	Frequency (MHz)	99% Occupied Bandwidth (MHz)	26 dB Bandwidth (MHz)
4132	826.4	4.4503	5.073
4175	835.0	4.4324	5.079
4233	846.6	4.4680	6.635

UMTS-FDD Band II (Part 24E)

Channel	Frequency (MHz)	99% Occupied Bandwidth (MHz)	26 dB Bandwidth (MHz)
9262	1852.4	4.3481	4.982
9400	1880.0	4.3539	4.964
9538	1907.6	4.3477	4.960

Test Plots

GMS Voice:

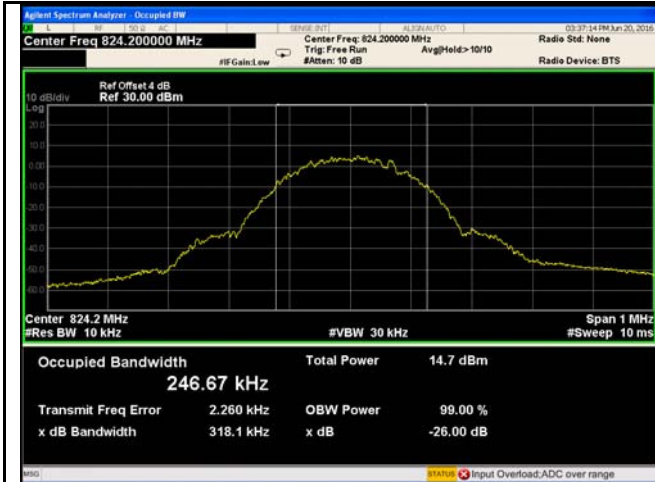

GSM 850 BW - Low CH 824.2MHz



GSM 850 BW - Mid CH 836.6MHz



GSM 850 BW - High CH 848.8MHz



PCS 1900 BW - Low CH 1850.2MHz

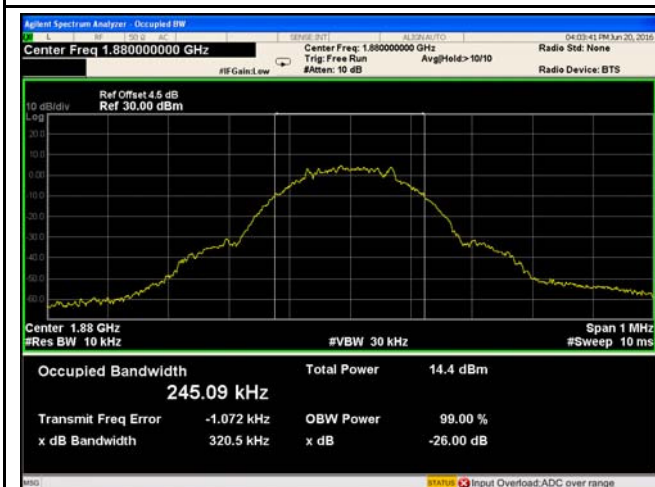

PCS 1900 BW - Mid CH 1880MHz

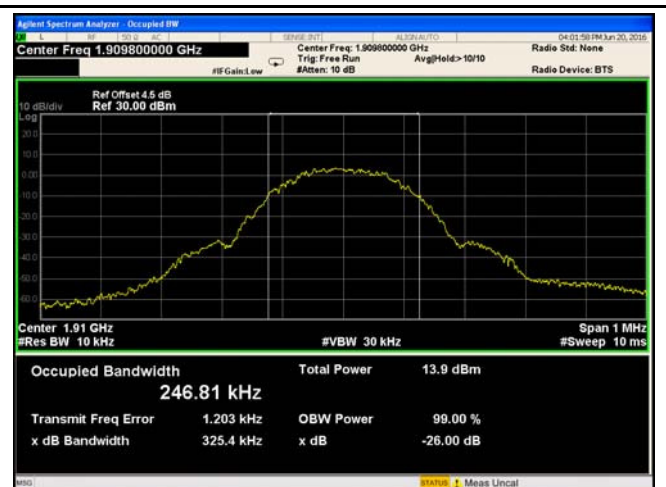

PCS 1900 BW - High CH 1909.8MHz

GPRS:

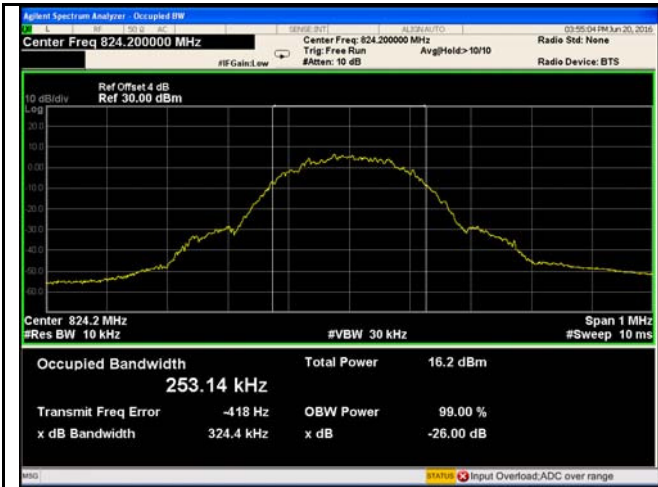

GSM 850 BW - Low CH 824.2MHz

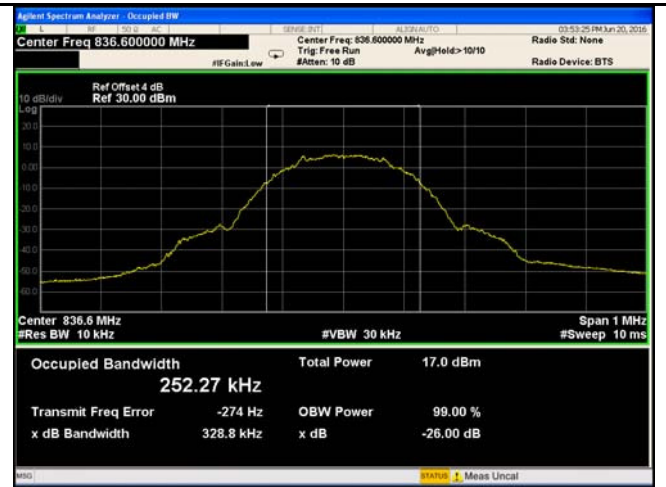

GSM 850 BW - Mid CH 836.6MHz

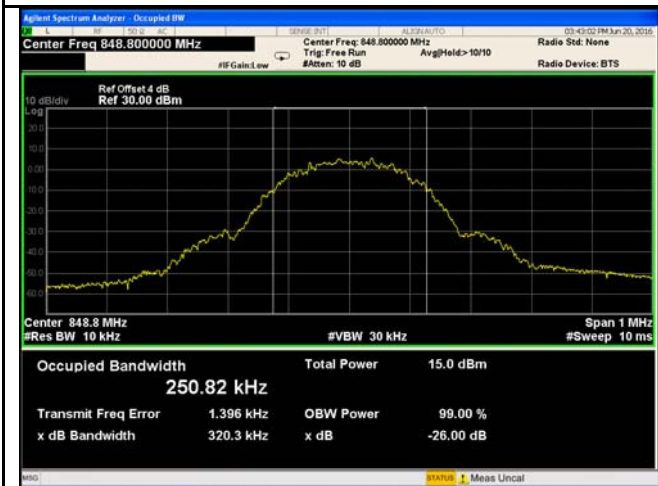

GSM 850 BW - High CH 848.8MHz



PCS 1900 BW - Low CH 1850.2MHz

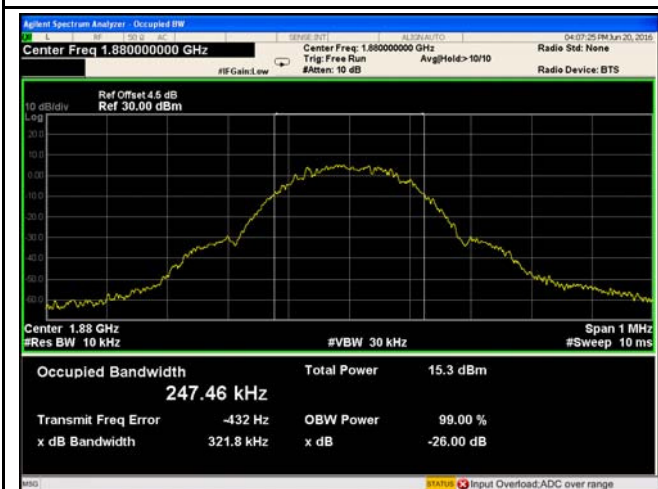

PCS 1900 BW - Mid CH 1880MHz



PCS 1900 BW - High CH 1909.8MHz

EGPRS:

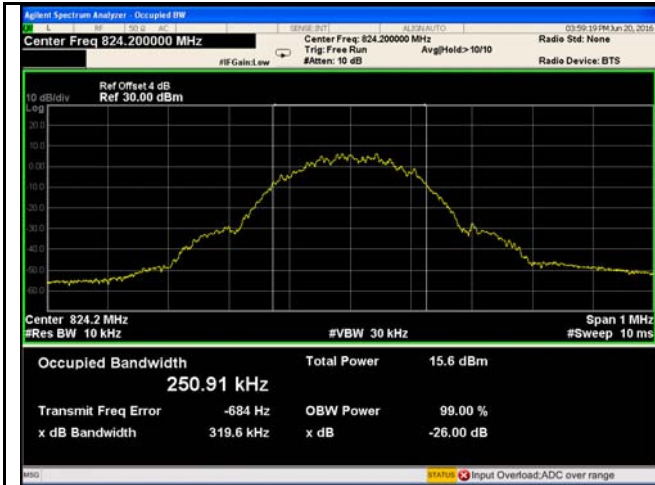

GSM 850 BW - Low CH 824.2MHz

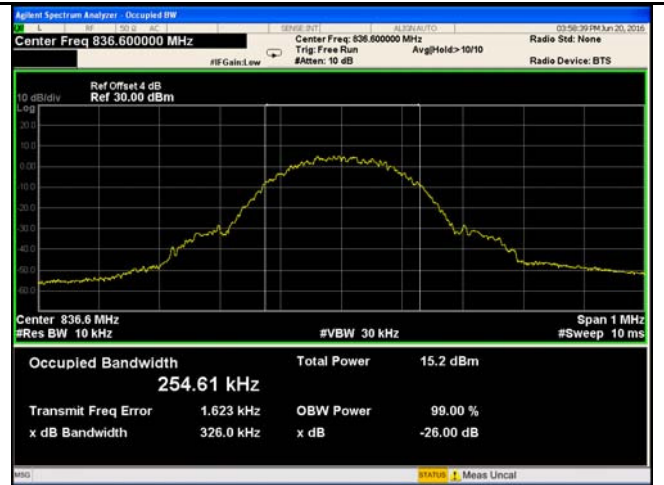

GSM 850 BW - Mid CH 836.6MHz

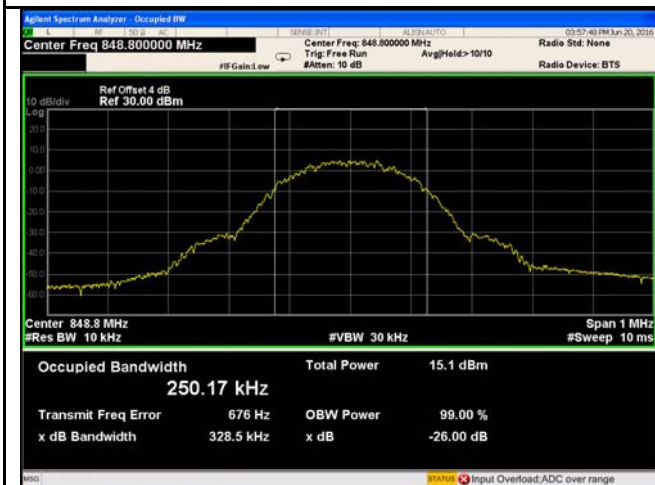

GSM 850 BW - High CH 848.8MHz



PCS 1900 BW - Low CH 1850.2MHz

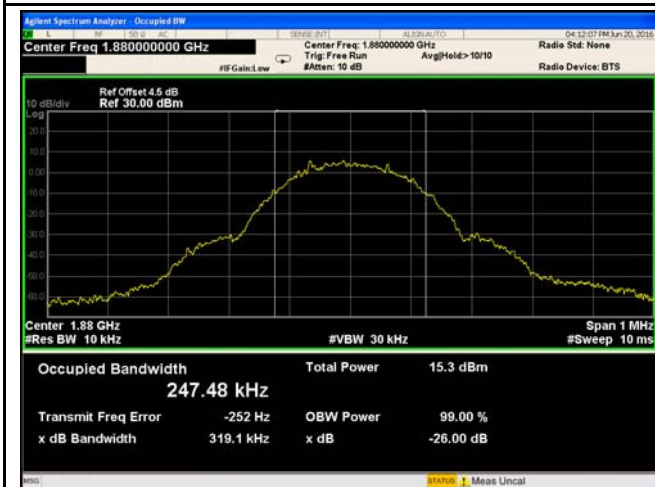

PCS 1900 BW - Mid CH 1880MHz

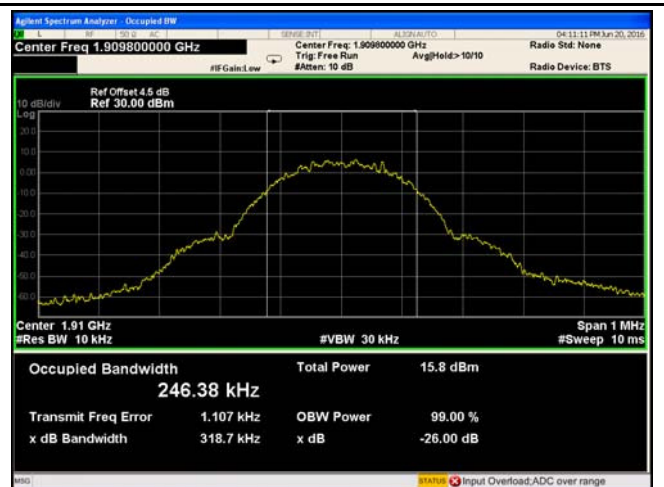

PCS 1900 BW - High CH 1909.8MHz

RMC:

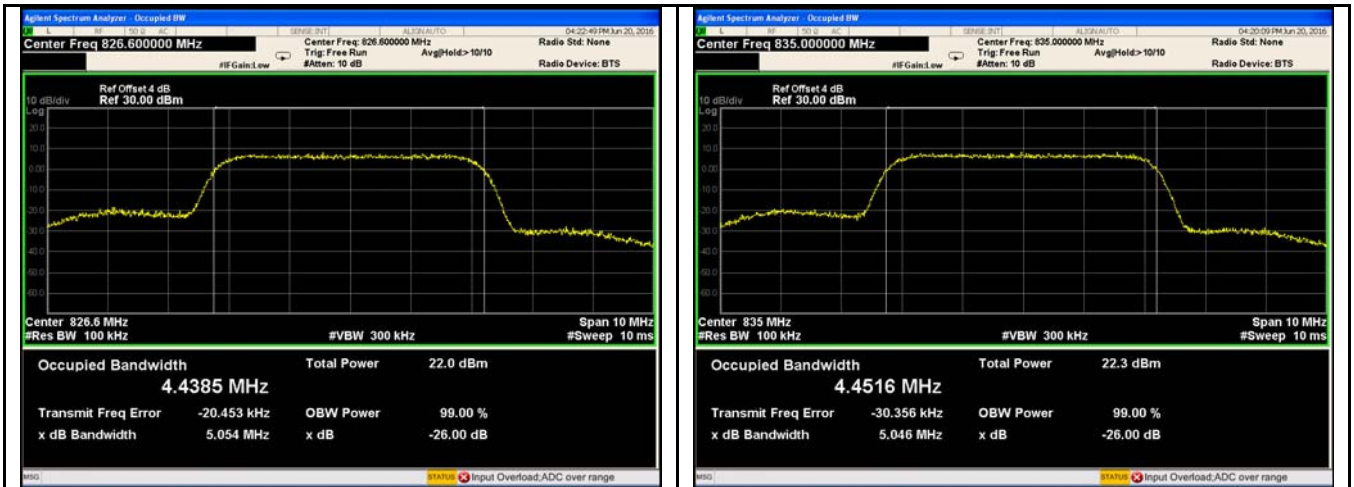

Band V BW - Low CH 826.6 MHz

Band V BW - Mid CH 835.0 MHz

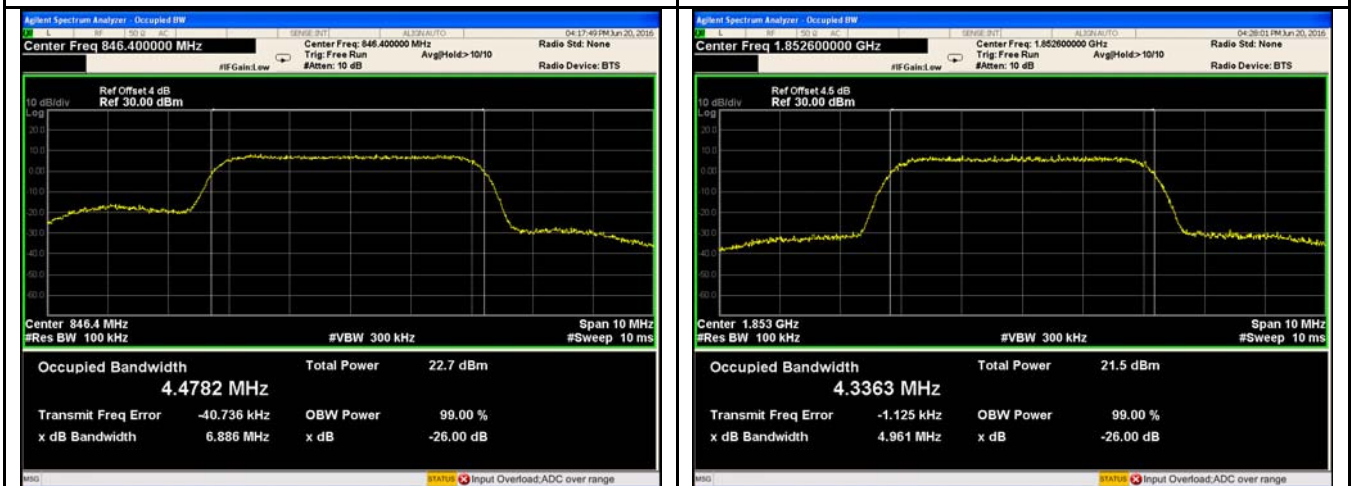

Band V BW - High CH 846.4 MHz

Band II BW - Low CH 1852.4MHz

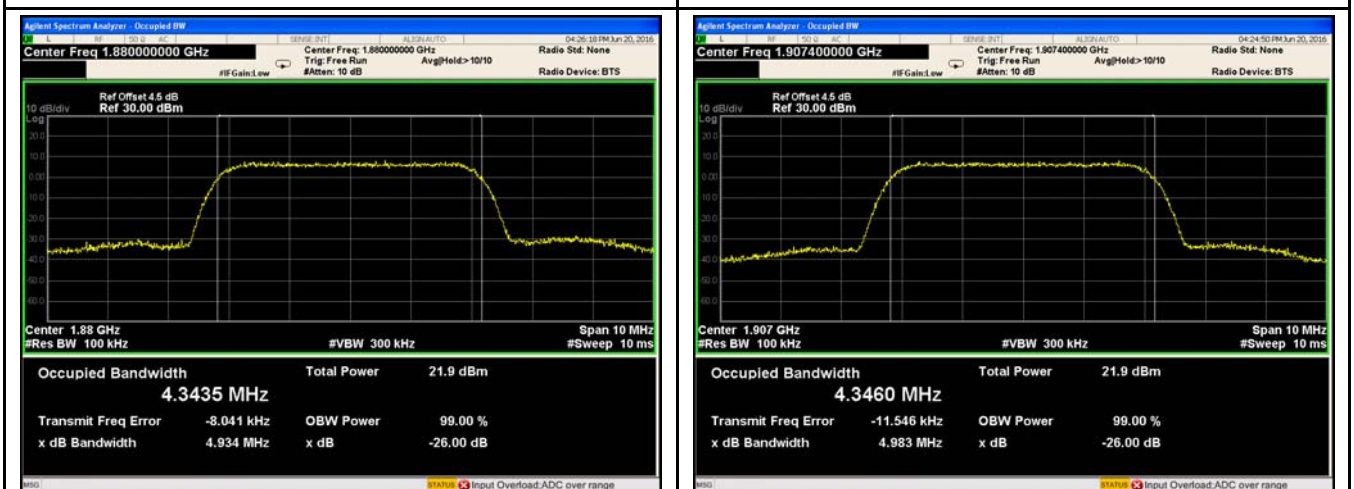

Band II BW - Mid CH 1880MHz

Band II BW - High CH 1907.6MHz

HSUPA:

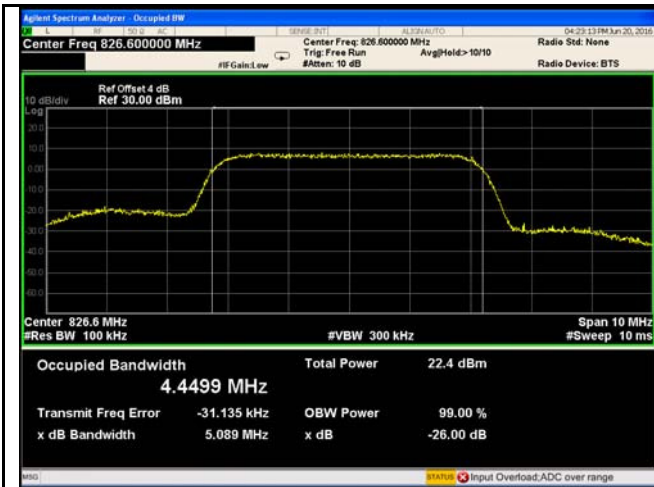

Band V BW - Low CH 826.6 MHz

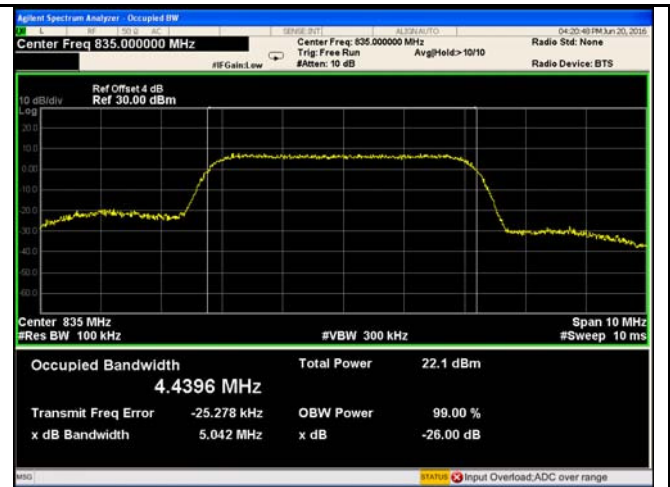

Band V BW - Mid CH 835.0 MHz

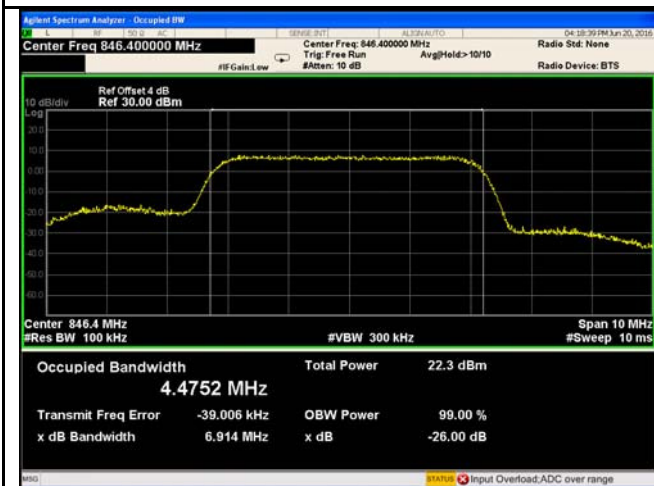

Band V BW - High CH 846.4 MHz

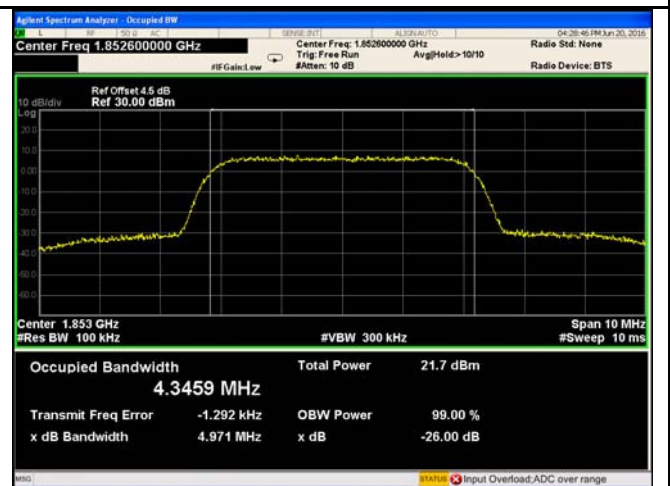

Band II BW - Low CH 1852.4MHz

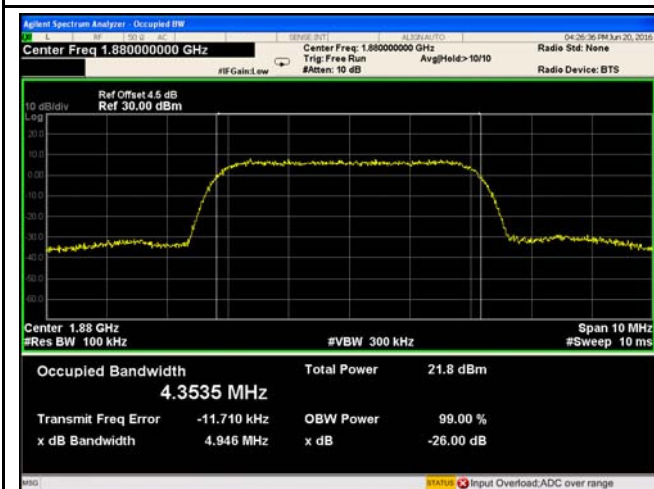

Band II BW - Mid CH 1880MHz

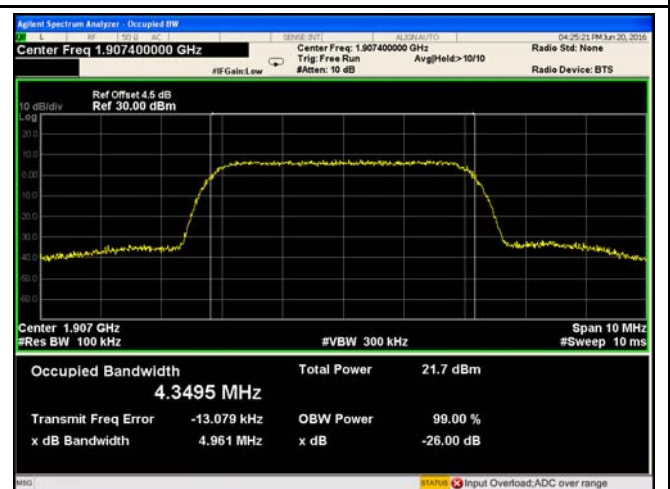

Band II BW - High CH 1907.6MHz

HSDPA:

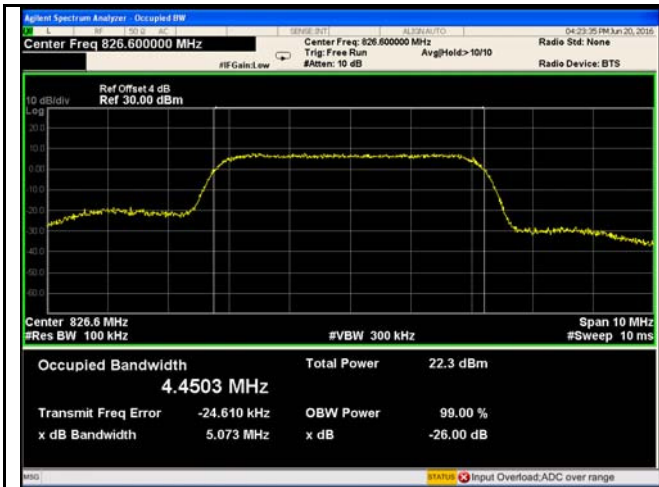

Band V BW - Low CH 826.6 MHz

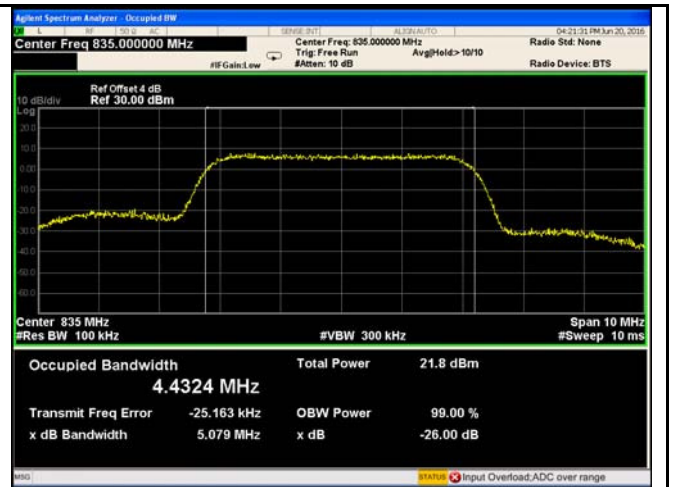

Band V BW - Mid CH 835.0 MHz

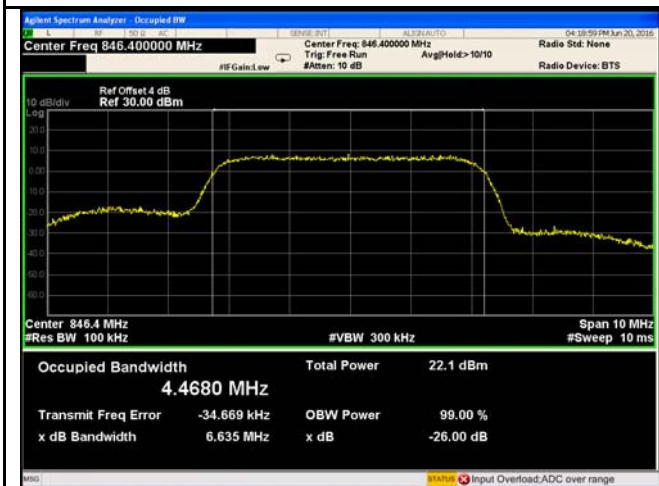

Band V BW - High CH 846.4 MHz

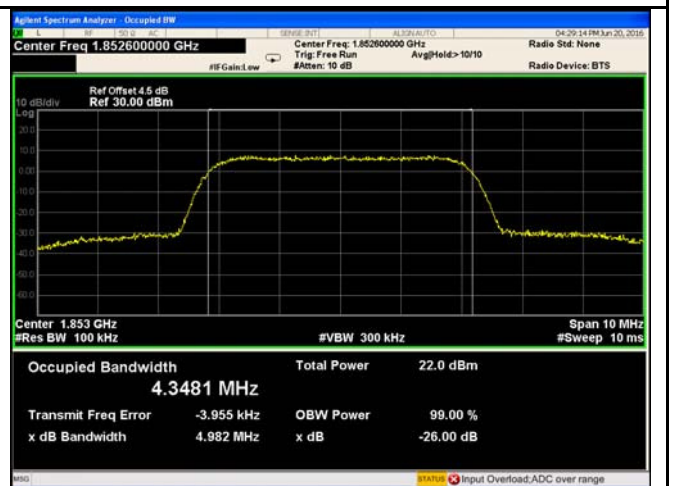

Band II BW - Low CH 1852.4 MHz

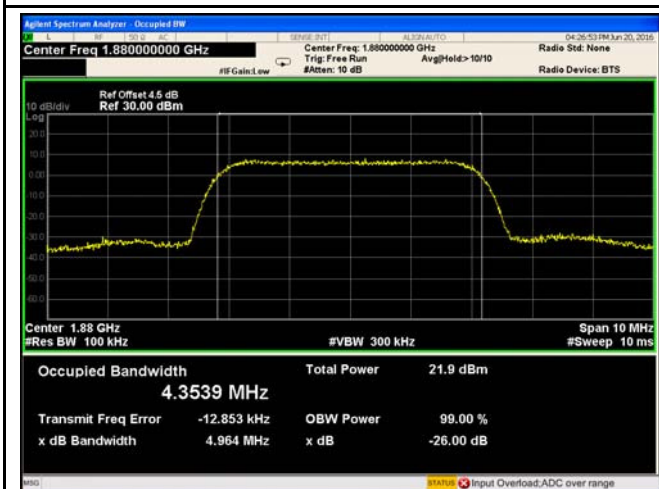

Band II BW - Mid CH 1880 MHz

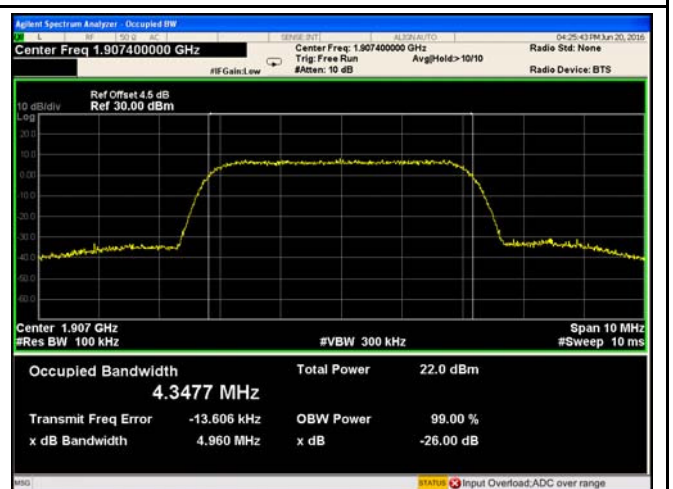

Band II BW - High CH 1907.6 MHz

6.5 Spurious Emissions at Antenna Terminals

Temperature	25°C
Relative Humidity	53%
Atmospheric Pressure	1020mbar
Test date :	June 20, 2016
Tested By :	Loren Luo

Requirement(s):

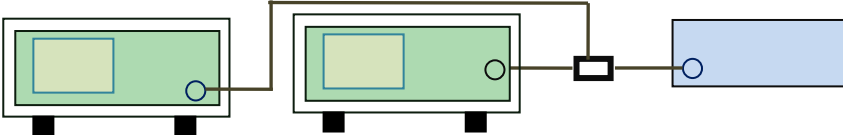
Spec	Item	Requirement	Applicable
§2.1051, §22.917(a)& §24.238(a)	a)	The power of any emission outside of the authorized operating frequency ranges must be lower than the transmitter power (P) by a factor of at least $43 + 10 \log(P)$ dB	<input checked="" type="checkbox"/>
Test Setup			
Test Procedure	<ul style="list-style-type: none"> - The EUT was connected to Spectrum Analyzer and Base Station via power divider. - The Band Edges of low and high channels for the highest RF powers were measured. - Setting RBW as roughly BW/100. 		
Remark			
Result	<input checked="" type="checkbox"/> Pass <input type="checkbox"/> Fail		

Test Data Yes N/A
 Test Plot Yes (See below) N/A

Test Plots

GSM Voice:

Cellular Band (Part 22H) result

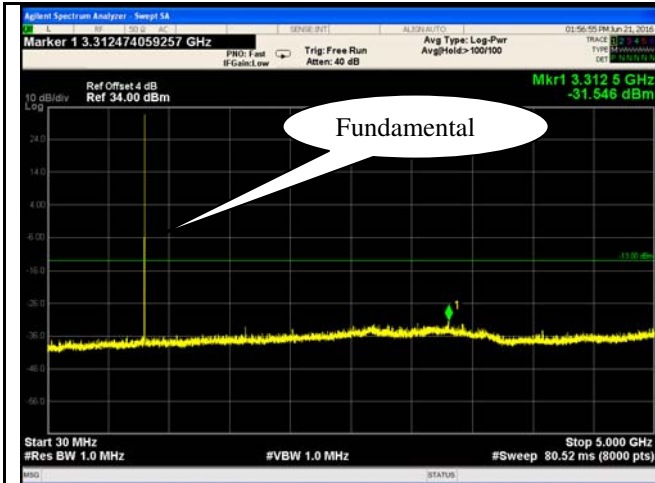

GSM 850 - Low Channel-1

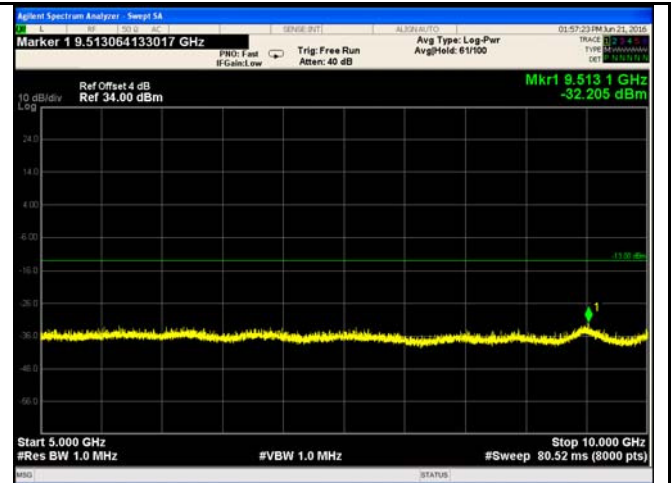

GSM 850 - Low Channel-2

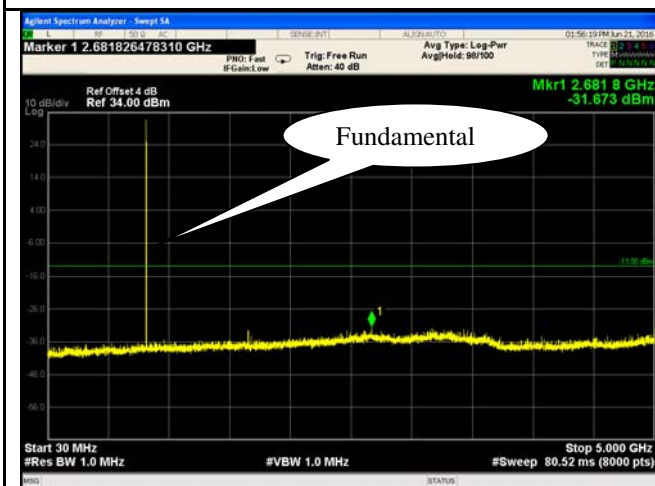

GSM 850 Middle Channel-1

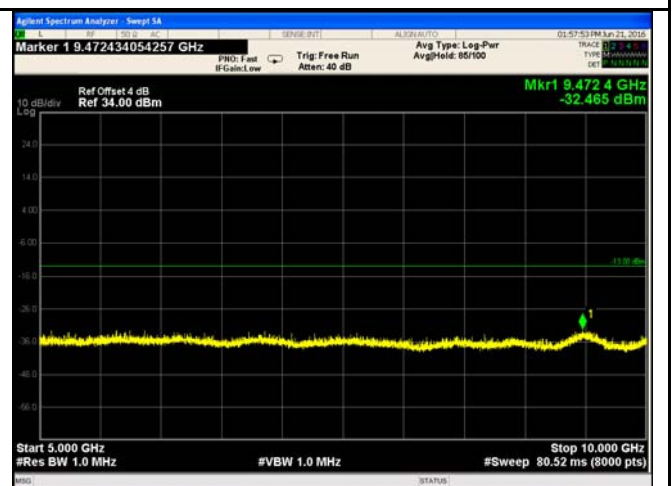

GSM 850 Middle Channel-2

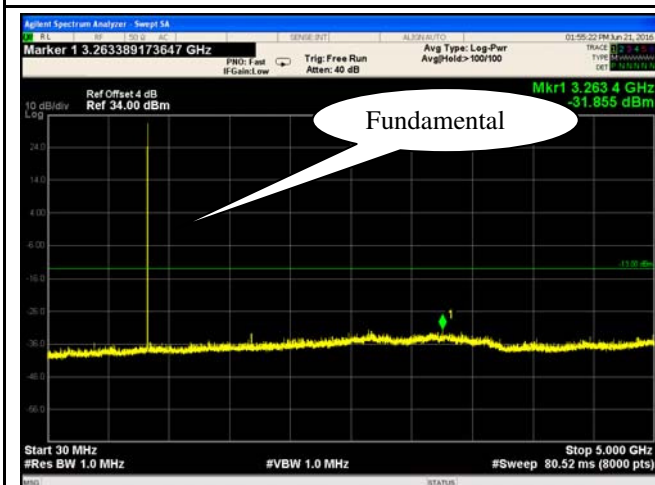

GSM 850 - High Channel-1

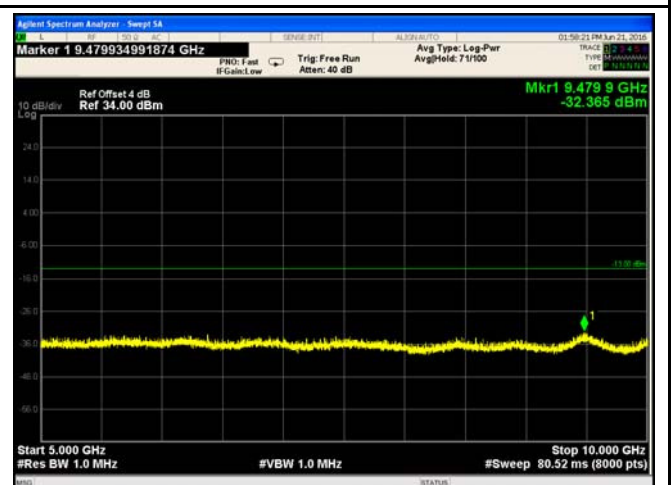

GSM 850 - High Channel-2

PCS Band (Part24E) result

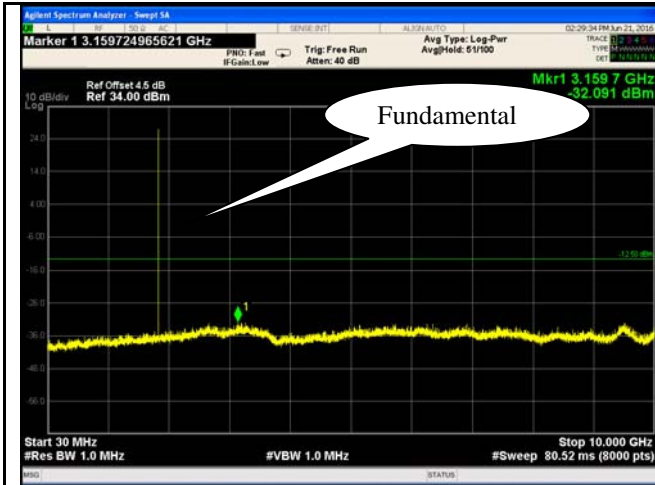

PCS1900 - Low Channel-1



PCS 1900 - Low Channel-2

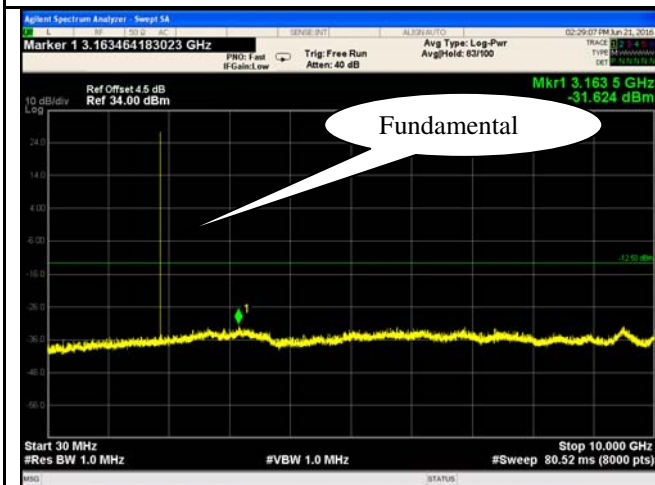

PCS1900 - Middle Channel-1

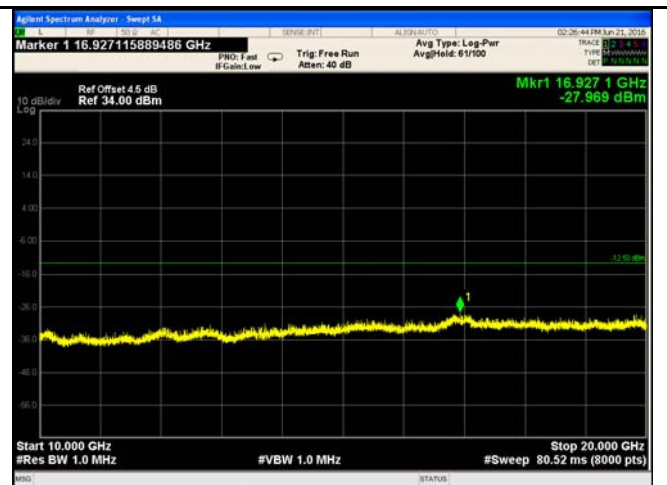

PCS 1900 - Middle Channel-2

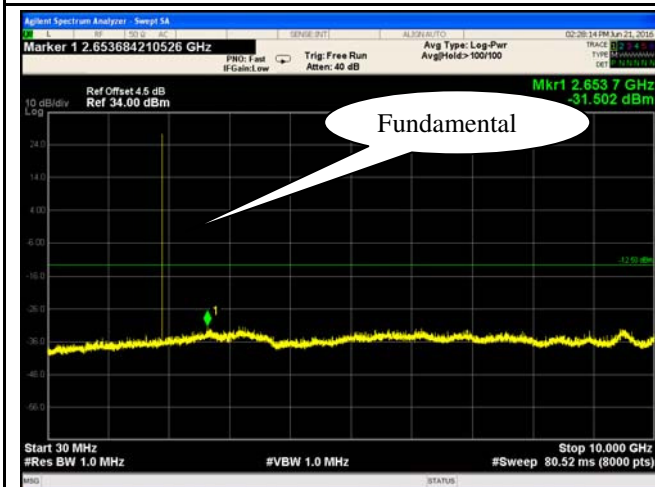

PCS1900 - High Channel-1

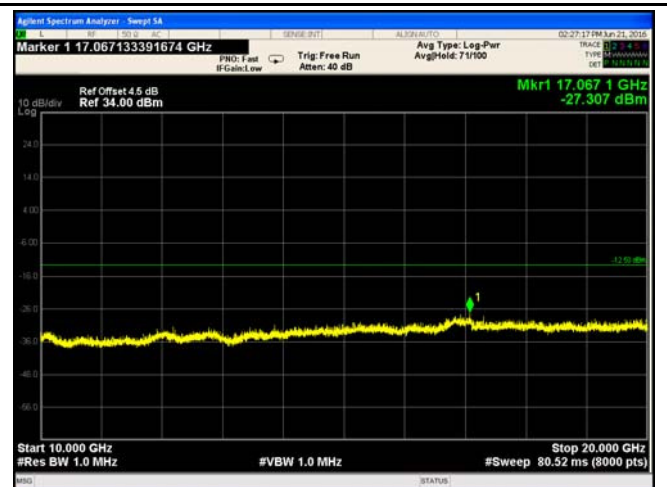

PCS 1900 - High Channel-2

GPRS:

Cellular Band (Part 22H) result

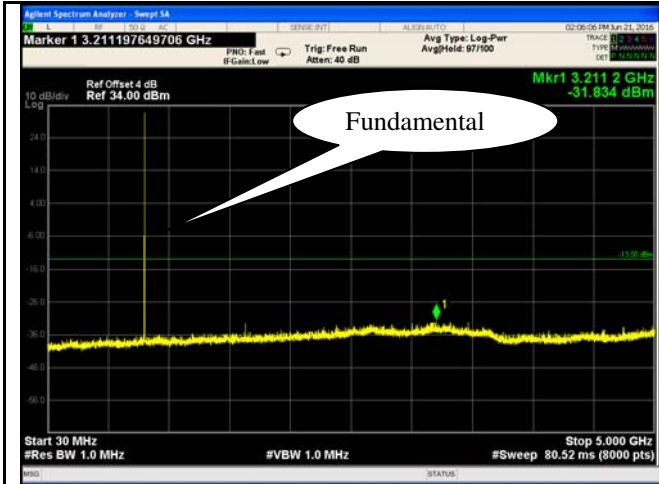

GSM 850 - Low Channel-1

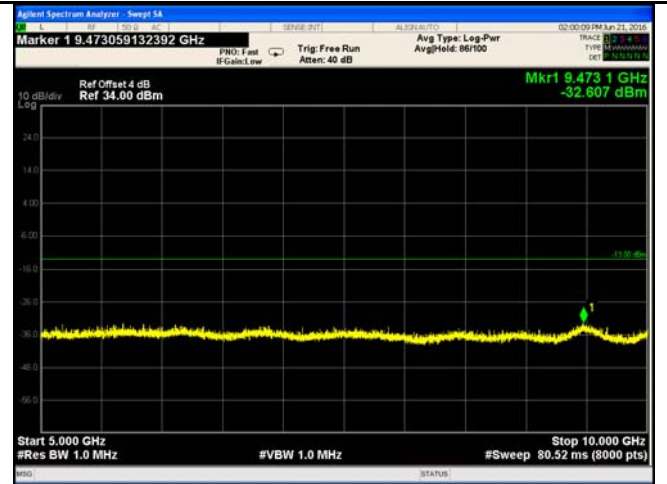

GSM 850 - Low Channel-2

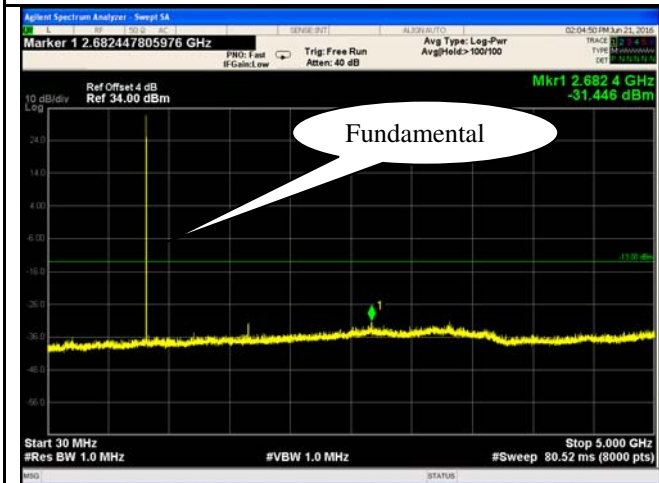

GSM 850 Middle Channel-1

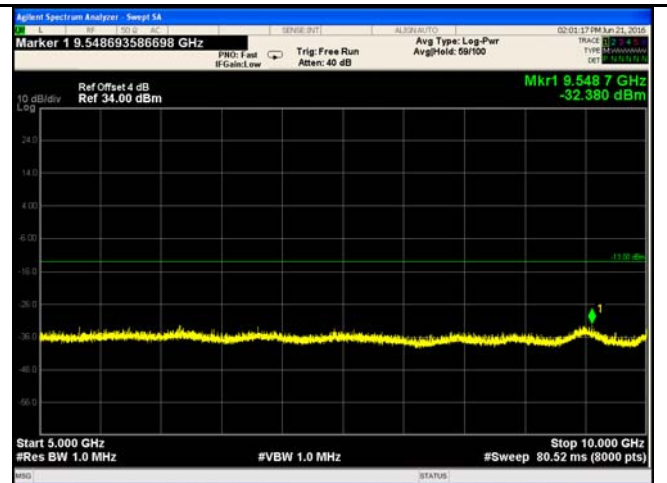

GSM 850 Middle Channel-2

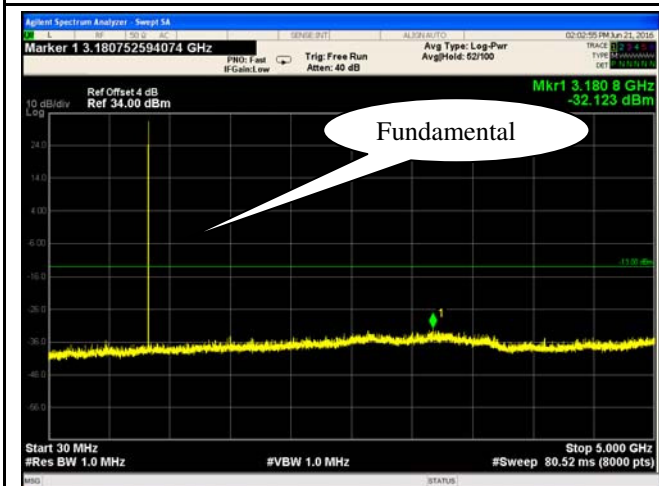

GSM 850 - High Channel-1

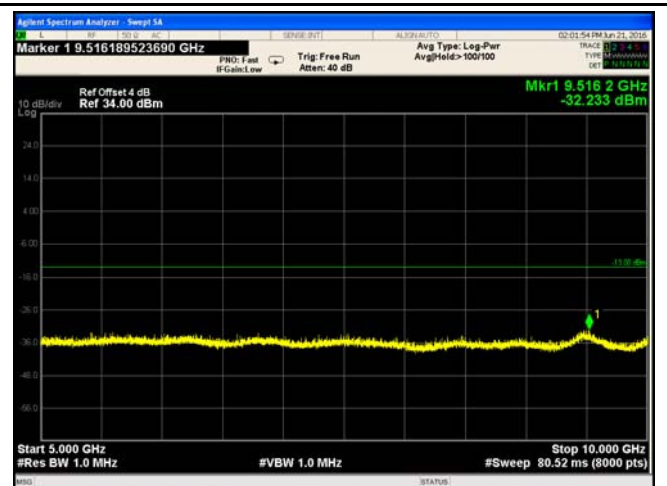

GSM 850 - High Channel-2

PCS Band (Part24E) result

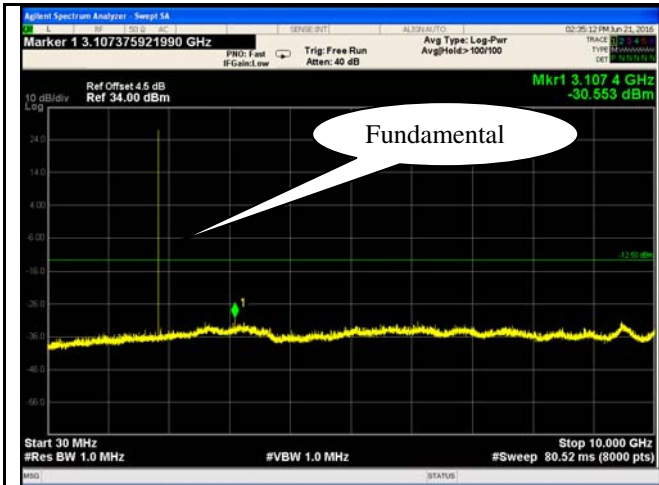

PCS1900 - Low Channel-1

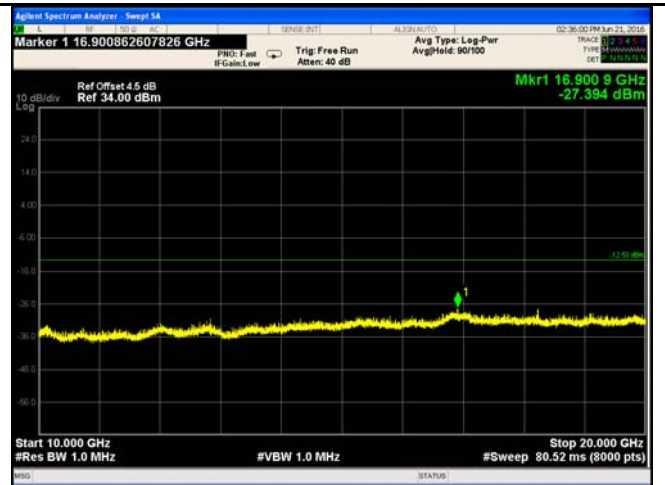

PCS 1900 - Low Channel-2

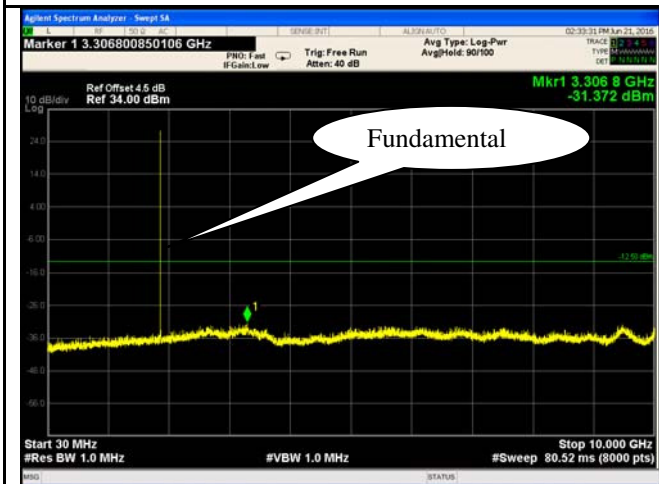

PCS1900 - Middle Channel-1

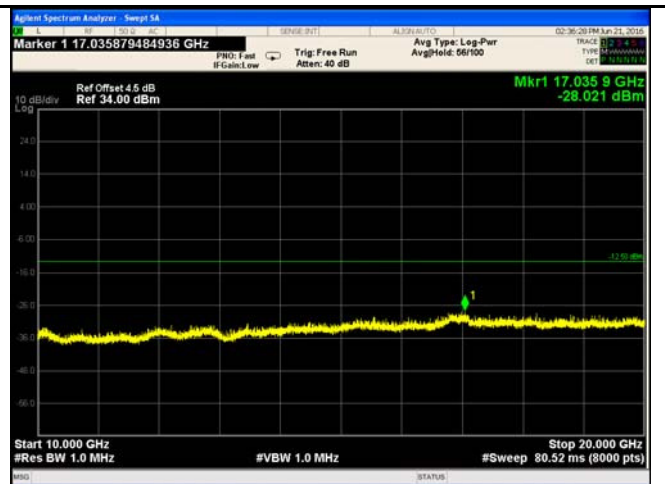

PCS 1900 - Middle Channel-2

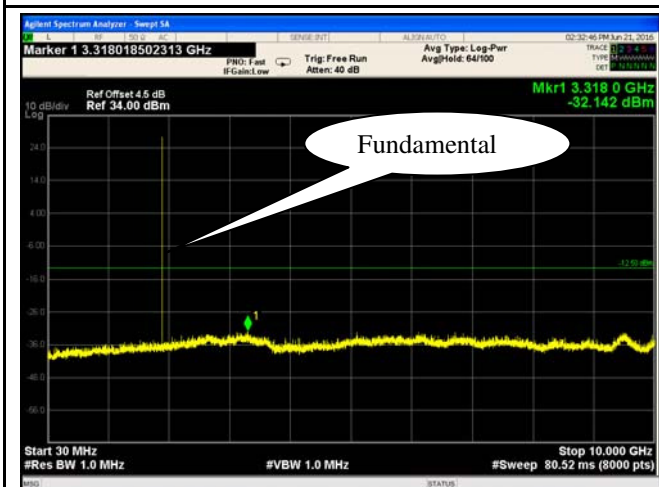

PCS1900 - High Channel-1

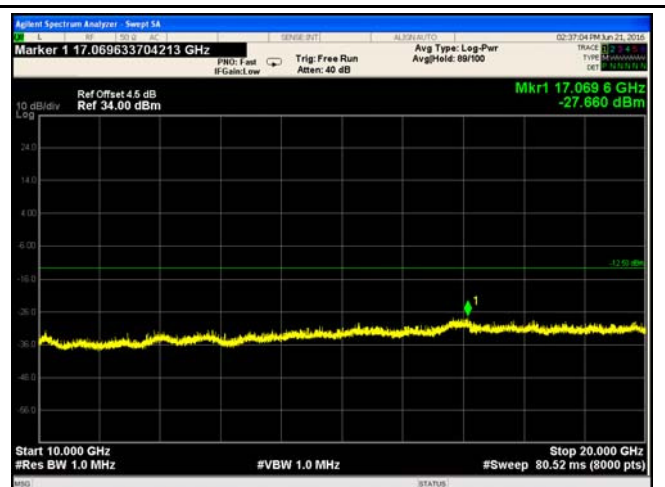

PCS 1900 - High Channel-2

**EGPRS (MCS 5):
 Cellular Band (Part 22H) result**

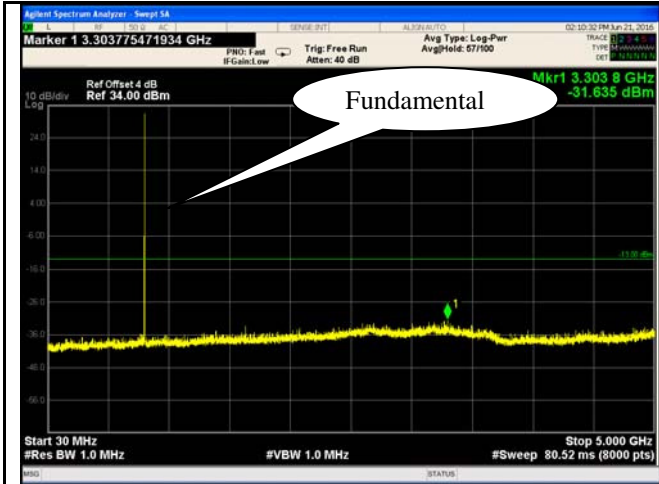

GSM 850 - Low Channel-1

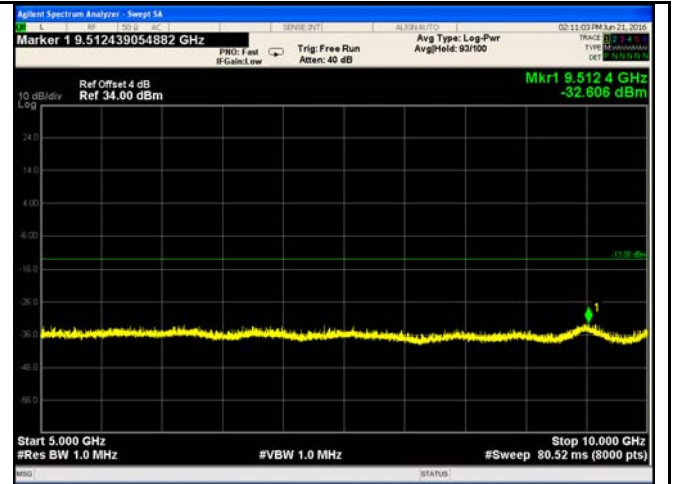

GSM 850 - Low Channel-2

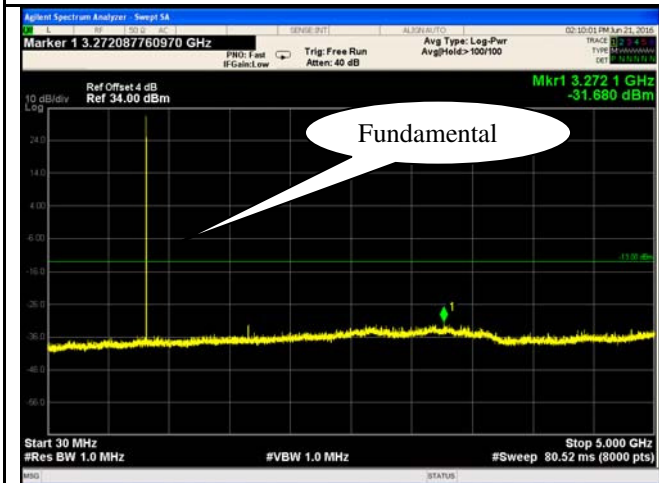

GSM 850 Middle Channel-1

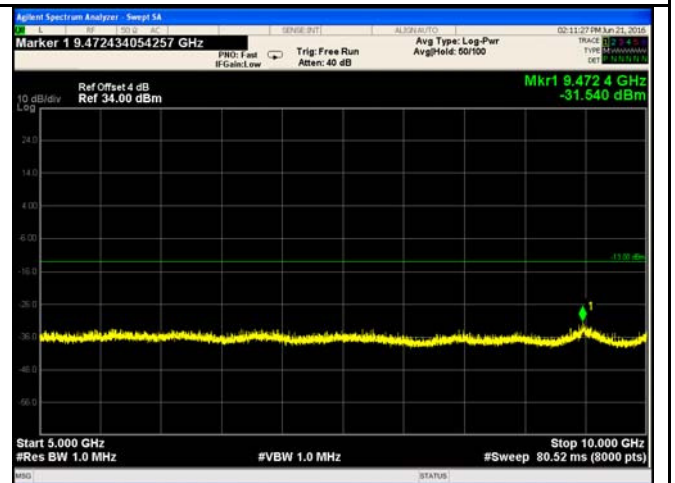

GSM 850 Middle Channel-2

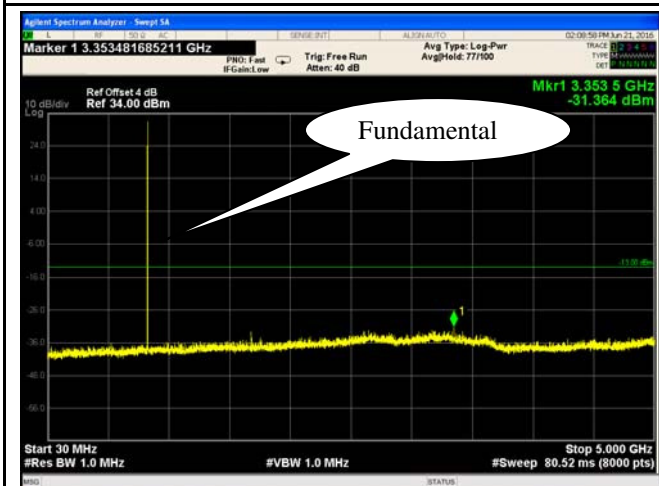

GSM 850 - High Channel-1

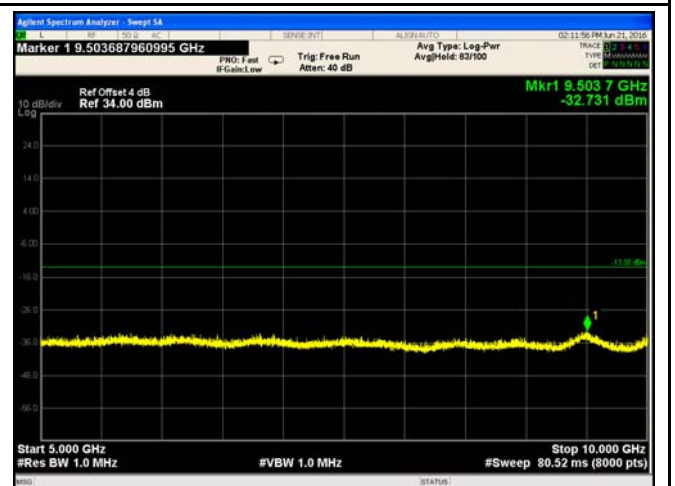

GSM 850 - High Channel-2

PCS Band (Part24E) result

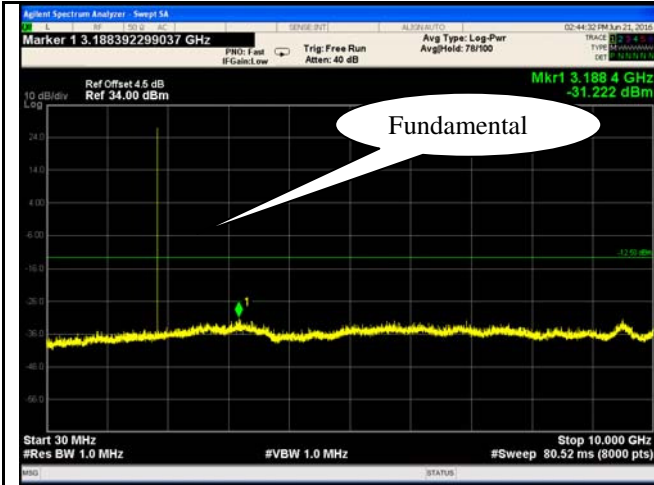

PCS1900 - Low Channel-1

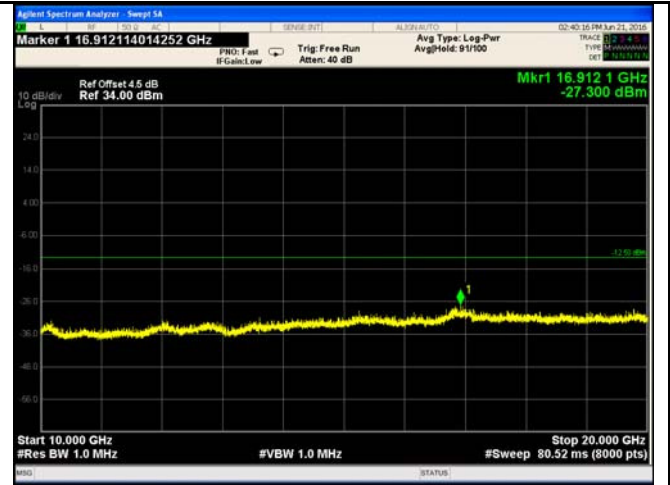

PCS 1900 - Low Channel-2

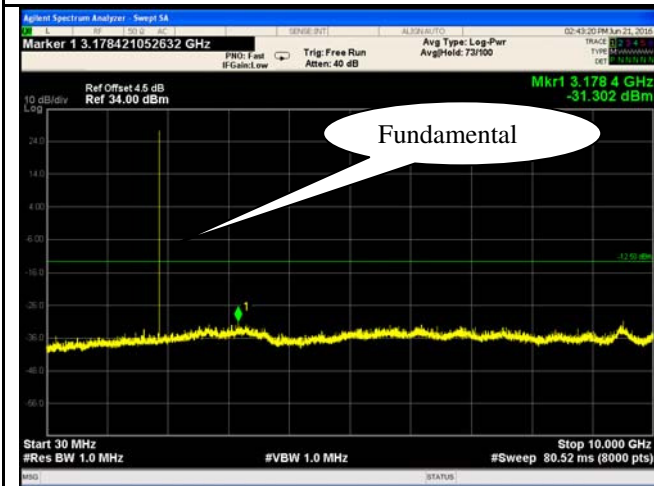

PCS1900 - Middle Channel-1



PCS 1900 - Middle Channel-2

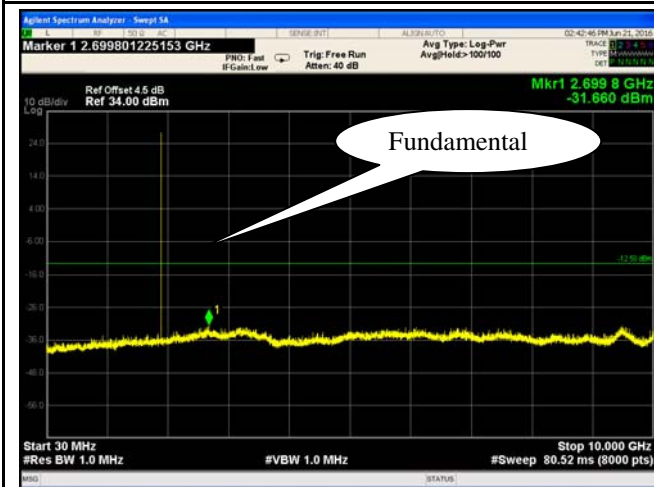

PCS1900 - High Channel-1

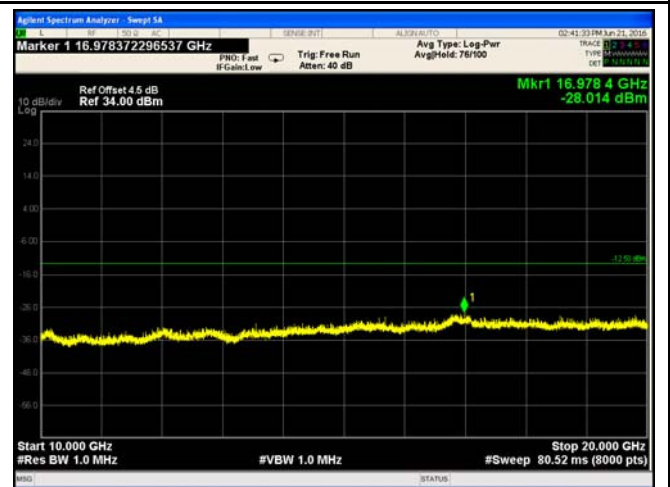

PCS 1900 - High Channel-2

RMC

UMTS-FDD Band V (Part 22H)

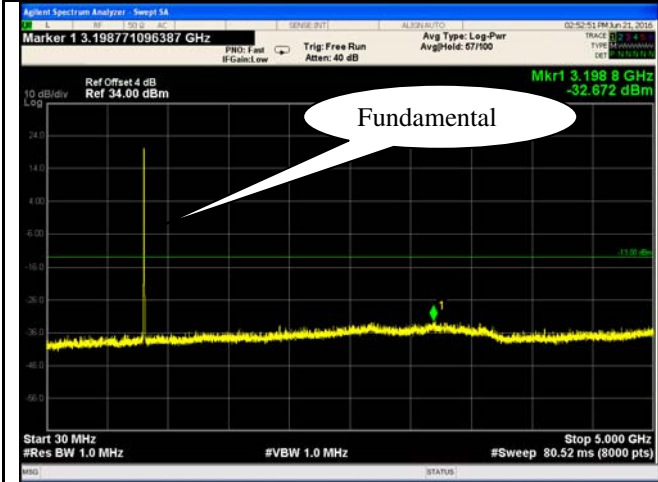

Band V - Low Channel-1

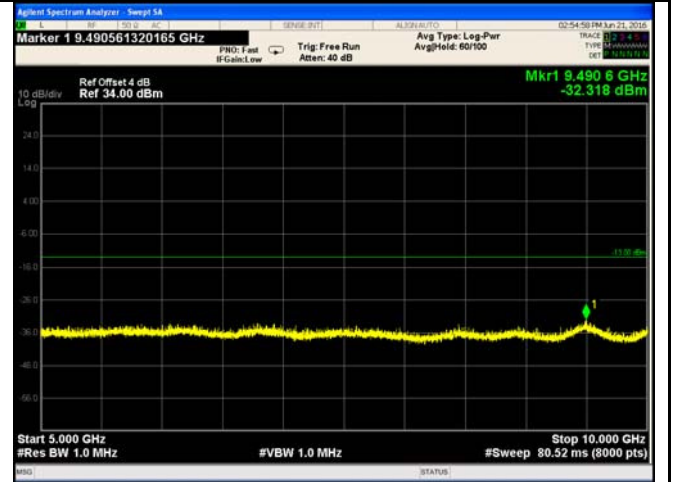

Band V - Low Channel-2

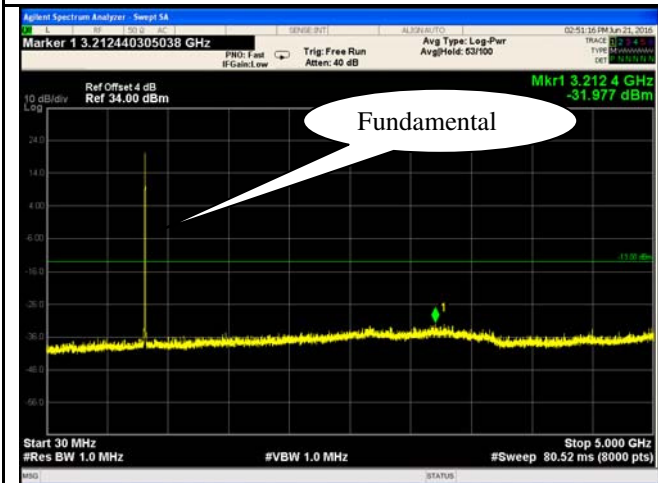

Band V - Middle Channel-1

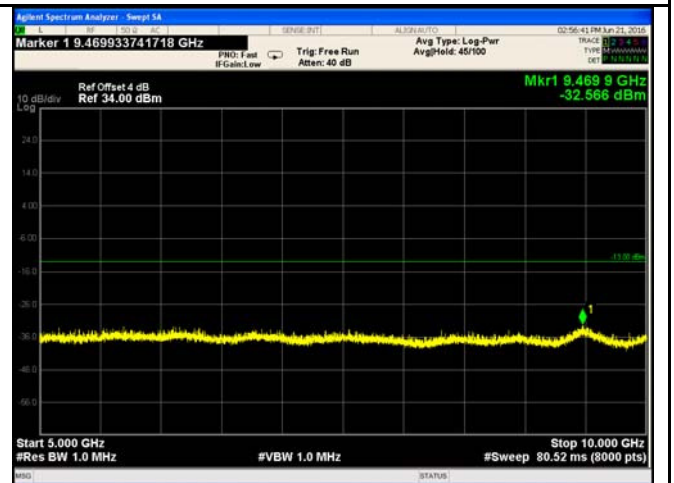

Band V - Middle Channel-2

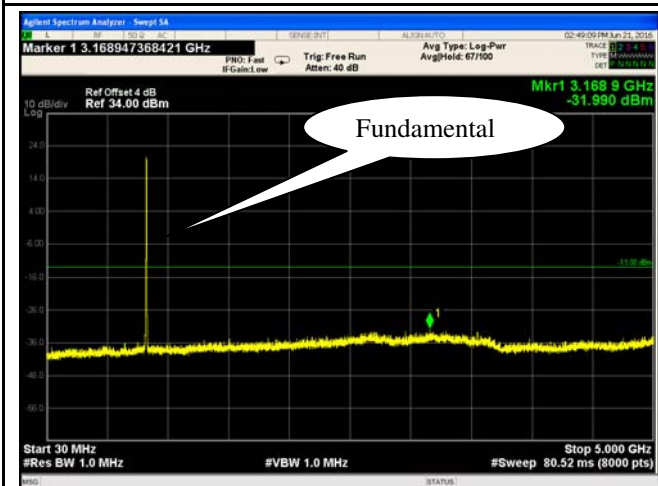

Band V - High Channel-1

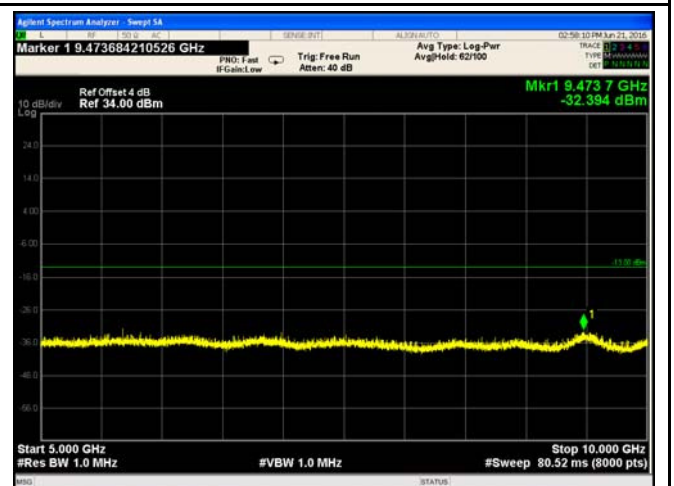

Band V - High Channel-2

UMTS-FDD Band II (Part 24E)

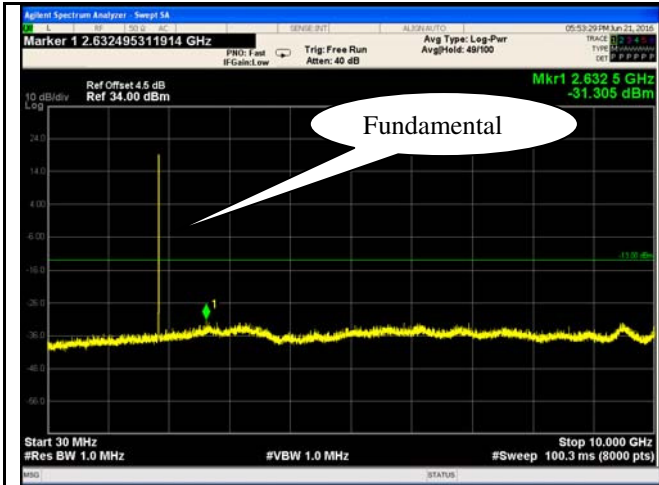

Band II - Low Channel-1



Band II - Low Channel-2

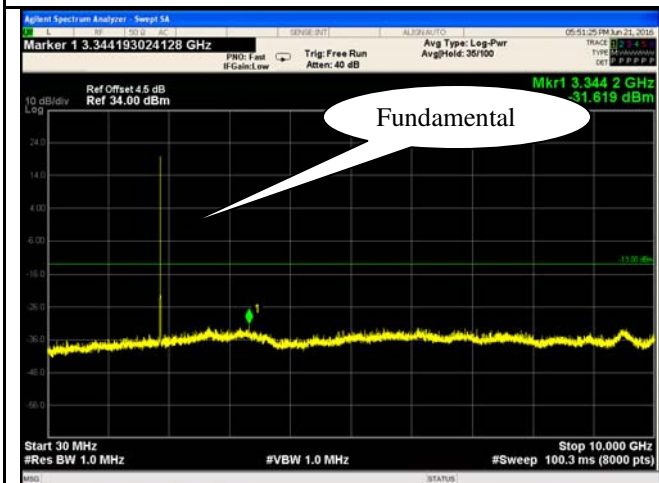

Band II - Middle Channel-1

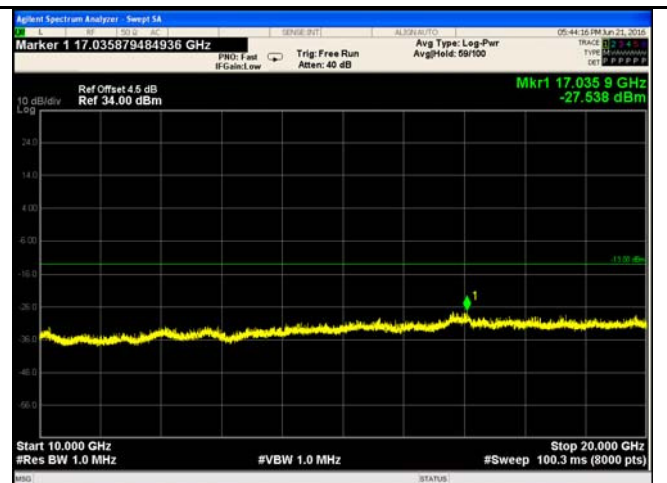

Band II - Middle Channel-2

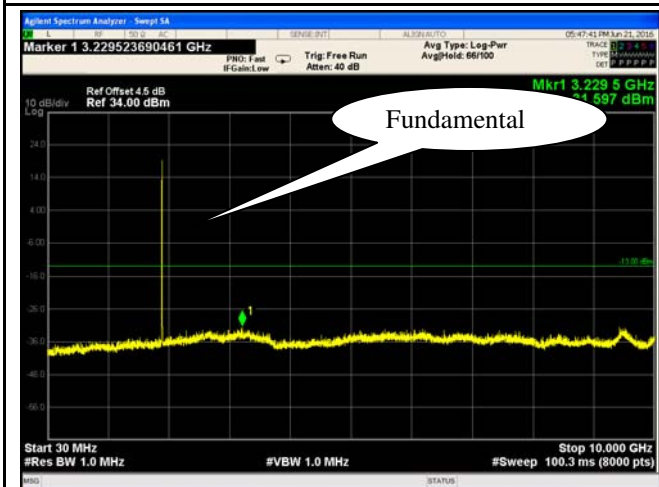

Band II - High Channel-1

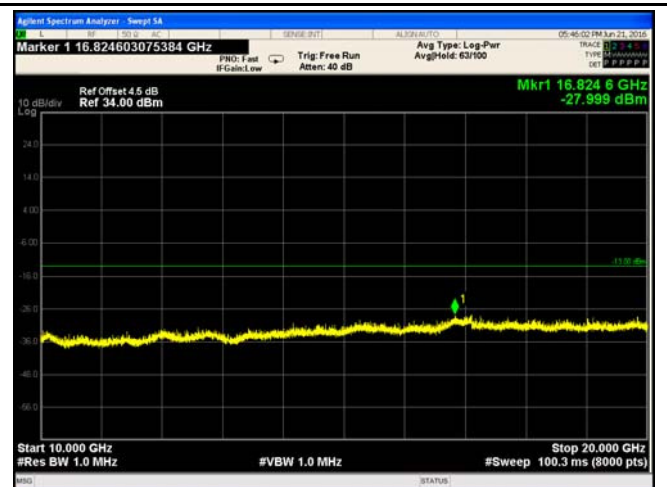

Band II - High Channel-2

HSUPA:

UMTS-FDD Band V (Part 22H)

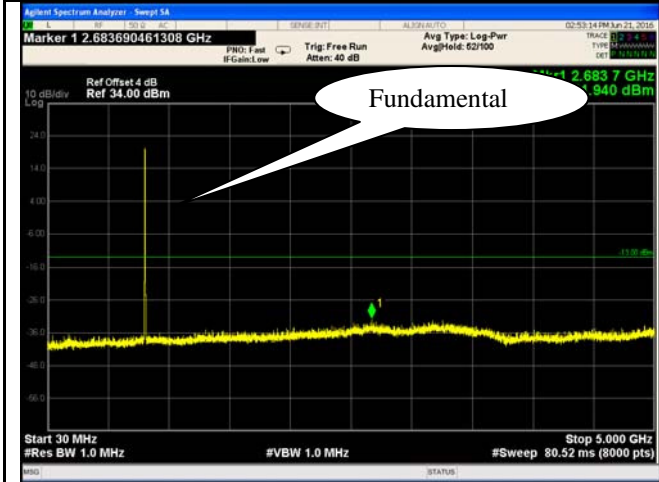

Band V - Low Channel-1

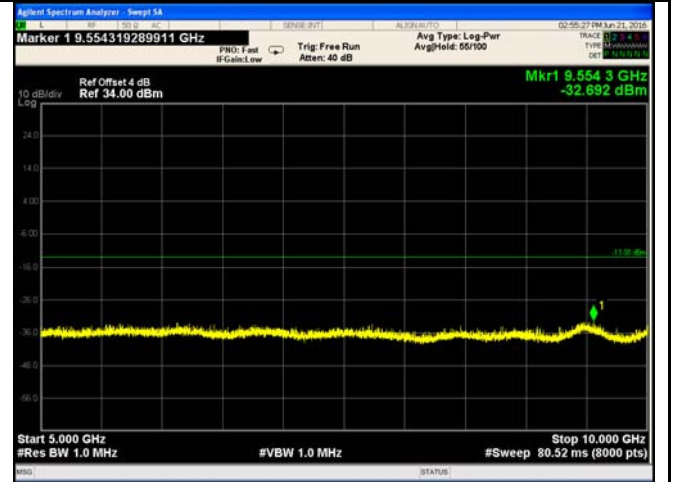

Band V - Low Channel-2

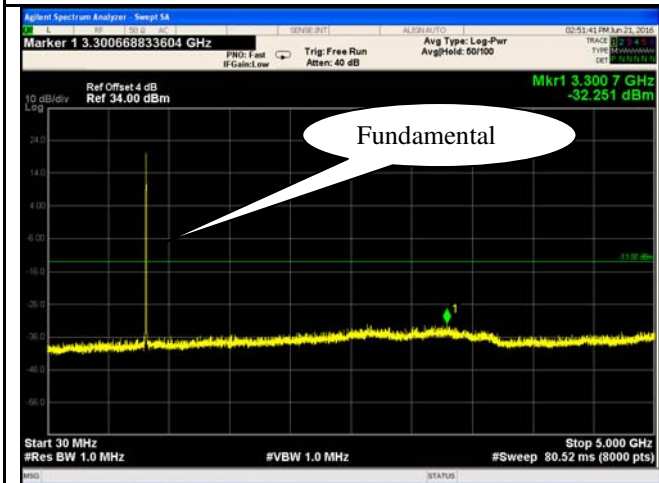

Band V - Middle Channel-1

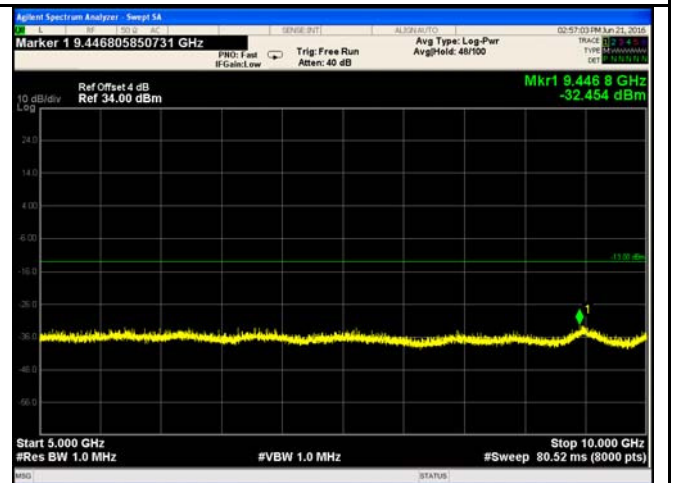

Band V - Middle Channel-2

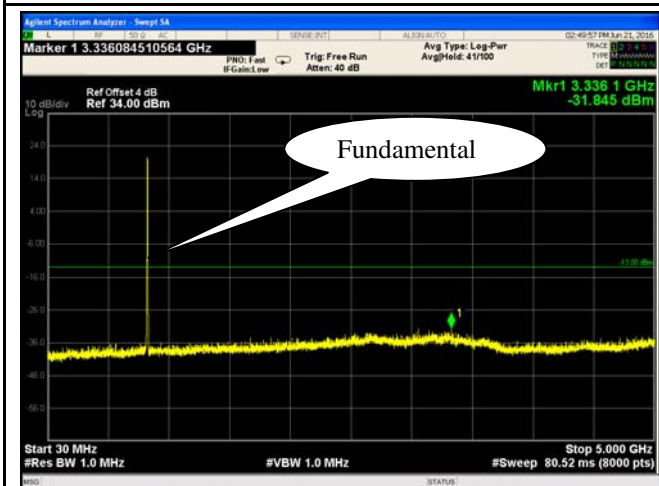

Band V - High Channel-1

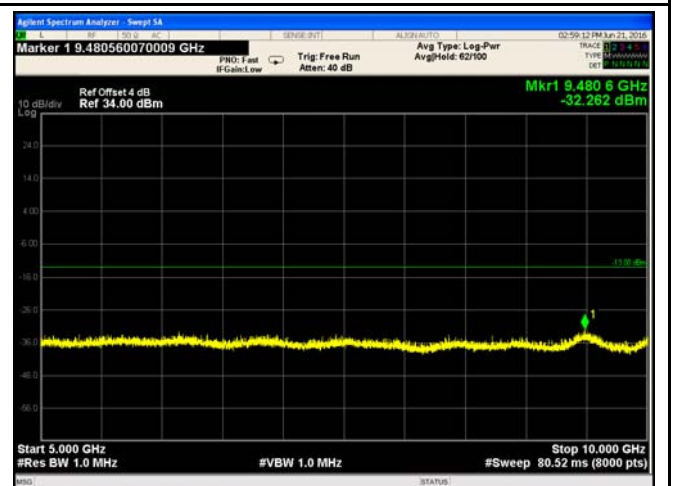

Band V - High Channel-2

UMTS-FDD Band II (Part 24E)

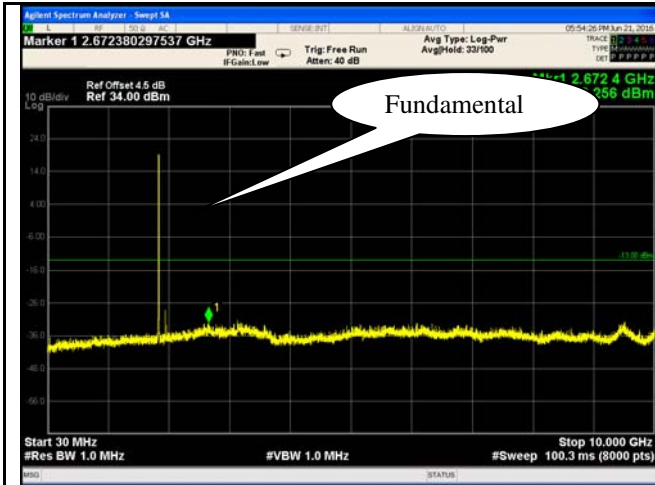

Band II - Low Channel-1

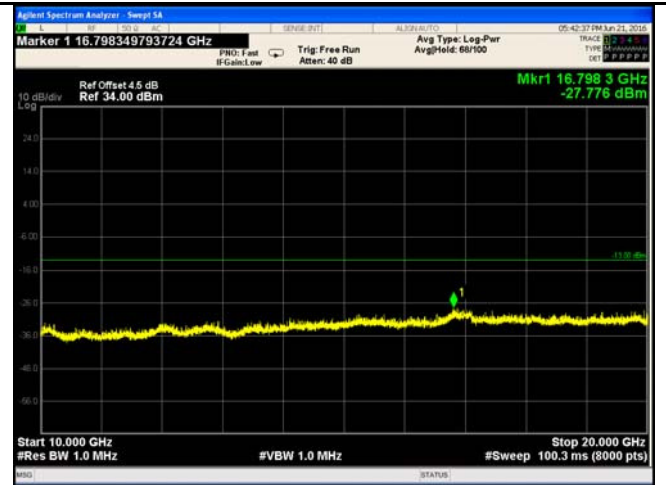

Band II - Low Channel-2

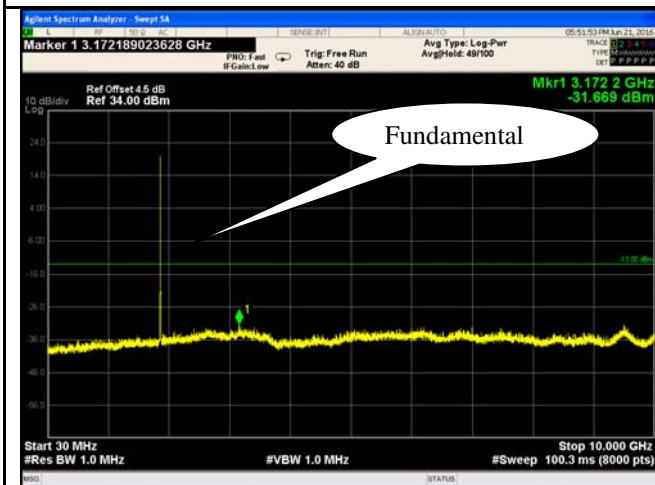

Band II - Middle Channel-1

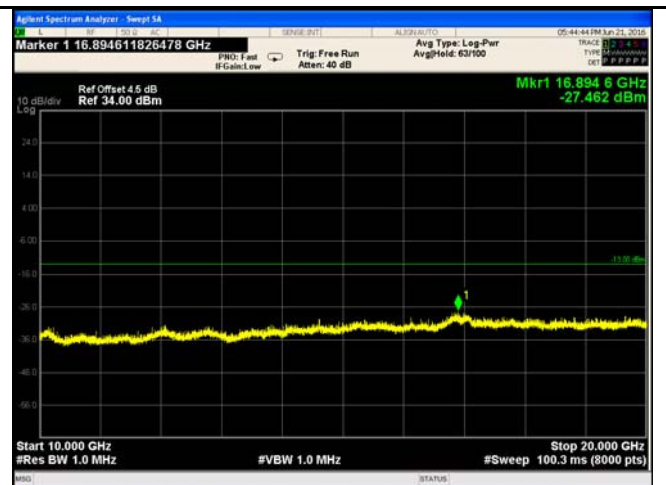

Band II - Middle Channel-2

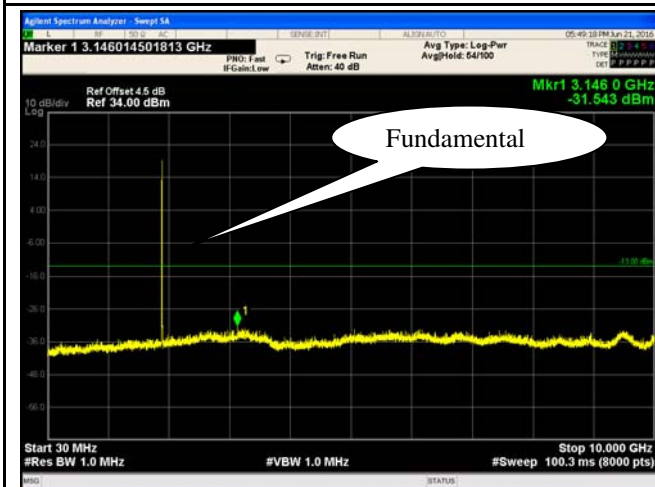

Band II - High Channel-1

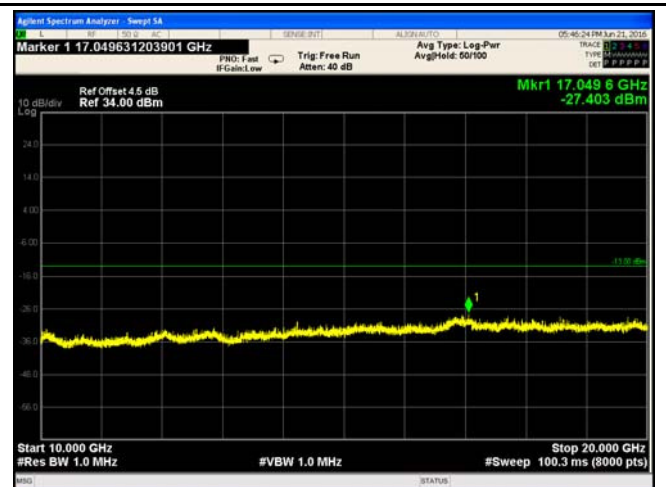

Band II - High Channel-2

HSDPA:

UMTS-FDD Band V (Part 22H)

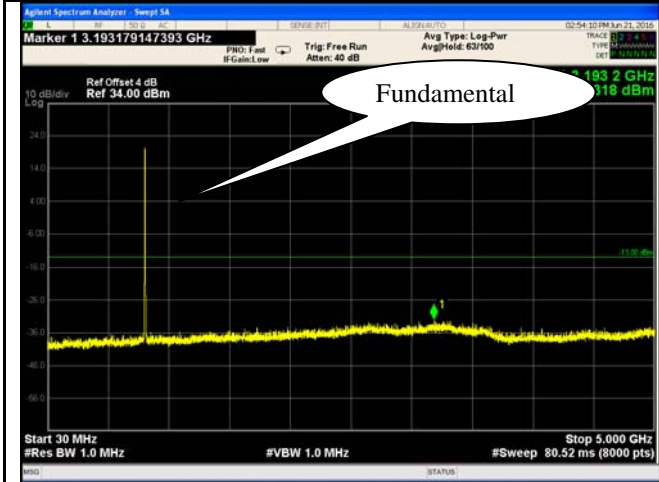

Band V - Low Channel-1

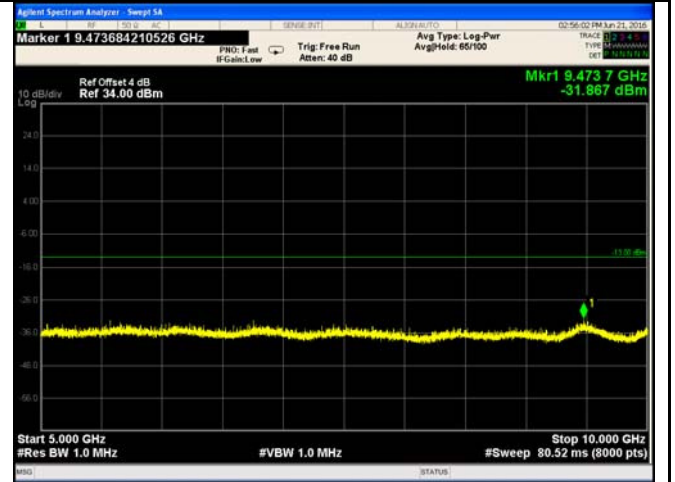

Band V - Low Channel-2

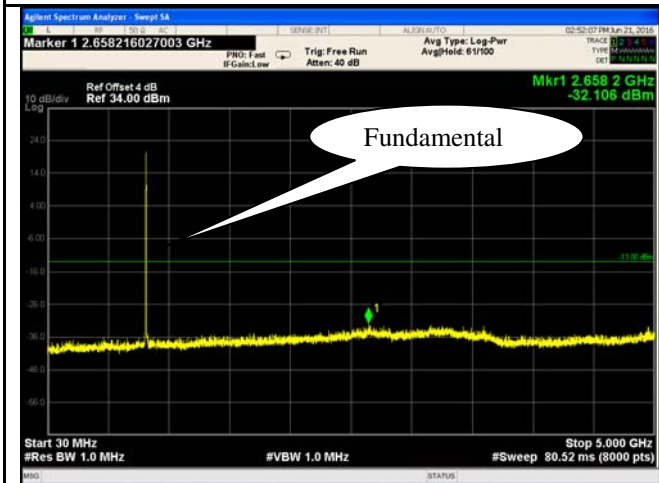

Band V - Middle Channel-1

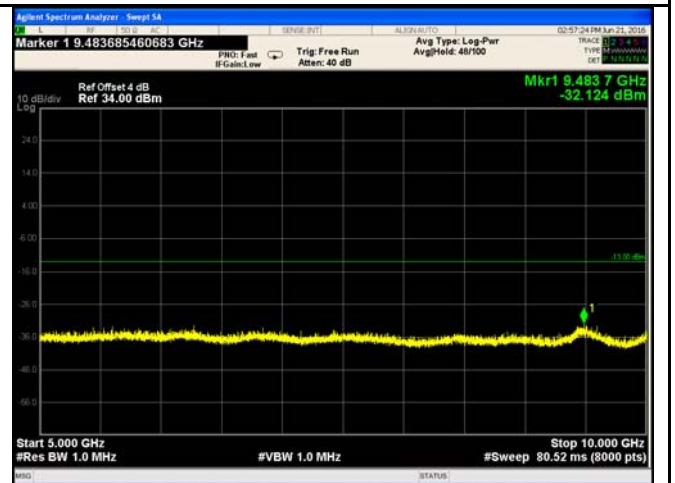

Band V - Middle Channel-2



Band V - High Channel-1

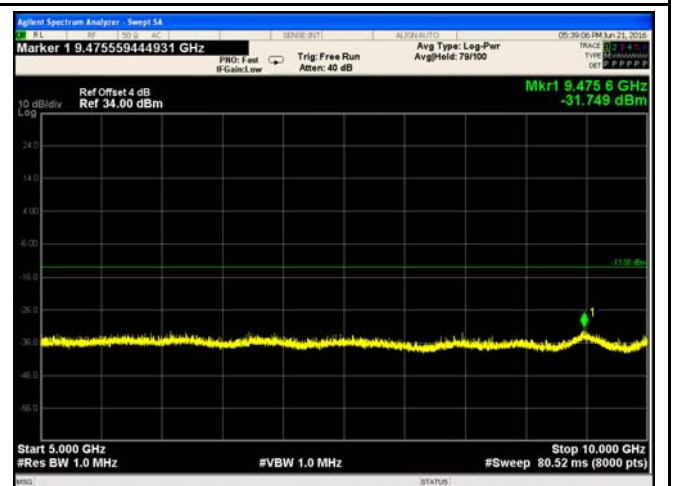

Band V - High Channel-2

UMTS-FDD Band II (Part 24E)

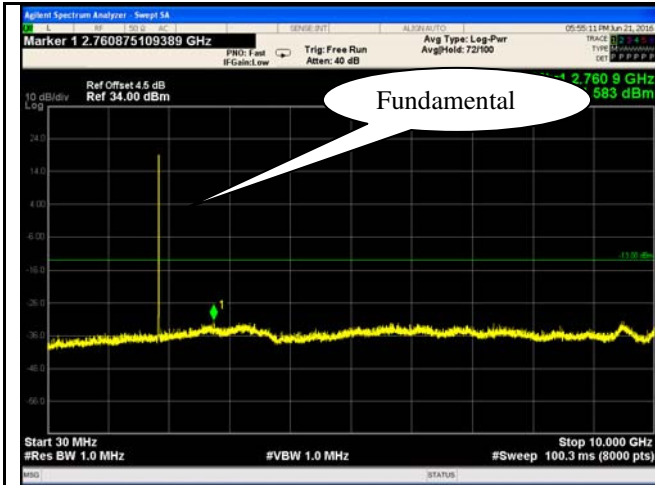

Band II - Low Channel-1

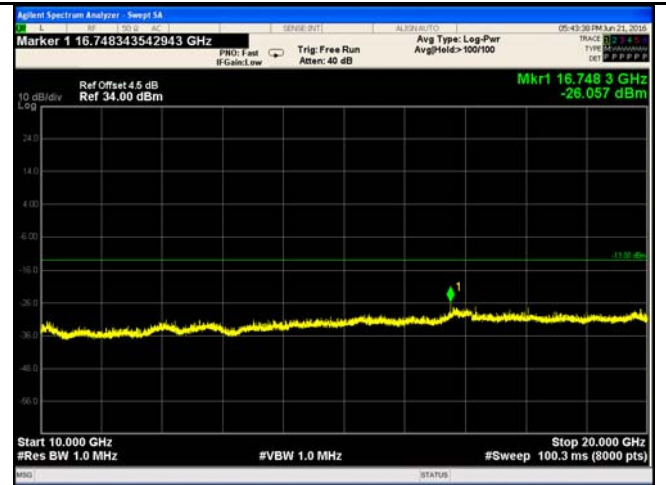

Band II - Low Channel-2

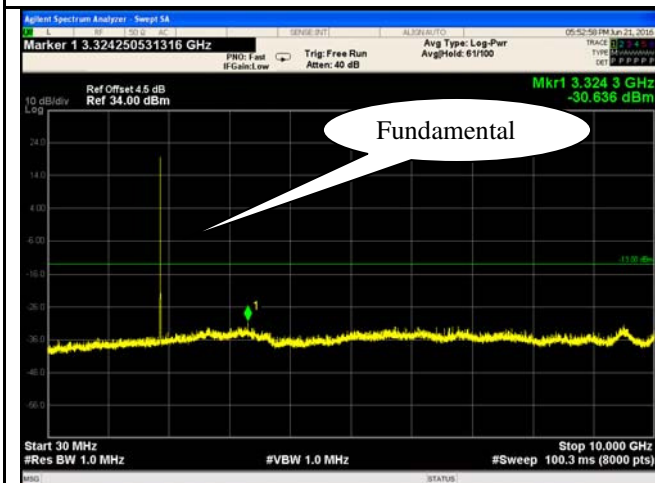

Band II - Middle Channel-1

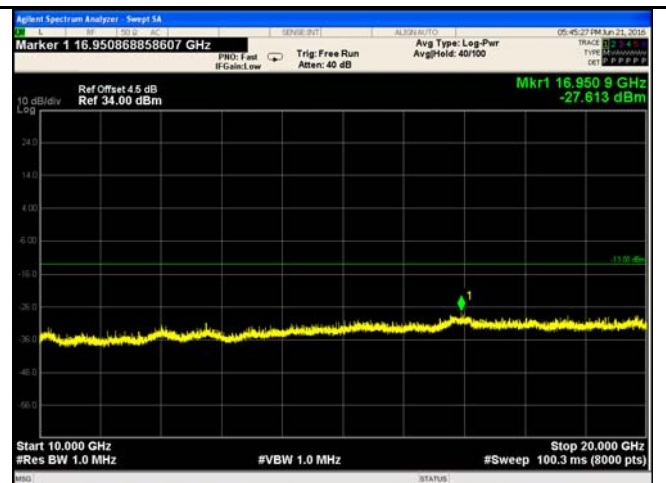

Band II - Middle Channel-2

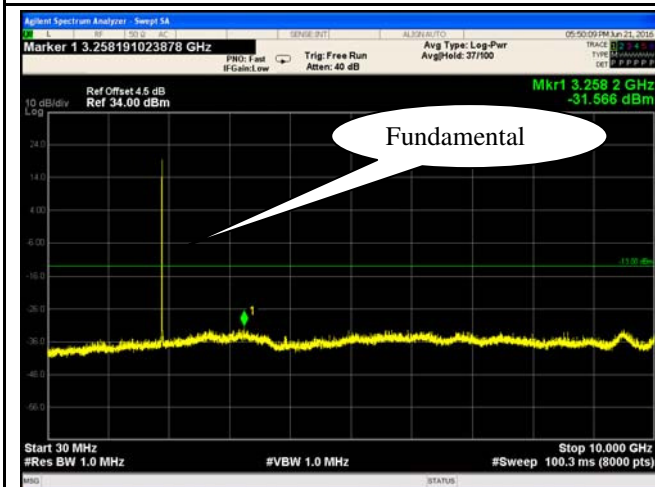

Band II - High Channel-1



Band II - High Channel-2

6.6 Spurious Radiated Emissions

Temperature	25°C
Relative Humidity	53%
Atmospheric Pressure	1020mbar
Test date :	June 20, 2016
Tested By :	Loren Luo

Requirement(s):

Spec	Item	Requirement	Applicable
§2.1053, §22.917 & §24.238	a)	The power of any emission outside of the authorized operating frequency ranges must be attenuated below the transmitter power (P) by a factor of at least $43 + 10 \log (P)$ dB. The spectrum is scanned from 30 MHz up to a frequency including its 10th harmonic.	<input checked="" type="checkbox"/>

Test setup	
------------	--

Test Procedure	<ol style="list-style-type: none"> The transmitter was placed on a wooden turntable, and it was transmitting into a non-radiating load which was also placed on the turntable. The measurement antenna was placed at a distance of 3 meters from the EUT. During the tests, the antenna height and polarization as well as EUT azimuth were varied in order to identify the maximum level of emissions from the EUT. The test was performed by placing the EUT on 3-orthogonal axis. Remove the EUT and replace it with substitution antenna. A signal generator was connected to the substitution antenna by a non-radiating cable. The absolute levels of the spurious emissions were measured by the substitution. Sample Calculation: EUT Field Strength = Raw Amplitude (dBµV/m) – Amplifier Gain (dB) + Antenna Factor (dB) + Cable Loss (dB) + Filter Attenuation (dB, if used)
----------------	---

Test Report	16070559-FCC-R1
Page	53 of 88

Remark	
Result	<input checked="" type="checkbox"/> Pass <input type="checkbox"/> Fail

Test Data Yes N/A
 Test Plot Yes (See below) N/A

Cellular Band (Part 22H) result

Low channel

Frequency (MHz)	Substituted level (dBm)	Polarity (H/V)	Antenna Gain Correction (dB)	Cable Loss (dB)	Corrected Reading (dBm)	Limit (dBm)	Margin (dB)
1648.4	-42.91	V	7.95	0.78	-35.74	-13	-22.74
1648.4	-43.25	H	7.95	0.78	-36.08	-13	-23.08
263.9	-51.47	V	6.1	0.23	-45.6	-13	-32.60
527.3	-51.34	H	6.6	0.35	-45.09	-13	-32.09

Middle channel

Frequency (MHz)	Substituted level (dBm)	Polarity (H/V)	Antenna Gain Correction (dB)	Cable Loss (dB)	Corrected Reading (dBm)	Limit (dBm)	Margin (dB)
1673.2	-42.86	V	7.95	0.78	-35.69	-13	-22.69
1673.2	-43.11	H	7.95	0.78	-35.94	-13	-22.94
263.5	-51.38	V	6.1	0.23	-45.51	-13	-32.51
527.8	-51.25	H	6.6	0.35	-45	-13	-32.00

High channel

Frequency (MHz)	Substituted level (dBm)	Polarity (H/V)	Antenna Gain Correction (dB)	Cable Loss (dB)	Corrected Reading (dBm)	Limit (dBm)	Margin (dB)
1697.6	-42.79	V	7.95	0.78	-35.62	-13	-22.62
1697.6	-42.95	H	7.95	0.78	-35.78	-13	-22.78
263.1	-51.63	V	6.1	0.23	-45.76	-13	-32.76
527.4	-51.38	H	6.6	0.35	-45.13	-13	-32.13

Note:

1, The testing has been conformed to $10 \times 848.8 \text{ MHz} = 8,488 \text{ MHz}$

2, All other emissions more than 30 dB below the limit

3, GSM voice, GPRS and EGPRS mode were investigated. The results above show only the worse cases

4, X-Axis, Y-Axis and Z-Axis were investigated. The results above show only the worst case.

PCS Band (Part24E) result

Low channel

Frequency (MHz)	Substituted level (dBm)	Polarity (H/V)	Antenna Gain Correction (dB)	Cable Loss (dB)	Corrected Reading (dBm)	Limit (dBm)	Margin (dB)
3700.4	-47.91	V	10.25	2.73	-40.39	-13	-27.39
3700.4	-48.16	H	10.25	2.73	-40.64	-13	-27.64
262.9	-52.38	V	6.1	0.23	-46.51	-13	-33.51
528.3	-52.51	H	6.6	0.35	-46.26	-13	-33.26

Middle channel

Frequency (MHz)	Substituted level (dBm)	Polarity (H/V)	Antenna Gain Correction (dB)	Cable Loss (dB)	Corrected Reading (dBm)	Limit (dBm)	Margin (dB)
3760	-48.05	V	10.25	2.73	-40.53	-13	-27.53
3760	-47.88	H	10.25	2.73	-40.36	-13	-27.36
262.5	-52.61	V	6.1	0.23	-46.74	-13	-33.74
527.9	-52.37	H	6.6	0.35	-46.12	-13	-33.12

High channel

Frequency (MHz)	Substituted level (dBm)	Polarity (H/V)	Antenna Gain Correction (dB)	Cable Loss (dB)	Corrected Reading (dBm)	Limit (dBm)	Margin (dB)
3819.6	-47.86	V	10.36	2.73	-40.23	-13	-27.23
3819.6	-47.51	H	10.36	2.73	-39.88	-13	-26.88
262.7	-52.37	V	6.1	0.23	-46.5	-13	-33.50
528.1	-52.62	H	6.6	0.35	-46.37	-13	-33.37

Note:

- 1, The testing has been conformed to $10 \times 1909.8 \text{ MHz} = 19,098 \text{ MHz}$
- 2, All other emissions more than 30 dB below the limit
- 3, GSM voice, GPRS and EGPRS mode were investigated. The results above show only the worse cases
- 4, X-Axis, Y-Axis and Z-Axis were investigated. The results above show only the worst case.

UMTS-FDD Band V (Part 22H)

Low channel

Frequency (MHz)	Substituted level (dBm)	Polarity (H/V)	Antenna Gain Correction (dB)	Cable Loss (dB)	Corrected Reading (dBm)	Limit (dBm)	Margin (dB)
1652.8	-45.18	V	7.95	0.78	-38.01	-13	-25.01
1652.8	-45.33	H	7.95	0.78	-38.16	-13	-25.16
264.3	-51.61	V	6.1	0.23	-45.74	-13	-32.74
528.7	-51.47	H	6.6	0.35	-45.22	-13	-32.22

Middle channel

Frequency (MHz)	Substituted level (dBm)	Polarity (H/V)	Antenna Gain Correction (dB)	Cable Loss (dB)	Corrected Reading (dBm)	Limit (dBm)	Margin (dB)
1670	-45.23	V	7.95	0.78	-38.06	-13	-25.06
1670	-45.81	H	7.95	0.78	-38.64	-13	-25.64
264.5	-51.49	V	6.1	0.23	-45.62	-13	-32.62
528.1	-51.35	H	6.6	0.35	-45.1	-13	-32.10

High channel

Frequency (MHz)	Substituted level (dBm)	Polarity (H/V)	Antenna Gain Correction (dB)	Cable Loss (dB)	Corrected Reading (dBm)	Limit (dBm)	Margin (dB)
1693.2	-45.48	V	7.95	0.78	-38.31	-13	-25.31
1693.2	-45.63	H	7.95	0.78	-38.46	-13	-25.46
264.9	-51.39	V	6.1	0.23	-45.52	-13	-32.52
528.5	-51.24	H	6.6	0.35	-44.99	-13	-31.99

Note:

- 1, The testing has been conformed to $10 \times 846.6 \text{ MHz} = 8,466 \text{ MHz}$
- 2, All other emissions more than 30 dB below the limit
- 3, RMC, HSUPA and HSDPA mode were investigated. The results above show only the worse cases
- 4, X-Axis, Y-Axis and Z-Axis were investigated. The results above show only the worst case.

UMTS-FDD Band II (Part 24E)

Low channel

Frequency (MHz)	Substituted level (dBm)	Polarity (H/V)	Antenna Gain Correction (dB)	Cable Loss (dB)	Corrected Reading (dBm)	Limit (dBm)	Margin (dB)
3704.8	-45.62	V	10.25	2.73	-38.1	-13	-25.10
3704.8	-45.47	H	10.25	2.73	-37.95	-13	-24.95
261.4	-51.58	V	6.1	0.23	-45.71	-13	-32.71
526.7	-51.33	H	6.6	0.35	-45.08	-13	-32.08

Middle channel

Frequency (MHz)	Substituted level (dBm)	Polarity (H/V)	Antenna Gain Correction (dB)	Cable Loss (dB)	Corrected Reading (dBm)	Limit (dBm)	Margin (dB)
3760	-45.18	V	10.25	2.73	-37.66	-13	-24.66
3760	-45.24	H	10.25	2.73	-37.72	-13	-24.72
261.7	-51.73	V	6.1	0.23	-45.86	-13	-32.86
526.2	-51.49	H	6.6	0.35	-45.24	-13	-32.24

High channel

Frequency (MHz)	Substituted level (dBm)	Polarity (H/V)	Antenna Gain Correction (dB)	Cable Loss (dB)	Corrected Reading (dBm)	Limit (dBm)	Margin (dB)
3815.2	-45.31	V	10.36	2.73	-37.68	-13	-24.68
3815.2	-45.17	H	10.36	2.73	-37.54	-13	-24.54
261.4	-52.05	V	6.1	0.23	-46.18	-13	-33.18
526.8	-51.82	H	6.6	0.35	-45.57	-13	-32.57

Note:

- 1, The testing has been conformed to $10 \times 1907.6 \text{ MHz} = 19,076 \text{ MHz}$
- 2, All other emissions more than 30 dB below the limit
- 3, RMC, HSUPA and HSDPA mode were investigated. The results above show only the worse cases
- 4, X-Axis, Y-Axis and Z-Axis were investigated. The results above show only the worst case

6.7 Band Edge

Temperature	25°C
Relative Humidity	53%
Atmospheric Pressure	1020mbar
Test date :	June 20, 2016
Tested By :	Loren Luo

Requirement(s):

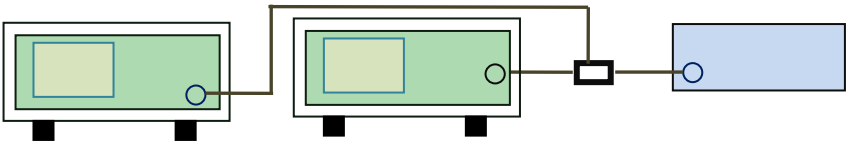
Spec	Item	Requirement	Applicable
§22.917(a) §24.238(a)	a)	The power of any emission outside of the authorized operating frequency ranges must be lower than the transmitter power (P) by a factor of at least $43 + 10 \log (P)$ dB.	<input checked="" type="checkbox"/>
Test setup			
Procedure	<ul style="list-style-type: none"> - The EUT was connected to Spectrum Analyzer and Base Station via power divider. - The Band Edges of low and high channels for the highest RF powers were measured. Setting RBW as roughly BW/100. 		
Remark			
Result	<input checked="" type="checkbox"/> Pass <input type="checkbox"/> Fail		

Test Data Yes N/A

Test Plot Yes (See below) N/A

GSM Voice:

Cellular Band (Part 22H) result

Frequency (MHz)	Emission (dBm)	Limit (dBm)
823.9950	-19.278	-13
849.0175	-16.380	-13

PCS Band (Part24E) result

Frequency (MHz)	Emission (dBm)	Limit (dBm)
1849.990	-16.948	-13
1910.020	-16.644	-13

GPRS:

Cellular Band (Part 22H) result

Frequency (MHz)	Emission (dBm)	Limit (dBm)
823.9900	-18.973	-13
849.0200	-17.878	-13

PCS Band (Part24E) result

Frequency (MHz)	Emission (dBm)	Limit (dBm)
1849.9825	-17.029	-13
1910.0025	-16.610	-13

EGPRS (MCS5):

Cellular Band (Part 22H) result

Frequency (MHz)	Emission (dBm)	Limit (dBm)
823.990	-15.775	-13
849.010	-17.327	-13

PCS Band (Part24E) result

Frequency (MHz)	Emission (dBm)	Limit (dBm)
1849.9825	-17.209	-13
1910.0025	-17.425	-13

RMC:

UMTS-FDD Band V (Part 22H)

Frequency (MHz)	Emission (dBm)	Limit (dBm)
823.017	-27.934	-13
849.033	-22.145	-13

UMTS-FDD Band II (Part 24E)

Frequency (MHz)	Emission (dBm)	Limit (dBm)
1849.983	-31.082	-13
1910.033	-31.917	-13

HSUPA:

UMTS-FDD Band V (Part 22H)

Frequency (MHz)	Emission (dBm)	Limit (dBm)
823.267	-29.771	-13
849.033	-21.568	-13

UMTS-FDD Band II (Part 24E)

Frequency (MHz)	Emission (dBm)	Limit (dBm)
1848.967	-32.961	-13
1910.017	-31.552	-13

HSDPA:

UMTS-FDD Band V (Part 22H)

Frequency (MHz)	Emission (dBm)	Limit (dBm)
823.417	-28.707	-13
849.150	-25.407	-13

UMTS-FDD Band II (Part 24E)

Frequency (MHz)	Emission (dBm)	Limit (dBm)
1849.183	-32.488	-13
1910.383	-31.749	-13

**GSM Voice:
Test Plots**



Cellular Band - Low Channel

Note: Offset=Cable loss (4.0) + 10log
(3.18/3)=4.0+0.4=4.4dB



Cellular Band - High Channel

Note: Offset=Cable loss (4.0) + 10log
(3.27/3)=4.0+0.4=4.4dB

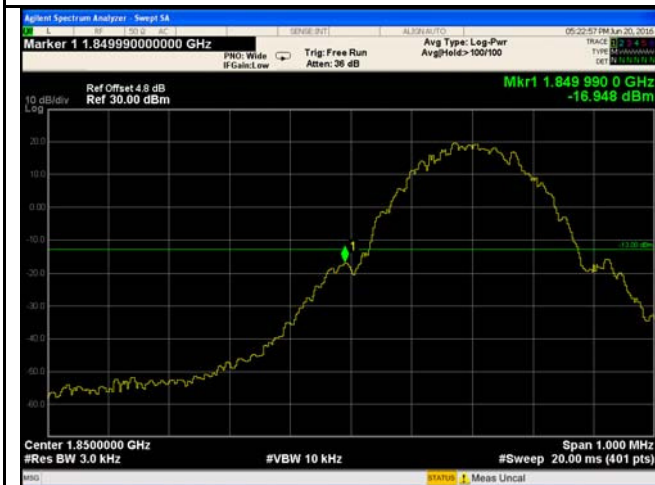

PCS Band - Low Channel

Note: Offset=Cable loss (4.0) + 10log
(3.19/3)=4.5+0.3=4.8dB



PCS Band - High Channel

Note: Offset=Cable loss (4.0) + 10log
(3.25/3)=4.5+0.4=4.9dB

GPRS:

Test Plots



Cellular Band - Low Channel

Note: Offset=Cable loss (4.0) + 10log
(3.24/3)=4.0+0.3=4.3dB



Cellular Band - High Channel

Note: Offset=Cable loss (4.0) + 10log
(3.20/3)=4.0+0.3=4.3dB

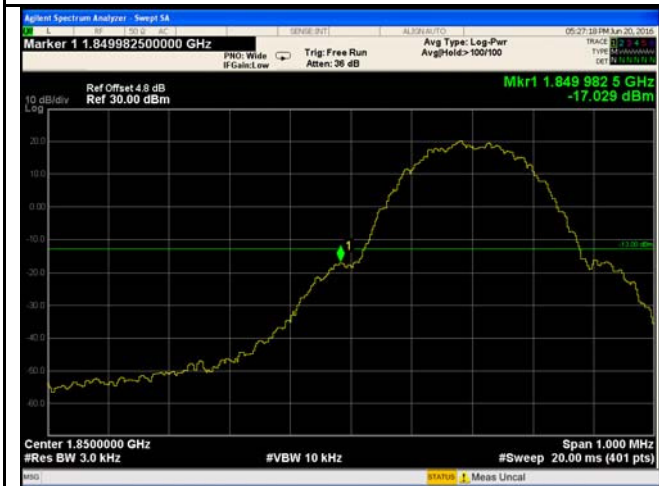

PCS Band - Low Channel

Note: Offset=Cable loss (4.5) + 10log
(3.19/3)=4.5+0.3=4.8dB



PCS Band - High Channel

Note: Offset=Cable loss (4.5) + 10log
(3.17/3)=4.5+0.3=4.8dB

EGPRS (MCS5):

Test Plots



Cellular Band - Low Channel

Note: Offset=Cable loss (4.0) + 10log
(3.19/3)=4.0+0.3=4.3dB



Cellular Band - High Channel

Note: Offset=Cable loss (4.0) + 10log
(3.28/3)=4.0+0.4=4.4dB

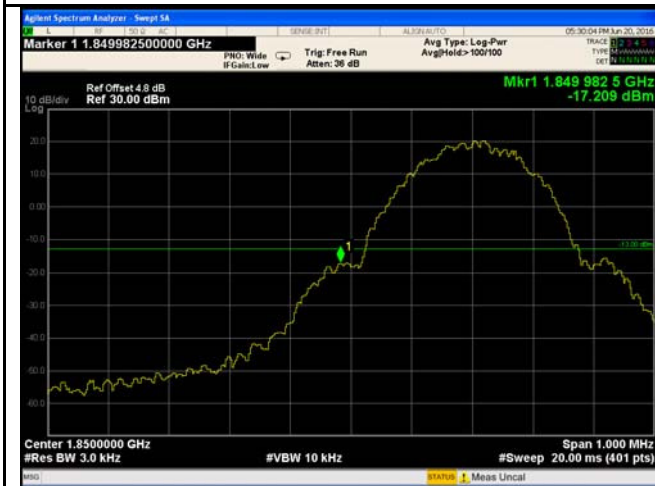

PCS Band - Low Channel

Note: Offset=Cable loss (4.5) + 10log
(3.18/3)=4.5+0.3=4.8dB



PCS Band - High Channel

Note: Offset=Cable loss (4.5) + 10log
(3.18/3)=4.5+0.3=4.8dB

RMC:



UMTS-FDD Band V - Low Channel

Note: Offset=Cable loss (4.0) + 10log
(50.54/30)=4.0+2.3=6.3 dB

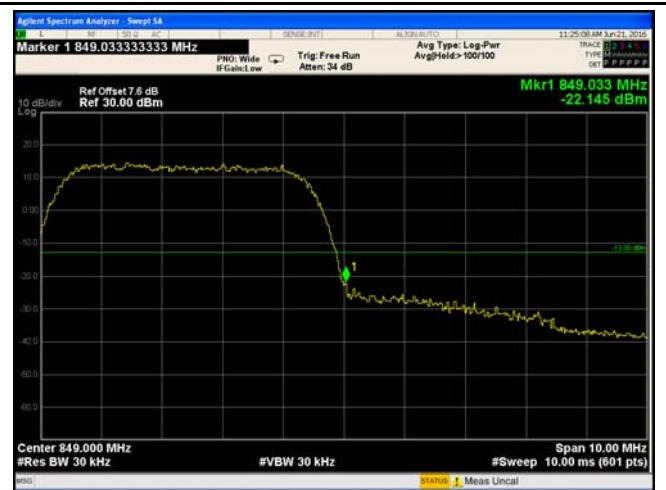

UMTS-FDD Band V - High Channel

Note: Offset=Cable loss (4.0) + 10log
(68.86/30)=4.0+3.6=7.6 dB



UMTS-FDD Band II - Low Channel

Note: Offset=Cable loss (4.5) + 10log
(49.61/30)=4.5+2.0=6.2 dB



UMTS-FDD Band II - High Channel

Note: Offset=Cable loss (4.5) + 10log
(49.83/30)=4.0+2.2=6.2 dB

HSUPA:



UMTS-FDD Band V - Low Channel

Note: Offset=Cable loss (4.0) + 10log
(50.89/30)=4.0+2.3=6.3 dB



UMTS-FDD Band V - High Channel

Note: Offset=Cable loss (4.0) + 10log
(69.14/30)=4.0+3.6=7.6 dB



UMTS-FDD Band II - Low Channel

Note: Offset=Cable loss (4.5) + 10log
(49.71/30)=4.0+2.2=6.5 dB



UMTS-FDD Band II - High Channel

Note: Offset=Cable loss (4.5) + 10log
(49.61/30)=4.0+2.2=6.5 dB

HSDPA:

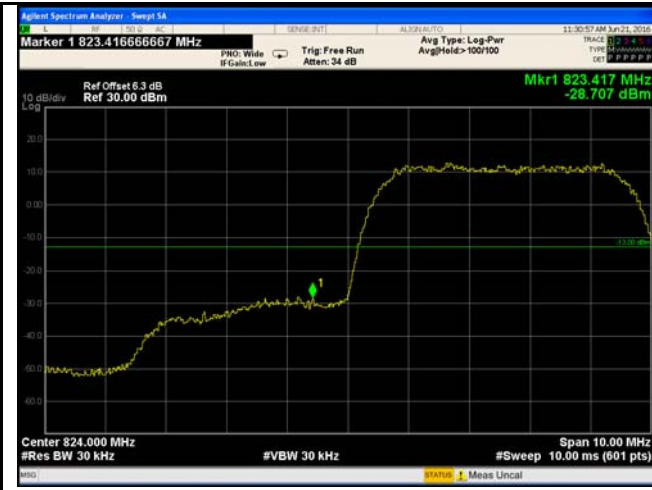

UMTS-FDD Band V - Low Channel

Note: Offset=Cable loss (4.0) + 10log
(50.73/30)=4.0+2.3=6.3 dB

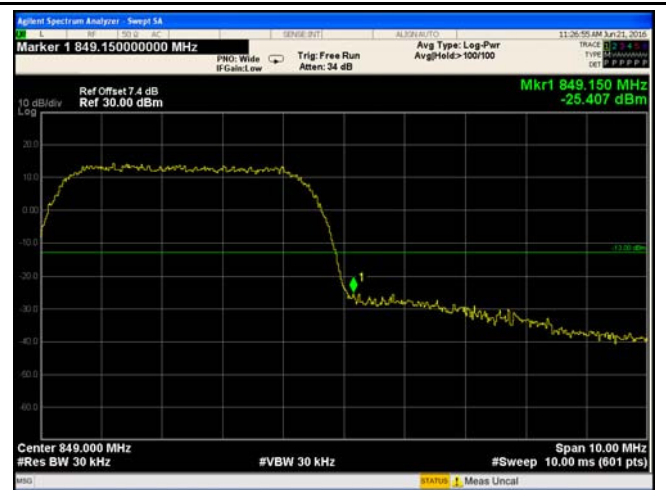

UMTS-FDD Band V - High Channel

Note: Offset=Cable loss (4.0) + 10log
(66.35/30)=4.0+3.4=7.4 dB

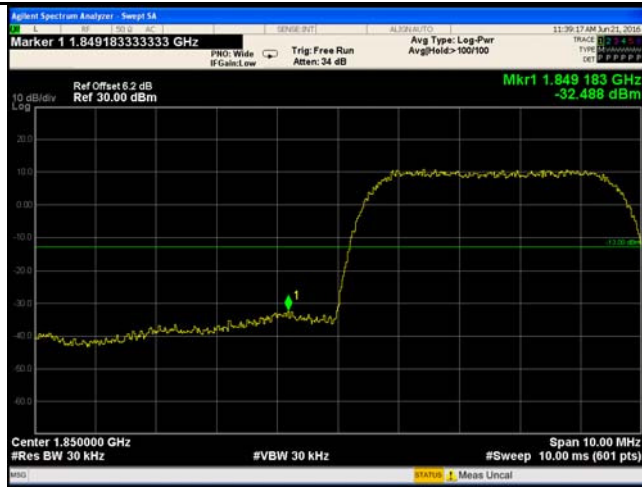

UMTS-FDD Band II - Low Channel

Note: Offset=Cable loss (4.5) + 10log
(49.82/30)=4.5+2.0=6.2 dB



UMTS-FDD Band II - High Channel

Note: Offset=Cable loss (4.5) + 10log
(49.6/30)=4.5+2.0=6.2 dB

6.8 Frequency Stability

Temperature	25°C
Relative Humidity	53%
Atmospheric Pressure	1020mbar
Test date :	June 20, 2016
Tested By :	Loren Luo

Requirement(s):

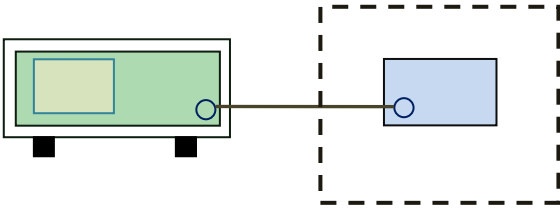
Spec	Item	Requirement	Applicable																																
§2.1055, §22.355 & §24.235	a)	<p>According to §22.355, the carrier frequency of each transmitter in the Public Mobile Services must be maintained within the tolerances given in Table below:</p> <p>Frequency Tolerance for Transmitters in the Public Mobile Services</p> <table border="1"> <thead> <tr> <th>Frequency Range (MHz)</th> <th>Base, fixed (ppm)</th> <th>Mobile ≤ 3 watts (ppm)</th> <th>Mobile ≤ 3 watts (ppm)</th> </tr> </thead> <tbody> <tr> <td>25 to 50</td> <td>20.0</td> <td>20.0</td> <td>50.0</td> </tr> <tr> <td>50 to 450</td> <td>5.0</td> <td>5.0</td> <td>50.0</td> </tr> <tr> <td>45 to 512</td> <td>2.5</td> <td>5.0</td> <td>.0</td> </tr> <tr> <td>821 to 896</td> <td>1.5</td> <td>2.5</td> <td>2.5</td> </tr> <tr> <td>928 to 29.</td> <td>5.0</td> <td>N/A</td> <td>N/A</td> </tr> <tr> <td>929 to 960.</td> <td>1.5</td> <td>N/A</td> <td>N/A</td> </tr> <tr> <td>2110 to 2220</td> <td>10.0</td> <td>N/A</td> <td>N/A</td> </tr> </tbody> </table> <p>According to §24.235, the frequency stability shall be sufficient to ensure that the fundamental emissions stay within the authorized frequency block.</p>	Frequency Range (MHz)	Base, fixed (ppm)	Mobile ≤ 3 watts (ppm)	Mobile ≤ 3 watts (ppm)	25 to 50	20.0	20.0	50.0	50 to 450	5.0	5.0	50.0	45 to 512	2.5	5.0	.0	821 to 896	1.5	2.5	2.5	928 to 29.	5.0	N/A	N/A	929 to 960.	1.5	N/A	N/A	2110 to 2220	10.0	N/A	N/A	<input checked="" type="checkbox"/>
		Frequency Range (MHz)	Base, fixed (ppm)	Mobile ≤ 3 watts (ppm)	Mobile ≤ 3 watts (ppm)																														
		25 to 50	20.0	20.0	50.0																														
		50 to 450	5.0	5.0	50.0																														
		45 to 512	2.5	5.0	.0																														
		821 to 896	1.5	2.5	2.5																														
		928 to 29.	5.0	N/A	N/A																														
		929 to 960.	1.5	N/A	N/A																														
2110 to 2220	10.0	N/A	N/A																																
Test setup																																			

Test Report	16070559-FCC-R1
Page	69 of 88

Procedure	A communication link was established between EUT and base station. The frequency error was monitored and measured by base station under variation of ambient temperature and variation of primary supply voltage. Limit: The frequency stability of the transmitter shall be maintained within $\pm 0.00025\%$ ($\pm 2.5\text{ppm}$) of the center frequency.
Remark	
Result	<input checked="" type="checkbox"/> Pass <input type="checkbox"/> Fail

Test Data Yes N/A

Test Plot Yes (See below) N/A

GSM Voice:

Cellular Band (Part 22H) result

Middle Channel, $f_0 = 836.6$ MHz				
Temperature (°C)	Power Supplied (V _{DC})	Frequency Error (Hz)	Frequency Error (ppm)	Limit (ppm)
-10	3.7	22	0.0263	2.5
0		15	0.0179	2.5
10		16	0.0191	2.5
20		17	0.0203	2.5
30		11	0.0131	2.5
40		17	0.0203	2.5
50		18	0.0215	2.5
55		21	0.0251	2.5
25	4.2	20	0.0239	2.5
	3.5	16	0.0191	2.5

PCS Band (Part 24E) result

Middle Channel, $f_0 = 1880$ MHz				
Temperature (°C)	Power Supplied (V _{DC})	Frequency Error (Hz)	Frequency Error (ppm)	Limit (ppm)
-10	3.7	10	0.0053	2.5
0		15	0.0080	2.5
10		14	0.0074	2.5
20		11	0.0059	2.5
30		15	0.0080	2.5
40		16	0.0085	2.5
50		14	0.0074	2.5
55		16	0.0085	2.5
25	4.2	14	0.0074	2.5
	3.5	20	0.0106	2.5

GPRS:

Cellular Band (Part 22H) result

Middle Channel, $f_0 = 836.6$ MHz				
Temperature (°C)	Power Supplied (V _{DC})	Frequency Error (Hz)	Frequency Error (ppm)	Limit (ppm)
-10	3.7	21	0.0251	2.5
0		19	0.0227	2.5
10		14	0.0167	2.5
20		11	0.0131	2.5
30		12	0.0143	2.5
40		14	0.0167	2.5
50		15	0.0179	2.5
55		20	0.0239	2.5
25	4.2	18	0.0215	2.5
	3.5	21	0.0251	2.5

PCS Band (Part 24E) result

Middle Channel, $f_0 = 1880$ MHz				
Temperature (°C)	Power Supplied (V _{DC})	Frequency Error (Hz)	Frequency Error (ppm)	Limit (ppm)
-10	3.7	18	0.0096	2.5
0		16	0.0085	2.5
10		13	0.0069	2.5
20		14	0.0074	2.5
30		12	0.0064	2.5
40		19	0.0101	2.5
50		15	0.0080	2.5
55		16	0.0085	2.5
25	4.2	21	0.0112	2.5
	3.5	20	0.0106	2.5

EGPRS (MCS5):

Cellular Band (Part 22H) result

Middle Channel, $f_0 = 836.6$ MHz				
Temperature (°C)	Power Supplied (V _{DC})	Frequency Error (Hz)	Frequency Error (ppm)	Limit (ppm)
-10	3.7	21	0.0251	2.5
0		15	0.0179	2.5
10		17	0.0203	2.5
20		18	0.0215	2.5
30		14	0.0167	2.5
40		17	0.0203	2.5
50		21	0.0251	2.5
55		21	0.0251	2.5
25	4.2	19	0.0227	2.5
	3.5	15	0.0179	2.5

PCS Band (Part 24E) result

Middle Channel, $f_0 = 1880$ MHz				
Temperature (°C)	Power Supplied (V _{DC})	Frequency Error (Hz)	Frequency Error (ppm)	Limit (ppm)
-10	3.7	21	0.0112	2.5
0		18	0.0096	2.5
10		17	0.0090	2.5
20		11	0.0059	2.5
30		15	0.0080	2.5
40		13	0.0069	2.5
50		11	0.0059	2.5
55		21	0.0112	2.5
25	4.2	20	0.0106	2.5
	3.5	14	0.0074	2.5

RMC:

UMTS-FDD Band V (Part 22H)

Middle Channel, $f_0 = 835$ MHz				
Temperature (°C)	Power Supplied (V _{DC})	Frequency Error (Hz)	Frequency Error (ppm)	Limit (ppm)
-10	3.7	15	0.0080	2.5
0		11	0.0059	2.5
10		13	0.0069	2.5
20		10	0.0053	2.5
30		13	0.0069	2.5
40		14	0.0074	2.5
50		12	0.0064	2.5
55		14	0.0074	2.5
25	4.2	17	0.0090	2.5
	3.5	18	0.0096	2.5

UMTS-FDD Band II (Part 24E)

Middle Channel, $f_0 = 1880$ MHz				
Temperature (°C)	Power Supplied (V _{DC})	Frequency Error (Hz)	Frequency Error (ppm)	Limit (ppm)
-10	3.7	15	0.0180	2.5
0		13	0.0156	2.5
10		14	0.0168	2.5
20		17	0.0204	2.5
30		11	0.0132	2.5
40		12	0.0144	2.5
50		17	0.0204	2.5
55		18	0.0216	2.5
25		4.2	13	0.0156
	3.5	16	0.0192	2.5

HSUPA:

UMTS-FDD Band V (Part 22H)

Middle Channel, $f_0 = 835$ MHz				
Temperature (°C)	Power Supplied (V _{DC})	Frequency Error (Hz)	Frequency Error (ppm)	Limit (ppm)
-10	3.7	17	0.0090	2.5
0		14	0.0074	2.5
10		15	0.0080	2.5
20		13	0.0069	2.5
30		17	0.0090	2.5
40		14	0.0074	2.5
50		14	0.0074	2.5
55		18	0.0096	2.5
25	4.2	15	0.0080	2.5
	3.5	20	0.0106	2.5

UMTS-FDD Band II (Part 24E)

Middle Channel, $f_0 = 1880$ MHz				
Temperature (°C)	Power Supplied (V _{DC})	Frequency Error (Hz)	Frequency Error (ppm)	Limit (ppm)
-10	3.7	17	0.0204	2.5
0		15	0.0180	2.5
10		12	0.0144	2.5
20		13	0.0156	2.5
30		16	0.0192	2.5
40		13	0.0156	2.5
50		17	0.0204	2.5
55		19	0.0228	2.5
25		4.2	20	0.0240
	3.5	19	0.0228	2.5

HSDPA:

UMTS-FDD Band V (Part 22H)

Middle Channel, $f_0 = 835$ MHz				
Temperature (°C)	Power Supplied (V _{DC})	Frequency Error (Hz)	Frequency Error (ppm)	Limit (ppm)
-10	3.7	21	0.0112	2.5
0		15	0.0080	2.5
10		10	0.0053	2.5
20		10	0.0053	2.5
30		12	0.0064	2.5
40		14	0.0074	2.5
50		17	0.0090	2.5
55		19	0.0101	2.5
25	4.2	15	0.0080	2.5
	3.5	14	0.0074	2.5

UMTS-FDD Band II (Part 24E)

Middle Channel, $f_0 = 1880$ MHz				
Temperature (°C)	Power Supplied (V _{DC})	Frequency Error (Hz)	Frequency Error (ppm)	Limit (ppm)
-10	3.7	20	0.0240	2.5
0		17	0.0204	2.5
10		14	0.0168	2.5
20		11	0.0132	2.5
30		13	0.0156	2.5
40		14	0.0168	2.5
50		12	0.0144	2.5
55		21	0.0251	2.5
25	4.2	18	0.0216	2.5
	3.5	20	0.0240	2.5

Annex A. TEST INSTRUMENT

Instrument	Model	Serial #	Cal Date	Cal Due	In use
RF Conducted Test					
Agilent ESA-E SERIES SPECTRUM ANALYZER	E4407B	MY45108319	09/16/2015	09/15/2016	<input checked="" type="checkbox"/>
Power Splitter	1#	1#	09/01/2015	08/31/2016	<input checked="" type="checkbox"/>
Universal Radio Communication Tester	CMU200	121393	09/25/2015	09/24/2016	<input checked="" type="checkbox"/>
Temperature/Humidity Chamber	UHL-270	001	10/09/2015	10/08/2016	<input checked="" type="checkbox"/>
DC Power Supply	E3640A	MY40004013	09/17/2015	09/16/2016	<input checked="" type="checkbox"/>
RF Power Sensor	Dare RPR3006C/P/W	AY554013	09/17/2015	09/16/2016	<input checked="" type="checkbox"/>
Radiated Emissions					
EMI test receiver	ESL6	100262	09/17/2015	09/16/2016	<input checked="" type="checkbox"/>
OPT 010 AMPLIFIER (0.1-1300MHz)	8447E	2727A02430	09/01/2015	08/31/2016	<input checked="" type="checkbox"/>
Microwave Preamplifier (1 ~ 26.5GHz)	8449B	3008A02402	03/24/2016	03/23/2017	<input checked="" type="checkbox"/>
Bilog Antenna (30MHz~6GHz)	JB6	A110712	09/21/2015	09/20/2016	<input checked="" type="checkbox"/>
Bilog Antenna (30MHz~2GHz)	JB1	A112017	09/21/2015	09/20/2016	<input checked="" type="checkbox"/>
Double Ridge Horn Antenna (1 ~18GHz)	AH-118	71259	09/24/2015	09/23/2016	<input checked="" type="checkbox"/>
Double Ridge Horn Antenna (1 ~18GHz)	AH-118	71283	09/24/2015	09/23/2016	<input checked="" type="checkbox"/>
SYNTHESIZED SIGNAL GENERATOR	8665B	3744A01293	09/17/2015	09/16/2016	<input checked="" type="checkbox"/>
Power Amplifier	SMC150D	R1553-0313	03/09/2016	03/08/2017	<input checked="" type="checkbox"/>
Power Amplifier	S41-25D	R1553-0314	05/27/2016	05/26/2017	<input checked="" type="checkbox"/>
Tunable Notch Filter	3NF-800/1000-S	AA4	09/01/2015	08/31/2016	<input checked="" type="checkbox"/>

Test Report	16070559-FCC-R1
Page	77 of 88

Tunable Notch Filter	3NF- 1000/2000-S	AM 4	09/01/2015	08/31/2016	<input checked="" type="checkbox"/>
----------------------	---------------------	------	------------	------------	-------------------------------------

Annex B. EUT And Test Setup Photographs

Annex B.i. Photograph: EUT External Photo

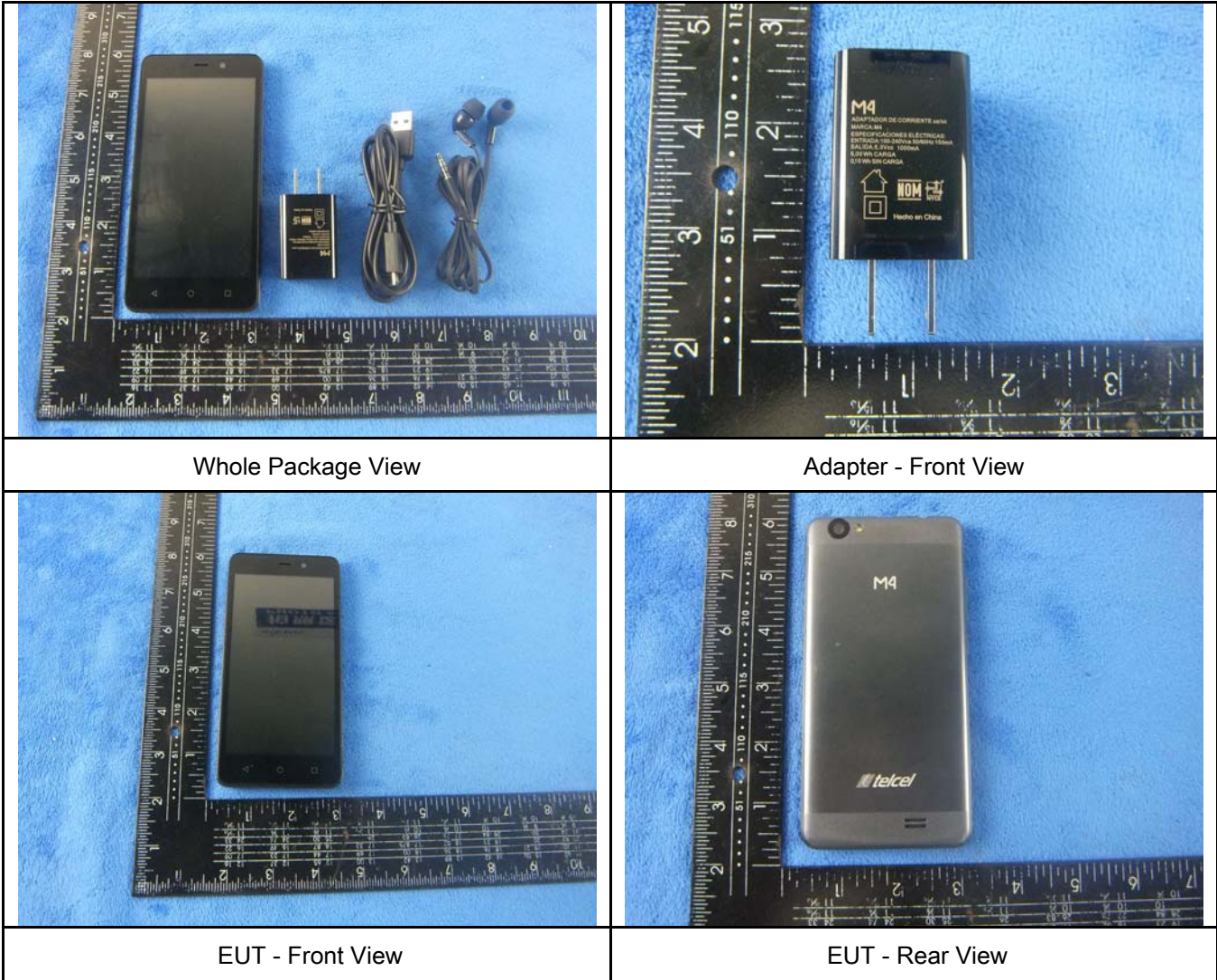



EUT - Top View



EUT - Bottom View



EUT - Left View



EUT - Right View

Annex B.ii. Photograph: EUT Internal Photo



Cover Off - Top View 1



Cover Off - Top View 2



Battery - Front View



Battery - Rear View

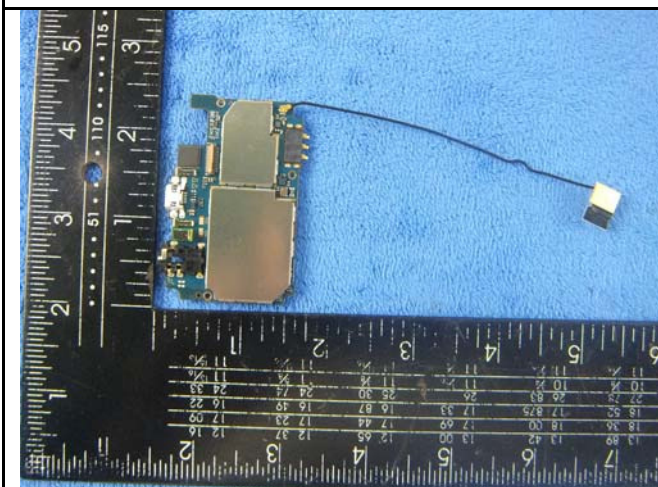

Mainboard with Shielding - Front View

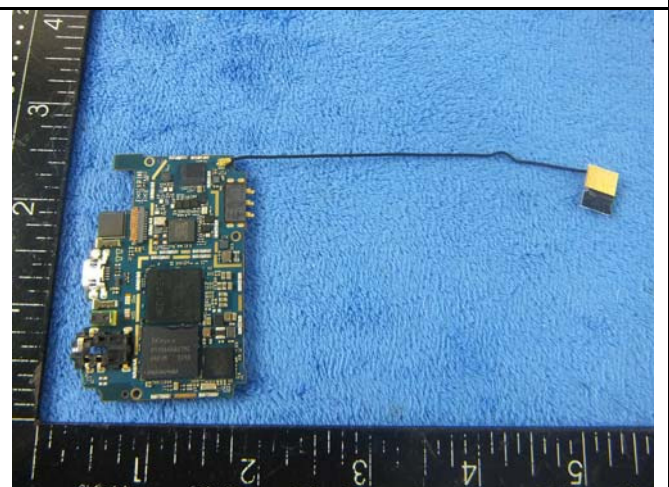

Mainboard without Shielding - Front View

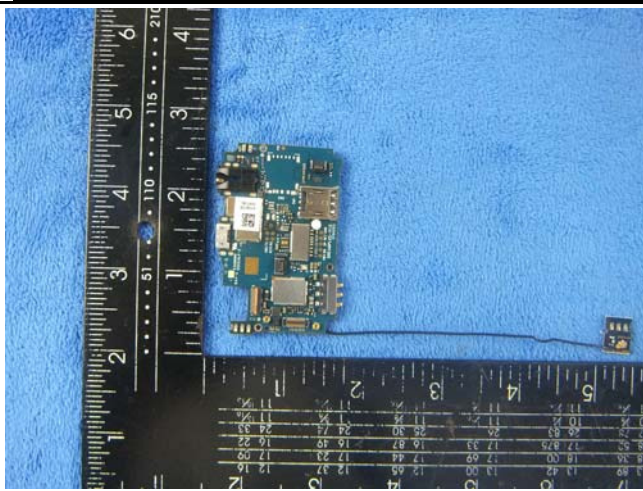

Mainboard with Shielding - Rear View

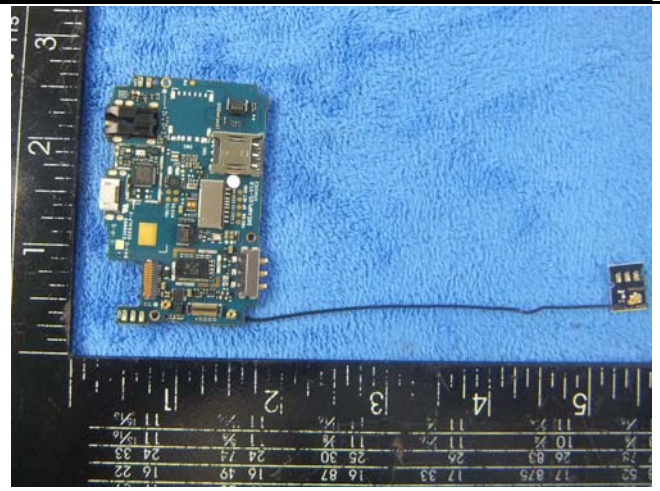

Mainboard without Shielding - Rear View



LCD – Front View



LCD – Rear View



GSM/PCS/UMTS-FDD/LTE Antenna View



WIFI/BT/BLE/GPS - Antenna View



LTE DRX Antenna

Annex B.iii. Photograph: Test Setup Photo

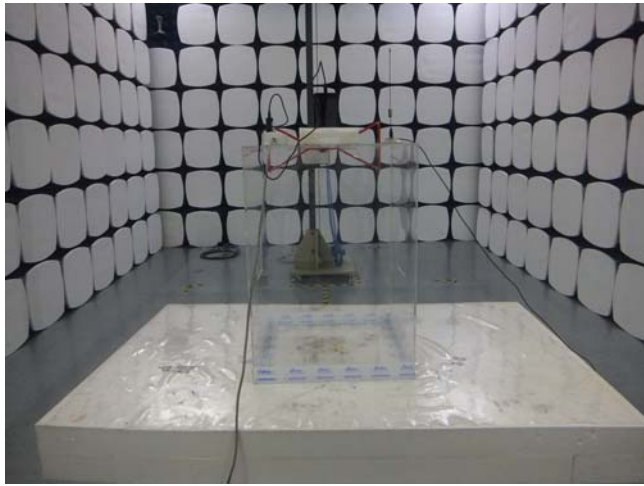

Radiated Spurious Emissions Test Setup Below 1GHz

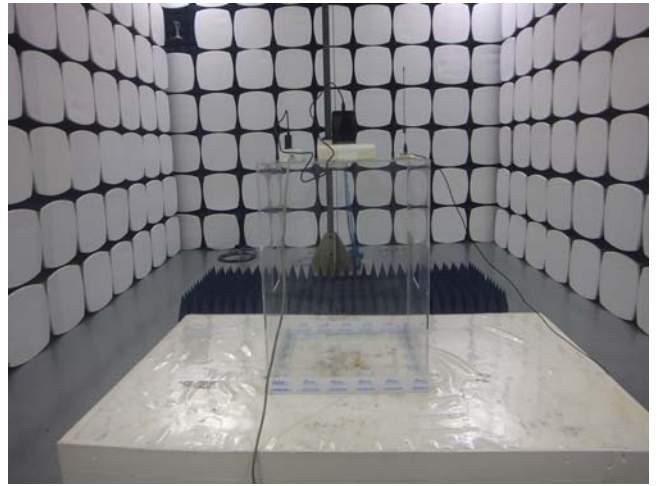

Radiated Spurious Emissions Test Setup Above
1GHz

Annex C. TEST SETUP AND SUPPORTING EQUIPMENT

Annex C.ii. TEST SET UP BLOCK

Block Configuration Diagram for Radiated Emissions

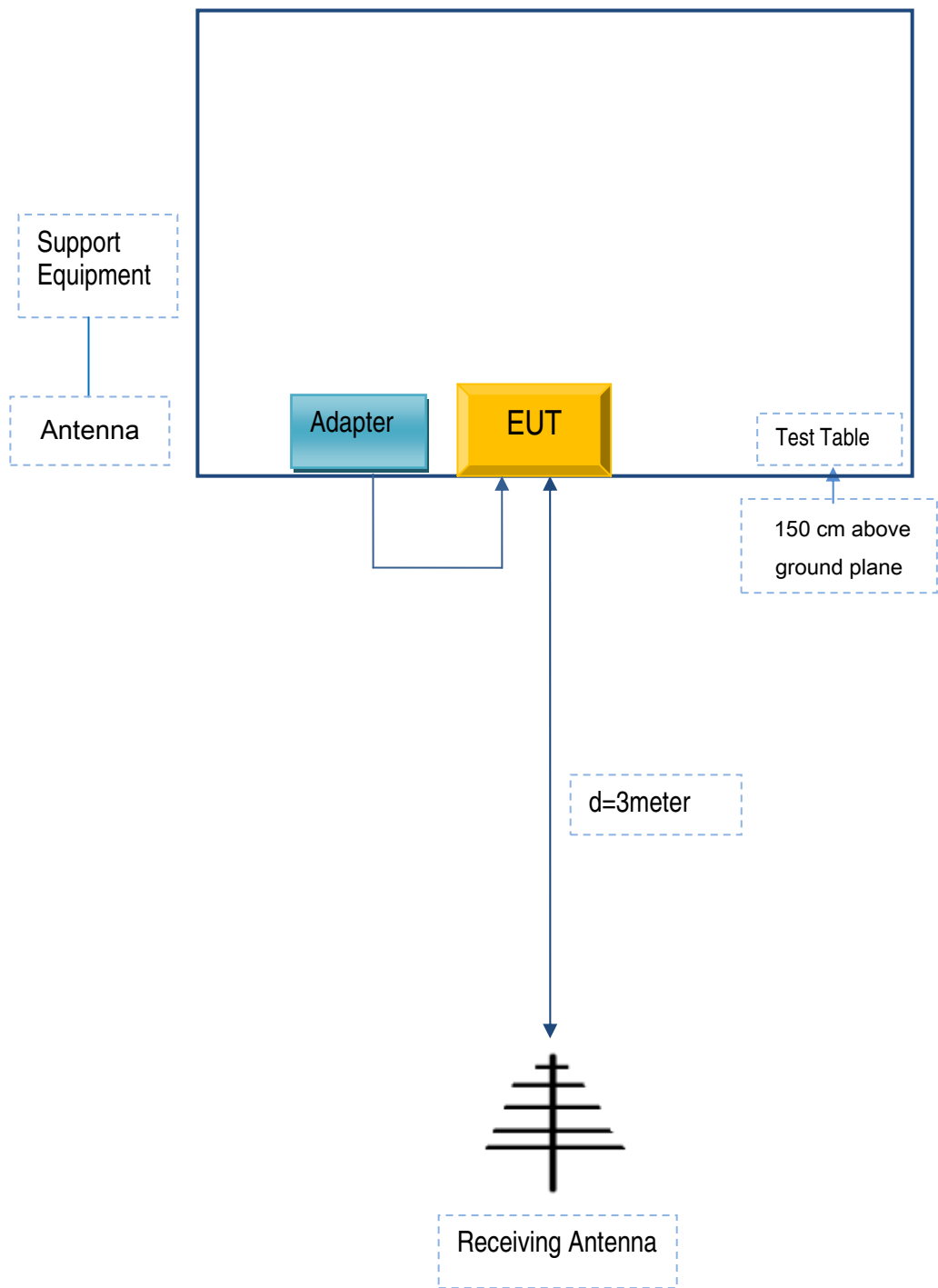

Annex C. ii. SUPPORTING EQUIPMENT DESCRIPTION

The following is a description of supporting equipment and details of cables used with the EUT.

Supporting Equipment:

Manufacturer	Equipment Description	Model	Serial No
MFOURTEL MEXICO S.A. DE C.V.	Adapter	M4	YK84201153021

Supporting Cable:

Cable type	Shield Type	Ferrite Core	Length	Serial No
USB Cable	Un-shielding	No	0.8m	YK84201153021

Test Report	16070559-FCC-R1
Page	86 of 88

Annex C.ii. EUT OPERATING CONKITIONS

N/A

Test Report	16070559-FCC-R1
Page	87 of 88

Annex D. User Manual / Block Diagram / Schematics / Partlist

See attachment

Test Report	16070559-FCC-R1
Page	88 of 88

Annex E. DECLARATION OF SIMILARITY

N/A