



RF TEST REPORT

Report No.: SET2015-01608

Product Name: LTE Mobile Phone

FCC ID: CLNSS4445T

Model No. : M4 SS4445T

Applicant: MFOURTEL MEXICO S.A. DE C.V.

Address: Av. Ejército Nacional 436 Piso 3 Chapultepec Morales Miguel Hidalgo Distrito Federal 11570.

Issued by: CCIC-SET

Lab Location: Electronic Testing Building, Shahe Road, Xili, Nanshan District, Shenzhen, 518055, P. R. China

Tel: 86 755 26627338 **Fax:** 86 755 26627238

This test report consists of 47 pages in total. It may be duplicated completely for legal use with the approval of the applicant. It should not be reproduced except in full, without the written approval of our laboratory. The client should not use it to claim product endorsement by CCIC-SET. The test results in the report only apply to the tested sample. The test report shall be invalid without all the signatures of testing engineers, reviewer and approver. Any objections must be raised to CCIC-SET within 20 days since the date when the report is received. It will not be taken into consideration beyond this limit.



Test Report

Product Name : LTE Mobile Phone

Brand Name : M4

Trade Name : M4

Applicant : MFOURTEL MEXICO S.A. DE C.V.

Applicant Address : Av. Ejército Nacional 436 Piso 3 Chapultepec Morales
Miguel Hidalgo Distrito Federal 11570.

Manufacturer : CK Telecom Limited

Manufacturer Address : Technology Road.High-Tech Development Zone. Heyuan,
Guangdong,P.R.China.

Test Standards : 47 CFR Part 15 Subpart C: Radio Frequency Devices
ANSI C63.10:2009 : American National Standard for
Testing Unlicensed Wireless Devices
KDB558074 D01 DTS Meas Guidance v03r02

Test Result : PASS

Tested by : 
2015.01.26

Haigang He, Test Engineer

Reviewed by : 
2015.01.26

Zhu Qi, Senior EGINEER

Approved by : 
2015.01.26

Wu Li'an, Manager



TABLE OF CONTENTS

- 1. GENERAL INFORMATION 4**
- 1.1. EUT Description 4
- 1.2. Test Standards and Results..... 5
- 1.3. Facilities and Accreditations 6
- 2. 47 CFR PART 15C REQUIREMENTS..... 7**
- 2.1. Antenna requirement..... 7
- 2.2. Peak Output Power..... 8
- 2.3. Average power 11
- 2.4. 6dB & 99% Bandwidth 12
- 2.5. Conducted Spurious Emissions..... 16
- 2.6. Power spectral density (PSD) 20
- 2.7. Band Edge 23
- 2.8. Conducted Emission 26
- 2.9. Radiated Emission..... 30
- ANNEX A ACCREDITATION CERTIFICATE 38**
- ANNEX B PHOTOGRAPHS OF THE EUT..... 39**
- ANNEX C PHOTOGRAPHS OF THE TEST SETUP..... 46**
- 1. CONDUCTED MEASUREMENT SETUP 46**
- 2. RADIATED MEASUREMENT SETUP..... 47**

Change History		
Issue	Date	Reason for change
1.0	2015-01-26	First edition



1. General Information

1.1. EUT Description

EUT Type: LTE Mobile Phone
Serial No.....: SS44456B4000114
IMEI No.: 355616029894916
Hardware Version.....: A-V1.0
Software Version: M4_SS4445_S10_Ver200
Frequency Range.....: The frequency range used is 2402MHz - 2480MHz (40 channels, at intervals of 2MHz);
Modulation Type: GFSK
Antenna Type.....: PIFA Antenna
Antenna Gain.....: -1.5 dBi

Note 1: The EUT is LTE Mobile Phone, it contain Bluetooth 4.0 LTE Module operating at 2.4GHz ISM band; the frequencies allocated for the Bluetooth 4.0 LTE is $F(\text{MHz})=2402+2*n$ ($0 \leq n \leq 39$). The lowest, middle, highest channel numbers of the Bluetooth Module used and tested in this report are separately 0 (2402MHz), 20(2442MHz) and 39 (2480MHz).

Note 2: For a more detailed description, please refer to Specification or User’s Manual supplied by the applicant and/or manufacturer.

Note 3: The EUT was programmed to be in continuously transmitting mode and the transmit duty cycle is not less than 98%.”.



1.2. Test Standards and Results

The objective of the report is to perform testing according to 47 CFR Part 15 Subpart C (Bluetooth, 2.4GHz ISM band radiators) for the EUT FCC Certification:

No.	Identity	Document Title
1	47 CFR Part 15 Subpart C 2013	Radio Frequency Devices

Test detailed items/section required by FCC rules and results are as below:

No.	Section in CFR 47	Description	Result
1	15.203	Antenna Requirement	PASS
2	15.247(b)	Peak Output Power	PASS
3	15.247(b)	Average power	PASS
4	15.247(a)	6dB Bandwidth & 99% Bandwidth	PASS
5	15.247(d)	Conducted Spurious Emission	PASS
6	15.247(e)	Power spectral density (PSD)	PASS
7	15.247(d)	Band Edge	PASS
8	15.207	Conducted Emission	PASS
9	15.209 15.247(d)	Radiated Emission	PASS

The tests of Conducted Emission and Radiated Emission were performed according to the method of measurements prescribed in ANSI C63.10 2009.

These RF tests were performed according to the method of measurements prescribed in KDB558074 D01 V03r02 (04/09/2013).



1.3. Facilities and Accreditations

1.3.1. Facilities

CNAS-Lab Code: L1659

CCIC Southern Electronic Product Testing (Shenzhen) Co., Ltd. CCIC is a third party testing organization accredited by China National Accreditation Service for Conformity Assessment (CNAS) according to ISO/IEC 17025. The accreditation certificate number is L1659. A 12.8*6.8*6.4 (m) fully anechoic chamber was used for the radiated spurious emissions test.

FCC-Registration No.: 406086

CCIC Southern Electronic Product Testing (Shenzhen) Co., Ltd. EMC Laboratory has been registered and fully described in a report filed with the FCC (Federal Communications Commission). The acceptance letter from the FCC is maintained in our files. Registration 406086, valid time is until October 28, 2017.

IC-Registration No.: 11185A-1

CCIC Southern Electronic Product Testing (Shenzhen) Co., Ltd. EMC Laboratory has been registered by Certification and Engineering Bureau of Industry Canada for the performance of radiated measurements with Registration No. 11185A-1 on July. 15, 2013, valid time is until July. 15, 2016.

1.3.2. Test Environment Conditions

During the measurement, the environmental conditions were within the listed ranges:

Temperature (°C):	15 °C - 35 °C
Relative Humidity (%):	30% -60%
Atmospheric Pressure (kPa):	86KPa-106KPa



2. 47 CFR Part 15C Requirements

2.1. Antenna requirement

2.1.1. Applicable Standard

According to FCC 15.203, an intentional radiator shall be designed to ensure that no antenna other than that furnished by the responsible party shall be used with the device. The use of a permanently attached antenna or of an antenna that uses a unique coupling to the intentional radiator shall be considered sufficient to comply with the provisions of this section.

And according to FCC 47 CFR Section 15.247(c), if transmitting antennas of directional gain greater than 6dBi are used, the power shall be reduced by the amount in dB that the directional gain of the antenna exceeds 6dBi.

2.1.2. Antenna Information

Antenna Category: External antenna

An External antenna was soldered to the antenna port of EUT via an adaptor cable, can't be removed.

Antenna General Information:

No.	EUT Model	Ant. Cat.	Ant. Type	Gain(dBi)
1	LTE Mobile Phone	External	PIFA	-1.5

2.1.3. Result: comply

The EUT has a permanently and irreplaceable attached antenna. Please refer to the EUT internal photos.

2.2. Peak Output Power

2.2.1. Requirement

According to FCC section 15.247(b)(3), For systems using digital modulation in the 902-928 MHz, 2400-2483.5 MHz, and 5725-5850 MHz bands: The maximum peak conducted output power of the intentional radiator shall not exceed 1 Watt.

2.2.2. Test Description

The measured output power was calculated by the reading of the spectrum analyzer and calibration.

A. Test Setup:



The EUT (Equipment under the test) which is powered by the Battery is coupled to the Spectrum analyzer; the RF load attached to the EUT antenna terminal is 50Ohm; the path loss as the factor is calibrated to correct the reading, all test result in Spectrum analyzer.

B. Equipments List:

Description	Manufacturer	Model	Serial No.	Cal.Date	Cal.Due Date
Spectrum Analyzer	R&S	FSP40	1164.4391.40	2014.07.07	2015.07.06

2.2.3. Test Result

The lowest, middle and highest channels are selected to perform testing to verify the conducted RF output peak power of the Module.

A. Test Verdict:

Channel	Frequency (MHz)	Measured Output Peak Power (dBm)	Refer to Plot	Limit (dBm)	Verdict
0	2402	-0.09	Plot A	30	PASS
20	2442	0.27	Plot B		PASS
39	2480	0.22	Plot C		PASS

B. Test Plots:

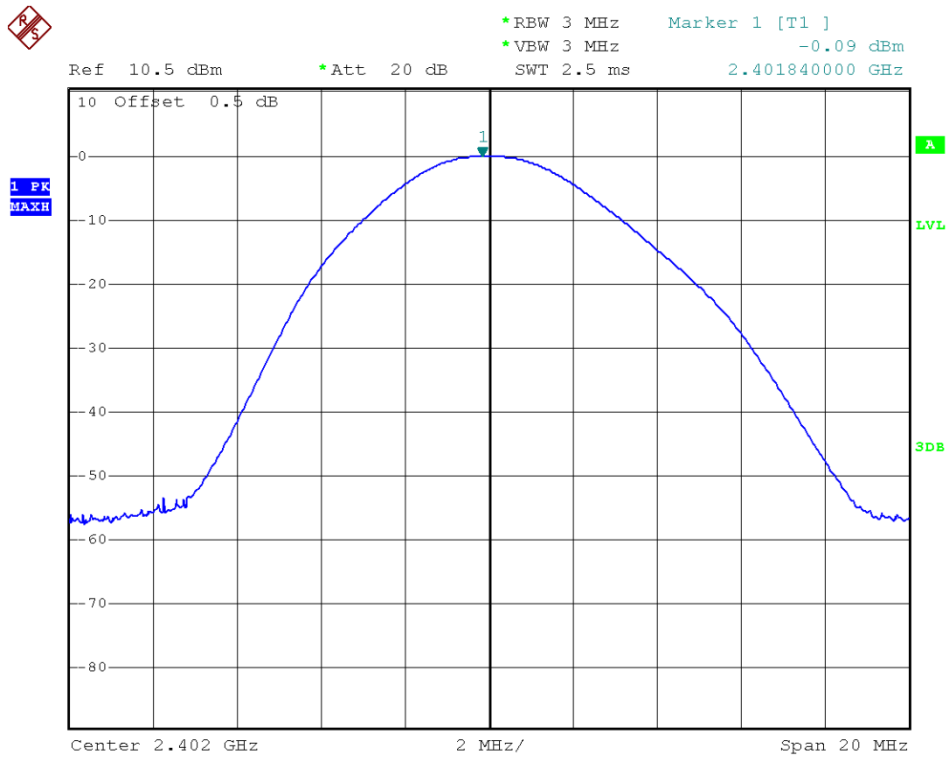

(Plot A: Channel 0: 2402MHz)

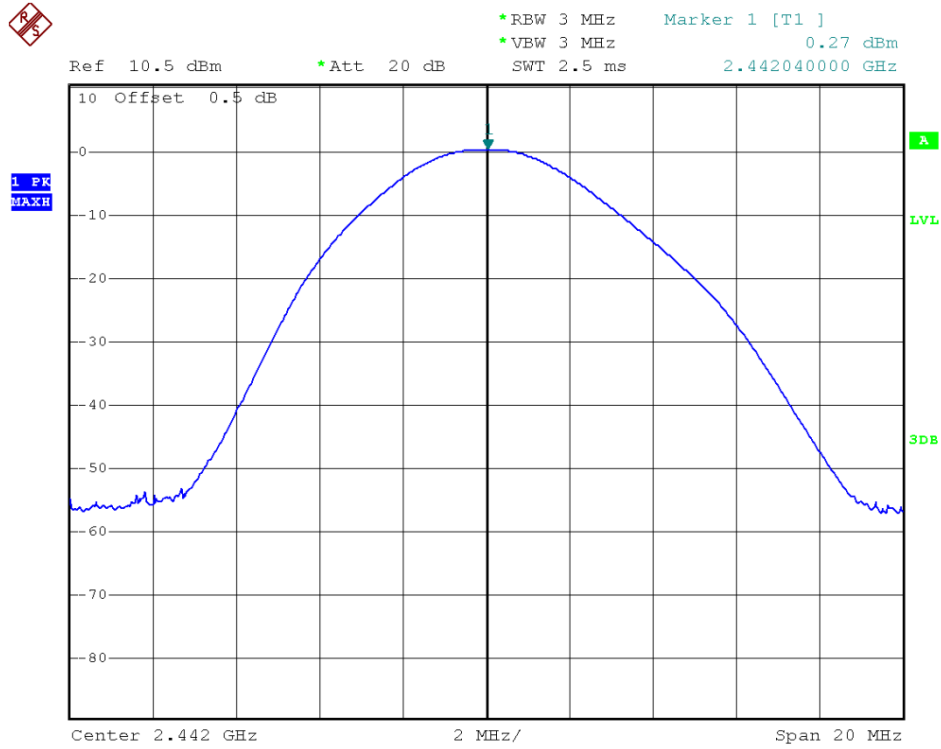

(Plot B: Channel 20: 2442MHz)

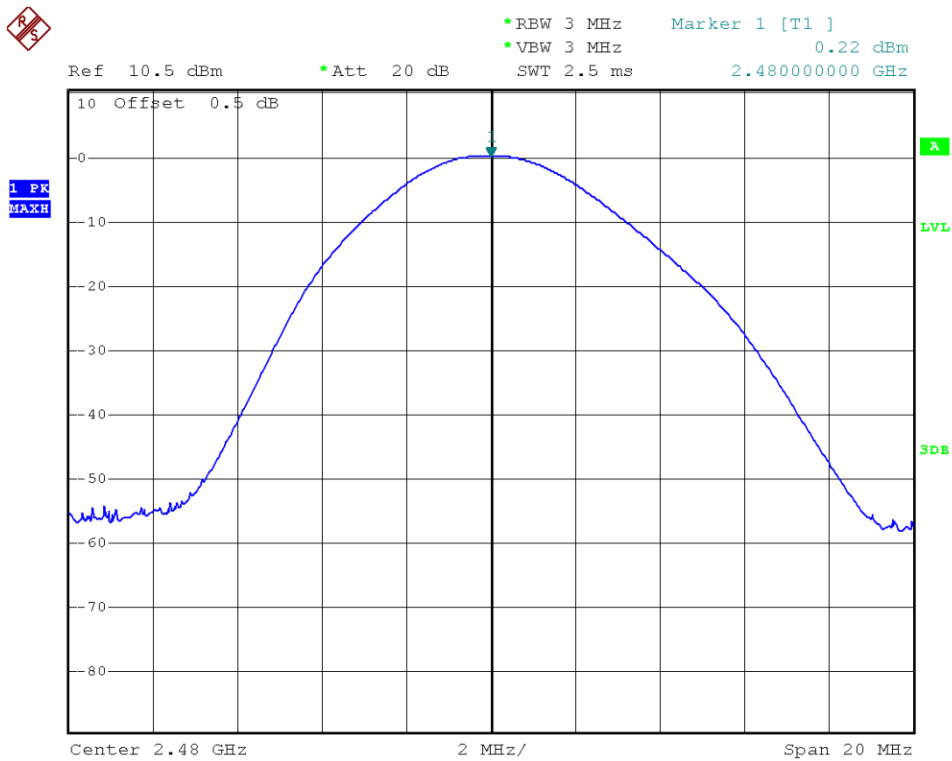

(Plot C: Channel 39: 2480MHz)

2.3. Average power

2.3.1. Requirement

None; for reporting purposes only.

2.3.2. Test Description

The transmitter output is connected to a power meter.

A. Test Setup:

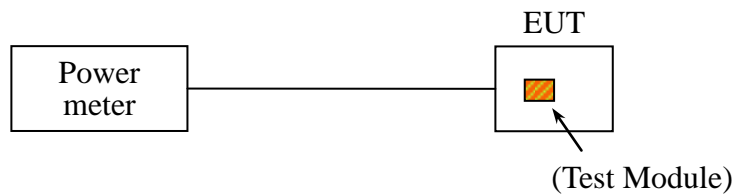

The EUT was directly connected to the power meter by 20dB Atten and antenna output port as show in the block diagram as TEST CONFIGURATION shows.

B. Equipments List:

Description	Manufacturer	Model	Serial No.	Cal. Date	Cal. Due Date
Power Meter	R&S	NRVS	1020.1809.02	2014.06.08	2015.06.07
Power Sensor	R&S	NRV-Z4	823.3618.03	2014.06.08	2015.06.07

2.3.3. Results

The cable assembly insertion loss of 1.5dB was entered as an offset in the power meter to allow for direct reading of power.

Channel	Frequency (MHz)	Average Power
		dBm
0	2402	-2.12
20	2442	-2.09
39	2480	-2.11

2.4. 6dB & 99%Bandwidth

2.4.1. Requirement

According to FCC section 15.247(a) (2), Systems using digital modulation techniques may operate in the 902 - 928 MHz, 2400 - 2483.5 MHz, and 5725 - 5850 MHz bands. The minimum 6 dB bandwidth shall be at least 500 kHz.

2.4.2. Test Description

A. Test Set:

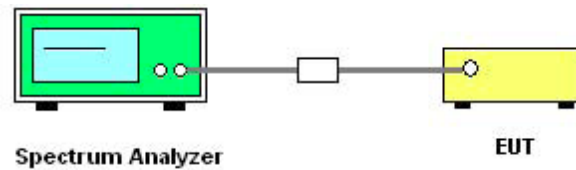

The EUT which is powered by the Battery, is coupled to the Spectrum Analyzer; the RF load attached to the EUT antenna terminal is 50Ohm; the path loss as the factor is calibrated to correct the reading.

B. Equipments List:

2.4.3. Test Result

Description	Manufacturer	Model	Serial No.	Cal.Date	Cal.Due Date
Spectrum Analyzer	R&S	FSP40	1164.4391.40	2014.07.07	2015.07.06

The lowest, middle and highest channels are selected to perform testing to record the 6 dB bandwidth of the Module.

A. Test Verdict:

Channe 1	Frequency (MHz)	6 dB Bandwidth (MHz)	99% Bandwidth (MHz)	Refer to Plot	Limits (kHz)	Result
0	2402	0.6400	1.1100	Plot A1/A2	≥500	PASS
20	2444	0.6400	1.1100	Plot B1/B2	≥500	PASS
39	2480	0.6300	1.1100	Plot C1/C2	≥500	PASS

B. Test Plots:



6 dB Bandwidth

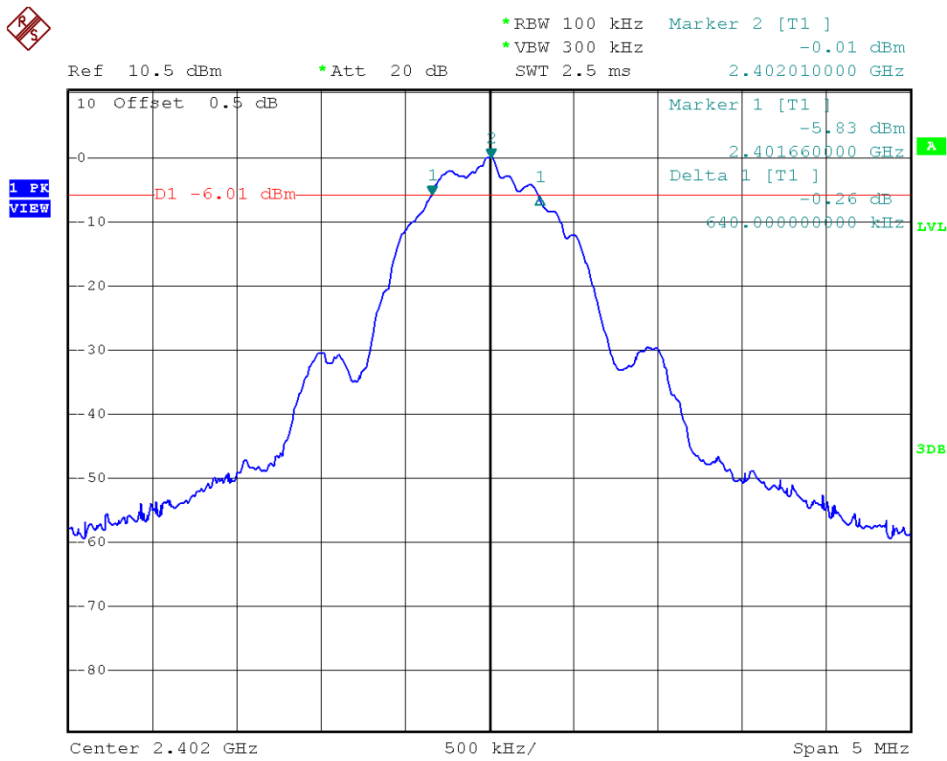

(Plot A1:Channel 0: 2402MHz)

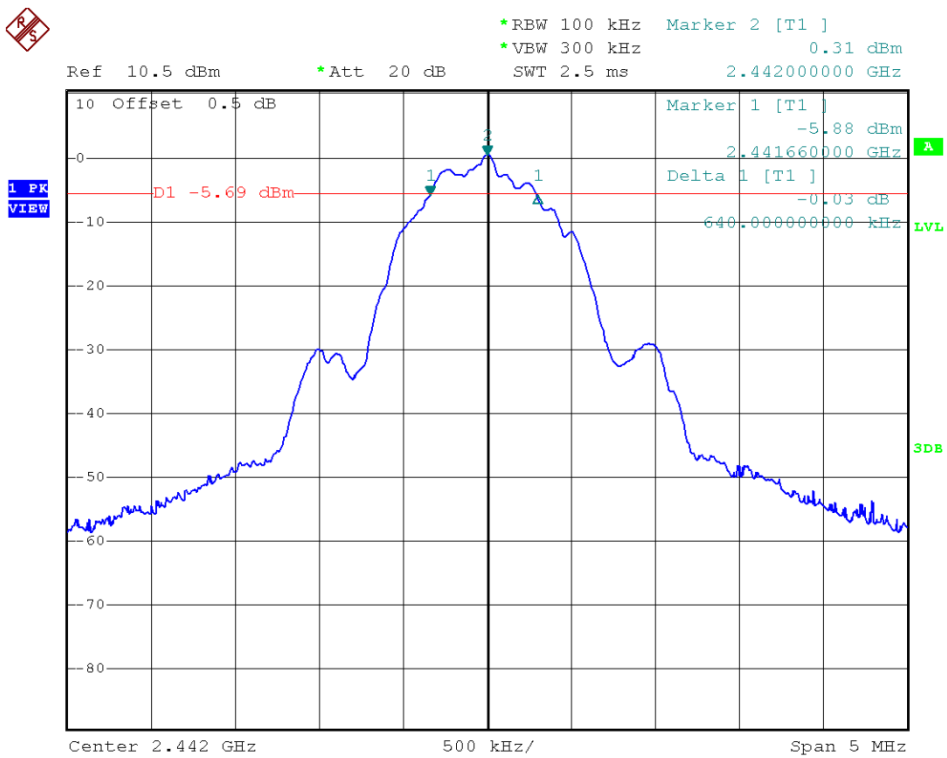

(Plot B1: Channel 20: 2442 MHz)

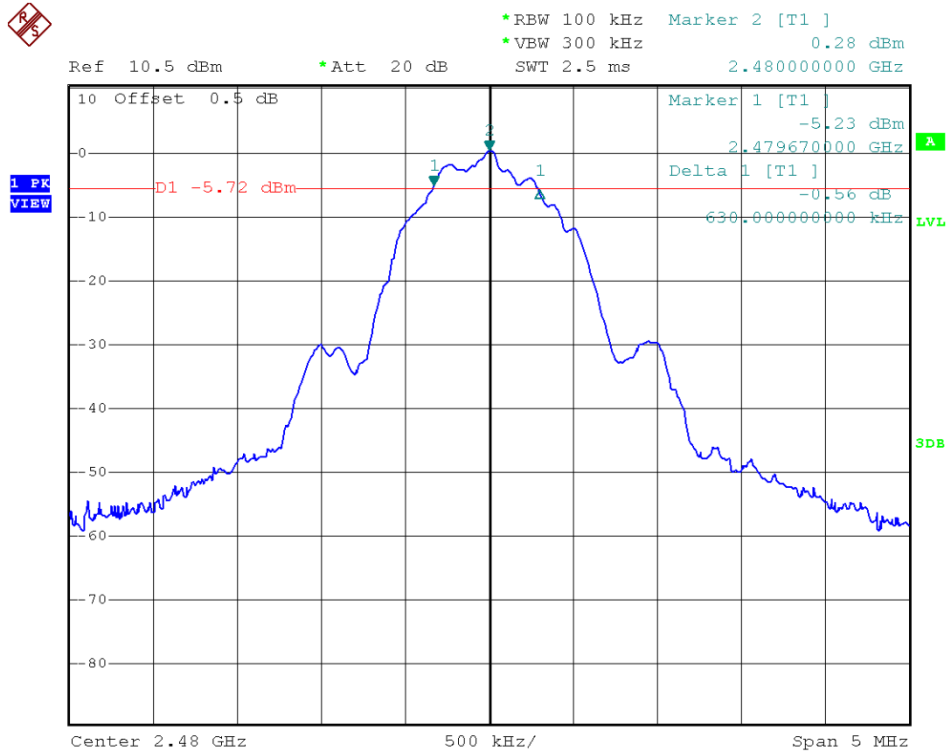

(Plot C1: Channel 39: 2480MHz)

99% Bandwidth

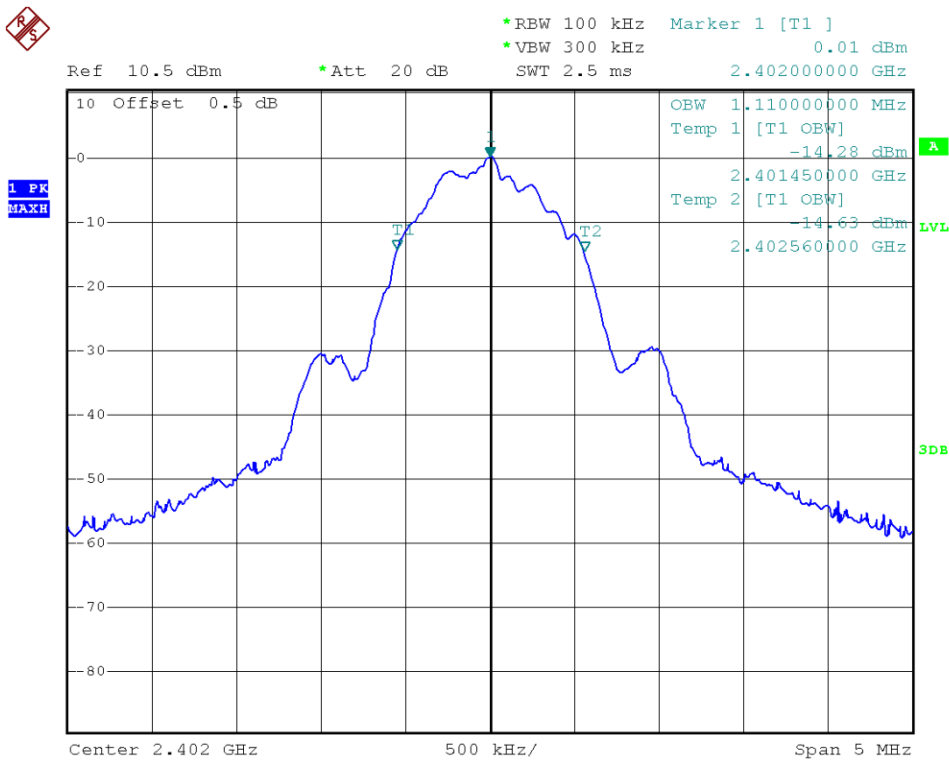

(Plot A2:Channel 0: 2402MHz)

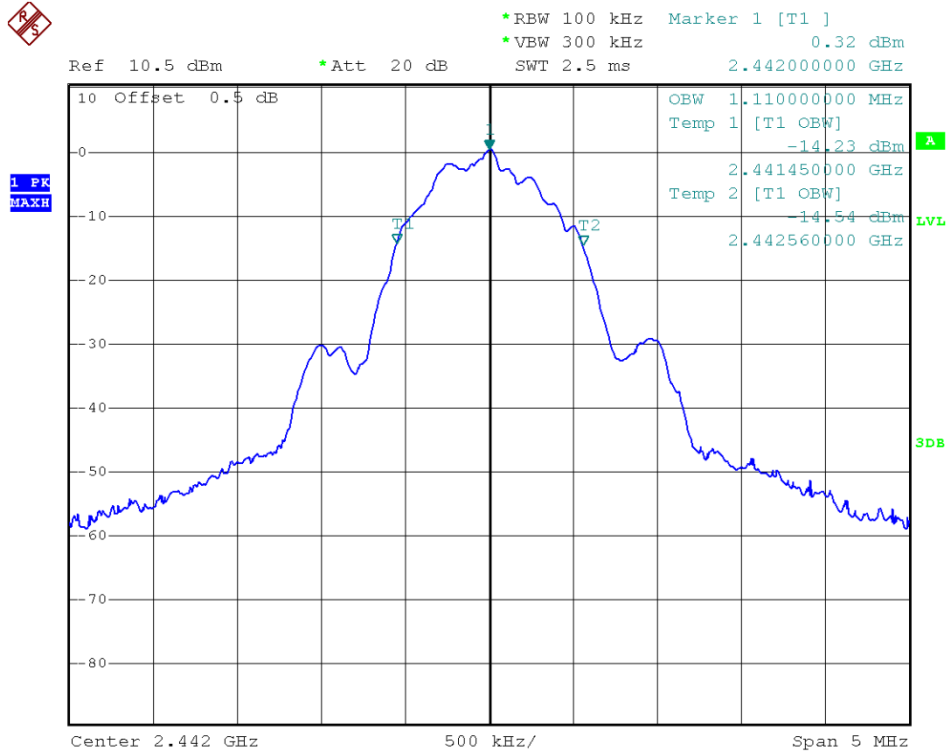

(Plot B2: Channel 20: 2442 MHz)

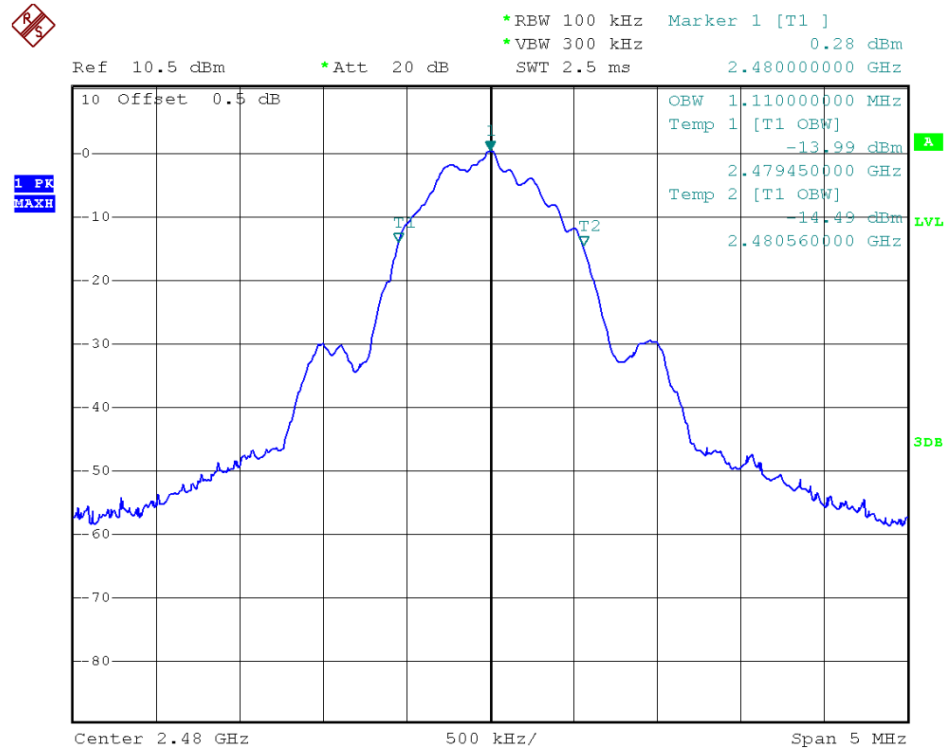

(Plot C2: Channel 39: 2480MHz)

2.5. Conducted Spurious Emissions

2.5.1. Requirement

According to FCC section 15.247(d), in any 100kHz bandwidth outside the frequency band in which the spread spectrum or digitally modulated intentional radiator is operating, the radio frequency power that is produced by the intentional radiator shall be at least 20dB below that in the 100kHz bandwidth within the band that contains the highest level of the desired power, based on either an RF conducted or a radiated measurement.

2.5.2. Test Description

A. Test Set:

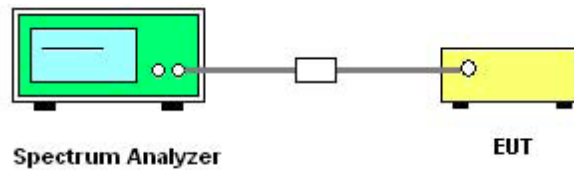

The EUT which is powered by the Battery, is coupled to the Spectrum Analyzer; the RF load attached to the EUT antenna terminal is 50Ohm; the path loss as the factor is calibrated to correct the reading.

Make the measurement with the spectrum analyzer's resolution bandwidth (RBW) = 100 kHz. In order to make an accurate measurement, set the span greater than RBW.

B. Equipments List:

Description	Manufacturer	Model	Serial No.	Cal.Date	Cal.Due Date
Spectrum Analyzer	R&S	FSP40	1164.4391.40	2014.07.07	2015.07.06

2.5.3. Test Result

The measurement frequency range is from 30MHz to the 10th harmonic of the fundamental frequency. The lowest, middle and highest channels are tested to verify the spurious emissions.

A. Test Verdict:

Channel	Frequency (MHz)	Measured Max. Out of Band Emission (dBm)	Refer to Plot	Limit (dBm)		Verdict
				Carrier Level	Calculated -20dBc Limit	
0	2402	-53.30	Plot A.1/A.2	-3.09	-23.09	PASS
20	2442	-52.85	Plot B.1/B.2	-3.72	-23.72	PASS
39	2480	-53.06	Plot C.1/C.2	-6.64	-26.64	PASS

B. Test Plots:

Note: The power of the Module transmitting frequency should be ignored.

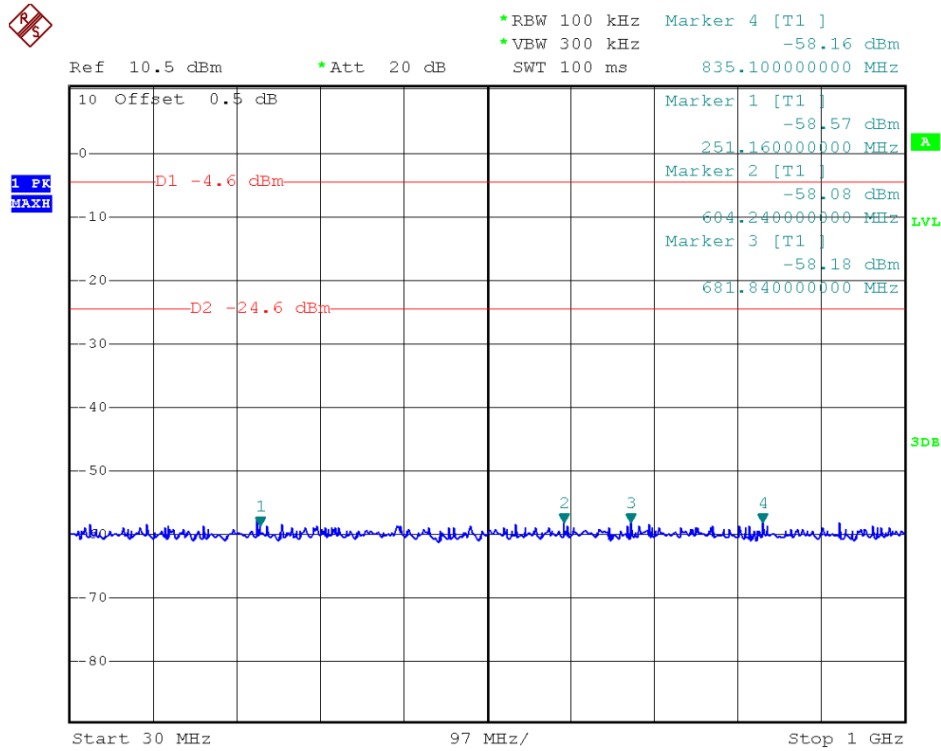

(Plot A.1: Channel = 0, 30MHz to 1GHz)

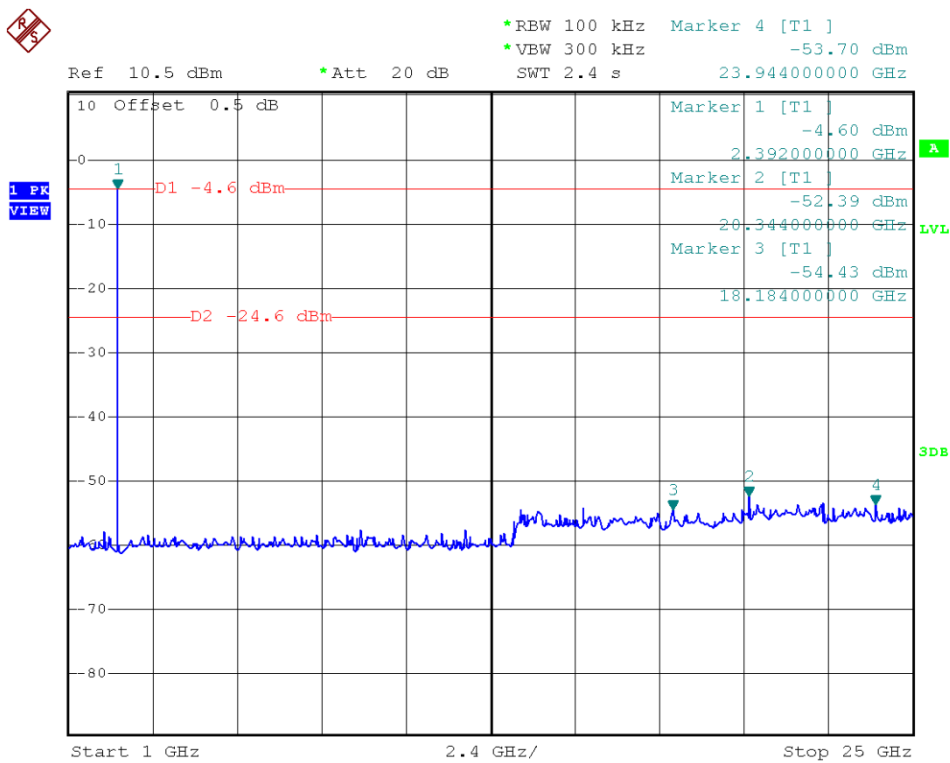

(Plot A.2: Channel = 0, 1GHz to 25GHz)

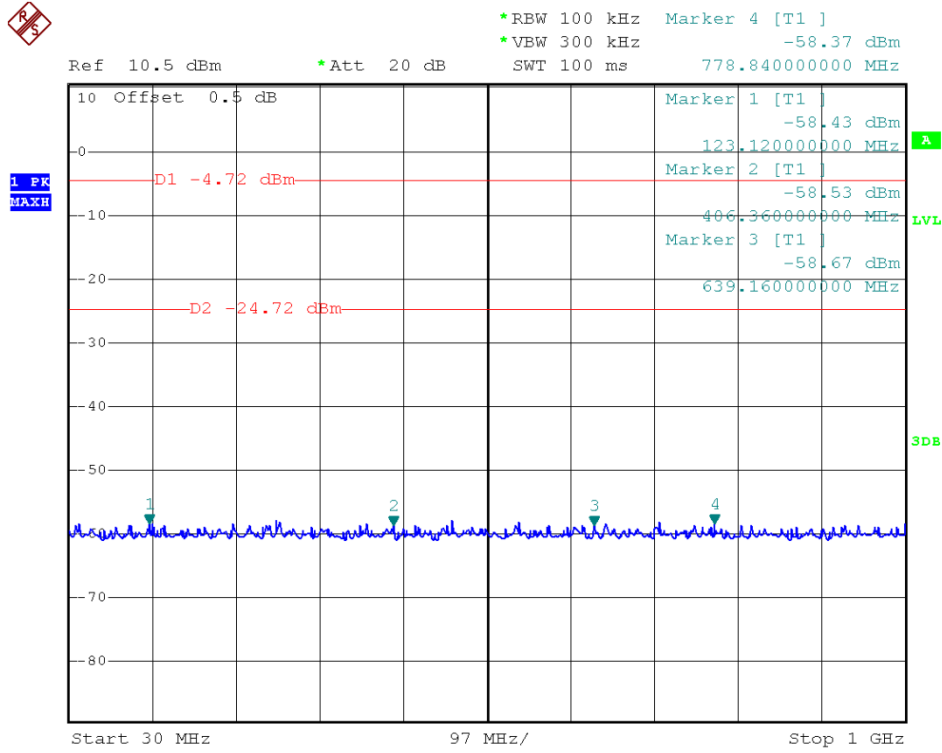

(Plot B.1: Channel = 20, 30MHz to 1GHz)

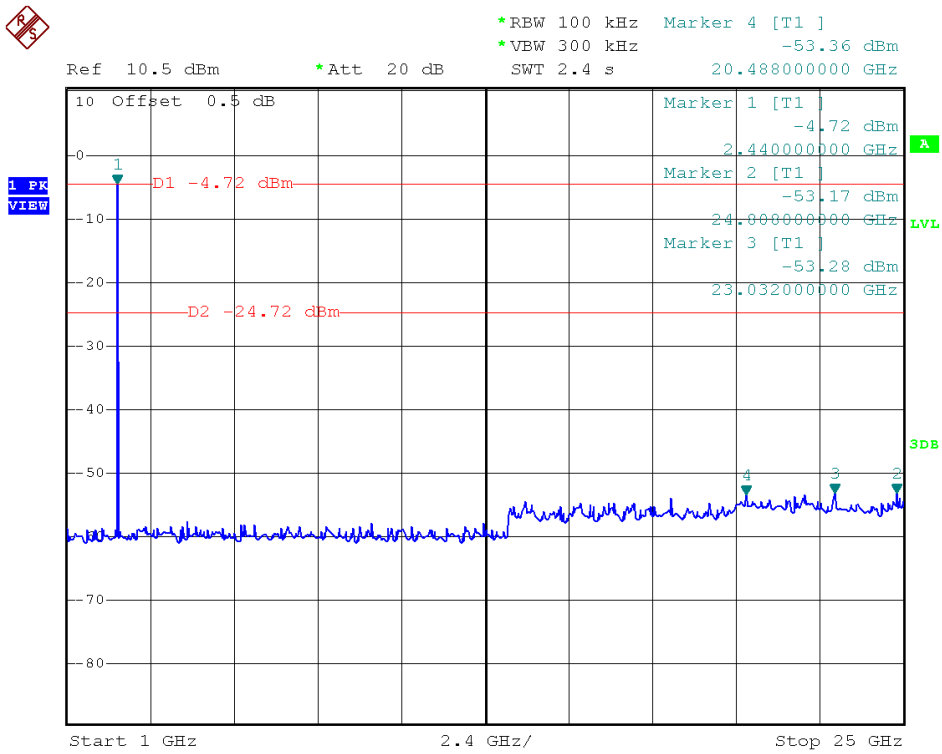

(Plot B.2: Channel = 20, 1GHz to 25GHz)

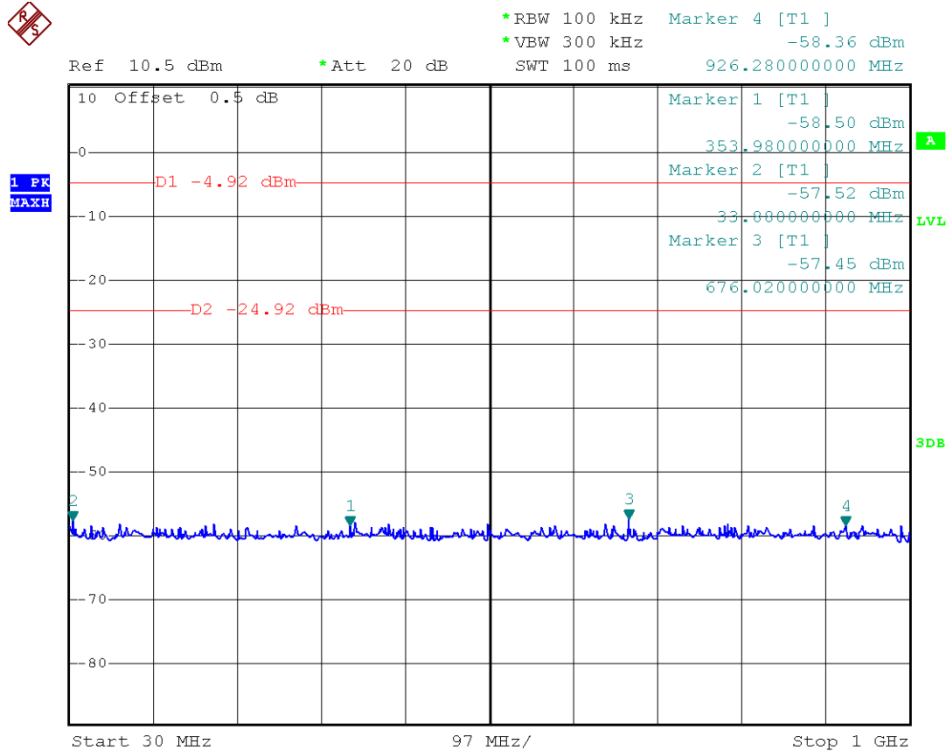

(Plot C.1: Channel = 39, 30MHz to 25GHz)

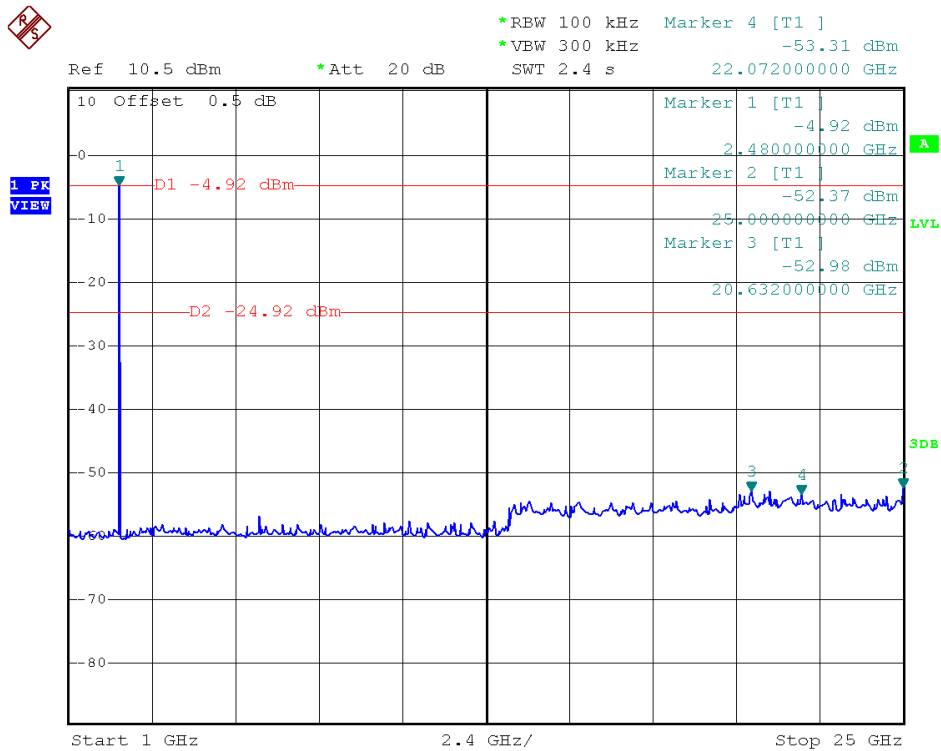

(Plot C.2: Channel = 39, 30MHz to 25GHz)

2.6. Power spectral density (PSD)

2.6.1. Requirement

According to FCC section 15.247(e), the same method of determining the conducted output power shall be used to determine the power spectral density. If a peak output power is measured, then a peak power spectral density measurement is required. If an average output power is measured, then an average power spectral density measurement should be used.

2.6.2. Test Description

A. Test Set:

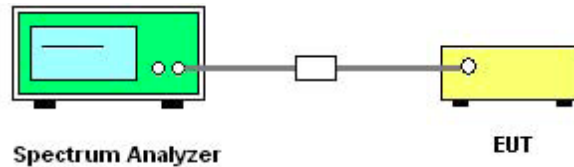

The EUT which is powered by the Battery, is coupled to the Spectrum Analyzer; the RF load attached to the EUT antenna terminal is 50Ohm; the path loss as the factor is calibrated to correct the reading.

B. Equipments List:

Description	Manufacturer	Model	Serial No.	Cal.Date	Cal.Due Date
Spectrum Analyzer	R&S	FSP40	1164.4391.40	2014.07.07	2015.07.06

2.6.3. Test Result

The lowest, middle and highest channels are tested.

Bandwidth correction: $10\log(3\text{kHz}/100\text{kHz}) = -15.2\text{dB}$

A. Test Verdict:

Spectral power density						
Channel	Frequency (MHz)	Measured PSD (dBm/100kHz)	Measured PSD (dBm/3kHz)	Refer to Plot	Limit (dBm/3kHz)	Verdict
0	2402	0.04	-15.16	Plot A	8	PASS
20	2442	0.64	-14.56	Plot B	8	PASS
39	2480	0.28	-14.92	Plot C	8	PASS
Measurement uncertainty: $\pm 1.3\text{dB}$						



B. Test Plots:

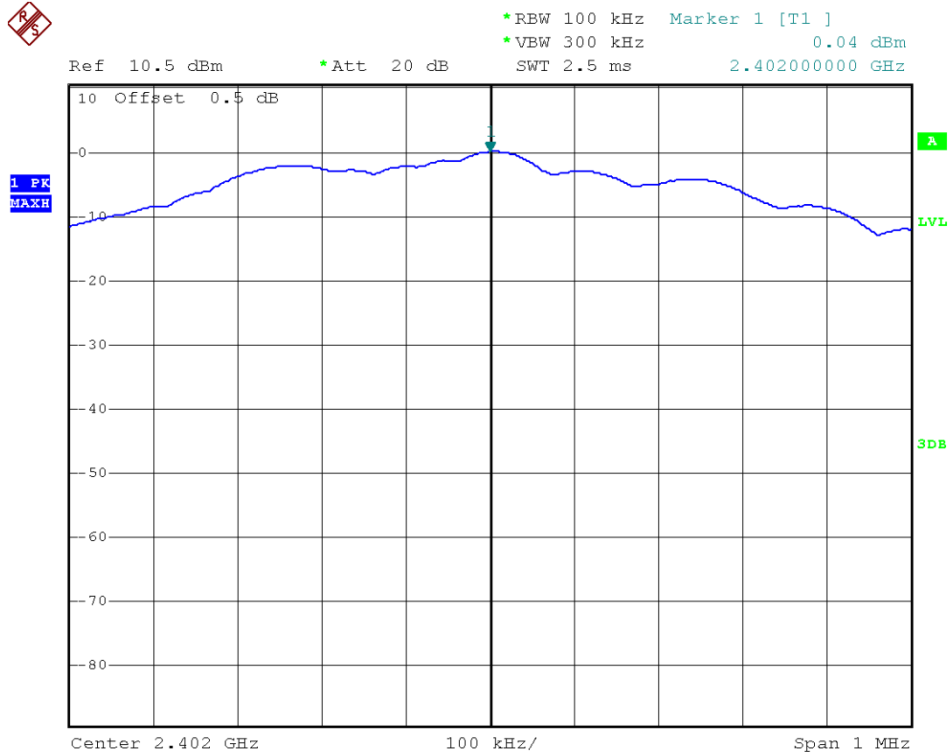

(Plot A: Channel = 0)

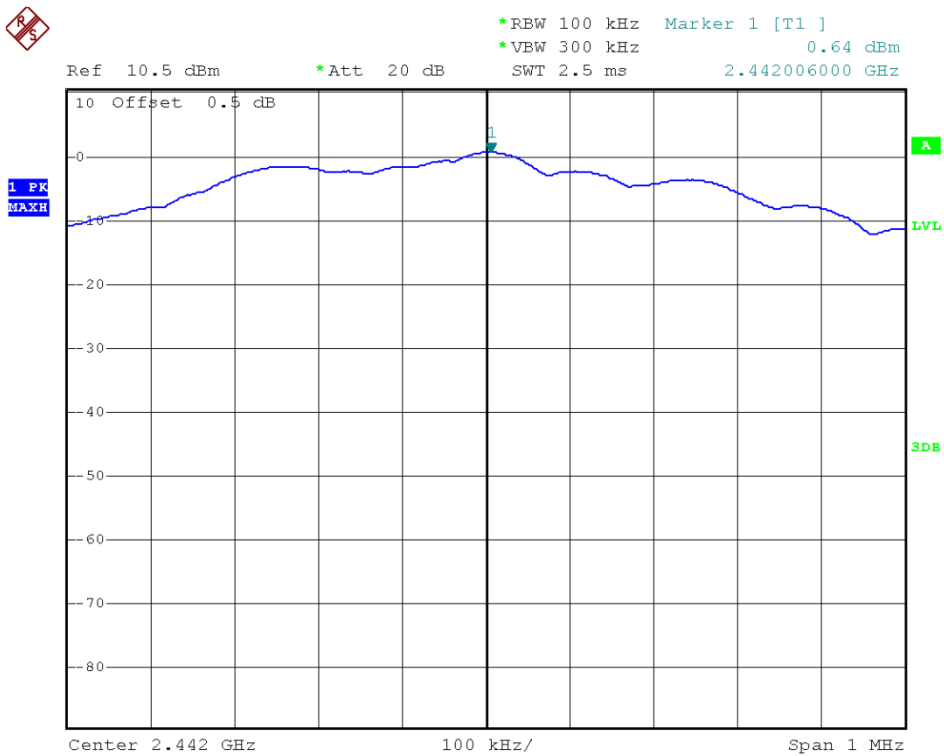

(Plot B: Channel = 20)

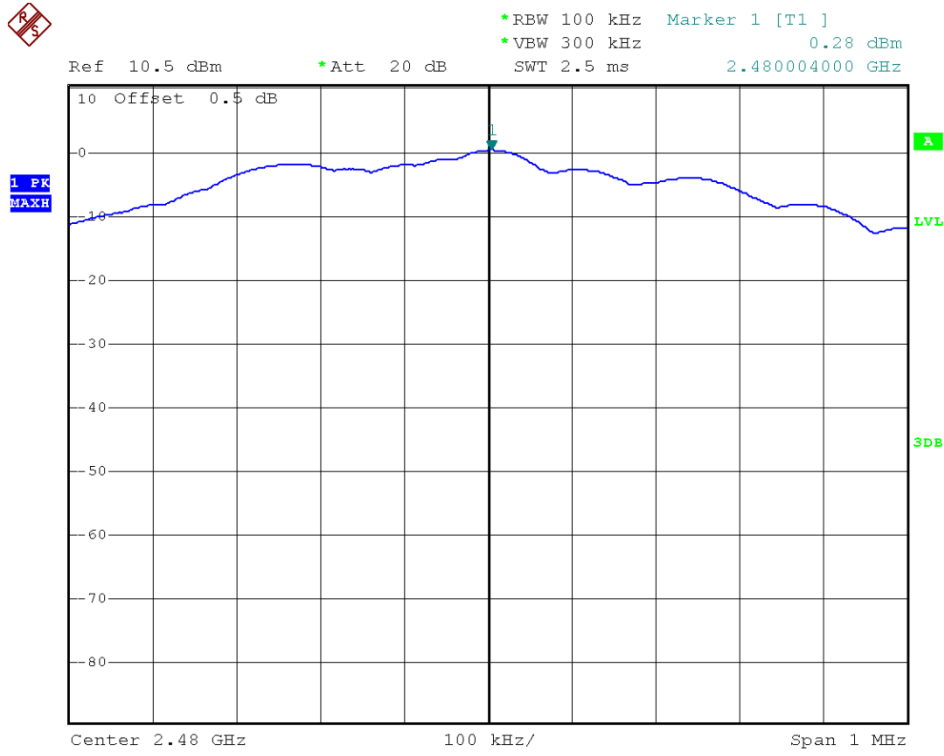

(Plot C: Channel = 39)

2.7. Conducted Band Edge

2.7.1. Requirement

In any 100kHz bandwidth outside the frequency band in which the spread spectrum or digitally modulated intentional radiator is operating, the radio frequency power that is produced by the intentional radiator shall be at least 20dB or 30Db below that in the 100kHz bandwidth within the band that contains the highest level of the desired power, based on either an RF conducted or a radiated measurement.

2.7.2. Test Description

Test Setup

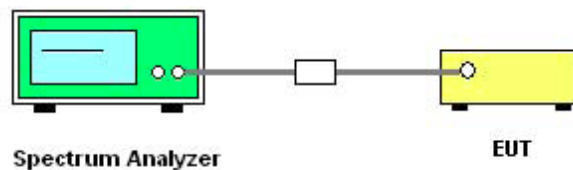

Equipments List:

Description	Manufacturer	Model	Serial No.	Cal. Date	Cal. Due Date
Spectrum Analyzer	R&S	FSP40	1164.4391.40	2014.07.07	2015.07.06

2.7.3. Test Procedure

The following procedures may be used to determine the peak or average field strength or power of an unwanted emission that is within 2 MHz of the authorized band edge. If a peak detector is utilized, use the procedure described in 13.2.1. Use the procedure described in 13.2.2 when using an average detector and the EUT can be configured to transmit continuously (i.e., duty cycle $\geq 98\%$). Use the procedure described in 13.2.3 when using an average detector and the EUT cannot be configured to transmit continuously but the duty cycle is constant (i.e., duty cycle variations are less than ± 2 percent). Use the procedure described in 13.2.4 when using an average detector for those cases where the EUT cannot be configured to transmit continuously and the duty cycle is not constant (duty cycle variations equal or exceed 2 percent).

When using a peak detector to measure unwanted emissions at or near the band edge (within 2 MHz of the authorized band), the following integration procedure can be used.

Set instrument center frequency to the frequency of the emission to be measured (must be within 2 MHz of the authorized band edge).

Set span to 2 MHz

RBW = 100 kHz.

VBW $\geq 3 \times$ RBW.

Detector = peak.

Sweep time = auto.

Trace mode = max hold.



Allow sweep to continue until the trace stabilizes (required measurement time may increase for low duty cycle applications)

Compute the power by integrating the spectrum over 1 MHz using the analyzer's band power measurement function with band limits set equal to the emission frequency (femission) ± 0.5 MHz. If the instrument does not have a band power function, then sum the amplitude levels (in power units) at 100 kHz intervals extending across the 1 MHz spectrum defined by femission ± 0.5 MHz.

2.7.4. Test Result

The lowest and highest channels are tested to verify the band edge emissions. Please refer to the following the plots for emissions values.

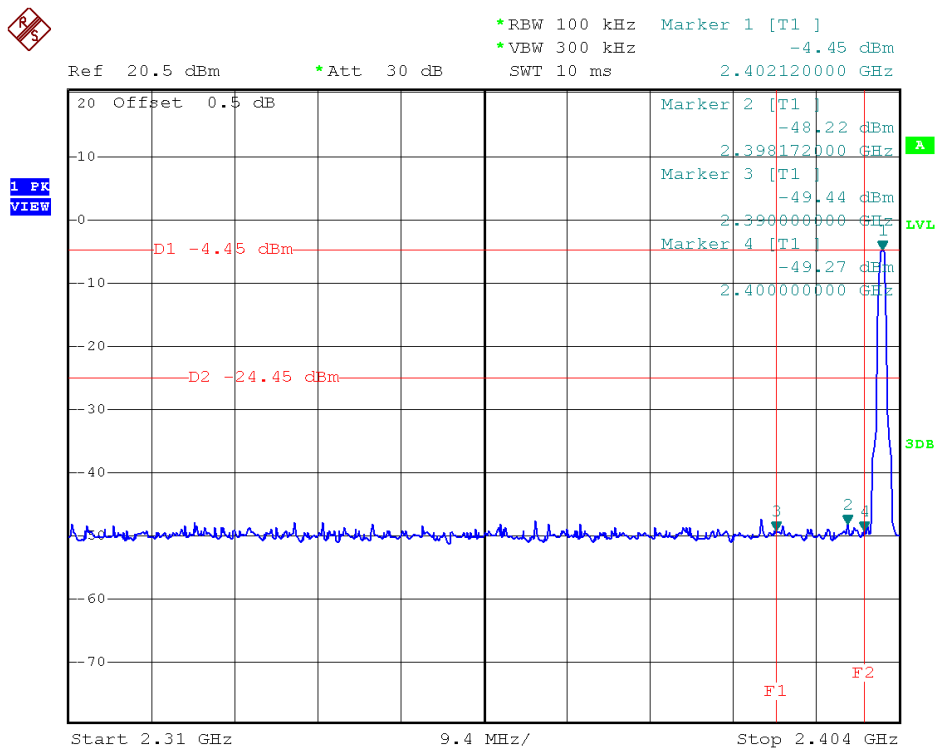

Channel = 0

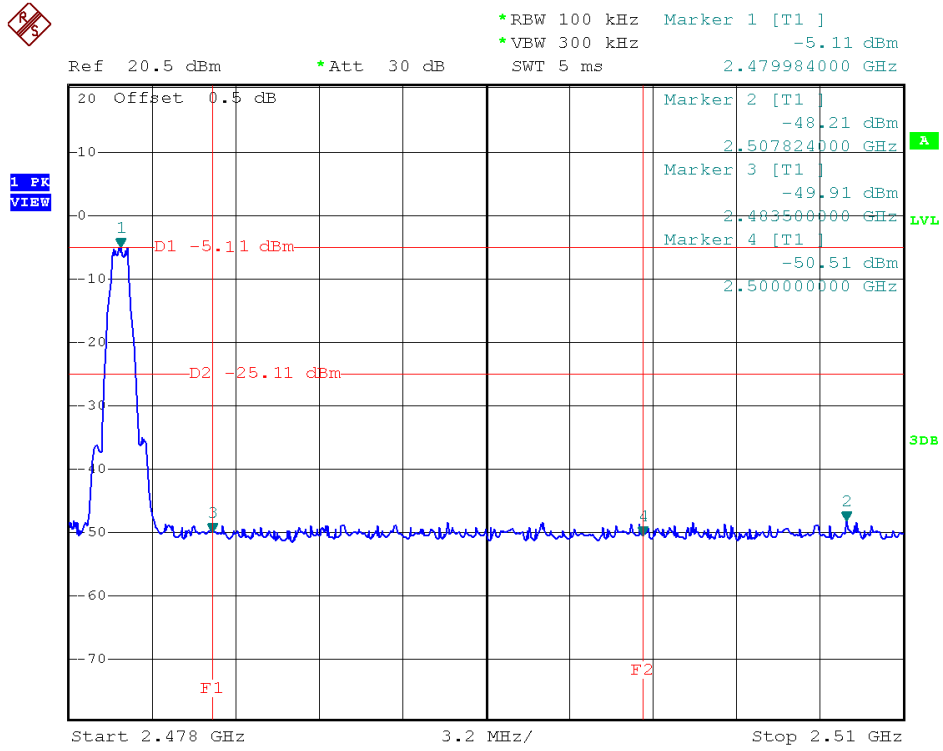

Channel = 39

2.8. Conducted Emission

2.8.1. Requirement

For an intentional radiator that is designed to be connected to the public utility (AC) power line, the radio frequency voltage that is conducted back onto the AC power line on any frequency within the band 150kHz to 30MHz shall not exceed the limits in the following table, as measured using a 50 μ H/50 Ω line impedance stabilization network (LISN).

Frequency range (MHz)	Conducted Limit (dB μ V)	
	Quai-peak	Average
0.15 - 0.50	66 to 56	56 to 46
0.50 - 5	56	46
5 - 30	60	50

NOTE:

- The lower limit shall apply at the band edges.
- The limit decreases linearly with the logarithm of the frequency in the range 0.15 - 0.50MHz.

2.8.2. Test Description

A. Test Setup:

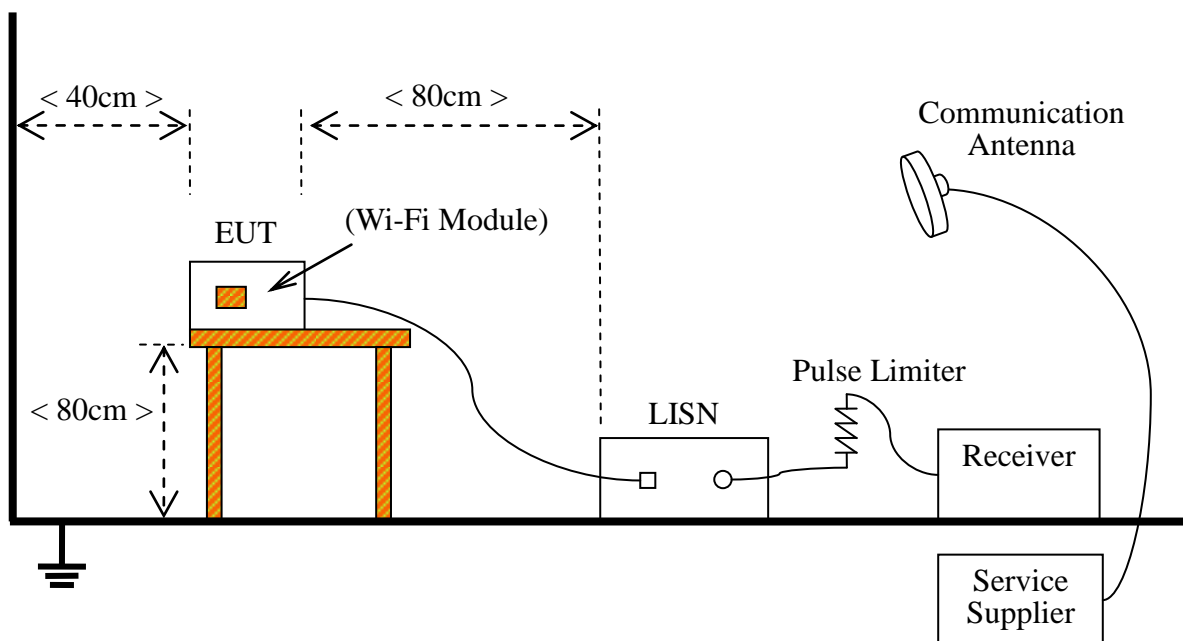

The Table-top EUT was placed upon a non-metallic table 0.8m above the horizontal metal reference ground plane. EUT was connected to LISN and LISN was connected to reference Ground Plane. EUT was 80cm from LISN. The set-up and test methods were according to ANSI C63.4:2009

B. Equipments List:



Description	Manufacturer	Model	Serial No.	Cal. Date	Cal. Due Date
Test Receiver	R&S	ESCS30	A0304260	2014.06.11	2015.06.10
LISN	R&S	ESH2-Z5	A0304221	2014.06.11	2015.06.10
Service Supplier	R&S	CMU200	A0304252	2014.06.11	2015.06.10
Pulse Limiter (20dB)	Schwarzbeck	VTSD 9561-D	A0304291	(n.a.)	(n.a.)
Cable	MATCHING PAD	W7	/	2014.06.05	2015.06.04

2.8.3. Test Result

The maximum conducted interference is searched using Peak (PK), if the emission levels more than the AV and QP limits, and that have narrow margins from the AV and QP limits will be re-measured with AV and QP detectors. Tests for both L phase and N phase lines of the power mains connected to the EUT are performed. Refer to recorded points and plots below.

A. Test setup:

The EUT configuration of the emission tests is EUT + PC.

B. Test Plots:

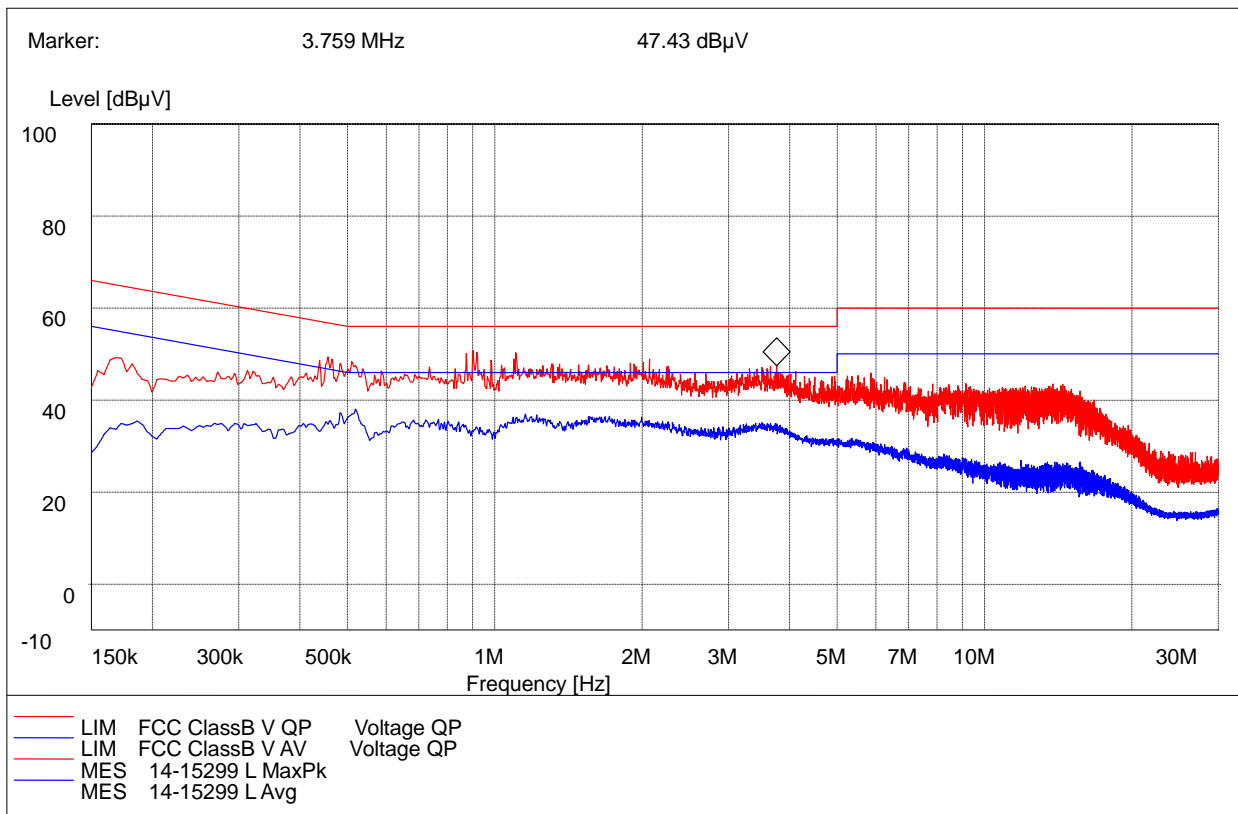

(Plot A: L Phase)



Conducted Disturbance at Mains Terminals					
L Test Data					
QP			AV		
Frequency (MHz)	Limits (dB μ V)	Measurement Value (dB μ V)	Frequency (MHz)	Limits (dB μ V)	Measurement Value (dB μ V)
0.4560	56.80	49.13	0.4560	46.80	34.74
0.9100	56.00	50.35	0.9100	46.00	33.27
2.0670	56.00	48.81	2.0670	46.00	31.69

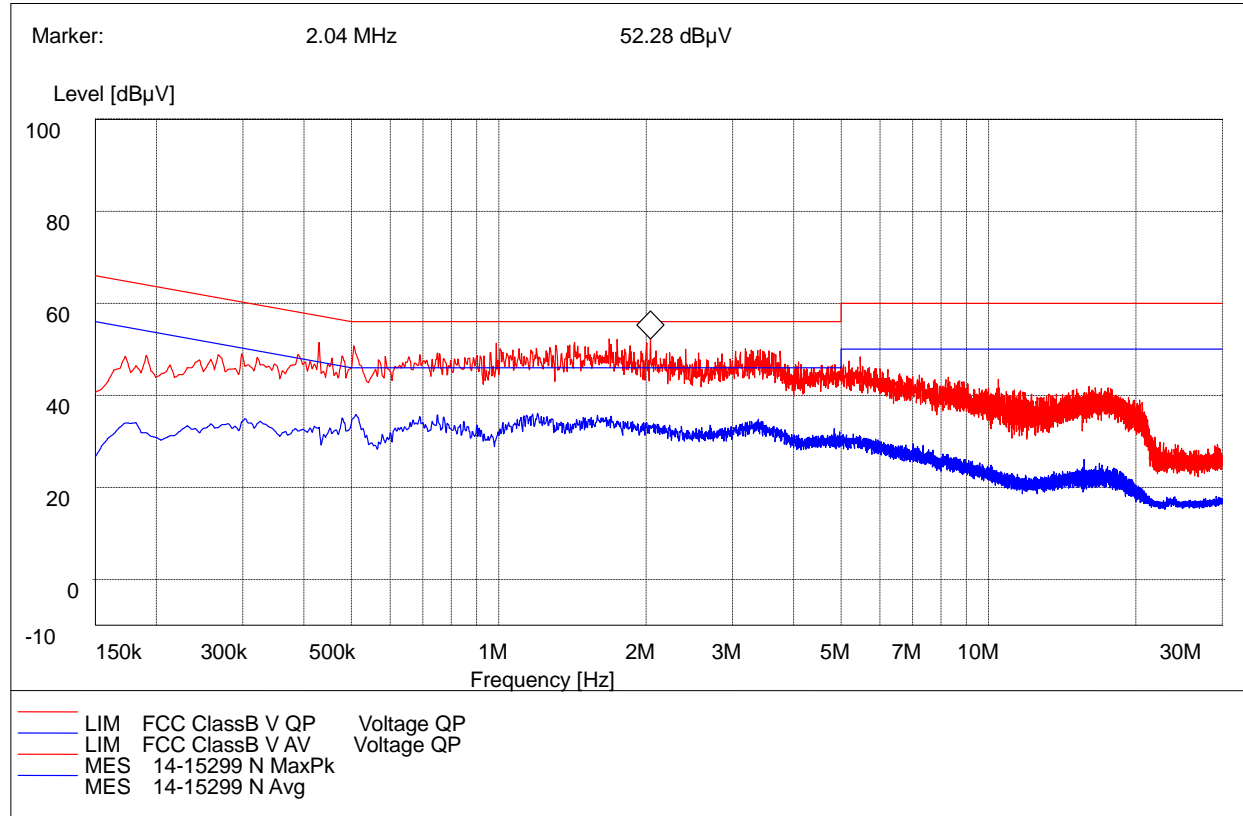

(Plot B: N Phase)



Conducted Disturbance at Mains Terminals					
N Test Data					
QP			AV		
Frequency (MHz)	Limits (dBμV)	Measurement Value (dBμV)	Frequency (MHz)	Limits (dBμV)	Measurement Value (dBμV)
0.5055	56.00	50.12	0.5055	46.00	35.03
0.9870	56.00	50.22	0.9870	46.00	30.87
1.6800	56.00	52.18	1.6800	46.00	34.76
N Test Curve					

Test Result: PASS



2.9. Radiated Emission

2.9.1. Requirement

Radiated emission outside the frequency band attenuation below the general limits specified in FCC section 15.209(a) is not required. In addition, radiated emissions which fall in the restricted bands, as defined in FCC section 15.205(a), must also comply with the radiated emission limits specified in FCC section 15.209(a).

According to FCC section 15.209 (a), except as provided elsewhere in this subpart, the emissions from an intentional radiator shall not exceed the field strength levels specified in the following table:

Frequency (MHz)	Field Strength ($\mu\text{V}/\text{m}$)	Measurement Distance (m)
0.009 - 0.490	2400/F(kHz)	300
0.490 - 1.705	24000/F(kHz)	30
1.705 - 30.0	30	30
30 - 88	100	3
88 - 216	150	3
216 - 960	200	3
Above 960	500	3

Note:

1. For Above 1000MHz, the emission limit in this paragraph is based on measurement instrumentation employing an average detector, measurement using instrumentation with a peak detector function, corresponding to 20dB above the maximum permitted average limit.
2. For above 1000MHz, limit field strength of harmonics: 54dBuV/m@3m (AV) and 74dBuV/m@3m (PK)

In addition, radiated emissions which fall in the restricted bands, as defined in Section 15.205(a), also should comply with the radiated emission limits specified in Section 15.209(a)(above table)

2.9.2. Test Description

A. Test Setup:

- 1) For radiated emissions from 9kHz to 30MHz

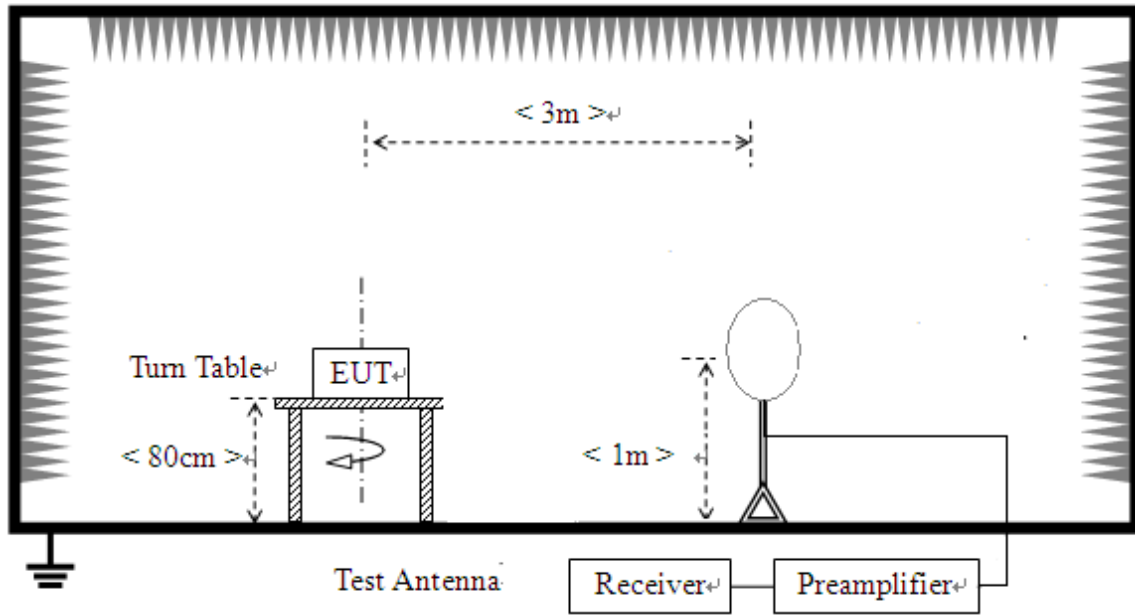

2) For radiated emissions from 30MHz to 1GHz

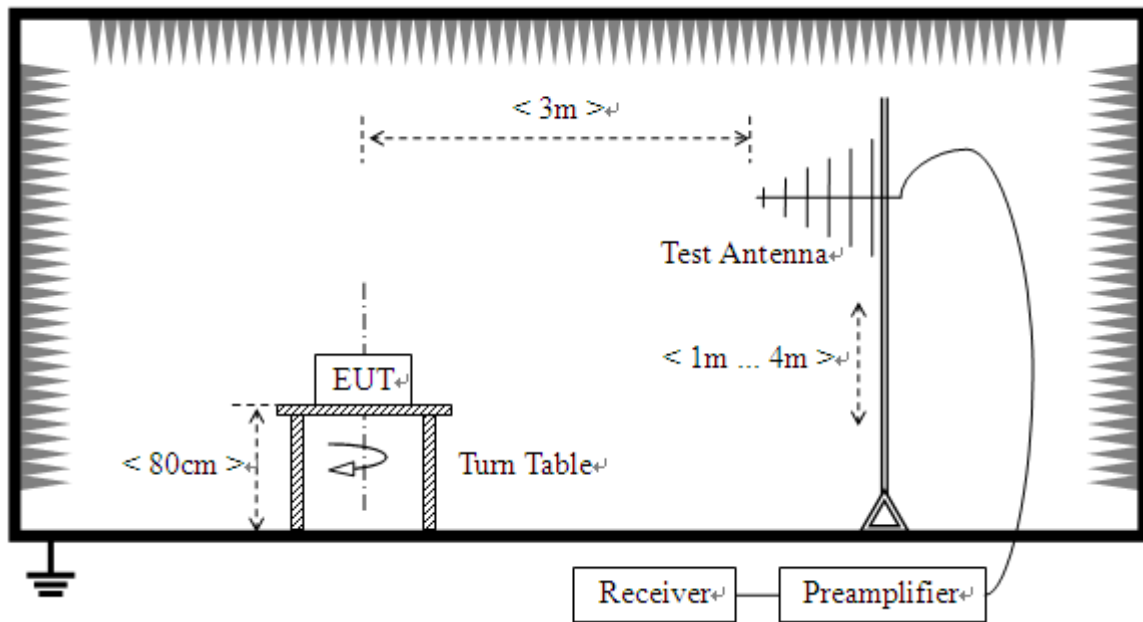

3) For radiated emissions above 1GHz

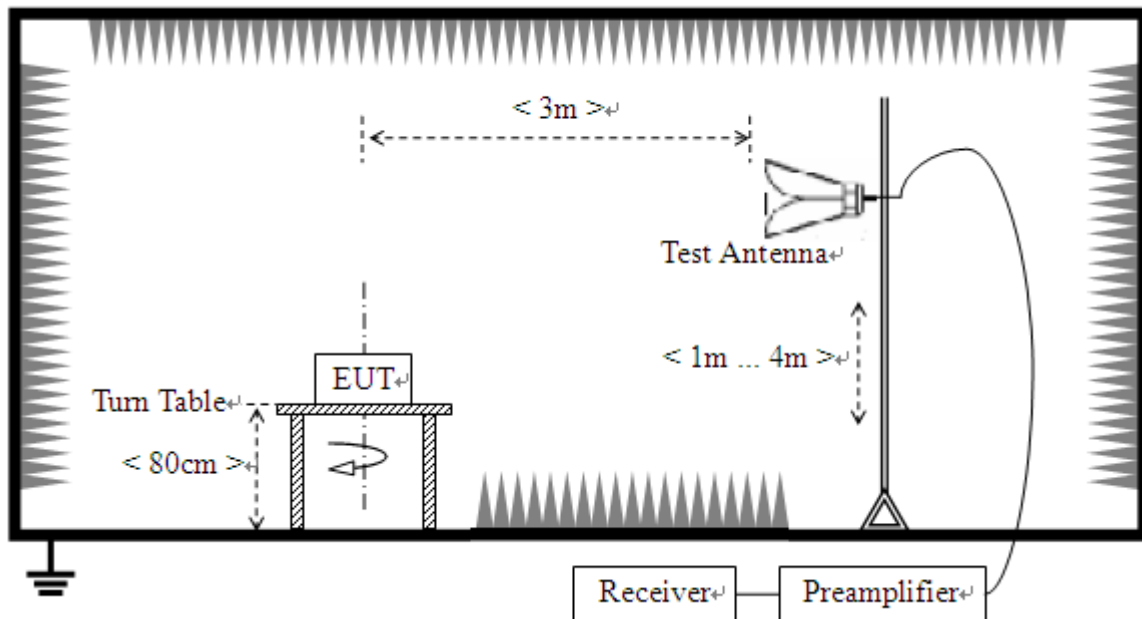

The test site semi-anechoic chamber has met the requirement of NSA tolerance 4dB according to the standards: ANSI C63.4 (2009). The EUT was set-up on insulator 80cm above the Ground Plane. The set-up and test methods were according to ANSI C63.4.

The EUT of the EUT is powered by the Battery charged with the AC Adapter which is powered by 120V, 60Hz AC mains supply. The Module is located in a 3m Semi-Anechoic Chamber; the antenna factors, cable loss and so on of the site as factors are calculated to correct the reading. During the measurement, the EUT is activated and controlled by the Wireless Router via a Common Antenna, and is set to operate under hopping-on test mode.

For the Test Antenna:

- (a) In the frequency range of 9kHz to 30MHz, magnetic field is measured with Loop Test Antenna. The Test Antenna is positioned with its plane vertical at 1m distance from the EUT. The center of the Loop Test Antenna is 1m above the ground. During the measurement the Loop Test Antenna rotates about its vertical axis for maximum response at each azimuth about the EUT.
- (b) In the frequency range above 30MHz, Bi-Log Test Antenna (30MHz to 2GHz) and Horn Test Antenna (above 2GHz) are used. Test Antenna is 3m away from the EUT. Test Antenna height is varied from 1m to 4m above the ground to determine the maximum value of the field strength. The emission levels at both horizontal and vertical polarizations should be tested.

**B. Equipments List:**

Description	Manufacturer	Model	Serial No.	Cal. Date	Cal. Due Date
Receiver	R&S	ESIB26	A0304218	2014.06.11	2015.06.10
Full-Anechoic Chamber	Albatross	12.8m*6.8m*6.4m	A0412372	2015.01.05	2016.01.04
Test Antenna - Bi-Log	Schwarzbeck	VULB 9163	9163-274	2014.06.11	2015.06.10
Test Antenna - Horn	R&S	BBHA 9120D	9120C-963	2014.06.11	2015.06.10
Test Antenna - Horn	R&S	HF960	100150	2014.06.11	2015.06.10
Test Antenna – Horn (18-25GHz)	ETS	UG-596A/U	A0902607	2014.06.11	2015.06.10
Test Antenna -Loop	Schwarzbeck	HFH2-Z2	100047	2014.06.11	2015.06.10
Amplifier 1G~18GHz	R&S	MITEQ AFS42-00101800	25-S-42	2014.06.11	2015.06.10
Amplifier 18G~40GHz	R&S	JS42-18002600-28-5A	12111.0980.00	2014.06.11	2015.06.10
amplifier 20M~3GHz	R&S	PAP-0203H	22018	2014.06.11	2015.06.10
Cable	SUNHNER	SUCOFLEX 100	/	2014.06.05	2015.06.04
Cable	SUNHNER	SUCOFLEX 104	/	2014.06.05	2015.06.04

2.9.3. Test Result

According to ANSI C63.4 selection 4.2.2, because of peak detection will yield amplitudes equal to or greater than amplitudes measured with the quasi-peak (or average) detector, the measurement data from a spectrum analyzer peak detector will represent the worst-case results, if the peak measured value complies with the quasi-peak limit, it is unnecessary to perform a quasi-peak measurement.

The measurement results are obtained as below:

$$E \text{ [dB}\mu\text{V/m]} = U_R + A_T + A_{\text{Factor}} \text{ [dB]}; A_T = L_{\text{Cable loss}} \text{ [dB]} - G_{\text{preamp}} \text{ [dB]}$$

A_T : Total correction Factor except Antenna

U_R : Receiver Reading

G_{preamp} : Preamplifier Gain

A_{Factor} : Antenna Factor at 3m

During the test, the total correction Factor A_T and A_{Factor} were built in test software.

Note: All radiated emission tests were performed in X, Y, Z axis direction. And only the worst axis test condition was recorded in this test report.

Test Plots for the Whole Measurement Frequency Range:



For 9KHz to 30MHz

The test has been performed, and the Radiated Emission level is too low to the limit.

For 30MHz to 1000 MHz

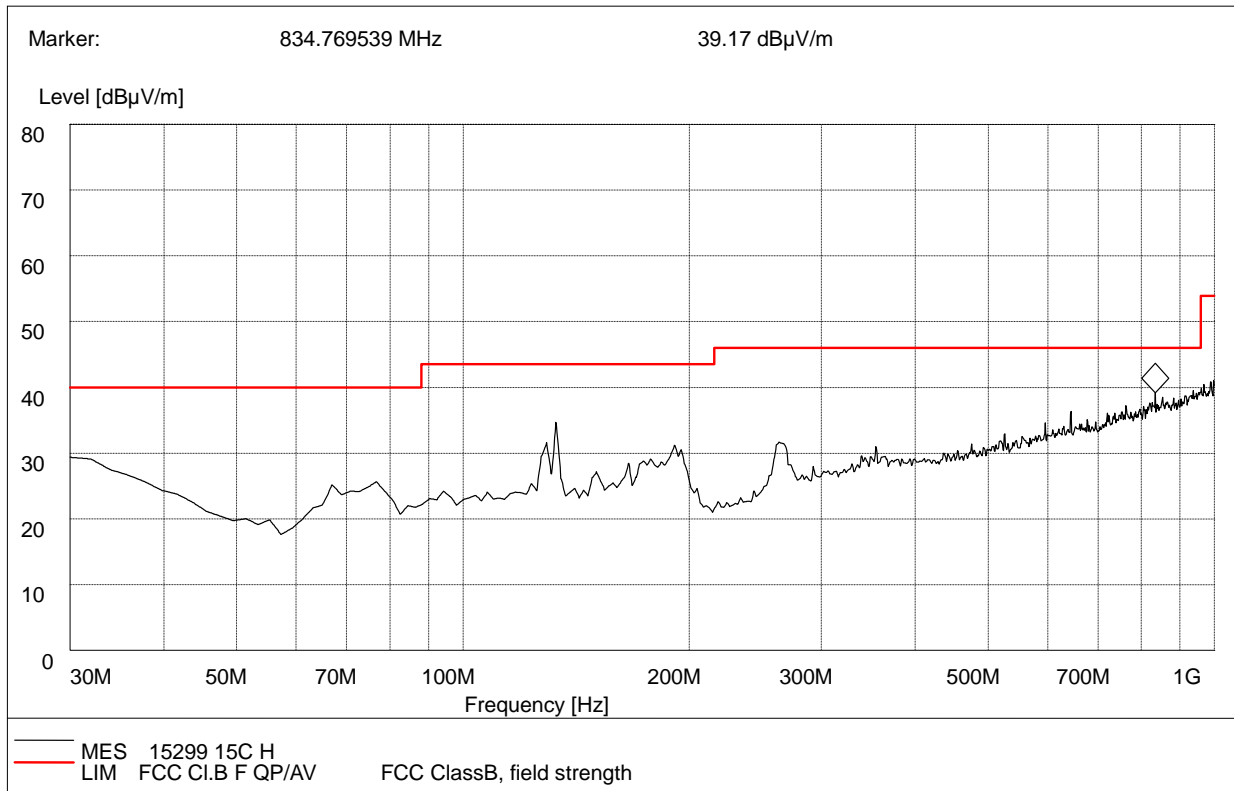

(Plot A: 30MHz to 1GHz, Antenna Horizontal)

Frequency (MHz)	QuasiPeak (dBµV/m)	Bandwidth (kHz)	Antenna height (cm)	Limit (dBµV/m)	Antenna	Verdict
133.0200	33.17	120.000	100.0	43.5	Horizontal	Pass
263.2500	30.47	120.000	100.0	46.0	Horizontal	Pass

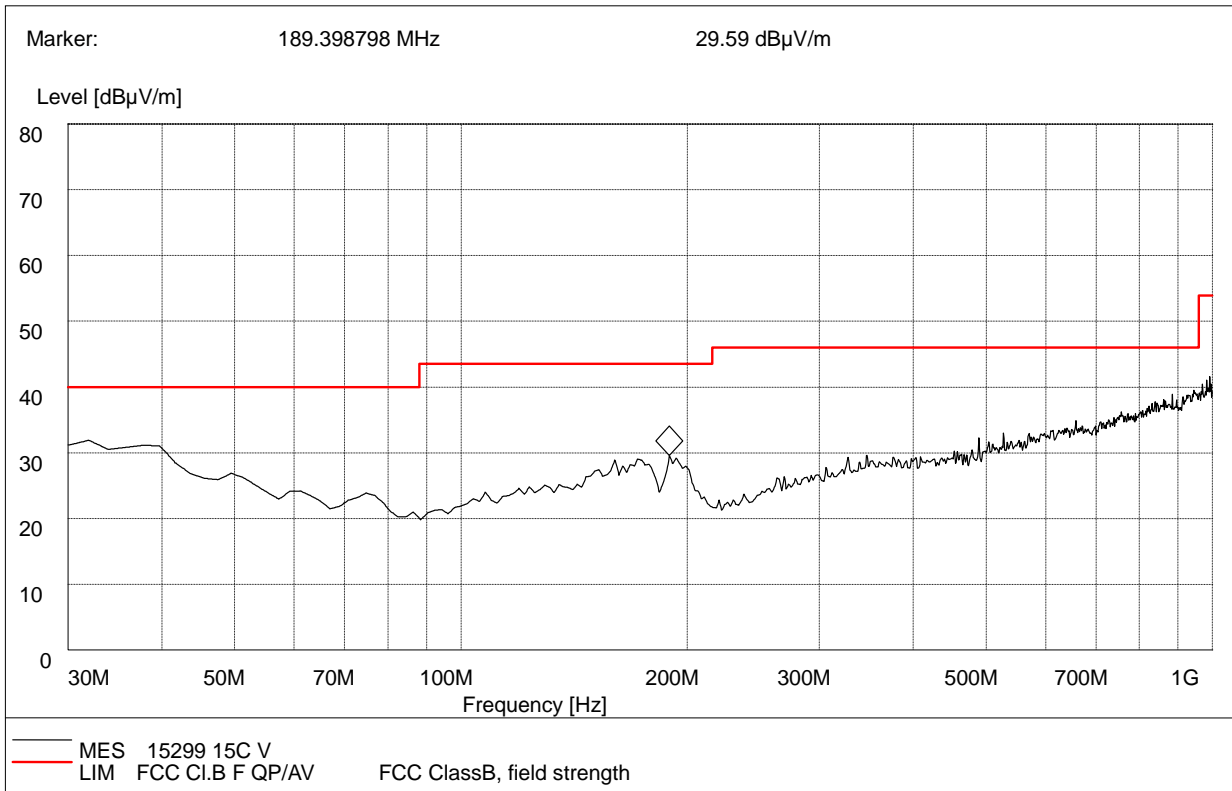

(Plot B: 30MHz to 1GHz, Antenna Vertical)

Frequency (MHz)	QuasiPeak (dBµ V/m)	Bandwidth (kHz)	Antenna height (cm)	Limit (dBµ V/m)	Antenna	Verdict
37.4900	30.41	120.000	100.0	40.0	Vertical	Pass
189.1500	29.43	120.000	100.0	43.5	Vertical	Pass



For 1GHz to 25GHz

ANTENNA POLARITY & TEST DISTANCE: HORIZONTAL AT 3 M (0CH_2402MHz)

No.	Frequency (MHz)	Emssion Level		Limit (dBuV/m)	Margin (dB)	Antenna Height	Table Angle	Raw Value	Antenna Factor	Cable Factor	Pre-amplifier
1	*2402.00	103.92	PK	/	/	1.00 H	112	107.32	28.30	4.90	-36.60
1	*2402.00	97.03	AV	/	/	1.00 H	112	100.43	28.30	4.90	-36.60
2	4804.00	47.51	PK	74.00	26.49	1.00 H	254	44.31	32.70	7.00	-36.50
2	4804.00	40.92	AV	54.00	13.08	1.00 H	254	37.72	32.70	7.00	-36.50
3	7206.00	48.96	PK	74.00	25.04	1.00 H	104	39.56	35.80	8.90	-35.30
3	7206.00	43.42	AV	54.00	10.58	1.00 H	104	34.02	35.80	8.90	-35.30
4	9608.00	48.15	PK	74.00	25.85	1.00 H	10	35.55	37.20	10.20	-34.80
4	9608.00	44.48	AV	54.00	9.52	1.00 H	10	31.88	37.20	10.20	-34.80

ANTENNA POLARITY & TEST DISTANCE: VERTICAL AT 3 M (0CH_2402MHz)

No.	Frequency (MHz)	Emssion Level		Limit (dBuV/m)	Margin (dB)	Antenna Height	Table Angle	Raw Value	Antenna Factor	Cable Factor	Pre-amplifier
1	*2402.00	103.59	PK	/	/	1.00 V	84	106.99	28.30	4.90	-36.60
1	*2402.00	95.22	AV	/	/	1.00 V	84	98.62	28.30	4.90	-36.60
2	4804.00	48.01	PK	74.00	25.99	1.00 V	109	44.81	32.70	7.00	-36.50
2	4804.00	45.06	AV	54.00	8.94	1.00 V	109	41.86	32.70	7.00	-36.50
3	7206.00	48.82	PK	74.00	25.18	1.00 V	22	39.42	35.80	8.90	-35.30
3	7206.00	42.59	AV	54.00	11.41	1.00 V	22	33.19	35.80	8.90	-35.30
4	9608.00	50.67	PK	74.00	23.33	1.00 V	323	38.07	37.20	10.20	-34.80
4	9608.00	44.44	AV	54.00	9.56	1.00 V	323	31.84	37.20	10.20	-34.80

ANTENNA POLARITY & TEST DISTANCE: HORIZONTAL AT 3 M (20CH_2442MHz)

No.	Frequency (MHz)	Emssion Level		Limit (dBuV/m)	Margin (dB)	Antenna Height	Table Angle	Raw Value	Antenna Factor	Cable Factor	Pre-amplifier
1	*2442.00	103.91	PK	/	/	1.00 H	15	107.11	28.30	5.10	-36.60
1	*2442.00	97.59	AV	/	/	1.00 H	15	100.79	28.30	5.10	-36.60
2	4884.00	46.01	PK	74.00	27.99	1.00 H	28	42.61	32.30	7.60	-36.50
2	4884.00	41.82	AV	54.00	12.18	1.00 H	28	38.42	32.30	7.60	-36.50
3	7326.00	51.13	PK	74.00	22.87	1.00 H	39	41.73	36.10	8.60	-35.30
3	7326.00	45.26	AV	54.00	8.74	1.00 H	39	35.86	36.10	8.60	-35.30
4	9768.00	49.45	PK	74.00	24.55	1.00 H	205	36.85	37.20	10.20	-34.80
4	9768.00	44.09	AV	54.00	9.91	1.00 H	205	31.49	37.20	10.20	-34.80



ANTENNA POLARITY & TEST DISTANCE: VERTICAL AT 3 M (20CH_2442MHz)

No.	Frequency (MHz)	Emission Level		Limit (dBuV/m)	Margin (dB)	Antenna Height	Table Angle	Raw Value	Antenna Factor	Cable Factor	Pre-amplifier
1	*2442.00	103.57	PK	/	/	1.00 V	87	106.77	28.30	5.10	-36.60
1	*2442.00	96.14	AV	/	/	1.00 V	87	99.34	28.30	5.10	-36.60
2	4884.00	47.03	PK	74.00	26.97	1.00 V	112	43.63	32.30	7.60	-36.50
2	4884.00	40.98	AV	54.00	13.02	1.00 V	112	37.58	32.30	7.60	-36.50
3	7326.00	53.32	PK	74.00	20.68	1.00 V	91	43.92	36.10	8.60	-35.30
3	7326.00	45.76	AV	54.00	8.24	1.00 V	91	36.36	36.10	8.60	-35.30
4	9768.00	48.56	PK	74.00	25.44	1.00 V	336	35.96	37.20	10.20	-34.80
4	9768.00	43.95	AV	54.00	10.05	1.00 V	336	31.35	37.20	10.20	-34.80

ANTENNA POLARITY & TEST DISTANCE: HORIZONTAL AT 3 M (39CH_2480MHz)

No.	Frequency (MHz)	Emission Level		Limit (dBuV/m)	Margin (dB)	Antenna Height	Table Angle	Raw Value	Antenna Factor	Cable Factor	Pre-amplifier
1	*2480.00	104.92	PK	/	/	1.00 H	15	108.22	28.60	4.70	-36.60
1	*2480.00	97.56	AV	/	/	1.00 H	15	100.86	28.60	4.70	-36.60
2	4960.00	50.08	PK	74.00	23.92	1.00 H	99	46.28	33.00	7.00	-36.20
2	4960.00	42.76	AV	54.00	11.24	1.00 H	99	38.96	33.00	7.00	-36.20
3	7440.00	49.37	PK	74.00	24.63	1.00 H	215	39.97	36.20	8.50	-35.30
3	7440.00	42.12	AV	54.00	11.88	1.00 H	215	32.72	36.20	8.50	-35.30
4	9920.00	50.02	PK	74.00	23.98	1.00 H	9	37.42	37.20	10.20	-34.80
4	9920.00	40.85	AV	54.00	13.15	1.00 H	9	28.25	37.20	10.20	-34.80

ANTENNA POLARITY & TEST DISTANCE: VERTICAL AT 3 M (39CH_2480MHz)

No.	Frequency (MHz)	Emission Level		Limit (dBuV/m)	Margin (dB)	Antenna Height	Table Angle	Raw Value	Antenna Factor	Cable Factor	Pre-amplifier
1	*2480.00	104.10	PK	/	/	1.00 V	29	107.40	28.60	4.70	-36.60
1	*2480.00	96.93	AV	/	/	1.00 V	29	100.23	28.60	4.70	-36.60
2	4960.00	49.21	PK	74.00	24.79	1.00 V	114	45.41	33.00	7.00	-36.20
2	4960.00	47.65	AV	54.00	6.35	1.00 V	114	43.85	33.00	7.00	-36.20
3	7440.00	49.27	PK	74.00	24.73	1.00 V	87	39.87	36.20	8.50	-35.30
3	7440.00	43.80	AV	54.00	10.20	1.00 V	87	34.40	36.20	8.50	-35.30
4	9920.00	49.36	PK	74.00	24.64	1.00 V	168	36.76	37.20	10.20	-34.80
4	9920.00	44.42	AV	54.00	9.58	1.00 V	168	31.82	37.20	10.20	-34.80

- REMARKS:**
1. Emission level (dBuV/m) =Raw Value (dBuV) +Antenna Factor (dB/m) + Cable Factor (dB) +Pre-amplifier Factor
 2. The other emission levels were very low against the limit.
 3. The other emission levels were very low against the limit.
 4. Margin value = Limit value- Emission level.
 5. The limit value is defined as per 15.247
 6. “ * “ : Fundamental frequency

Annex A Accreditation Certificate

China National Accreditation Service for Conformity Assessment

LABORATORY ACCREDITATION CERTIFICATE

(Registration No. CNAS L1659)

CCIC Southern Electronic Product Testing (Shenzhen) Co., Ltd.

Building 28/29, Shigudong, Xili Industrial Area, Xili Street,

Nanshan District, Shenzhen, Guangdong, China

is accredited to ISO/IEC 17025:2005 General Requirements for the Competence of Testing and Calibration Laboratories(CNAS-CL01 Accreditation Criteria for the Competence of Testing and Calibration Laboratories) for the competence of testing and calibration.

The scope of accreditation is detailed in the attached appendices bearing the same registration number as above. The appendices form an integral part of this certificate.

Date of Issue: 2012-09-29

Date of Expiry: 2015-09-28

Date of Initial Accreditation: 1999-08-03

Date of Update: 2012-09-29



Signed on behalf of China National Accreditation Service
for Conformity Assessment

China National Accreditation Service for Conformity Assessment (CNAS) is authorized by Certification and Accreditation Administration of the People's Republic of China (CNCA) to operate the national accreditation schemes for conformity assessment. CNAS is the signatory to International Laboratory Accreditation Cooperation Multilateral Recognition Arrangement (ILAC MRA) and Asia Pacific Laboratory Accreditation Cooperation Multilateral Recognition Arrangement (APLAC MRA).

No.CNAS AL 2

0005210

Annex B PHOTOGRAPHS OF THE EUT





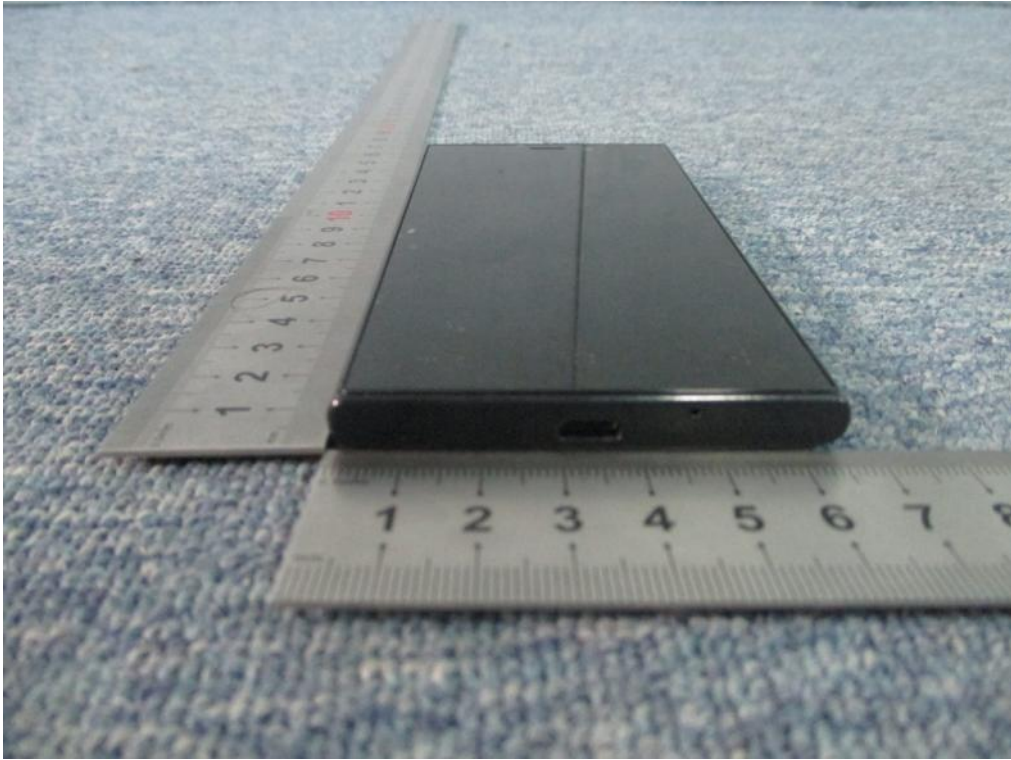

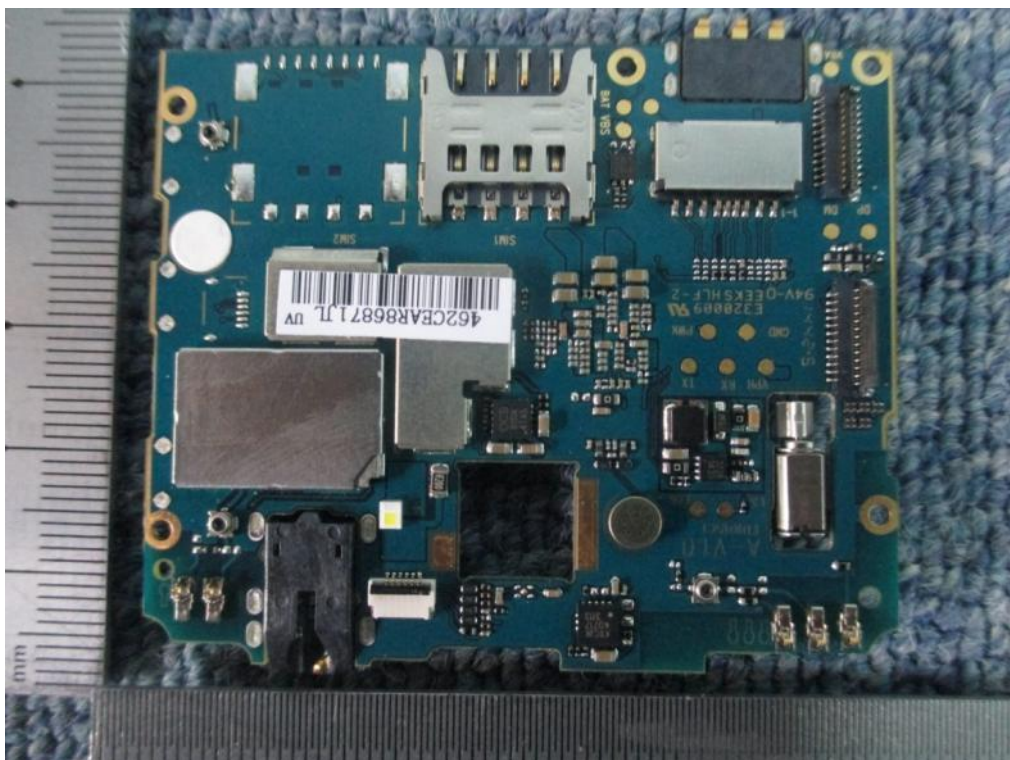

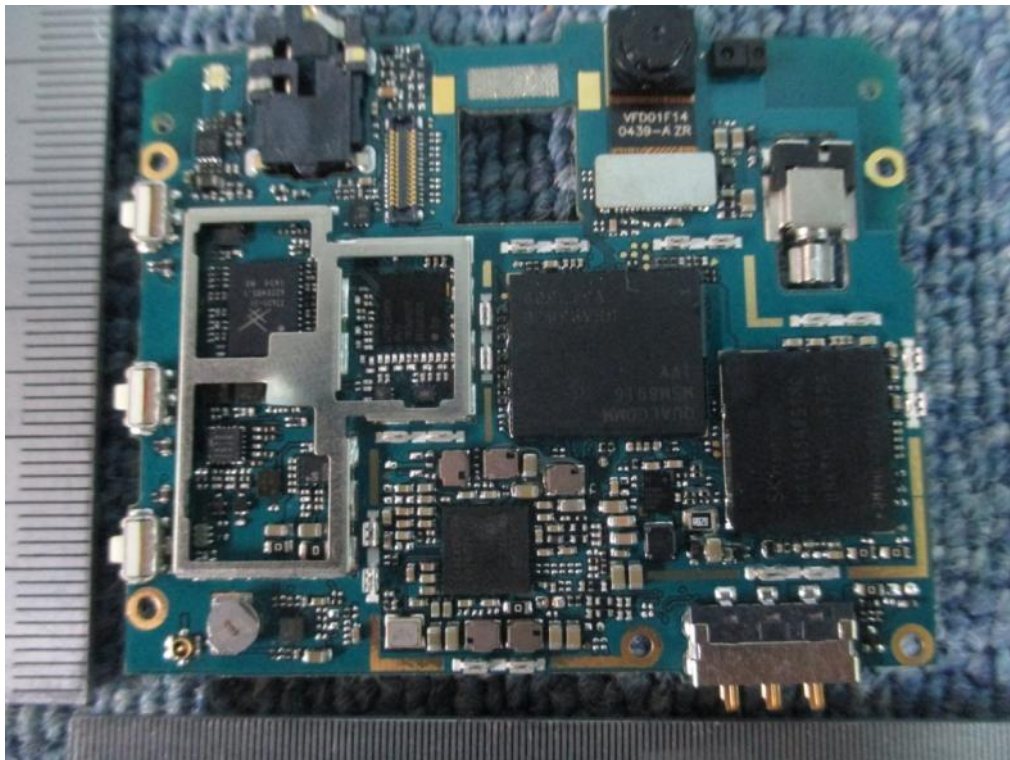
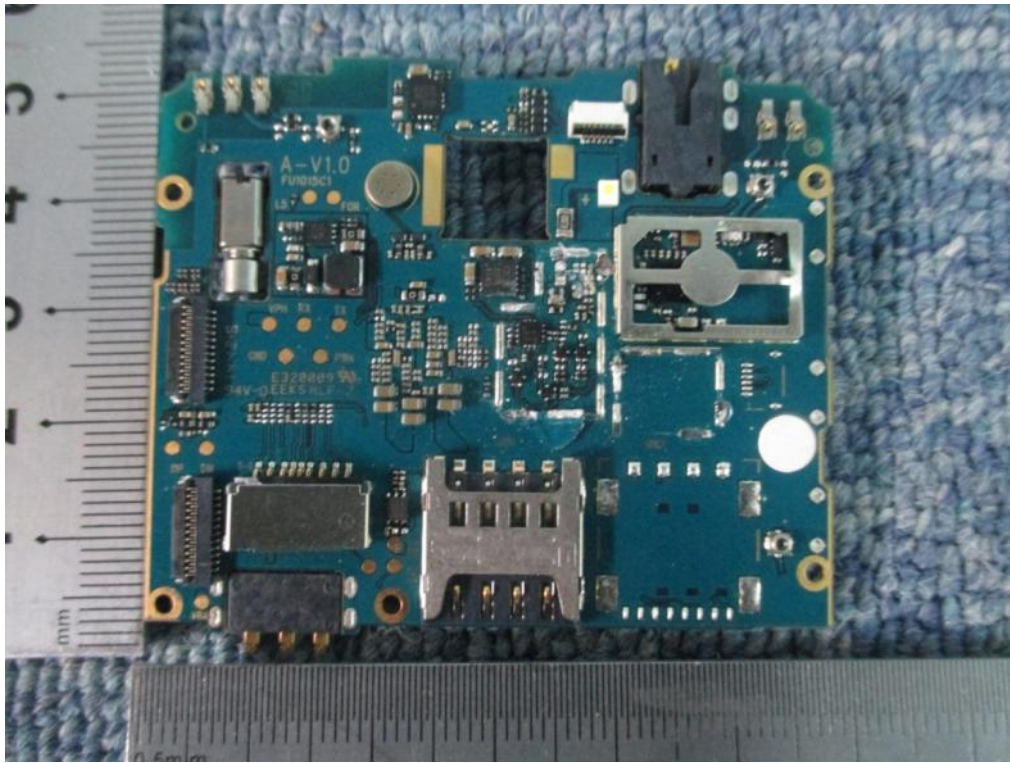

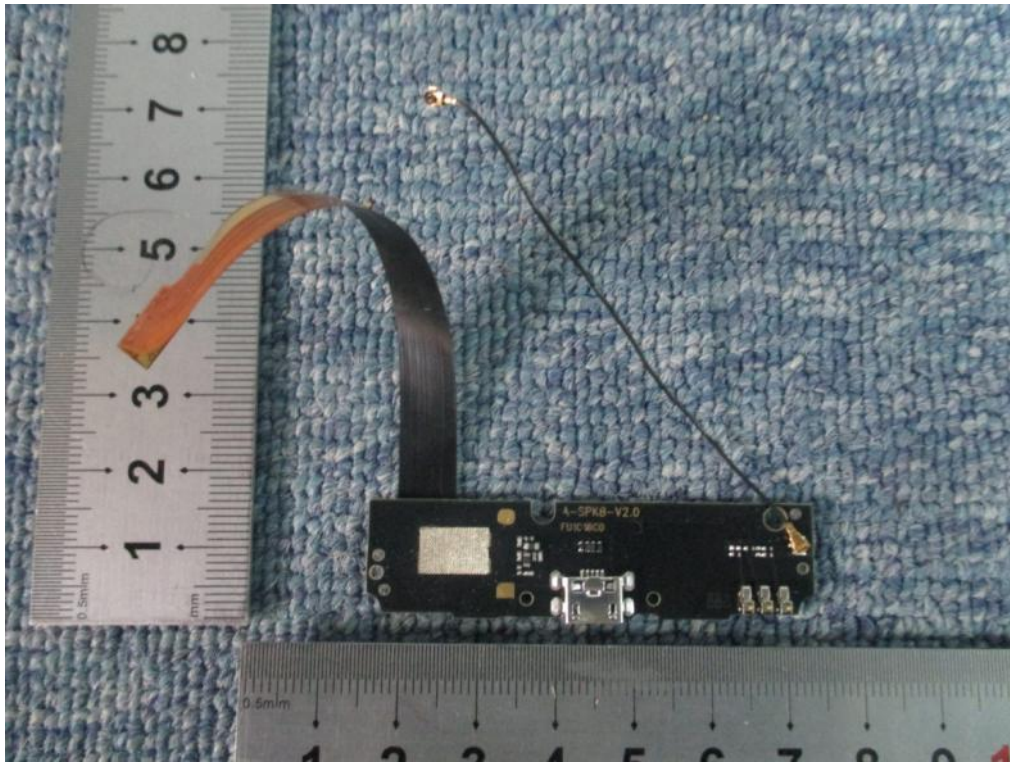



Annex C PHOTOGRAPHS OF THE TEST SETUP

1. Conducted Measurement Setup

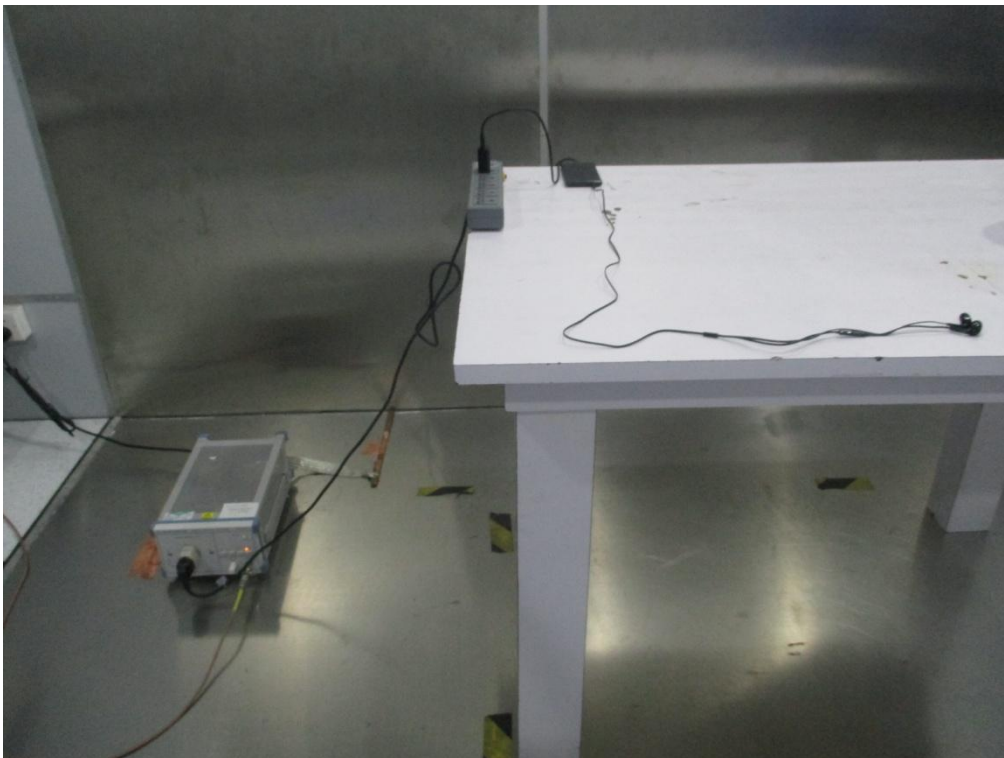
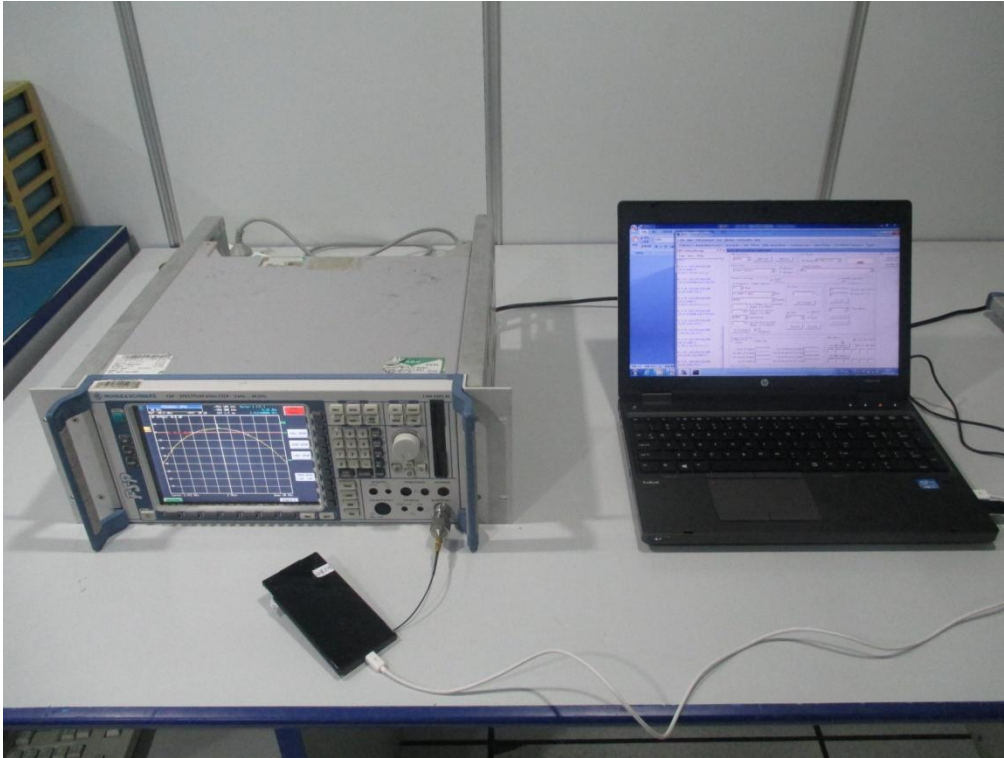

2. Radiated Measurement Setup

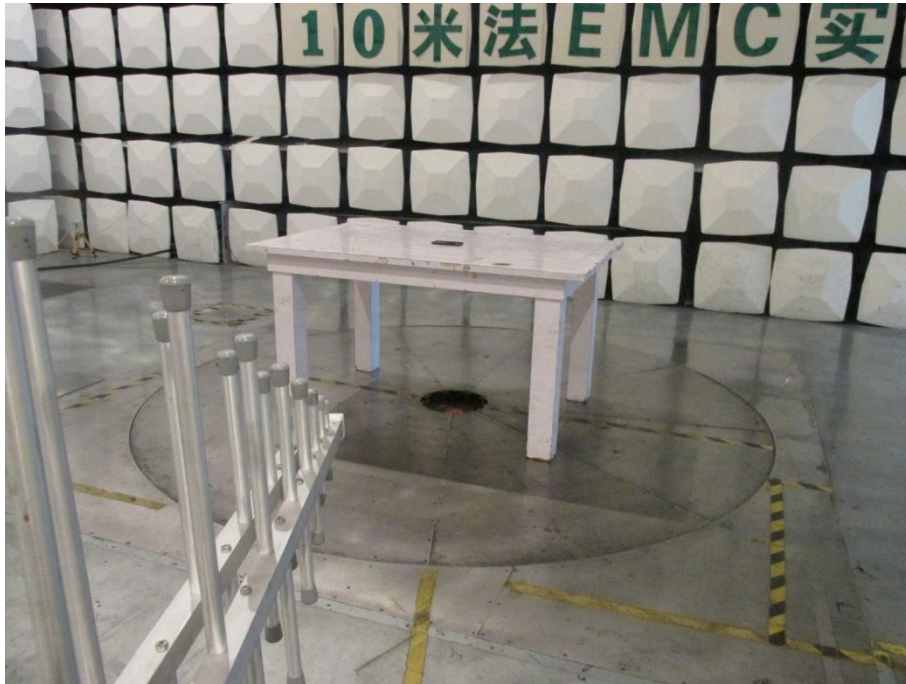

** END OF REPORT **