



RF TEST REPORT

Report No.: SET2014-13269

Product: LTE Mobile Phone

FCC ID: CLNSS4445

Model No.: M4 SS4445

Applicant: MFOURTEL MEXICO S.A. DE C.V.

Address: Av. Ejército Nacional 436 Piso 3 Chapultepec Morales Miguel
Hidalgo Distrito Federal 11570.

Issued by: CCIC-SET

Lab Location: Electronic Testing Building, Shahe Road, Xili, Nanshan District,
Shenzh China

Tel: 86 755 26627338

Fax: 86 755 26627238

This test report consists of 115 pages in total. It may be duplicated completely for legal use with the approval of the applicant. It should not be reproduced except in full, without the written approval of our laboratory. The client should not use it to claim product endorsement by CCIC-SET. The test results in the report only apply to the tested sample. The test report shall be invalid without all the signatures of testing engineers, reviewer and approver. Any objections must be raised to CCIC-SET within 15 days since the date when the report is received. It will not be taken into consideration beyond this limit.



Test Report

Product.....: LTE Mobile Phone

Brand Name.....: M4

Trade Name.....: M4

Applicant.....: MFOURTEL MEXICO S.A. DE C.V.

Applicant Address.....: Av. Ejército Nacional 436 Piso 3 Chapultepec Morales Miguel Hidalgo Distrito Federal 11570.

Manufacturer.....: CK Telecom Limited

Manufacturer Address.....: Technology Road.High-Tech Development Zone. Heyuan, Guangdong,P.R.China.

Test Standards.....: 47 CFR Part 2(10-1-12 Edition) Frequency Allocations and Radio Treaty Matters; General Rules and Regulations
47 CFR Part 22(10-1-12 Edition) Public Mobile Services
47 CFR Part 24(10-1-12 Edition)Personal Communications Services

Test Result.....: PASS

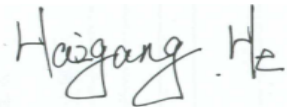
Tested by.....:  2014.11.27

Haigang He, Test Engineer

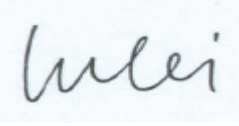
Reviewed by.....:  2014.11.27

Shuangwen Zhang, Senior EGINEER

Approved by.....:  2014.11.27

Wu Li'an, Manager



Table of Contents

- 1. GENERAL INFORMATION4**
- 1.1 EUT Description4**
- 1.2 Maximum ERP/EIRP Power, Frequency Tolerance, and Emission Designator5**
- 1.3 Test Standards and Results.....5**
- 1.4 Test Configuration of Equipment under Test.....6**
- 1.5 Facilities and Accreditations7**
- 2. 47 CFR PART 2, PART 22H & 24E REQUIREMENTS8**
- 2.1 Conducted RF Output Power8**
- 2.2 Peak to Average Ratio 11**
- 2.3 99% Occupied Bandwidth17**
- 2.4 Frequency Stability.....61**
- 2.5 Conducted Out of Band Emissions66**
- 2.6 Band Edge86**
- 2.7 Transmitter Radiated Power (EIRP/ERP).....93**
- 2.8 Radiated Out of Band Emissions98**
- ANNEX A ACCREDITATION CERTIFICATE106**
- ANNEX B PHOTOGRAPHS OF THE EUT107**
- ANNEX C PHOTOGRAPHS OF THE TEST SETUP 114**
- 1. CONDUCTED MEASUREMENT SETUP 114**
- 2. RADIATED MEASUREMENT SETUP 114**

Change History		
Issue	Date	Reason for change
1.0	2014-11-27	First edition



1. GENERAL INFORMATION

1.1 EUT Description

EUT Type	LTE Mobile Phone
Serial No.	SS44456B4000114
IMEI No.	355616029894916
Hardware Version	A-V1.0
Software Version	M4_SS4445_S10_Ver200
EUT supports Radios application	GSM/GPRS/WCDMA/HSPA/LTE WLAN2.4GHz 802.11b/g/n (HT20/HT40) Bluetooth v4.0 LE
Frequency Range	GSM 850MHz: Tx: 824.2 - 848.8MHz (at intervals of 200kHz); Rx: 869.2 - 893.8MHz (at intervals of 200kHz) GSM 1900MHz: Tx: 1850.2 - 1909.8MHz (at intervals of 200kHz); Rx: 1930.2 - 1989.8MHz (at intervals of 200kHz) WCDMA 850MHz Tx: 826.4 - 846.6MHz (at intervals of 200kHz); Rx: 871.4 - 891.6MHz (at intervals of 200kHz) WCDMA 1900MHz Tx: 1852.4 - 1907.6MHz (at intervals of 200kHz); Rx: 1932.4 - 1987.6MHz (at intervals of 200kHz)
Multislot Class.....:	GPRS: Multislot Class12,EGPRS: Multislot Class12
Maximum Output Power to Antenna	GSM 850: 33.63dBm GSM 1900: 30.76dBm EDGE 850: 32.96dBm EDGE 1900: 30.34dBm WCDMA 850: 23.36 WCDMA 1900: 23.25
Antenna Type.....:	PIFA Antenna
Type of Modulation	GMSK,8PSK,QPSK



1.2 Maximum ERP/EIRP Power, Frequency Tolerance, and Emission Designator

System	Emission Designator	Frequency Tolerance (ppm)	Maximum ERP/EIRP(W)
GSM 850	244KGXW	0.06	2.477
GSM 1900	252KGXW	0.03	1.352
GPRS 850	252KGXW	-	-
GPRS 1900	252KGXW	-	-
EDGE 850	248KG7W	0.06	1.611
EDGE 1900	248KG7W	0.03	0.957
WCDMA 850	4M16F9W	0.06	0.393
WCDMA 1900	4M16F9W	0.03	0.381
HSDPA 850	4M18F9W	-	-
HSDPA 1900	4M16F9W	-	-
HSUPA 850	4M18F9W	-	-
HSUPA 1900	4M16F9W	-	-
HSPA+ 850	4M20F9W	-	-
HSPA+ 1900	4M20F9W	-	-

1.3 Test Standards and Results

The objective of the report is to perform testing according to 47 CFR Part 2, Part 22, Part 24 for the EUT FCC ID Certification:

1. 47 CFR Part 2, 22(H), 24(E)
2. ANSI / TIA / EIA-603-C-2004
3. FCC KDB 971168 D01 Power Meas. License Digital Systems v02r01

Test detailed items/section required by FCC rules and results are as below:

No.	Section	Description	Limit	Result
1	2.1046	Conducted RF Output Power	Reporting Only	PASS
2	24.232(d)	Peak to Average Ratio	< 13dBm	PASS
3	2.1049,	99% Occupied Bandwidth and	Reporting Only	PASS



	22.917(b) 24.238(b)	26dB Bandwidth		
4	2.1055, 22.355 24.235	Frequency Stability	<2.5ppm	PASS
5	2.1051 22.917(a) 24.238(a)	Conducted Out of Band Emissions	< 43+10log10(P[Watts])	PASS
6	2.1051 22.917(a) 24.238(a)	Band Edge	< 43+10log10(P[Watts])	PASS
7	22.913(a)(2)	Effective Radiated Power	<7Watts	PASS
	24.232(c)	Equivalent Isotropic Radiated Power	<2Watts	PASS
8	2.1053 22.917(a) 24.238(a)	Field Strength of Spurious Radiation	< 43+10log10(P[Watts])	PASS

Remark:

1. All test items were verified and recorded according to the standards and without any deviation during the test.
2. This EUT has also been tested and complied with the requirements of FCC Part 15, Subpart B, recorded in a separate test report.

1.4 Test Configuration of Equipment under Test

Antenna port conducted and radiated test items were performed according to KDB 971168 D01 Power Meas. License Digital Systems v02r01 with maximum output power.

Radiated measurements were performed with rotating EUT in different three orthogonal test planes to find the maximum emission.

Radiated emissions were investigated as following frequency range:

1. 30 MHz to 9000 MHz for GSM850 and WCDMA Band V.
2. 30 MHz to 20000 MHz for GSM1900 and WCDMA Band II.

All modes and data rates and positions were investigated.

Test modes are chosen to be reported as the worst case configuration below:

Test Modes		
Band	Radiated TCs	Conducted TCs
GSM 850	GSM Link EDGE Link	GSM Link EDGE Link
GSM 1900	GSM Link EDGE Link	GSM Link EDGE Link
WCDMA Band V	RMC 12.2Kbps Link	RMC 12.2Kbps Link
WCDMA Band II	RMC 12.2Kbps Link	RMC 12.2Kbps Link



Note: The maximum power levels are chosen to test as the worst case configuration as follows: GSM mode for GMSK modulation, EDGE multi-slot class 8 mode for 8PSK modulation, RMC 12.2Kbps mode for WCDMA band V, RMC 12.2Kbps mode for WCDMA band II, only these modes were used for all tests.

1.5 Facilities and Accreditations

1.5.1 Test Facilities

CNAS-Lab Code: L1659

CCIC Southern Electronic Product Testing (Shenzhen) Co., Ltd. CCIC is a third party testing organization accredited by China National Accreditation Service for Conformity Assessment (CNAS) according to ISO/IEC 17025. The accreditation certificate number is L1659. A 12.8*6.8*6.4 (m) fully anechoic chamber was used for the radiated spurious emissions test.

FCC-Registration No.: 406086

CCIC Southern Electronic Product Testing (Shenzhen) Co., Ltd. EMC Laboratory has been registered and fully described in a report filed with the FCC (Federal Communications Commission). The acceptance letter from the FCC is maintained in our files. Registration 406086, Renewal date Nov. 19, 2011, valid time is until Nov. 18, 2014.

IC-Registration No.: 11185A-1

CCIC Southern Electronic Product Testing (Shenzhen) Co., Ltd. EMC Laboratory has been registered by Certification and Engineering Bureau of Industry Canada for the performance of radiated measurements with Registration No. 11185A-1 on July. 15, 2013, valid time is until July. 15, 2016.

1.5.2 Test Environment Conditions

During the measurement, the environmental conditions were within the listed ranges:

Temperature (°C):	15°C - 35°C
Relative Humidity (%):	30% -60%
Atmospheric Pressure (kPa):	86KPa-106KPa

2. 47 CFR PART 2, PART 22H & 24E REQUIREMENTS

2.1 Conducted RF Output Power

2.1.1 Requirement

According to FCC section 2.1046(a), for transmitters other than single sideband, independent sideband and controlled carrier radiotelephone, power output shall be measured at the RF output terminals when the transmitter is adjusted in accordance with the tune-up procedure to give the values of current and voltage on the circuit elements specified in FCC section 2.1033(c)(8).

2.1.2 Test Description

1. Test Setup:

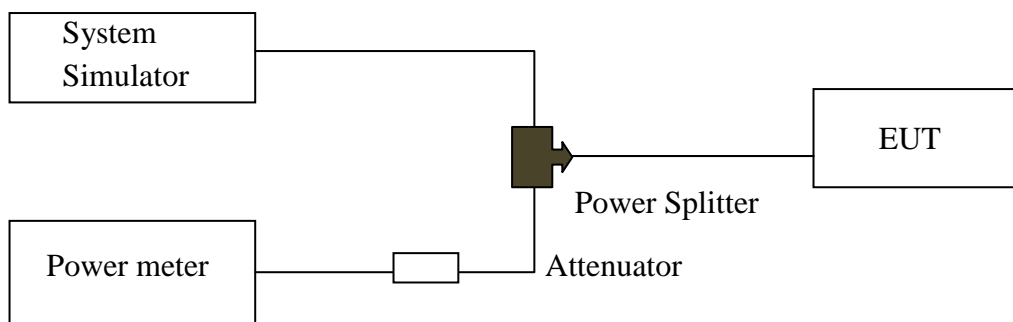

The EUT, which is powered by the Battery, is coupled to the Power meter and the System Simulator (SS) with Attenuators through the Power Splitter; the RF load attached to the EUT antenna terminal is 50Ohm; the path loss as the factor is calibrated to correct the reading. The EUT is commanded by the SS to operate at the maximum output power i.e. Power Control Level (PCL) = 5 and Power Class = 4. A call is established between the EUT and the SS.

2. Equipments List:

Description	Manufacturer	Model	Serial No.	Cal. Date	Cal. Due Date
System Simulator	Agilent	E5515C	MY47510547	2014.06.11	2015.06.10
Power Meter	R&S	NRV2	1020.1809.02	2014.06.08	2015.06.07
Power Sensor	R&S	NRV-Z4	823.3618.03	2014.06.08	2015.06.07
Attenuator	MCE	10dB	BN3693	2014.06.11	2015.06.10



2.1.3 Test Results

Here the lowest, middle and highest channels are selected to perform testing to verify the conducted RF output power of the EUT.

1. GSM Model Test Verdict:

Band	Channel	Frequency (MHz)	Measured Output Power dBm	Verdict
GSM 850MHz	128	824.2	33.28	PASS
	190	836.6	33.63	PASS
	251	848.8	33.61	PASS
GSM 1900MHz	512	1850.2	30.76	PASS
	661	1880.0	30.70	PASS
	810	1909.8	30.58	PASS
GPRS 850MHz	128	824.2	33.13	PASS
	190	836.6	33.24	PASS
	251	848.8	33.45	PASS
GPRS 1900MHz	512	1850.2	30.62	PASS
	661	1880.0	30.57	PASS
	810	1909.8	30.53	PASS
EDGE 850MHz	128	824.2	32.96	PASS
	190	836.6	32.76	PASS
	251	848.8	32.84	PASS
EDGE 1900MHz	512	1850.2	30.23	PASS
	661	1880.0	30.34	PASS
	810	1909.8	30.26	PASS

Note 1: For the GPRS and EDGE model, all the slots were tested and just the worst data was record in this report.



2. WCDMA Model Test Verdict:

Item	band	WCDMA 850			WCDMA 1900		
	ARFCN	4132	4183	4233	9262	9400	9538
	subtest	dBm			dBm		
5.2(WCDMA)	non	23.17	23.36	23.21	23.23	23.25	23.09
HSDPA	1	22.71	22.51	22.84	22.67	22.79	22.58
	2	22.29	22.71	22.29	22.47	22.05	22.54
	3	21.68	21.91	21.78	21.85	21.89	21.95
	4	21.79	21.54	21.61	21.77	21.94	21.83
HSUPA	1	22.24	22.37	22.77	22.54	22.37	22.77
	2	22.29	22.14	22.21	22.03	21.89	21.74
	3	21.86	22.09	22.08	22.17	22.01	22.08
	4	22.05	22.04	22.33	21.99	21.51	21.74
	5	22.23	22.16	22.11	22.05	22.25	22.08
HSPA+	1	22.23	22.48	22.25	22.39	22.45	22.57

2.2 Peak to Average Ratio

2.2.1 Definition

According to FCC section 2.1049 and FCC 24.232(d), the peak-to-average ratio (PAR) of the transmission may not exceed 13 dB.

2.2.2 Test Description

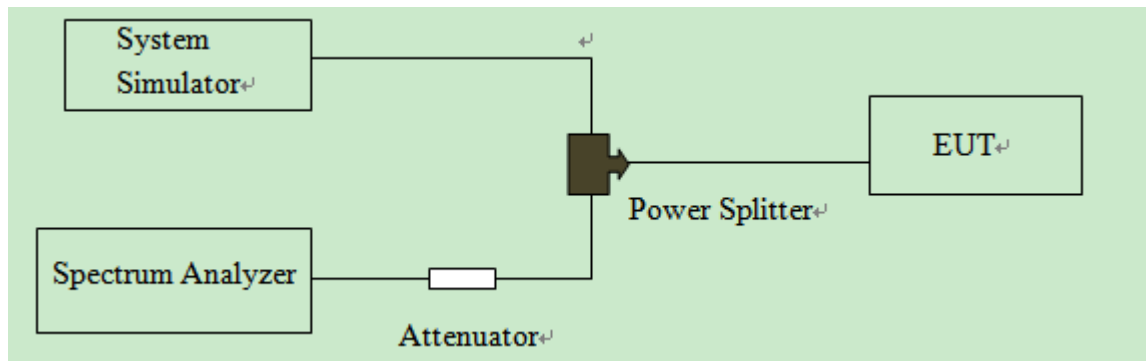

Description	Manufacturer	Model	Serial No.	Cal. Date	Cal. Due Date
System Simulator	R&S	CMW500	149333	2014.07.21	2015.07.20
Spectrum Analyzer	R&S	FSP40	100341	2014.07.07	2015.07.06
Attenuator 1	Resent	10dB	(n.a.)	2014.06.11	2015.06.10
Attenuator 2	Resent	3dB	(n.a.)	2014.06.11	2015.06.10

2.2.3 Test Verdict

Here the lowest, middle and highest channels are selected to perform testing to verify the peak-to-average ratio.

Test procedures:

A. For GSM operating mode:

- Set RBW=1MHz, VBW=3MHz, Peak detector on spectrum analyzer for first trace.
- Set the RBW = 1MHz, VBW = 3MHz, RMS detector on spectrum analyzer for second trace.
- The wanted burst signal is triggered by spectrum analyzer, and measured respectively the peak level and Mean level without burst-off time, after system simulator has synchronized with the spectrum analyzer.

B. For UMTS operating mode:

- Set the CCDF (Complementary Cumulative Distribution Function) option in spectrum analyzer.
- The highest RF powers were measured and recorded the maximum PAPR level associated with a probability of 0.1%.
- Record the deviation as Peak to Average Ratio.



1. Test Verdict:

Band	Channel	Frequency (MHz)	Peak to Average ratio		Limit dBm	Verdict
			dBm	Refer to Plot		
GSM 1900MHz	512	1850.2	0.10	Plot A1 to A3	13	PASS
	661	1880.0	0.08			PASS
	810	1909.8	0.08			PASS
EDGE 1900MHz	512	1850.2	0.08	Plot B1 to B3	13	PASS
	661	1880.0	0.06			PASS
	810	1909.8	0.06			PASS
WCDMA 1900MHz	9262	1852.4	5.96	Plot C1 to C3	13	PASS
	9400	1880.0	5.96			PASS
	9538	1907.6	5.96			PASS

2. GSM Model Test Plots:

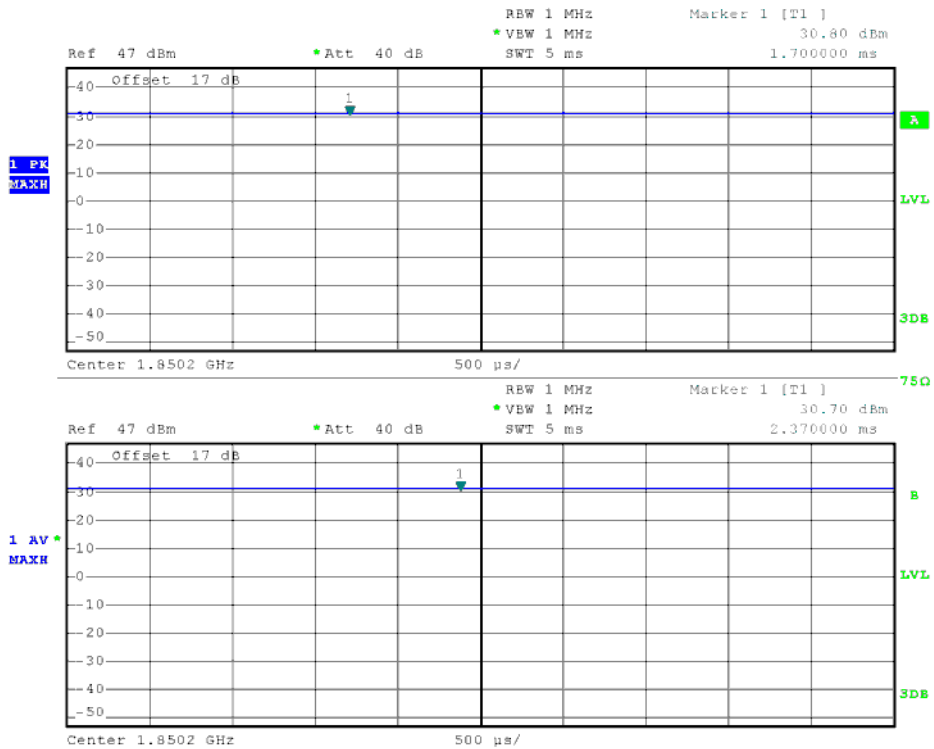

(Plot A1: GSM 1900 MHz Channel = 512)

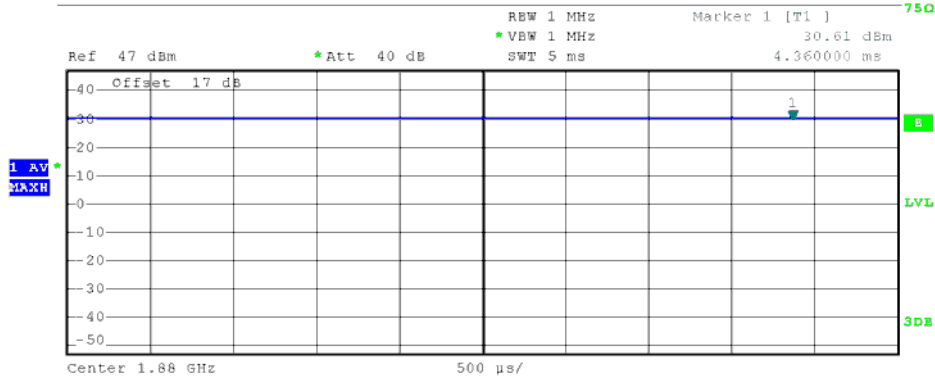
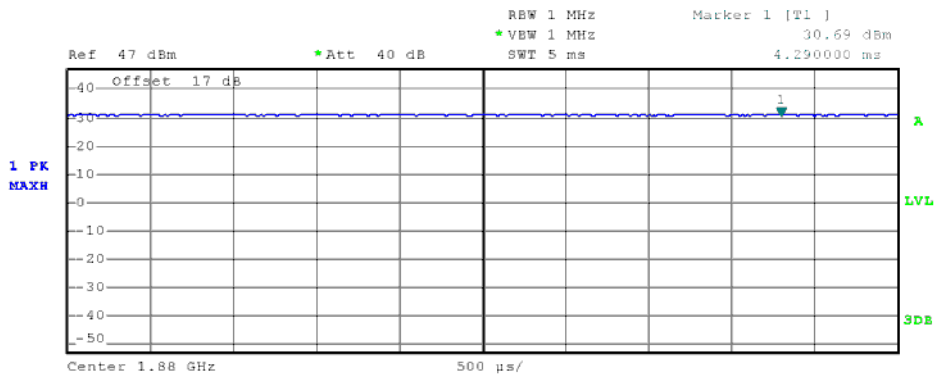

(Plot A2: GSM 1900 MHz Channel = 661)

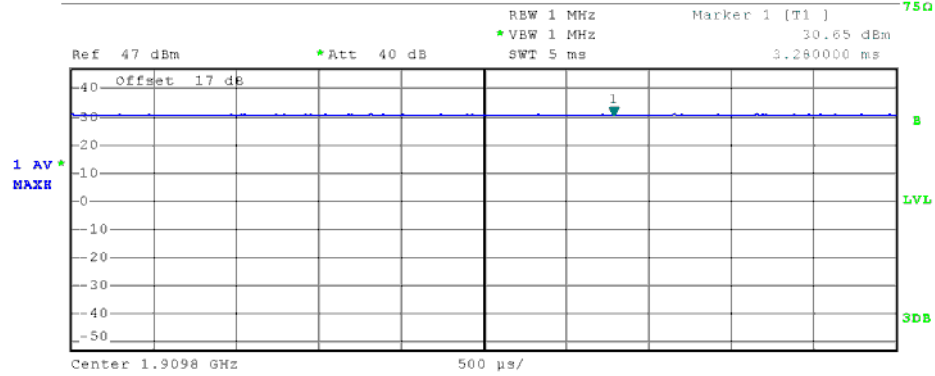
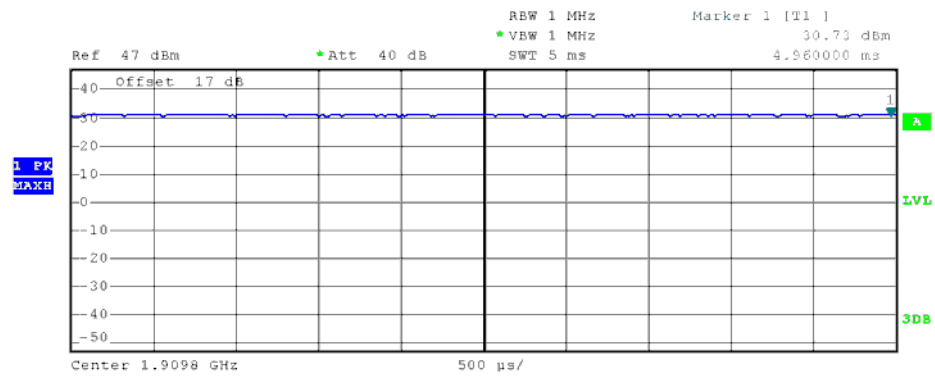

(Plot A3: GSM 1900MHz Channel = 810)

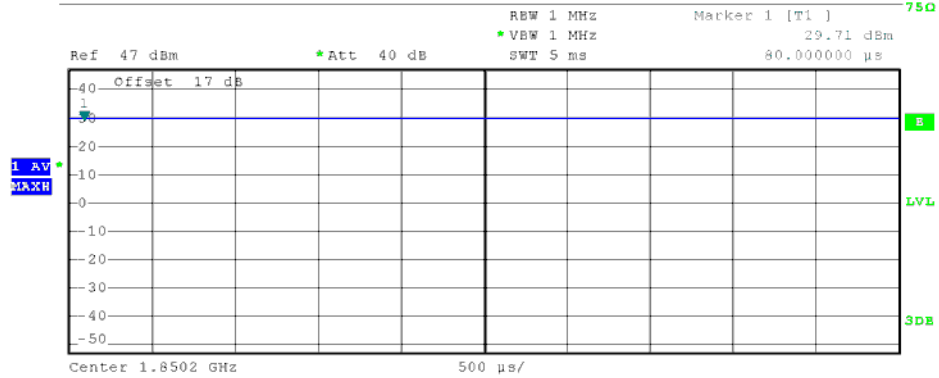
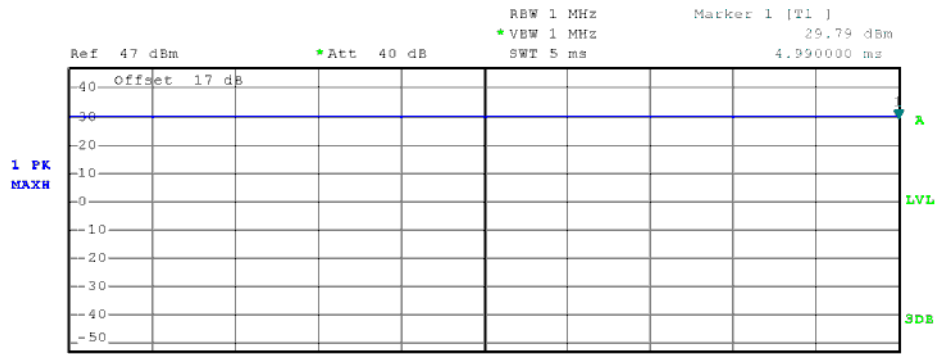

(Plot B1: EDGE 1900 MHz Channel = 512)

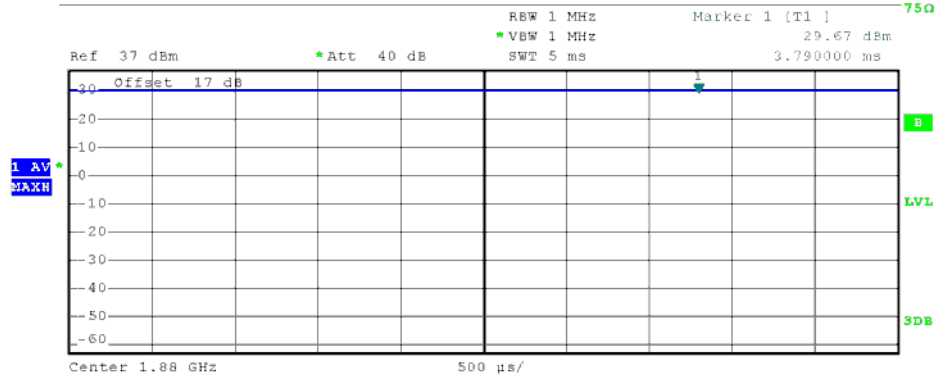
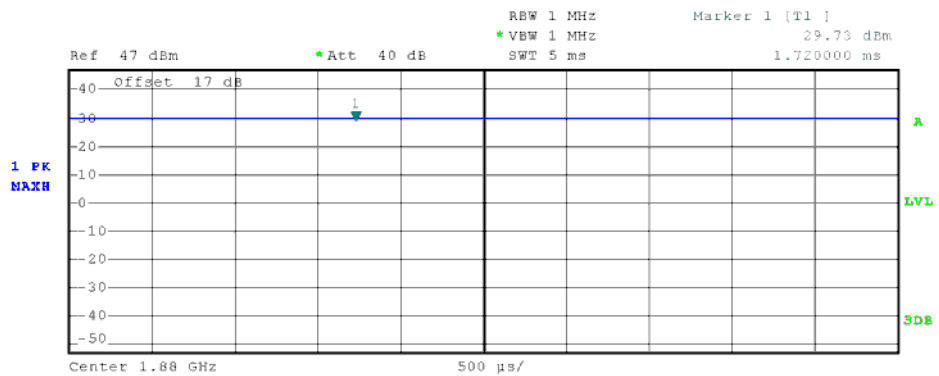

(Plot B2: EDGE 1900 MHz Channel = 661)

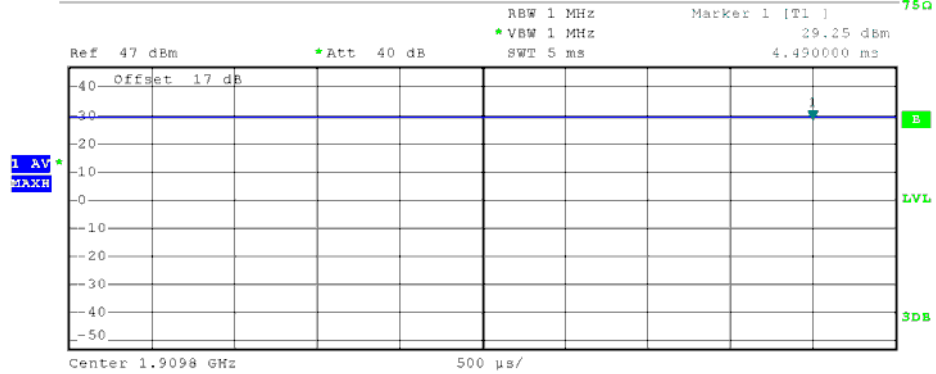
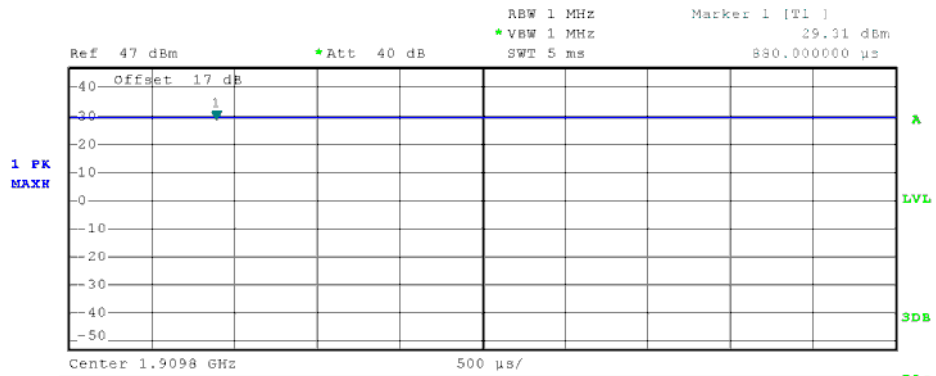

(Plot B3: EDGE 1900MHz Channel = 810)

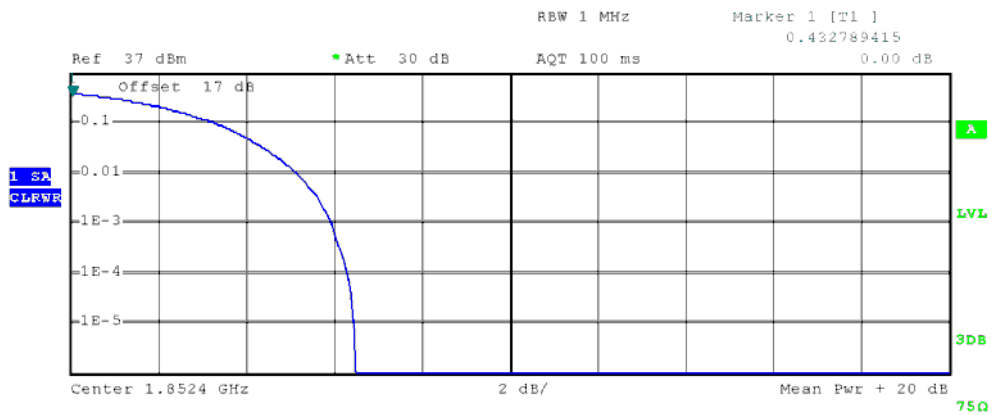

Complementary Cumulative Distribution Function (100000 samples)

Trace 1

Mean 17.58 dBm
 Peak 24.07 dBm
 Crest 6.50 dB

10 % 3.40 dB
 1 % 5.20 dB
 .1 % 5.96 dB
 .01 % 6.32 dB

(Plot C1: WCDMA 1900MHz Channel = 9262)

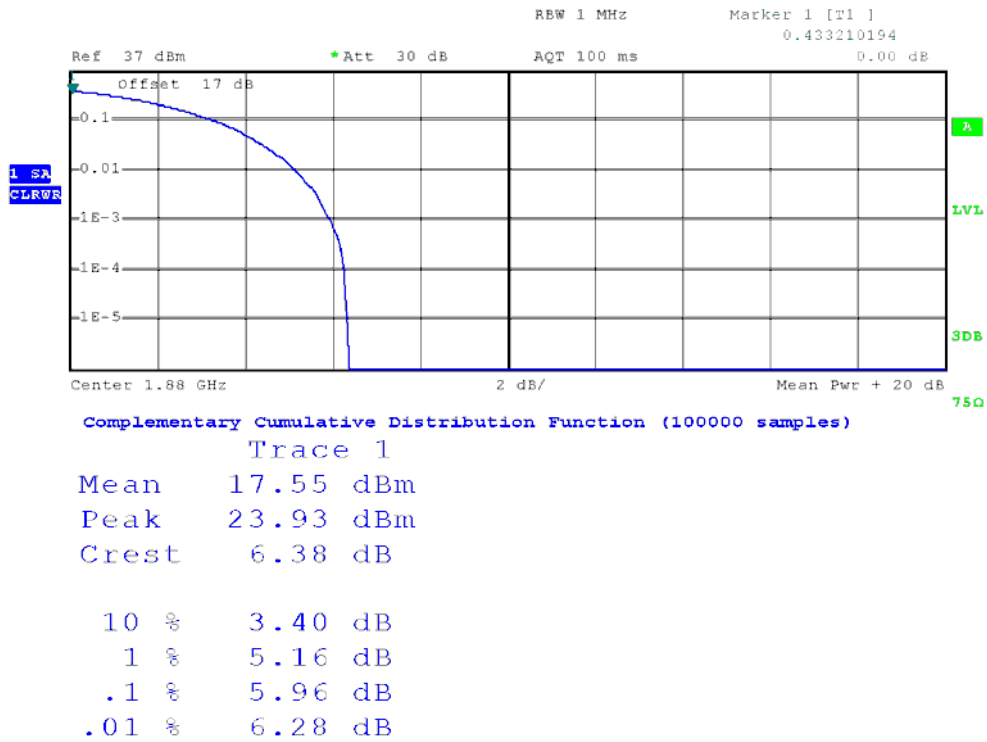

(Plot C2: WCDMA 1900MHz Channel = 9400)

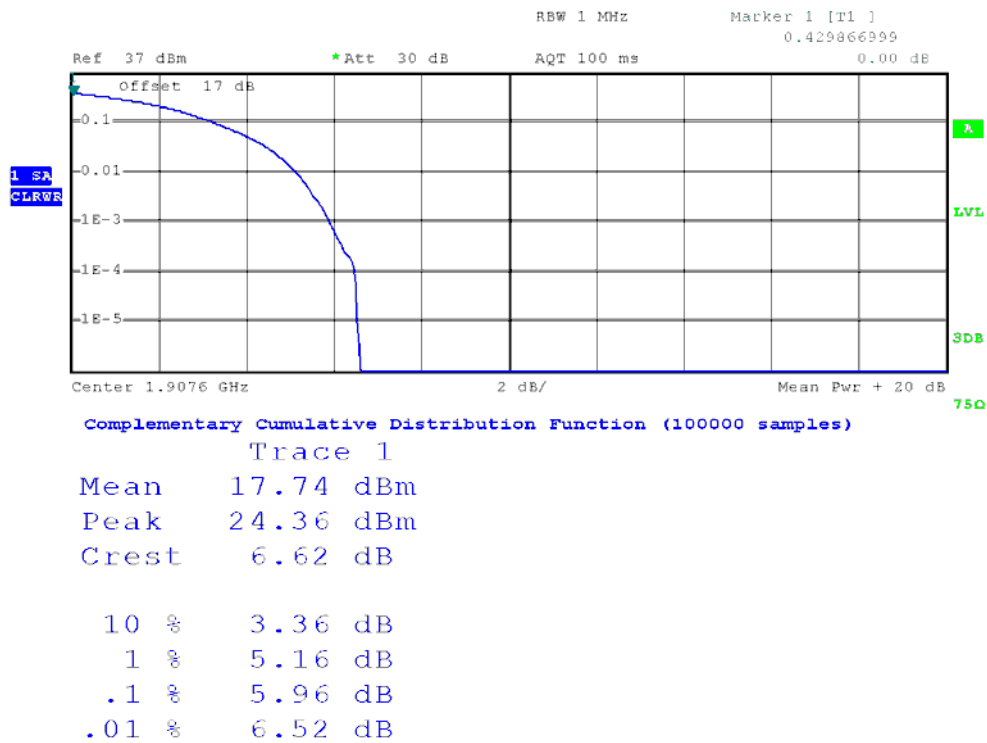

(Plot C3: WCDMA 1900MHz Channel = 9538)

2.3 99% Occupied Bandwidth

2.3.1 Definition

The 99% occupied bandwidth is the width of a frequency band such that, below the lower and above the upper frequency limits, the mean powers emitted are each equal to a specified percentage 0.5% of the total mean transmitted power.

The emission bandwidth is defined as the width of the signal between two points, located at the 2 sides of the carrier frequency, outside of which all emissions are attenuated at least 26 dB below the transmitter power.

2.3.2 Test Description

See section 2.1.2 of this report.

2.3.3 Test Procedures

1. The testing follows FCC KDB 971168 v02r01 Section 4.2.
2. The EUT was connected to the spectrum analyzer and system simulator via a power divider.
3. The RF output of the EUT was connected to the spectrum analyzer by RF cable and attenuator.
The path loss was compensated to the results for each measurement.
4. The 99% occupied bandwidth were measured, set RBW= 1% of span, VBW= 3*RBW, sample detector, trace maximum hold.
5. The 26dB bandwidth were measured, set RBW= 1% of EBW, VBW= 3*RBW, peak detector, trace maximum hold.

2.3.4 Test Verdict

Here the lowest, middle and highest channels are selected to perform testing to verify the 99% occupied bandwidth.

1. Test Verdict:

Band	Channel	Frequency (MHz)	26dB bandwidth	99% Occupied Bandwidth	Refer to Plot
GSM 850MHz	128	824.2	328KHz	244KHz	Plot A1-A2
	190	836.6	316KHz	244KHz	Plot A3-A4
	251	848.8	320KHz	244KHz	Plot A5-A6
GSM 1900MHz	512	1850.2	324KHz	252KHz	Plot B1-B2
	661	1880.0	320KHz	248KHz	Plot B3-B4
	810	1909.8	316KHz	248KHz	Plot B5-B6



Band	Channel	Frequency (MHz)	26dB bandwidth	99% Occupied Bandwidth	Refer to Plot
GPRS 850MHz	128	824.2	320KHz	252KHz	Plot C1-C2
	190	836.6	332KHz	248KHz	Plot C3-C4
	251	848.8	320KHz	252KHz	Plot C5-C6
GPRS 1900MHz	512	1850.2	324KHz	252KHz	Plot D1-D2
	661	1880.0	324KHz	244KHz	Plot D3-D4
	810	1909.8	316KHz	248KHz	Plot D5-D6
EDGE 850MHz	128	824.2	320KHz	244KHz	Plot E1-E2
	190	836.6	316KHz	248KHz	Plot E3-E4
	251	848.8	316KHz	248KHz	Plot E5-E6
EDGE 1900MHz	512	1850.2	320KHz	244KHz	Plot F1-F2
	661	1880.0	320KHz	248KHz	Plot F3-F4
	810	1909.8	316KHz	244KHz	Plot F5-F6
WCDMA Band V	4132	826.4	4.64MHz	4.14MHz	Plot G1-G2
	4183	836.6	4.68MHz	4.16MHz	Plot G3-G4
	4233	846.6	4.68MHz	4.14MHz	Plot G5-G6
WCDMA Band II	9262	1852.4	4.68MHz	4.14MHz	Plot H1-H2
	9400	1880	4.68MHz	4.16MHz	Plot H3-H4
	9538	1907.6	4.68MHz	4.16MHz	Plot H5-H6
HSDPA Band V	4132	826.4	4.66MHz	4.14MHz	Plot I1-I2
	4183	836.6	4.68MHz	4.18MHz	Plot I3-I4
	4233	846.6	4.66MHz	4.16MHz	Plot I5-I6
HSDPA Band II	9262	1852.4	4.68MHz	4.16MHz	Plot J1-J2
	9400	1880	4.66MHz	4.16MHz	Plot J3-J4
	9538	1907.6	4.68MHz	4.16MHz	Plot J5-J6
HSUPA Band V	4132	826.4	4.66MHz	4.14MHz	Plot K1-K2
	4183	836.6	4.68MHz	4.18MHz	Plot K3-K4
	4233	846.6	4.68MHz	4.14MHz	Plot K5-K6
HSUPA Band II	9262	1852.4	4.68MHz	4.16MHz	Plot L1-L2
	9400	1880	4.68MHz	4.16MHz	Plot L3-L4
	9538	1907.6	4.68MHz	4.16MHz	Plot L5-L6
HSPA+ Band V	4132	826.4	4.74MHz	4.20MHz	Plot M1-M2
	4183	836.6	4.76MHz	4.18MHz	Plot M3-M4
	4233	846.6	4.72MHz	4.20MHz	Plot M5-M6
HSPA+ Band II	9262	1852.4	4.74MHz	4.18MHz	Plot N1-N2
	9400	1880	4.74MHz	4.20MHz	Plot N3-N4
	9538	1907.6	4.76MHz	4.18MHz	Plot N5-N6



2. Test Plots:

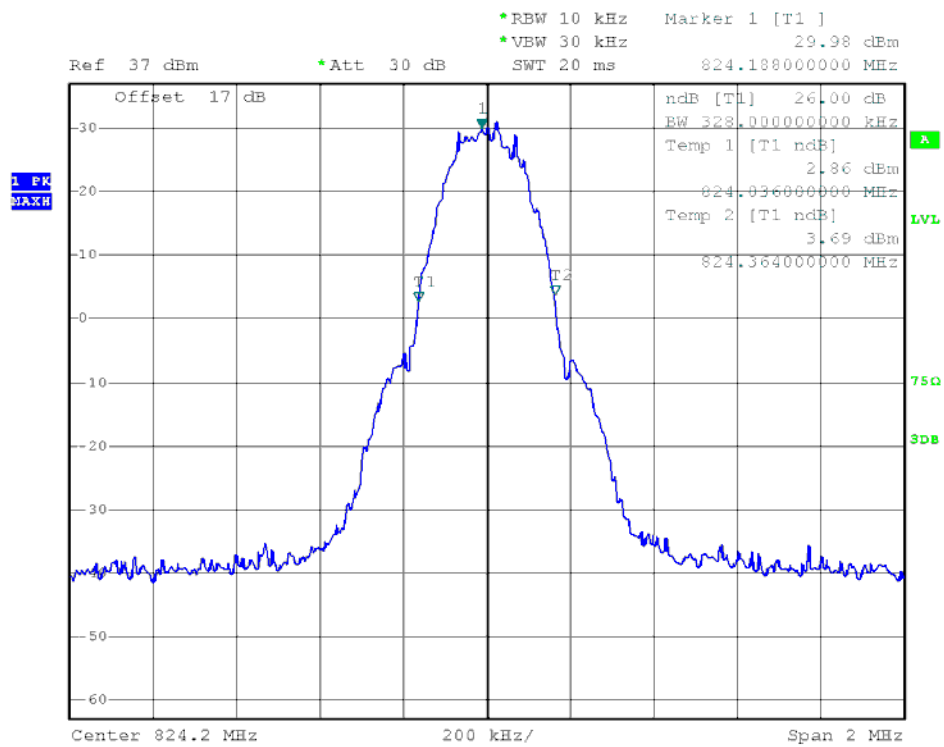

(Plot A1: GSM 850MHz Channel = 128)

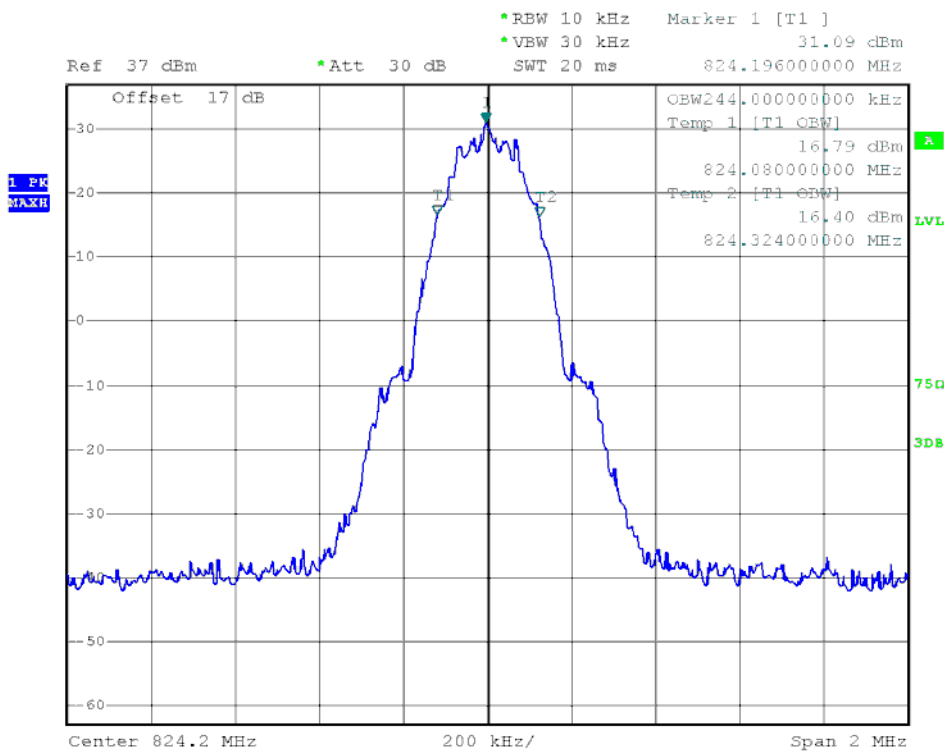

(Plot A2: GSM 850MHz Channel = 128)

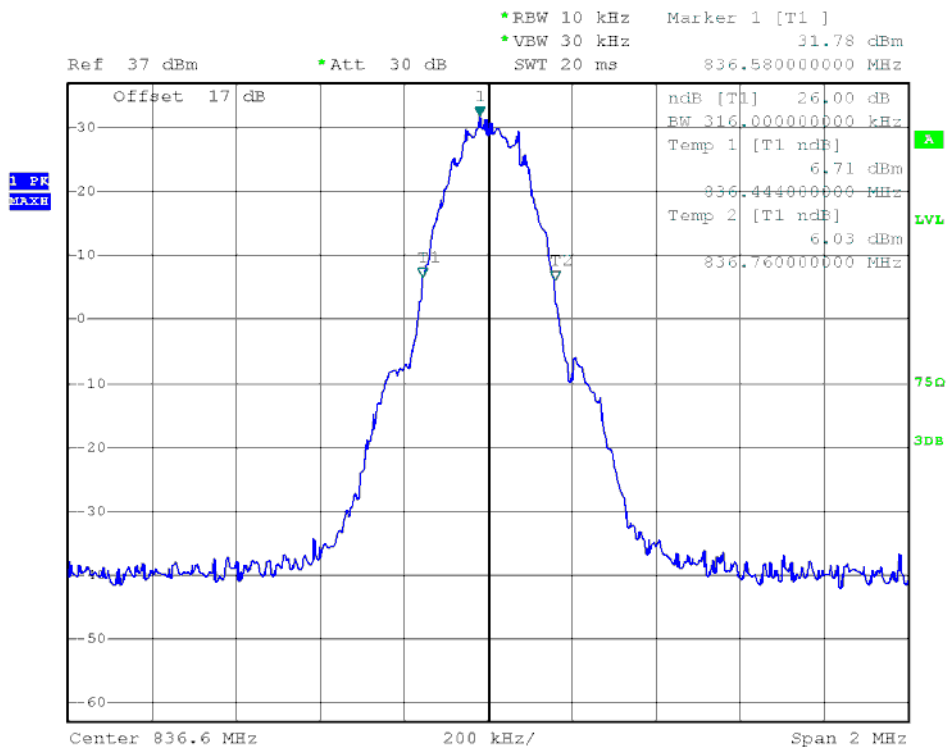

(Plot A3: GSM 850MHz Channel = 190)

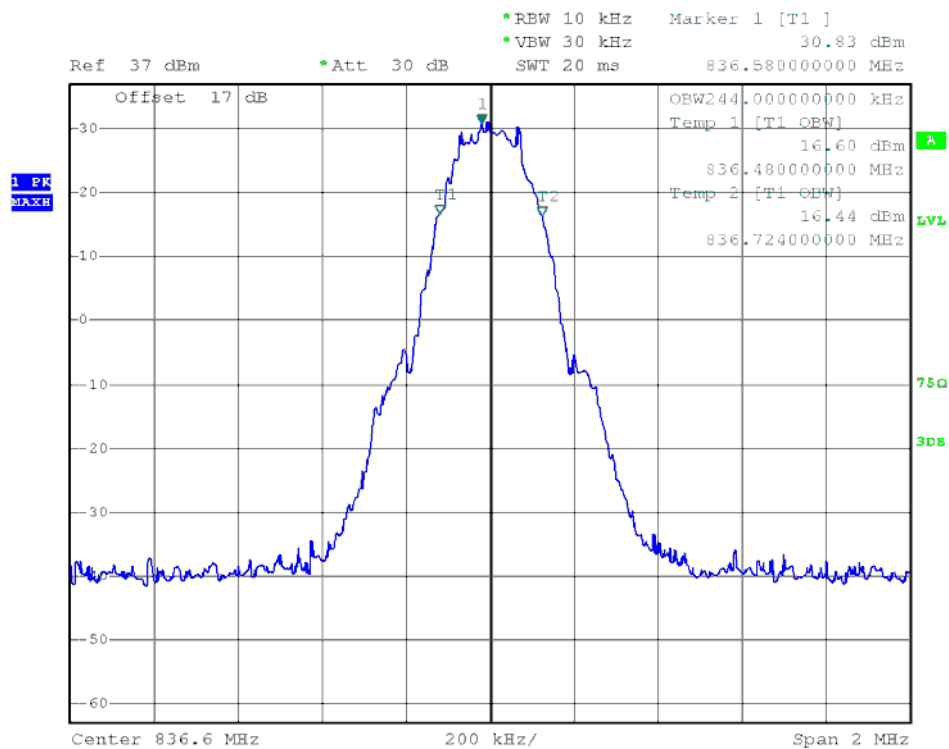

(Plot A4: GSM 850MHz Channel = 190)

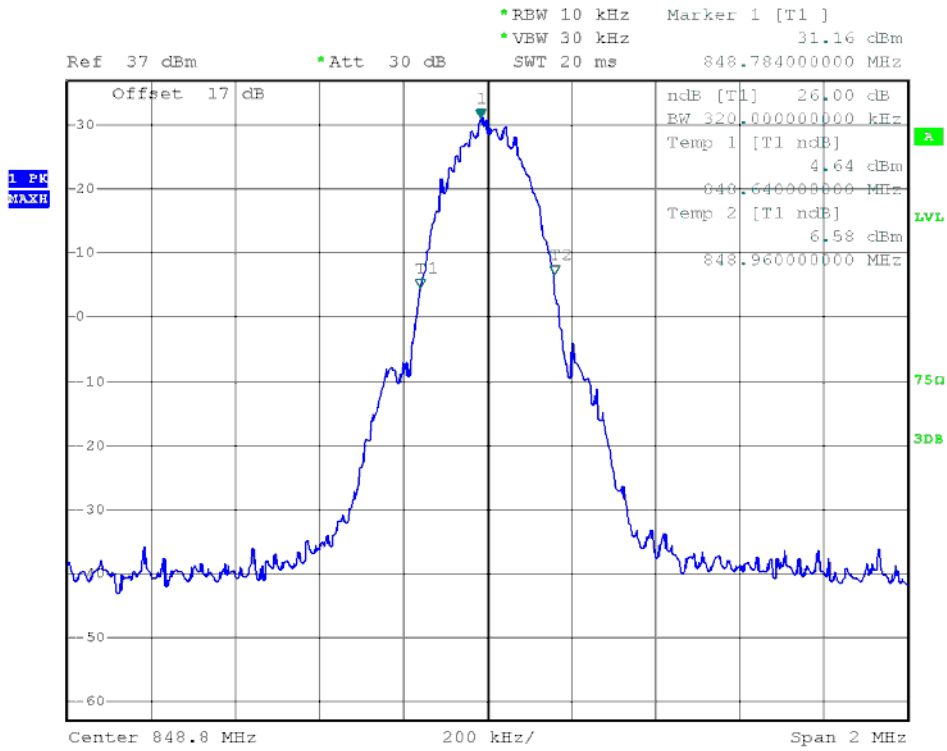

(Plot A5: GSM 850MHz Channel = 251)

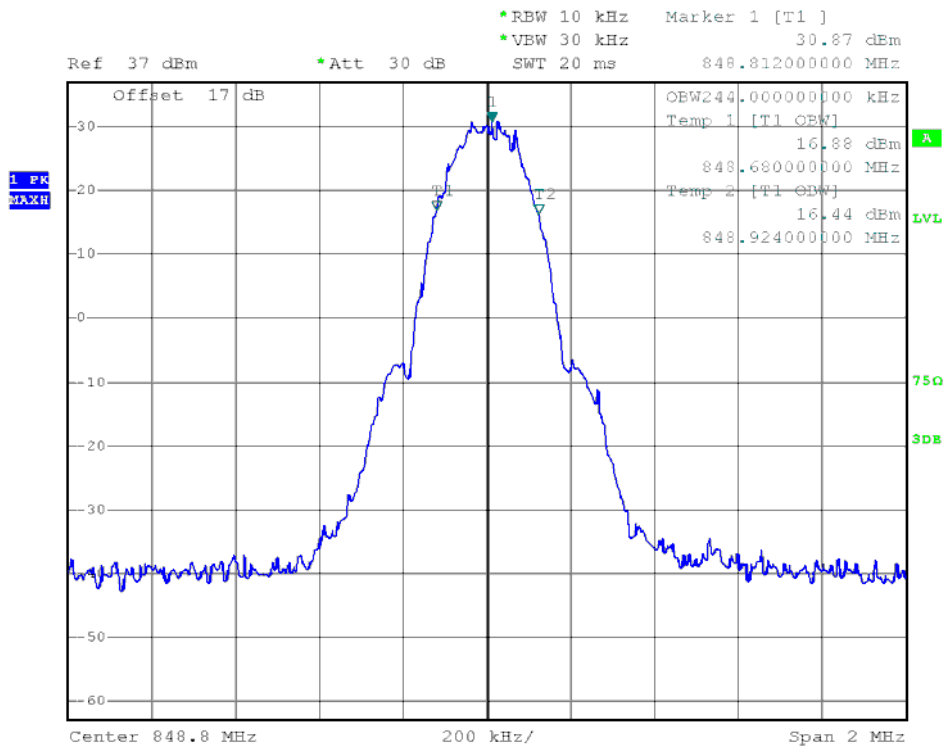

(Plot A6: GSM 850MHz Channel = 251)

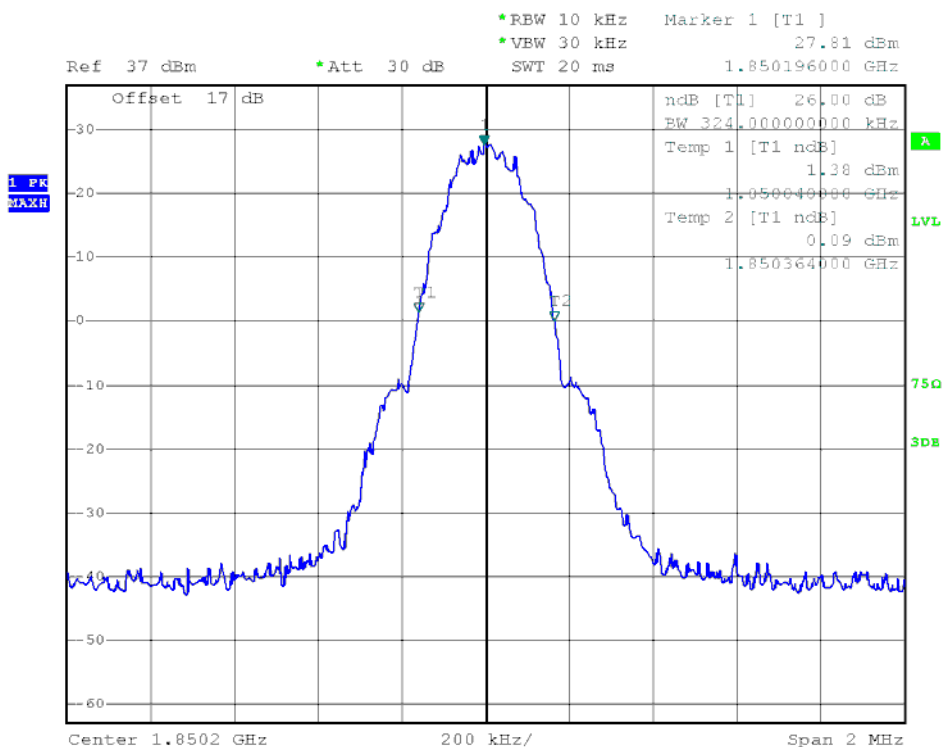

(Plot B1: GSM 1900MHz Channel = 512)

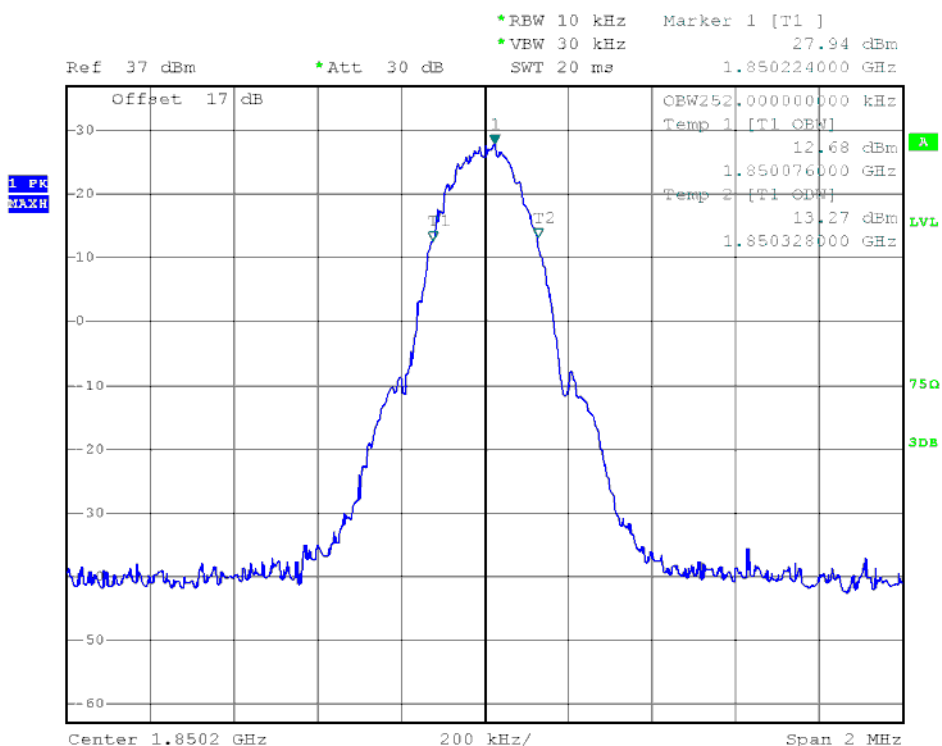

(Plot B2: GSM 1900MHz Channel = 512)

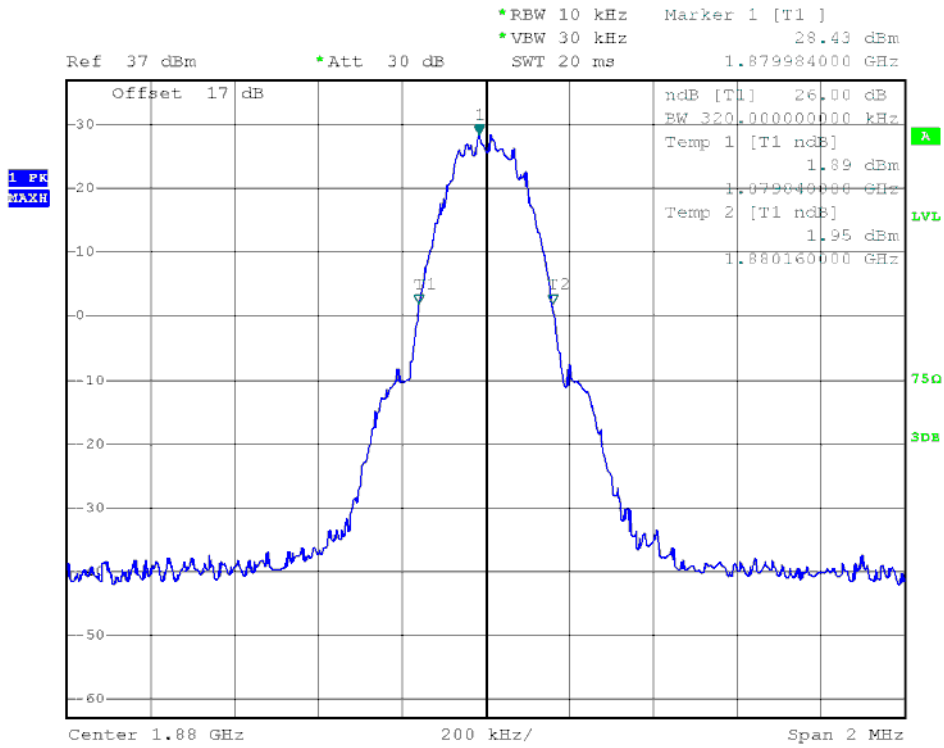

(Plot B3: GSM 1900MHz Channel = 661)

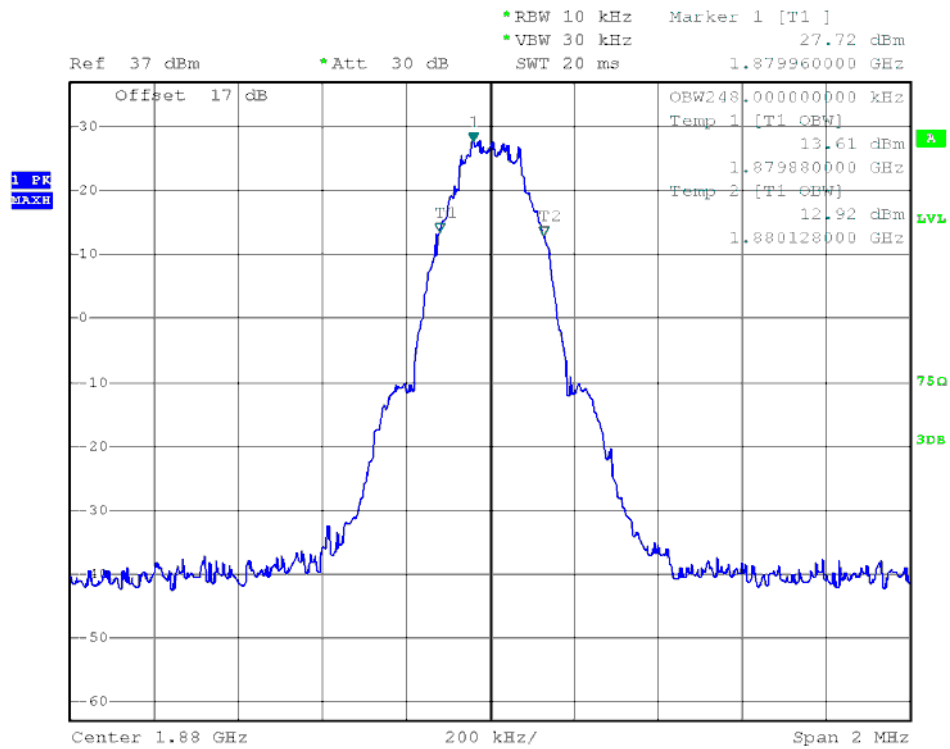

(Plot B4: GSM 1900MHz Channel = 661)

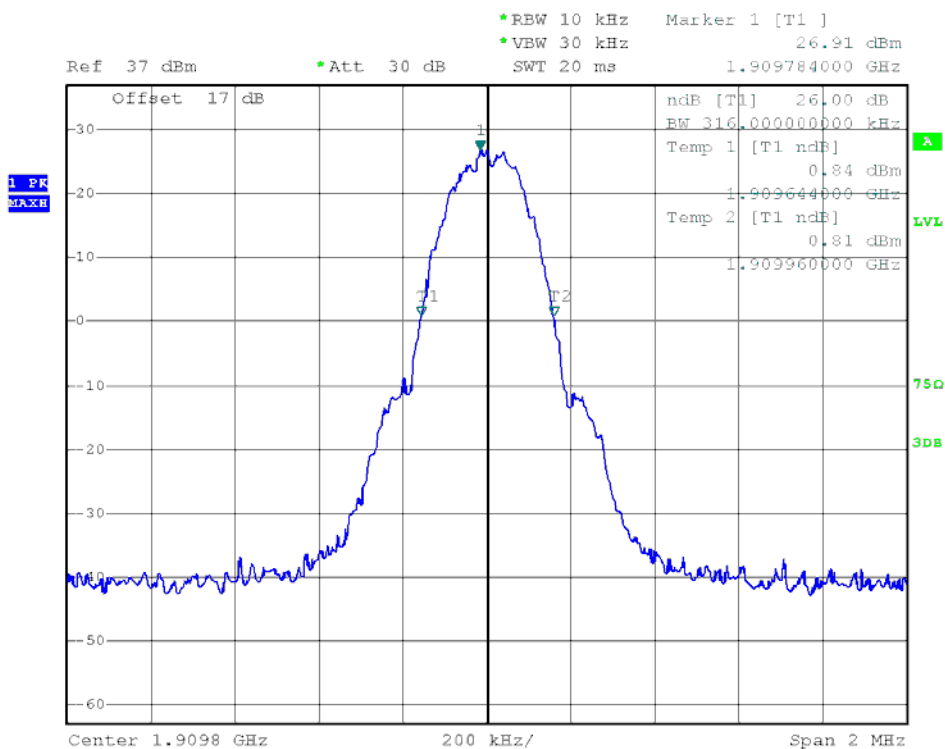

(Plot B5: GSM 1900MHz Channel = 810)

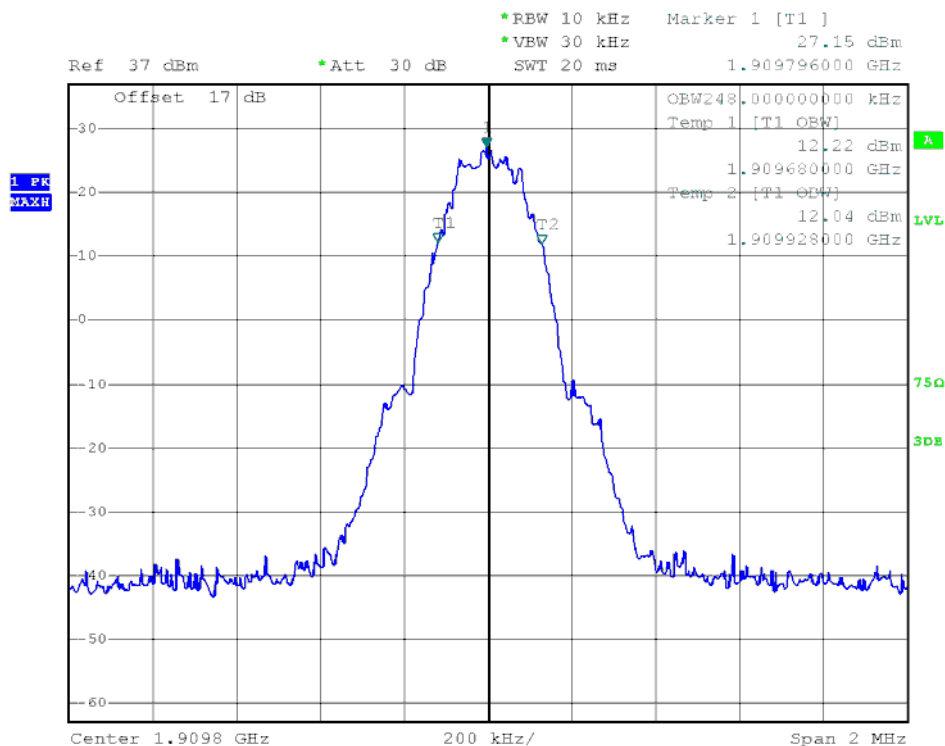

(Plot B6: GSM 1900MHz Channel = 810)

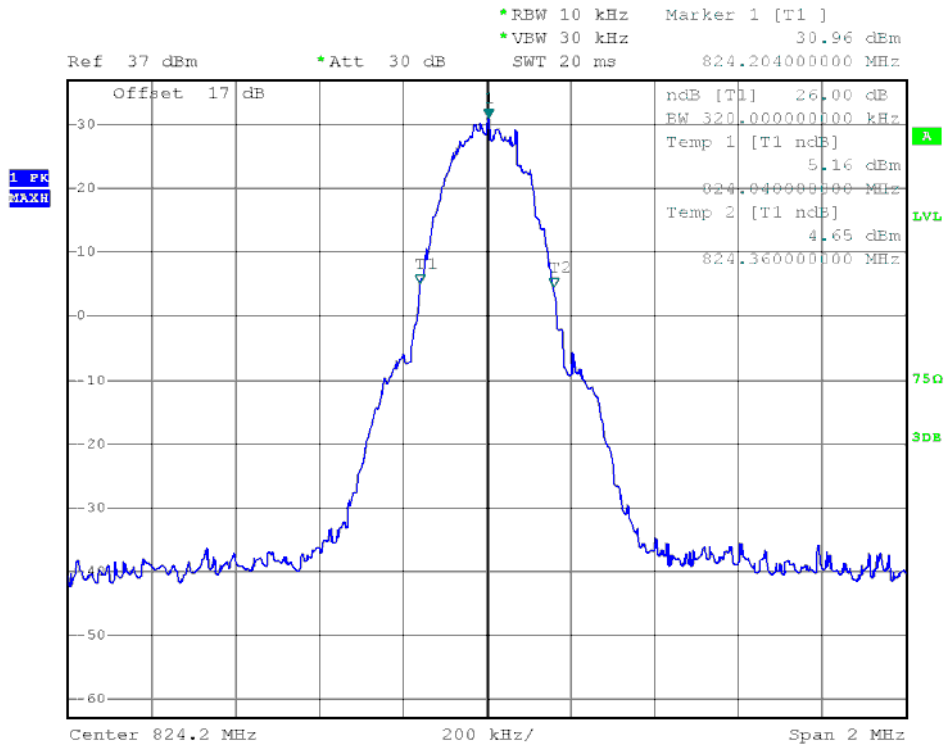

(Plot C1: GPRS 850MHz Channel = 128)

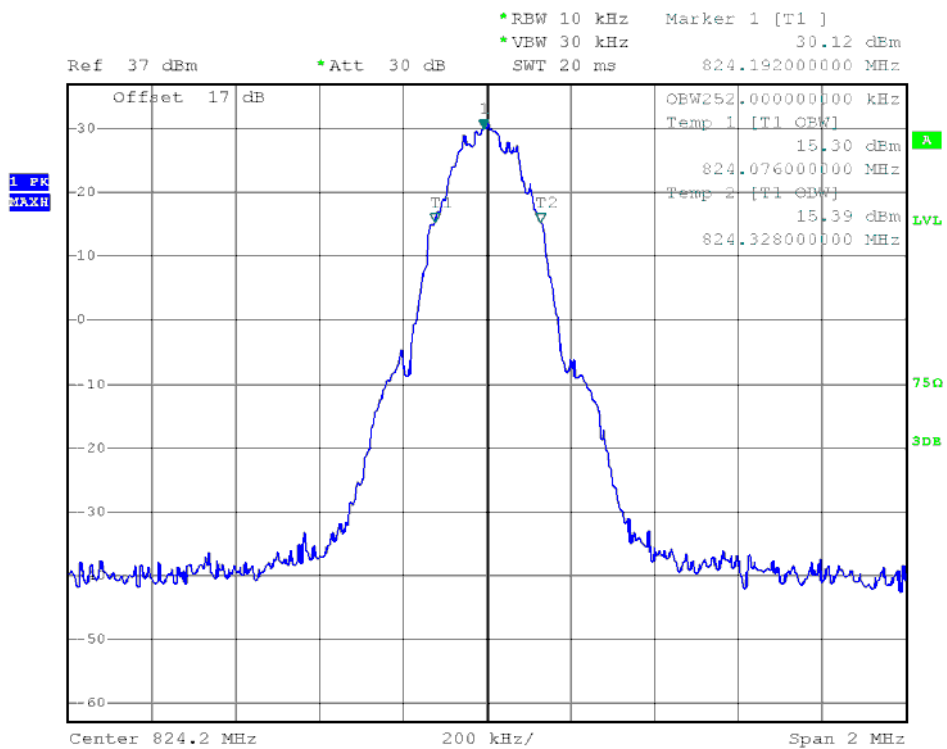

(Plot C2: GPRS 850MHz Channel = 128)

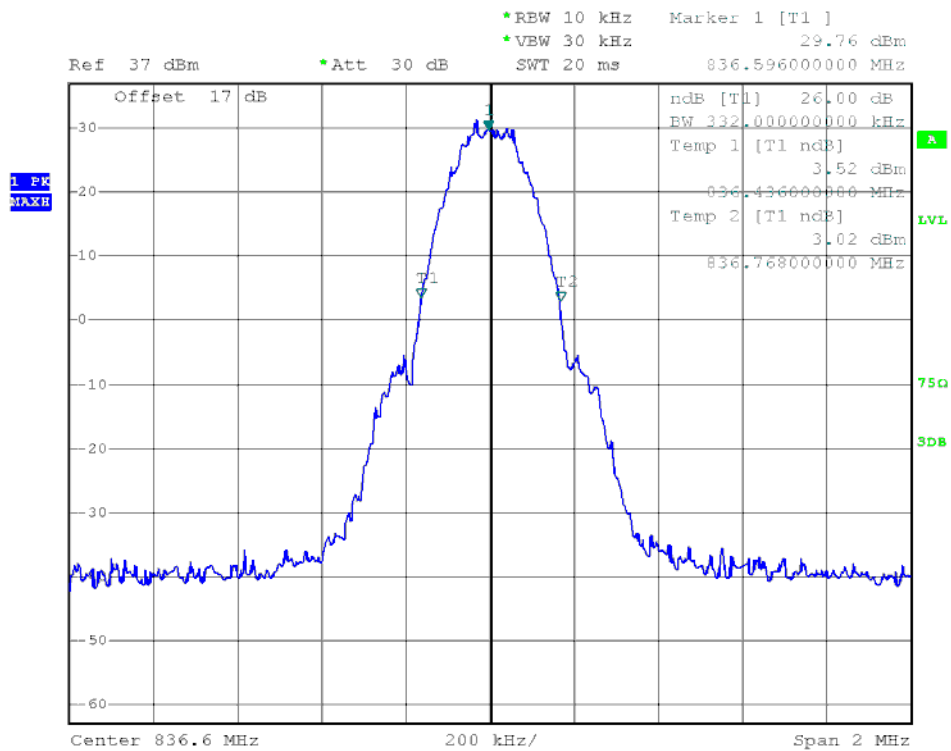

(Plot C3: GPRS 850MHz Channel = 190)

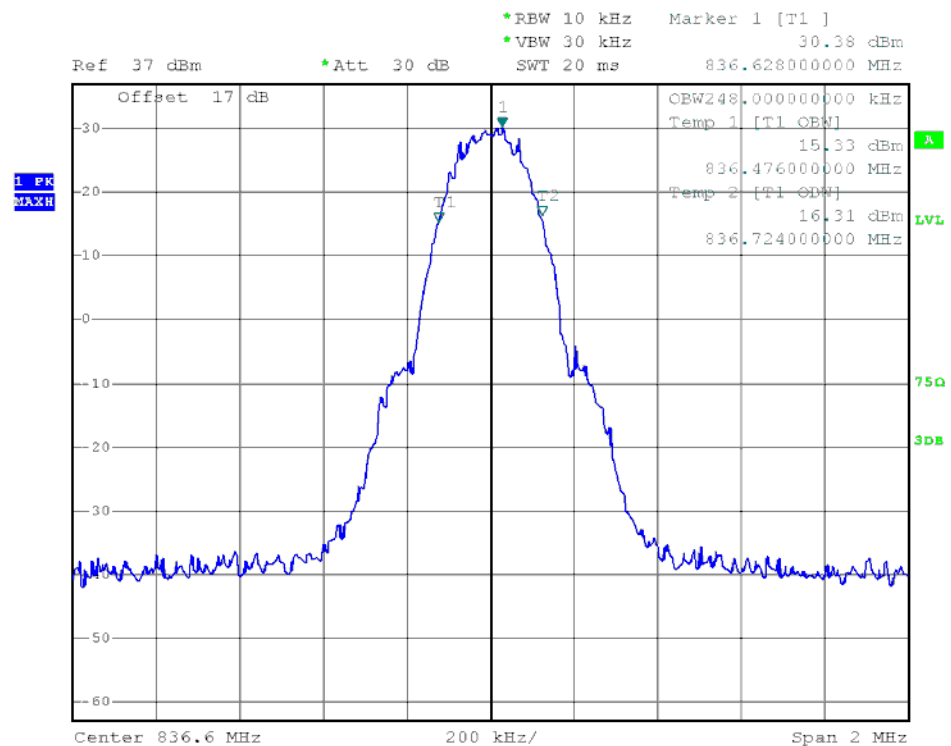

(Plot C4: GPRS 850MHz Channel = 190)

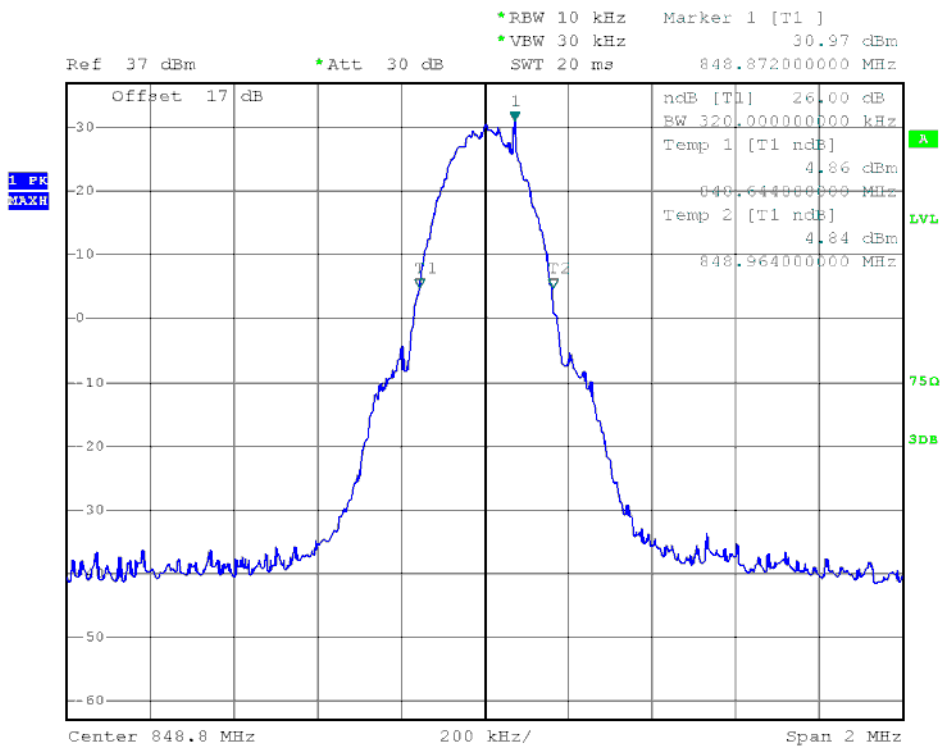

(Plot C5: GPRS 850MHz Channel = 251)

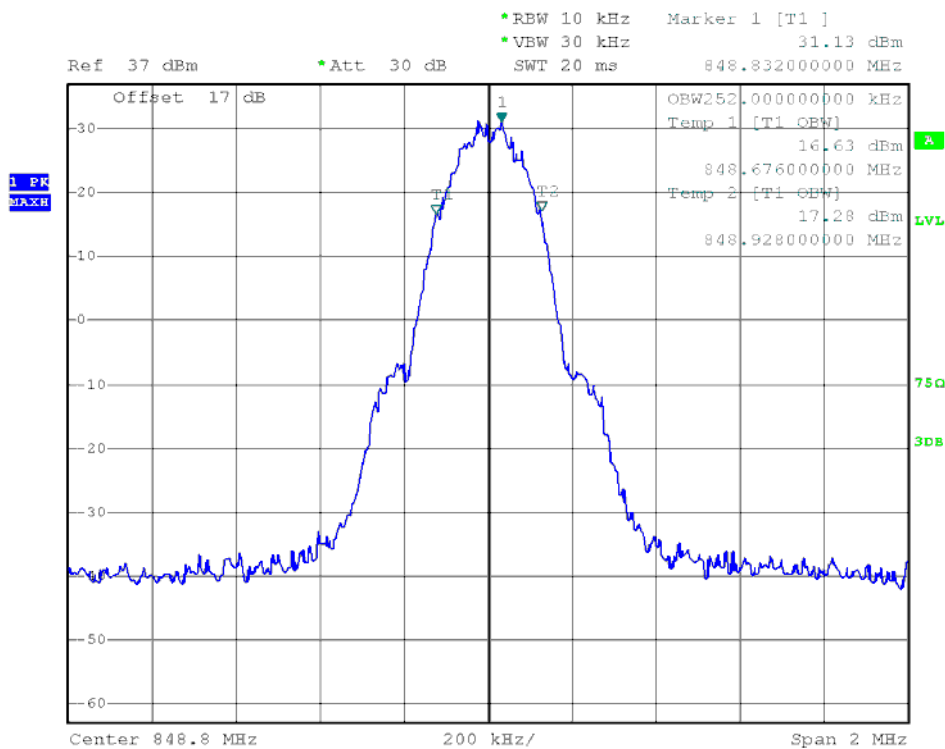

(Plot C6: GPRS 850MHz Channel = 251)

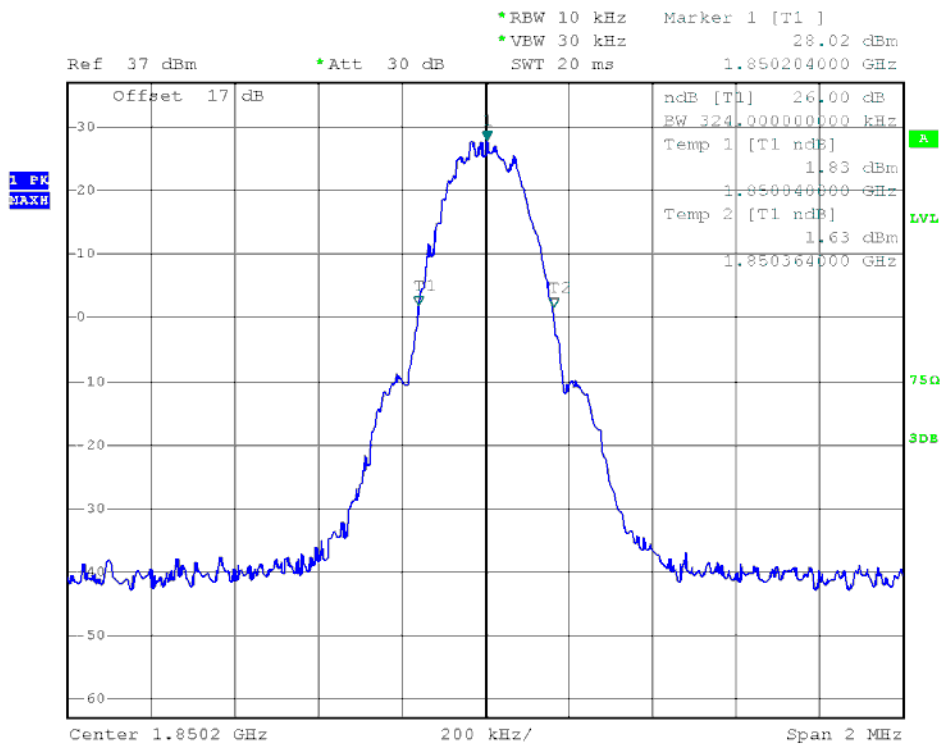

(Plot D1: GPRS 1900MHz Channel = 512)

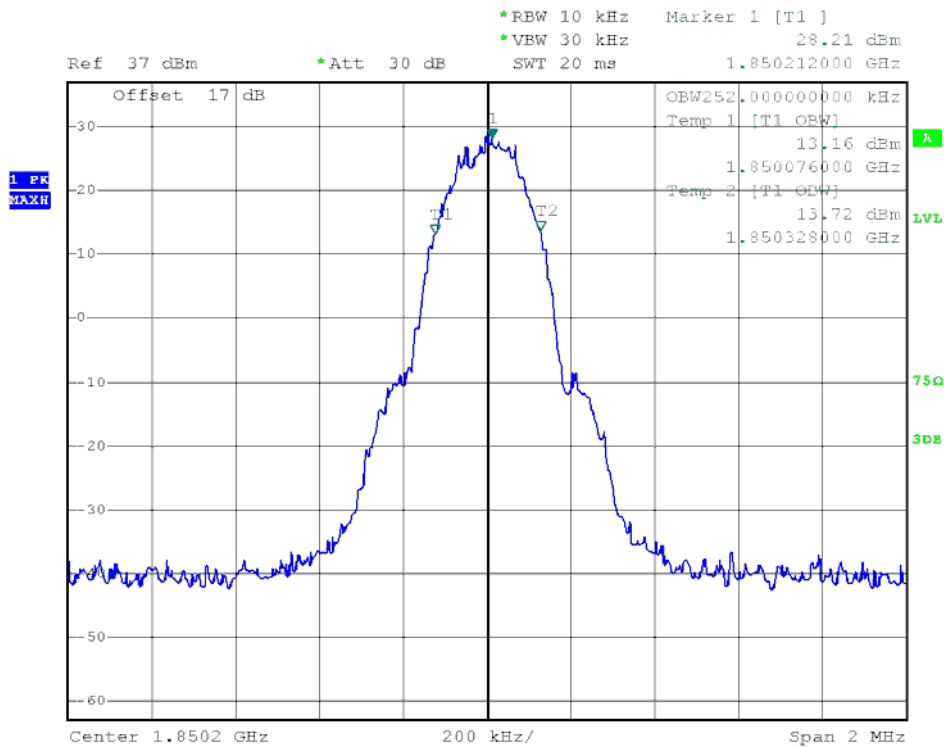

(Plot D2: GPRS 1900MHz Channel = 512)

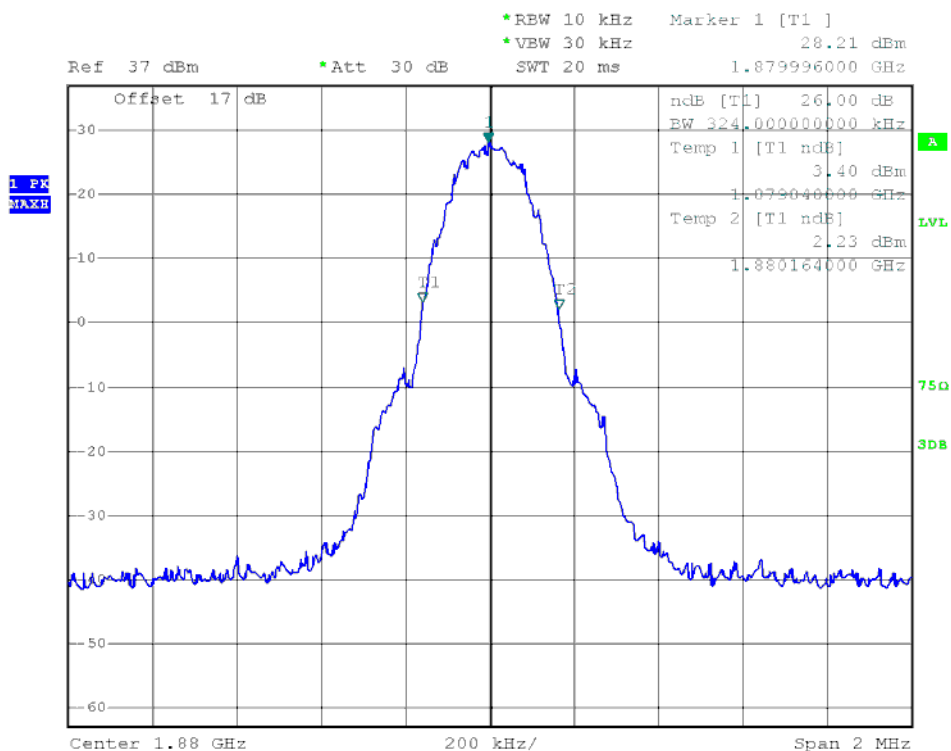

(Plot D3: GPRS 1900MHz Channel = 661)

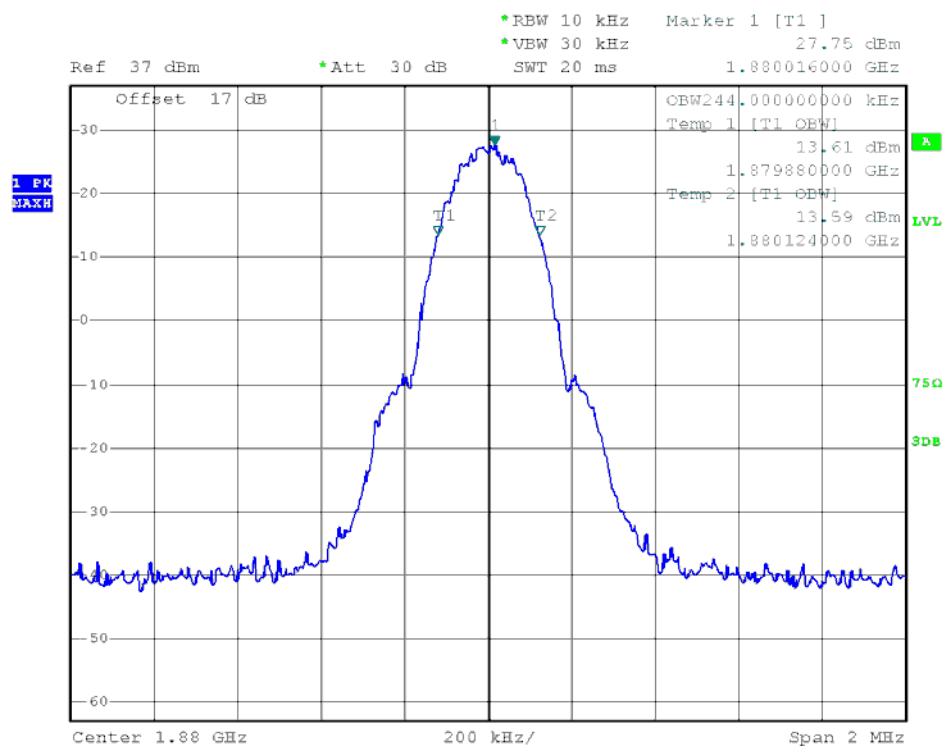

(Plot D4: GPRS 1900MHz Channel = 661)

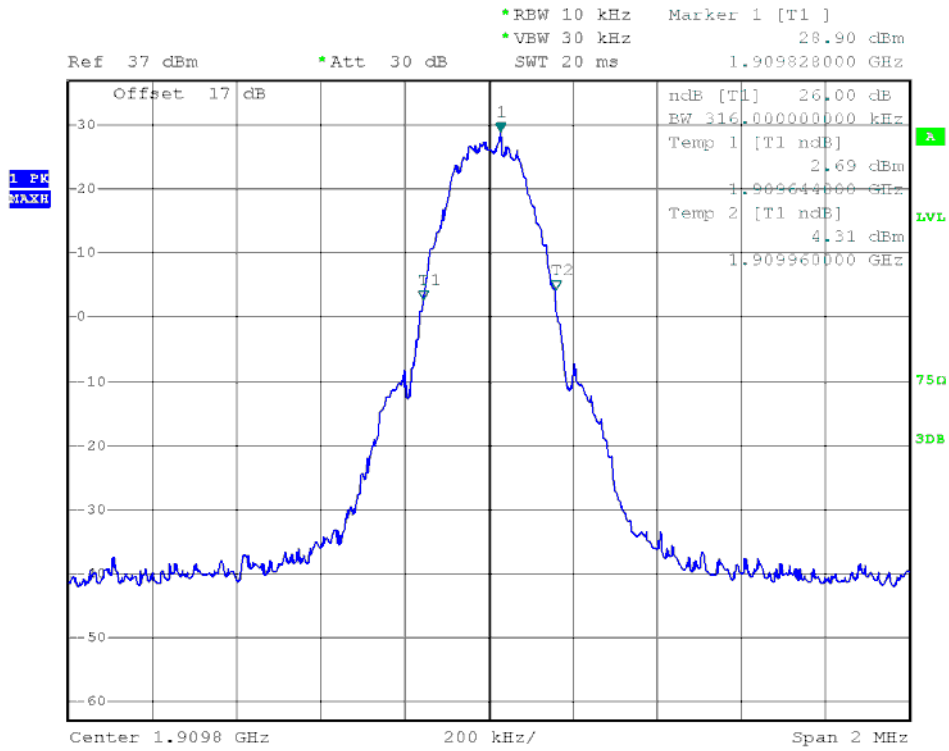

(Plot D5: GPRS 1900MHz Channel = 810)

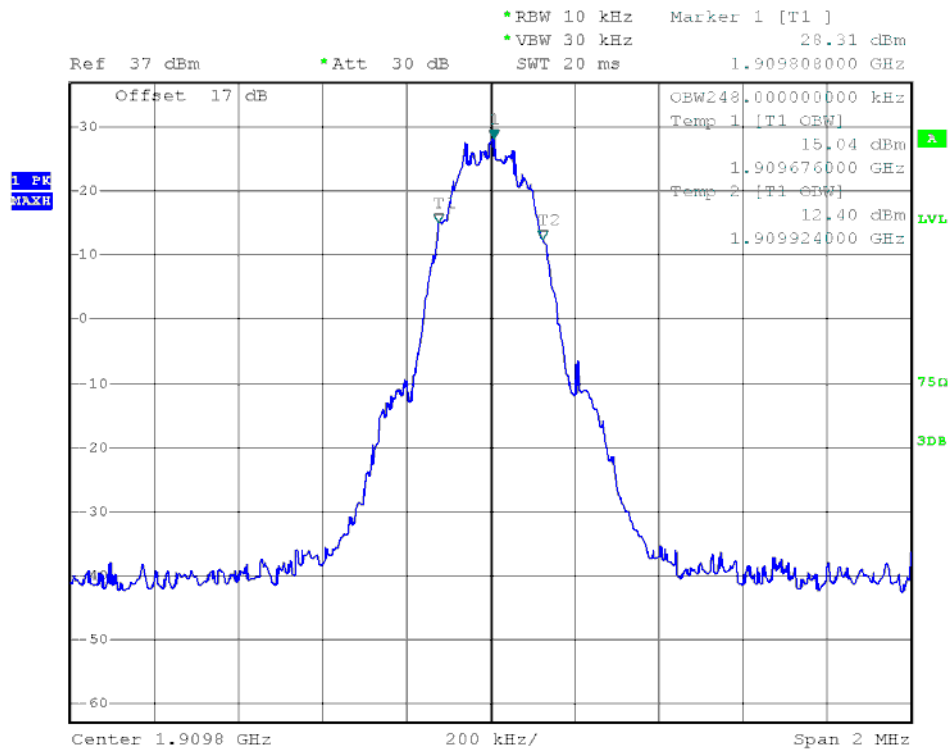

(Plot D6: GPRS 1900MHz Channel = 810)

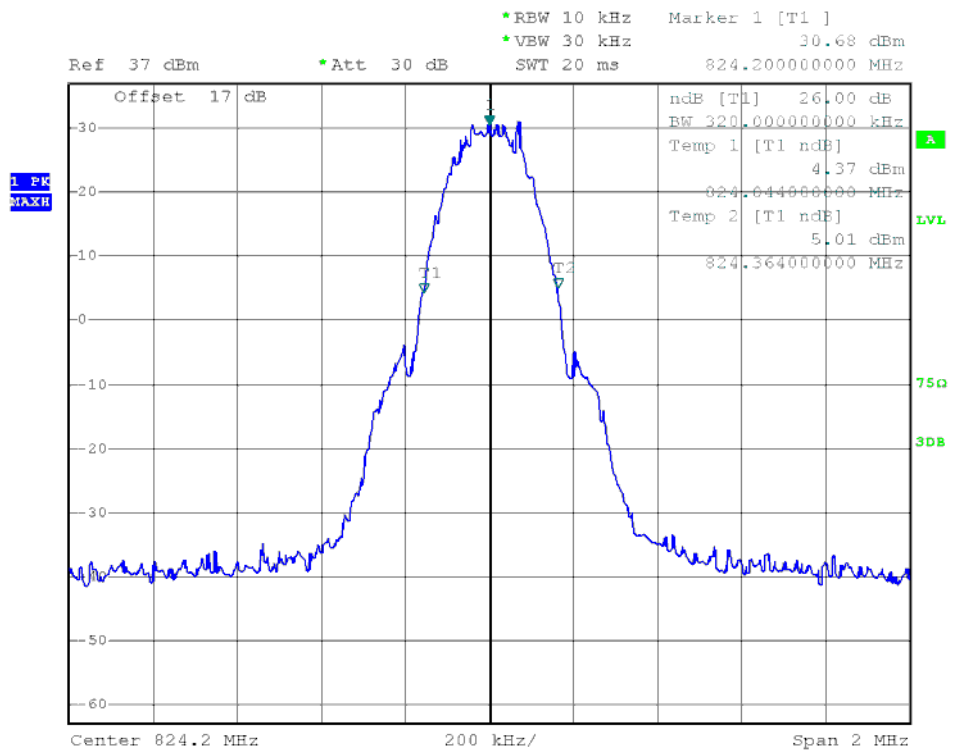

(Plot E1: EDGE 850MHz Channel = 128)

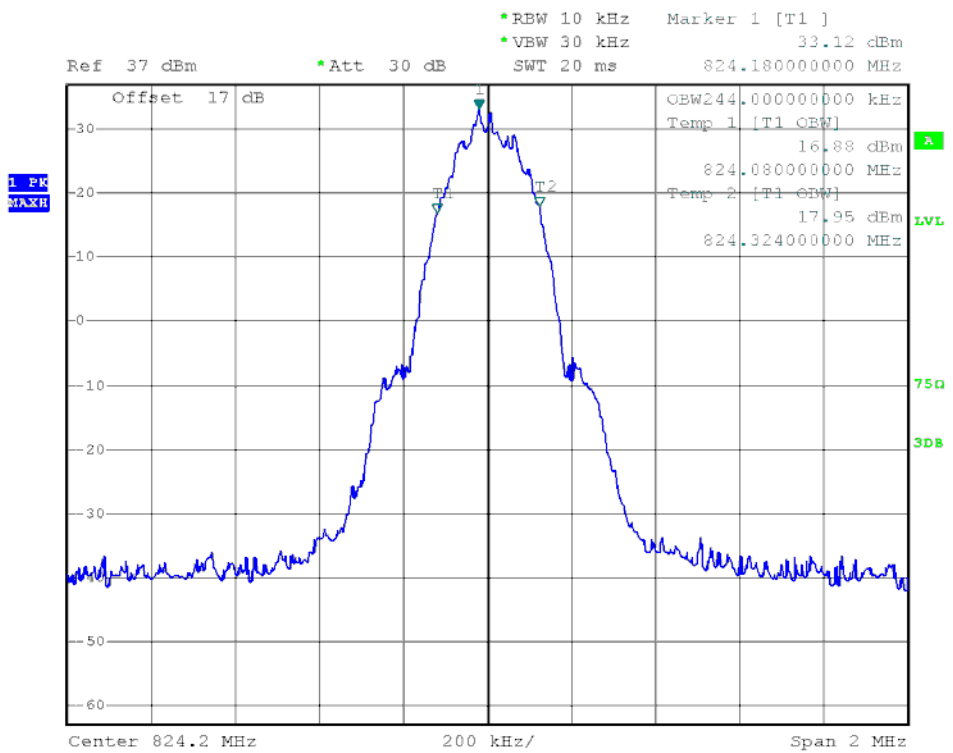

(Plot E2: EDGE 850MHz Channel = 128)

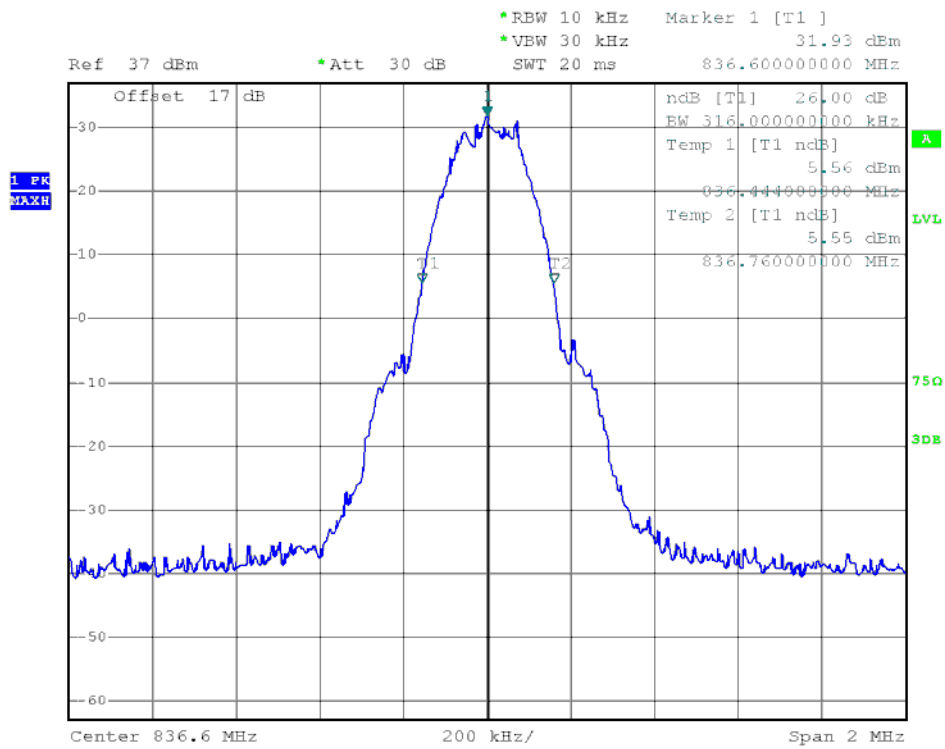

(Plot E3: EDGE 850MHz Channel = 190)

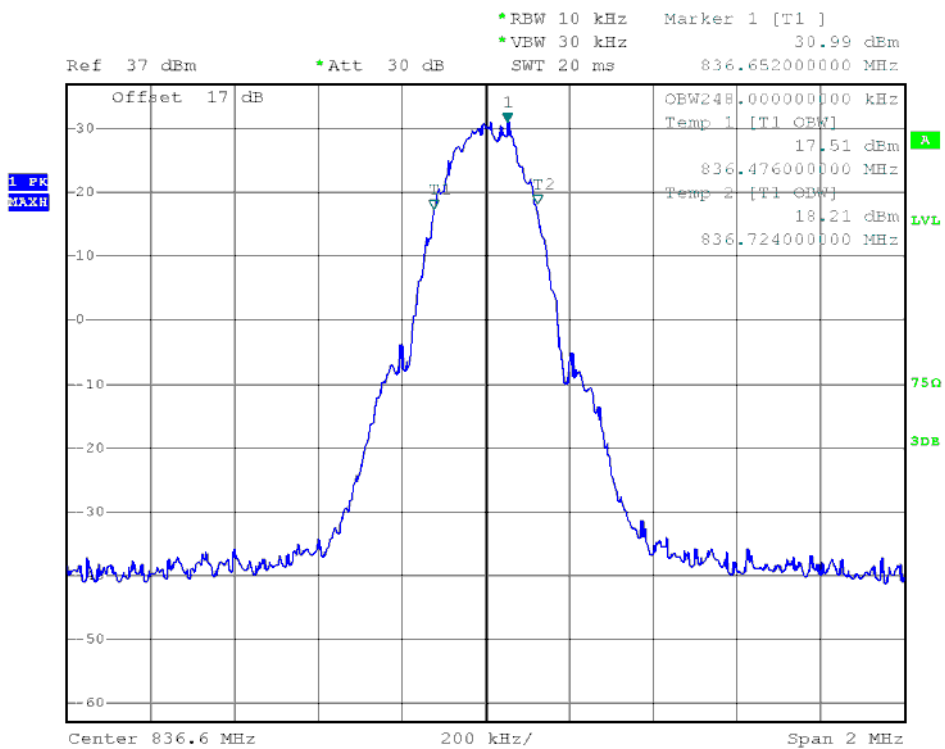

(Plot E4: EDGE 850MHz Channel = 190)

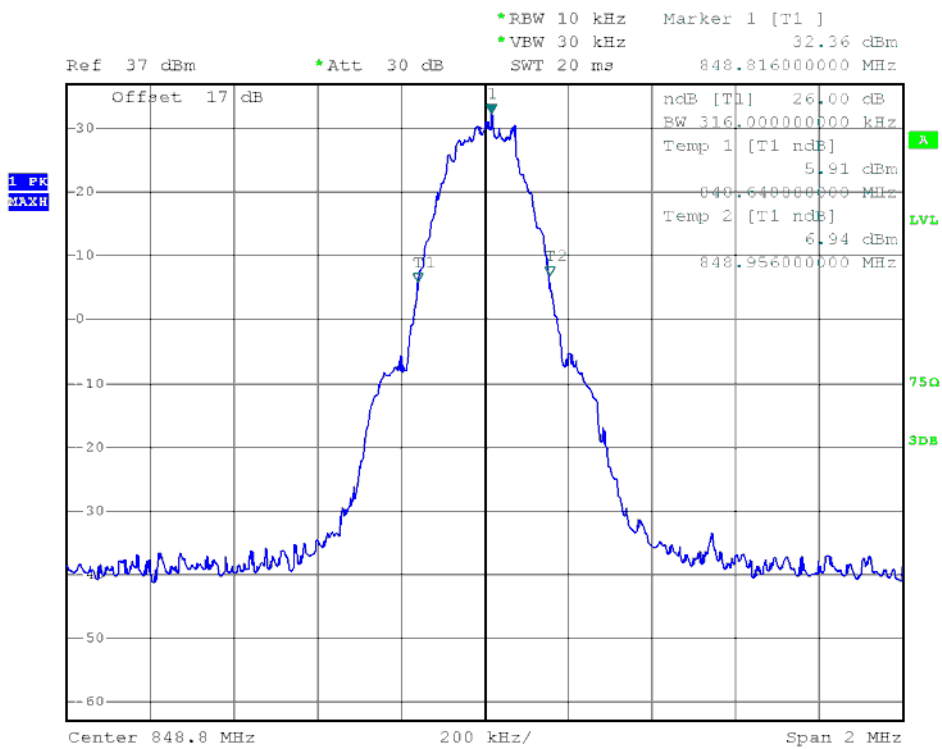

(Plot E5: EDGE 850MHz Channel = 251)

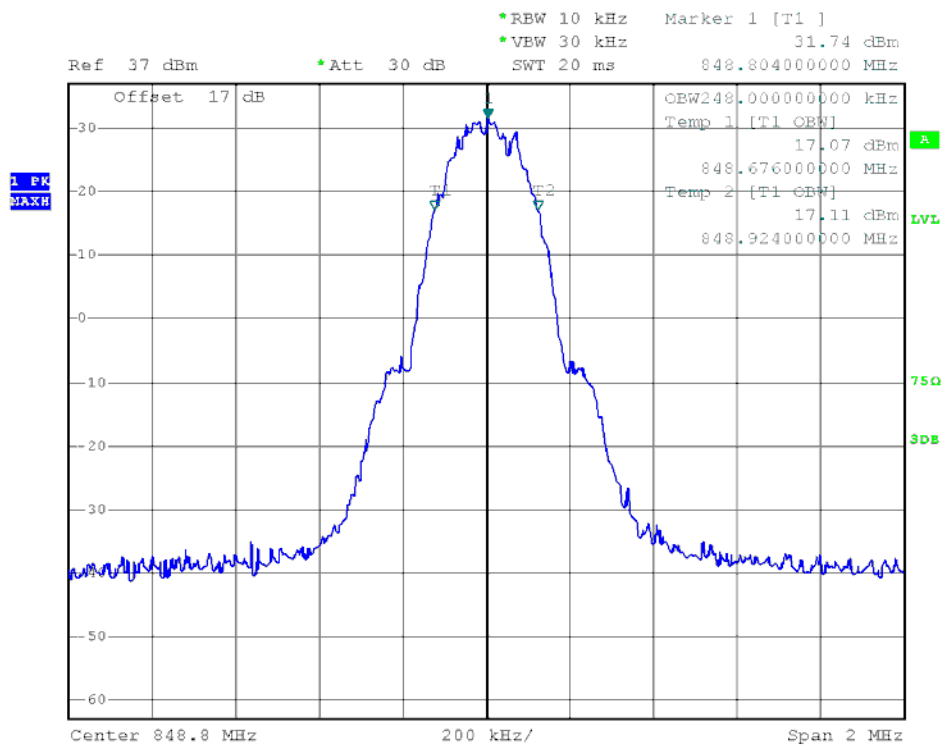

(Plot E6: EDGE 850MHz Channel = 251)

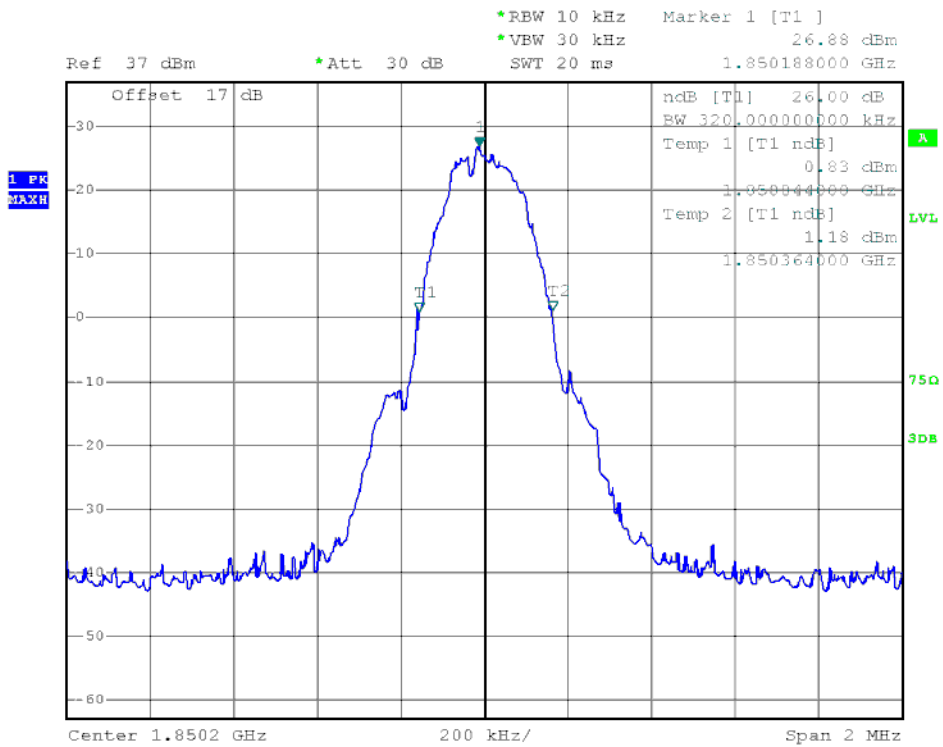

(Plot F1: EDGE 1900MHz Channel = 512)

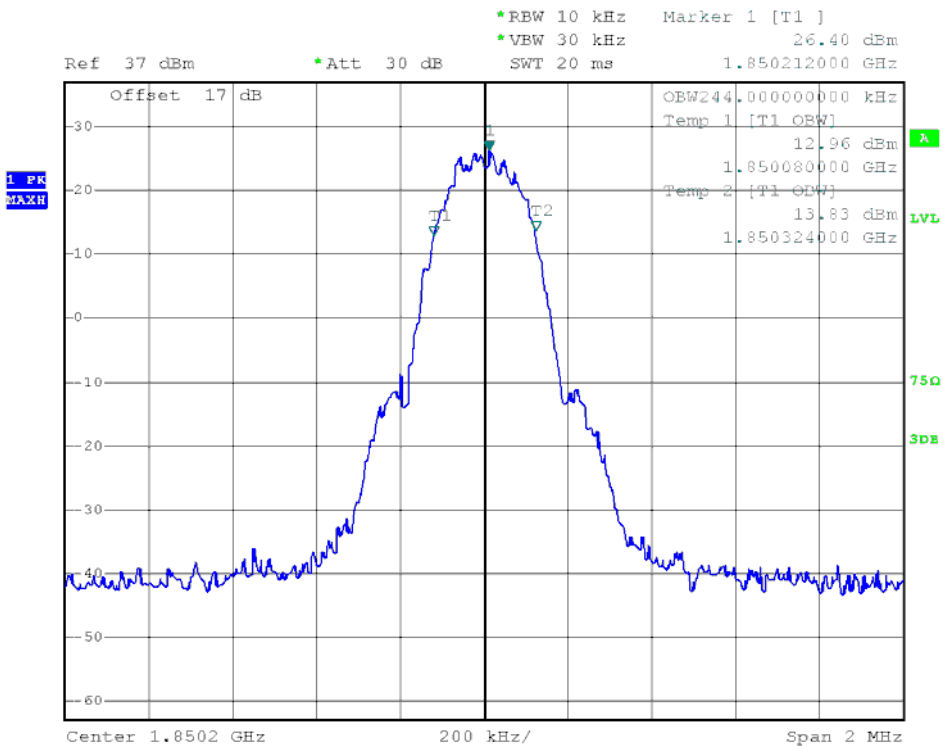

(Plot F2: EDGE 1900MHz Channel = 512)

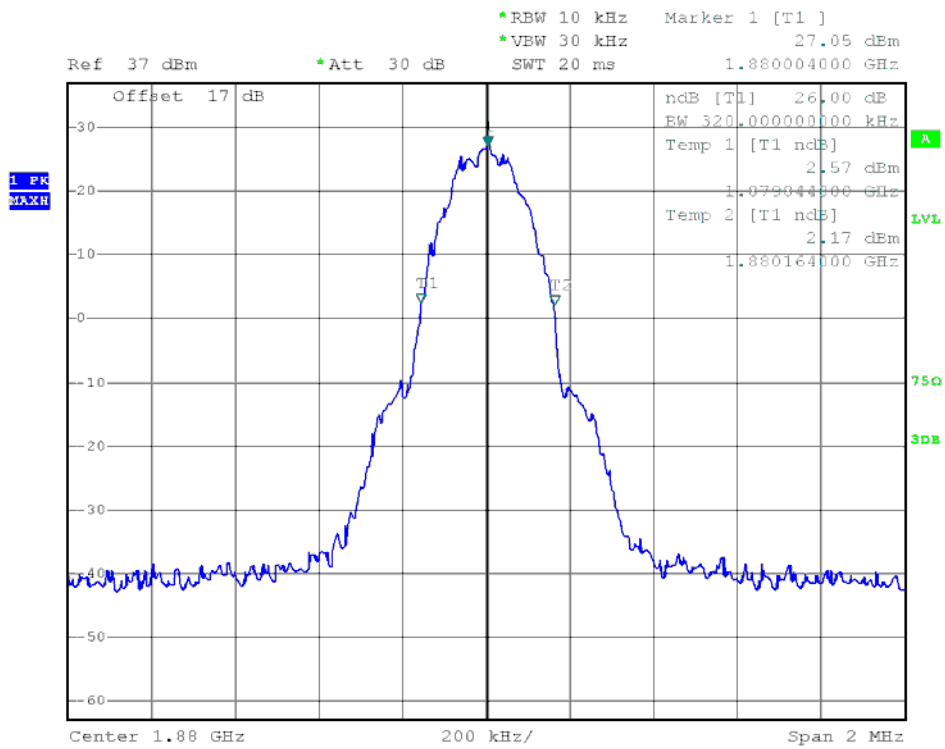

(Plot F3: EDGE 1900MHz Channel = 661)

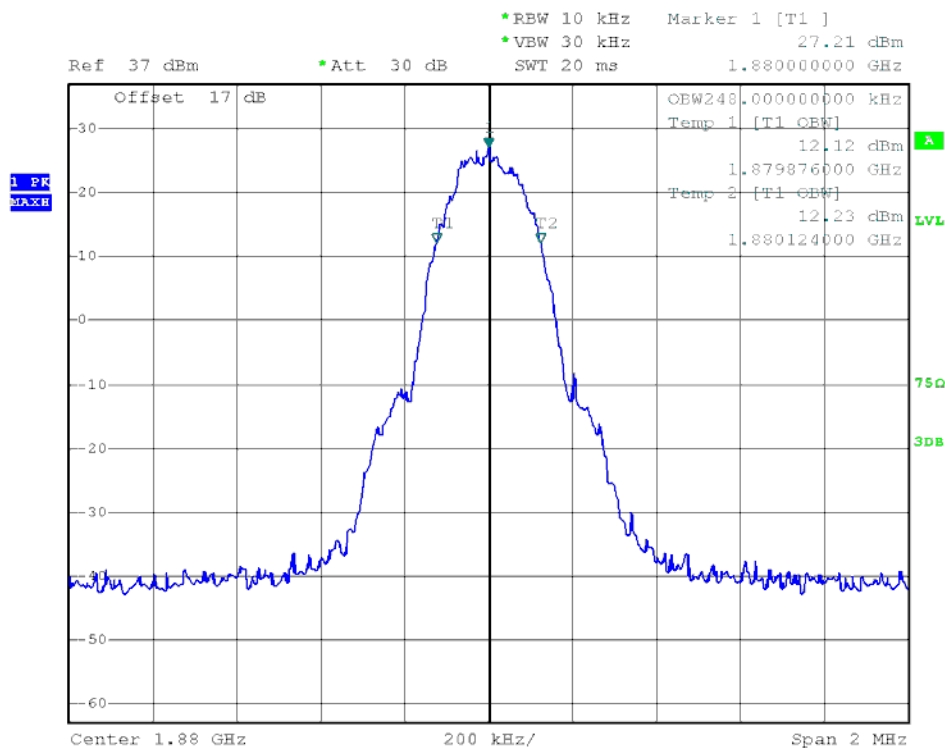

(Plot F4: EDGE 1900MHz Channel = 661)

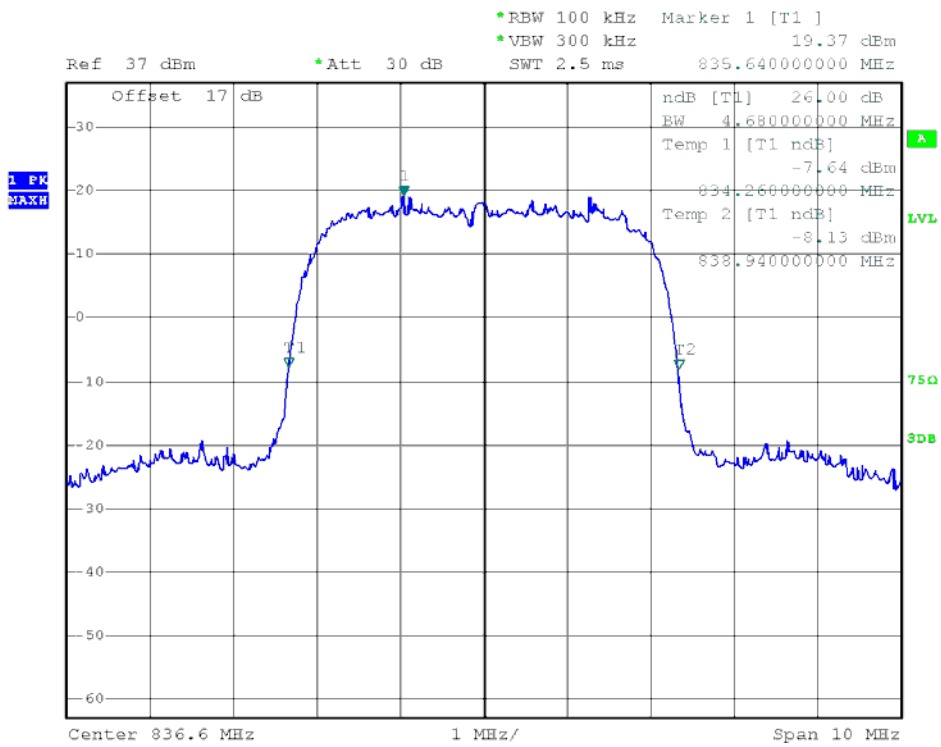

(Plot G3: WCDMA 850 MHz Channel = 4183)

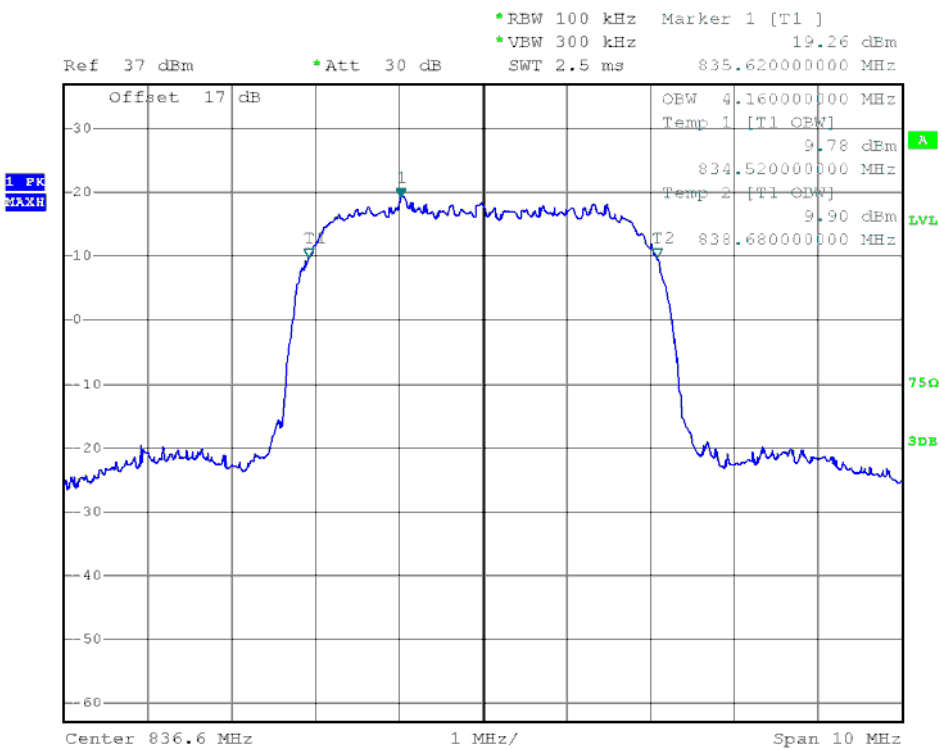

(Plot G4: WCDMA 850 MHz Channel = 4183)

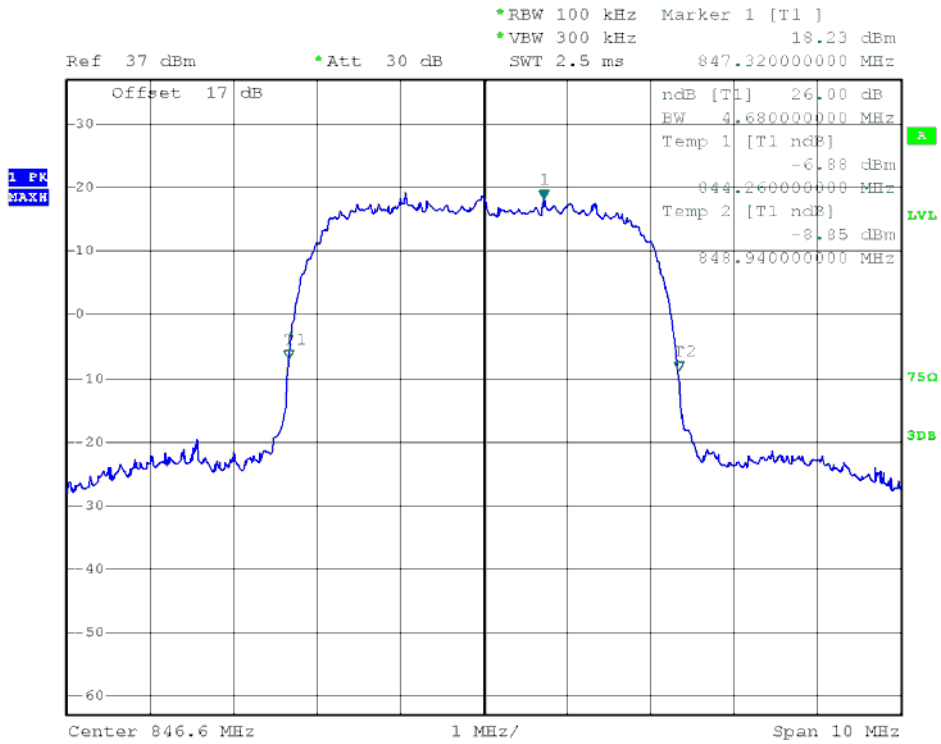

(Plot G5: WCDMA 850MHz Channel = 4233)

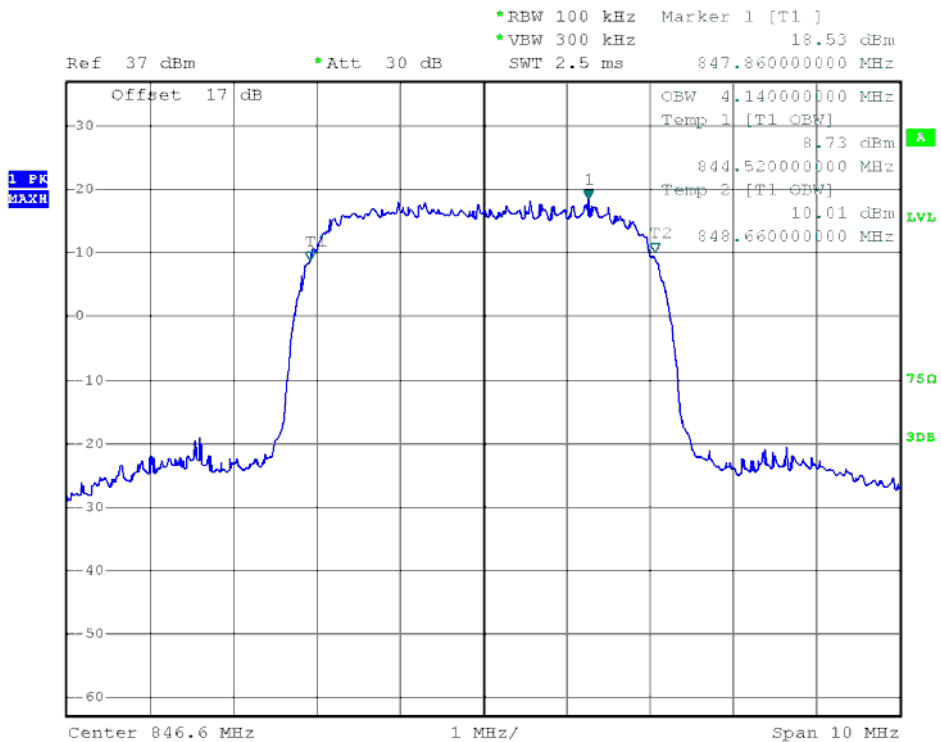

(Plot G6: WCDMA 850MHz Channel = 4233)

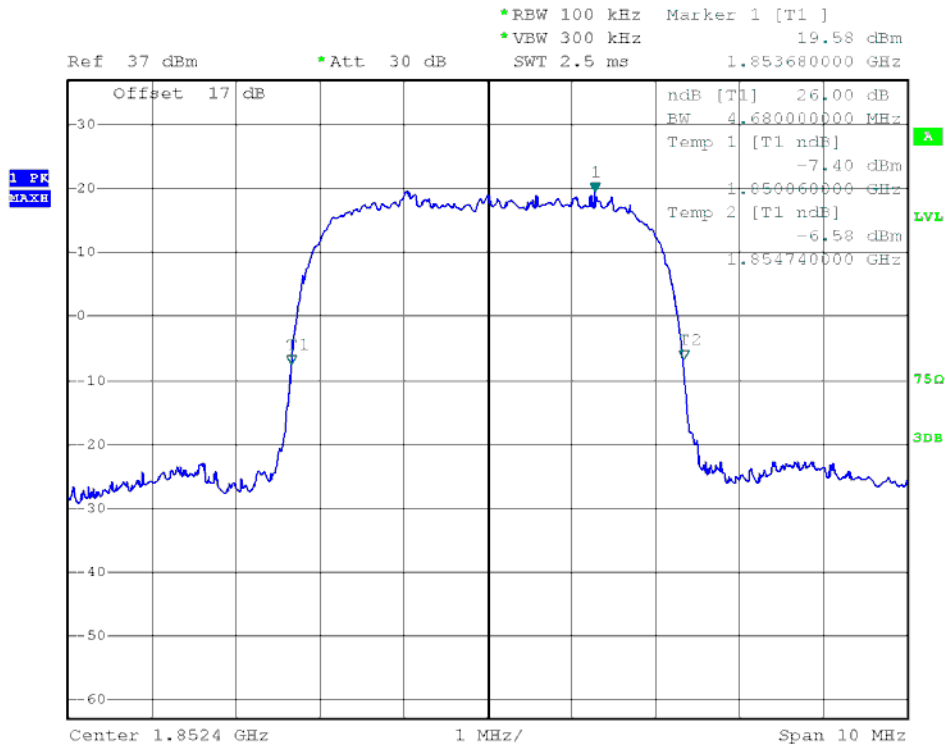

(Plot H1: WCDMA 1900MHz Channel = 9262)

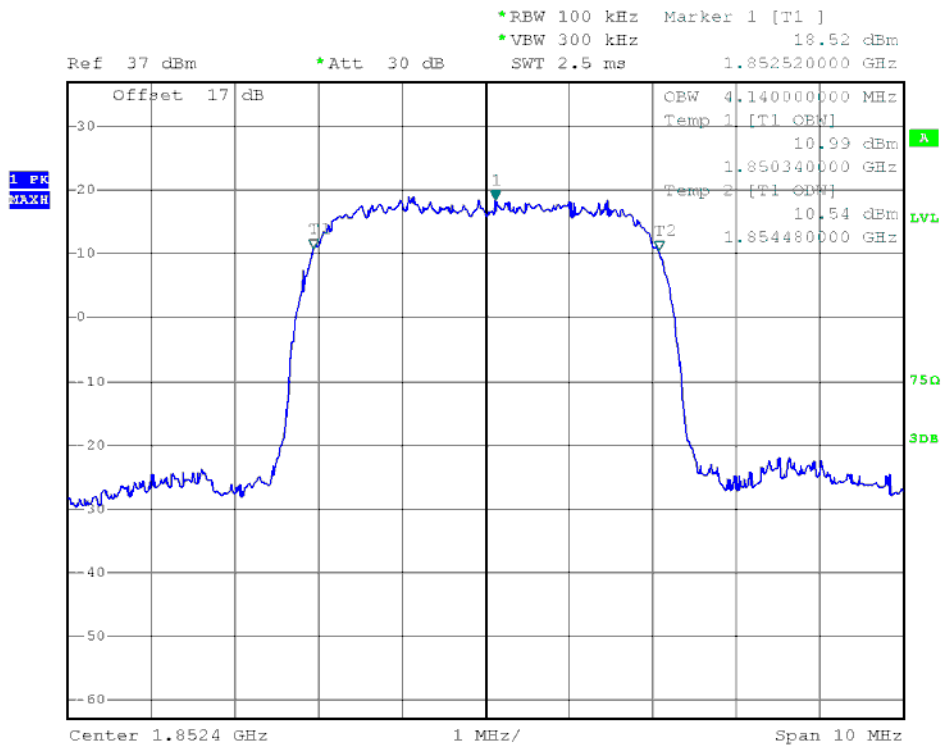

(Plot H2: WCDMA 1900MHz Channel = 9262)

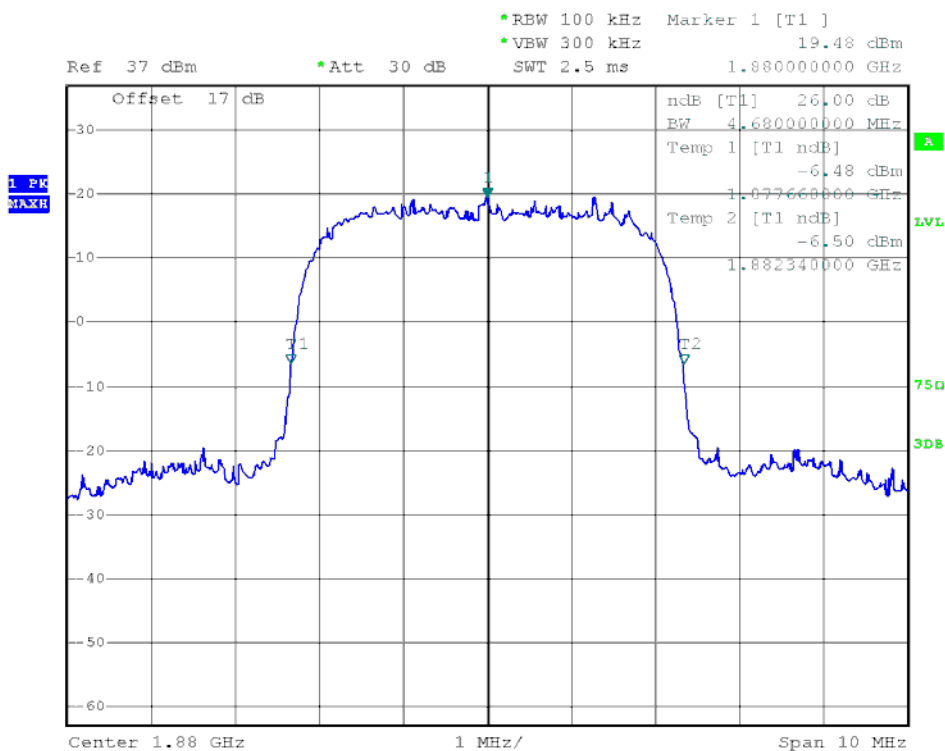

(Plot H3: WCDMA 1900 MHz Channel = 9400)

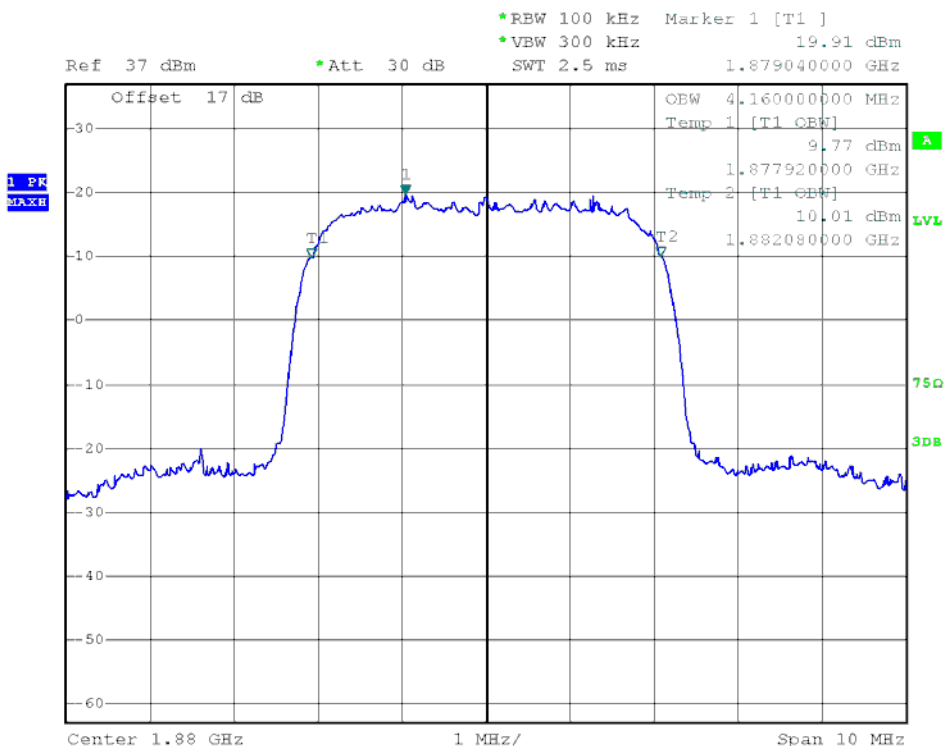

(Plot H4: WCDMA 1900 MHz Channel = 9400)

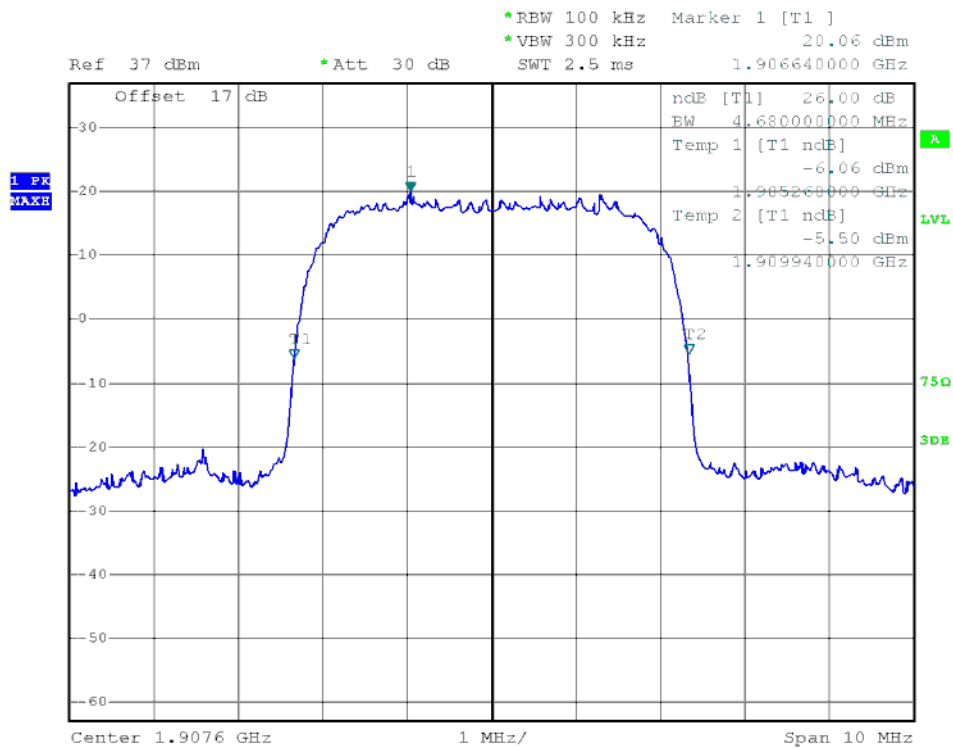

(Plot H5: WCDMA1900MHz Channel = 9538)

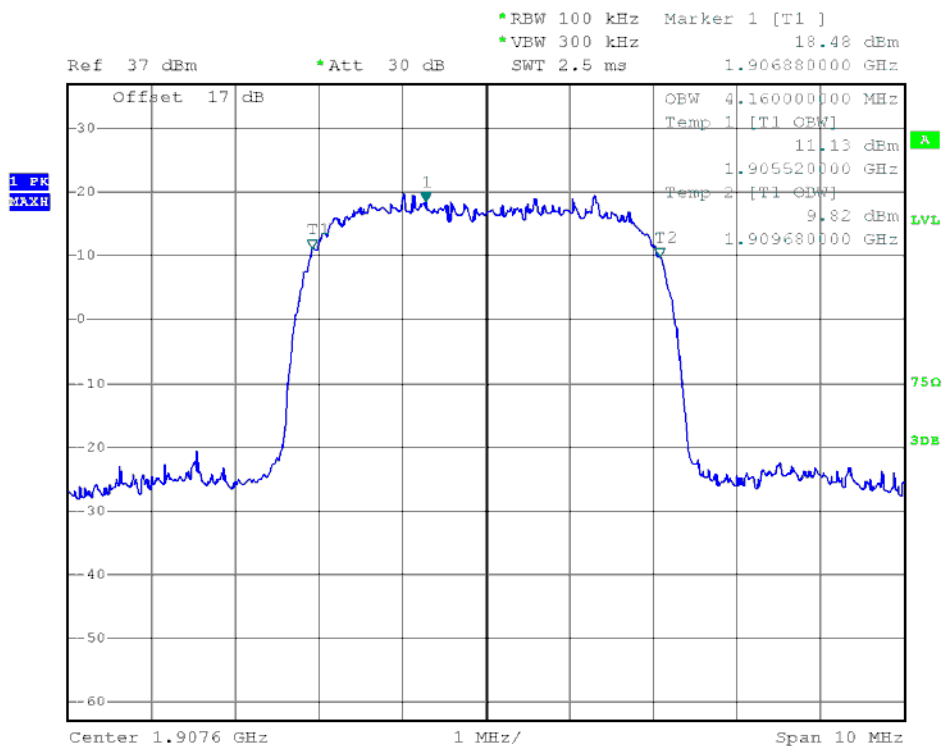

(Plot H6: WCDMA1900MHz Channel = 9538)

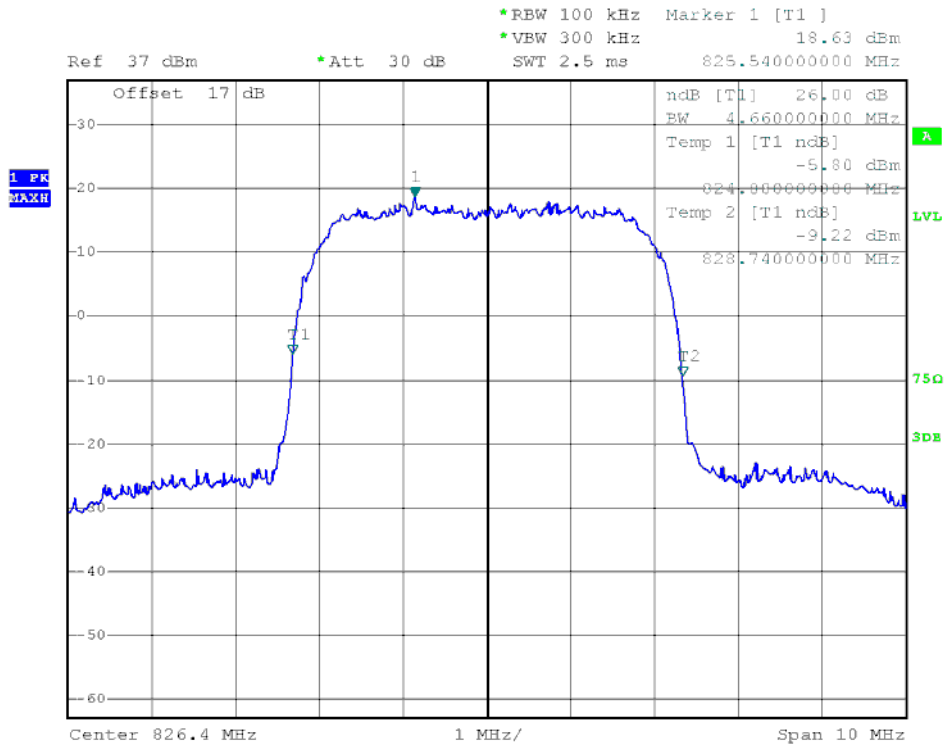

(Plot I1: HSDPA 850MHz Channel = 4132)

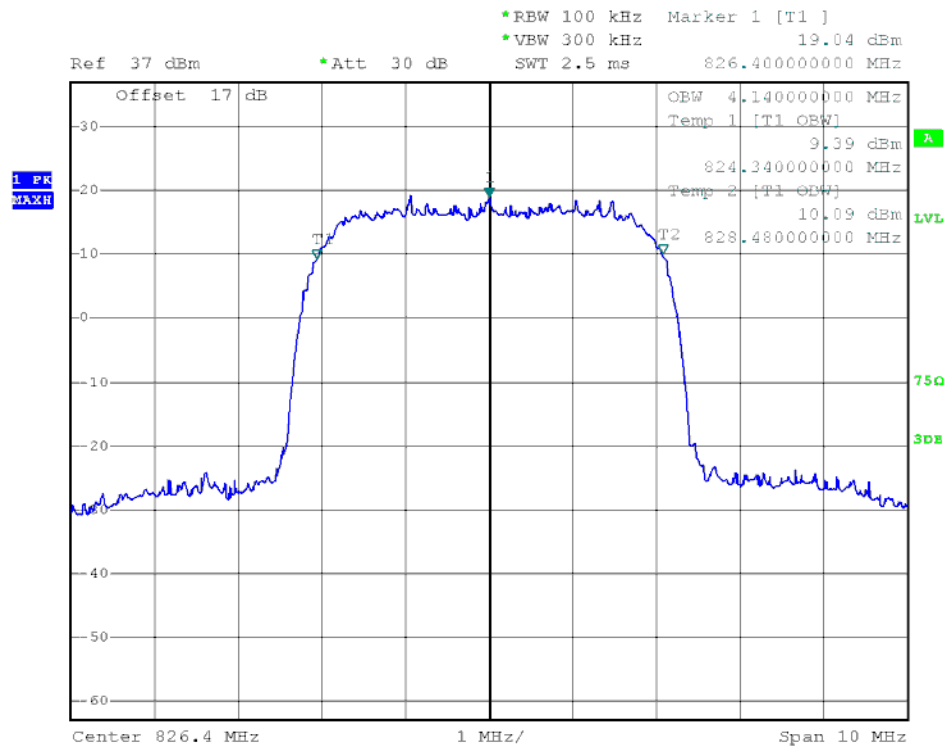

(Plot I2: HSDPA 850MHz Channel = 4132)

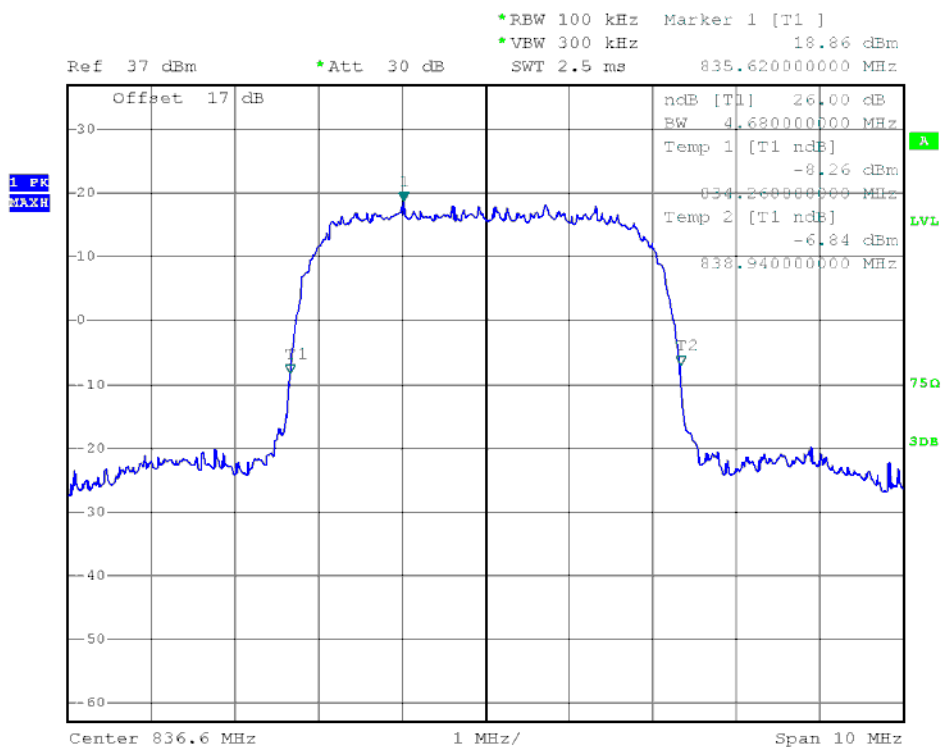

(Plot I3: HSDPA 850 MHz Channel = 4183)

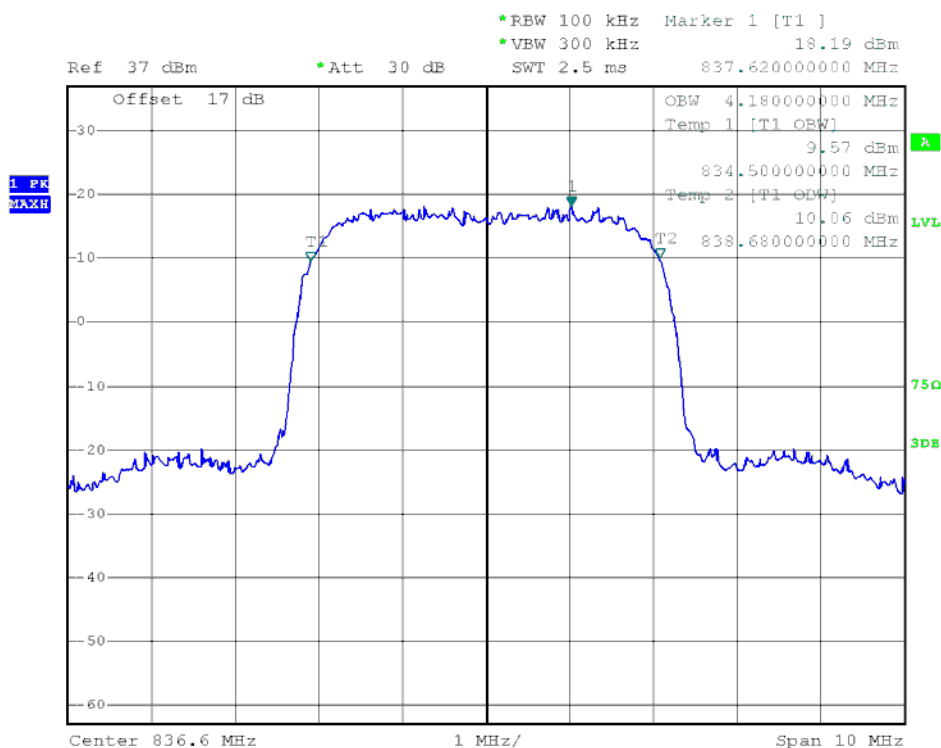

(Plot I4: HSDPA 850 MHz Channel = 4183)

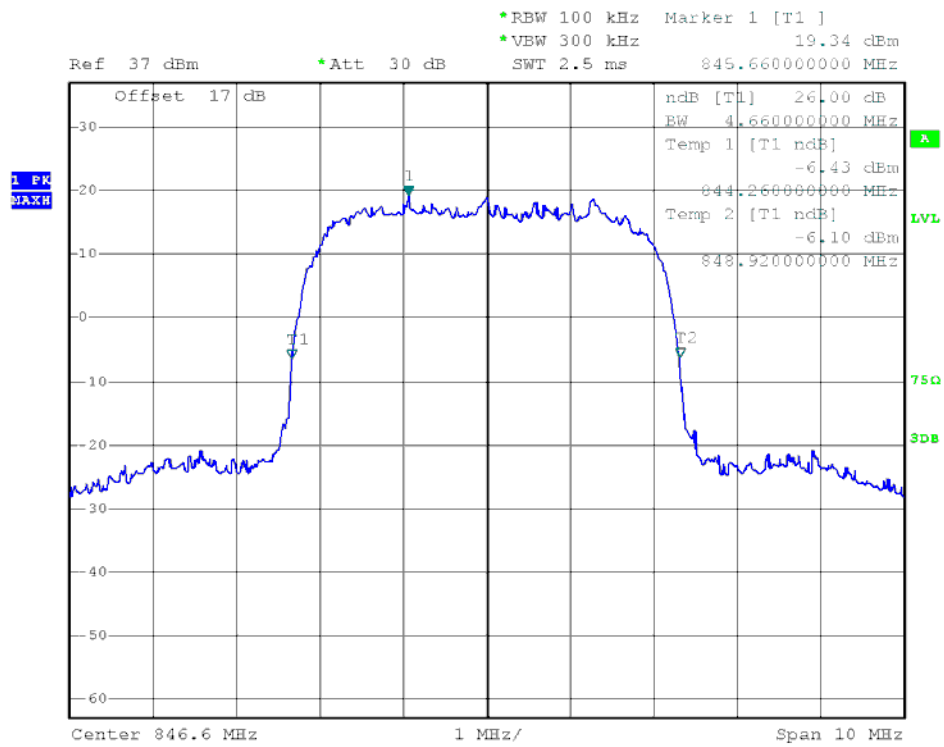

(Plot I5: HSDPA 850MHz Channel = 4233)

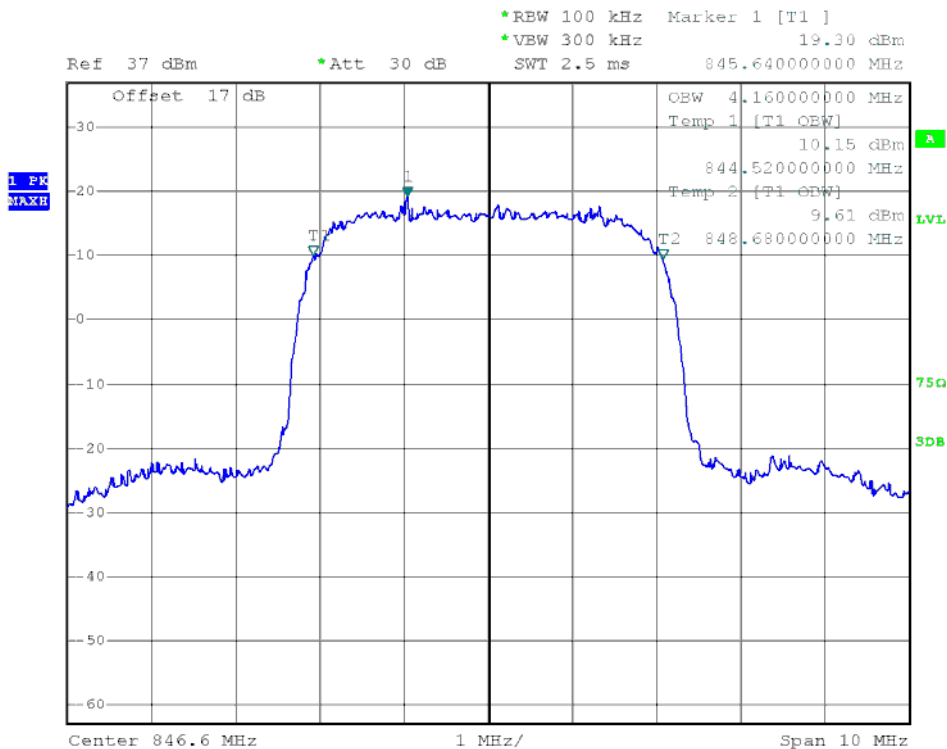

(Plot I6: HSDPA 850MHz Channel = 4233)

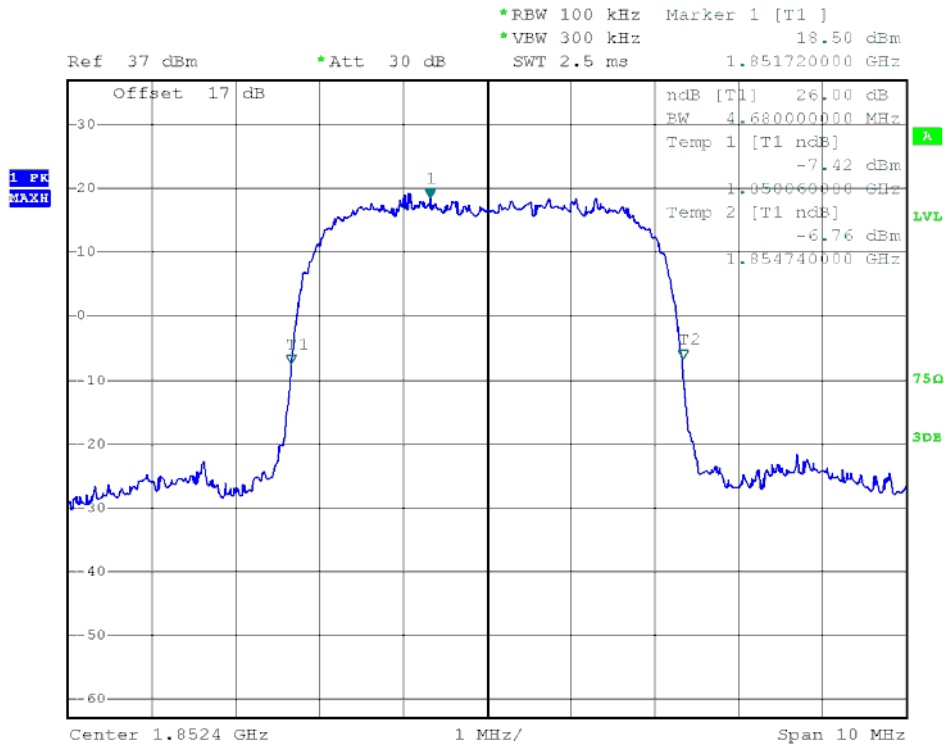

(Plot J1: HSDPA 1900MHz Channel = 9262)

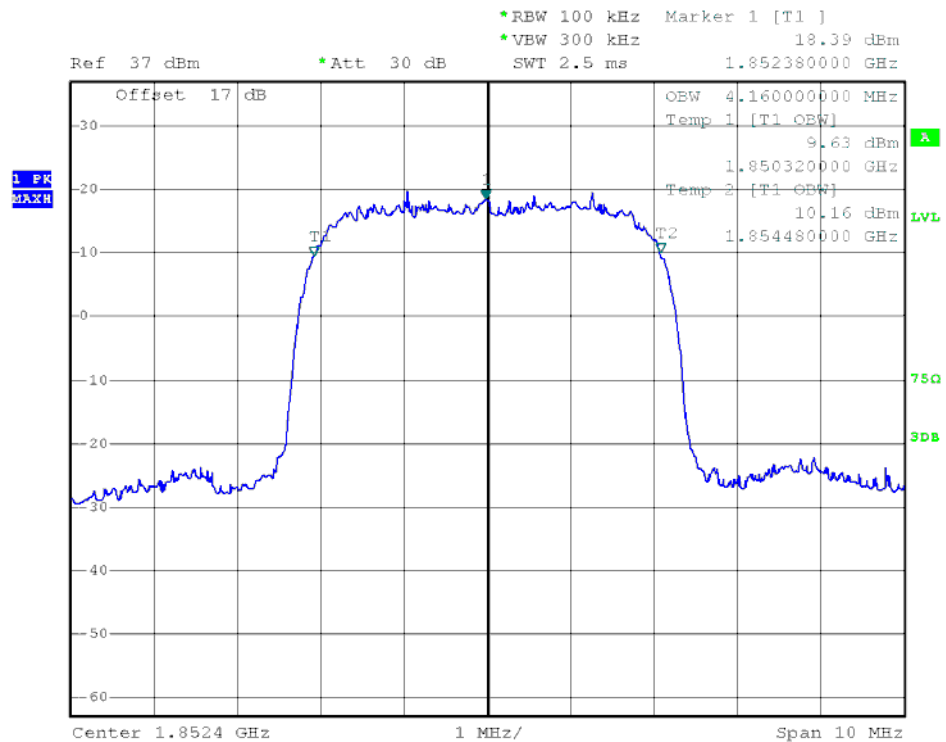

(Plot J2: HSDPA 1900MHz Channel = 9262)

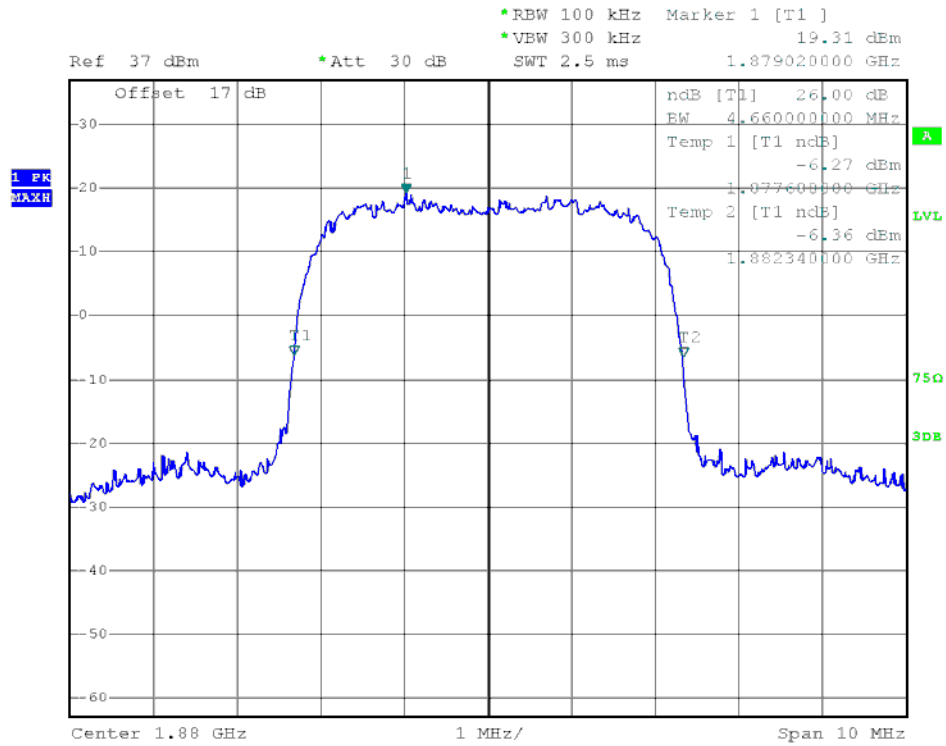

(Plot J3: HSDPA 1900 MHz Channel = 9400)

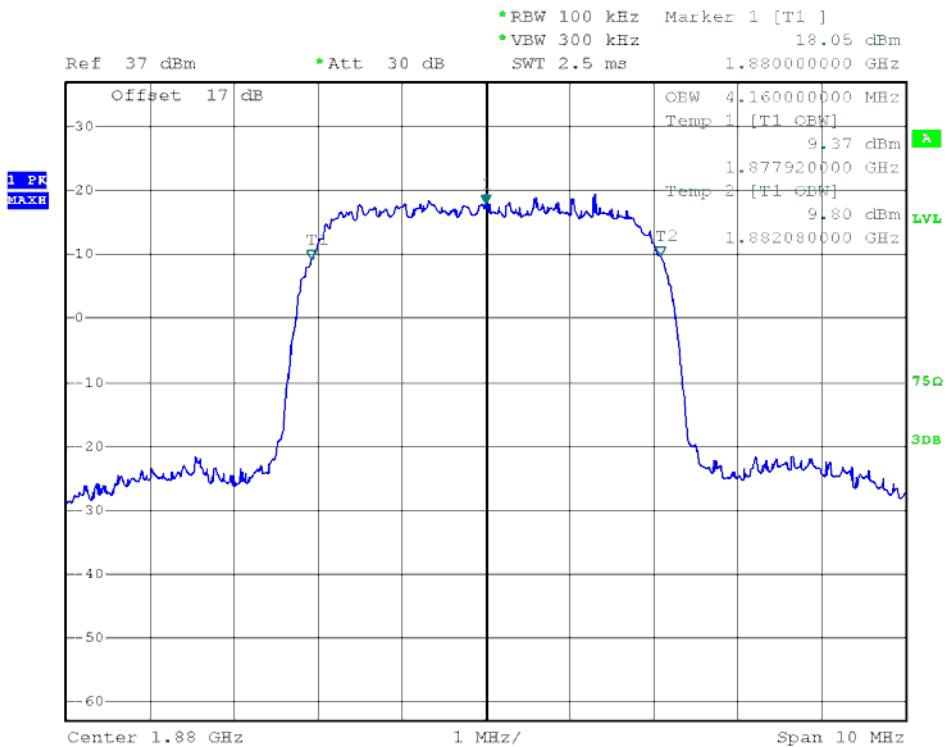

(Plot J4: HSDPA 1900 MHz Channel = 9400)

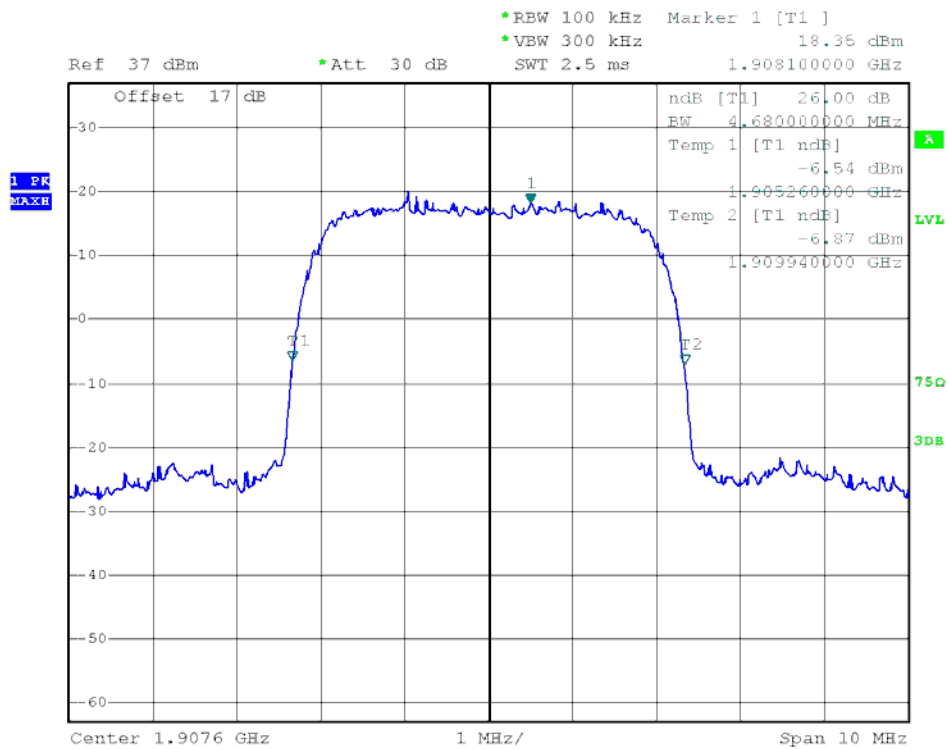

(Plot J5: HSDPA 1900MHz Channel = 9538)

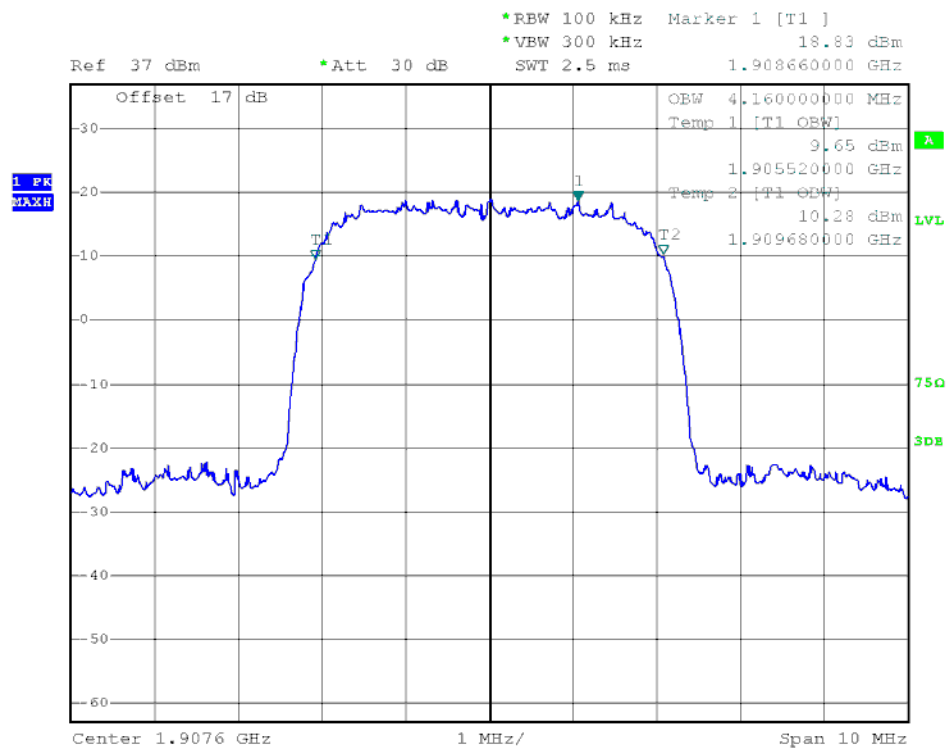

(Plot J6: HSDPA 1900MHz Channel = 9538)

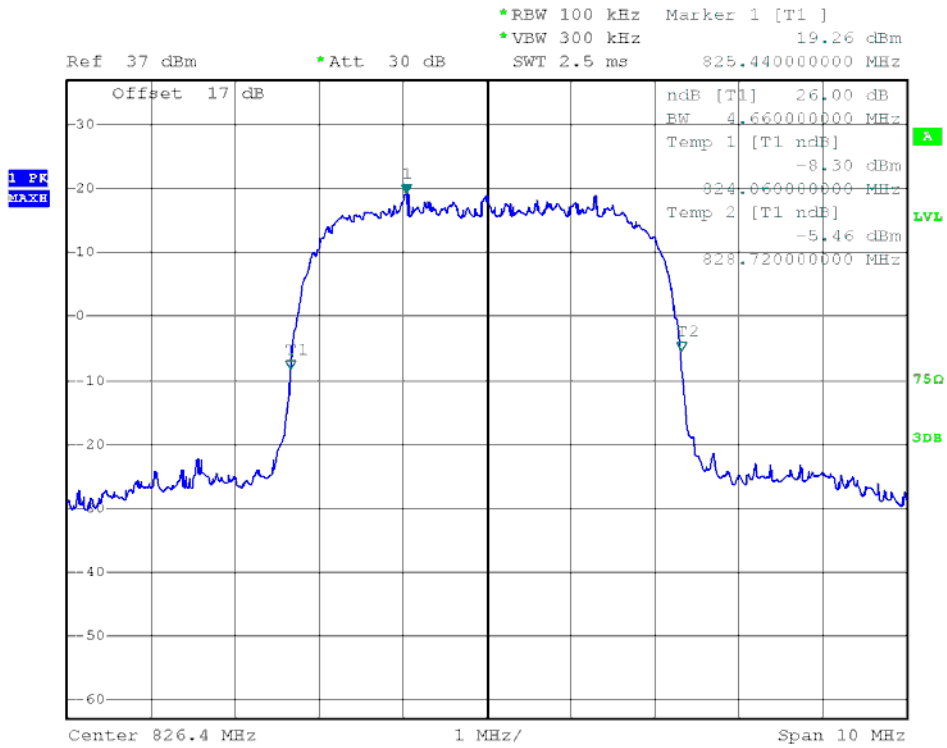

(Plot K1: HSUPA 850MHz Channel = 4132)

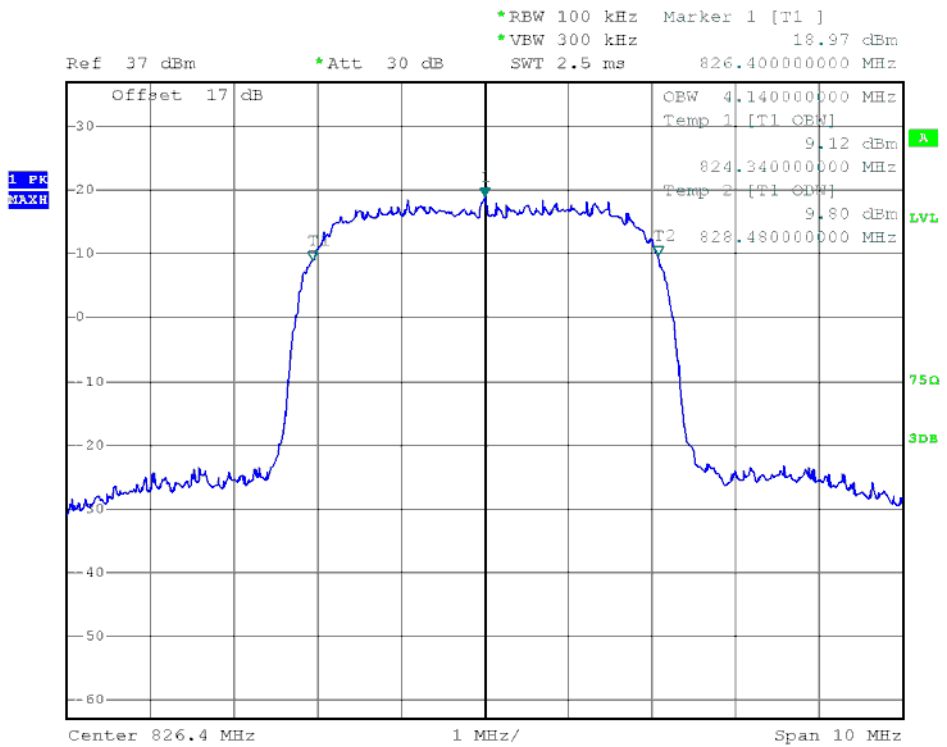

(Plot K2: HSUPA 850MHz Channel = 4132)

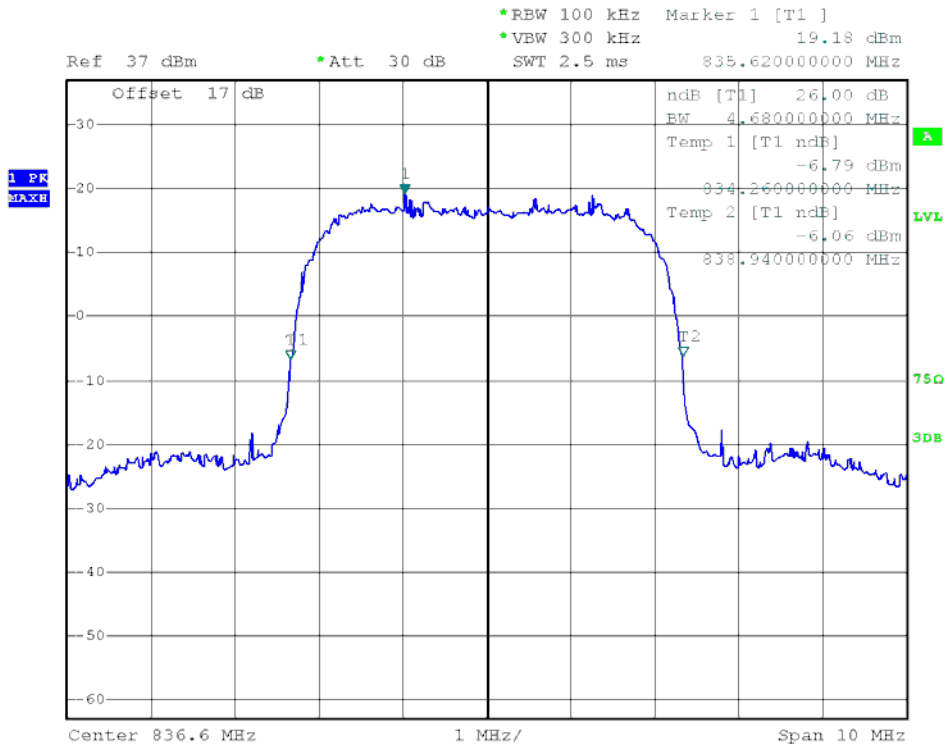

(Plot K3: HSUPA 850 MHz Channel = 4183)

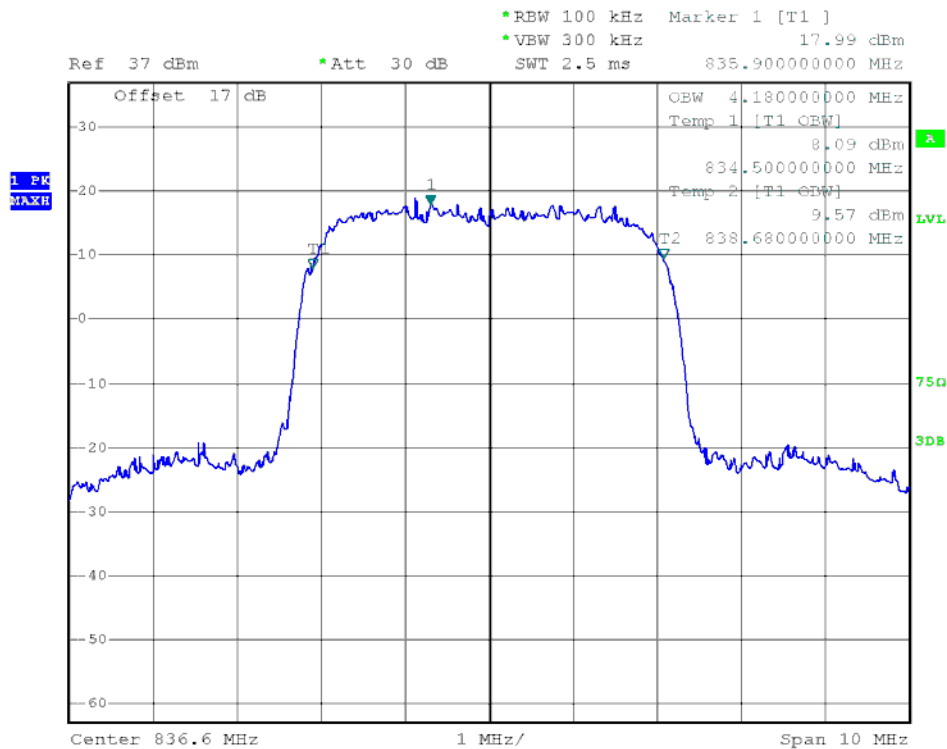

(Plot K4: HSUPA 850 MHz Channel = 4183)

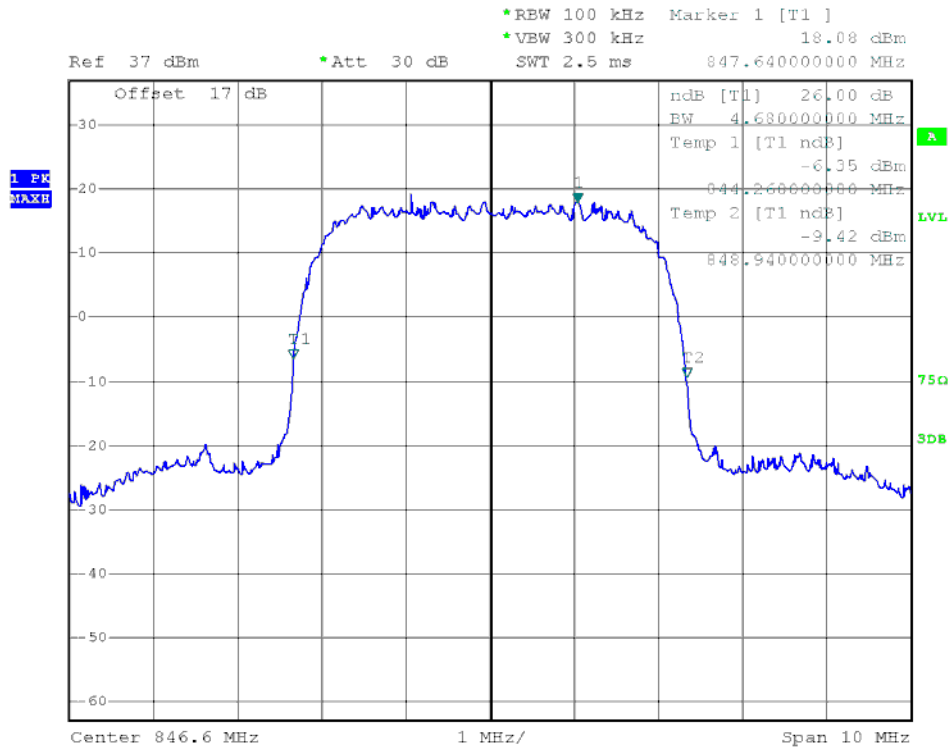

(Plot K5: HSUPA 850MHz Channel = 4233)

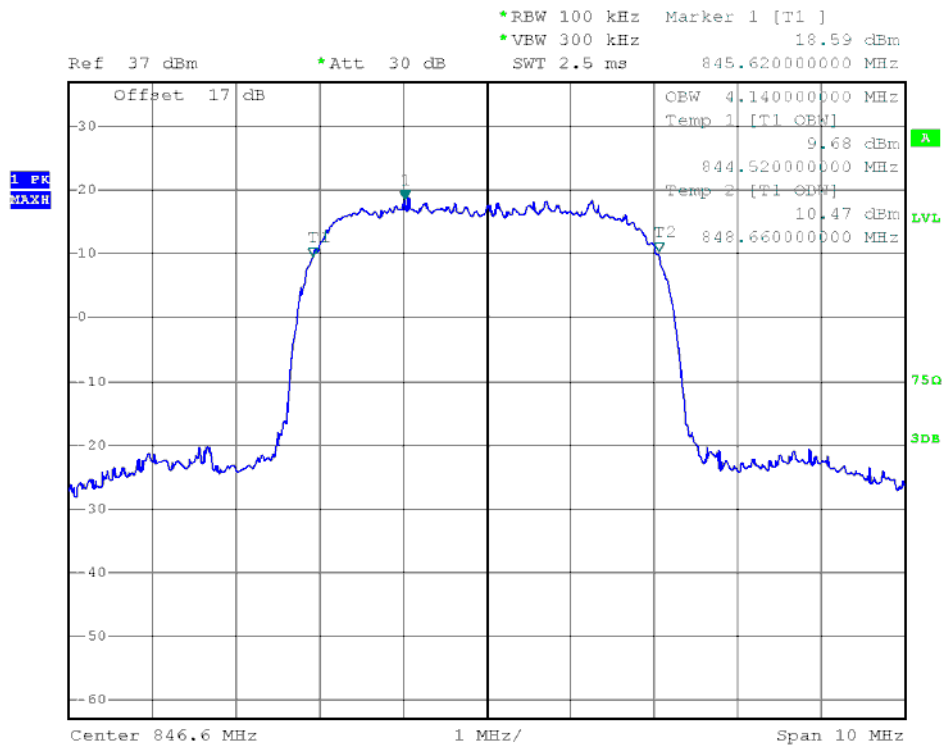

(Plot K6: HSUPA 850MHz Channel = 4233)

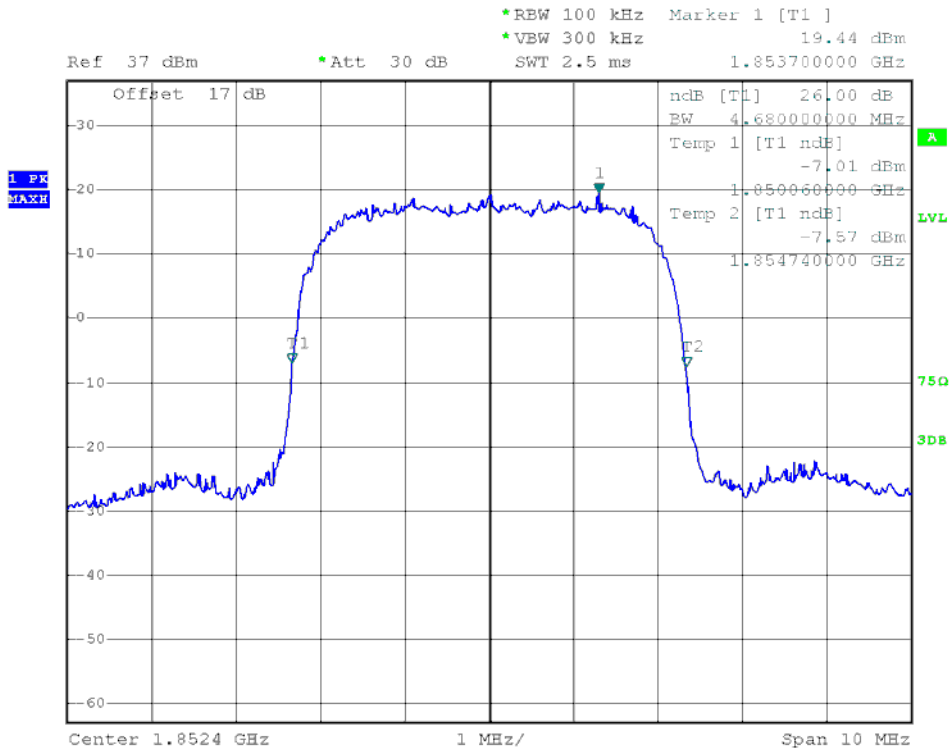

(Plot L1: HSUPA 1900MHz Channel = 9262)

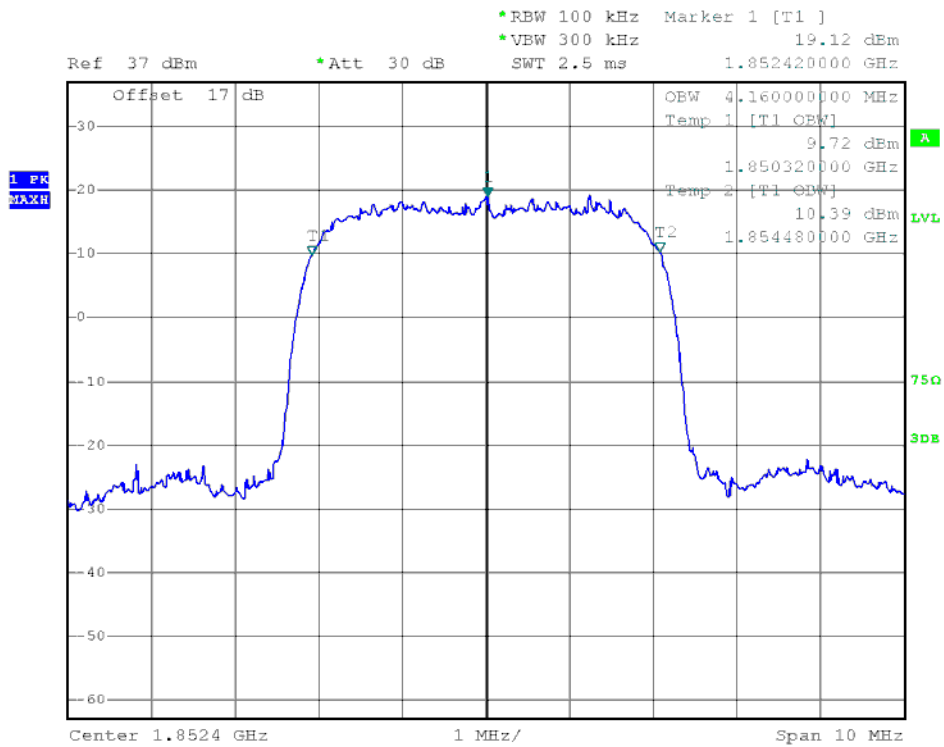

(Plot L2: HSUPA 1900MHz Channel = 9262)

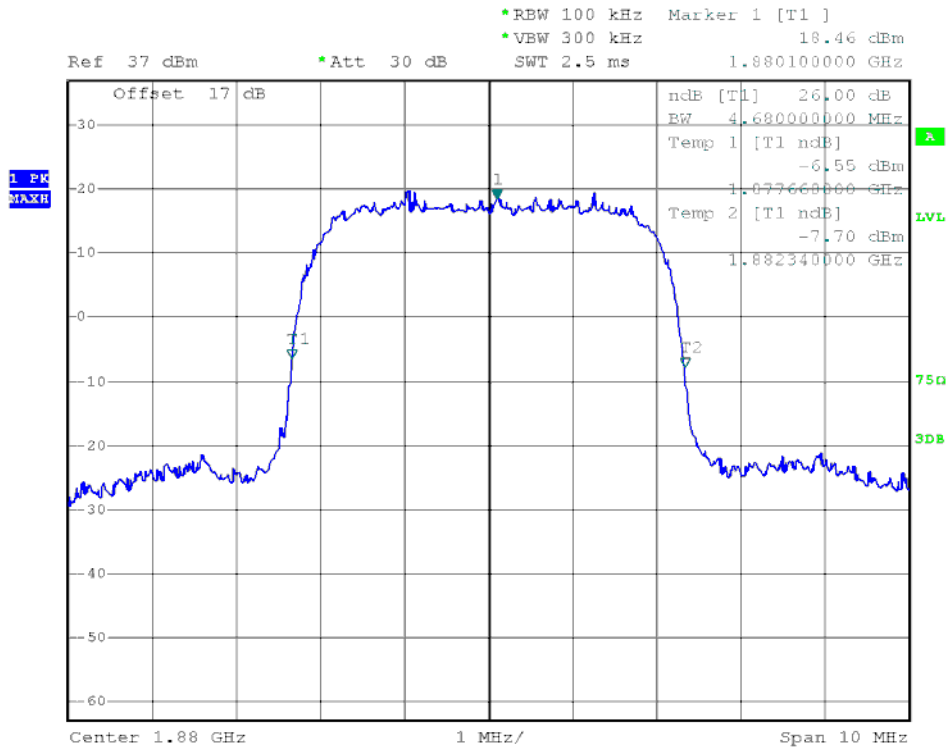

(Plot L3: HSUPA 1900 MHz Channel = 9400)

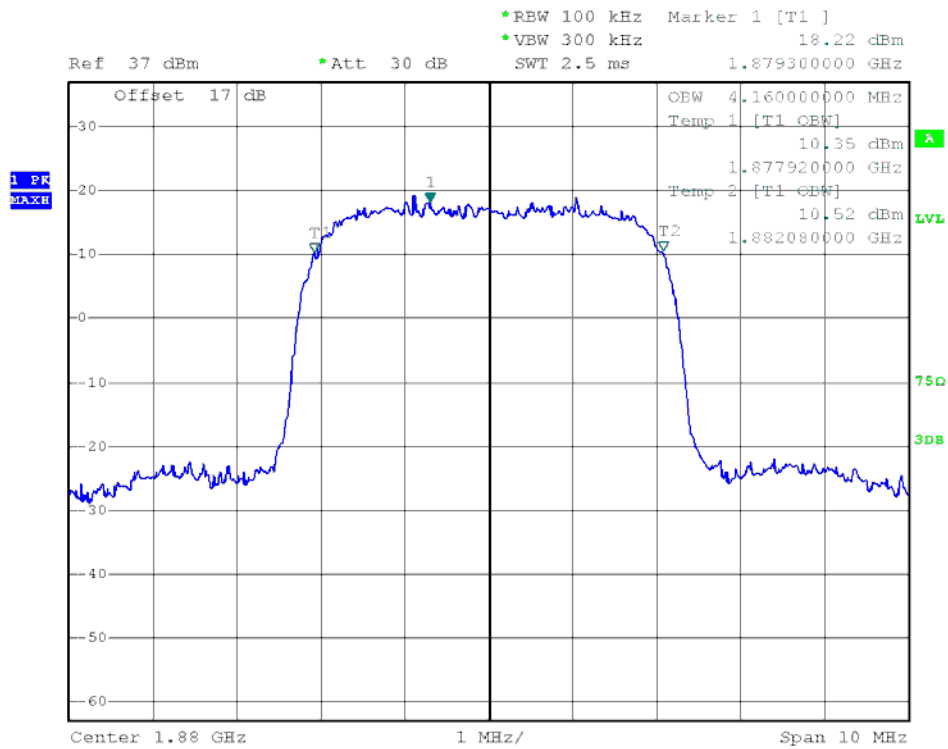

(Plot L4: HSUPA 1900 MHz Channel = 9400)

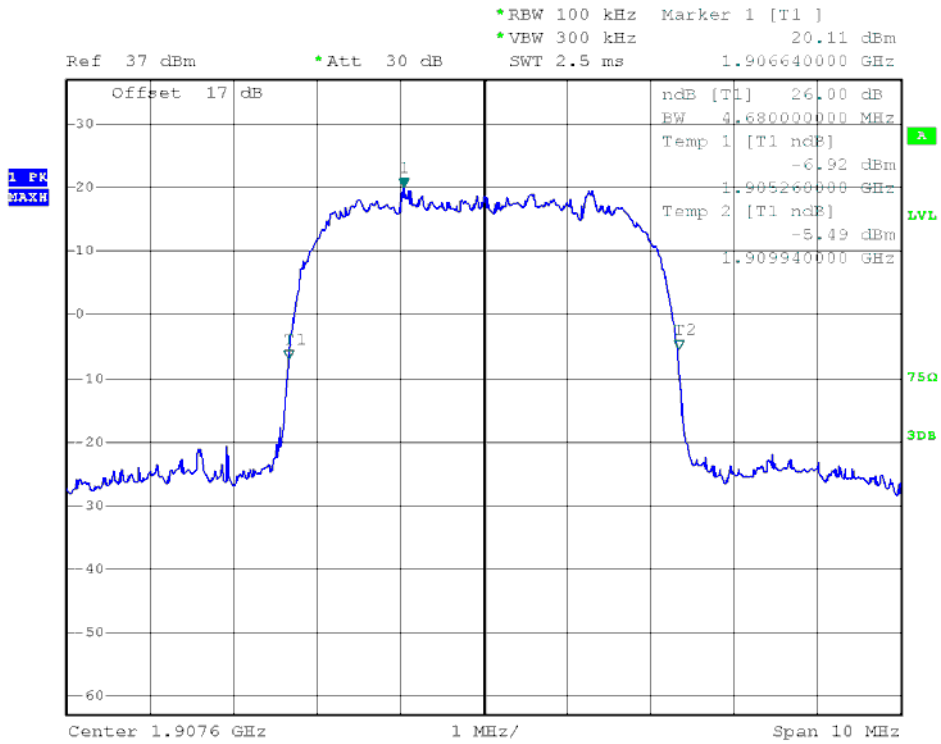

(Plot L5: HSUPA 1900MHz Channel = 9538)

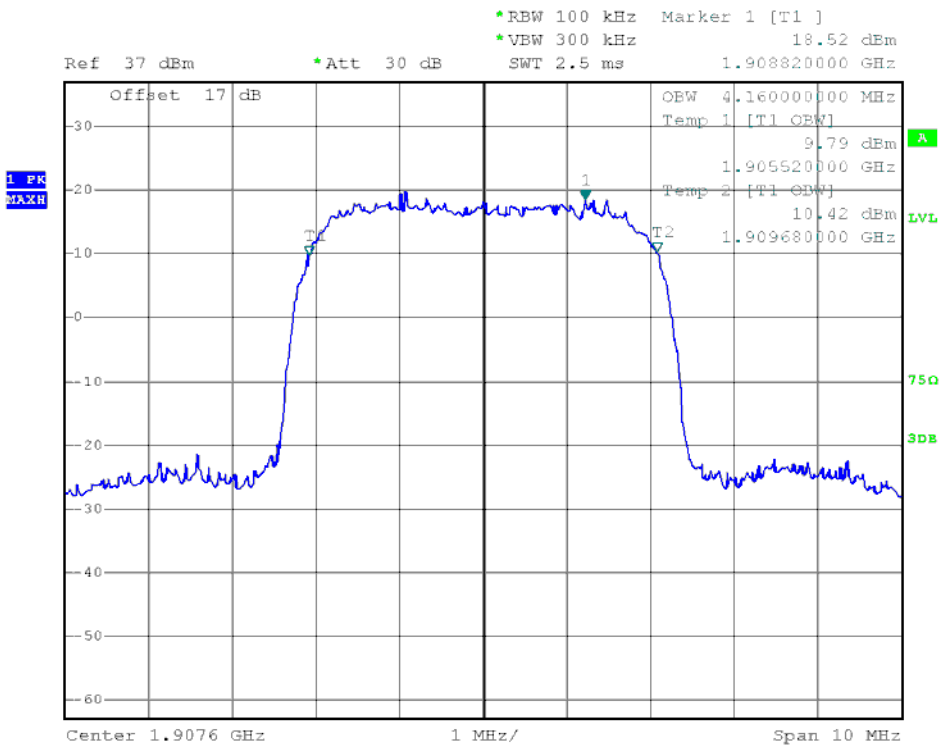

(Plot L6: HSUPA 1900MHz Channel = 9538)

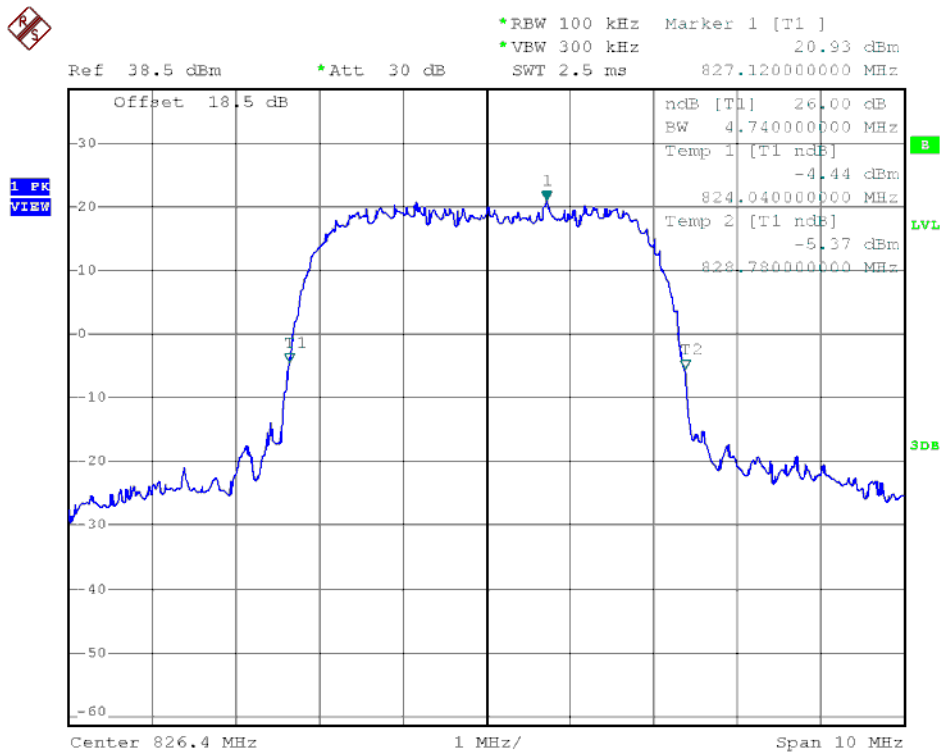

(Plot M1: HSPA+ 850MHz Channel = 4132)

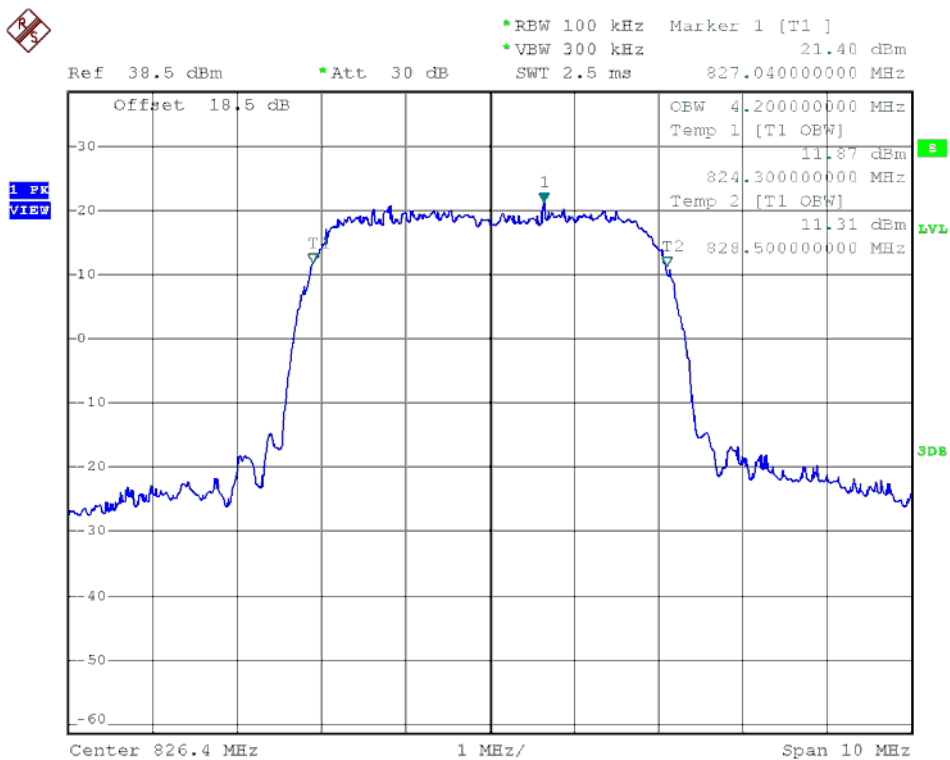

(Plot M2: HSPA+ 850MHz Channel = 4132)

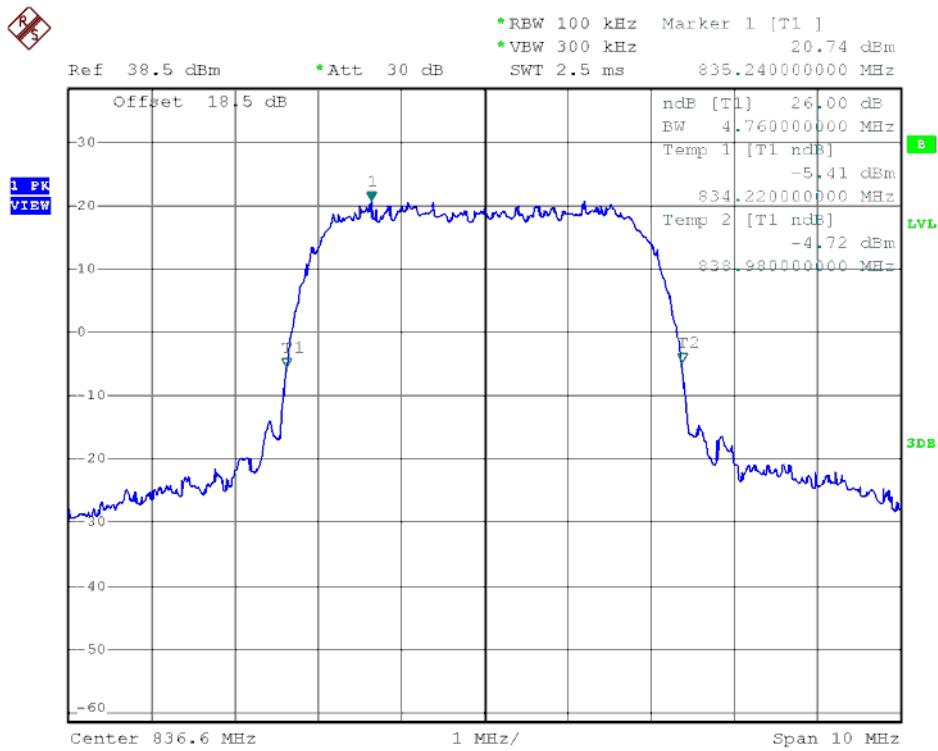

(Plot M3: HSPA+ 850 MHz Channel = 4183)

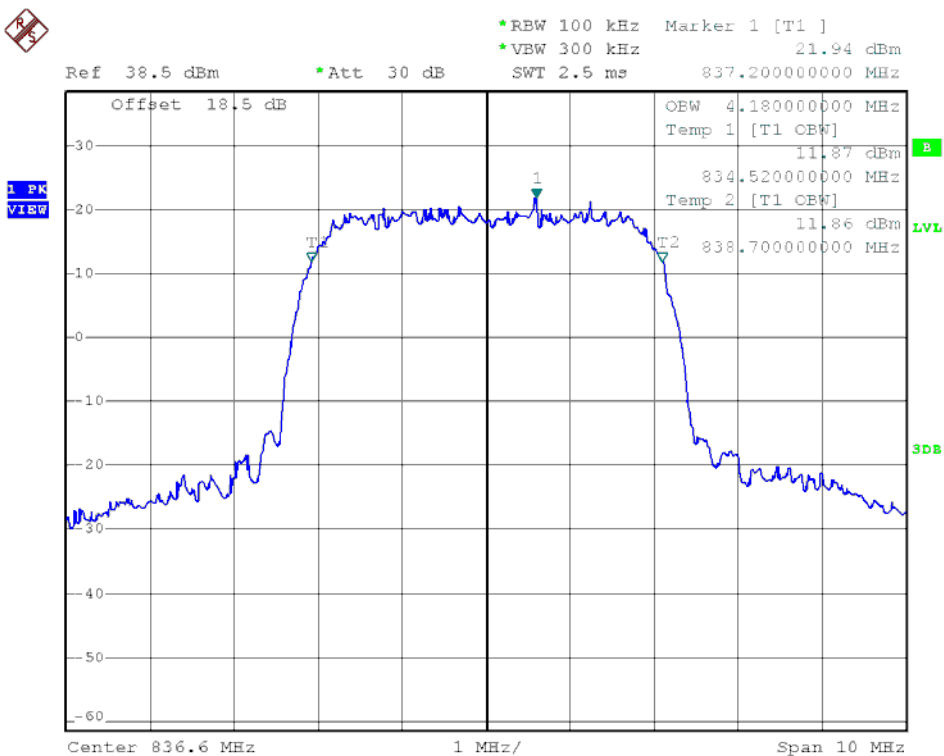

(Plot M4: HSPA+ 850 MHz Channel = 4183)

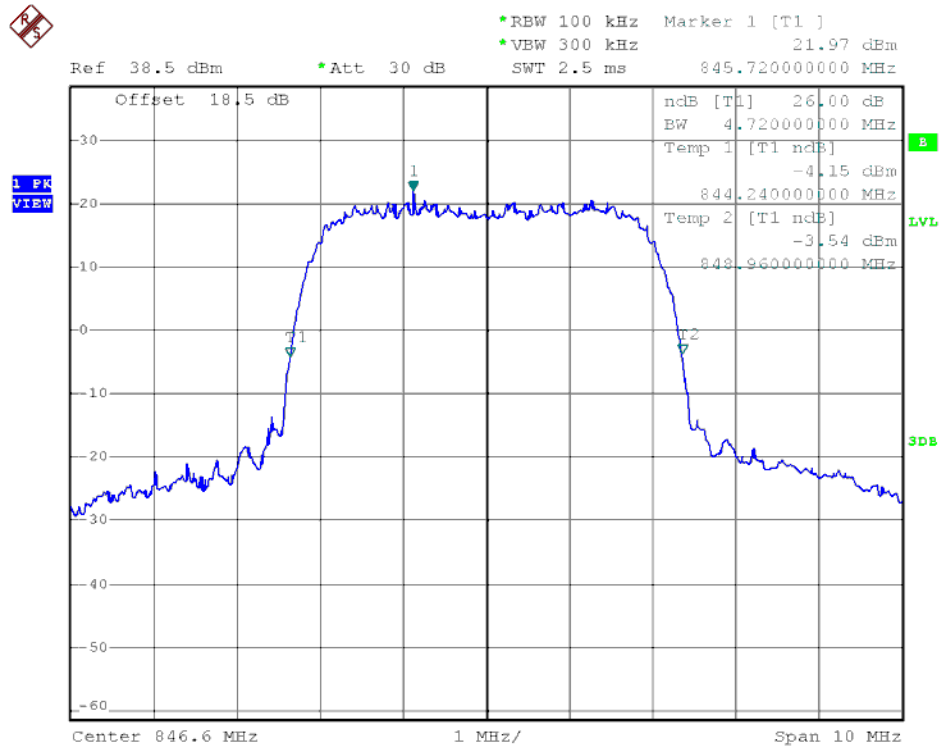

(Plot M5: HSPA+ 850MHz Channel = 4233)

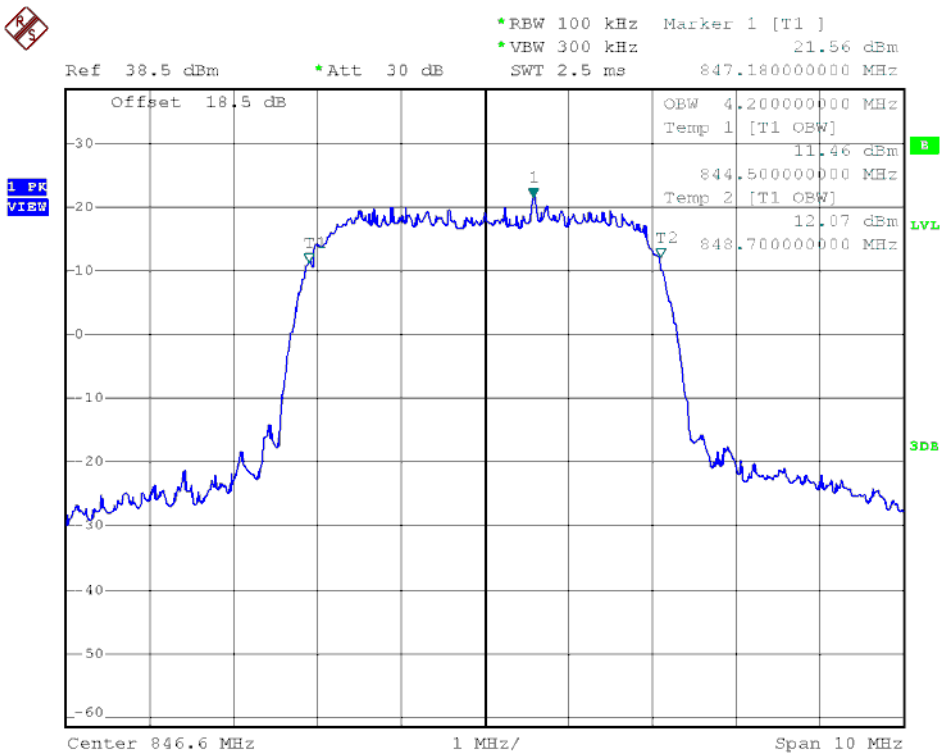

(Plot M6: HSPA+ 850MHz Channel = 4233)

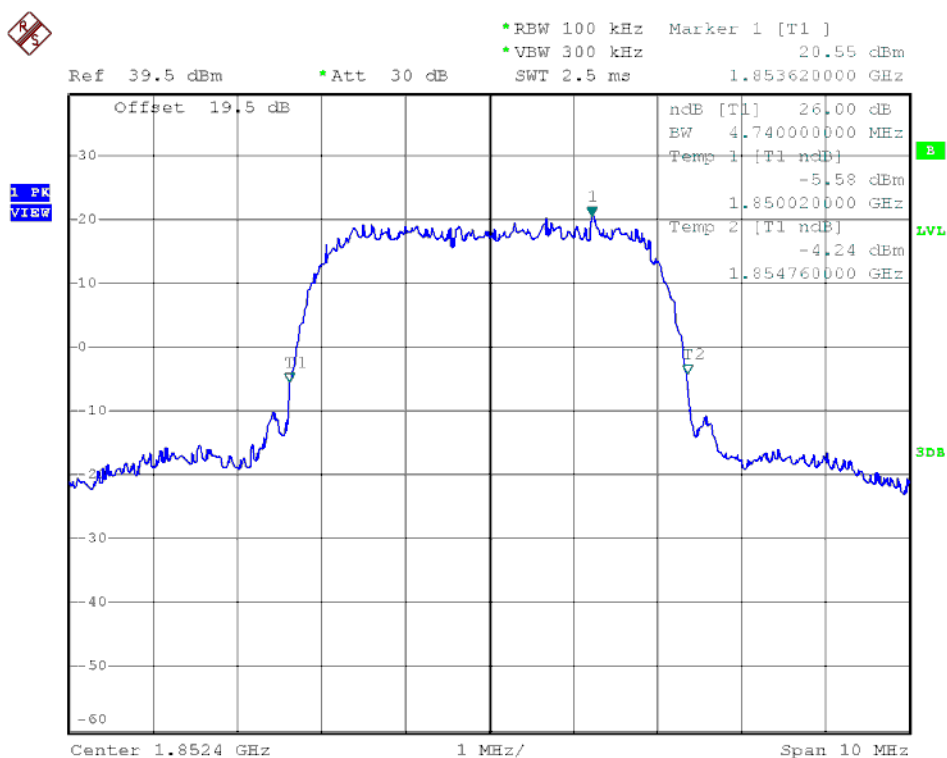

(Plot N1: HSPA+ 1900MHz Channel = 9262)

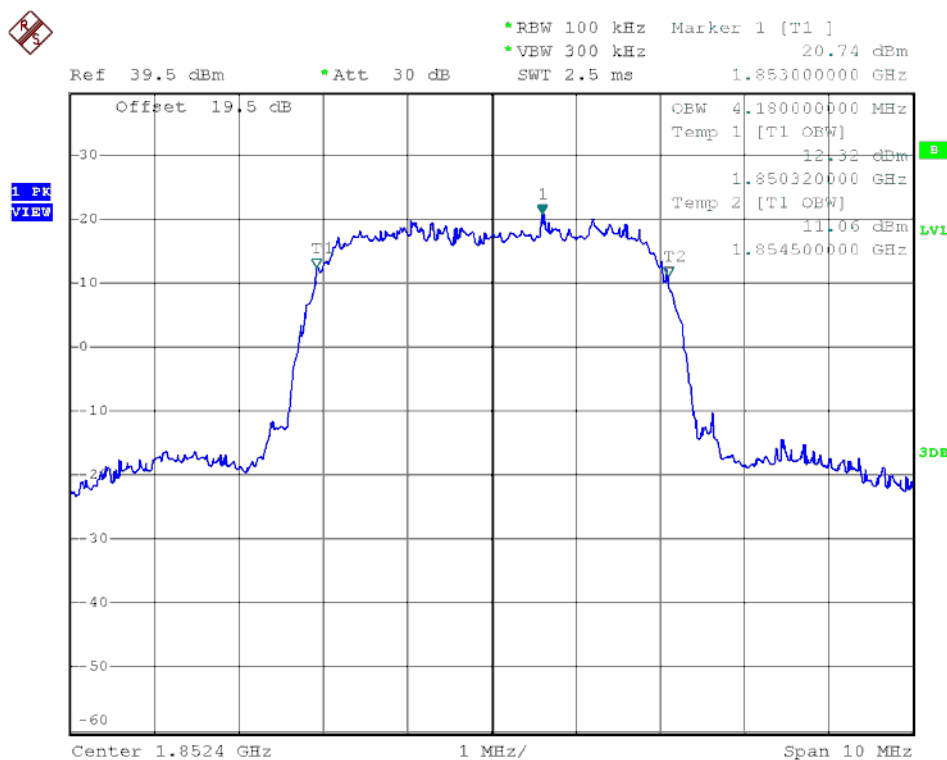

(Plot N2: HSPA+ 1900MHz Channel = 9262)

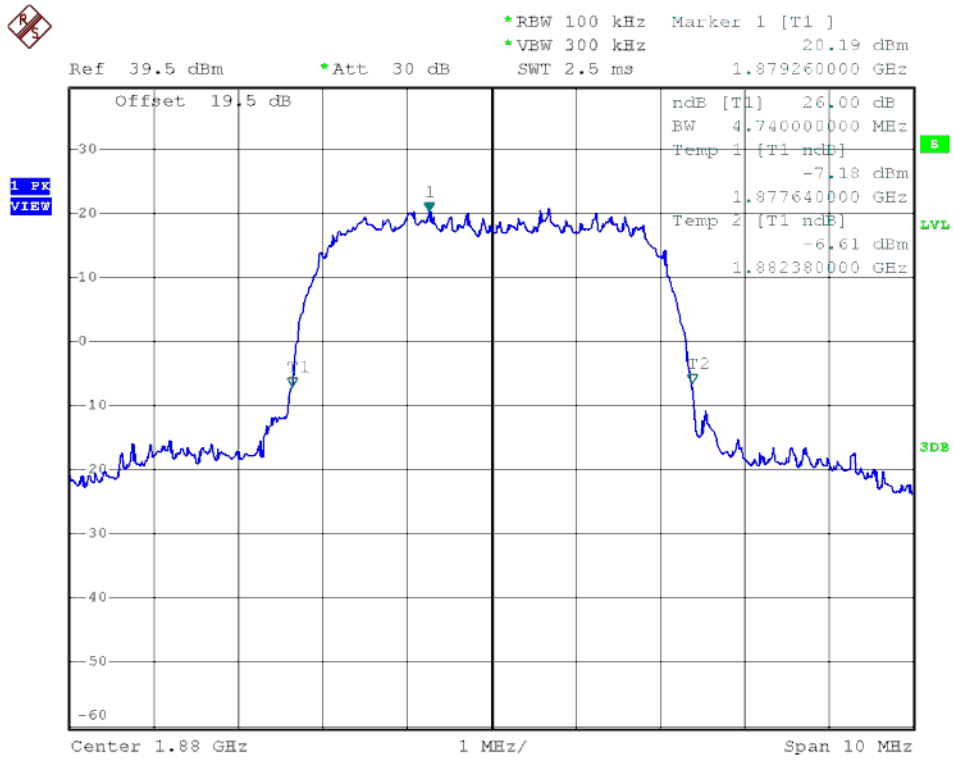

(Plot N3: HSPA+ 1900 MHz Channel = 9400)

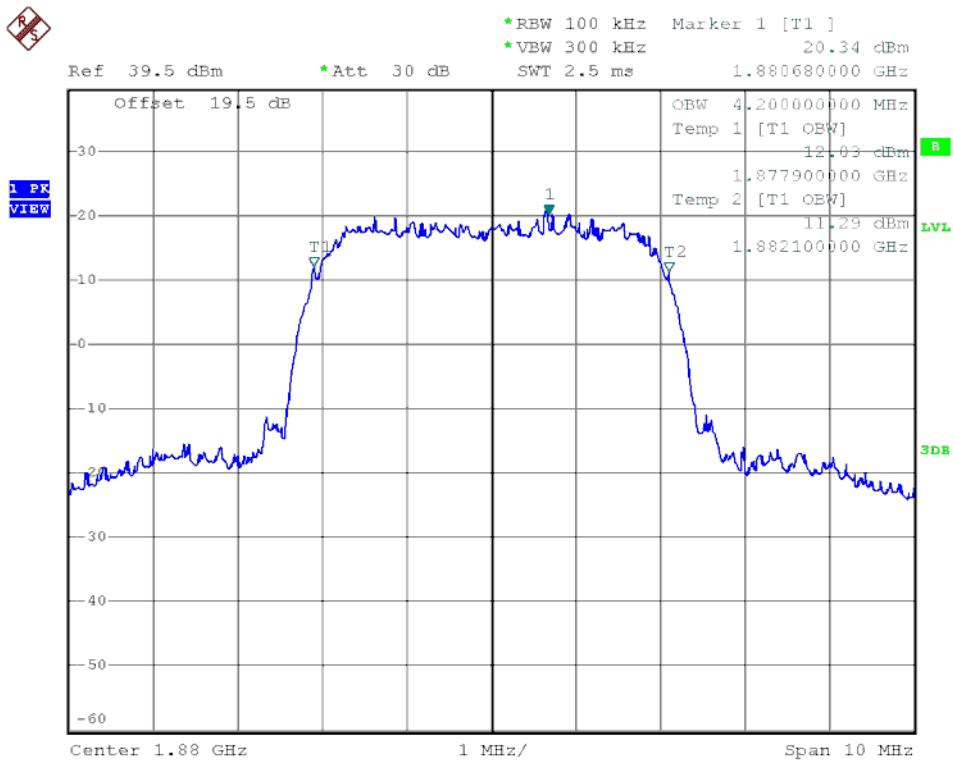

(Plot N4: HSPA+ 1900 MHz Channel = 9400)

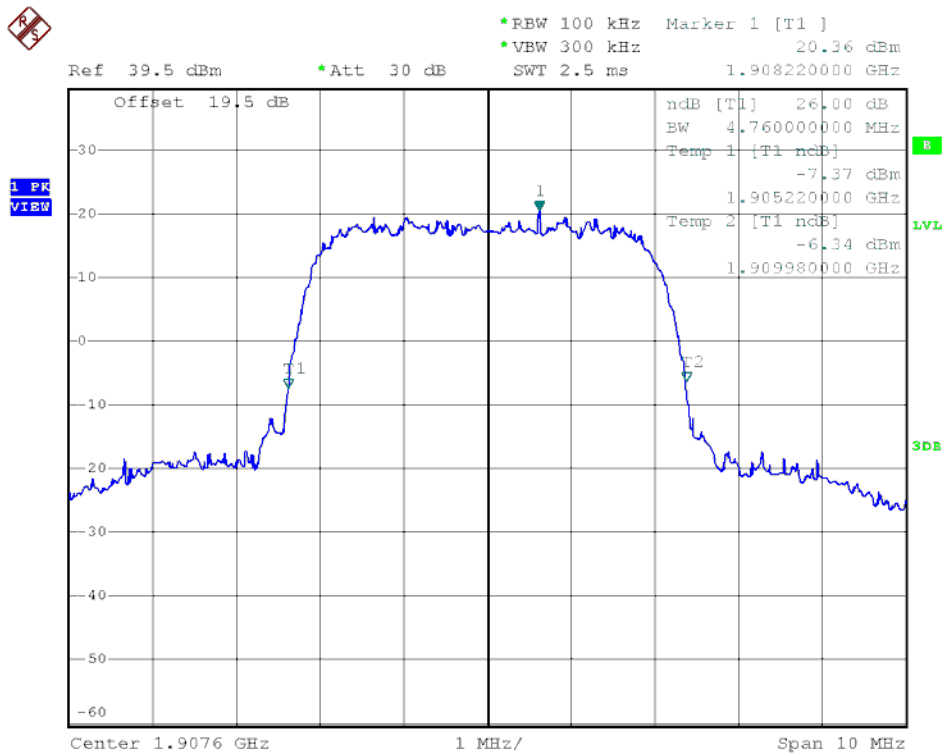

(Plot N5: HSPA+ 1900MHz Channel = 9538)

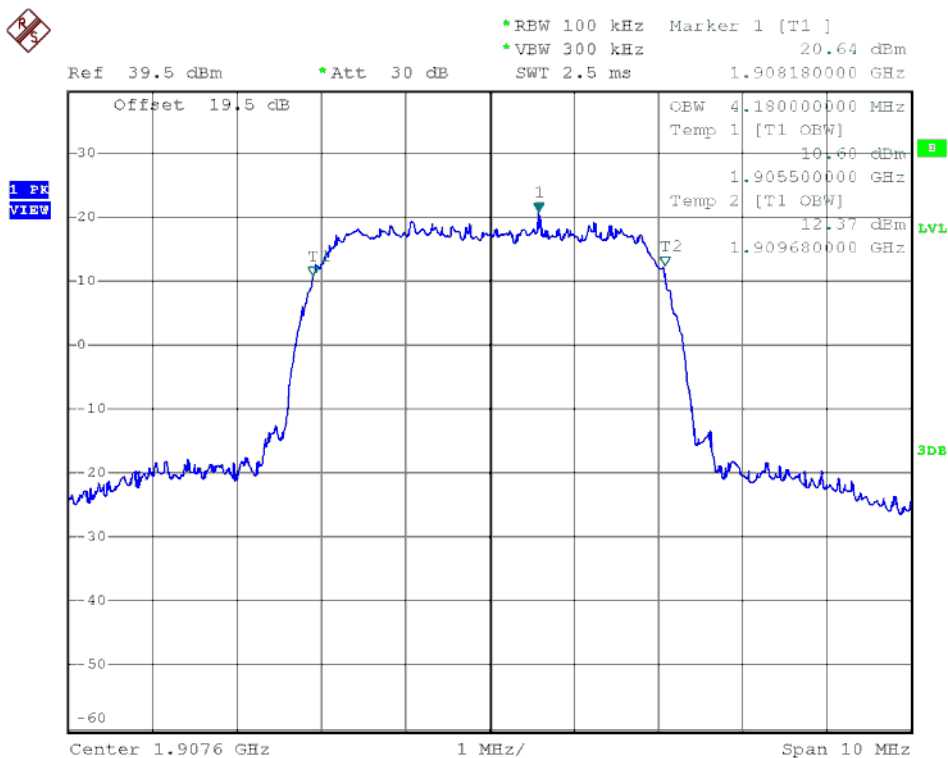

(Plot N6: HSPA+ 1900MHz Channel = 9538)

2.4 Frequency Stability

2.4.1 Requirement

The frequency stability shall be measured by variation of ambient temperature and variation of primary supply voltage to ensure that the fundamental emission stays within the authorized frequency block. The frequency stability of the transmitter shall be maintained within $\pm 0.00025\%$ ($\pm 2.5\text{ppm}$) of the center frequency.

2.4.2 Test Description

1. Test Setup:

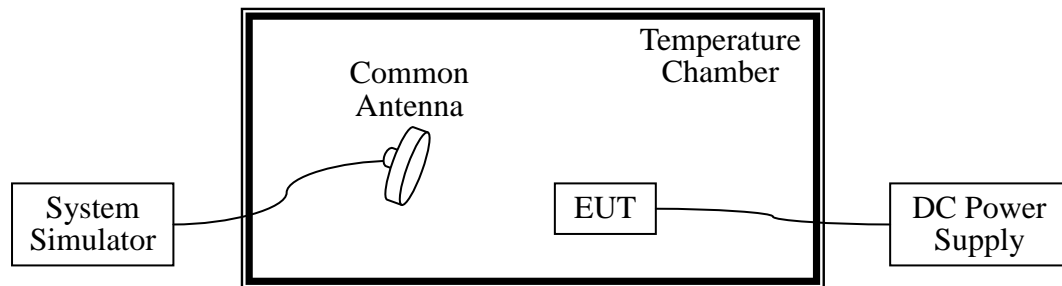

The EUT, which is powered by the DC Power Supply directly, is located in the Temperature Chamber. The EUT is commanded by the System Simulator (SS) to operate at the maximum output power i.e. Power Control Level (PCL) = 5 and Power Class = 4. A call is established between the EUT and the SS via a Common Antenna.

2. Equipments List:

Description	Manufacturer	Model	Serial No.	Cal. Data	Cal. Due Data
System Simulator	Agilent	E5515C	GB43130131	2014.06.11	2015.06.10
DC Power Supply	Good Will	GPS-3030DD	EF920938	2014.06.11	2015.06.10
Temperature Chamber	YinHe Experimental Equip.	HL4003T	(n.a.)	2014.06.11	2015.06.10
Cable	SUNHNER	SUCOFLEX 100	/	2014.06.05	2015.06.04

2.4.3 Test Procedures for Temperature Variation

1. The testing follows FCC KDB 971168 v02r01 Section 9.0.
2. The EUT was set up in the thermal chamber and connected with the system simulator.



3. With power OFF, the temperature was decreased to -30 °C and the EUT was stabilized before testing. Power was applied and the maximum change in frequency was recorded within one minute.
4. With power OFF, the temperature was raised in 10 °C steps up to 50 °C. The EUT was stabilized at each step for at least half an hour. Power was applied and the maximum frequency change was recorded within one minute.

2.4.4 Test Procedures for Voltage Variation

1. The testing follows FCC KDB 971168 v02r01 Section 9.0.
2. The EUT was placed in a temperature chamber at 25 ±5 °C and connected with the system simulator.
3. The power supply voltage to the EUT was varied from BEP to 115% of the nominal value measured at the input to the EUT.
4. The variation in frequency was measured for the worst case.

2.4.5 Test Verdict

The nominal, highest and lowest extreme voltages are separately 3.8VDC, 4.2VDC and 3.6VDC, which are specified by the applicant; the normal temperature here used is 25 °C. The frequency deviation limit of 850MHz band is ±2.5ppm, and 1900MHz is ±1ppm

1. GSM 850MHz Band

Test Conditions		Frequency Deviation						Verdict
Power (VDC)	Temperature (°C)	Channel = 128 (824.2MHz)		Channel = 190 (836.6MHz)		Channel = 251 (848.8MHz)		
		Hz	Limits	Hz	Limits	Hz	Limits	
3.8	-30	24.89	±2060.5	4.43	±2091.5	5.30	±2122	PASS
	-20	38.66		-15.01		37.67		
	-10	41.47		34.03		-12.80		
	0	13.21		44.86		39.77		
	+10	10.35		51.87		45.48		
	+20	-12.03		51.00		9.68		
	+30	21.03		38.12		-12.23		
	+40	25.80		17.07		5.04		
	+50	27.93		29.71		2.61		
4.2	+25	3.71		42.55		42.18		
3.6	+25	25.57		53.57		48.27		

2. GSM 1900MHz Band

Test Conditions		Frequency Deviation						Verdict
Power (VDC)	Temperature (°C)	Channel = 512 (1850.2MHz)		Channel = 661 (1880.0MHz)		Channel = 810 (1909.8MHz)		
		Hz	Limits	Hz	Limits	Hz	Limits	
3.8	-30	-5.19	±1850.2	48.91	±1880.0	29.27	±1909.8	PASS
	-20	19.00		11.01		-8.57		
	-10	38.22		15.79		36.13		
	0	25.23		41.59		-14.70		
	+10	-1.45		-10.89		-8.71		
	+20	6.94		-7.13		-15.98		
	+30	21.13		29.44		21.63		
	+40	41.23		-10.34		-2.73		
+50	30.96	15.41	8.69					
4.2	+25	-5.63	32.72	48.24				
3.6	+25	20.67	-9.80	36.41				

3. EDGE 850MHz Band

Test Conditions		Frequency Deviation						Verdict
Power (VDC)	Temperature (°C)	Channel = 128 (824.2MHz)		Channel = 190 (836.6MHz)		Channel = 251 (848.8MHz)		
		Hz	Limits	Hz	Limits	Hz	Limits	
3.8	-30	53.12	±2060.5	26.32	±2091.5	18.24	±2122	PASS
	-20	45.27		49.22		48.85		
	-10	30.81		0.87		42.82		
	0	54.90		34.76		27.61		
	+10	-5.95		41.21		34.98		
	+20	30.97		53.40		37.51		
	+30	38.53		33.93		24.02		
	+40	28.67		16.43		-2.96		
+50	14.09	10.68	-2.48					
4.2	+25	27.35	25.06	36.37				
3.6	+25	6.10	34.97	15.30				

4. EDGE 1900MHz Band

Test Conditions		Frequency Deviation						Verdict
Power (VDC)	Temperature (°C)	Channel = 512 (1850.2MHz)		Channel = 661 (1880.0MHz)		Channel = 810 (1909.8MHz)		
		Hz	Limits	Hz	Limits	Hz	Limits	
3.8	-30	21.88	±1850.2	39.06	±1880.0	39.43	±1909.8	PASS
	-20	17.62		48.73		39.04		
	-10	-1.53		32.16		37.00		
	0	-6.03		19.61		17.81		
	+10	9.99		53.81		42.53		
	+20	35.96		18.77		38.33		
	+30	10.10		15.01		19.75		
	+40	51.32		0.50		32.86		
+50	14.47	-0.56	4.44					
4.2	+25	-2.21		19.71		52.20		
3.6	+25	26.45		23.51		53.04		

5. WCDMA 850MHz Band

Test Conditions		Frequency Deviation						Verdict
Power (VDC)	Temperature (°C)	Channel = 4123 (826.4MHz)		Channel = 4183 (836.6MHz)		Channel = 4233 (846.6MHz)		
		Hz	Limit	Hz	Limit	Hz	Limit	
3.8	-30	-4.32	±2066	27.18	±2091.5	5.05	±2116.5	PASS
	-20	35.25		30.07		7.49		
	-10	-19.21		5.48		0.19		
	0	27.75		-1.82		34.30		
	+10	-13.73		19.02		45.99		
	+20	-6.95		44.78		-16.51		
	+30	48.07		21.99		19.46		
	+40	42.00		17.67		-6.80		
+55	38.85	-19.44	7.58					
4.2	+25	31.42		-6.76		3.11		
3.6	+25	4.49		14.09		-4.93		



6. WCDMA 1900MHz Band

Test Conditions		Frequency Deviation						Verdict
Power (VDC)	Temperature (°C)	Channel = 9262 (1852.4MHz)		Channel = 9400 (1880.0MHz)		Channel = 9538 (1907.6MHz)		
		Hz	Limits	Hz	Limits	Hz	Limits	
3.8	-30	-0.97	±1852.4	51.25	±1880.0	1.12	±1907.6	PASS
	-20	35.71		51.56		8.81		
	-10	54.73		48.10		22.21		
	0	25.45		43.19		47.37		
	+10	18.46		6.50		14.85		
	+20	20.42		3.76		33.63		
	+30	0.36		7.11		38.27		
	+40	26.25		5.70		57.38		
	+55	24.14		-5.74		21.22		
4.2	+25	12.46		42.11		50.98		
3.6	+25	46.55		5.31		0.95		



2.5 Conducted Out of Band Emissions

2.5.1 Requirement

The power of any emission outside of the authorized operating frequency ranges must be lower than the transmitter power (P) by a factor of at least $43 + 10 \log (P)$ dB.

It is measured by means of a calibrated spectrum analyzer and scanned from 30 MHz up to a frequency including its 10th harmonic.

2.5.2 Test Description

See section 2.1.2 of this report.

2.5.3 Test Procedures

1. The testing follows FCC KDB 971168 v02r01 Section 6.0.
2. The EUT was connected to the spectrum analyzer and system simulator via a power divider.
3. The RF output of EUT was connected to the spectrum analyzer by an RF cable and attenuator. The path loss was compensated to the results for each measurement.
4. The middle channel for the highest RF power within the transmitting frequency was measured.
5. The conducted spurious emission for the whole frequency range was taken.
6. The RF fundamental frequency should be excluded against the limit line in the operating frequency band.
7. The limit line is derived from $43 + 10 \log(P)$ dB below the transmitter power P(Watts)
 - = $P(W) - [43 + 10 \log(P)]$ (dB)
 - = $[30 + 10 \log(P)]$ (dBm) - $[43 + 10 \log(P)]$ (dB)
 - = -13dBm.

2.5.4 Test Result

The measurement frequency range is from 30MHz to the 10th harmonic of the fundamental frequency. The lowest, middle and highest channels are tested to verify the out of band emissions.

1. Test Verdict:

Band	Channel	Frequency (MHz)	Measured Max. Spurious Emission (dBm)	Refer to Plot	Limit (dBm)	Verdict
GSM 850MHz	128	824.2	-26.80	Plot A1toA1.1	-13	PASS
	190	836.6	-26.90	Plot A2toA2.1		PASS
	251	848.8	-27.16	Plot A3toA3.1		PASS
GSM 1900MHz	512	1850.2	-18.29	Plot B1toB1.1	-13	PASS
	661	1880.0	-18.78	Plot B2toB2.1		PASS
	810	1909.8	-18.93	Plot B3toB3.1		PASS



Band	Channel	Frequency (MHz)	Measured Max. Spurious Emission (dBm)	Refer to Plot	Limit (dBm)	Verdict
EDGE 850MHz	128	824.2	-26.62	Plot C1toC1.1	-13	PASS
	190	836.6	-27.20	Plot C2toC2.1		PASS
	251	848.8	-26.70	Plot C3toC3.1		PASS
EDGE 1900MHz	512	1850.2	-18.73	Plot D1toD1.1	-13	PASS
	661	1880.0	-18.26	Plot D2toD2.1		PASS
	810	1909.8	-19.23	Plot D3toD3.1		PASS
WCDMA 850MHz	4132	826.4	-27.08	Plot E1toE1.1	-13	PASS
	4183	836.6	-26.90	Plot E2toE2.1		PASS
	4233	846.6	-27.51	Plot E3toE3.1		PASS
WCDMA 1900MHz	9262	1852.4	-19.28	Plot F1toF1.1	-13	PASS
	9400	1880	-19.84	Plot F2toF2.1		PASS
	9538	1907.6	-18.78	Plot F3toF3.1		PASS

2. Test Plots for the Whole Measurement Frequency Range:

Note: the power of the EUT transmitting frequency should be ignored.

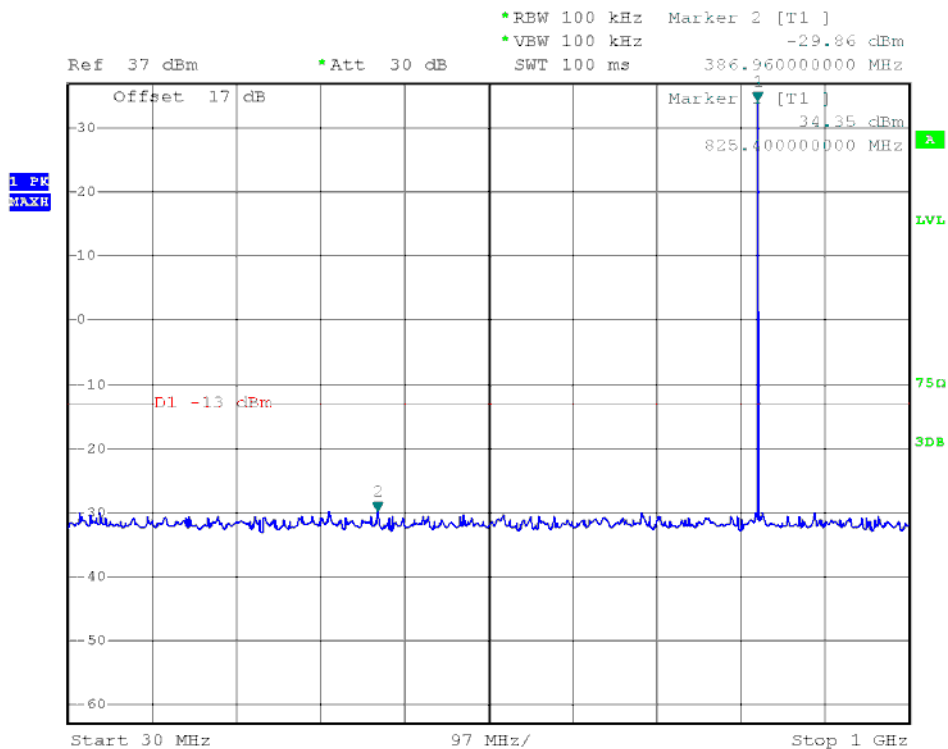

(Plot A1: GSM 850MHz Channel = 128, 30MHz to 1GHz)

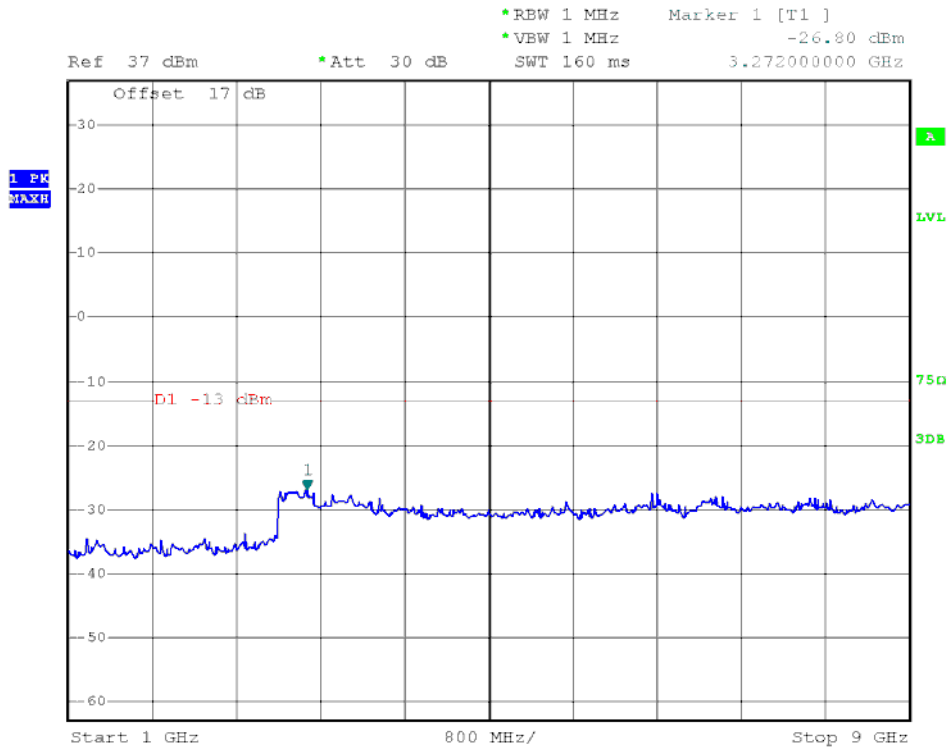

(Plot A1.1: GSM 850MHz Channel = 128, 1GHz to 9GHz)

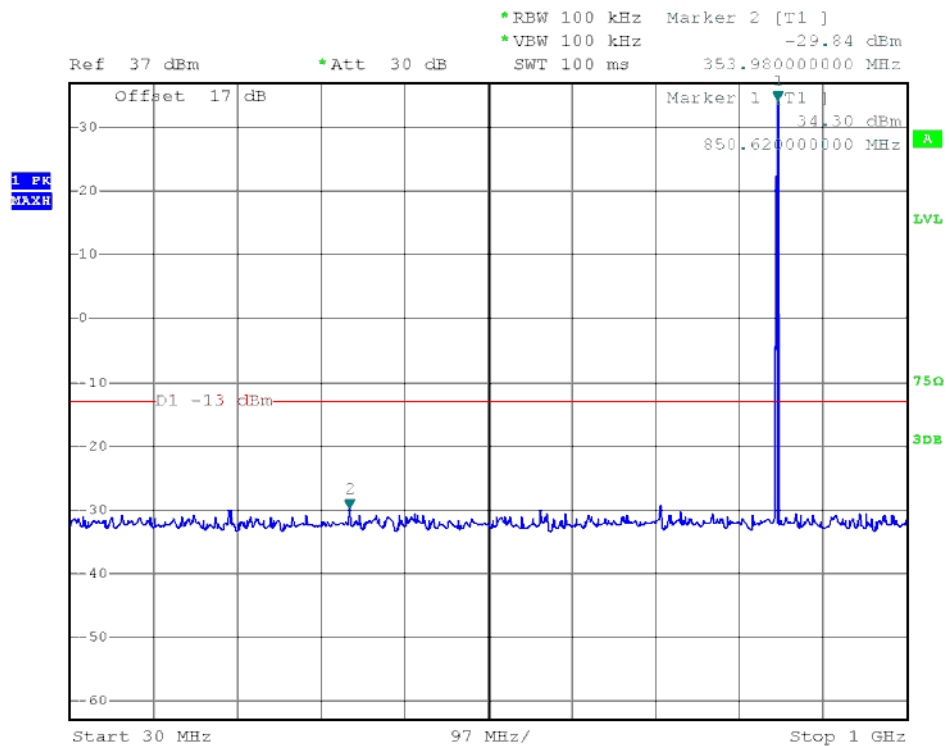

(Plot A2: GSM 850MHz Channel = 190, 30MHz to 1GHz)

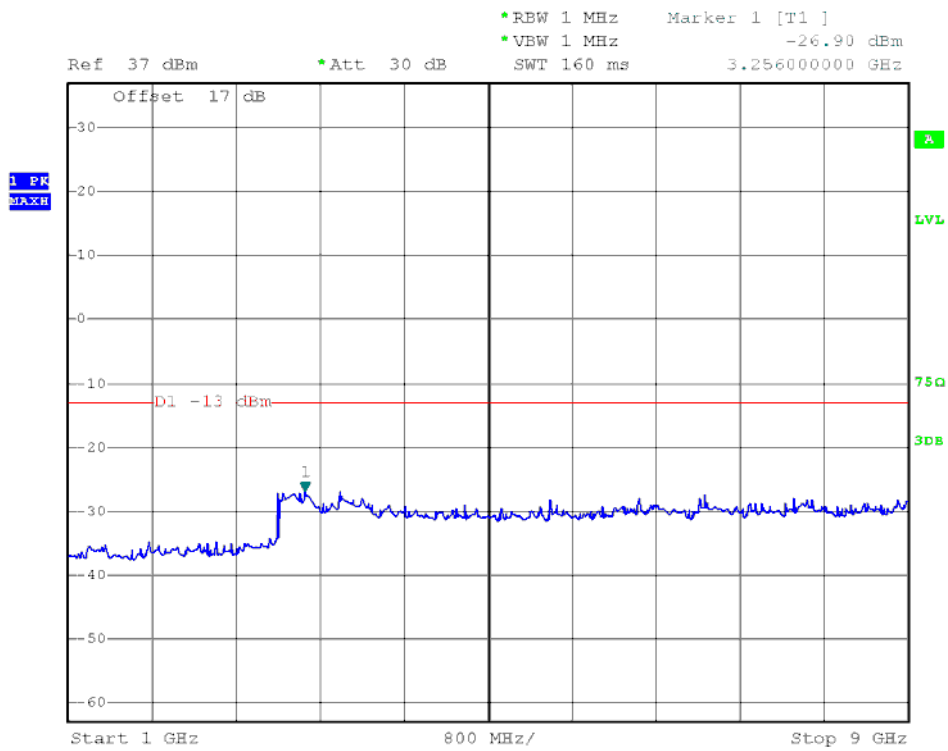

(Plot A2.1: GSM 850MHz Channel = 190, 1GHz to 9GHz)

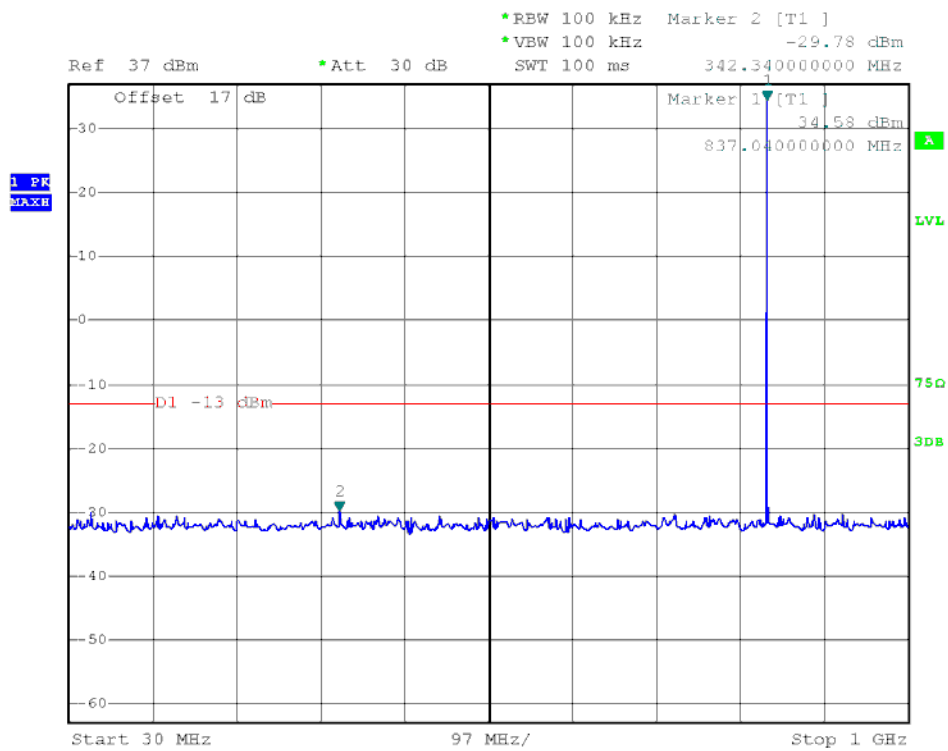

(Plot A3: GSM 850MHz Channel = 251, 30MHz to 1GHz)

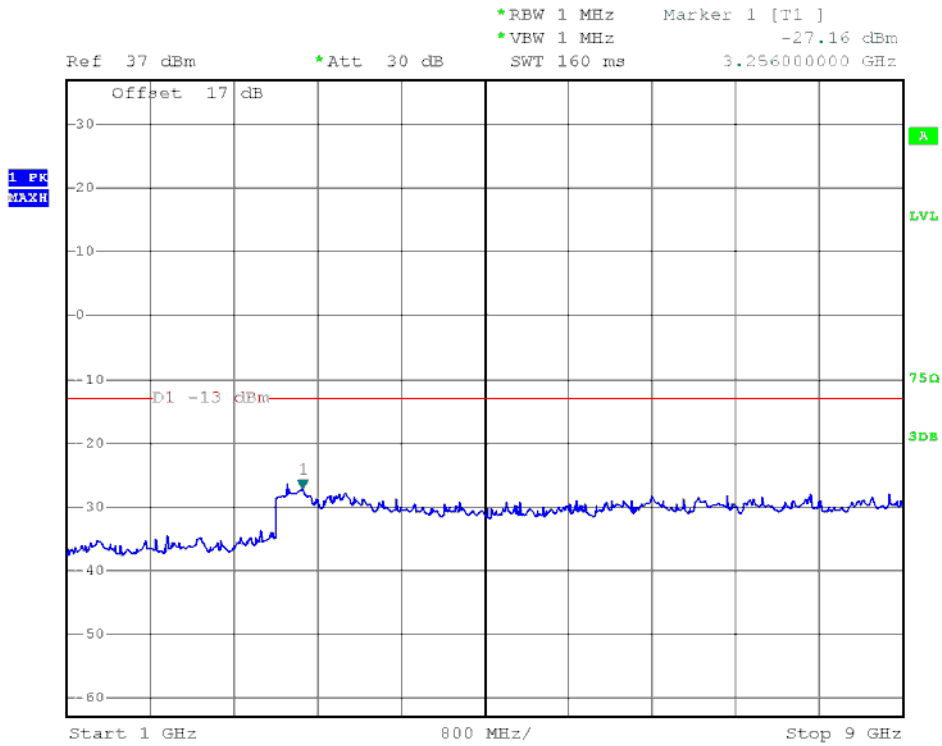

(Plot A3.1: GSM 850MHz Channel = 251, 1GHz to 9GHz)

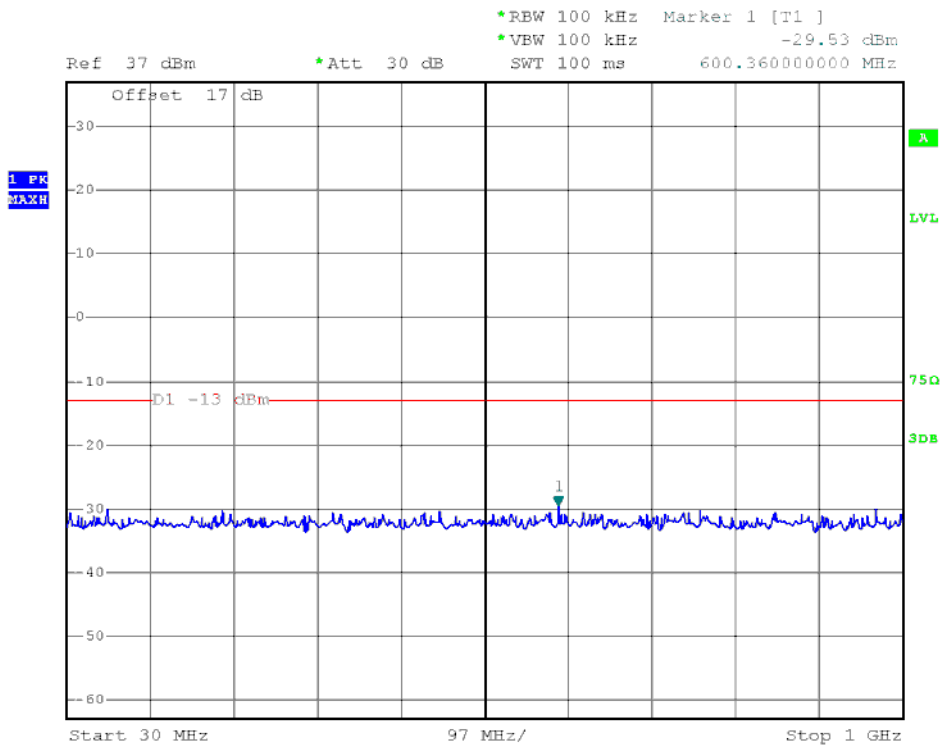

(Plot B1: GSM 1900MHz Channel = 512, 30MHz to 1GHz)

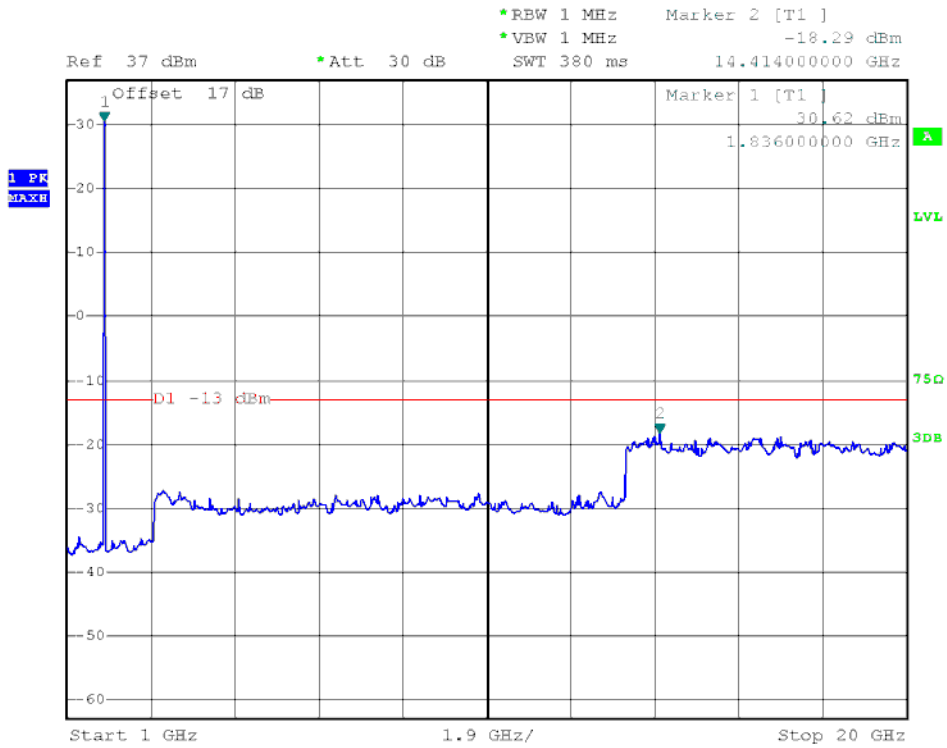

(Plot B1.1: GSM 1900MHz Channel = 512, 1GHz to 20GHz)

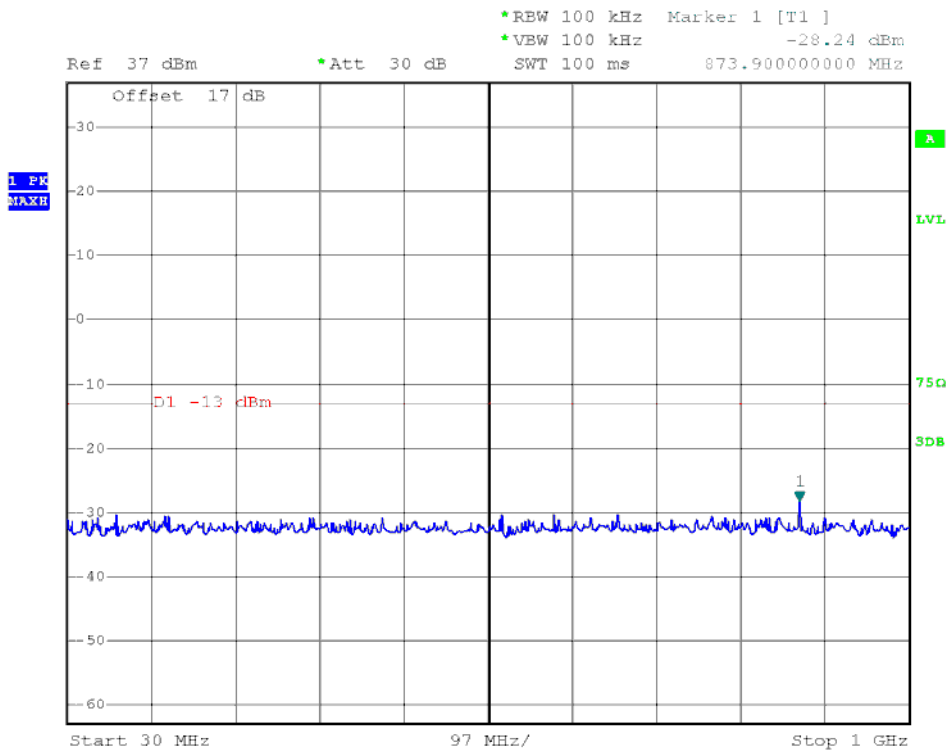

(Plot B2: GSM 1900MHz Channel = 661, 30MHz to 1GHz)

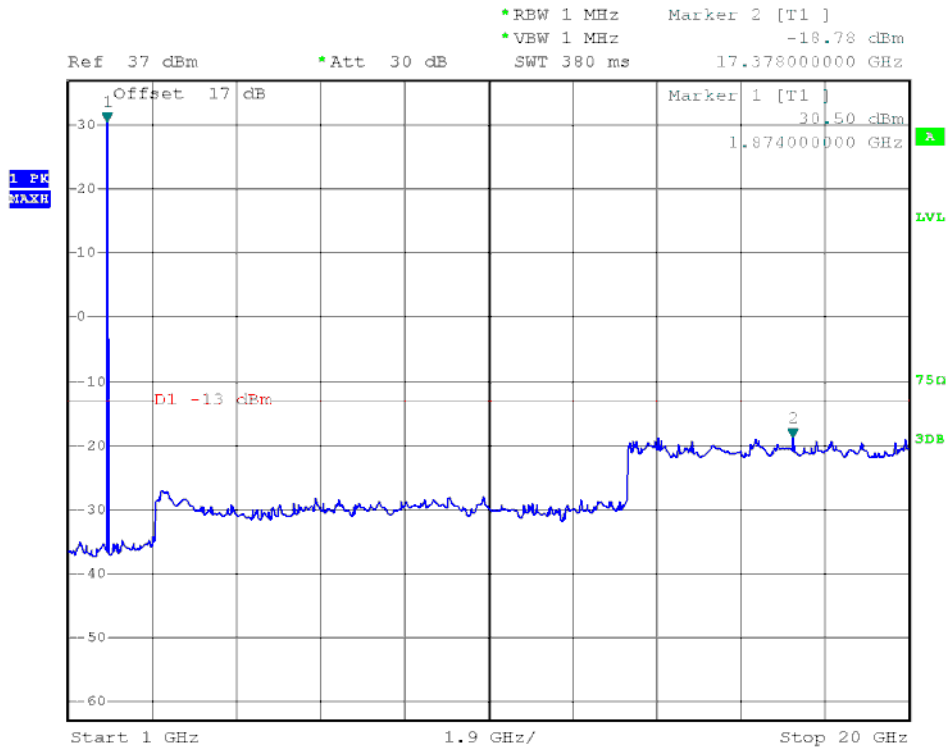

(Plot B2.1: GSM 1900MHz Channel = 661, 1GHz to 20GHz)

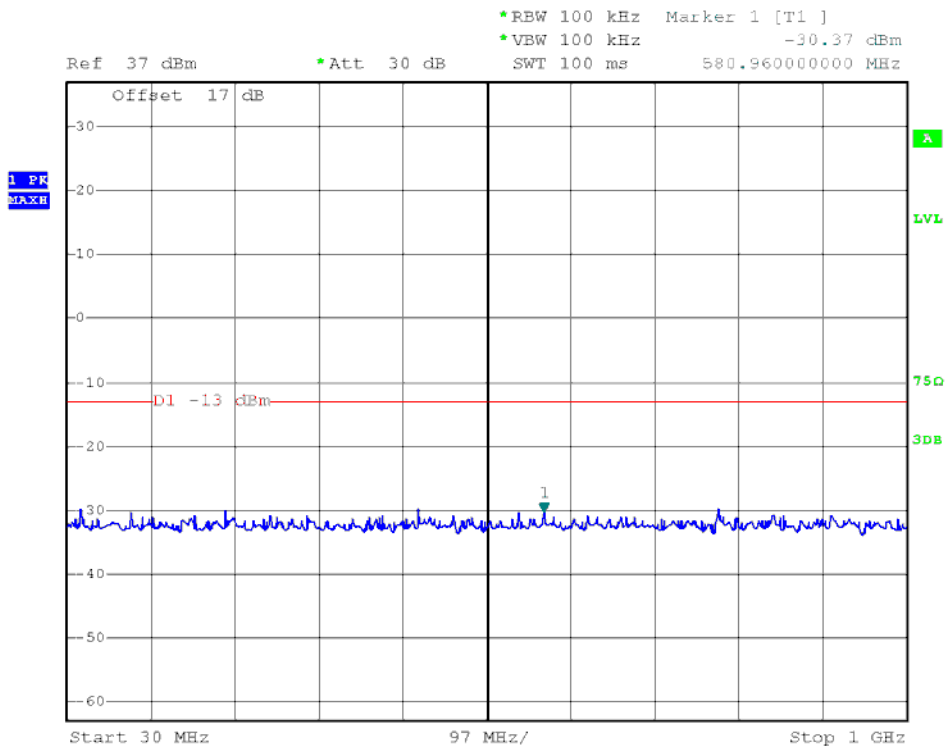

(Plot B3: GSM 1900MHz Channel = 810, 30MHz to 1GHz)

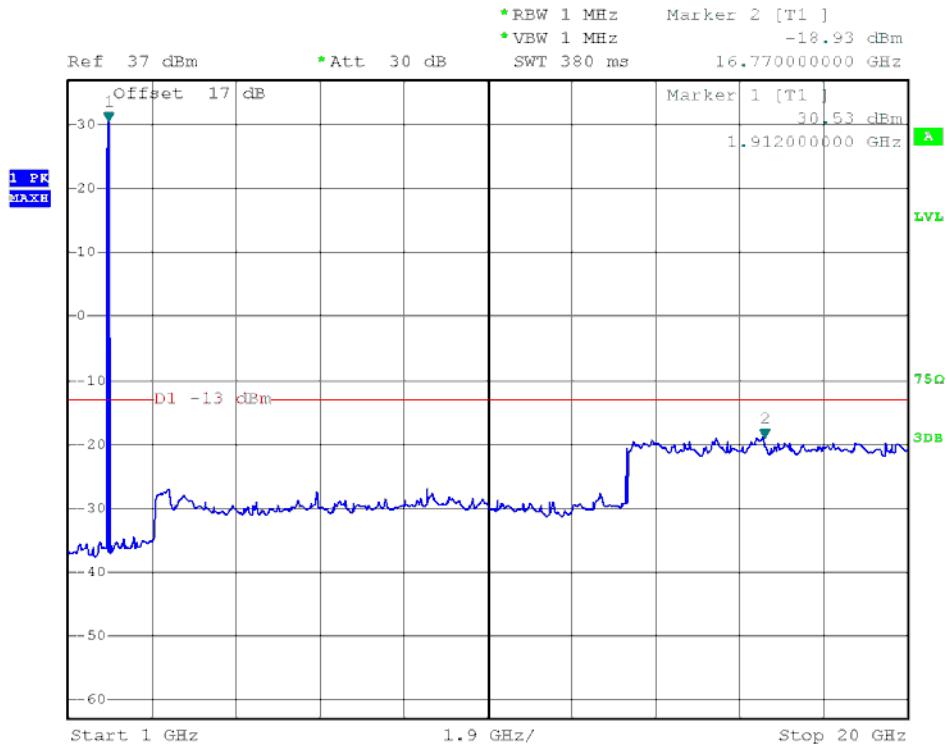

(Plot B3.1: GSM 1900MHz Channel = 810, 1GHz to 20GHz)

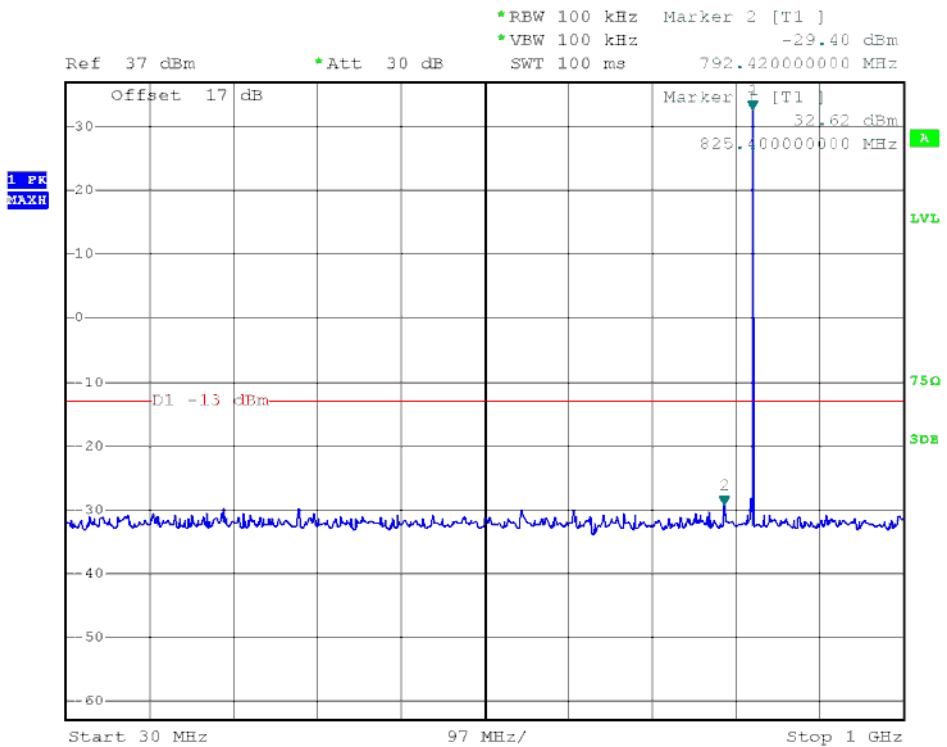

(Plot C1: EDGE 850MHz Channel = 128, 30MHz to 1GHz)

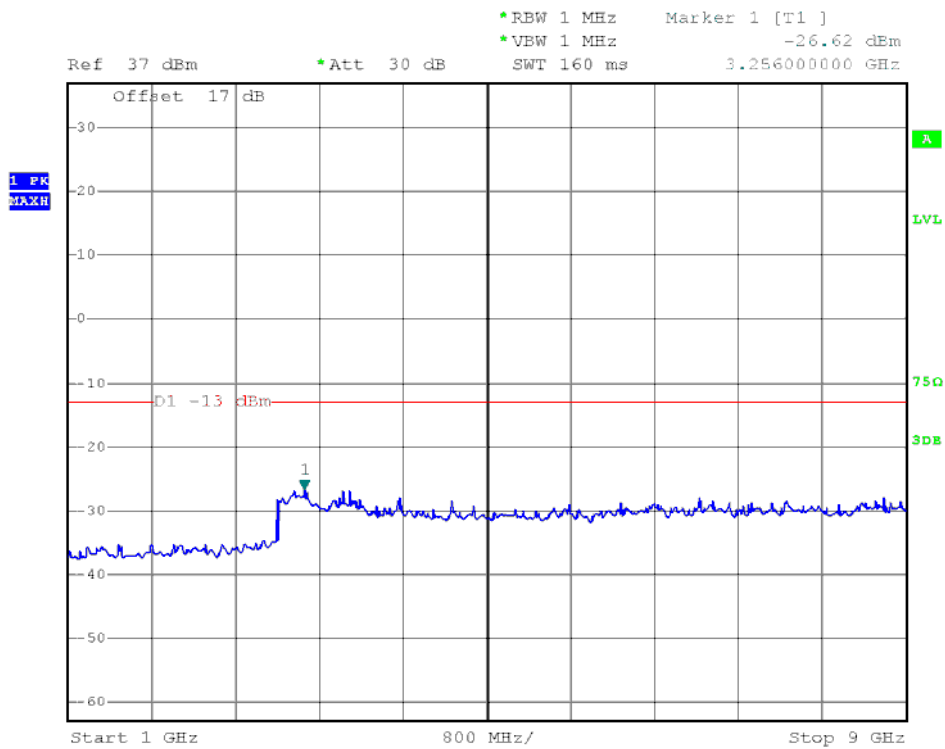

(Plot C1.1: EDGE 850MHz Channel = 128, 1GHz to 9GHz)

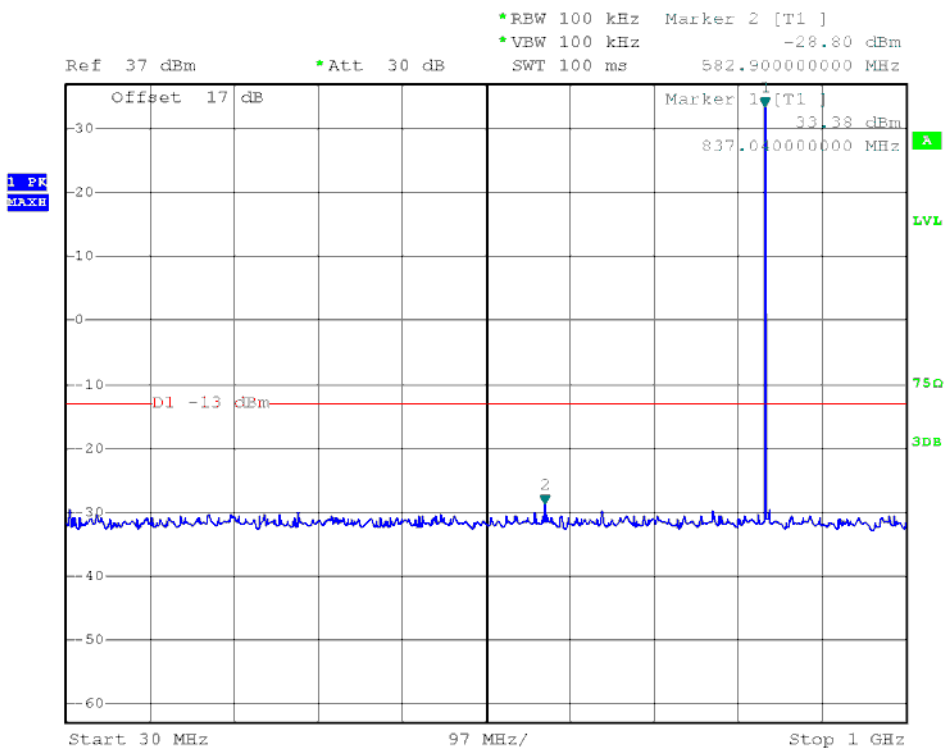

(Plot C2: EDGE 850MHz Channel = 190, 30MHz to 1GHz)

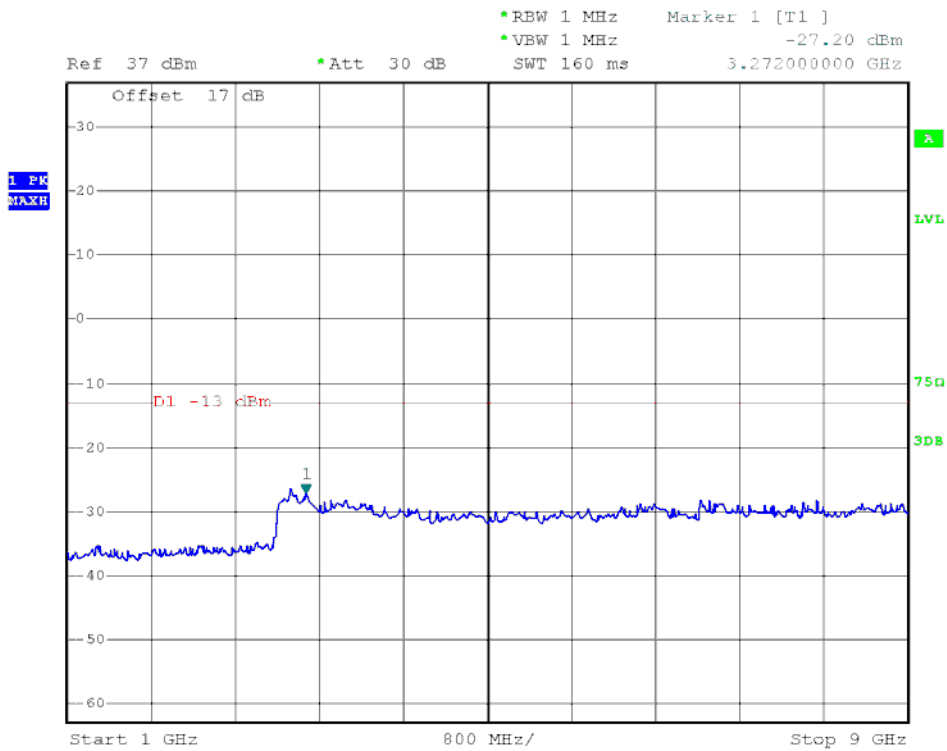

(Plot C2.1: EDGE 850MHz Channel = 190, 1GHz to 9GHz)

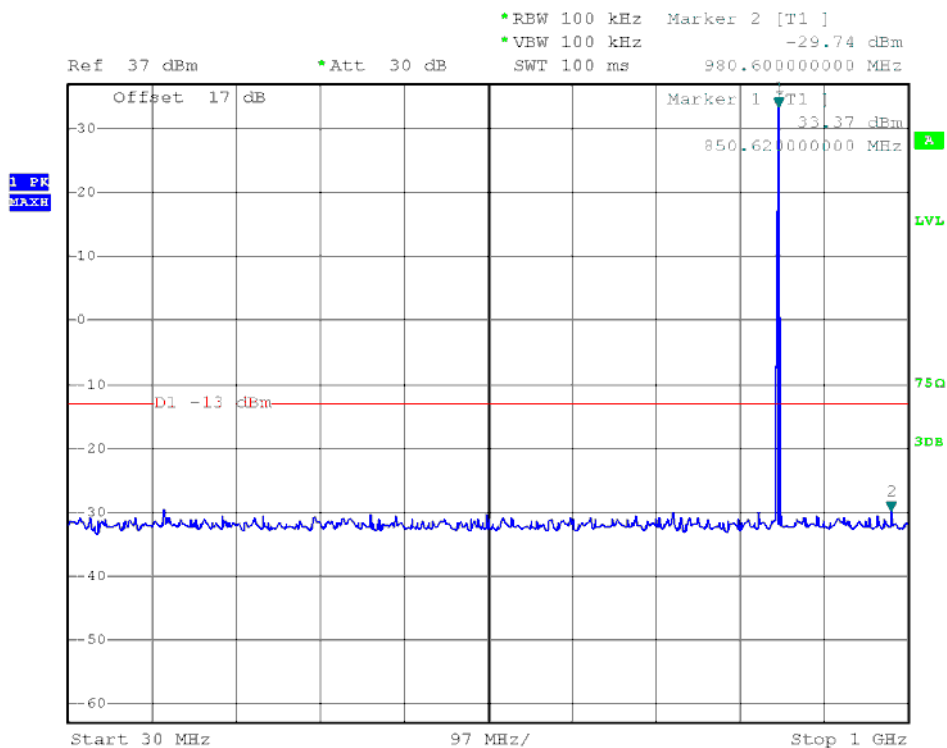

(Plot C3: EDGE 850MHz Channel = 251, 30MHz to 1GHz)

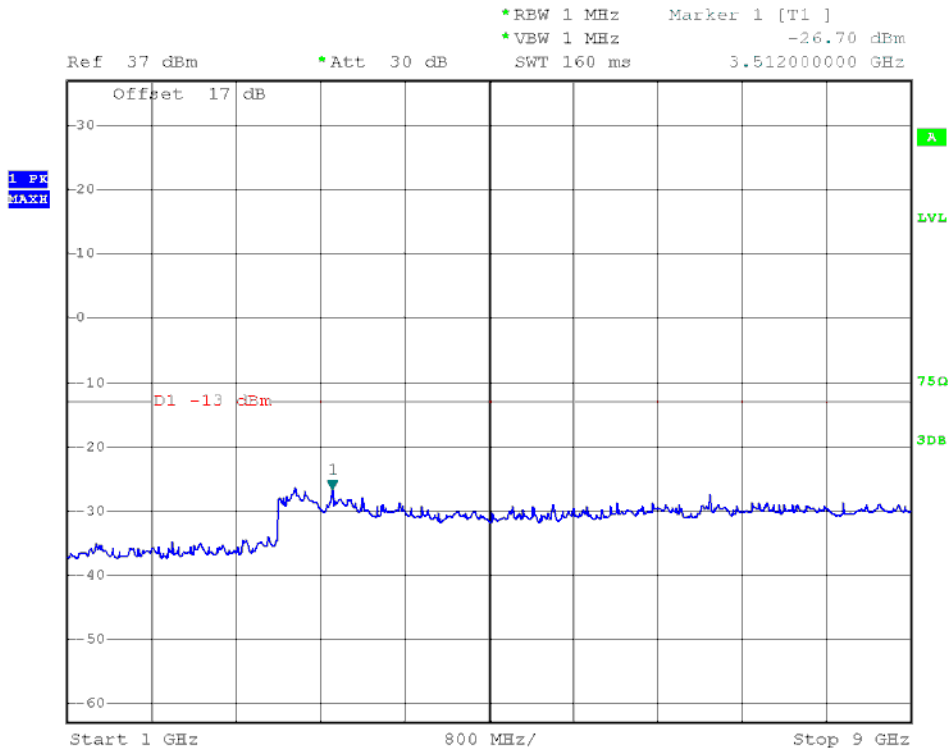

(Plot C3.1: EDGE 850MHz Channel = 251, 1GHz to 9GHz)

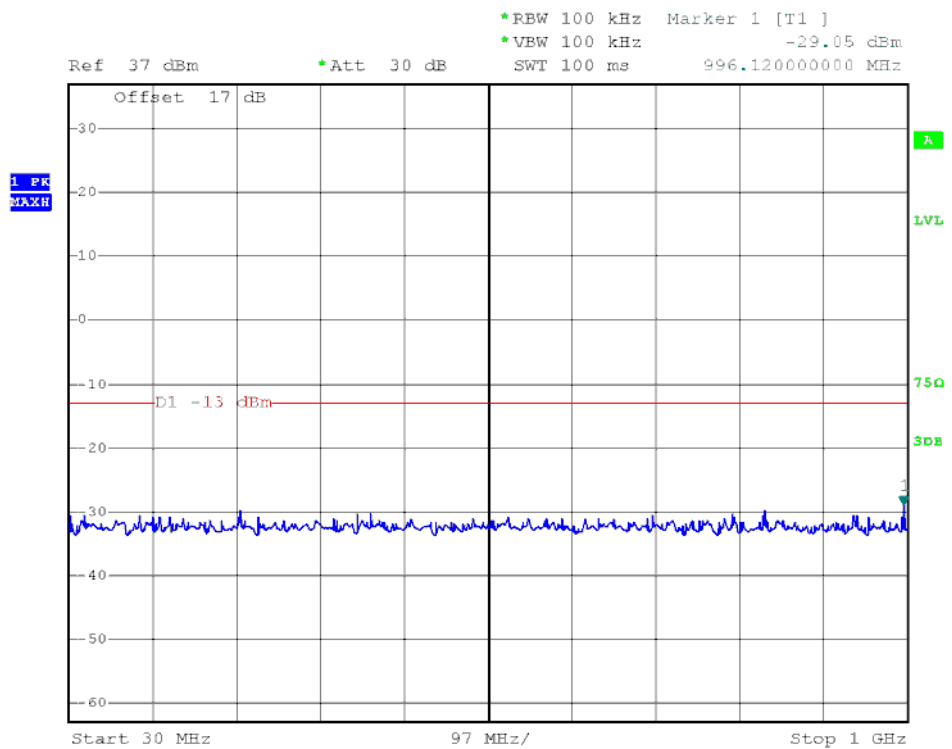

(Plot D1: EDGE 1900MHz Channel = 512, 30MHz to 1GHz)

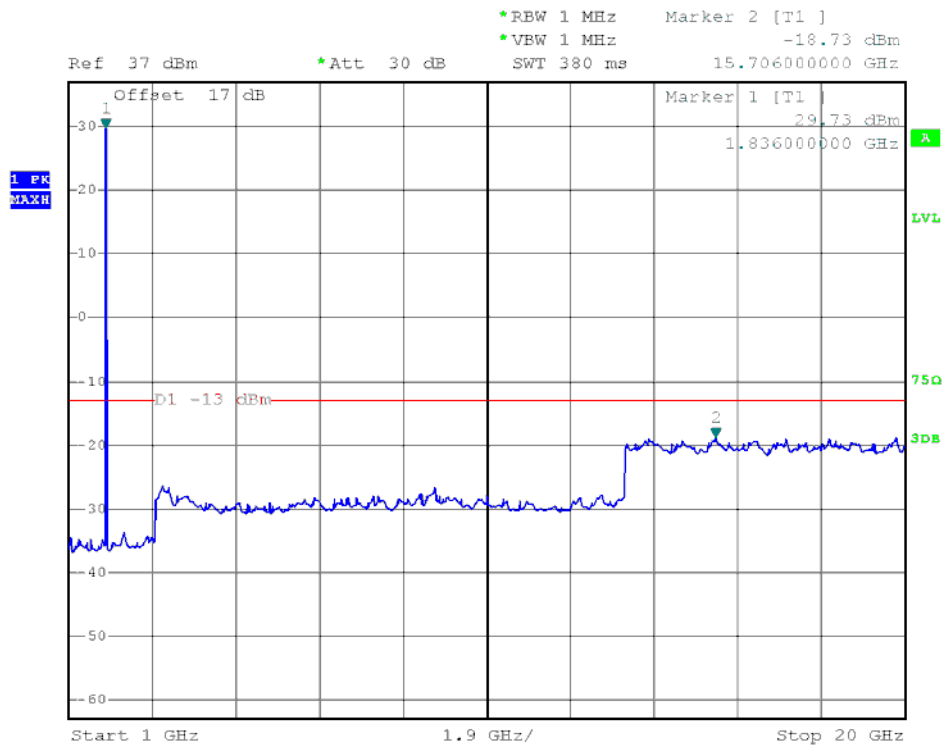

(Plot D1.1: EDGE 1900MHz Channel = 512, 1GHz to 20GHz)

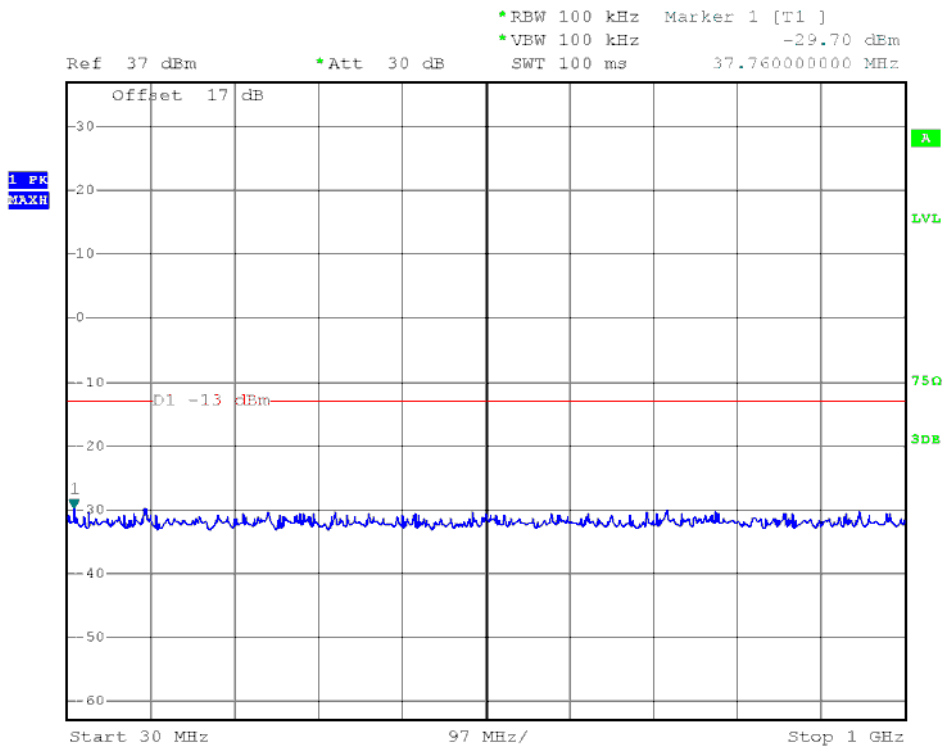

(Plot D2: EDGE 1900MHz Channel = 661, 30MHz to 1GHz)

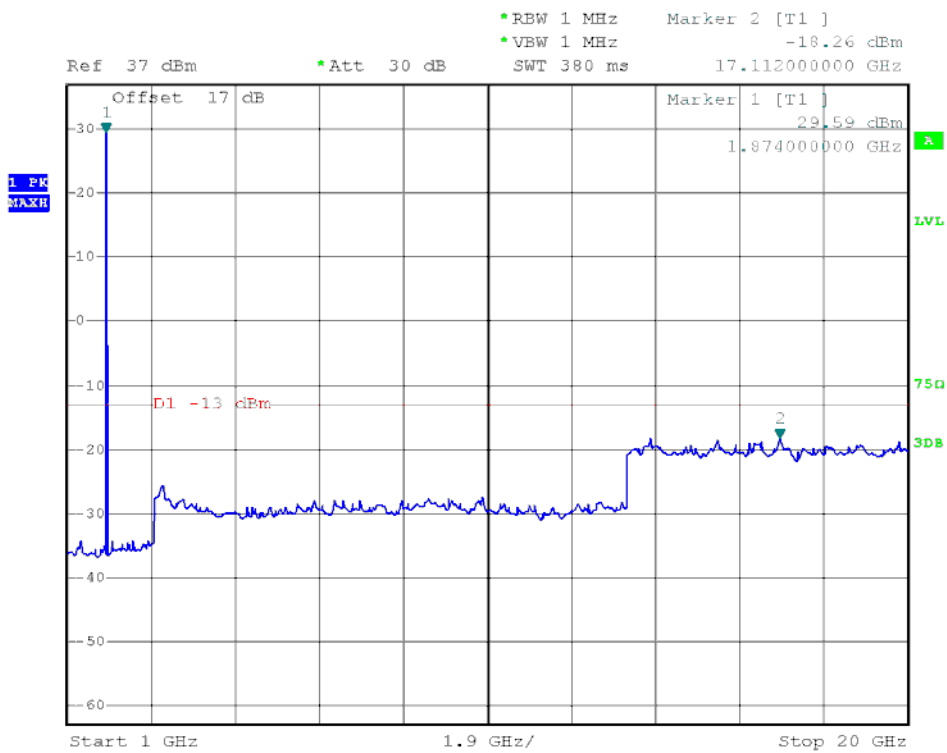

(Plot D2.1: EDGE 1900MHz Channel = 661, 1GHz to 20GHz)

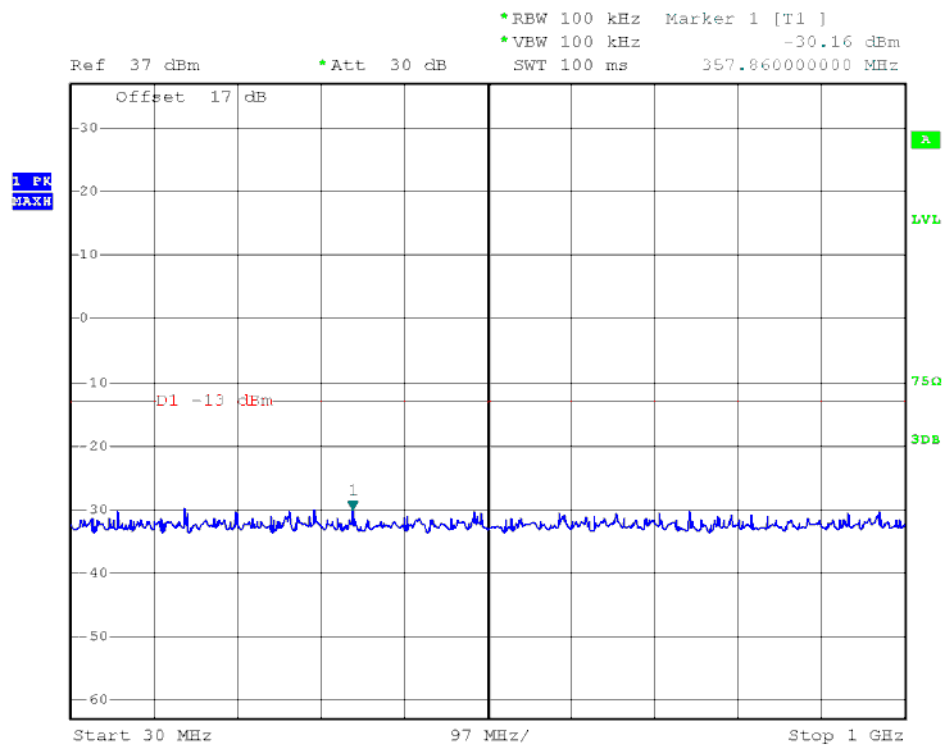

(Plot D3: EDGE 1900MHz Channel = 810, 30MHz to 1GHz)

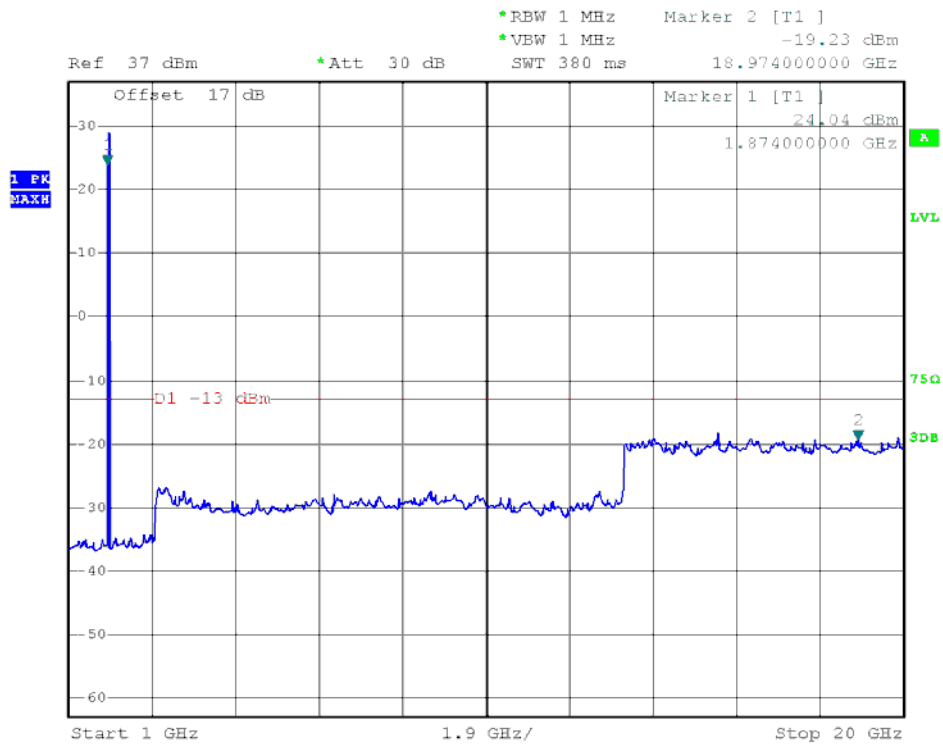

(Plot D3.1: EDGE 1900MHz Channel = 810, 1GHz to 20GHz)

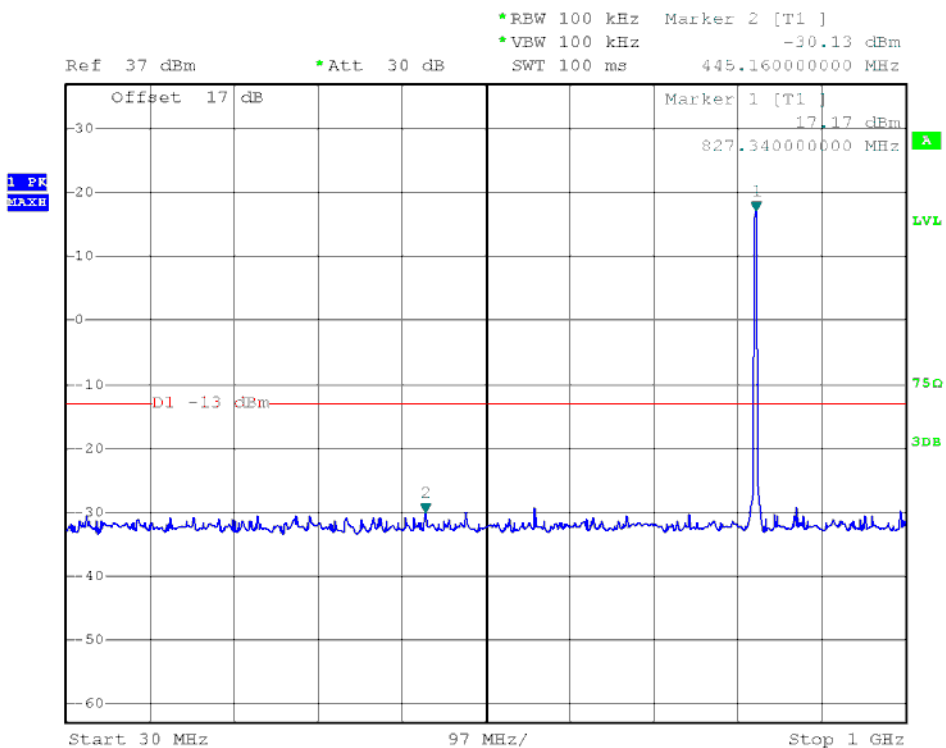

(Plot E1: WCDMA850MHz Channel = 4132, 30MHz to 1GHz)

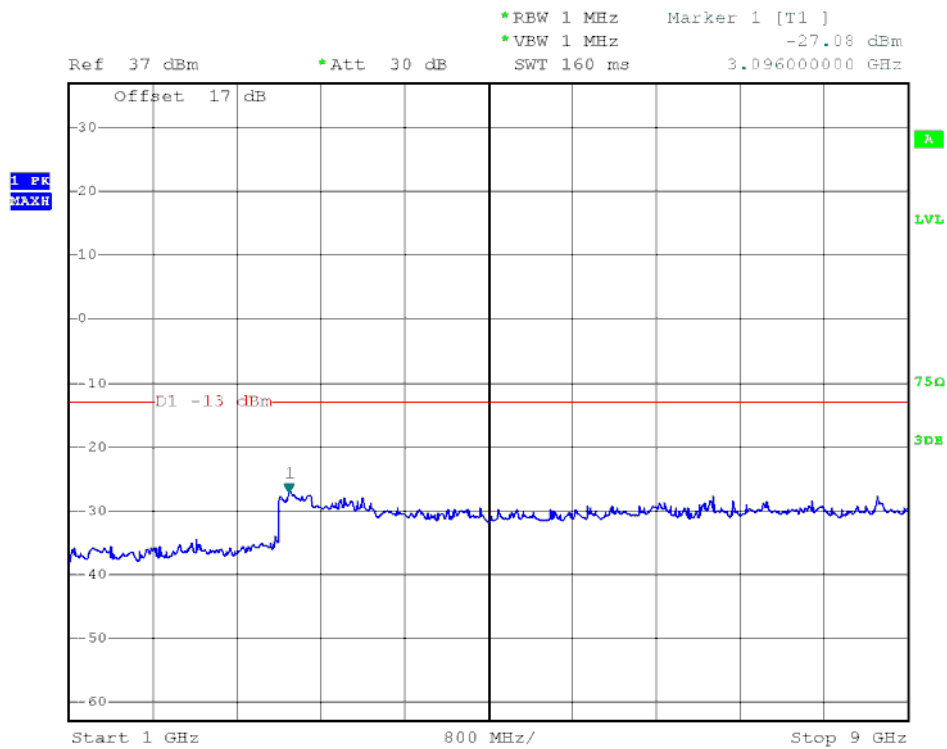

(Plot E1.1: WCDMA850MHz Channel = 4132, 1GHz to 9GHz)

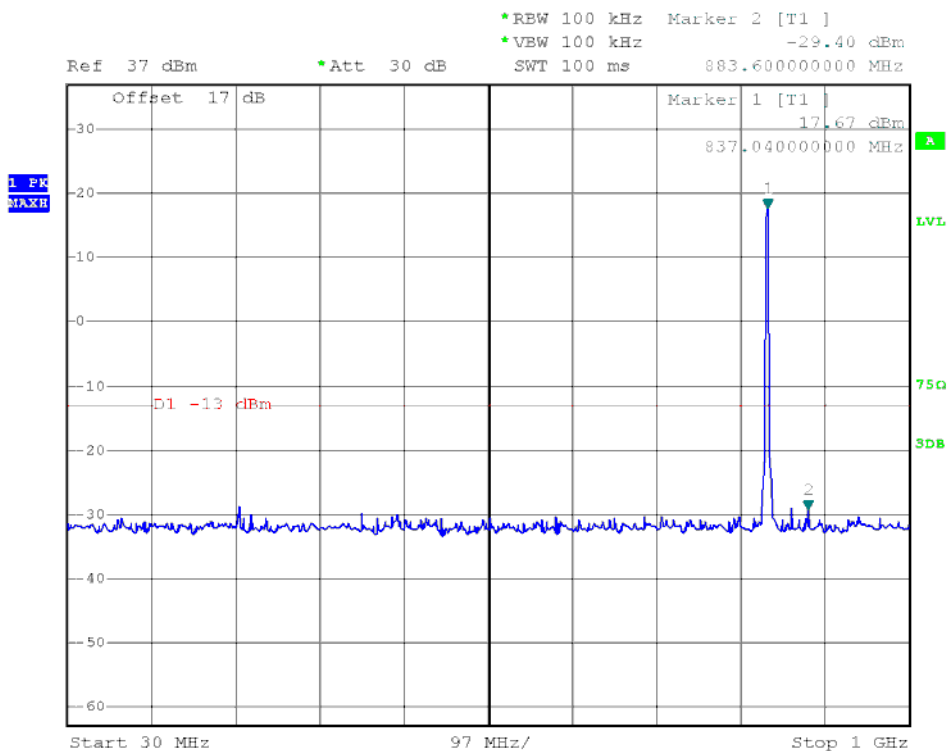

(Plot E2: WCDMA850MHz Channel = 4183, 30MHz to 1GHz)

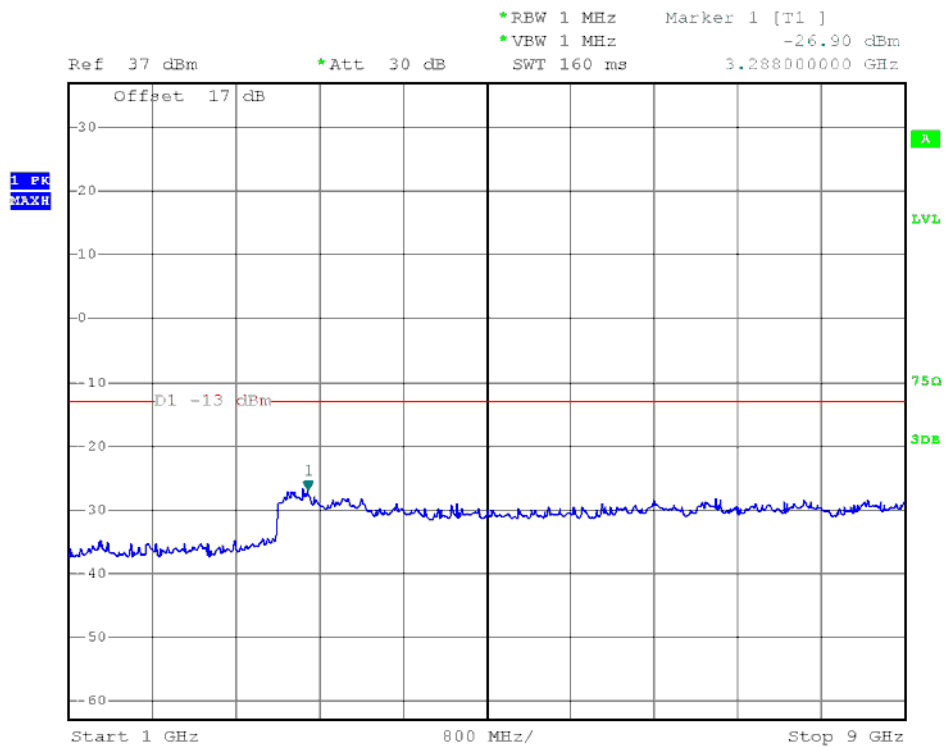

(Plot E2.1: WCDMA850MHz Channel = 4183, 1GHz to 9GHz)

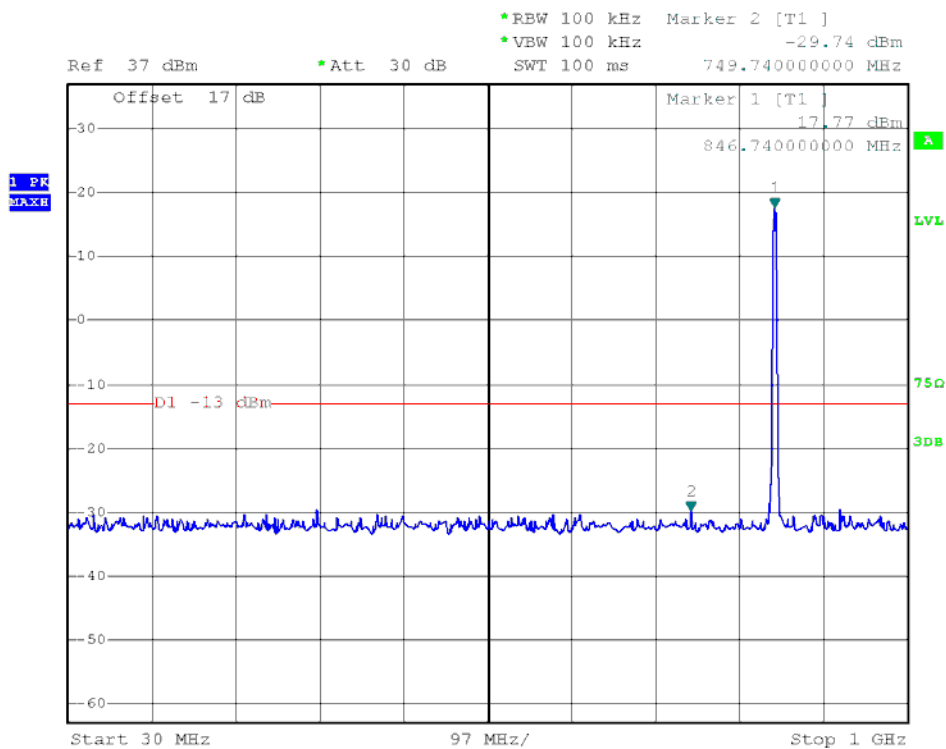

(Plot E3: WCDMA850MHz Channel = 4233, 30MHz to 1GHz)

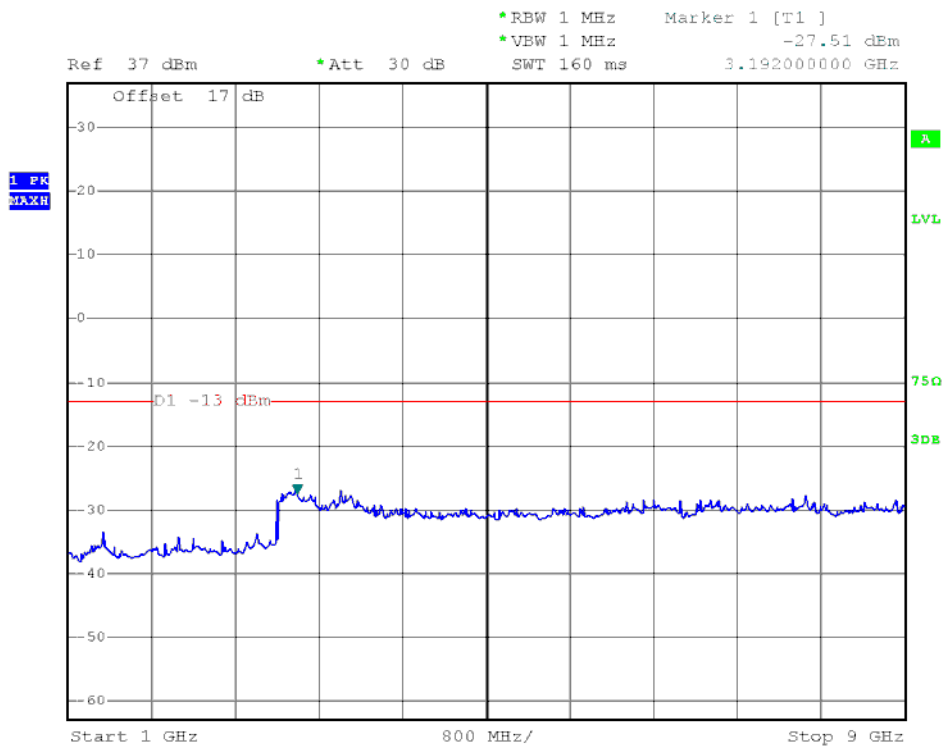

(Plot E3.1: WCDMA850MHz Channel = 4233, 1GHz to 9GHz)

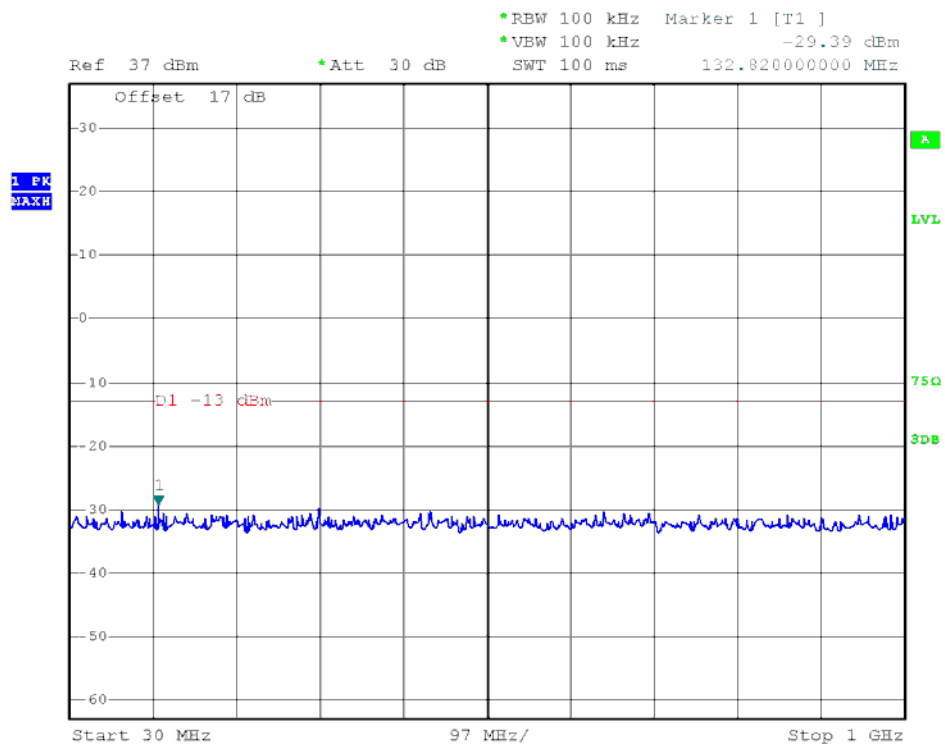

(Plot F1: WCDMA1900MHz Channel = 9262, 30MHz to 1GHz)

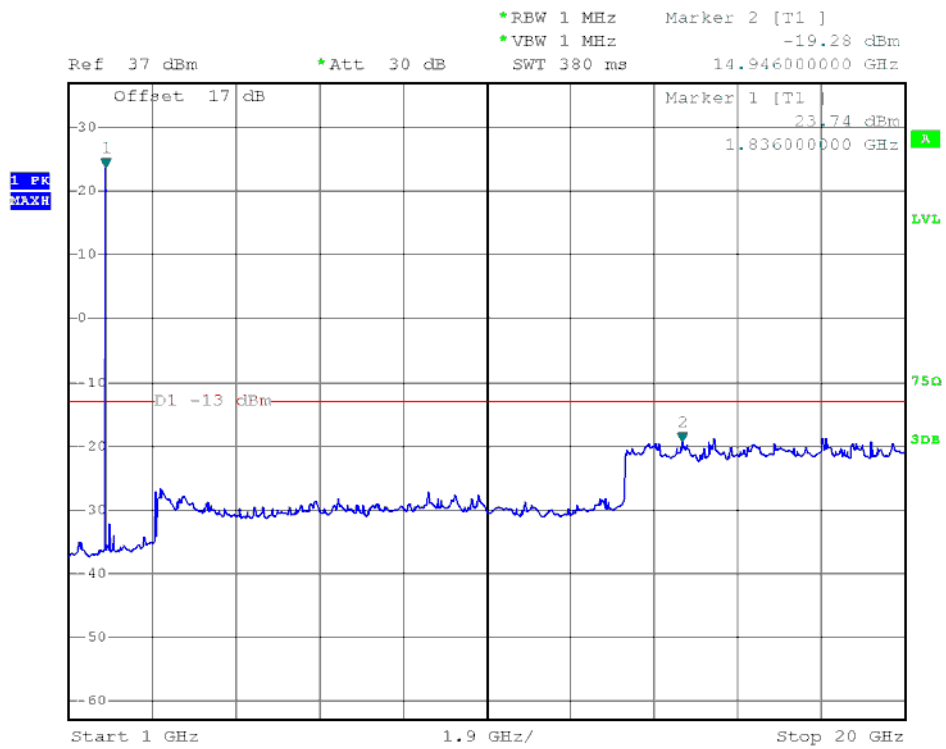

(Plot F1.1: WCDMA1900MHz Channel = 9262, 1GHz to 20GHz)

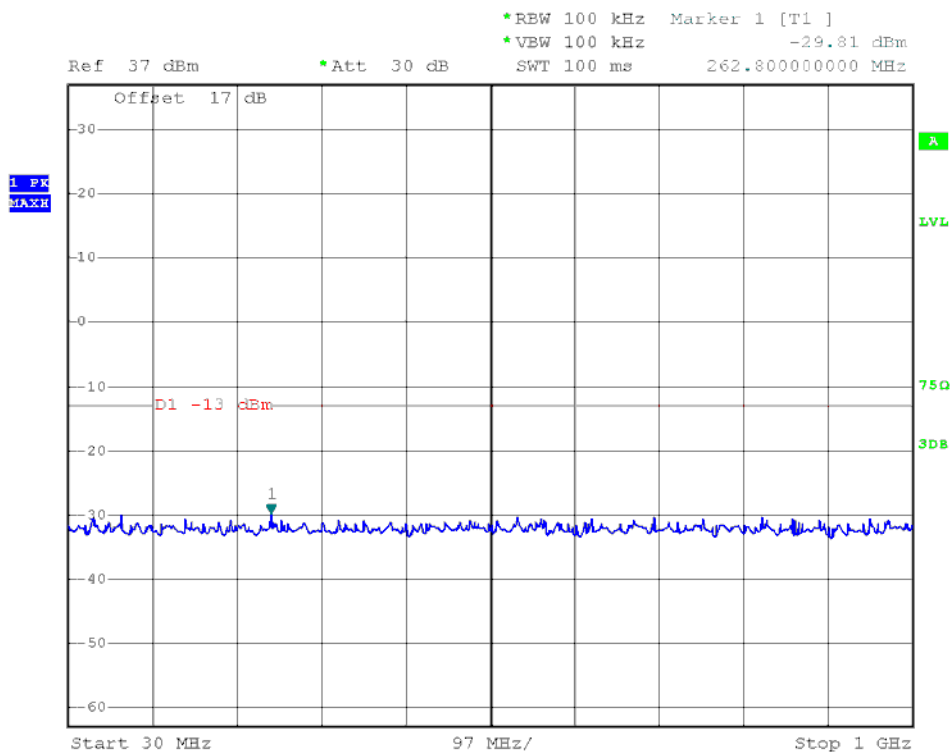

(Plot F2: WCDMA1900MHz Channel = 9400, 30MHz to 1GHz)

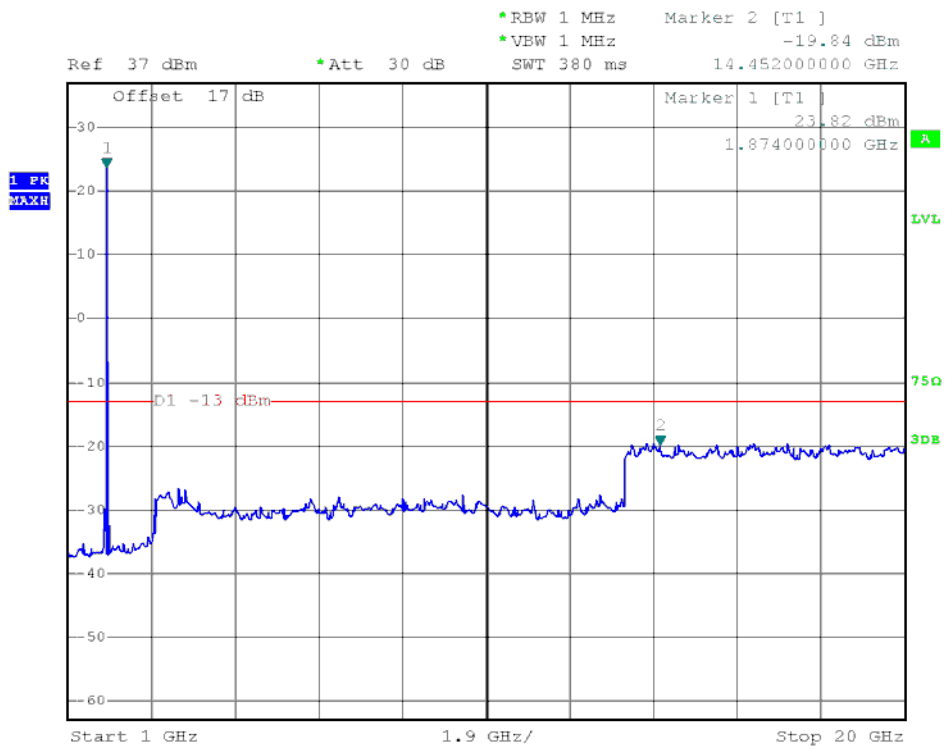

(Plot F2.1: WCDMA1900MHz Channel = 9400, 1GHz to 20GHz)

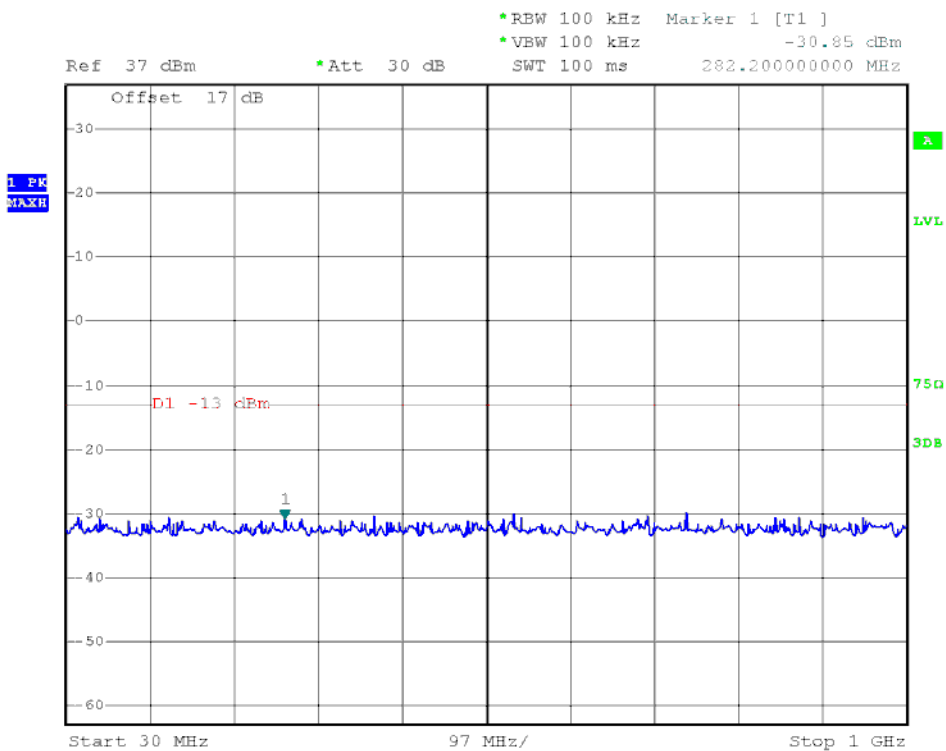

(Plot F3: WCDMA1900MHz Channel = 9538, 30MHz to 1GHz)

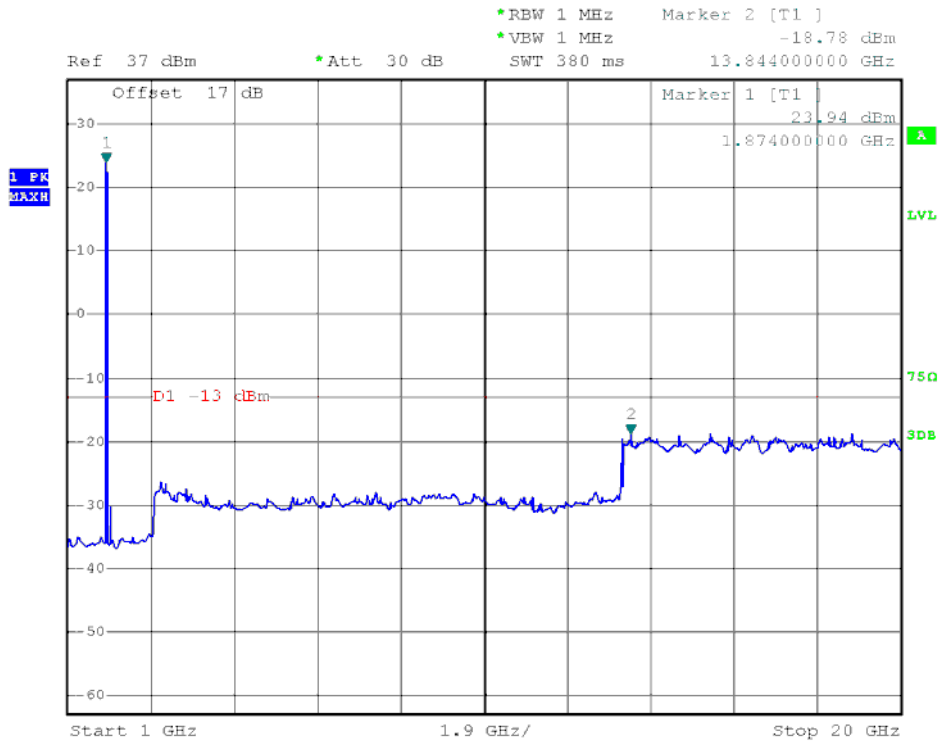

(Plot F3.1: WCDMA1900MHz Channel = 9538 1GHz to 20GHz)



2.6 Band Edge

2.6.1 Requirement

According to FCC section 22.917(b) and FCC section 24.238(b), in the 1MHz bands immediately outside and adjacent to the frequency block a resolution bandwidth of at least one percent of the emission bandwidth (26dB emission bandwidth) of the fundamental emission of the transmitter may be employed.

2.6.2 Test Description

See section 2.1.2 of this report.

2.6.3 Test Procedures

1. The testing follows FCC KDB 971168 v02r01 Section 6.0.
2. The EUT was connected to the spectrum analyzer and system simulator via a power divider.
3. The RF output of EUT was connected to the spectrum analyzer by an RF cable and attenuator
The path loss was compensated to the results for each measurement.
4. The band edges of low and high channels for the highest RF powers were measured.
5. The RF fundamental frequency should be excluded against the limit line in the operating frequency band.
6. The limit line is derived from $43 + 10\log(P)$ dB below the transmitter power P(Watts)
 $= P(W) - [43 + 10\log(P)]$ (dB)
 $= [30 + 10\log(P)]$ (dBm) - $[43 + 10\log(P)]$ (dB)
 $= -13\text{dBm}$.

2.6.4 Test Result

The lowest and highest channels are tested to verify the band edge emissions.

1. Test Verdict:

Band	Channel	Frequency (MHz)	Measured Max. Band Edge Emission (dBm)	Refer to Plot	Limit (dBm)	Verdict
GSM 850MHz	128	824.2	-14.40	Plat A	-13	PASS
	251	848.8	-14.60	Plot B		PASS
GSM 1900MHz	512	1850.2	-14.47	Plat C	-13	PASS
	810	1909.8	-15.37	Plot D		PASS
EDGE 850MHz	128	824.2	-13.51	Plat E	-13	PASS
	251	848.8	-14.96	Plot F		PASS
EDGE 1900MHz	512	1850.2	-14.38	Plat G	-13	PASS
	810	1909.8	-14.41	Plot H		PASS
WCDMA 850MHz	4132	826.4	-19.14	Plot I	-13	PASS
	4233	846.6	-17.22	Plot J		PASS



WCDMA	9262	1852.4	-22.29	Plot K	-13	PASS
1900MHz	9538	1907.6	-20.73	Plot L		PASS

2. Test Plots:

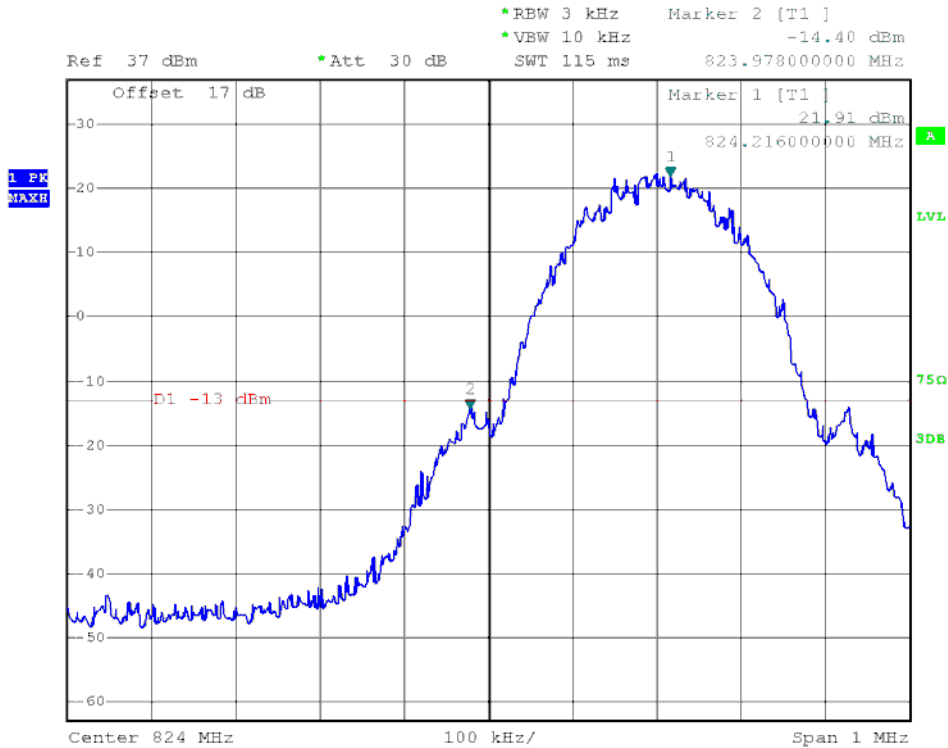

(Plot A: GSM 850 Channel = 128)

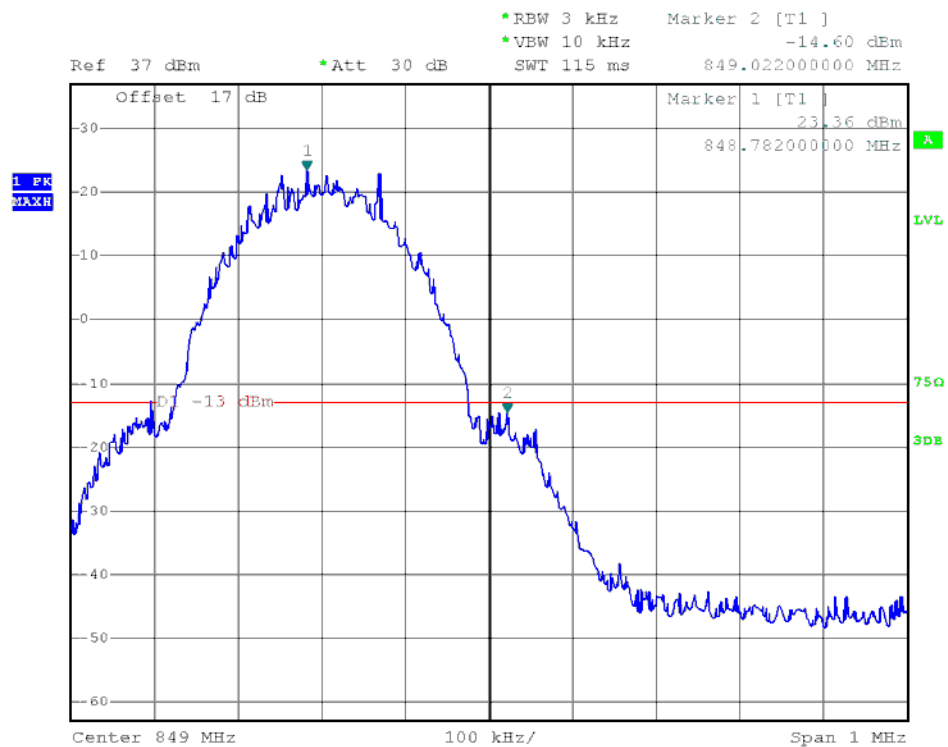

(Plot B: GSM 850 Channel = 251)

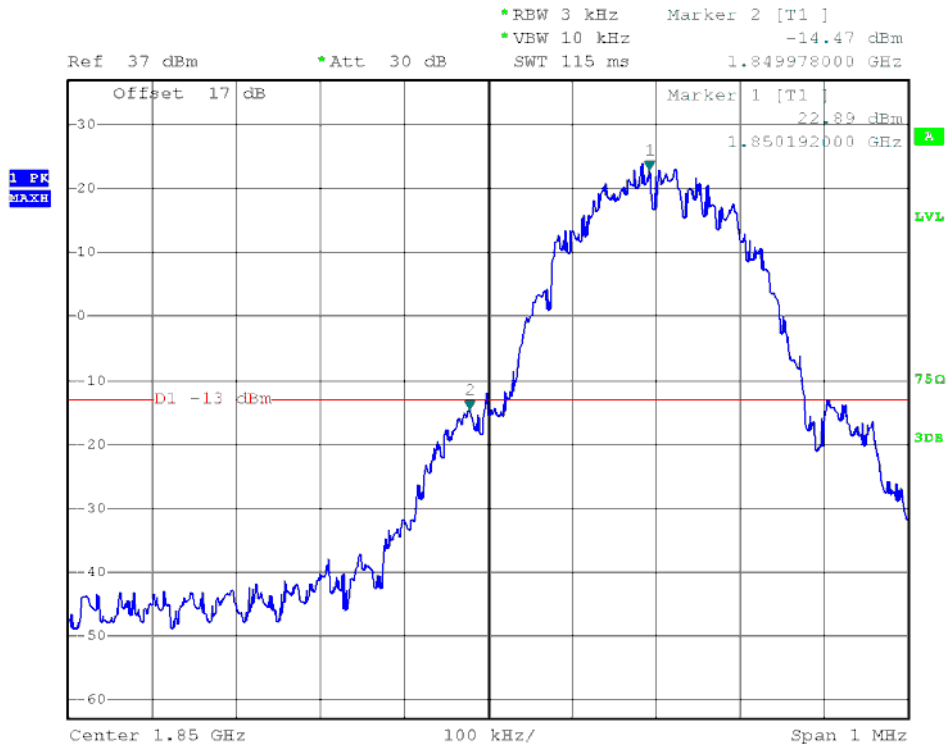

(Plot C: GSM 1900 Channel = 512)

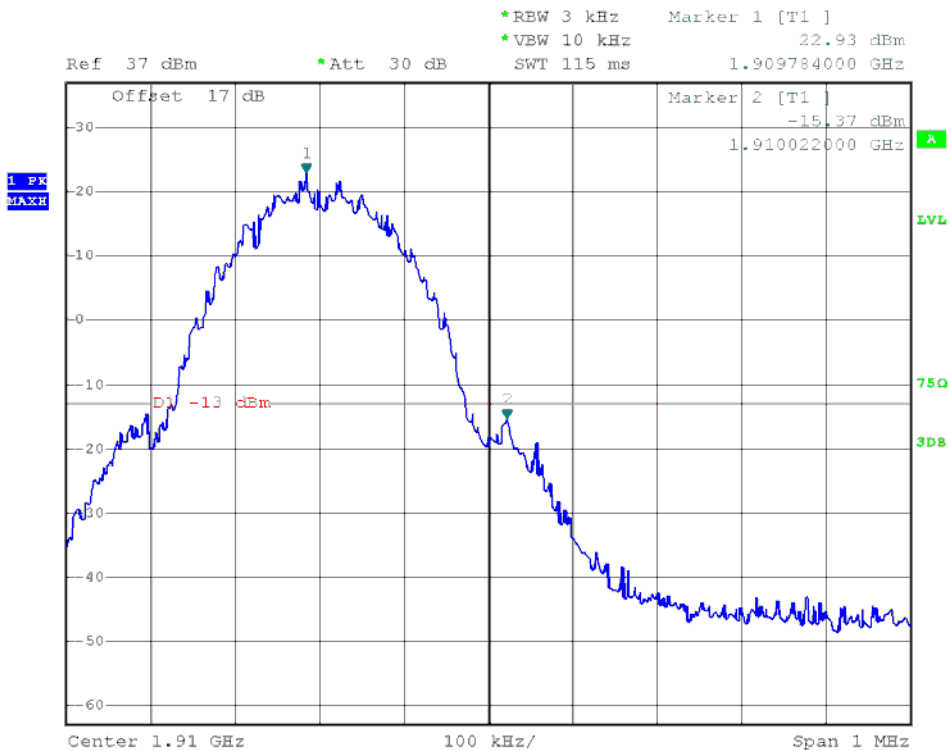

(Plot D: GSM 1900 Channel = 810)

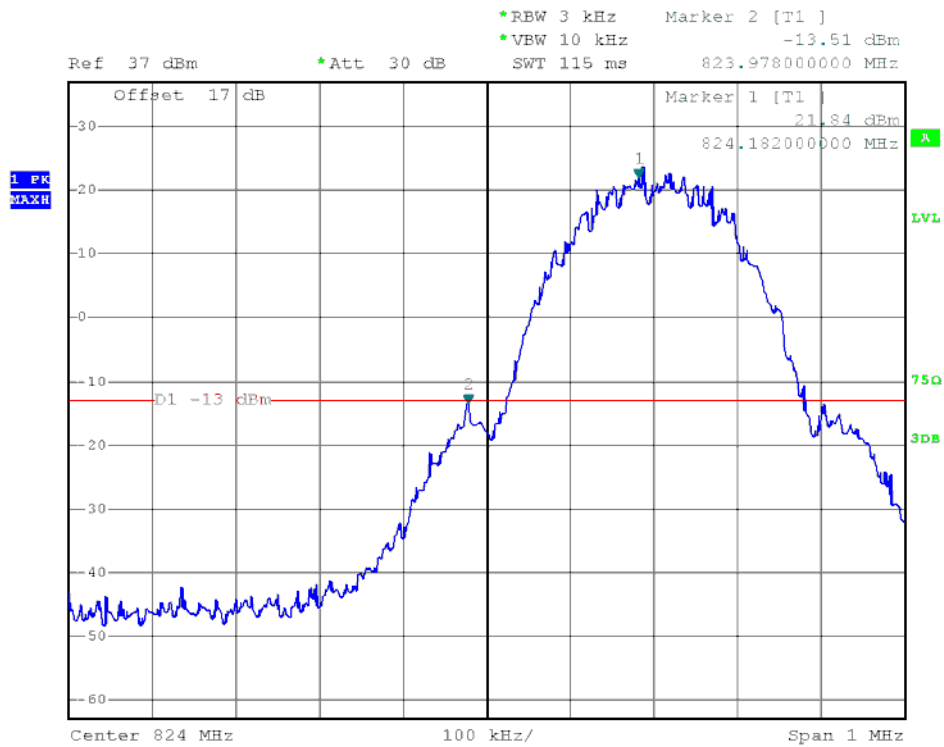

(Plot E: EDGE 850 Channel = 128)

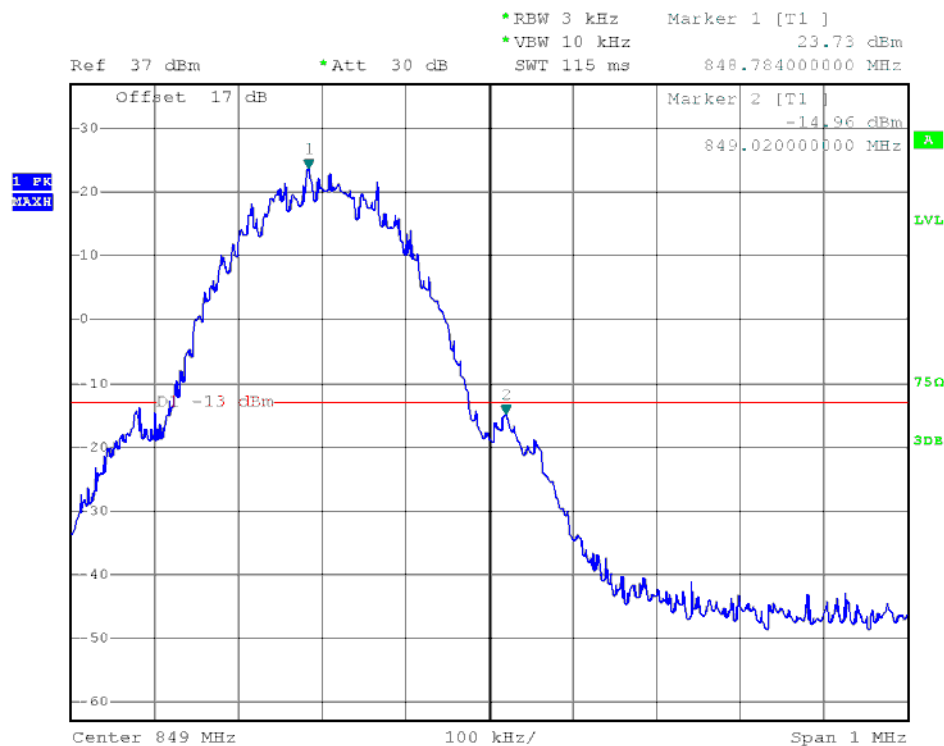

(Plot F: EDGE 850 Channel = 251)

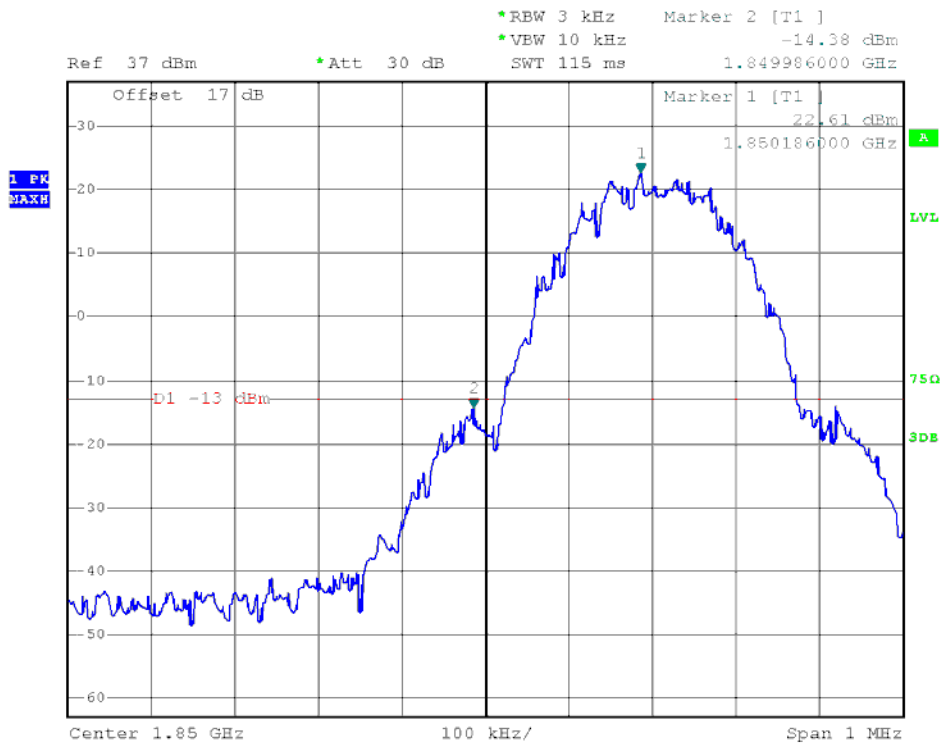

(Plot G: EDGE 1900 Channel = 512)

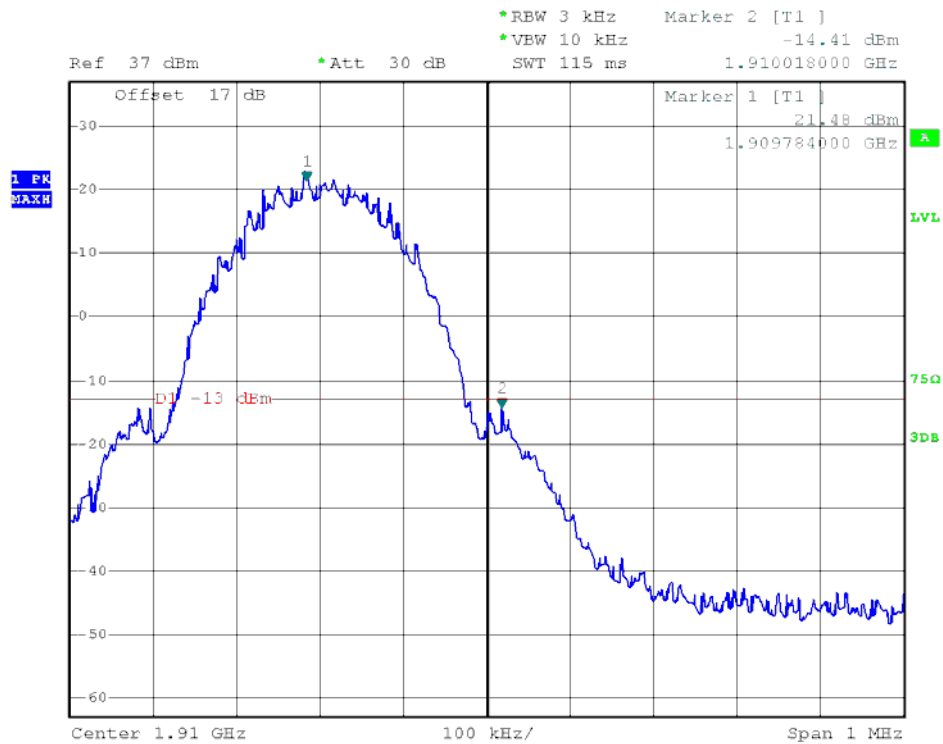

(Plot H: EDGE 1900 Channel = 810)

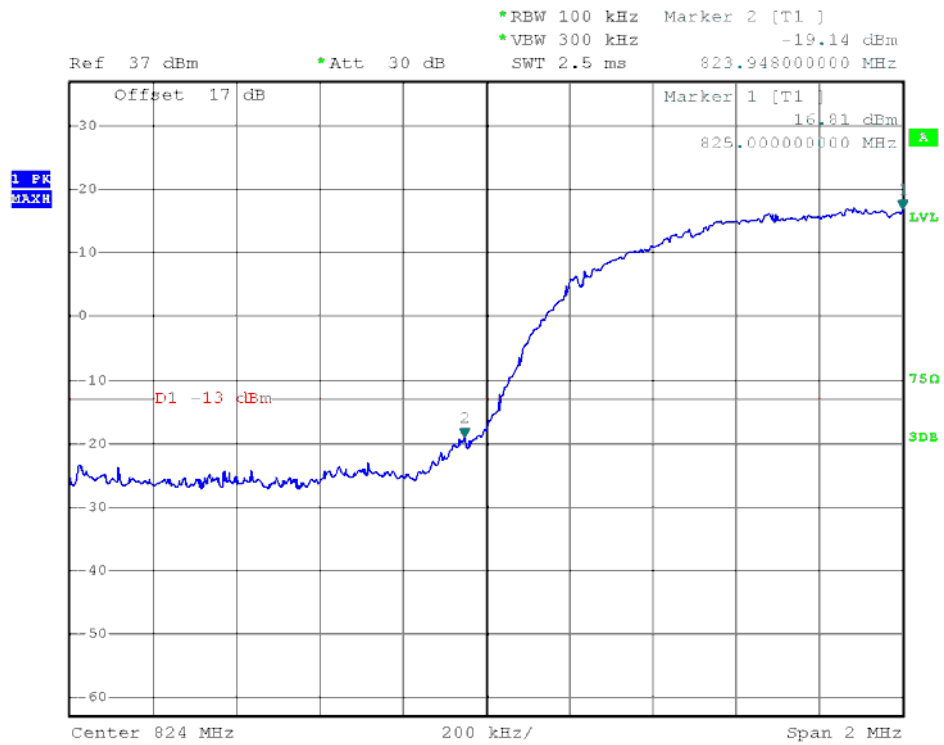

(Plot I: WCDMA 850 Channel = 4132)

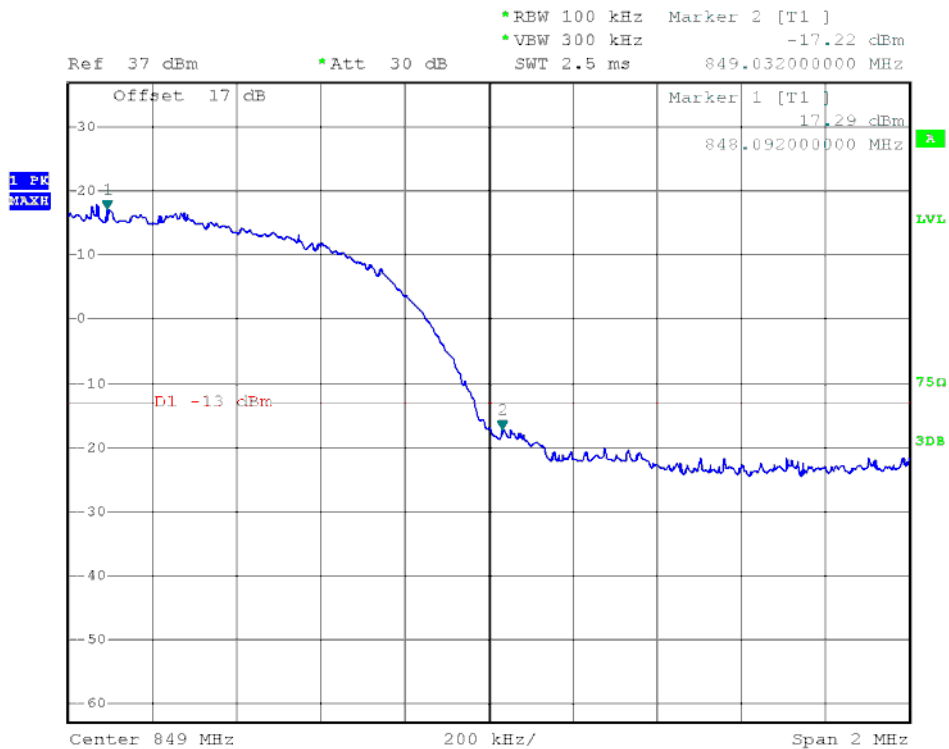

(Plot J: WCDMA 850 Channel = 4233)

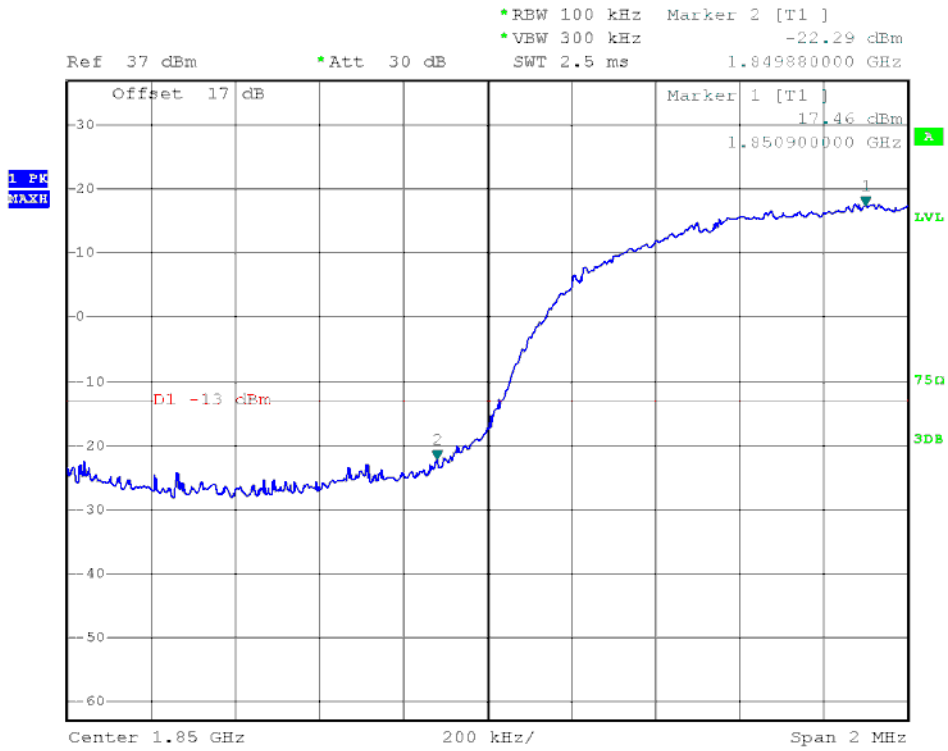

(Plot K: WCDMA 1900 Channel = 9262)

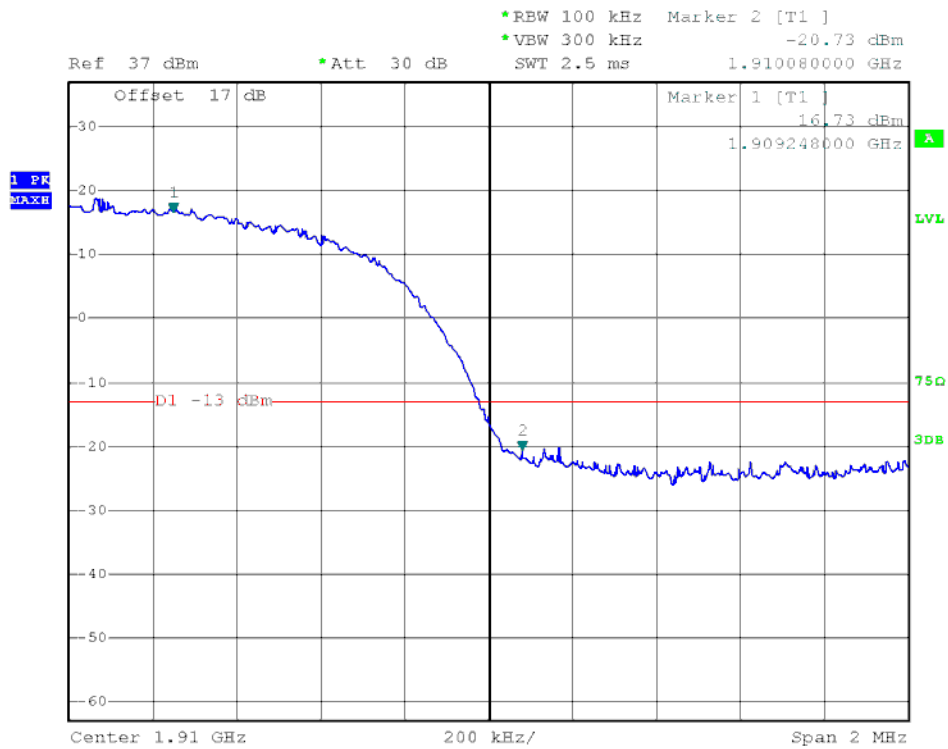

(Plot L: WCDMA 1900 Channel = 9538)

2.7 Transmitter Radiated Power (EIRP/ERP)

2.7.1 Requirement

The substitution method, in ANSI / TIA / EIA-603-C-2004, was used for ERP/EIRP measurement, and the spectrum analyzer configuration follows KDB 971168 D01 Power Meas. License Digital Systems v02r01. The ERP of mobile transmitters must not exceed 7 Watts (Cellular Band) and the EIRP of mobile transmitters are limited to 2 Watts (PCS Band) and 1 Watts (AWS Band).

2.7.2 Test Description

1. Test Setup:

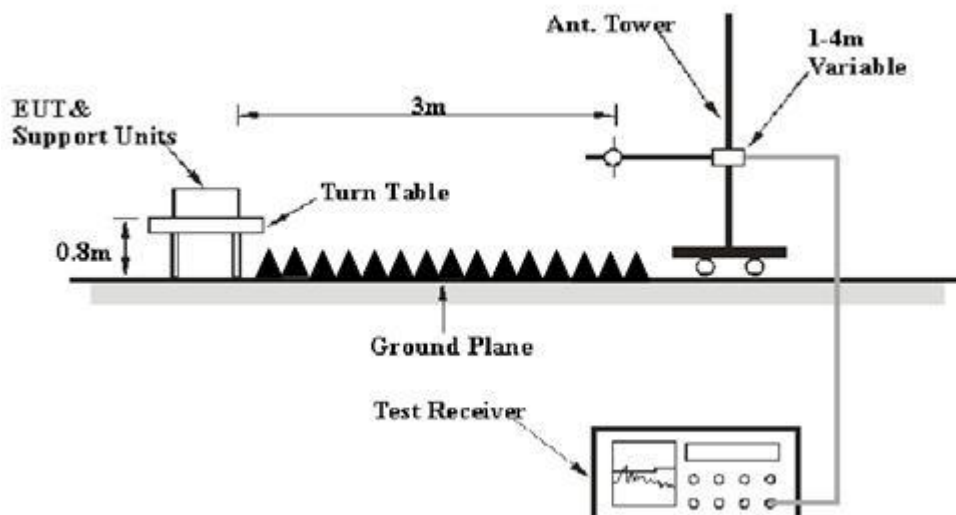

The EUT, which is powered by the DC 3.8V Power Supply directly, is located in a 3m Full-Anechoic Chamber; the cable loss, air loss and so on of the site as factors are pre-calibrated using the "Substitution" method, and calculated to correct the reading.

A call is established between the EUT and the SS via a Common Antenna. The EUT is commanded by the SS to operate at the maximum and minimum output power, and only the test result of the maximum output power was recorded.

2. Equipments List:

Description	Manufacturer	Model	Serial No.	Cal. Date	Cal. Due Date
Spectrum Analyzer	R&S	FSP40	1164.4391.40	2014.07.07	2015.07.06
EMI Test Receiver	R&S	ESIB26	100130	2014.07.07	2015.07.06
Full-Anechoic Chamber	Albatross~ Projects	12.8m*6.8m *6.4m	A0412372	2014.01.05	2015.01.04



Description	Manufacturer	Model	Serial No.	Cal. Date	Cal. Due Date
Double ridge horn antenna	R&S	HF906	A0304225	2014.06.11	2015.06.10
Ultra-wideband antenna	R&S	HL562	A0304224	2014.06.11	2015.06.10
Loop antenna	R&S	HFH2-Z2	A0304226	2014.06.11	2015.06.10
Cable	SUNHNER	SUCOFLEX 100	/	2014.06.05	2015.06.04
Cable	SUNHNER	SUCOFLEX 104	/	2014.06.05	2015.06.04

2.7.3 Test Procedures

- The testing follows FCC KDB 971168 v02r01 Section 5.2.1. (for CDMA/WCDMA), Section 5.2.2.2 (for GSM/GPRS/EDGE) and ANSI / TIA-603-C-2004 Section 2.2.17.
- The EUT was placed on a turntable 1.5 meters high in a fully anechoic chamber.
- The EUT was placed 3 meters from the receiving antenna, which was mounted on the antenna tower.
- GSM operating modes: Set RBW= 1MHz, VBW= 3MHz, RMS detector over burst;
UMTS operating modes: Set RBW= 100 kHz, VBW= 300 kHz, RMS detector over frame, and use channel power option with bandwidth=5MHz, per KDB 971168 D01.
- The table was rotated 360 degrees to determine the position of the highest radiated power.
- The height of the receiving antenna is adjusted to look for the maximum ERP/EIRP.
- Taking the record of maximum ERP/EIRP.
- A dipole antenna was substituted in place of the EUT and was driven by a signal generator.
- The conducted power at the terminal of the dipole antenna is measured.
- Repeat step 3 to step 5 to get the maximum ERP/EIRP of the substitution antenna.
- $ERP/EIRP = P_s + E_t - E_s + G_s = P_s + R_t - R_s + G_s$
 P_s (dBm): Input power to substitution antenna.
 G_s (dBi or dBd): Substitution antenna Gain.
 $E_t = R_t + AF$ $E_s = R_s + AF$
 AF (dB/m): Receive antenna factor
 R_t : The highest received signal in spectrum analyzer for EUT.



Rs: The highest received signal in spectrum analyzer for substitution antenna.

2.7.4 Test Result

Test Notes:

1. This device employs GMSK technology with GSM and GPRS capabilities. All configurations were investigated and the worst case emissions were found in GSM mode.
2. This device employs UMTS technology with WCDMA (AMR/RMC), HSDPA, HSUPA and HSPA+ capabilities. All configurations were investigated and the worst case UMTS emissions were found in RMC WCDMA mode at 12.2Kbps.
3. This unit was tested with its standard battery.
4. The worst case test configuration was found in the vertical positioning where the EUT is laying on its side. The data reported in the tables below were measured in this test setup.

Band	Channel	Frequency (MHz)	Antenna Pol (H/V)	PCL	Measured ERP dBm	Limit dBm	Verdict
GSM 850MHz	128	824.20	V	5	33.86	38.5	PASS
	190	836.60	V	5	33.94		PASS
	251	848.80	V	5	33.91		PASS

Band	Channel	Frequency (MHz)	Antenna Pol (H/V)	PCL	Measured ERP dBm	Limit dBm	Verdict
GSM 850MHz	128	824.20	H	5	33.67	38.5	PASS
	190	836.60	H	5	33.72		PASS
	251	848.80	H	5	33.58		PASS

Band	Channel	Frequency (MHz)	Antenna Pol (H/V)	PCL	Measured EIRP dBm	Limit dBm	Verdict
GSM 1900MHz	512	1850.2	V	0	31.28	33	PASS
	661	1880.0	V	0	31.31		PASS
	810	1909.8	V	0	31.24		PASS

Band	Channel	Frequency (MHz)	Antenna Pol (H/V)	PCL	Measured EIRP dBm	Limit dBm	Verdict
GSM 1900MHz	512	1850.2	H	0	31.11	33	PASS
	661	1880.0	H	0	31.15		PASS
	810	1909.8	H	0	31.03		PASS



Band	Channel	Frequency (MHz)	Antenna Pol (H/V)	PCL	Measured ERP dBm	Limit dBm	Verdict
EDGE 850MHz	128	824.20	V	5	31.96	38.5	PASS
	190	836.60	V	5	32.04		PASS
	251	848.80	V	5	32.07		PASS

Band	Channel	Frequency (MHz)	Antenna Pol (H/V)	PCL	Measured ERP dBm	Limit dBm	Verdict
EDGE 850MHz	128	824.20	H	5	31.87	38.5	PASS
	190	836.60	H	5	31.95		PASS
	251	848.80	H	5	31.99		PASS

Band	Channel	Frequency (MHz)	Antenna Pol (H/V)	PCL	Measured EIRP dBm	Limit dBm	Verdict
EDGE 1900MHz	512	1850.2	V	0	29.78	33	PASS
	661	1880.0	V	0	29.81		PASS
	810	1909.8	V	0	29.74		PASS

Band	Channel	Frequency (MHz)	Antenna Pol (H/V)	PCL	Measured EIRP dBm	Limit dBm	Verdict
EDGE 1900MHz	512	1850.2	H	0	29.74	33	PASS
	661	1880.0	H	0	29.69		PASS
	810	1909.8	H	0	29.67		PASS

Band	Channel	Frequency (MHz)	Antenna Pol (H/V)	Measured ERP dBm	Limit dBm	Verdict
WCDMA 850MHz	4132	826.4	V	25.73	38.5	PASS
	4175	835	V	25.94		PASS
	4233	846.6	V	25.84		PASS

Band	Channel	Frequency (MHz)	Antenna Pol (H/V)	Measured ERP dBm	Limit dBm	Verdict
WCDMA 850MHz	4132	826.4	H	25.58	38.5	PASS
	4175	835	H	25.71		PASS
	4233	846.6	H	25.68		PASS



Band	Channel	Frequency (MHz)	Antenna Pol (H/V)	Measured EIRP dBm	Limit dBm	Verdict
WCDMA 1900MHz	9262	1852.4	V	25.68	33	PASS
	9400	1880	V	25.81		PASS
	9538	1907.6	V	25.58		PASS

Band	Channel	Frequency (MHz)	Antenna Pol (H/V)	Measured EIRP dBm	Limit dBm	Verdict
WCDMA 1900MHz	9262	1852.4	H	25.51	33	PASS
	9400	1880	H	25.65		PASS
	9538	1907.6	H	25.43		PASS



2.8 Radiated Out of Band Emissions

2.8.1 Requirement

According to FCC section 22.917(a) and section 24.238(a), the power of any emission outside of the authorized operating frequency ranges must be attenuated below the transmitting power (P) by a factor of at least $43+10*\log(P)$ dB. This calculated to be -13dBm.

2.8.2 Test Description

See section 0 of this report.

Equipment List:

Description	Manufacturer	Model	Serial No.	Cal. Date	Cal.Due Date
System Simulator	R&S	CMW500	149333	2014.07.21	2015.07.20
EMI Test Receiver	R&S	ESIB26	100130	2014.07.07	2015.07.06
Full-Anechoic Chamber	Albatross~ Projects	12.8m*6.8m *6.4m	A0412372	2014.01.05	2015.01.04
Double ridge horn antenna(1GHz~18G Hz)	R&S	HF906	100150	2014.06.11	2015.06.10
Broadband antenna (30MHz~1GHz)	R&S	HL562	101341	2014.06.11	2015.06.10
Horn antenna (18GHz~26.5GHz)	R&S	HM118	101286	2014.06.11	2015.06.10
Cable	SUNHNER	SUCOFLEX 100	/	2014.06.05	2015.06.04
Cable	SUNHNER	SUCOFLEX 104	/	2014.06.05	2015.06.04

Note: when doing measurements above 1GHz, the EUT has been within the 3dB cone width of the horn antenna during horizontal antenna.

2.8.3 Test Result

Test Notes:

1. This device employs GMSK technology with GSM and GPRS capabilities. All configurations were investigated and the worst case emissions were found in GSM mode.
2. This device employs UMTS technology with WCDMA (AMR/RMC), HSDPA, HSUPA and HSPA+ capabilities. All configurations were investigated and the worst case UMTS emissions were



found in RMC WCDMA mode at 12.2Kbps.

3. This unit was tested with its standard battery.

4. The worst case test configuration was found in the vertical positioning where the EUT is laying on its side. The data reported in the tables below were measured in this test setup.

5. The spectrum is measured from 30MHz to the 10th harmonic of the fundamental frequency of the transmitter using CISPR quasi peak detector below 1GHz. The worst case emissions are reported however emissions whose levels were not within 20dB of the respective limits were not reported.

6. Emissions below 18GHz were measured at a 3 meter test distance while emissions above 18GHz were measured at a 1 meter test distance with the application of a distance correction factor.

1. Test Verdict:

Band	Channel	Frequency (MHz)	Measured Max. Spurious Emission (dBm)		Limit (dBm)	Verdict
			Test Antenna Horizontal	Test Antenna Vertical		
GSM 850MHz	128	824.2	< -25	< -25	-13	PASS
	190	836.6	< -25	< -25		PASS
	251	848.8	< -25	< -25		PASS
GSM 1900MHz	512	1850.2	< -25	< -25	-13	PASS
	661	1880.0	< -25	< -25		PASS
	810	1909.8	< -25	< -25		PASS
EDGE 850MHz	128	824.2	< -25	< -25	-13	PASS
	190	836.6	< -25	< -25		PASS
	251	848.8	< -25	< -25		PASS
EDGE 1900MHz	512	1850.2	< -25	< -25	-13	PASS
	661	1880.0	< -25	< -25		PASS
	810	1909.8	< -25	< -25		PASS
WCDMA 850MHz	4132	826.4	< -25	< -25	-13	PASS
	4183	836.6	< -25	< -25		PASS
	4233	846.6	< -25	< -25		PASS
WCDMA 1900MHz	9262	1852.4	< -25	< -25	-13	PASS
	9400	1880	< -25	< -25		PASS
	9538	1907.6	< -25	< -25		PASS

2. Test Plots for the Whole Measurement Frequency Range:

Note1: the power of the EUT transmitting frequency should be ignored.

Note2: All Spurious Emission tests were performed in X, Y, Z axis direction and low, middle, high channel. And only the worst axis test condition was recorded in this test report.

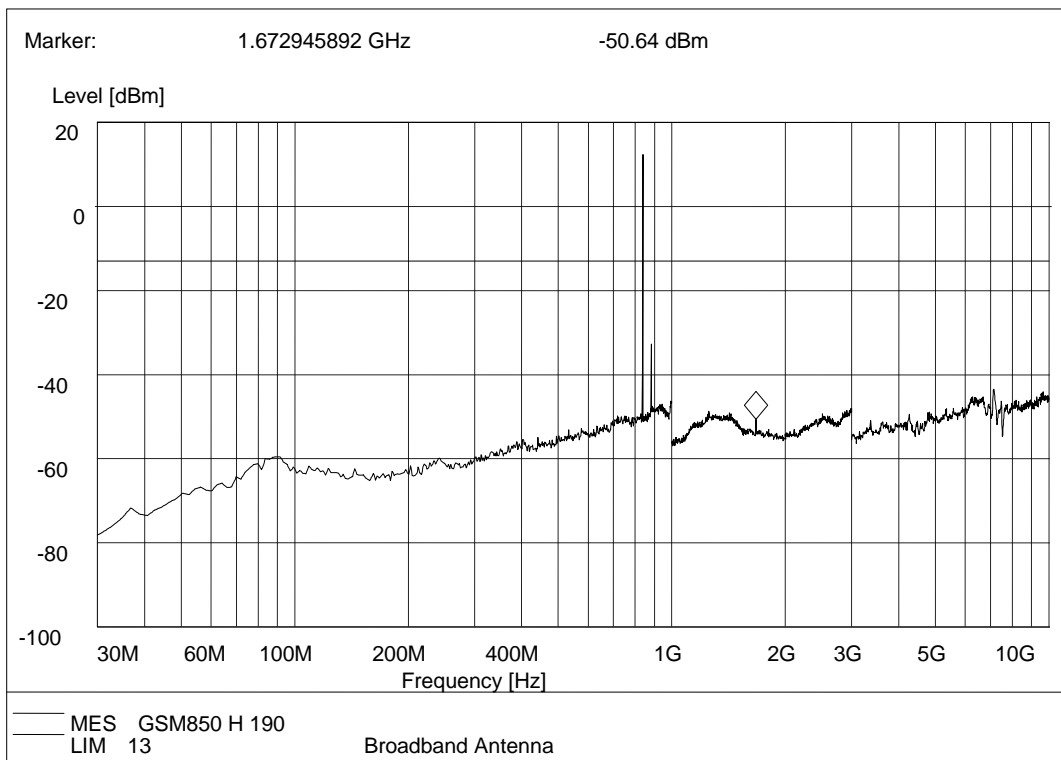

GSM 850MHz , Test Antenna Horizontal

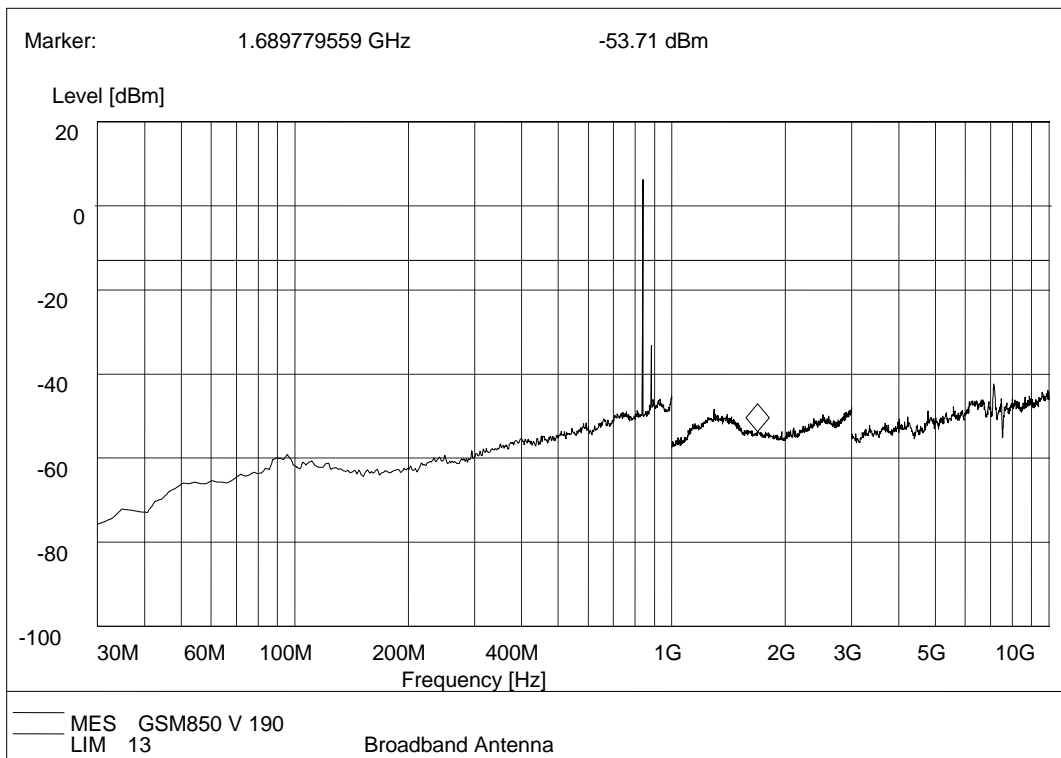

GSM 850MHz , Test Antenna Vertical

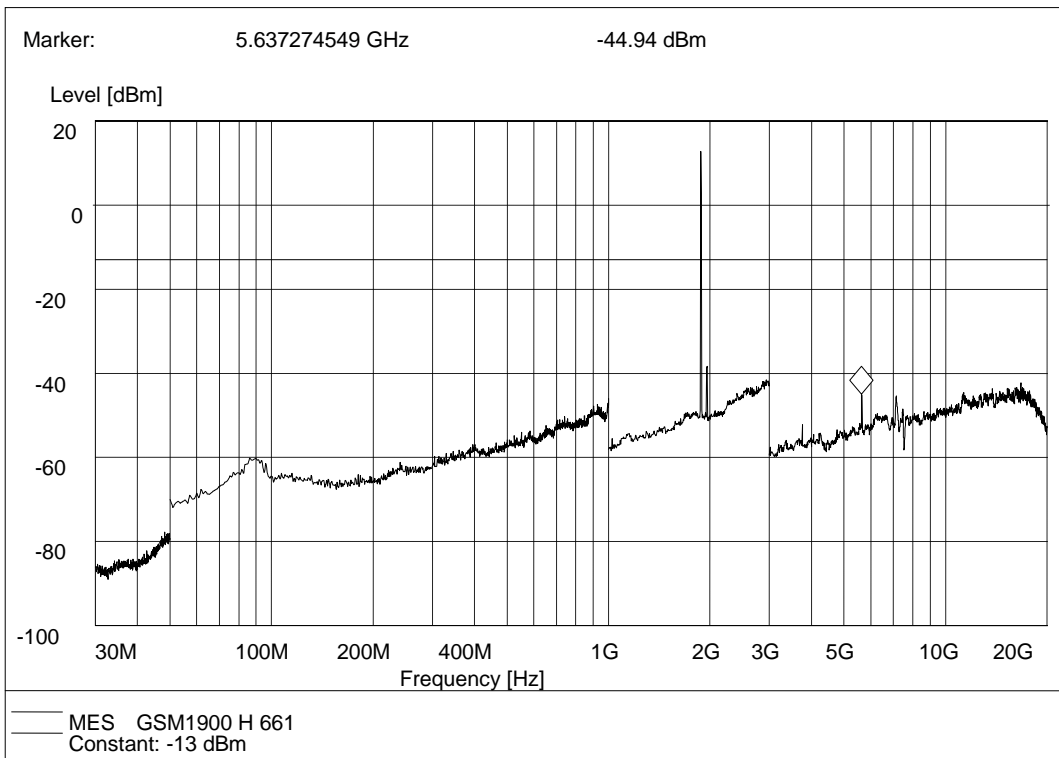

GSM 1900MHz , Test Antenna Horizontal

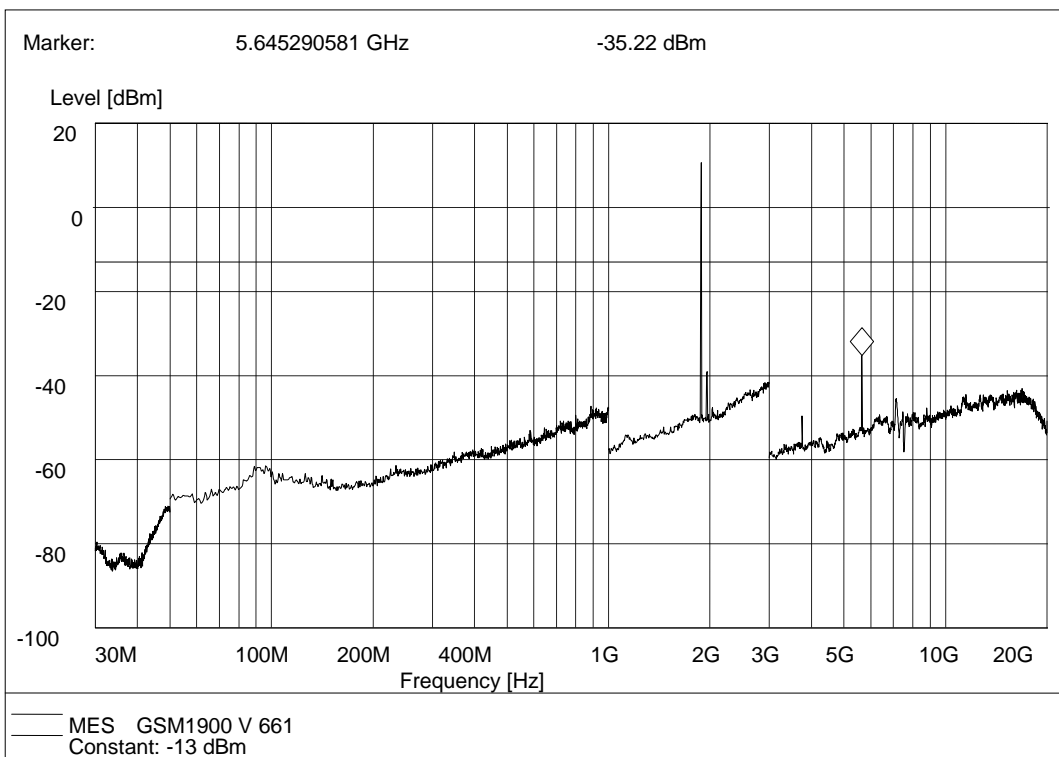

GSM 1900MHz , Test Antenna Vertical

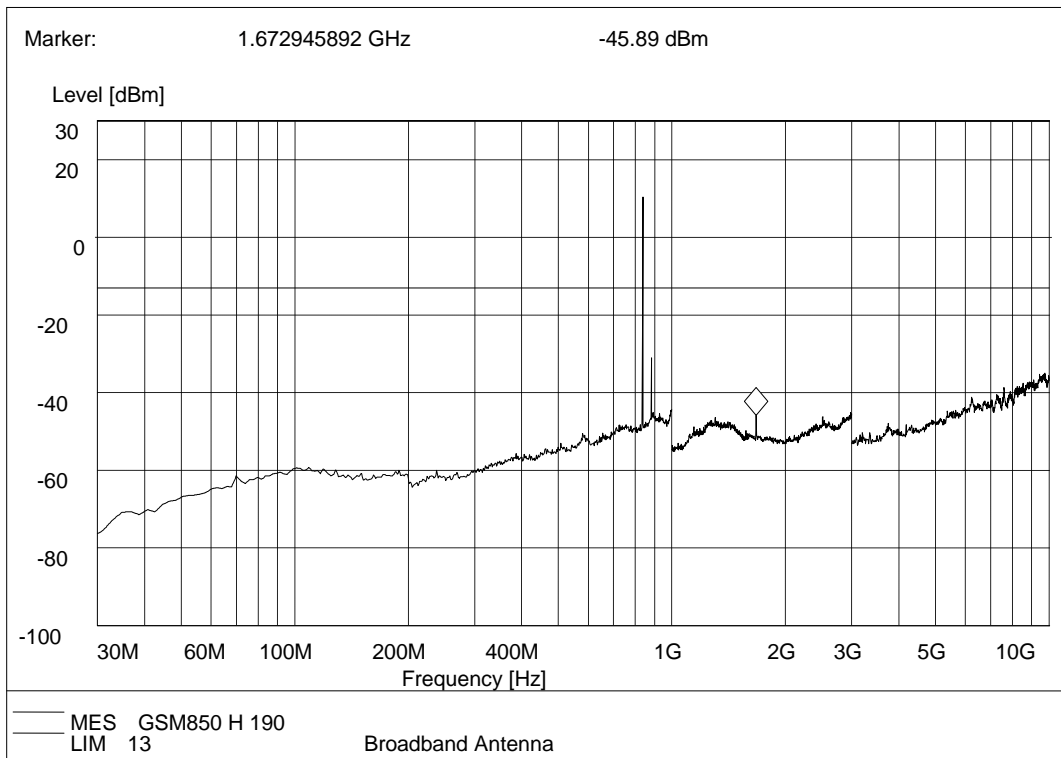

EDGE 850MHz , Test Antenna Horizontal

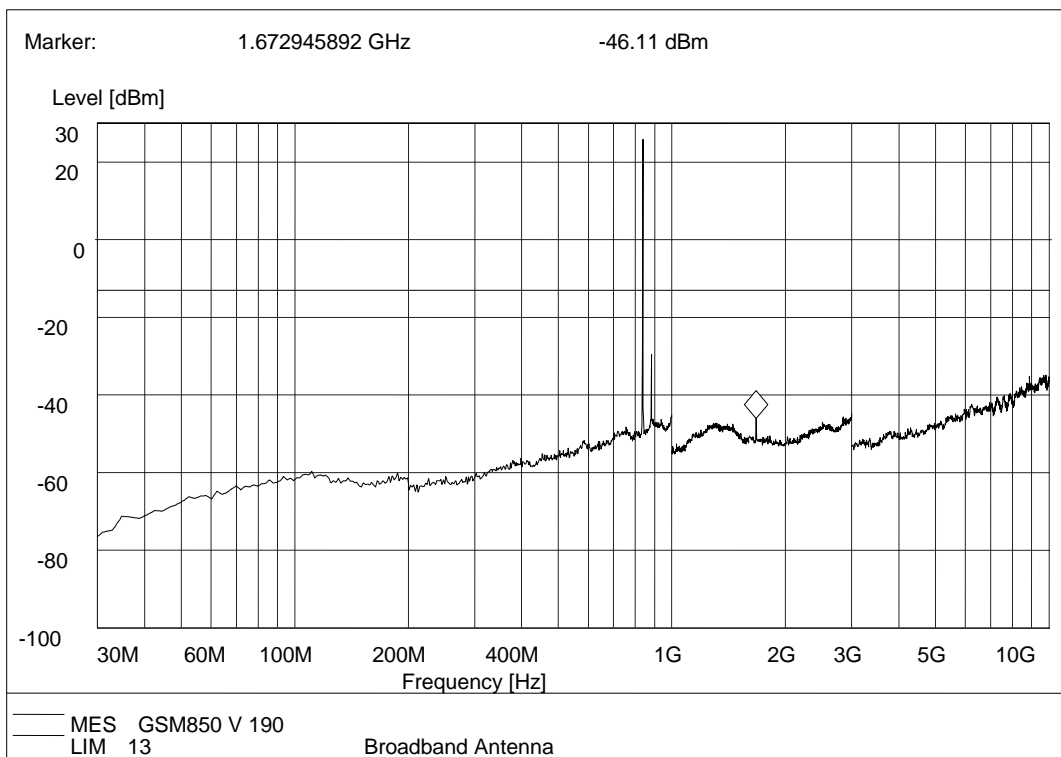

EDGE 850MHz, Test Antenna Vertical

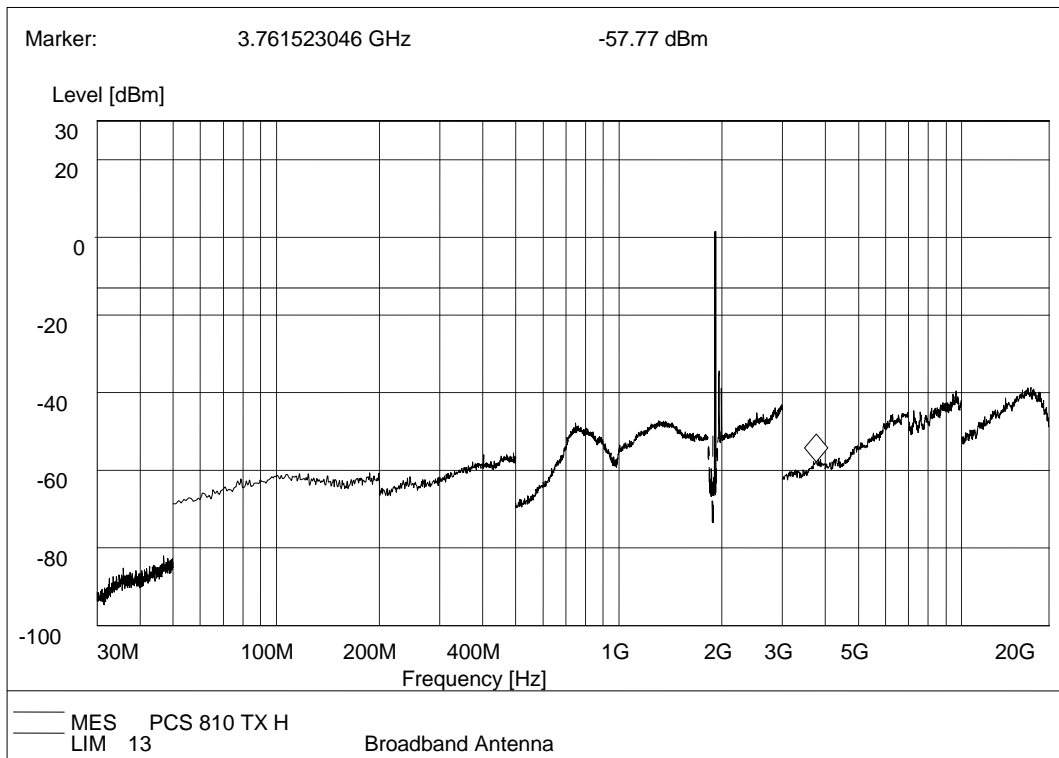

EDGE 1900MHz, Test Antenna Horizontal

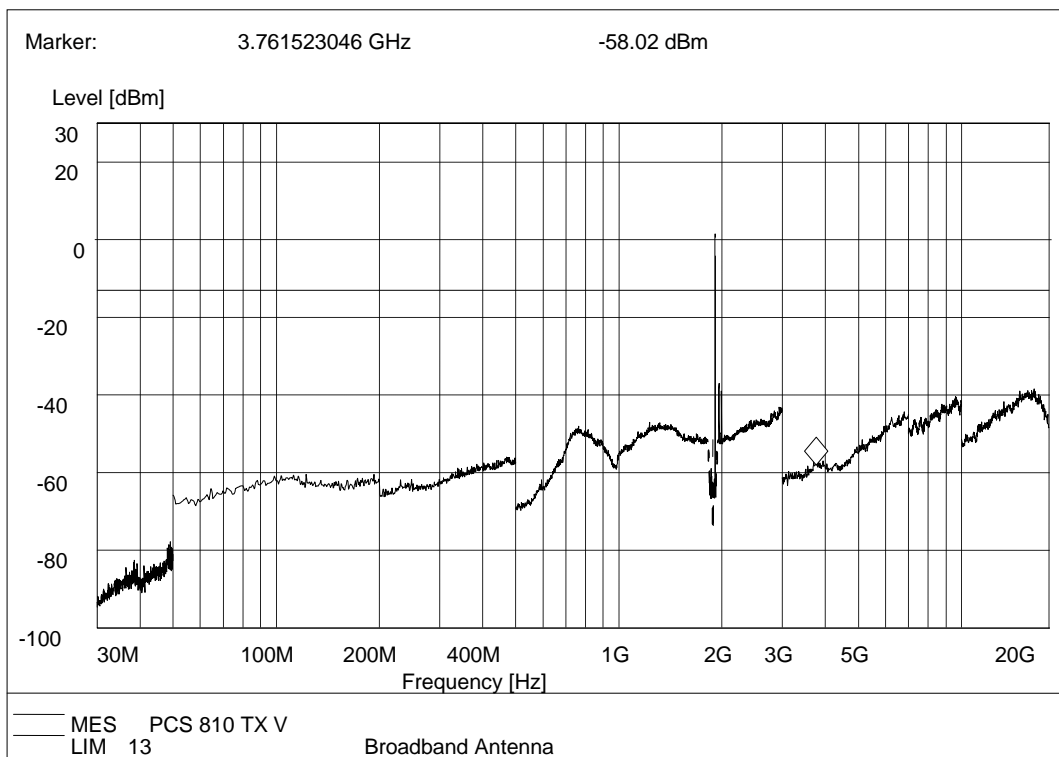

EDGE 1900MHz, Test Antenna Vertical

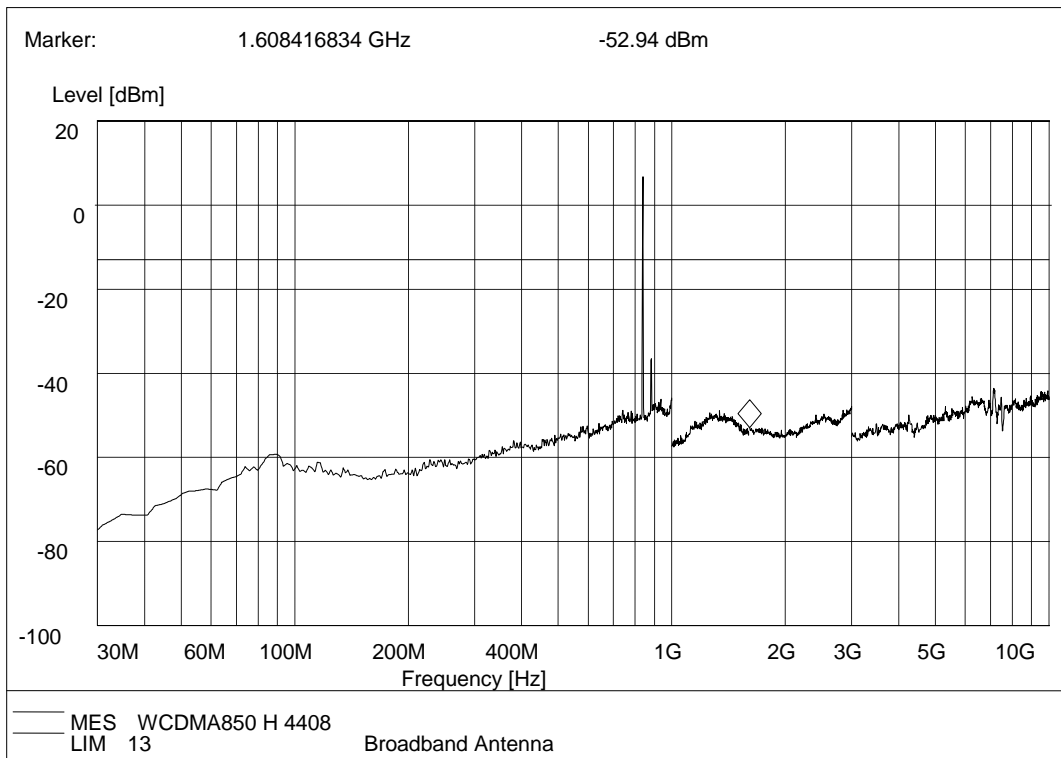

WCDMA 850MHz , Test Antenna Horizontal

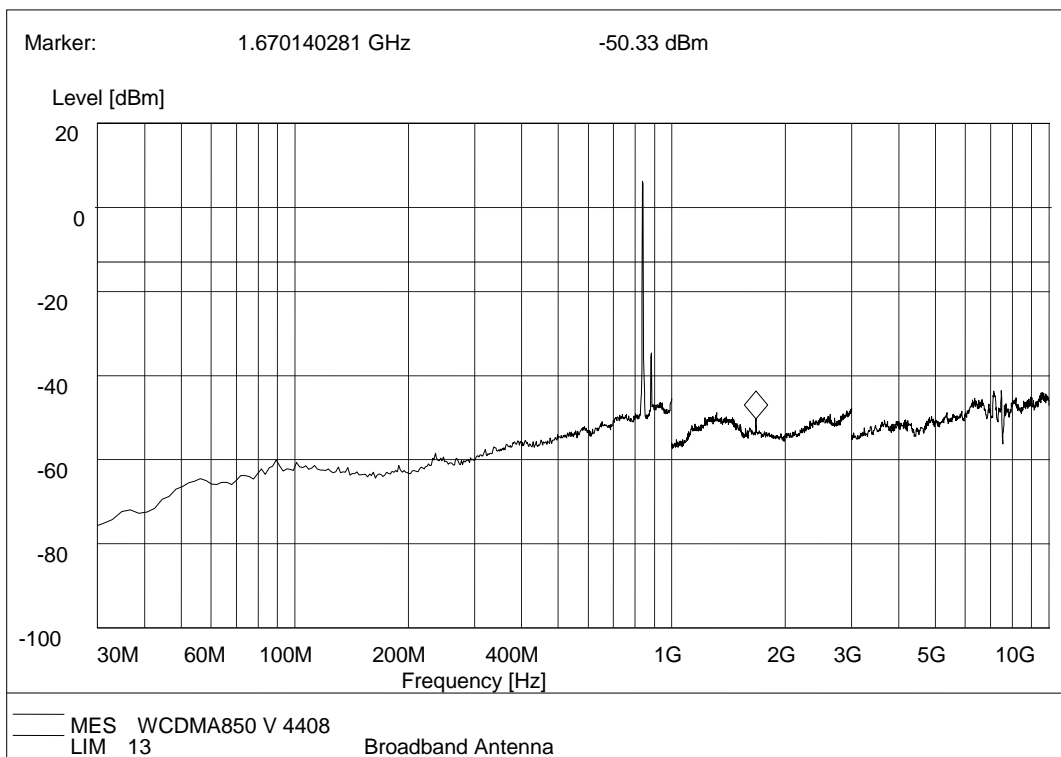

WCDMA 850MHz, Test Antenna Vertical

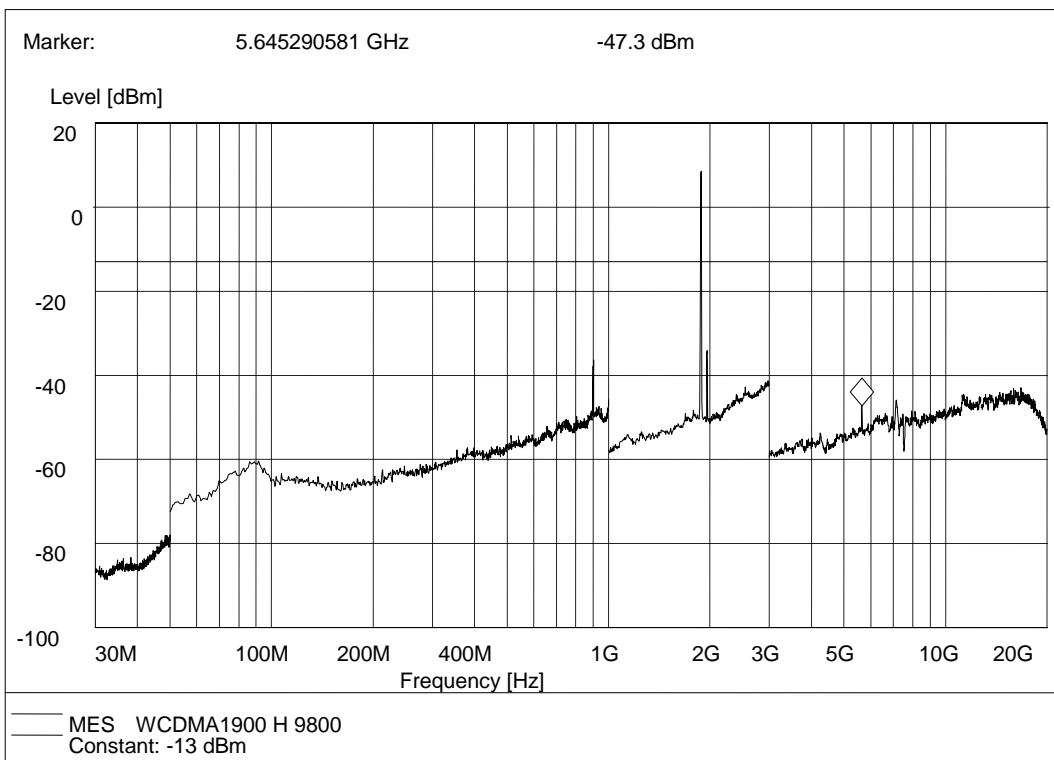

WCDMA 1900MHz, Test Antenna Horizontal

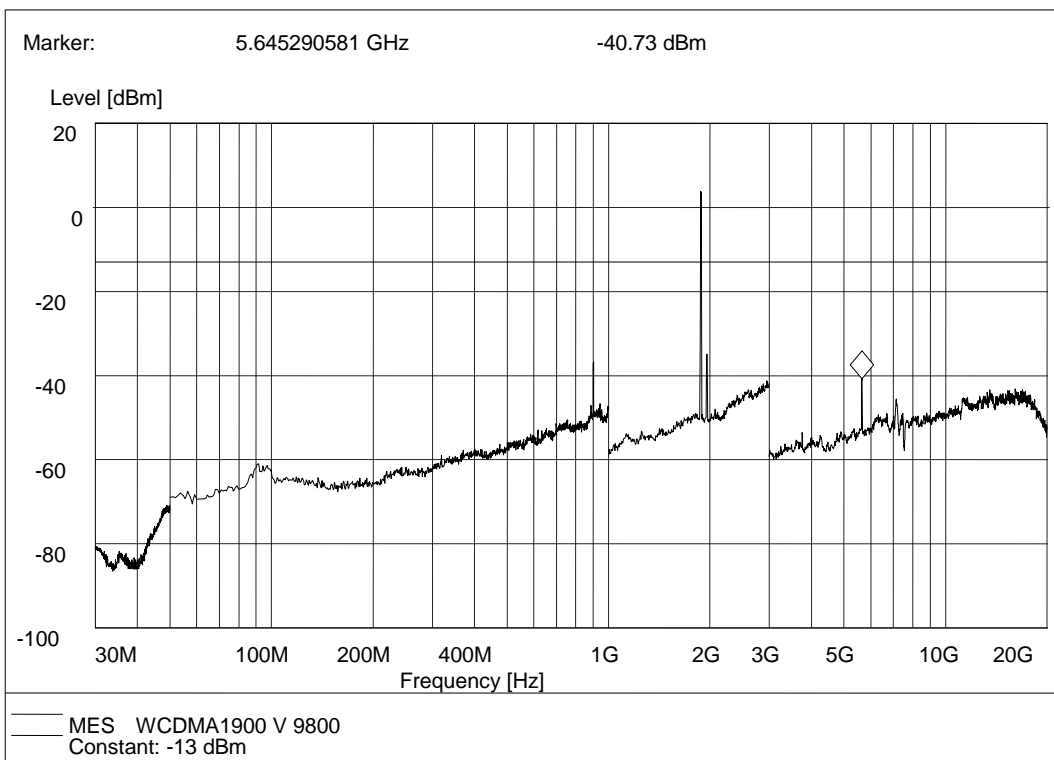

WCDMA 1900MHz, Test Antenna Vertical

Annex A Accreditation Certificate

 
China National Accreditation Service for Conformity Assessment
LABORATORY ACCREDITATION CERTIFICATE
(Registration No. CNAS L1659)
CCIC Southern Electronic Product Testing (Shenzhen) Co., Ltd. <u>Building 28/29, Shigudong, Xili Industrial Area, Xili Street,</u> <u>Nanshan District, Shenzhen, Guangdong, China</u>
<i>is accredited to ISO/IEC 17025:2005 General Requirements for the Competence of Testing and Calibration Laboratories(CNAS-CL01 Accreditation Criteria for the Competence of Testing and Calibration Laboratories) for the competence of testing and calibration.</i>
<i>The scope of accreditation is detailed in the attached appendices bearing the same registration number as above. The appendices form an integral part of this certificate.</i>
Date of Issue: 2012-09-29 Date of Expiry: 2015-09-28 Date of Initial Accreditation: 1999-08-03 Date of Update: 2012-09-29

Signed on behalf of China National Accreditation Service for Conformity Assessment
<small>China National Accreditation Service for Conformity Assessment (CNAS) is authorized by Certification and Accreditation Administration of the People's Republic of China (CNCA) to operate the national accreditation scheme for conformity assessment. CNAS is the signatory to International Laboratory Accreditation Cooperation Multilateral Recognition Arrangement (ILAC MRA) and Asia Pacific Laboratory Accreditation Cooperation Multilateral Recognition Arrangement (APLAC MRA).</small>
No. CNAS AL 2 0005210

Annex B PHOTOGRAPHS OF THE EUT





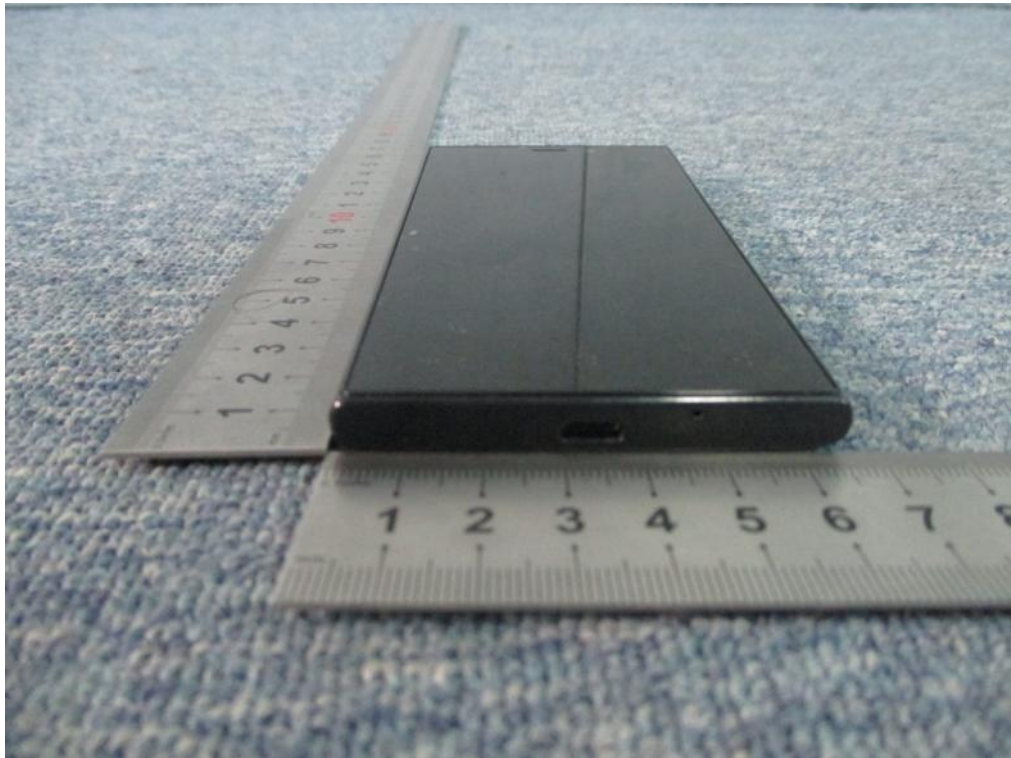

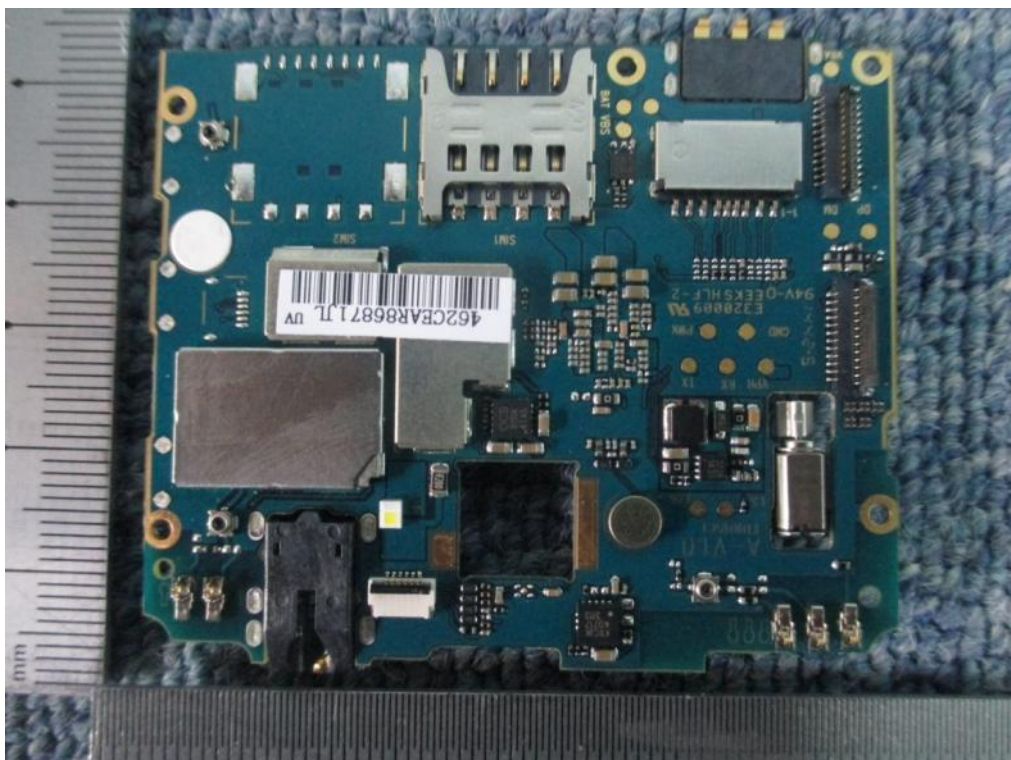

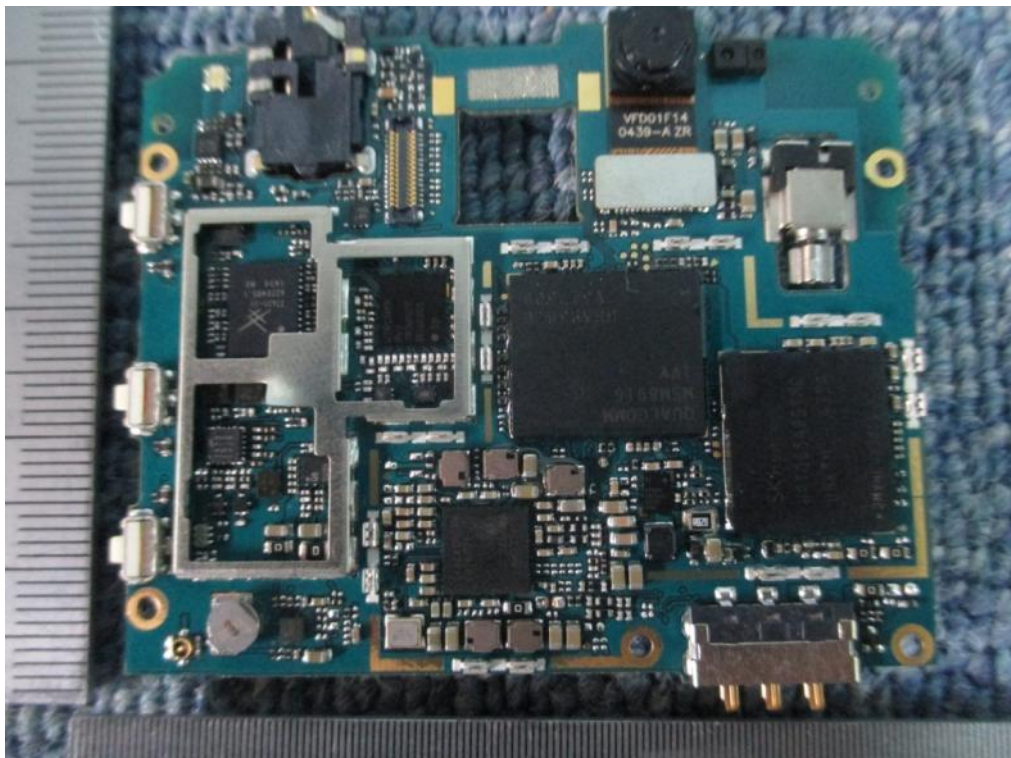
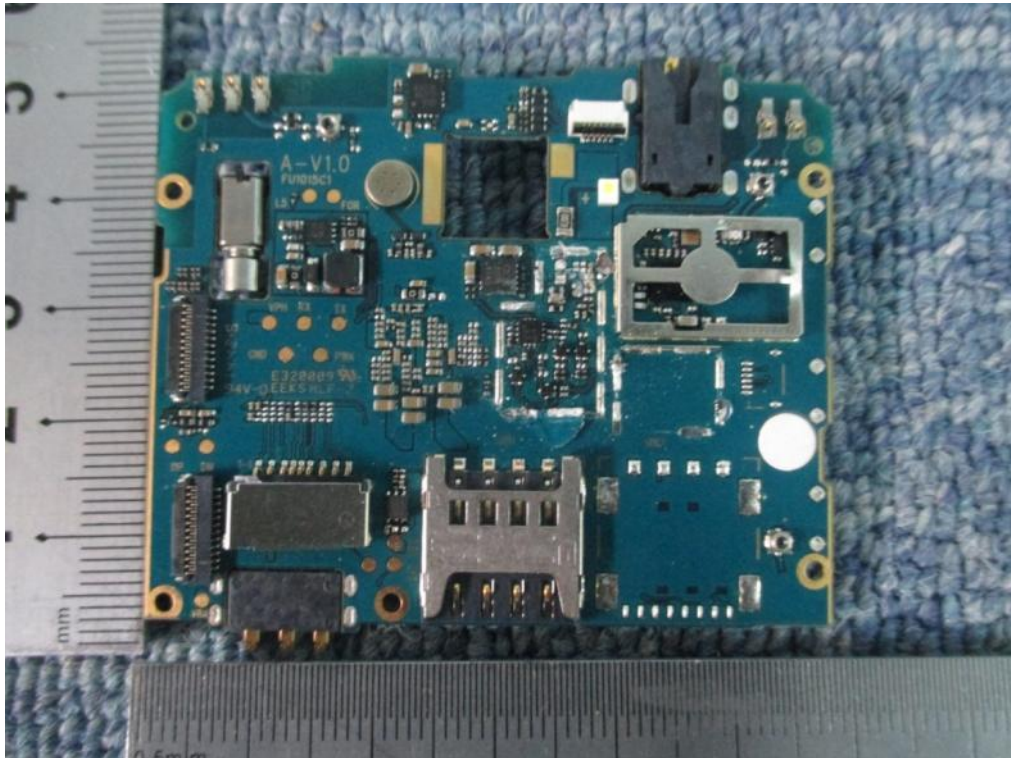

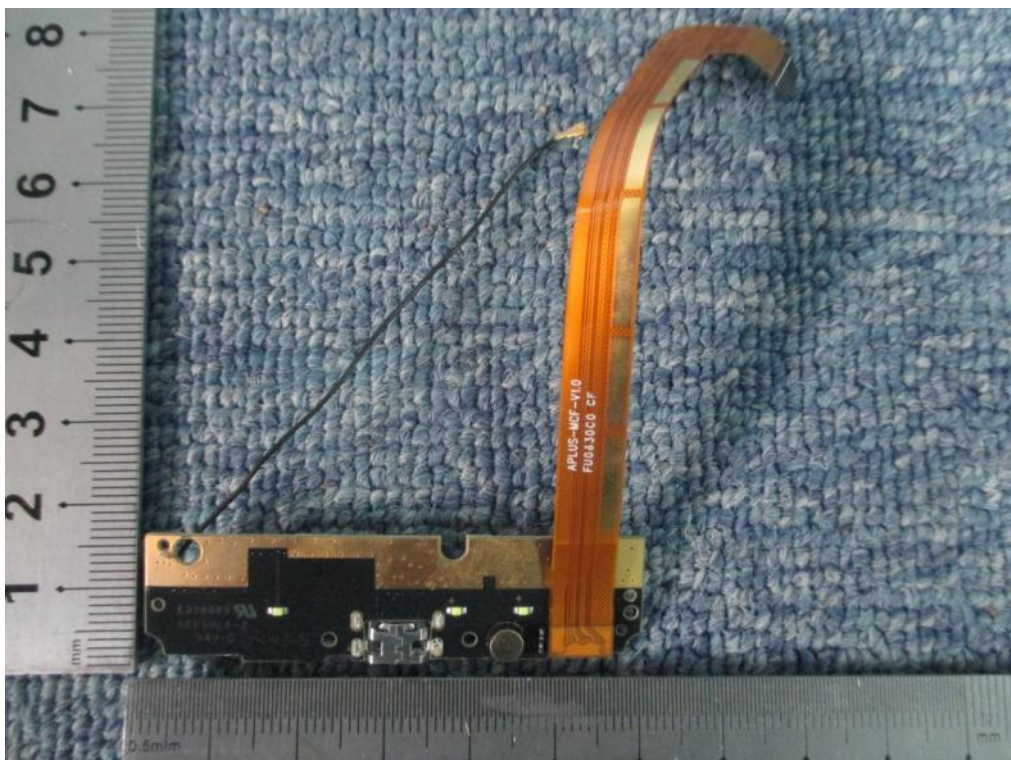
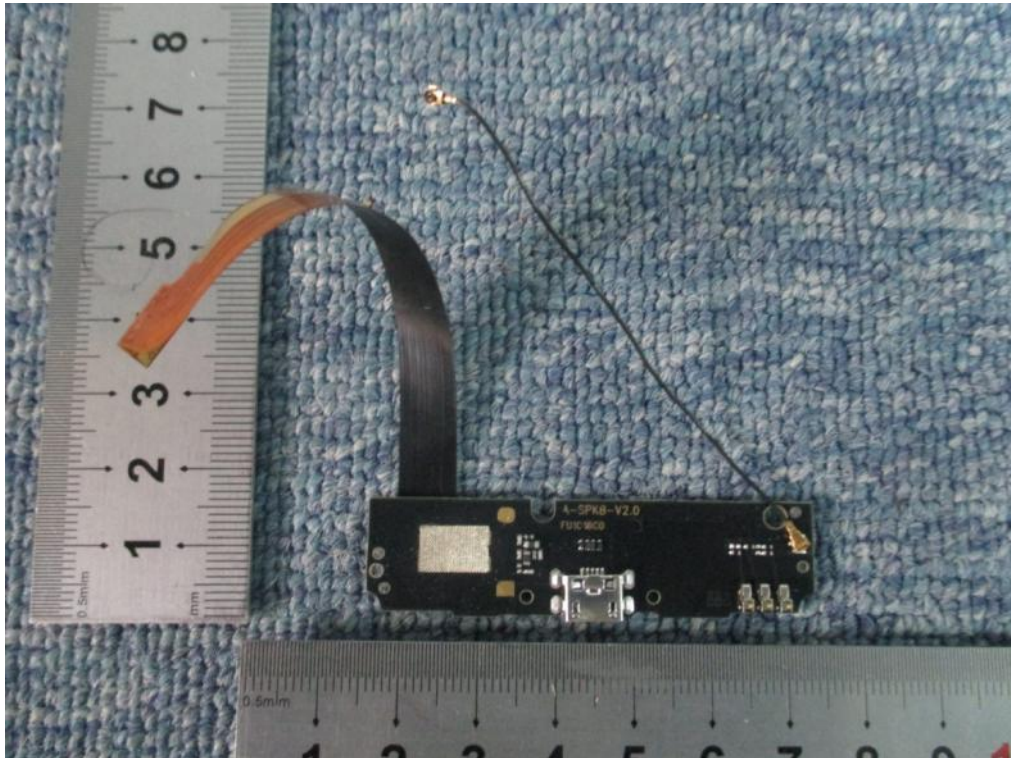



Annex C PHOTOGRAPHS OF THE TEST SETUP

1. Conducted Measurement Setup



2. Radiated Measurement Setup

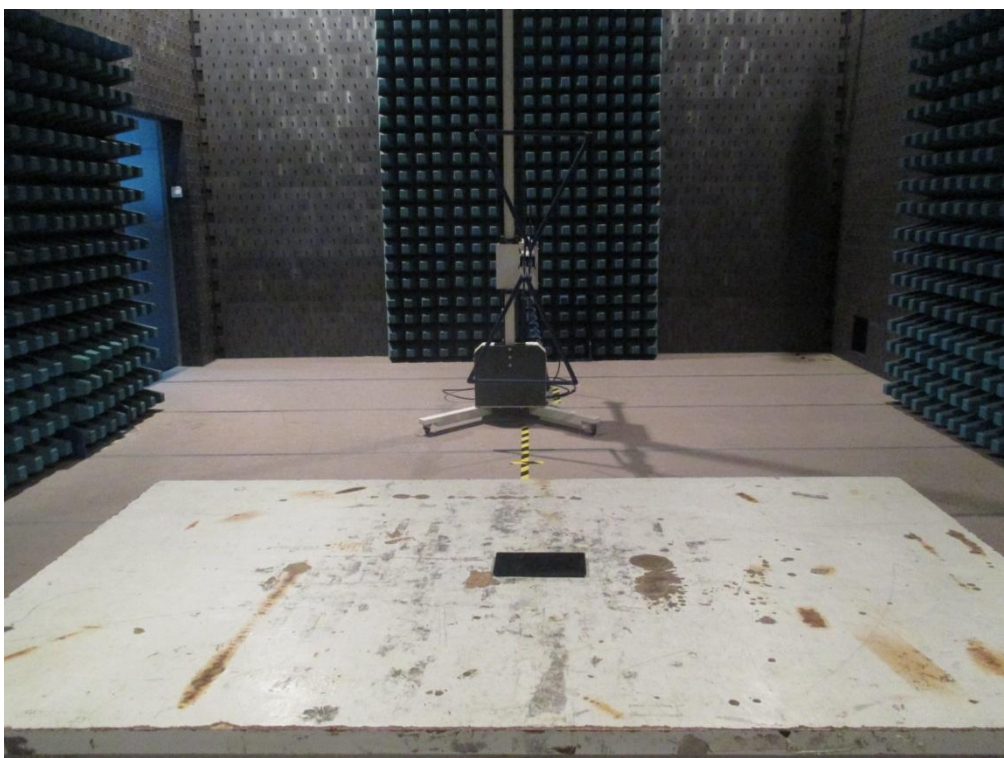



** END OF REPORT **