

Fig.29 WCDMA Band V-CH4133 Band Edge Compliance

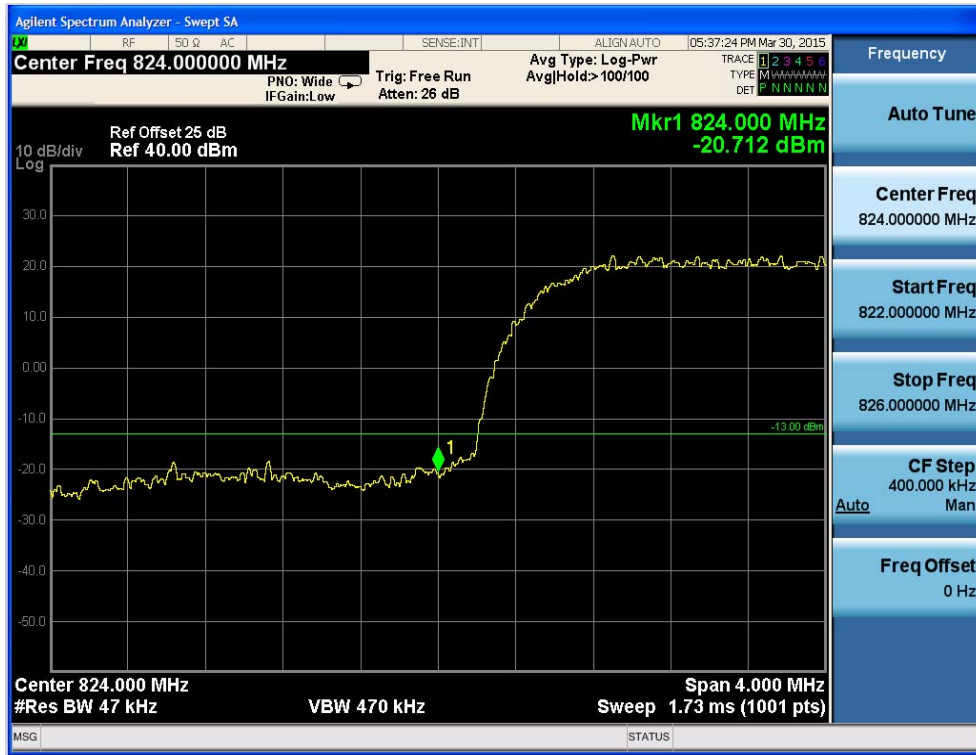

Fig.30 WCDMA Band V-CH4232 Band Edge Compliance



Fig.31 WCDMA Band V-CH4133 Band Edge Compliance HSDPA Subtest 1

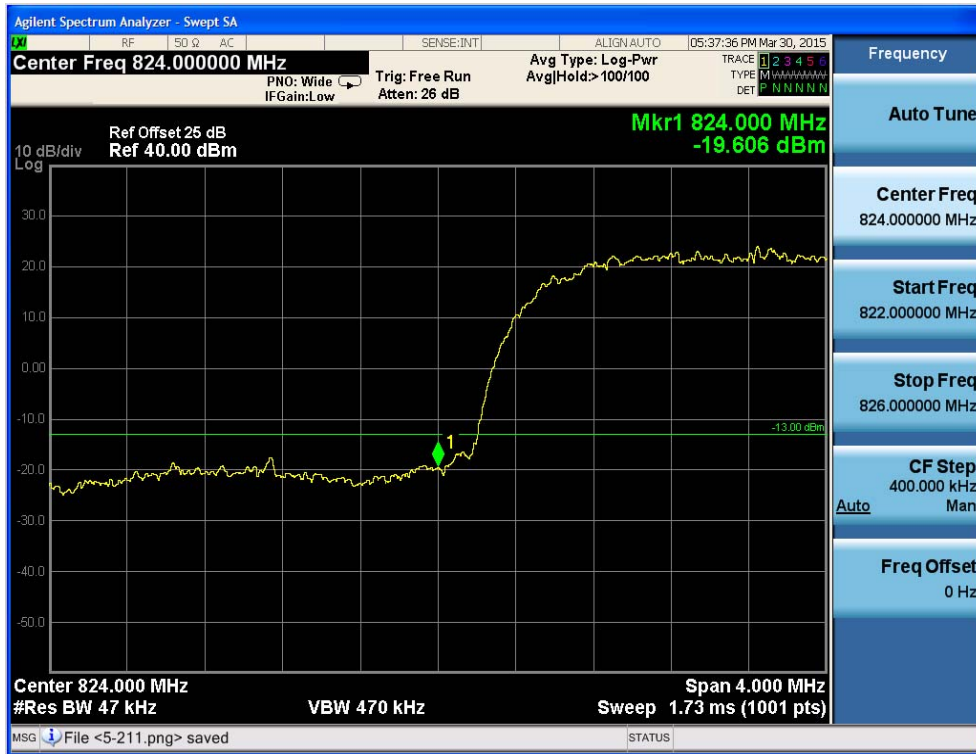

Fig.32 WCDMA Band V-CH4232 Band Edge Compliance HSDPA Subtest 1

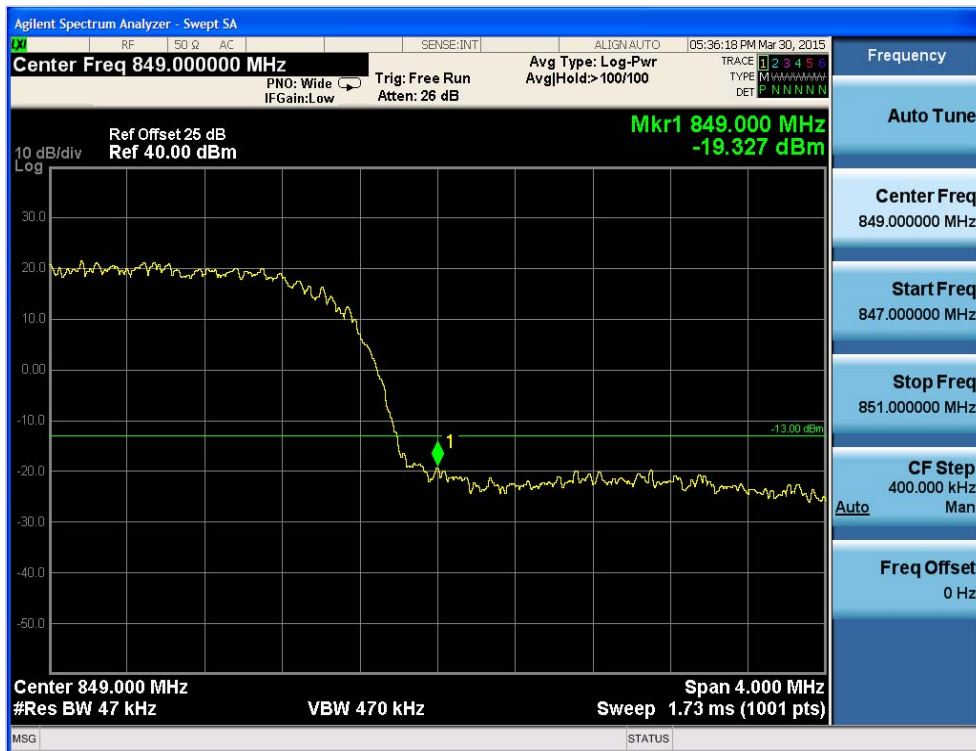

Fig.33 WCDMA Band V-CH4133 Band Edge Compliance HSUPA Subtest 5

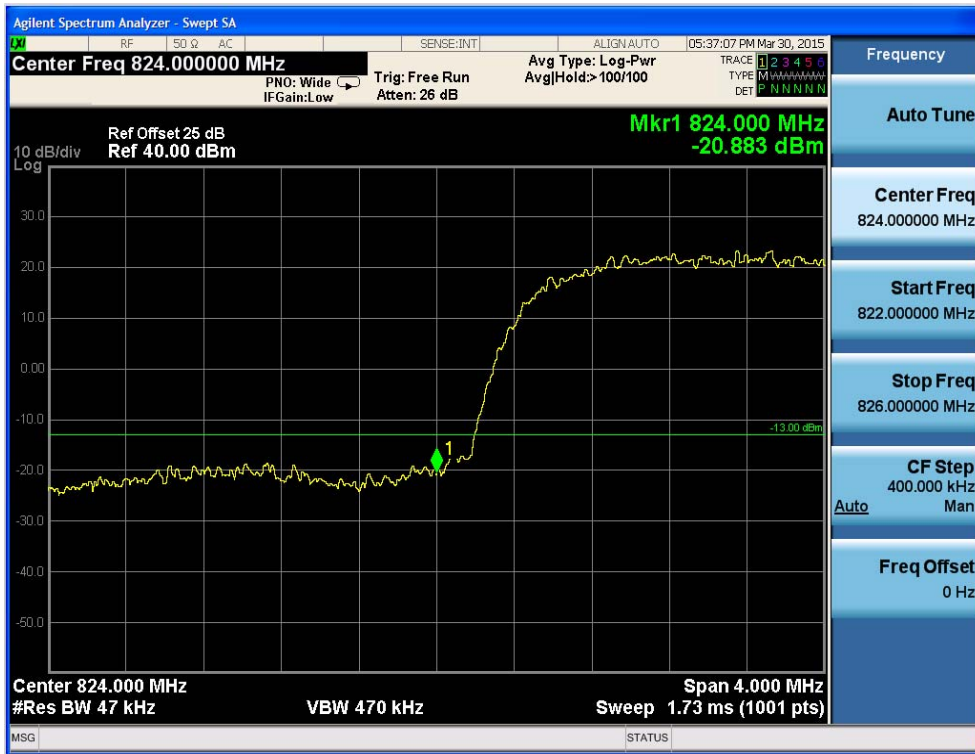

Fig.34 WCDMA Band V-CH4232 Band Edge Compliance HSUPA Subtest 5

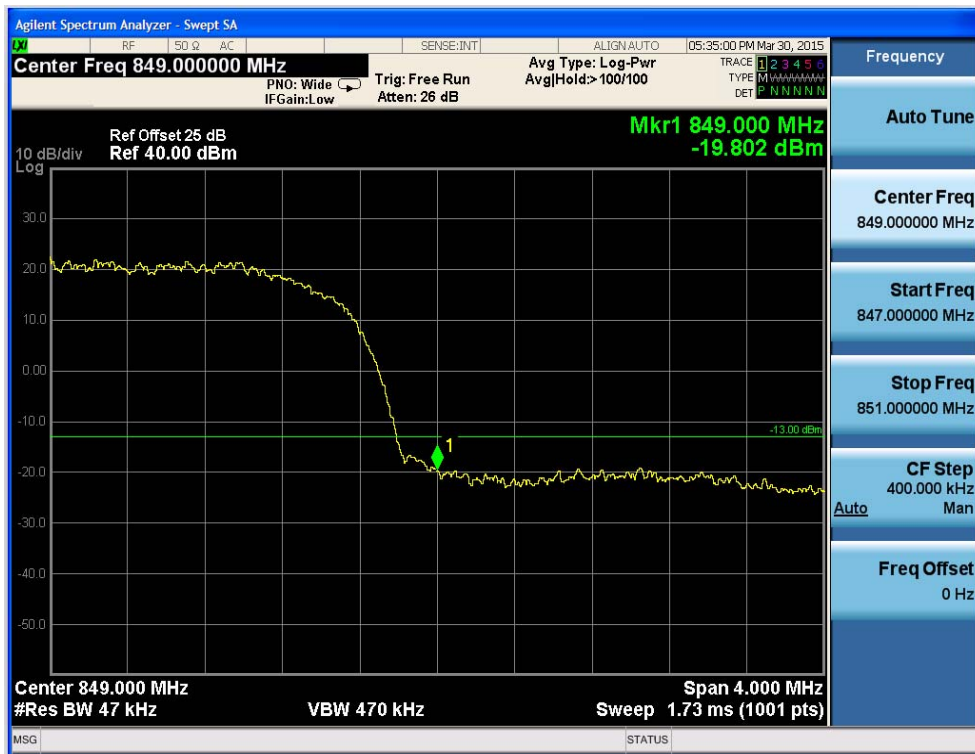

Fig.35 WCDMA Band II-CH9263Band Edge Compliance

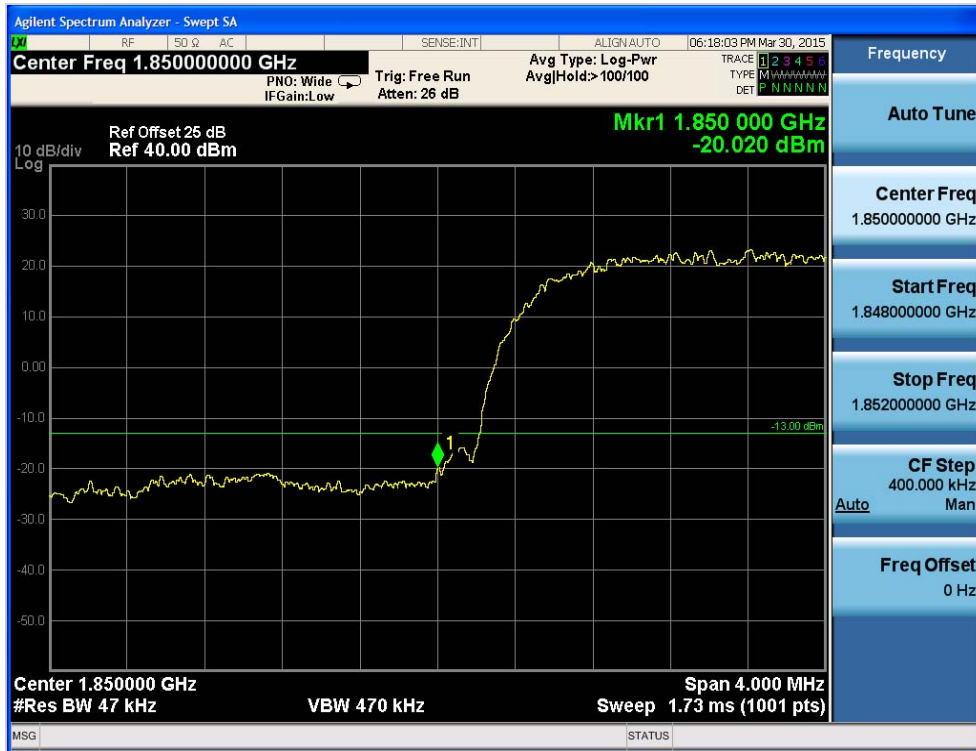

Fig.36 WCDMA Band II-CH9538Band Edge Compliance



Fig.37 WCDMA Band II-CH9263Band Edge Compliance HSDPA Subtest 1

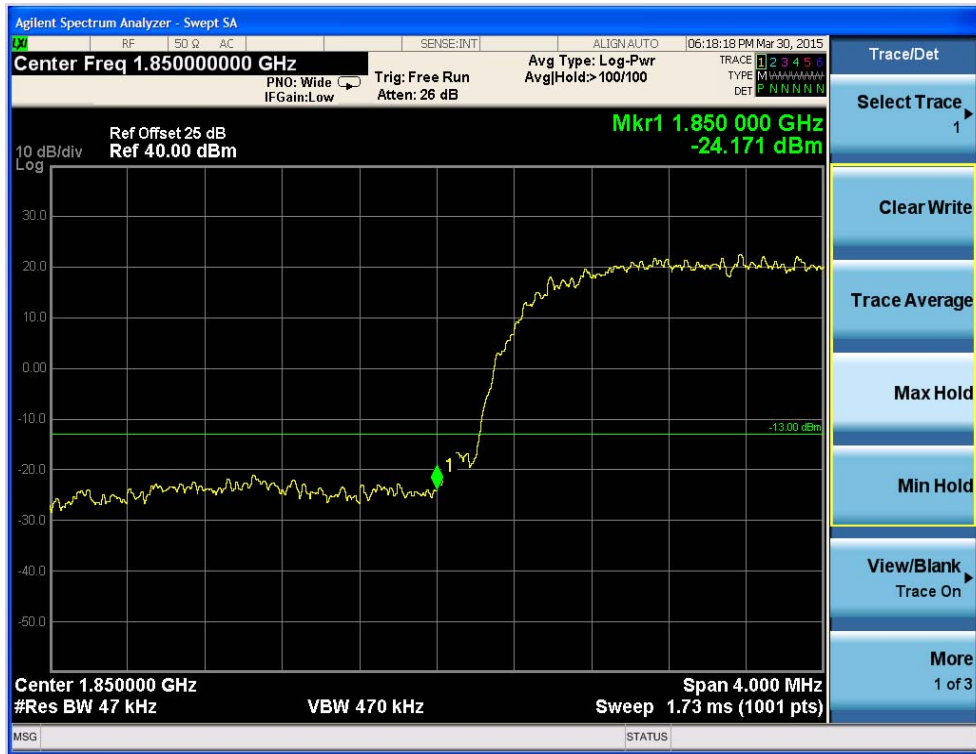

Fig.38 WCDMA Band II-CH9538 Band Edge Compliance HSDPA Subtest 1

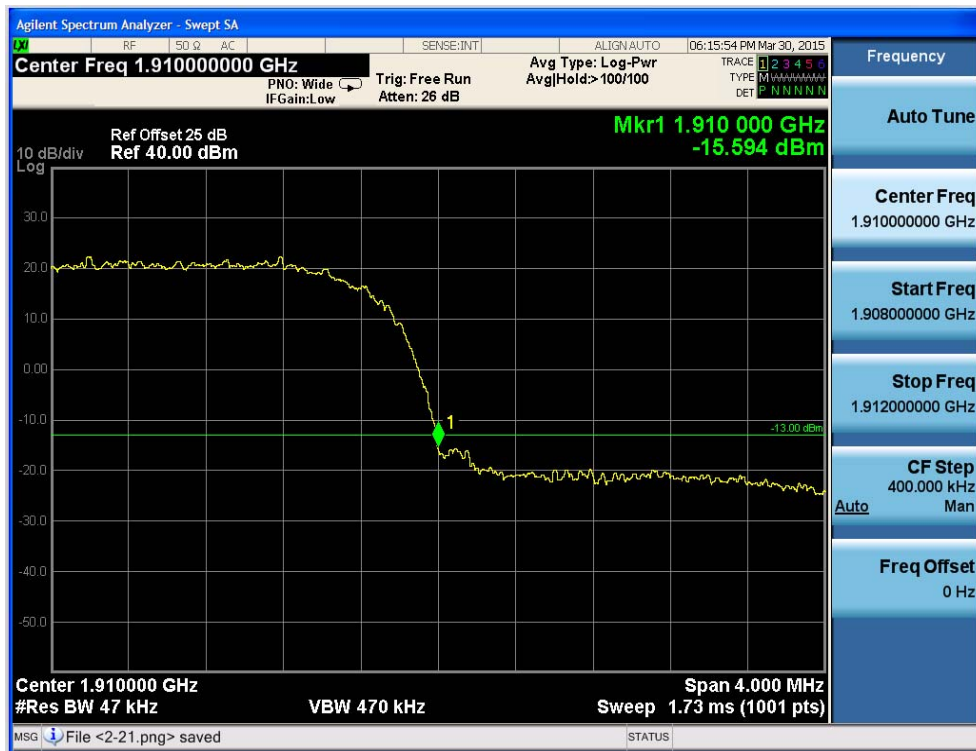

Fig.39 WCDMA Band II-CH9263 Band Edge Compliance HSUPA Subtest 5



Fig.40 WCDMA Band II-CH9538 Band Edge Compliance HSUPA Subtest 5



## B.6 Conducted Spurious Emission(22.917(a)/24.238(a))

### B.6.1 Description

The power of any emission outside of the authorized operating frequency ranges must be lower than transmitter power by a factor of at least  $43+10\log(P)$  dB. For all power levels +30 dBm to 0 dBm, this becomes a constant specification limit of -13 dBm. It is measured by means of spectrum analyzer and scanned from 30MHz up to a frequency including its 10<sup>th</sup> harmonic.

For the equipment of PCS1900 band, this equates to a frequency range of 30MHz to 19.1GHz, data is taken from 30 MHz to 20 GHz. For GSM 850, data is taken from 30 MHz to 9 GHz.

### B.6.2 Test Procedures

1. The EUT was connected to Spectrum Analyzer and Base Station.
2. The middle channel for maximum RF power within the transmitting frequency was measured.
3. The conducted spurious emission for the whole frequency range was taken.

### B.6.3 Test Setup

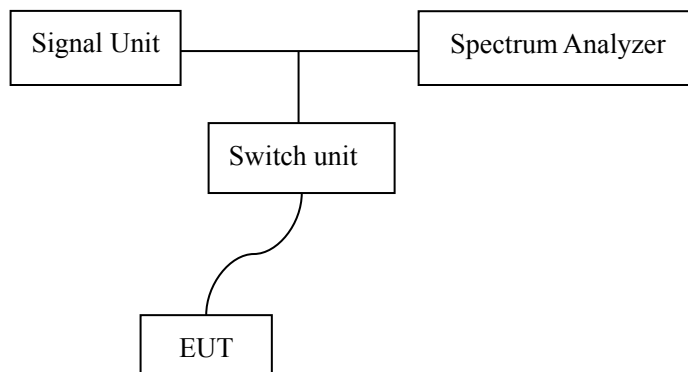

### B.6.4 Test Results

Band	CH	Frequency(MHz)	Result	Verdict
GSM850	189	836.6	Fig.41	Pass
			Fig.42	Pass
GSM1900	661	1880.0	Fig.43	Pass
			Fig.44	Pass
WCDMA Band V	4175	835	Fig.45	Pass
			Fig.46	Pass
WCDMA Band II	9400	1880.0	Fig.47	Pass
			Fig.48	Pass

Fig.41 GSM850 on Channel 189 30MHz~3GHz

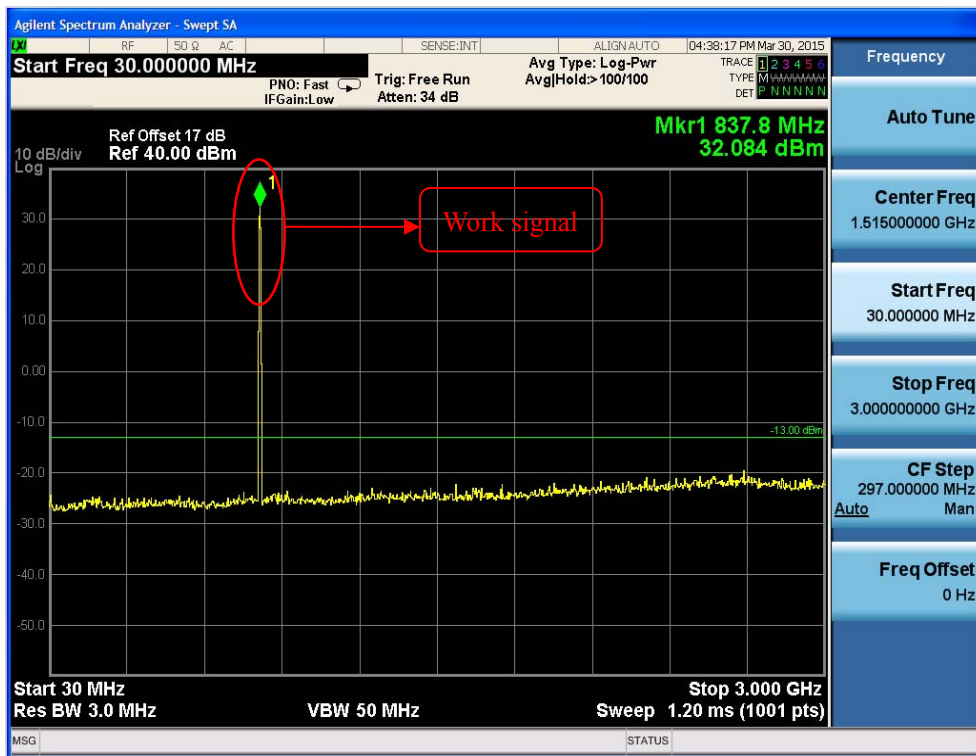

Fig.42 GSM850 on Channel 189 3GHz~9GHz

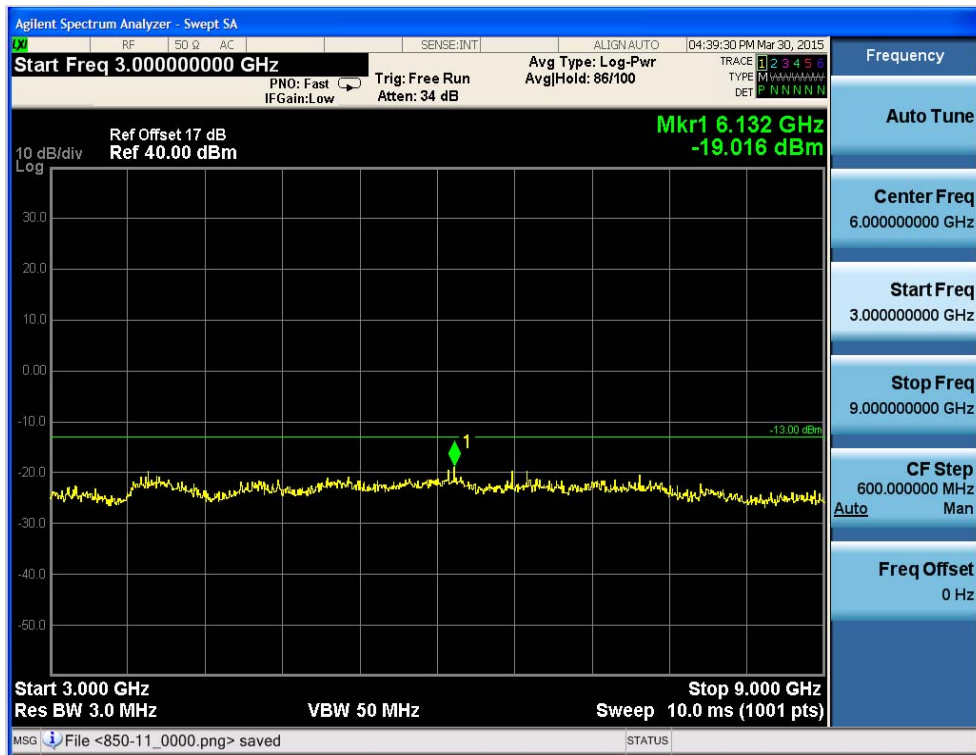



Fig.43 GSM1900 on Channel 661 30MHz~3GHz

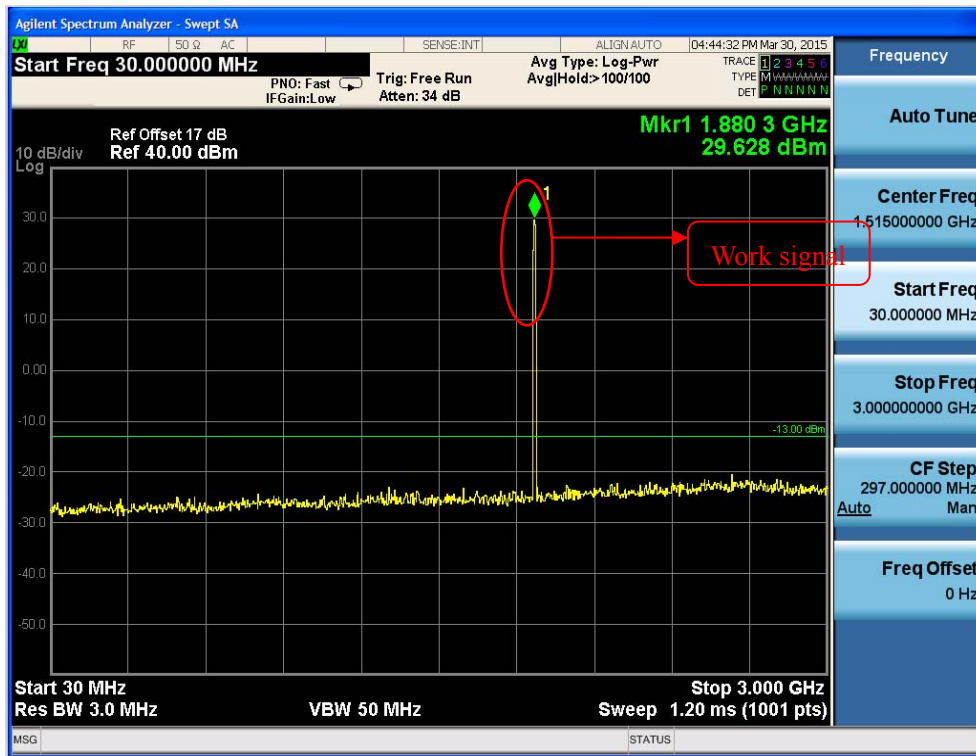

Fig.44 GSM1900 on Channel 661 3GHz~19.1GHz



The Conducted Spurious Emissions was checked. No emissions were found and only noise floor in 13.8GHz~19.1GHz.

Fig.45 WCDMA Band V on Channel 4175 30MHz~3GHz

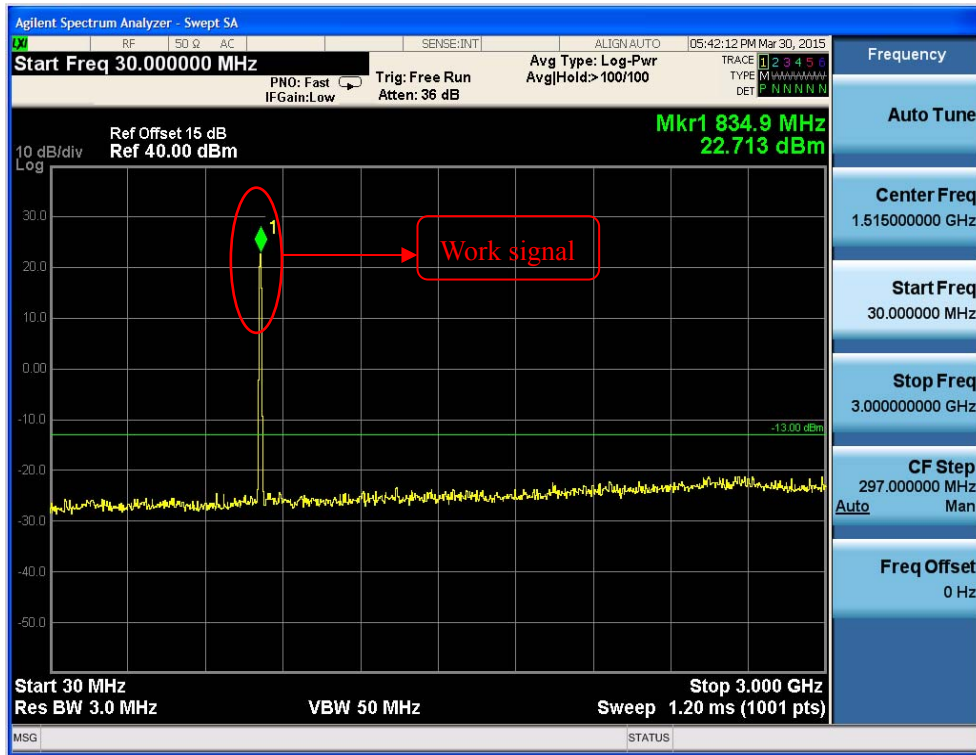

Fig.46 WCDMA Band V on Channel 4175 3GHz~9GHz

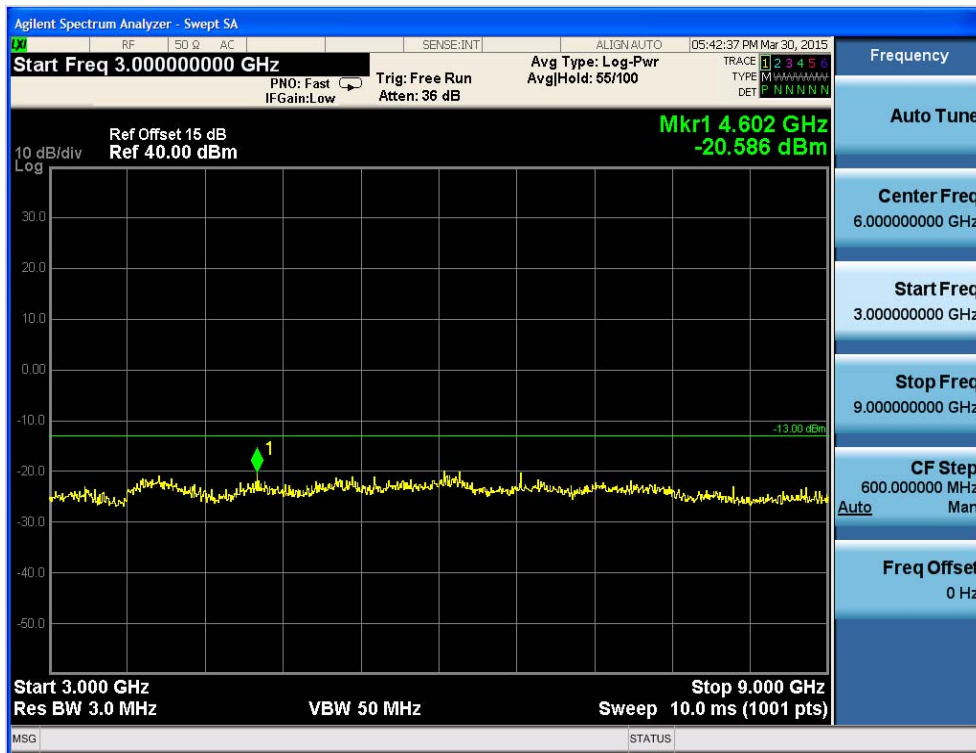

Fig.47 WCDMA Band II Channel 9400 30MHz~3GHz

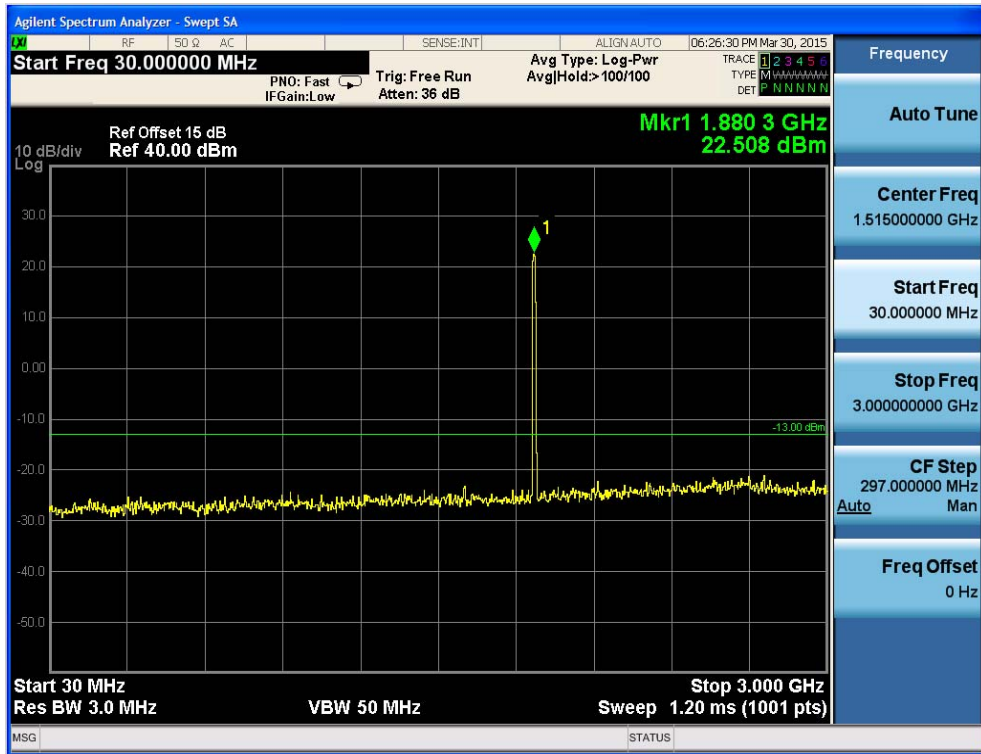

Fig.48 WCDMA Band II on Channel 9400 3GHz~19.1GHz



The Conducted Spurious Emissions was checked. No emissions were found and only noise floor in 13.8GHz~19.1GHz

## B.7 Peak-to-average ratio(24.232(d))

### B.8.1 Description

Power Complementary Cumulative Distribution Function (CCDF) curves provide a means for characterizing the power peaks of a digitally modulated signal on a statistical basis. A CCDF curve depicts the probability of the peak signal amplitude exceeding the average power level.

### B.8.2 Test Procedure

1. The EUT was connected to Spectrum Analyzer and Base Station.
2. The CCDF of middle channel for the highest powers were measured.

### B.8.3 Test Setup

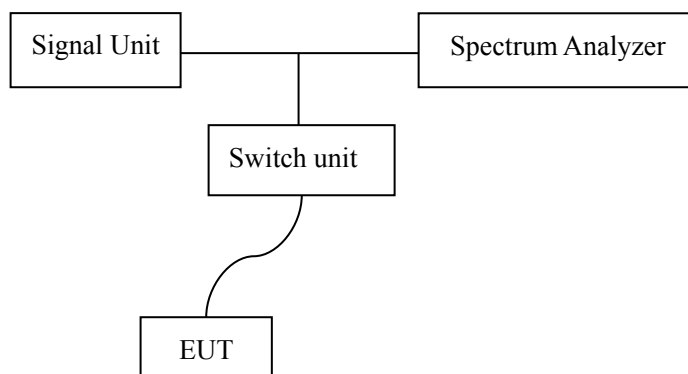

### B.7.4 Test Results

#### Limit

Peak-to-average ratio
≤13dBm

Band	CH	Frequency(MHz)	Result(dBm)	Verdict	
GSM850	GSM	128	824.2	0.11	Pass
		189	836.6	0.09	Pass
		251	848.8	0.09	Pass
	GPRS	128	824.2	0.06	Pass
		189	836.6	0.16	Pass
		251	848.8	0.11	Pass
GSM1900	GSM	512	1850.2	0.13	Pass
		661	1880.0	0.08	Pass
		810	1909.8	0.1	Pass
	GPRS	512	1850.2	0.05	Pass
		661	1880.0	0.11	Pass
		810	1909.8	0.13	Pass
WCDMA Band V	4132	824.2	0.08	Pass	
	4175	835	0.1	Pass	
	4233	848.8	0.06	Pass	

WCDMA Band V HSDPA Subtest 1	4132	824.2	0.12	Pass
	4175	835	0.1	Pass
	4233	848.8	0.14	Pass
WCDMA Band V HSUPA Subtest 5	4132	824.2	0.04	Pass
	4175	835	0.11	Pass
	4233	848.8	0.11	Pass
WCDMA Band II	9263	1850.2	0.09	Pass
	9400	1880.0	0.1	Pass
	9538	1909.8	0.06	Pass
WCDMA Band II HSDPA Subtest 1	9263	1850.2	0.11	Pass
	9400	1880.0	0.06	Pass
	9538	1909.8	0.09	Pass
WCDMA Band II HSUPA Subtest 5	9263	1850.2	0.11	Pass
	9400	1880.0	0.06	Pass
	9538	1909.8	0.08	Pass

**\*\*\* END OF REPORT\*\*\***