

FCC RADIO TESTREPORT

No. 150220-RF

for

MFOURTEL MEXICO S.A. DE C.V.

Mobile Phone

Model M4 SS4345

Trade Name: M4

Issued Date: 2015-03-17

Note:

The test results in this test report relate only to the devices specified in this report. This report shall not be reproduced except in full without the written approval of GCCT.

Test Laboratory:

GCCT, *Guangdong Telecommunications Terminal Products Quality Supervision and Testing Center*

Technology Road, High-tech Zone, He Yuan, Guang Dong, PR China 517001

Tel:+86(0)762-3607181, Fax:+86(0)762-3603336 Email: nctmail@126.com. www.ncct.org.cn

CONTENTS

GENERAL SUMMARY	3
1.Test Laboratory	4
1.1 Testing Location.....	4
1.2Testing Environment.....	4
1.3.Project Data.....	4
2.Client Information	4
2.1Applicant Information.....	4
2.2Manufacturer Information.....	4
3.Equipment Under Test (EUT) and Ancillary Equipment (AE)	5
3.1About EUT.....	5
3.2Internal Identification of EUT.....	6
3.3Internal Identification of AE	6
4.Test Results.....	6
4.1Summary of Test Results	6
4.2Statements.....	7
5.Test Equipments Utilized	7
5.1List of Measuring Equipment	7
5.2Climate Chamber	8
ANNEX A: EUT Photograph	9
ANNEX B: Detailed Test Results	18
B.1 Output Power(22.913(a)/24.232(b)).....	18
B.2 Frequency Stability(22.355/24.235).....	22
B.3 Occupied Bandwidth(22.917(a)/24.238(b))	24
B.4 Emission Limit(22.917(b)/ 24.238(b)).....	38
B.5 Band Edge Compliance(22.917(b)/ 24.238).....	42
B.6 Conducted Spurious Emission(22.917(a)/24.238(a)).....	51
B.7Peak-to-average ratio(24.232(d))	56

GENERAL SUMMARY

Product Name	Mobile Phone
Model Name	M4 SS4345
Applicant	MFOURTEL MEXICO S.A. DE C.V.
Manufacturer	CK Telecom Limited
Test Laboratory	GCCT, Guangdong Telecommunications Terminal Products Quality Supervision and Testing Center
Reference Standards	FCC CFR 47 Part 22(H):“FCC CFR 47 Part 22:Public Mobile Services” FCC CFR 47 Part 24(E):“FCC CFR 47 Part 24:Radio Frequency Devices”
Test Conclusion	This portable wireless equipment has been measured in all cases requested by the relevant standards. Test results in annex B of this test report are below limits specified in the relevant standards. General Judgment: Pass Date of issue:2015.03.17
Comment	The test results in this report apply only to the tested sample of the stated device/equipment.

Approved by:

Luo Jian

LuoJian
Manager

Reviewed by:

Xiaoyong wen

Wen Xiaoyong
Deputy Manager

Tested by:

xuan wu

Wu Xuan
Test Engineer

1. Test Laboratory

1.1 Testing Location

Company Name:	GCCT, Guangdong Telecommunications Terminal Products Quality Supervision and Testing Center
FCC Registration No.	303878
CNAS Registration No.	L4992
Address:	Technology Road, High-tech Zone, Heyuan, Guangdong Province, PR.China
Postal Code:	517001
Telephone:	+86-762-3607181
Fax:	+86-762-3603336

1.2 Testing Environment

Environment Data	Temperature(°C)	Humidity(%)
Maximum Ambient	26.9	45
Minimum Ambient	20.9	27

EUT is under testing environment.

1.3 Project Data

Project Leader:	Wen Xiaoyong
Testing Start Date:	2015-02-10
Testing End Date:	2015-03-17

2. Client Information

2.1 Applicant Information

Company Name:	MFOURTEL MEXICO S.A. DE C.V.
Address:	Av.Ejercito Nacional 436 Piso 3 Chapultepec, Morales Miguel Hidalgo D.F 11570
City:	Mexico
Postal Code:	/
Country:	Mexico
Telephone:	/
Fax:	/

2.2 Manufacturer Information

Company Name:	CK Telecom Limited
---------------	--------------------

Address:	Technology Road.High-Tech Development Zone. Heyuan
City:	Heyuan
Postal Code:	/
Country:	China
Telephone:	0755-26738515
Fax:	0755-26739500

3.Equipment Under Test (EUT) and Ancillary Equipment (AE)

3.1About EUT

Model Name	M4 SS4345
FCC ID	CLNSS4345
Tx Frequency	GSM850:824.2~848.8 MHz UMTS Band V : 826.4~846.6MHz PCS1900 TX: 1850.2~1909.8MHz UMTS Band II TX: 1852.4~1907.6MHz Bluetooth/BLE: 2402 ~ 2480 MHz WIFI(802.11b/g/n-20): 2412 ~ 2462 MHz WIFI(n-40): 2422 ~ 2452 MHz
Rx Frequency	GSM850:869.2~893.8 MHz UMTS Band V : 871.4~891.6 MHz PCS1900 TX: 1930.2~1989.8 MHz UMTS Band II TX: 1932.4~1987.6 MHz Bluetooth/BLE: 2402 ~ 2480 MHz WIFI(802.11b/g/n-20): 2412 ~ 2462 MHz WIFI(n-40): 2422 ~ 2452 MHz
Number of Channels	GSM850&WCDMA Band V:25 PCS1900&WCDMA Band II: 60 Bluetooth:79 WIFI(802.11b/g/n-20):11 WIFI(n-40):7 BLE:40
Modulation	GSM&DCS:GMSK WCDMA:BPSK/QPSK Bluetooth: GFSK& $\pi/4$ -DQPSK&8DPSK WIFI:CCK/OFDM BLE:GFSK
Antenna Type	PIFA(GSM/DCS/WCDMA); MONOPOLE (Bluetooth/WIFI)

Antenna Gain	GSM850:-0.5dBi DCS1900: -0.5dBi WCDMA850: -1dBi WCDMA1900: -1dBi Bluetooth/BLE/WIFI: -1dBi
Emission Designator	GSM850:245KGXW DCS1900:247KGXW WCDMA850:4M16F9W WCDMA1900:4M16F9W
Normal Voltage	3.7V
Extreme Low Voltage	3.6V
Extreme High Voltage	4.2V
Extreme Low Temperature	0°C
Extreme High Temperature	45°C

Note: Photographs of EUT are shown in ANNEX A of this test report.

Note: high and low voltage values in extreme condition test are given by manufacturer

3.2 Internal Identification of EUT

EUT ID *	IMEI	HW Version	SW Version
150220-M03	867040020000608	SLFQPLUS-V1.0	SLFQPLUS15A-S00A_CKT_L2EN_102_150130
150220-M04	867041020002149	SLFQPLUS-V1.0	SLFQPLUS15A-S00A_CKT_L2EN_102_150130

*EUT ID: is used to identify the test sample in the lab internally.150220-M03and 150220-M04 are the same mobile phones.

3.3 Internal Identification of AE

AE ID *	Description	Type	SN
150220-C03	Charger	A8-501000	/
150220-B03	Battery	M1700A	/
150220-C04	Charger	A8-501000	/
150220-B04	Battery	M1700A	/

*AE ID: is used to identify the test sample in the lab internally.

4. Test Results

4.1 Summary of Test Results

Items	List	Clause in FCC	Verdict
-------	------	---------------	---------

1	Output Power	22.913(a)/24.232(b)	Pass
2	Frequency Stability	22.355/24.235	Pass
3	Occupied Bandwidth	22.917(a)/24.238(b)	Pass
4	Emission Limit	22.917(b)/ 24.238(b)	Pass
5	Band Edge Compliance	22.917(b)/ 24.238	Pass
6	Conducted Spurious Emission	22.917(a)/24.238(a)	Pass
7	Peak-to-average ratio	24.232(d))	Pass

Note: please refer to Annex B in this test report for the detailed test results.

4.2 Statements

GCCT has evaluated the test cases requested by the applicant/manufacturer as listed in section 4.1 of this report, for the EUT specified in section 3, according to the standards or reference documents listed in general summary.

5. Test Equipments Utilized

5.1 List of Measuring Equipment

Table 1. RF Test Equipments

No.	Name	Type	SN	Manufacturer	Cal Date	Cal Due Date
1	Signaling Tester	E5515E	E0111-8	Agilent	2014.08.13	2015.08.13
2	Spectrum Analyzer	N9020A	E0111-9	Agilent	2014.08.13	2015.08.13
3	Switching Unit	/	E0112	/	/	

Table 2. EMC Test Equipments

Hardware						
No.	Name	Type	SN	Manufacturer	Cal Date	Cal Due Date
1	Spectrum	E4440A	MY48250641	Agilent	2014.08.13	2015.08.13
2	RF Preselector	N9039A	MY48260024	Agilent	2014.08.13	2015.08.13
3	BiCoNilog	3142E	00142015	ETS-Lindgren	2014.08.13	2015.08.13
4	Horn Antenna	3117	00129169	ETS-Lindgren	2014.08.13	2015.08.13
5	RF Notch filter	/	/	ETS-Lindgren	2014.08.13	2015.08.13
6	Power Meter	N1913A	MY50000213	Agilent	2014.08.13	2015.08.13
7	Universal Radio Communication Tester	8960	MY48367105	Agilent	2014.08.13	2015.08.13

Software					
1	Software	TILE4.5	/	ETS-Lindgren	/

Table 3. OTA Test Equipments

Hardware						
No.	Name	Type	SN	Manufacturer	Cal Date	Cal Due Date
1	Spectrum	N9020A	MY49101012	Agilent	2014.08.13	2015.08.13
2	Universal Radio	E5515C	MY48367103	Agilent	2014.08.13	2015.08.13
3	Switch/Control Mainframe	3499C	MY42000534	Agilent	2014.08.13	2015.08.13
4	Positioning	2090	00119389	ETS-Lindgren	2014.08.13	2015.08.13
Software						
1	Software	EMQuest™	/	ETS-Lindgren	/	/
2	Software	EMQ-108	/	ETS-Lindgren	/	/

5.2 Climate Chamber

No.	Name	Type	SN	Manufacturer	Cal Date	Cal Due Date
1	Climate Chamber	SH-241	92003546	ESPEC	2014.08.13	2015.08.13

ANNEX A: EUT Photograph

EUT Front View



EUT behind View



EUT Left View



EUT Right View

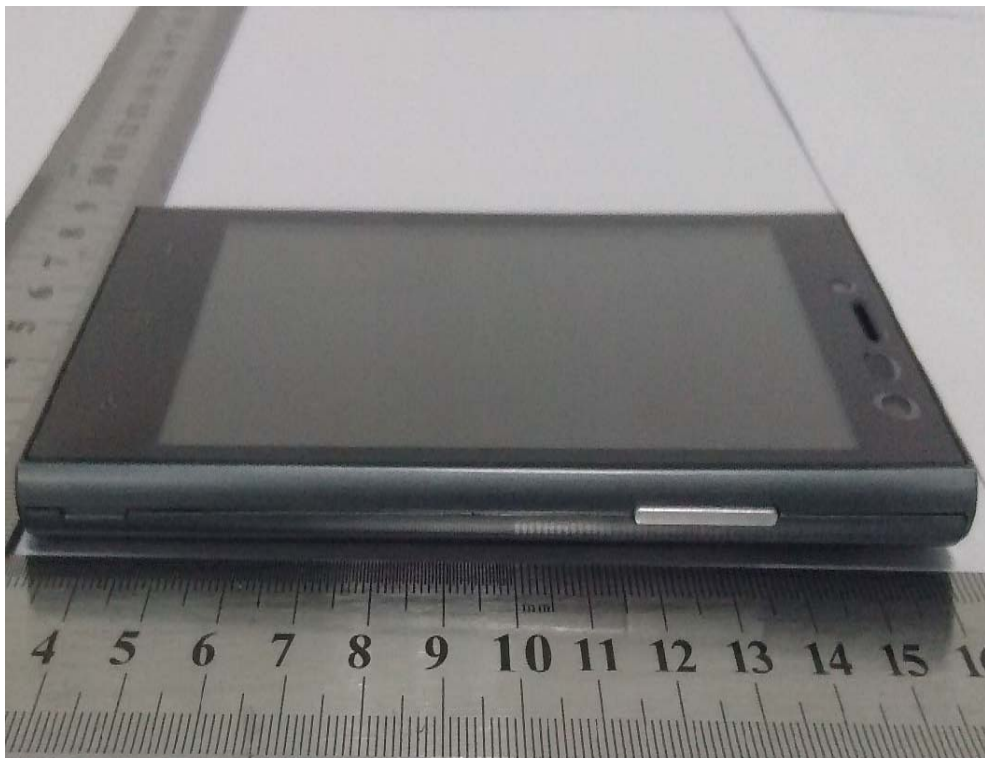

EUT Top View

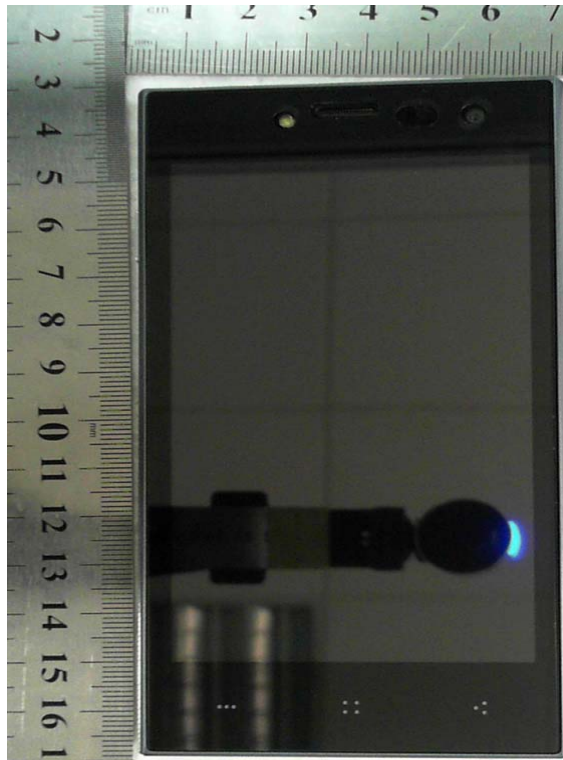

EUT Rear View



All



Cover off



Main board With shielding Front View

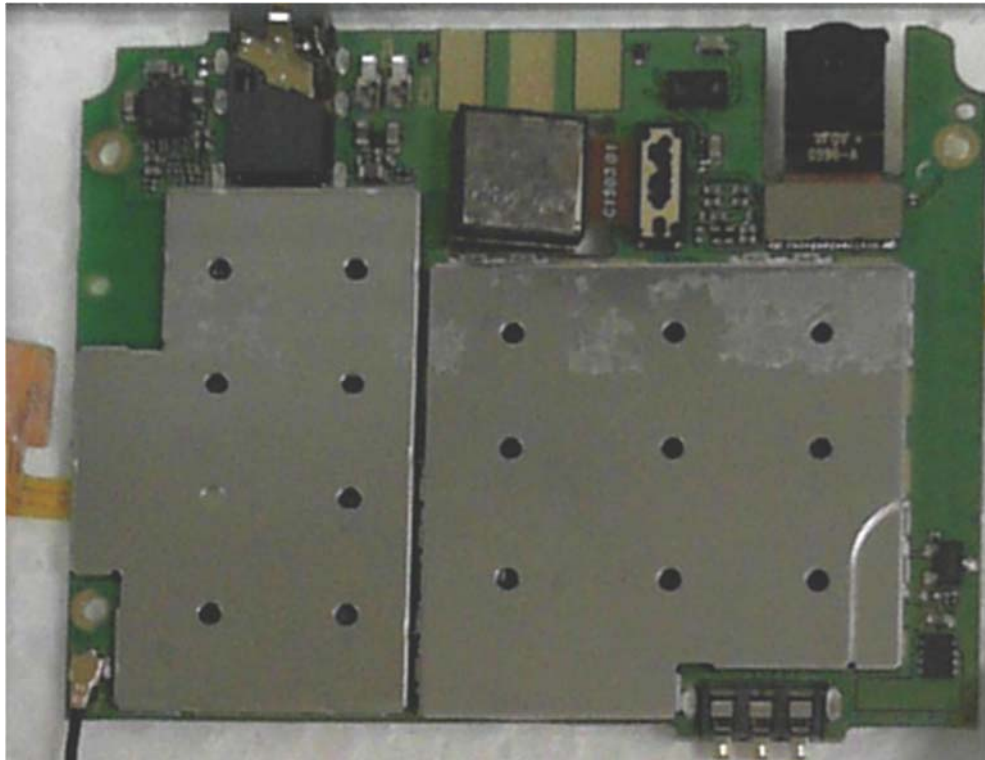

Main board Without shielding Front View

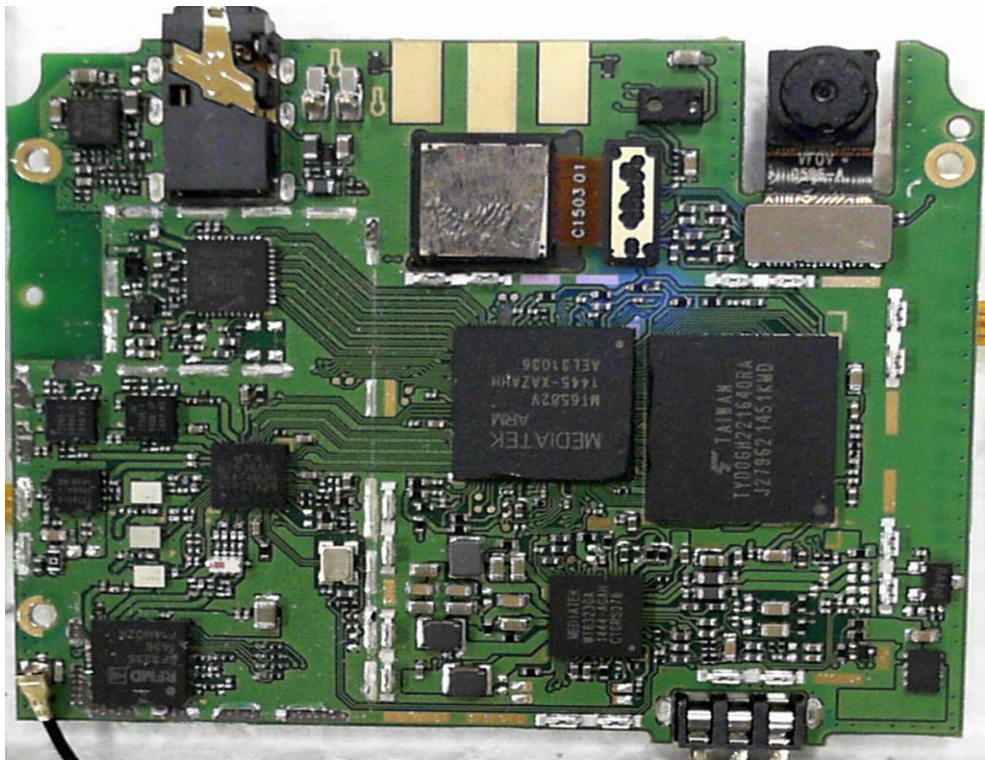

Main board Rear

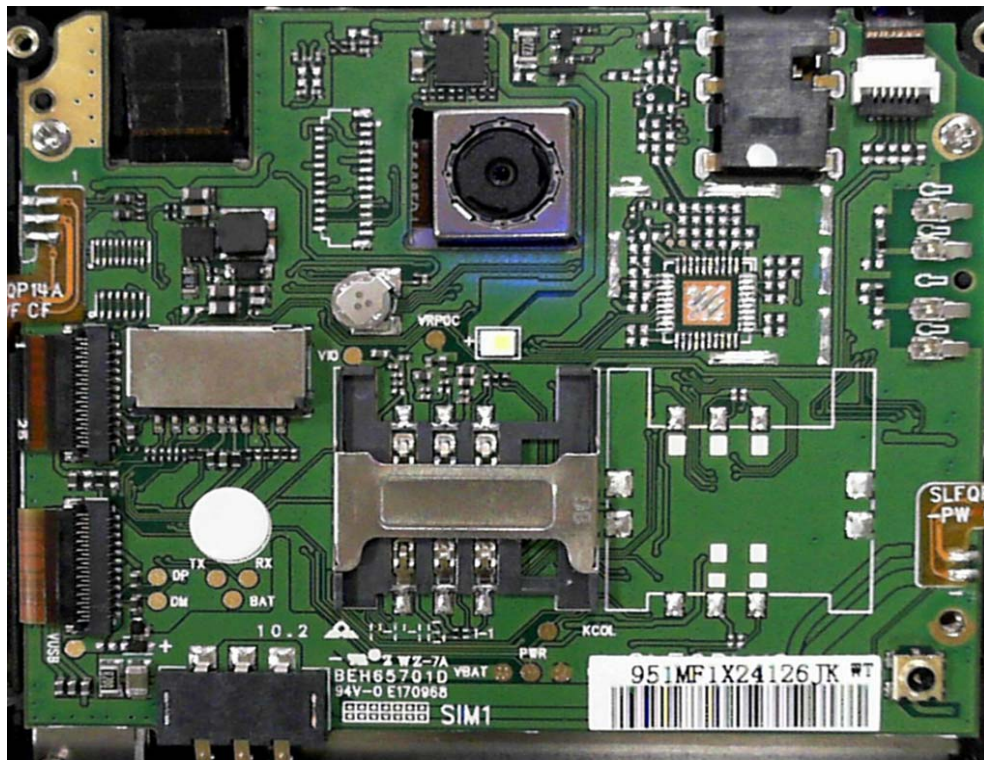

Battery Front View



USB Cable



Headset



GSM/DCS/UMTS Antenna View



BT/WIFI Antenna View

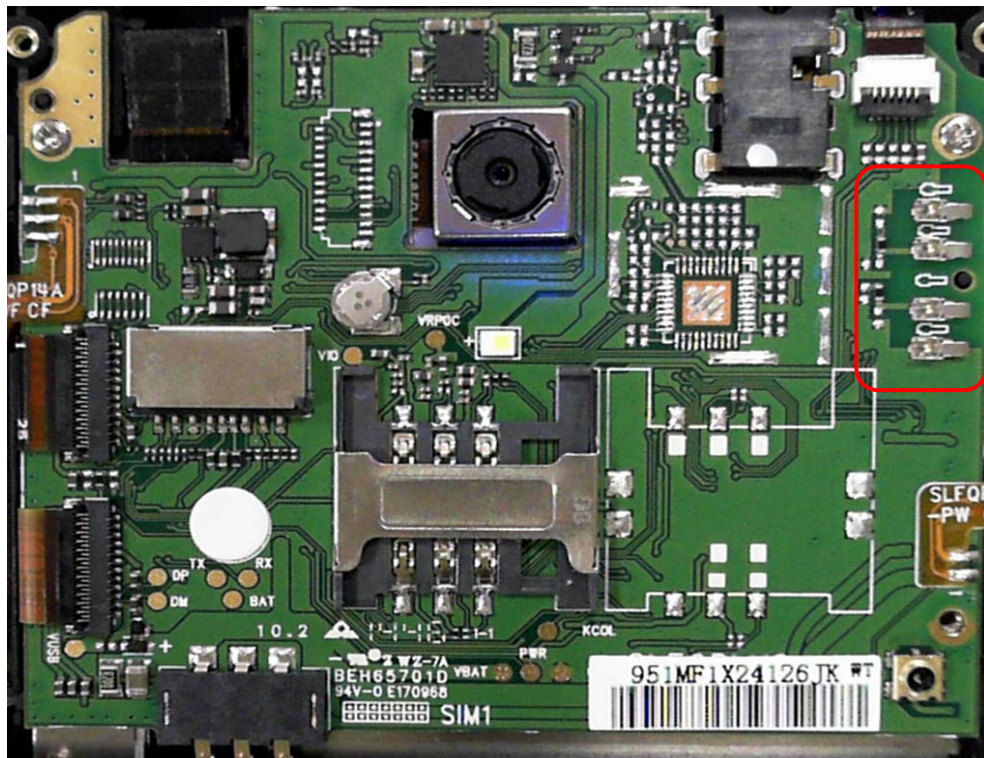

Adapter



ANNEX B: Detailed Test Results

B.1 Output Power(22.913(a)/24.232(b))

B.1.1 Conducted Output Power Measurement

B.1.1.1 Description

A base station simulator was used to establish communication with the EUT. Its parameters were set to transmit the maximum power on the EUT. The measured power in the radio frequency on the transmitter output terminals shall be reported.

B. 1.1.2 Test Procedures

1. The transmitter output port was connected to base station.
2. Set EUT as maximum power through base station.
3. There measurements were done at 3 frequencies,824.2MHz, 836.6MHz and 848.8MHz for GSM850 band;1850.2MHz, 1880.0MHz and 1909.8MHz for PCS1900 band.

B.1.1.3 Test Setup



B.1.1.4 Test Results

GSM850

Measurement result

GSM

Frequency(MHz)	Channel No.	Power Step	Peak output power(dBm)	Verdict
824.2	128	5	32.28	Pass
836.6	190		32.34	Pass
848.8	251		32.39	Pass

GPRS

Frequency(MHz)	Channel No.	Power Step	Peak output power(dBm)	Verdict
824.2	128	5	32.24	Pass
836.6	190		32.33	Pass
848.8	251		32.35	Pass

PCS1900

Measurement result

GSM

Frequency(MHz)	Channel No.	Power Step	Peak output power(dBm)	Verdict
1850.2	512	0	30.24	Pass
1880.0	661	0	30.16	Pass
1909.8	810	0	30.03	Pass

GPRS

Frequency(MHz)	Channel No.	Power Step	Peak output power(dBm)	Verdict
1850.2	512	5	30.23	Pass
1880.0	661		29.47	Pass
1909.8	810		30.08	Pass

WCDMA Band V and Band II

Band II

Band/Time slot configuration	Frequency(MHz)	Channel	Power Class	Peak output power(dBm)	Verdict
RMC (12.2kbps)	1852.6	9263	3	22.92	Pass
	1880.0	9400		22.16	
	1907.6	9538		22.25	
HSDPA Subtest 1	1852.6	9263		22.13	Pass
	1880.0	9400		21.99	
	1907.6	9538		21.66	
HSDPA Subtest 2	1852.6	9263		22.13	Pass
	1880.0	9400		21.89	
	1907.6	9538		21.86	
HSDPA Subtest 3	1852.6	9263		21.67	Pass
	1880.0	9400		21.51	
	1907.6	9538		21.21	
HSDPA Subtest 4	1852.6	9263		21.65	Pass
	1880.0	9400		21.51	
	1907.6	9538		21.18	
HSUPA Subtest 1	1852.6	9263		20.31	Pass
	1880.0	9400		20.09	
	1907.6	9538		19.75	
HSUPA Subtest 2	1852.6	9263		20.3	Pass
	1880.0	9400		20.08	
	1907.6	9538		19.72	
HSUPA Subtest 3	1852.6	9263	21.29	Pass	
	1880.0	9400	21.07		
	1907.6	9538	20.73		
HSUPA Subtest 4	1852.6	9263	19.77	Pass	
	1880.0	9400	19.54		
	1907.6	9538	19.19		
HSUPA Subtest 5	1852.6	9263	22.27	Pass	
	1880.0	9400	22.07		
	1907.6	9538	21.71		

Band V

Band/Time slot configuration	Frequency(MHz)	Channel	Power Class	Peak output power(dBm)	Verdict
------------------------------	----------------	---------	-------------	------------------------	---------

RMC (12.2kbps)	826.6	4133	3	23.01	Pass
	835.0	4175		22.98	
	846.4	4232		23.12	
HSDPA Subtest 1	826.6	4133		22.03	Pass
	835.0	4175		21.99	
	846.4	4232		21.59	
HSDPA Subtest 2	826.6	4133		22.03	Pass
	835.0	4175		22.01	
	846.4	4232		21.59	
HSDPA Subtest 3	826.6	4133		21.57	Pass
	835.0	4175		21.54	
	846.4	4232		21.13	
HSDPA Subtest 4	826.6	4133		21.55	Pass
	835.0	4175		21.51	
	846.4	4232		21.1	
HSUPA Subtest 1	826.6	4133		20.55	Pass
	835.0	4175		20.15	
	846.4	4232		19.3	
HSUPA Subtest 2	826.6	4133		20.54	Pass
	835.0	4175		20.15	
	846.4	4232		19.29	
HSUPA Subtest 3	826.6	4133		21.53	Pass
	835.0	4175		21.15	
	846.4	4232		20.30	
HSUPA Subtest 4	826.6	4133		20	Pass
	835.0	4175		19.62	
	846.4	4232		18.77	
HSUPA Subtest 5	826.6	4133		22.51	Pass
	835.0	4175		22.12	
	846.4	4232		21.26	

B.1.2 Radiated Power

B.1.2.1 Description

This is the test for the maximum radiated power from the EUT. Rule Part 24.232(b) specifies, "Mobile/portable stations are limited to 2 watts e.i.r.p. Peak power and 24.232(c) specifies that "Peak transmit power must be measured over any interval of continuous transmission using instrumentation calibrated in terms of an rms-equivalent voltage." Rule Part 22.913(a) specifies "Maximum ERP. The effective radiated power (ERP) of base transmitters and cellular repeaters must not exceed 500 Watts. The ERP of mobile transmitters and auxiliary test transmitters must not exceed 7 Watts."

B.1.2.2 Test Procedures

1. In an anechoic antenna test chamber, a half-wave dipole antenna for the frequency band of interest is placed at the reference centre of the chamber. An RF Signal source for the frequency band of interest is connected to the dipole with a cable that has been constructed to not interfere with the

radiation pattern of the antenna. A known (measured) power (P_{in}) is applied to the input of the dipole, and the power received (P_r) at the chamber's probe antenna is recorded.

2. A "reference path loss" is established as $P_{in} + 2.15 - P_r$.
3. The EUT is substituted for the dipole at the reference centre of the chamber and a scan is performed to obtain the radiation pattern.
4. From the radiation pattern, the co-ordinates where the maximum antenna gain occurs are identified.
5. The EUT is then put into pulse mode at its maximum power level (Power Step 0 for PCS1900,5 for GSM 850).
6. "Gated mode" power measurements are performed with the receiving antenna placed at the coordinates determined in Step 3 to determine the output power as defined in Rule 24.232 (b) and (c). The "reference path loss" from Step 1 is added to this result.
7. This value is EIRP since the measurement is calibrated using a half-wave dipole antenna of known gain (2.15 dBi) and known input power (P_{in}).
8. ERP can be calculated from EIRP by subtracting the gain of the dipole, $ERP = EIRP - 2.15\text{dBi}$.

B.1.2.3 Test Setup

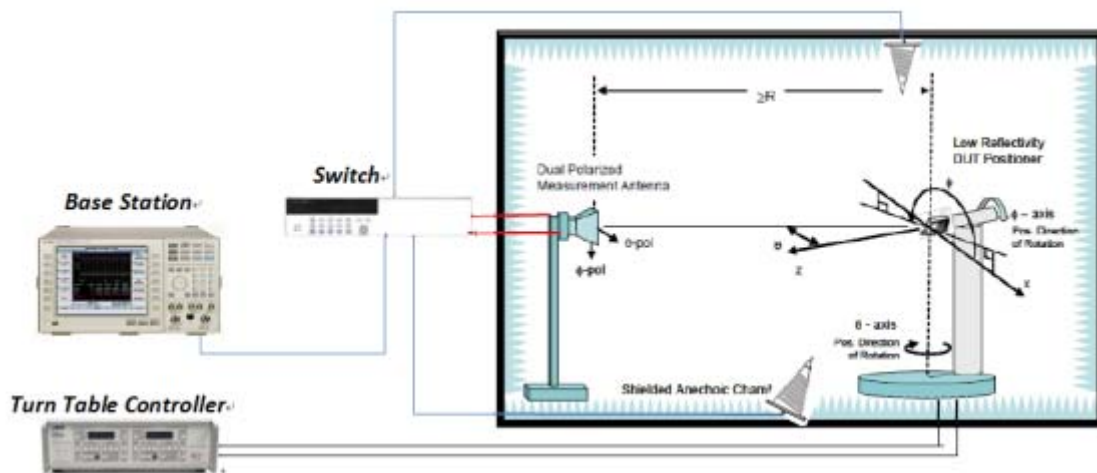

B.1.2.4 Test Result of ERP

GSM850

Frequency(MHz)	Channel No.	Power Step	ERP(dBm)	Verdict
824.2	128	5	28.07	Pass
836.6	190	5	28.17	Pass
848.8	251	5	28.14	Pass

WCDMA Band V

Frequency(MHz)	Channel No.	Power Step	ERP(dBm)	Verdict
826.6	4133	3	21.59	Pass
835	4175	3	20.83	Pass
846.4	4232	3	21.52	Pass

B1.2.4 Test Result of EIRP

GSM1900

Frequency(MHz)	Channel	Power Step	EIRP(dBm)	Verdict
1850.2	512	0	31.60	Pass
1880.0	661	0	31.38	Pass
1909.8	810	0	31.16	Pass

WCDMA Band II

Frequency(MHz)	Channel	Power Class	EIRP(dBm)	Verdict
1852.6	9263	3	24.32	Pass
1880.0	9400	3	24.30	Pass
1907.6	9538	3	23.02	Pass

B.2 Frequency Stability(22.355/24.235)

B.2.1 Description

The frequency stability shall be measured by variation of ambient temperature and variation of primary supply voltage to ensure that fundamental emission stays within the authorized frequency block. The frequency stability of transmitter shall be maintained within $\pm 0.00023\%$ ($\pm 2.5\text{ppm}$) of the center frequency.

B.2.2 Test Procedure for Temperature Variation

1. The EUT was set up in the thermal chamber and connected with the base station.
2. With power OFF, the temperature was decreased to -20°C and the EUT was stabilized for three hours. Power was applied and maximum change in frequency was recorded within one minute.
3. With power OFF, the temperature was raised in 10°C step to 50°C . The EUT was stabilized at each step for at least half an hour. Power was applied and the maximum frequency change was recorded within one minute.
4. if the EUT cannot be turned on at -30°C , the testing lowest temperature will be raised in 10°C step until the EUT can be turned on.

B.2.2.1 Test Setup

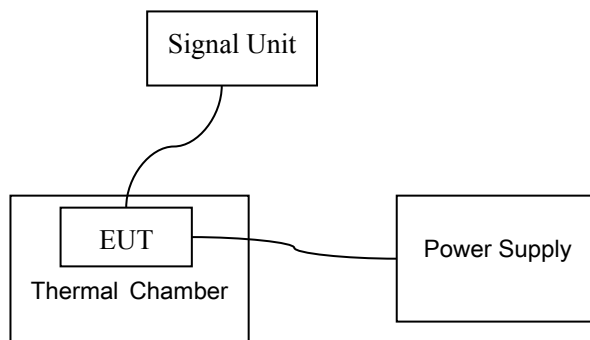

B.2.2.2 Test Results

GSM850

Temperature ($^{\circ}\text{C}$)	Frequency Error (Hz)	ppm	Limit	Verdict
-20	/	/	$\leq \pm 2.5\text{ppm}$	Pass
-10	/	/		Pass
0	0.58	0.0006		Pass
10	-3.56	-0.0042		Pass

20	-2.08	-0.0024		Pass
30	1.20	0.0014		Pass
40	-3.97	-0.0047		Pass
50	/	/		Pass
55	/	/		Pass

GSM1900

Temperature (°C)	Frequency Error (Hz)	ppm	Limit	Verdict
-20	/	/	≤±2.5ppm	Pass
-10	/	/		Pass
0	3.03	0.0016		Pass
10	0.47	0.0002		Pass
20	11.07	0.0058		Pass
30	7.01	0.0036		Pass
40	3.32	0.0017		Pass
50	/	/		Pass
55	/	/		Pass

WCDMA Band II

Temperature (°C)	Frequency Error (Hz)	ppm	Limit	Verdict
-20	/	/	≤±2.5ppm	Pass
-10	/	/		Pass
0	4.13	0.0049		Pass
10	-0.44	0.0005		Pass
20	-1.20	0.0014		Pass
30	6.09	0.0072		Pass
40	0.13	0.0002		Pass
50	/	/		Pass
55	/	/		Pass

WCDMA Band V

Temperature (°C)	Frequency Error (Hz)	ppm	Limit	Verdict
-20	/	/	≤±2.5ppm	Pass
-10	/	/		Pass
0	-3.6	-0.0019		Pass
10	1.05	0.0006		Pass
20	-0.95	0.0005		Pass
30	1.11	0.0006		Pass
40	1.21	0.0006		Pass
50	/	/		Pass
55	/	/		Pass

B.2.3 Test Procedure for Voltage Variation

1. The EUT was placed in a temperature chamber at 25±5°C and connected with the base station.
2. The power supply voltage to the EUT was varied from BEP to 115% of the nominal value measured at the input to the EUT.
3. The variation in frequency was measured.

B.2.3.1 Test Setup

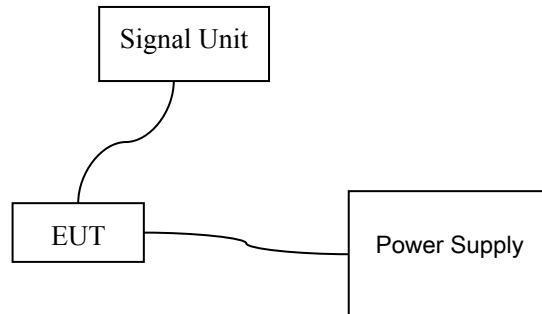

B.2.3.2 Test Results:

Band	Voltage (V)	Freq.Dev.(Hz)	Dev.(ppm)	Limit(ppm)	Verdict
GSM850	3.6	-5.70	0.0067	≤±2.5ppm	Pass
	3.7	1.02	0.0012		Pass
	4.2	-0.03	0.0002		Pass
GSM1900	3.6	-5.89	-0.0031		Pass
	3.7	-4.42	-0.0023		Pass
	4.2	-3.16	-0.0017		Pass
WCDMA Band II	3.6	3.15	0.0017		Pass
	3.7	2.56	0.0013		Pass
	4.2	-3.03	0.0016		Pass
WCDMA Band V	3.6	-4.60	-0.0054		Pass
	3.7	4.12	0.0048		Pass
	4.2	5.23	0.0062		Pass

B.3 Occupied Bandwidth(22.917(a)/24.238(b))

B.3.1 Description

Similar to conducted emissions; occupied bandwidth measurements are only provided for selected frequencies in order to reduce the amount of submitted data. Data were taken at the extreme and mid frequencies of the USPCS frequency band. The table below lists the measured -20dBc BW(99%). Spectrum analyzer plots are included on the following pages.

B.3.2 Test Setup

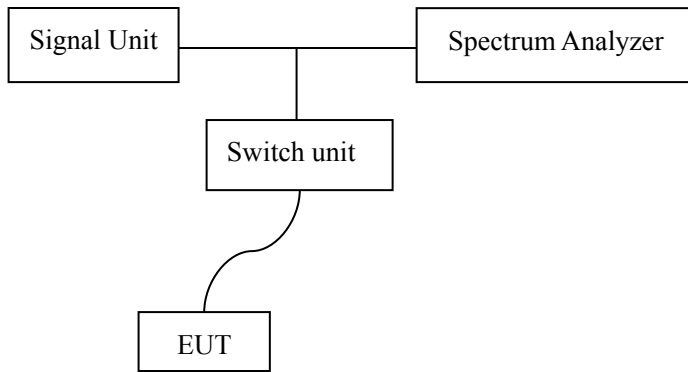

B.3.3 Test Results

Band	CH	Frequency(MHz)	Result	Verdict
GSM850	128	824.2	Fig.1	Pass
	190	836.6	Fig.2	Pass
	251	848.8	Fig.3	Pass
GSM1900	512	1850.2	Fig.4	Pass
	661	1880.0	Fig.5	Pass
	810	1909.8	Fig.6	Pass
WCDMA Band V	4133	826.6	Fig.7	Pass
	4175	835	Fig.8	Pass
	4233	846.4	Fig.9	Pass
WCDMA Band V HSDPA Subtest 1	4133	826.6	Fig.10	Pass
	4175	835	Fig.11	Pass
	4233	846.4	Fig.12	Pass
WCDMA Band V HSUPA Subtest 5	4133	826.6	Fig.13	Pass
	4175	835	Fig.14	Pass
	4233	846.4	Fig.15	Pass
WCDMA Band II	9263	1852.6	Fig.16	Pass
	9400	1880.0	Fig.17	Pass
	9538	1907.6	Fig.18	Pass
WCDMA Band II HSDPA Subtest 1	9263	1852.6	Fig.19	Pass
	9400	1880.0	Fig.20	Pass
	9538	1907.6	Fig.21	Pass
WCDMA Band II HSUPA Subtest 5	9263	1852.6	Fig.22	Pass
	9400	1880.0	Fig.23	Pass
	9538	1907.6	Fig.24	Pass

Fig.1 GSM850-CH128 Occupied Bandwidth

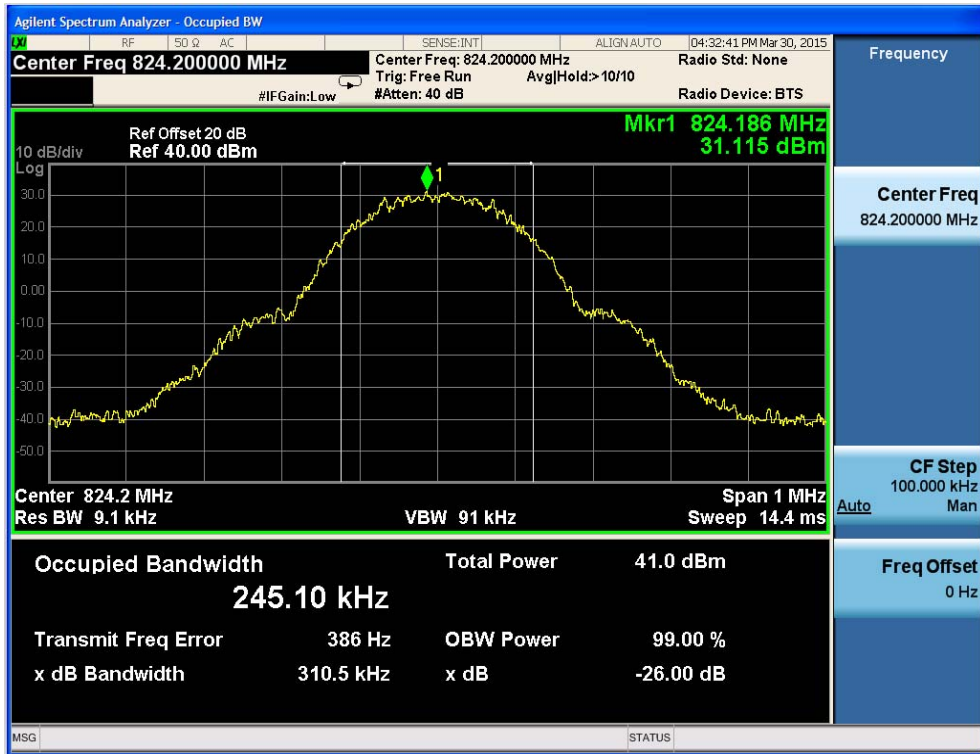

Fig.2 GSM850-CH190 Occupied Bandwidth

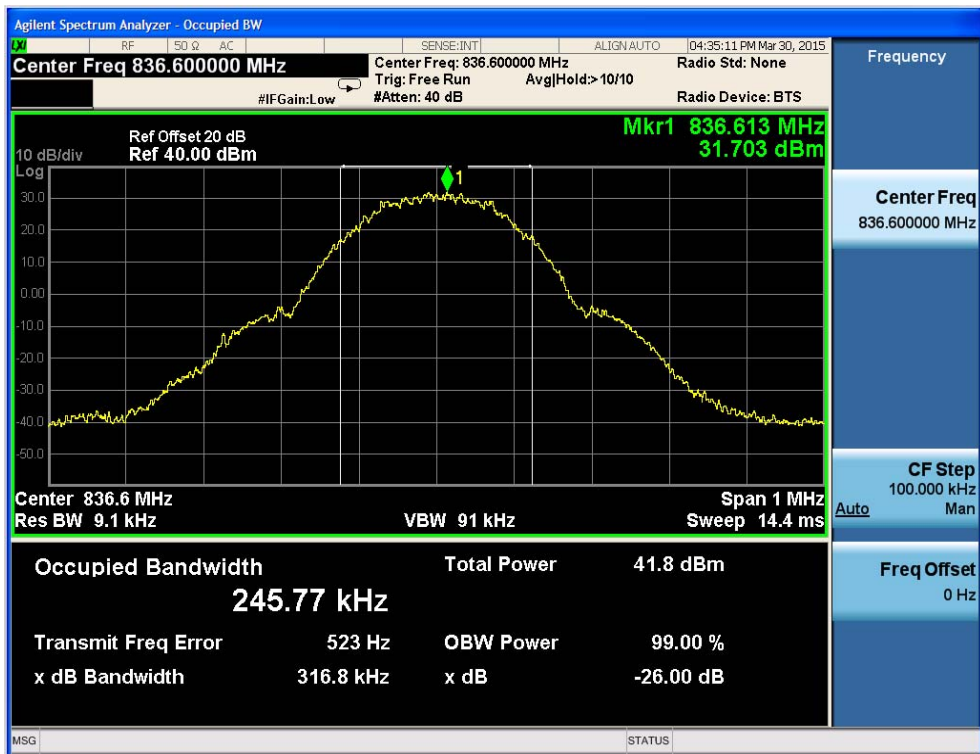

Fig.3 GSM850-CH251 Occupied Bandwidth



Fig.4 GSM1900-CH512 Occupied Bandwidth

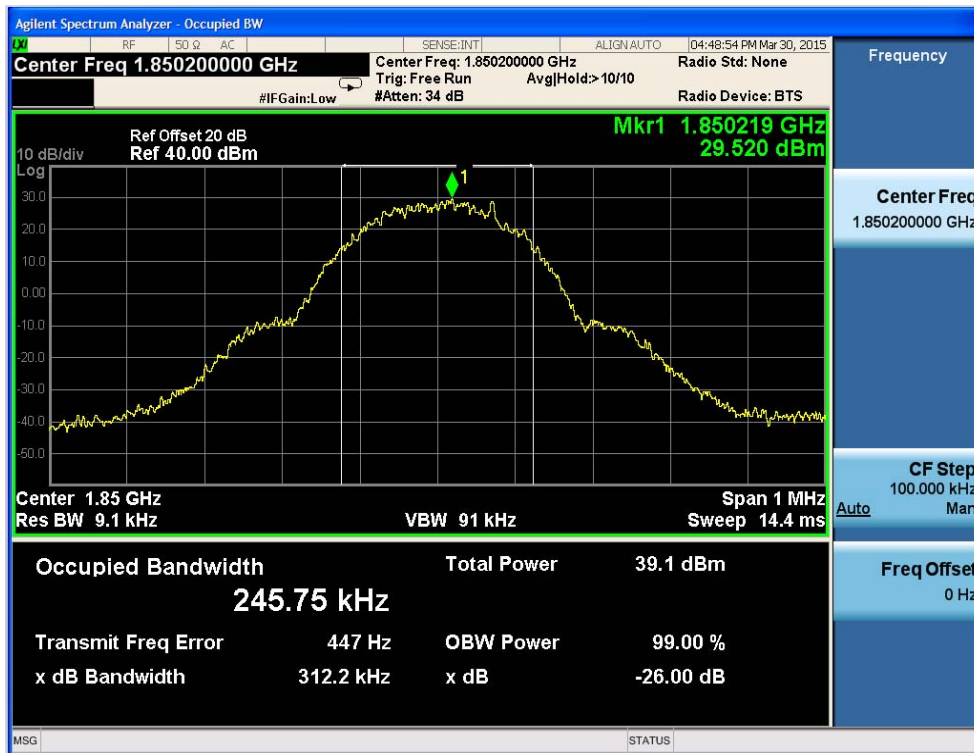

Fig.5 GSM1900-CH661 Occupied Bandwidth

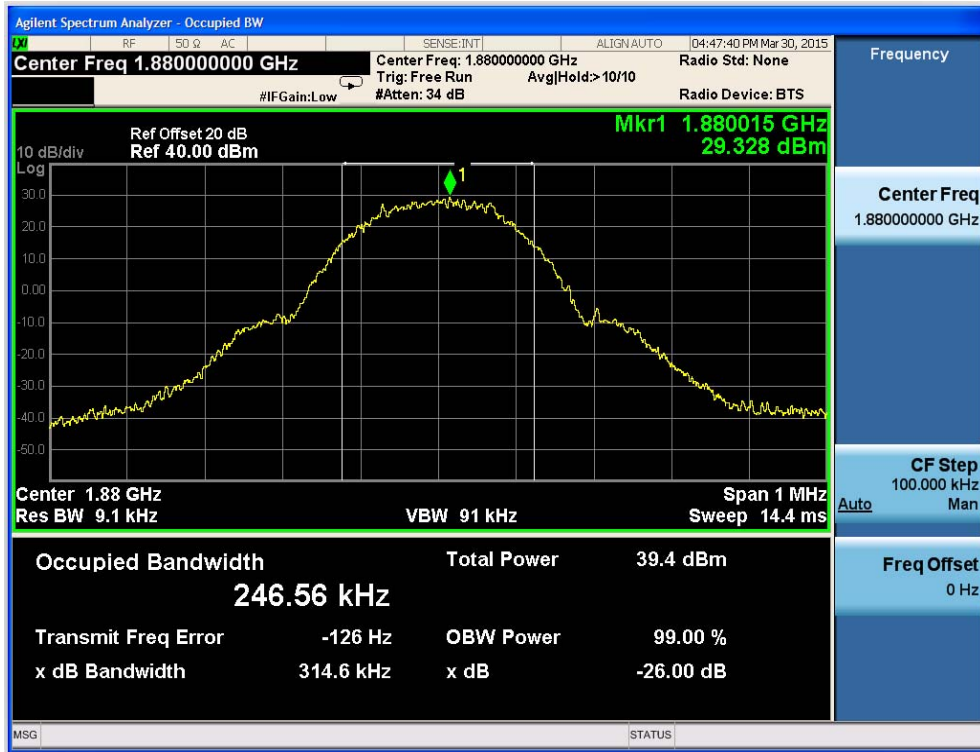

Fig.6 GSM1900-CH810 Occupied Bandwidth

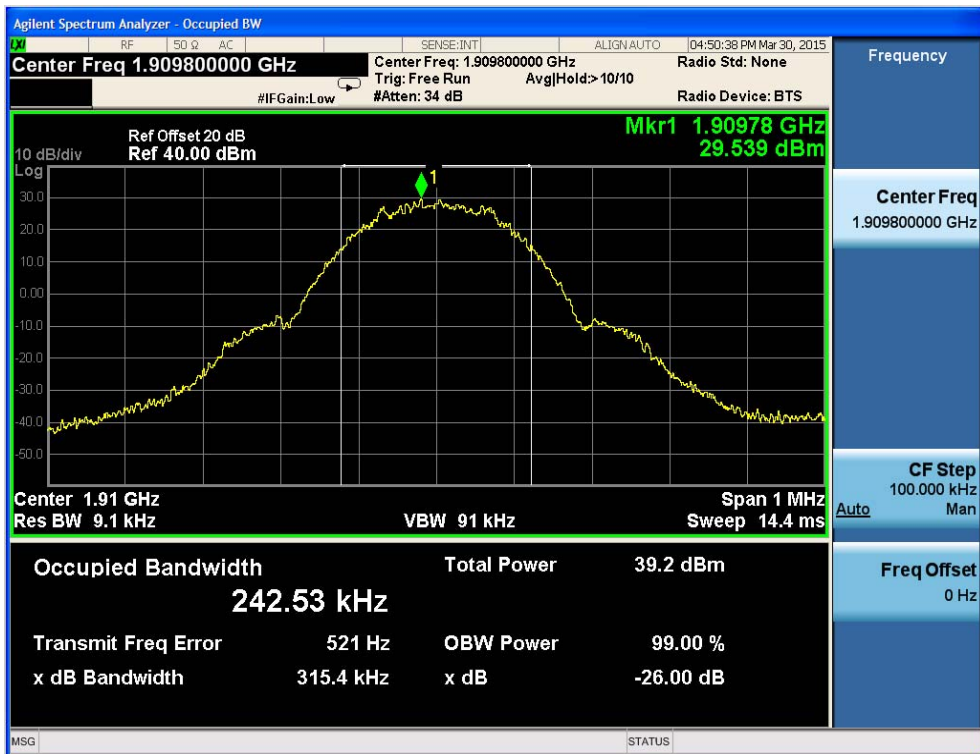

Fig.7 WCDMA Band V-CH4133 Occupied Bandwidth

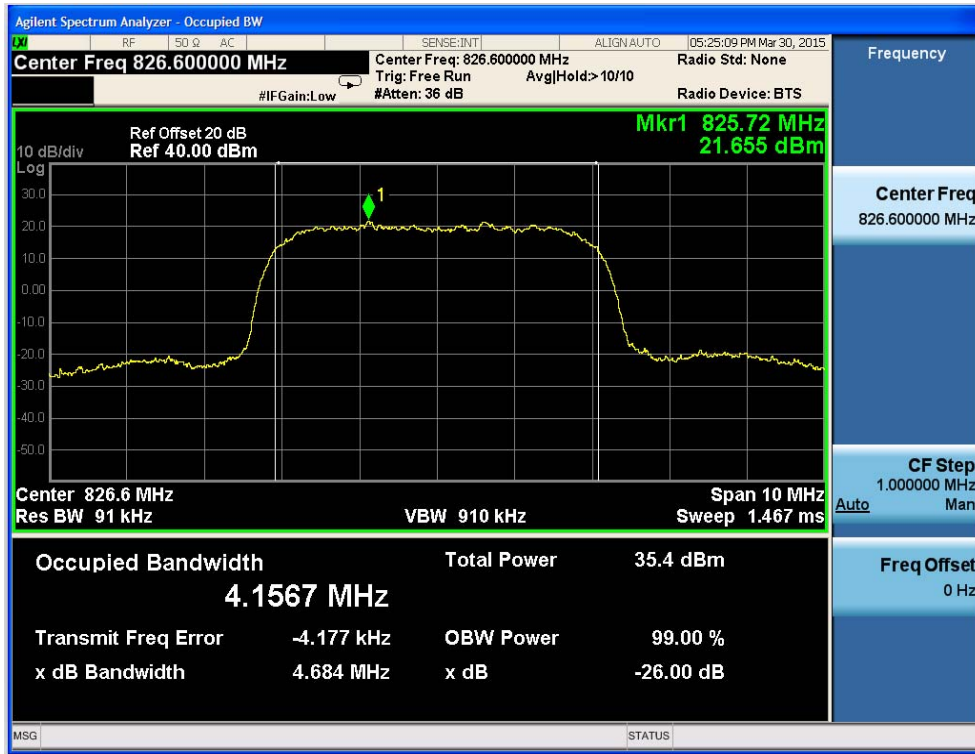

Fig.8 WCDMA Band V-CH4175 Occupied Bandwidth

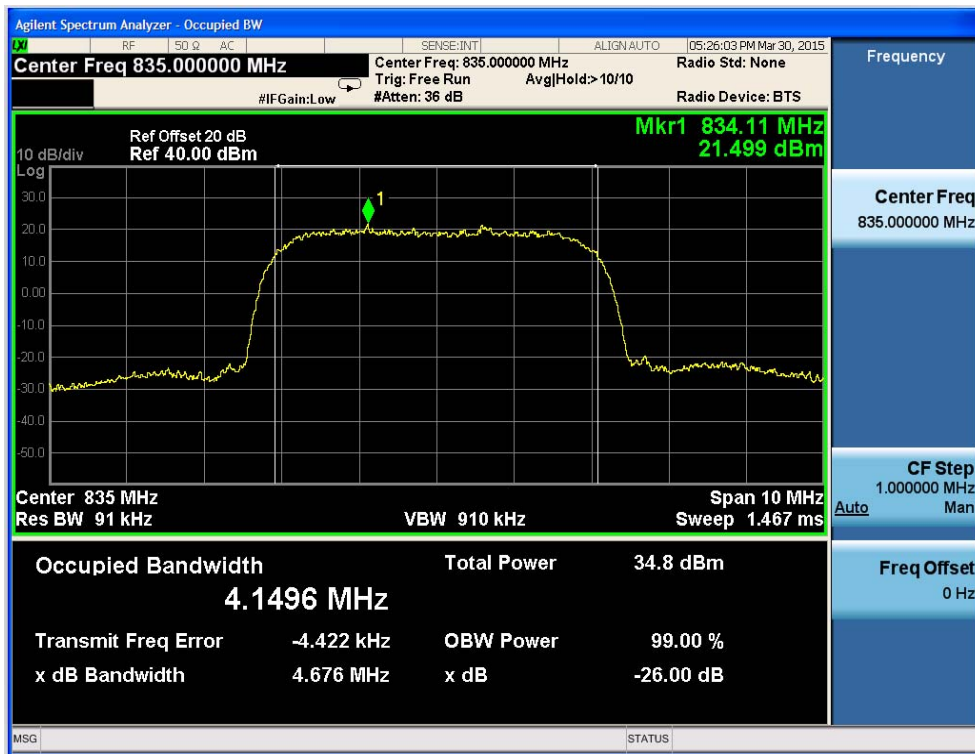

Fig.9 WCDMA Band V-CH4232 Occupied Bandwidth

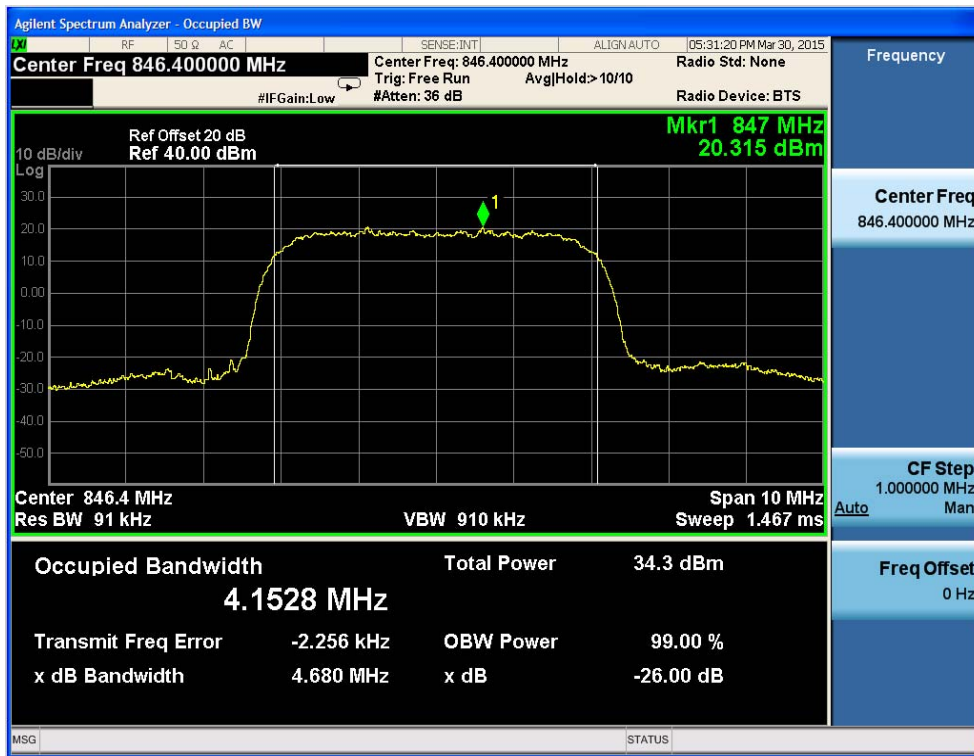

Fig.10 WCDMA Band V-CH4133 Occupied Bandwidth (HSDPA Subtest 1)

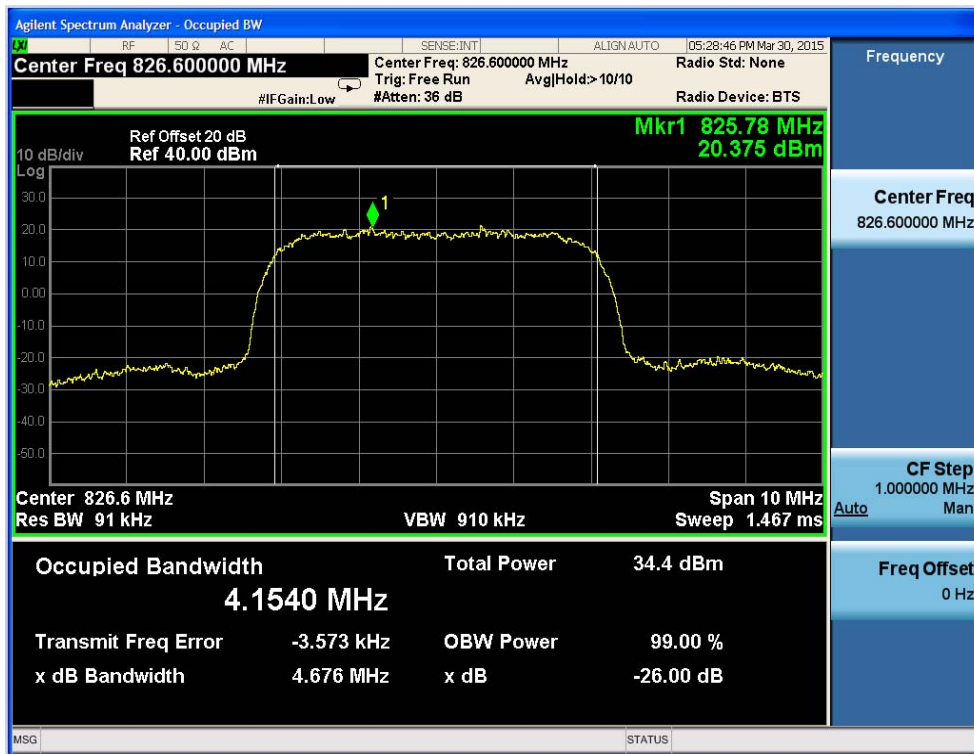

Fig.11 WCDMA Band V-CH4175 Occupied Bandwidth (HSDPA Subtest 1)

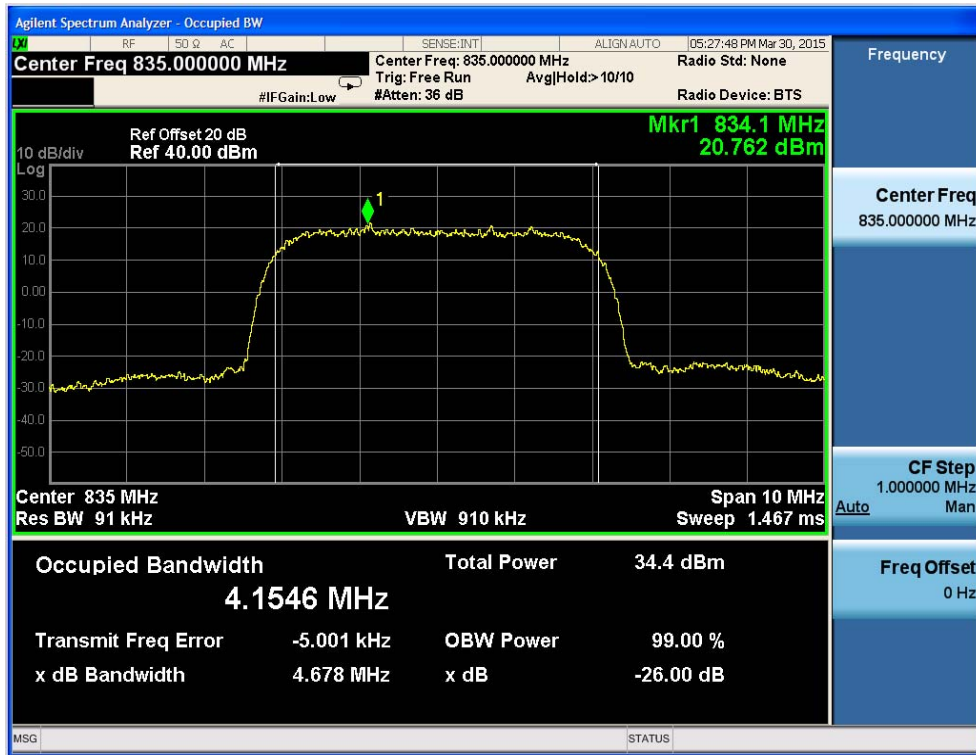

Fig.12 WCDMA Band V-CH4232 Occupied Bandwidth (HSDPA Subtest 1)

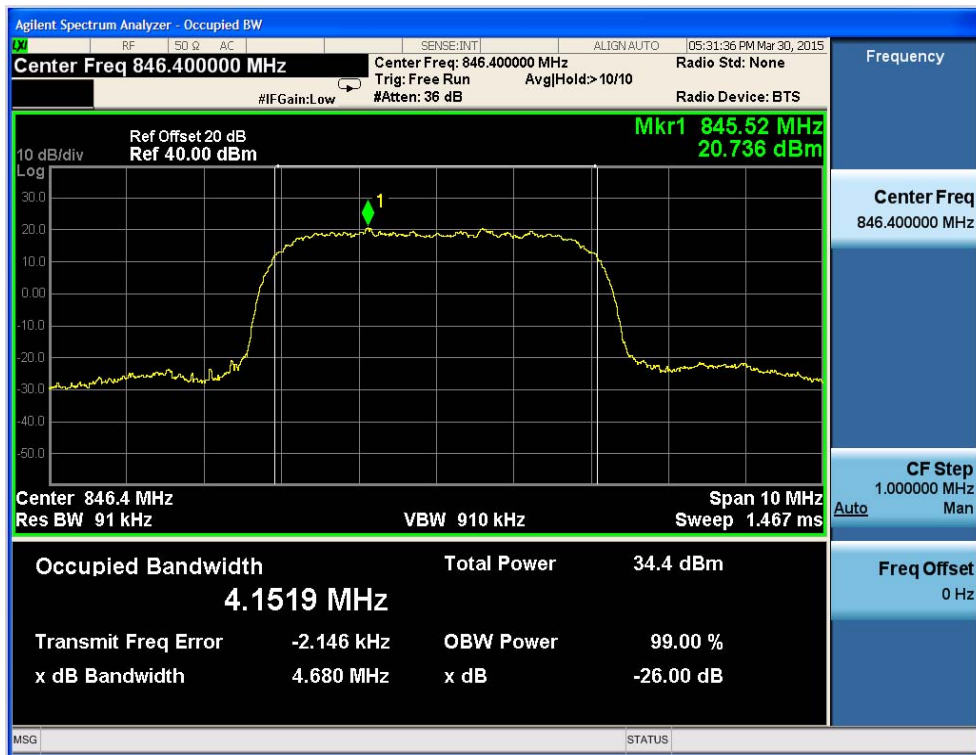

Fig.13 WCDMA Band V-CH4133 Occupied Bandwidth (HSUPA Subtest 5)

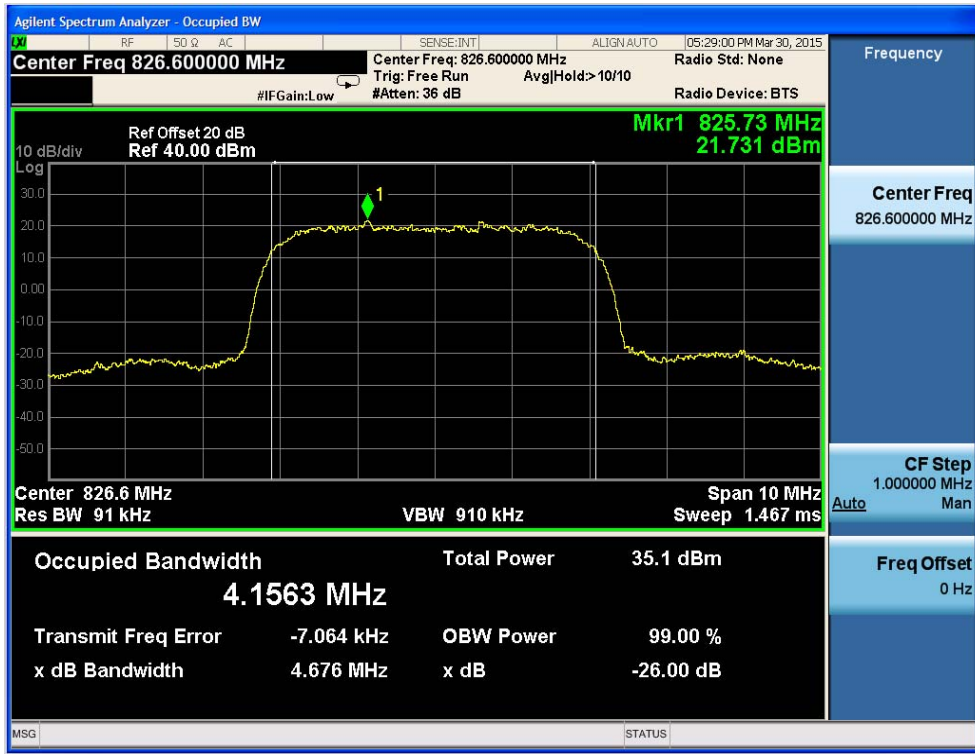

Fig.14 WCDMA Band V-CH4175 Occupied Bandwidth (HSUPA Subtest 5)

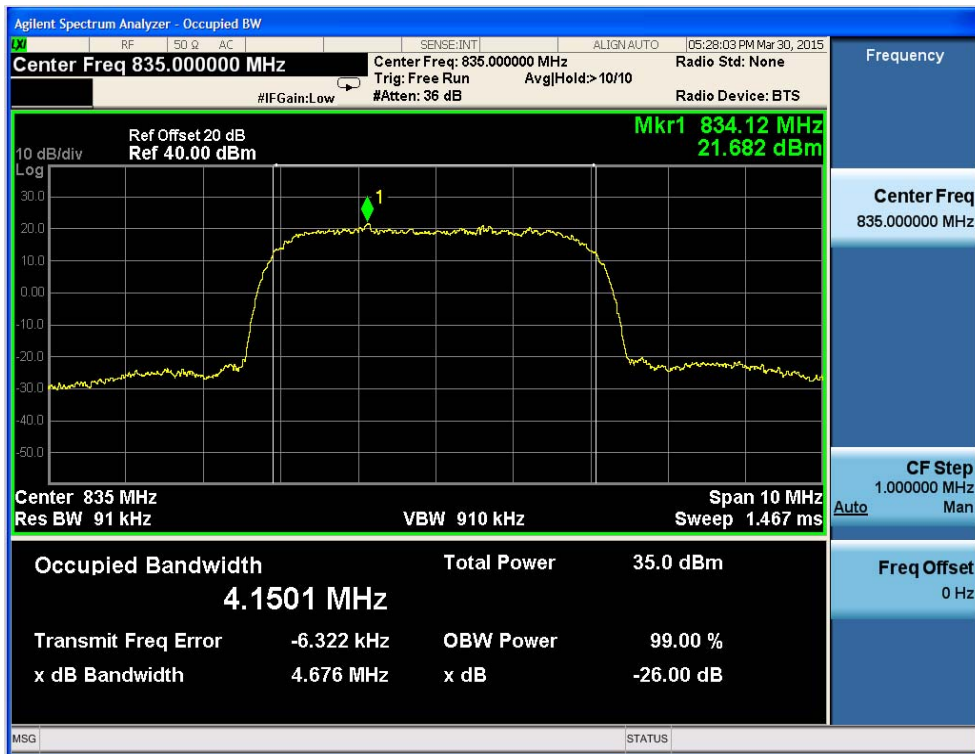

Fig.15 WCDMA Band V-CH4232 Occupied Bandwidth (HSUPA Subtest 5)

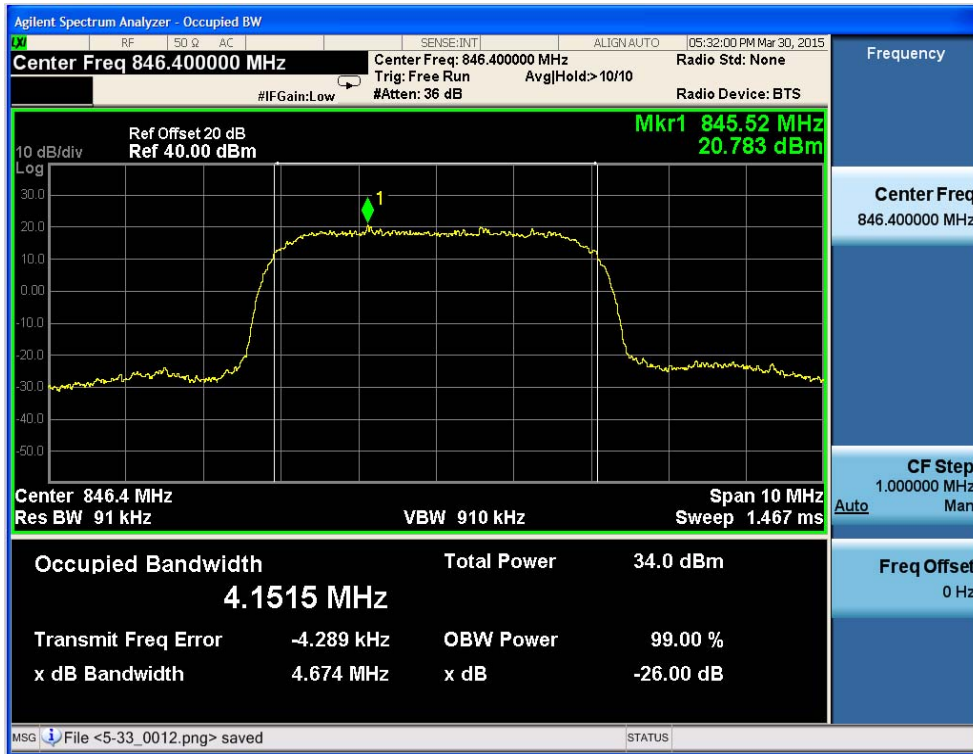

Fig.16 WCDMA Band II-CH9263 Occupied Bandwidth

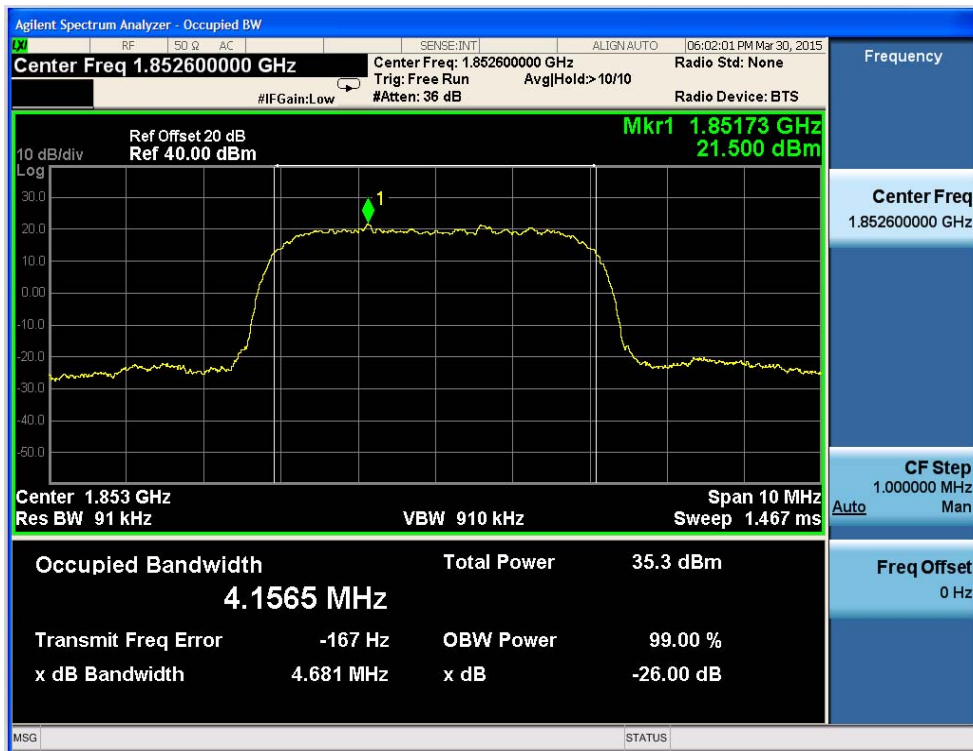

Fig.17 WCDMA Band II-CH9400 Occupied Bandwidth

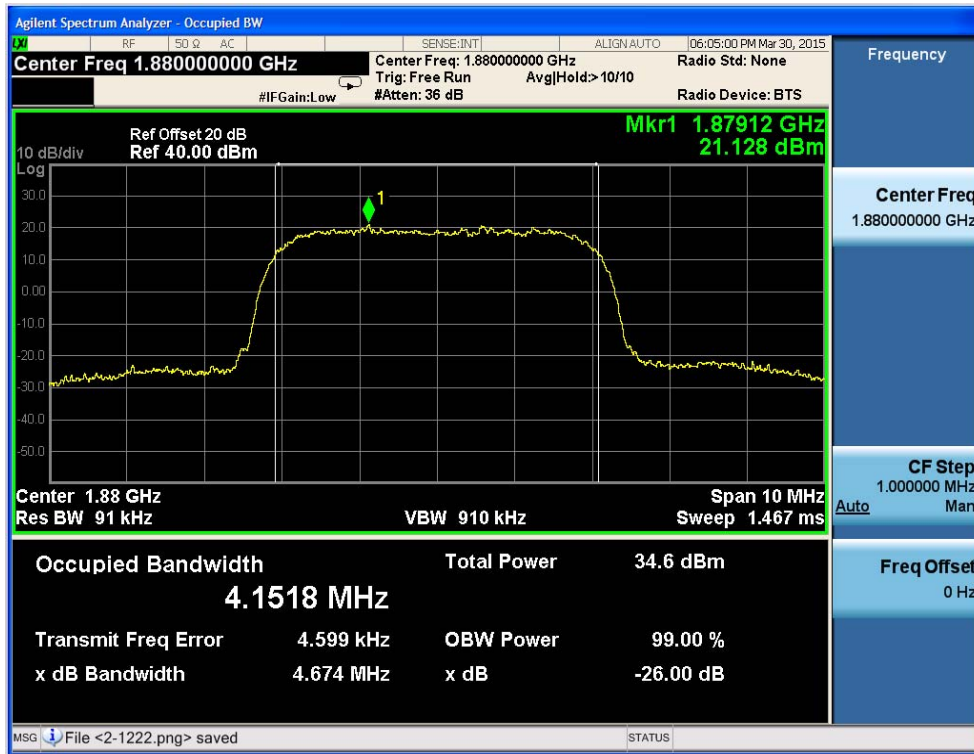

Fig.18 WCDMA Band II-CH9538 Occupied Bandwidth

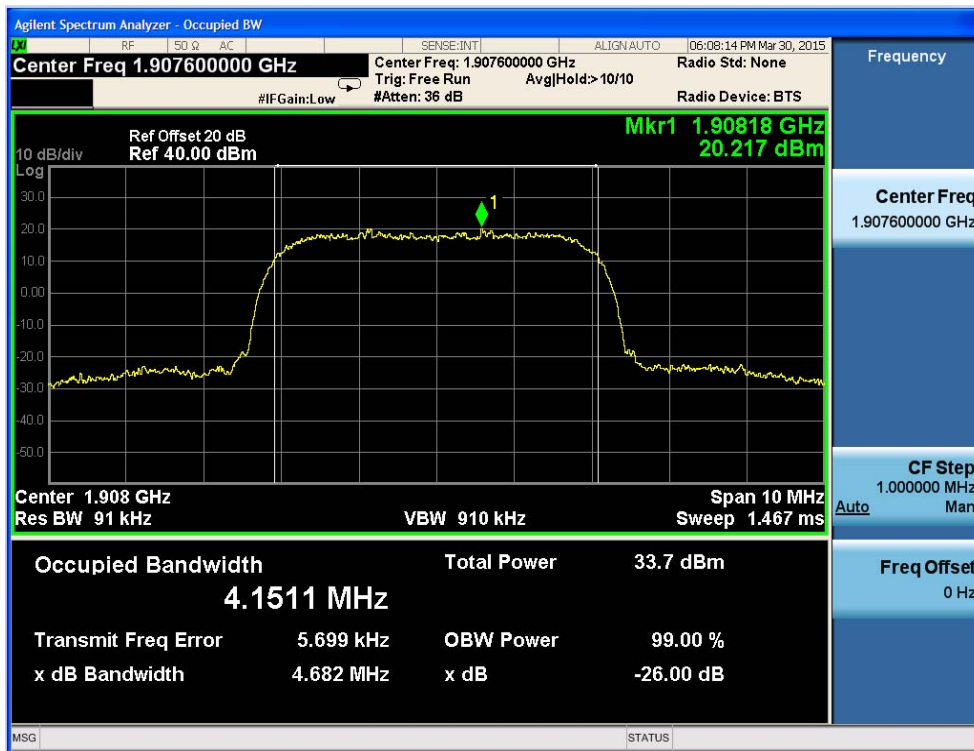

Fig.19 WCDMA Band II-CH9263 Occupied Bandwidth (HSDPA Subtest 1)

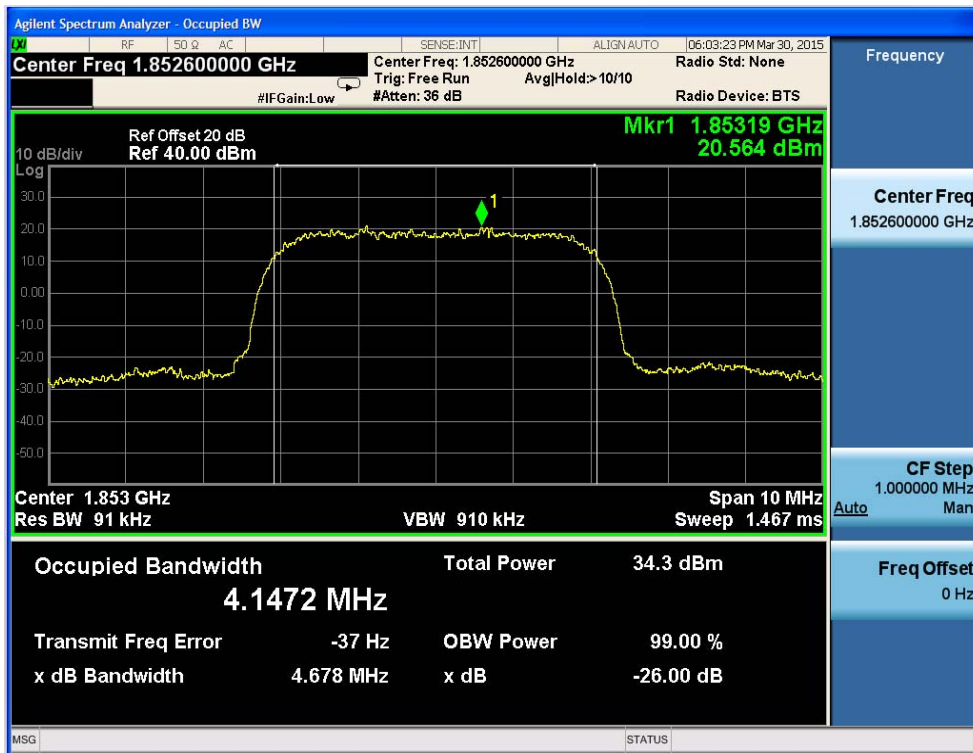

Fig.20 WCDMA Band II-CH9400 Occupied Bandwidth (HSDPA Subtest 1)

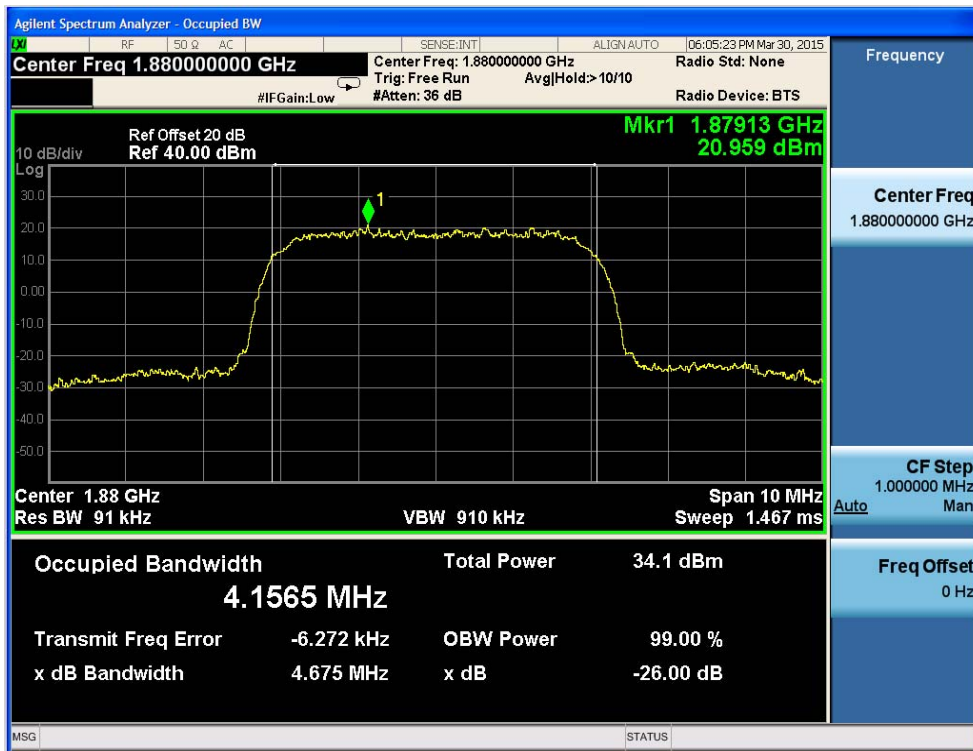

Fig.21 WCDMA Band II-CH9538 Occupied Bandwidth (HSDPA Subtest 1)

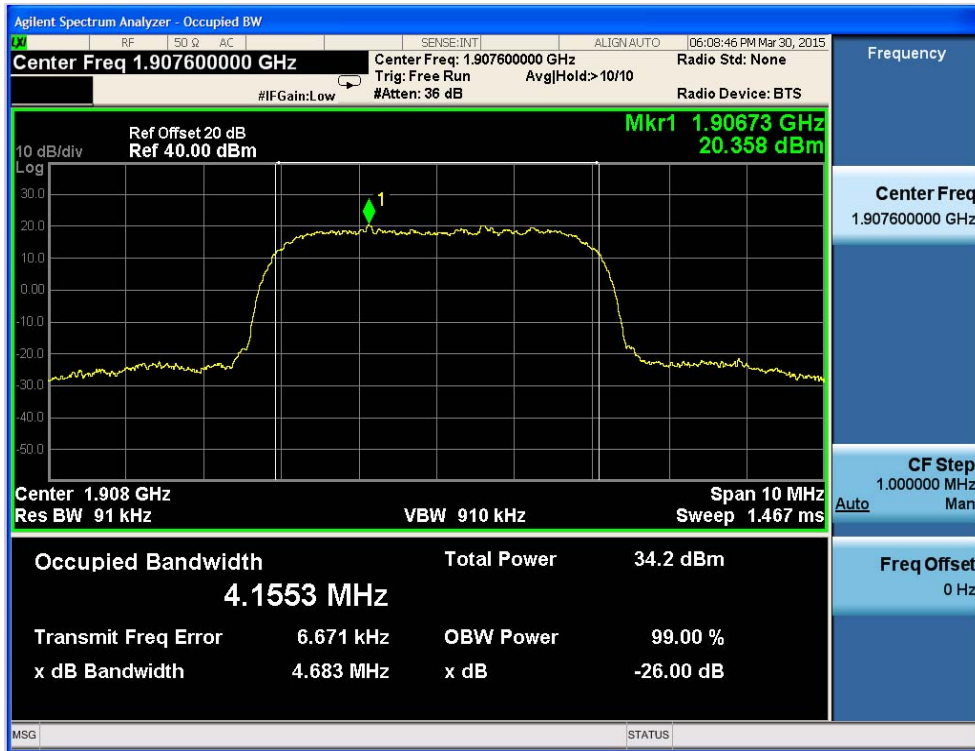

Fig.22 WCDMA Band II-CH92633 Occupied Bandwidth (HSUPA Subtest 5)

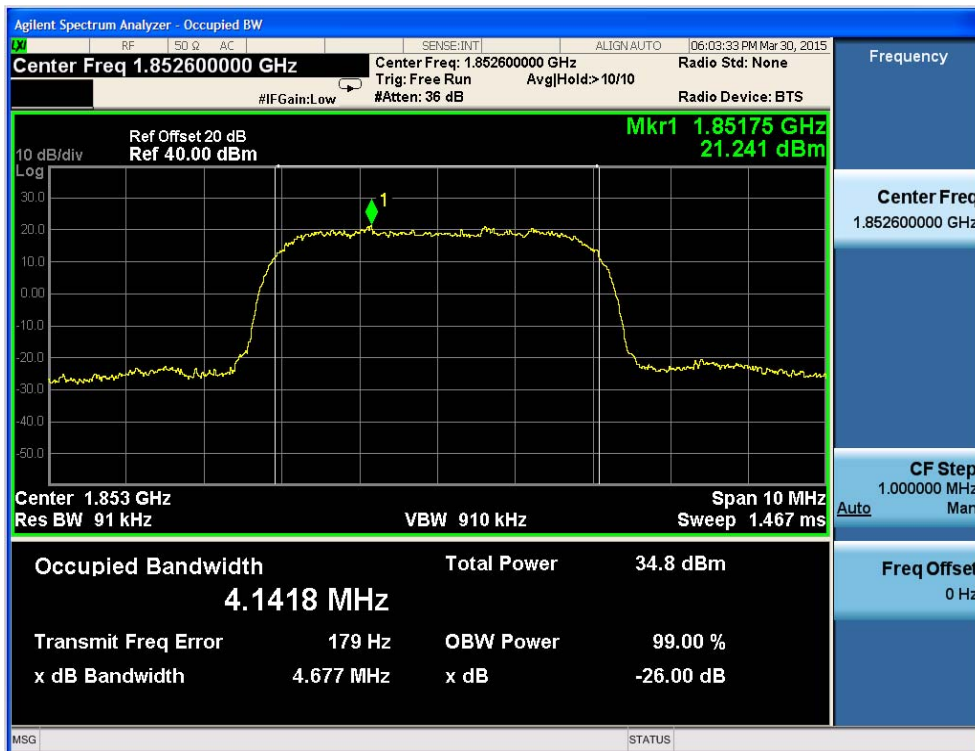

Fig.23 WCDMA Band II-CH9400 Occupied Bandwidth (HSUPA Subtest 5)

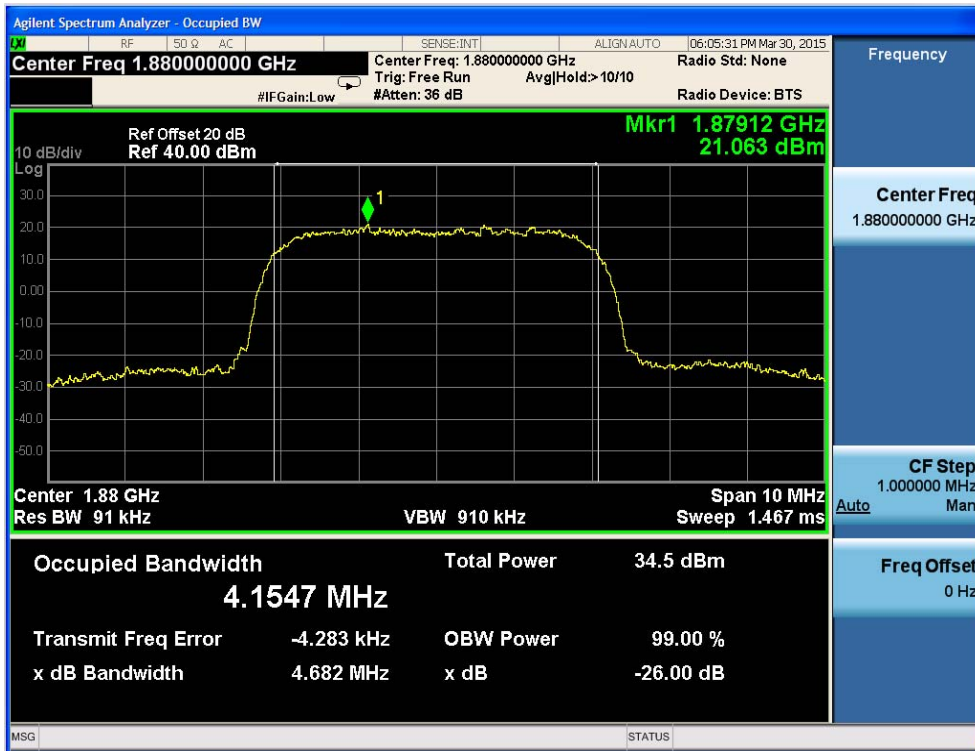
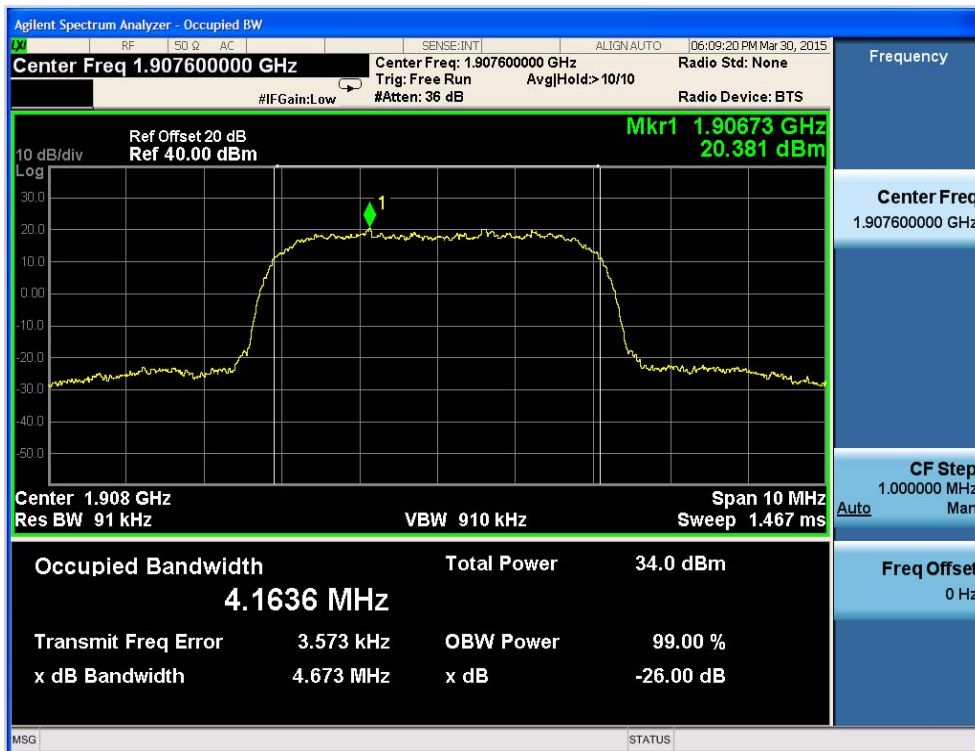

Fig.24 WCDMA Band II-CH9538 Occupied Bandwidth (HSUPA Subtest 5)



B.4 Emission Limit(22.917(b)/ 24.238(b))

B.4.1 Description

The radiated spurious emission was measured by substitution method according to TIA-603C-2004. This method does not require calibration of all measuring components. Instead, the spurious output power is recorded from measuring device. Then this power level is matched by a signal from a calibrated signal generator which is substituted for the EUT. The power supplied by the generator is then equal to the power of the spurious domain emission. The power of any emission outside of the authorized operating frequency ranges must be lower than transmitter power by a factor of at least $43+10\log(P)$ dB. The spectrum is scanned from 30MHz up to a frequency including its 10th harmonic.

B.4.2 Test Procedure

1. All possible modes of operation were investigated. Only the 6 worst case emissions measured using the correct CISPR detectors, are reported. All other emission were relatively insignificant.

2. A "-ve" margin indicates a PASS as it refers to the margin present below the limit line at the particular frequency.

3. Radiated Emissions Measurement Uncertainty

All test measurements carried out are traceable to national standards. The uncertainty of the measurement at a confidence level of approximately 95% (in the case where distributions are normal), with a coverage factor of 2, in the range 1GHz-40GHz is ± 6.0 dB (for EUTs $< 0.5\text{m} \times 0.5\text{m} \times 0.5\text{m}$)

4. The transmitter was placed on a wooden turntable, and it was transmitting into a non-radiating load which was also placed on the turntable.

5. The measurement antenna was placed at a distance of 3 meters from the EUT. During the tests, the antenna height and polarization as well as EUT azimuth were varied in order to identify the maximum level of emissions from the EUT. The test was performed by placing the EUT on 3-orthogonal axis.

6. Remove the EUT and replace it with substitution antenna. A signal generator was connected to the substitution.

7. Sample Calculation:

EUT Field Strength (dBm) = Reading (Signal generator) + Antenna Gain (substitution antenna) - Cable loss (From Signal Generator to substitution antenna)

8. The limit is derived from $43+10\log(p)$ dB below transmitter power P (Watts)

$$= p(w) - [43 + 10\log(p)] \text{ (dB)}$$

$$= [30 + 10\log(p)] \text{ (dBm)} - [43 + 10\log(p)] \text{ (dB)}$$

$$= -13 \text{ dBm}$$

B.4.3 Test Setup

<Below 1GHz>

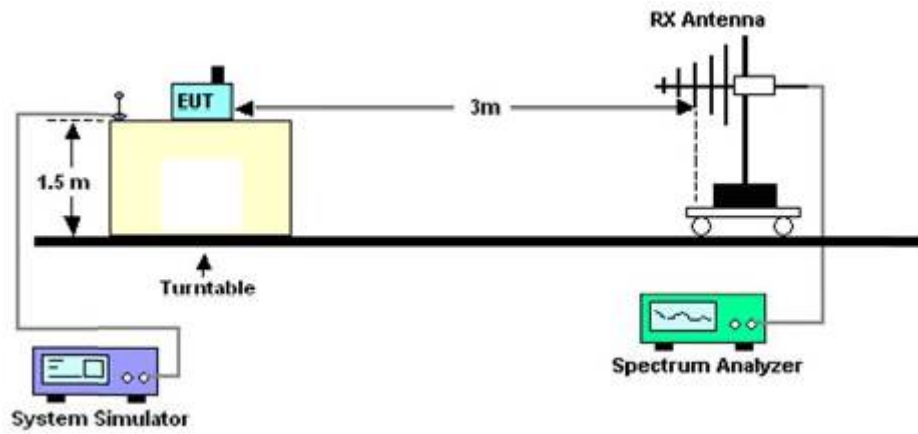

<Above 1GHz>

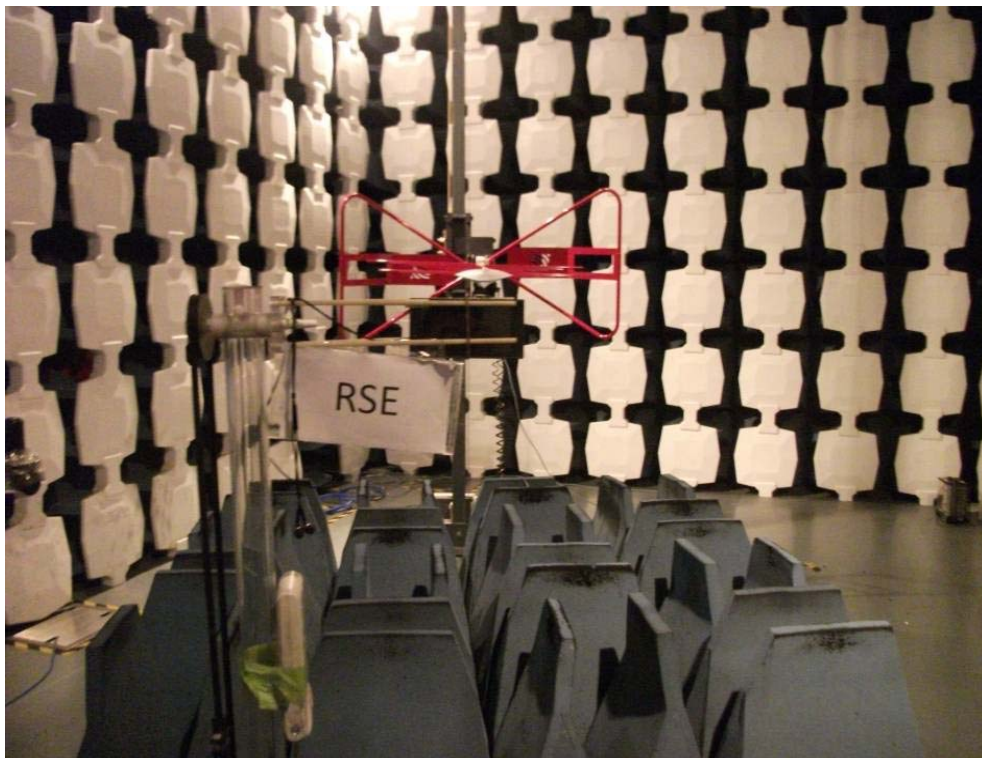
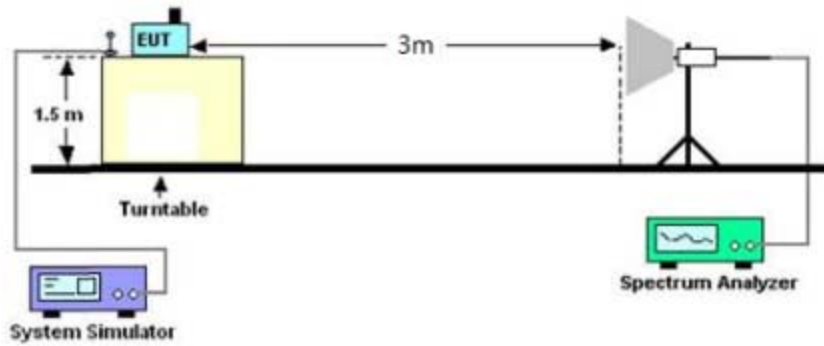

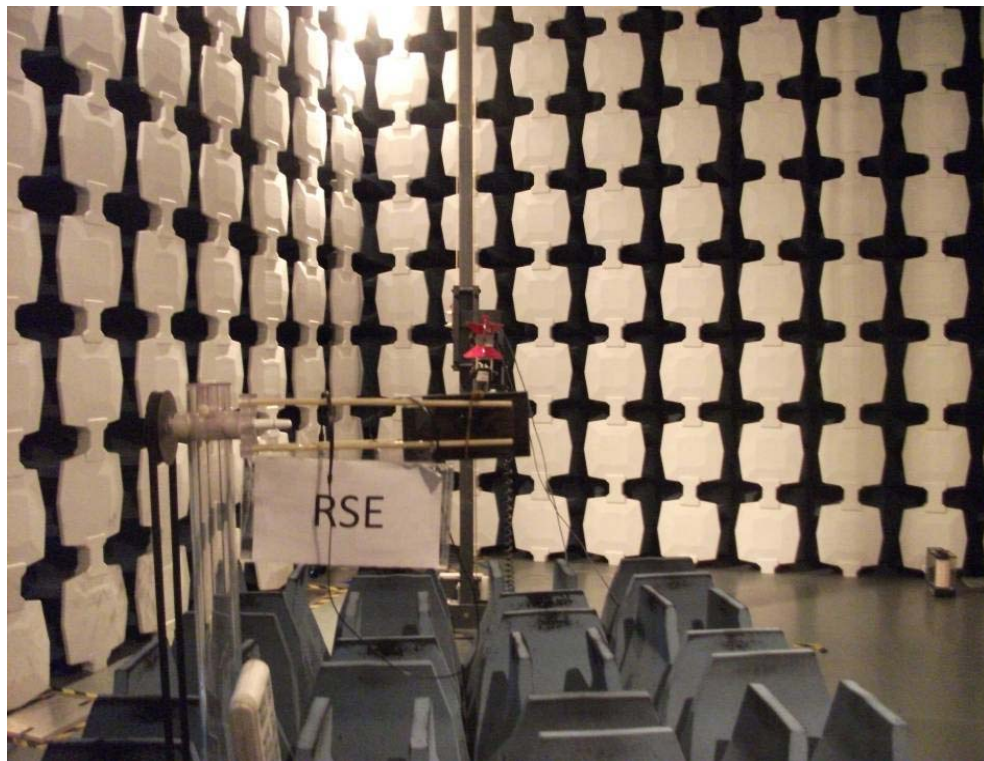

B.4.4 Test Results

GSM850								
CH	Frequency (MHz)	Substituted Level(dBm)	Polarity (H/V)	Antenna Gain(dBi)	Cable Loss(dB)	Limit dBm	Corrected Reading(dBm)	Verdict
L	1648.4	-44.55	V	7.56	0.71	-13	-36.28	Pass
	1648.4	-46.13	H	7.56	0.71		-37.86	Pass
	144.6	-43.11	V	2.61	0.14		-40.36	Pass
	204.5	-43.21	H	4.13	0.14		-38.94	Pass
M	1673.2	-44.66	V	7.56	0.71		-36.39	Pass
	1673.2	-46.25	H	7.56	0.71		-37.98	Pass
	144.6	-43.34	V	2.61	0.14		-40.59	Pass
	203.4	-43.55	H	4.13	0.14		-39.28	Pass
H	1697.6	-44.44	V	7.56	0.71		-36.17	Pass
	1697.6	-46.1	H	7.56	0.71		-37.83	Pass
	145.2	-43.27	V	2.61	0.14		-40.52	Pass
	202.6	-43.42	H	4.13	0.14		-39.15	Pass

GSM1900								
CH	Frequency (MHz)	Substituted Level(dBm)	Polarity (H/V)	Antenna Gain(dBi)	Cable Loss(dB)	Limit dBm	Corrected Reading(dBm)	Verdict
L	3700.4	-51.11	V	10.11	2.35	-13	-38.65	Pass
	3700.4	-51.24	H	10.11	2.35		-38.78	Pass
	144.8	-44.76	V	2.61	0.14		-42.01	Pass

M	202.5	-44.99	H	4.13	0.14	-13	-40.72	Pass
	3760	-51.22	V	10.11	2.35		-38.76	Pass
	3760	-51.36	H	10.11	2.35		-38.9	Pass
	145.2	-44.99	V	2.61	0.14		-42.24	Pass
	202.8	-45.33	H	4.13	0.14		-41.06	Pass
H	3819.6	-51	V	10.11	2.35		-38.54	Pass
	3819.6	-51.21	H	10.11	2.35		-38.75	Pass
	146.1	-44.92	V	2.61	0.14		-42.17	Pass
	201.7	-45.2	H	4.13	0.14		-40.93	Pass

WCDMA Band V								
CH	Frequency (MHz)	Substituted Level(dBm)	Polarity (H/V)	Antenna Gain(dBi)	Cable Loss(dB)	Limit dBm	Corrected Reading(dBm)	Verdict
L	1652.8	-56.98	V	7.56	0.71	-13	-48.71	Pass
	1652.8	-57.23	H	7.56	0.71		-48.96	Pass
	146.2	-43.01	V	2.61	0.14		-40.26	Pass
	203.6	-45.98	H	4.13	0.14		-41.71	Pass
M	1670	-57.09	V	7.56	0.71		-48.82	Pass
	1670	-57.35	H	7.56	0.71		-49.08	Pass
	145.7	-43.24	V	2.61	0.14		-40.49	Pass
	202.8	-46.32	H	4.13	0.14		-42.05	Pass
H	1693.2	-56.87	V	7.56	0.71		-48.6	Pass
	1693.2	-57.2	H	7.56	0.71		-48.93	Pass
	143.7	-43.17	V	2.61	0.14		-40.42	Pass
	202.8	-46.19	H	4.13	0.14		-41.92	Pass

WCDMA Band II								
CH	Frequency (MHz)	Substituted Level(dBm)	Polarity (H/V)	Antenna Gain(dBi)	Cable Loss(dB)	Limit dBm	Corrected Reading(dBm)	Verdict
L	3704.8	-50.99	V	10.11	2.35	-13	-38.53	Pass
	3704.8	-52.11	H	10.11	2.35		-39.65	Pass
	144.3	-45.01	V	2.61	0.14		-42.26	Pass
	203.7	-44.23	H	4.13	0.14		-39.96	Pass
M	3760	-51.1	V	10.11	2.35		-38.64	Pass
	3760	-52.23	H	10.11	2.35		-39.77	Pass
	144.6	-45.24	V	2.61	0.14		-42.49	Pass
	202.3	-44.57	H	4.13	0.14		-40.3	Pass
H	3815.2	-50.88	V	10.11	2.35		-38.42	Pass
	3815.2	-52.08	H	10.11	2.35		-39.62	Pass
	146.2	-45.17	V	2.61	0.14		-42.42	Pass
	203.7	-44.44	H	4.13	0.14		-40.17	Pass

B.5 Band Edge Compliance(22.917(b)/ 24.238)

B.5.1 Description

The power of any emission outside of the authorized operating frequency ranges must be lower than transmitter power by a factor of at least $43+10\log(P)$ dB.

B.5.2 Test Procedure

1. The EUT was connected to Spectrum Analyzer and Base Station.
2. The band edge of low and high channel for maximum RF power was measured. Setting RBW is as roughly BW/100.

B.5.3 Test Setup

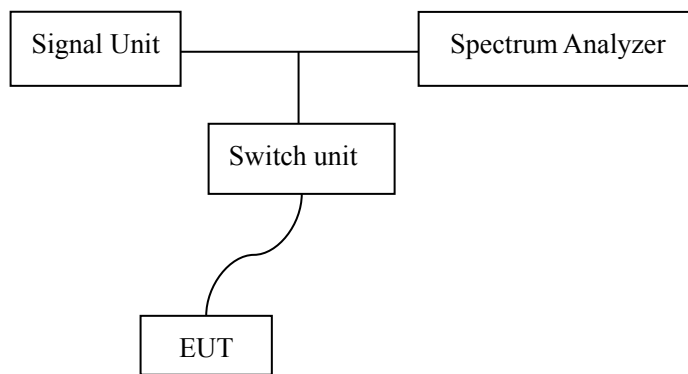

B.5.4 Test Results

Band	CH	Frequency(MHz)	Result	Verdict
GSM850	128	824.2	Fig.25	Pass
	251	848.8	Fig.26	Pass
GSM1900	512	1850.2	Fig.27	Pass
	810	1909.8	Fig.28	Pass
WCDMA Band V	4133	824.2	Fig.29	Pass
	4232	848.8	Fig.30	Pass
WCDMA Band VHSDPA Subtest 1	4133	824.2	Fig.31	Pass
	4232	848.8	Fig.32	Pass
WCDMA Band VHSUPA Subtest 5	4133	824.2	Fig.33	Pass
	4232	848.8	Fig.34	Pass
WCDMA Band II	9263	1850.2	Fig.35	Pass
	9538	1909.8	Fig.36	Pass
WCDMA Band IIHSDPA Subtest 1	9263	1850.2	Fig.37	Pass
	9538	1909.8	Fig.38	Pass
WCDMA Band IIHSUPA Subtest 5	9263	1850.2	Fig.39	Pass
	9538	1909.8	Fig.40	Pass

Fig.25 GSM850-CH128 Band Edge Compliance

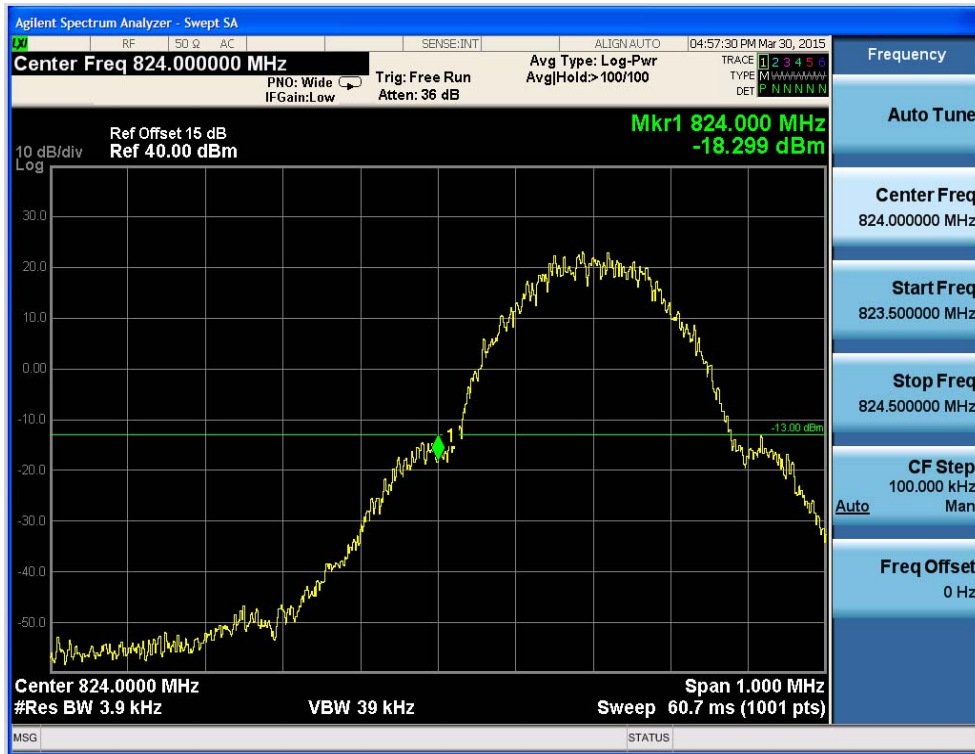

Fig.26 GSM850-CH251 Band Edge Compliance



Fig.27 GSM1900-CH512 Band Edge Compliance

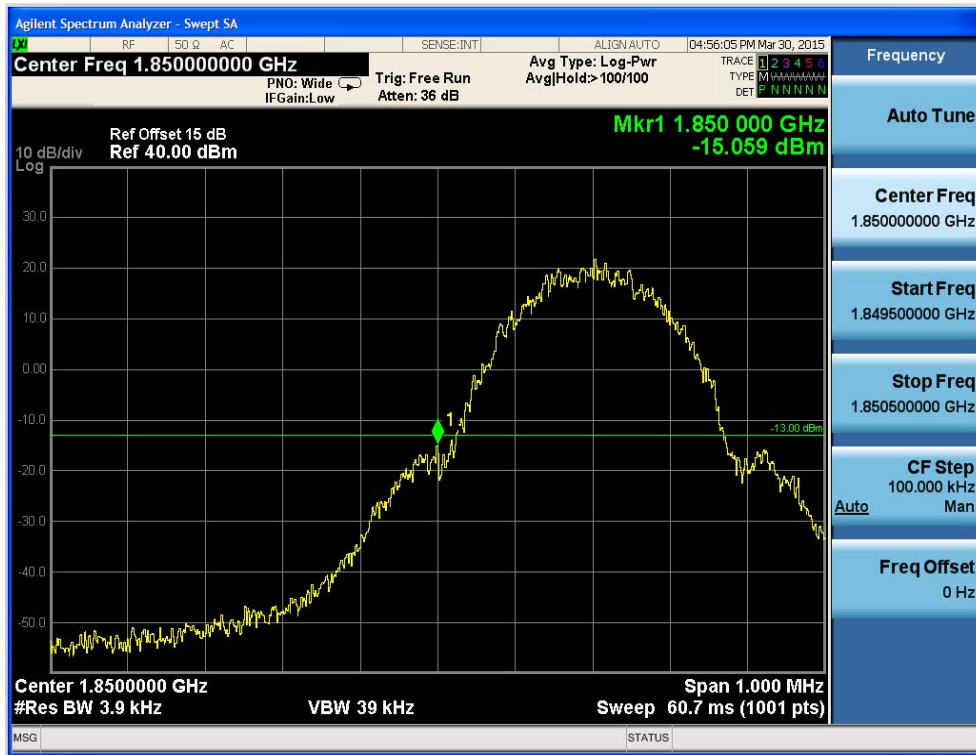

Fig.28 GSM1900-CH810 Band Edge Compliance

