

# SAR Test Report

Product Name : GSM MOBILE PHONE  
Model No. : M4TEL SS220  
FCC ID : CLNSS220G

Prepared By: : Inventec Appliances(Pudong) Corporation  
Address: : No.789 Pu Xing Road,Shanghai,PRC  
Date of Receipt : 2012.03.8  
Date of Test : 2012.03.12-2012.03.15  
Report No. : 20120308SAR



### Test Report Certification

Date of Issue : Mar.08.2012

Report No. : 20120308SAR

Product Name : GSM MOBILE PHONE

Model No. : M4TEL SS220

Trade Name : M4TEL

Applicant : FOURTEL MEXICO S.A. DE C.V.

Address : Montecito 38, Piso 23, Oficina 15. Colonia Nápoles. C.P.  
03810 Mexico

Standard : FCC 47 CFR Part2 (2.1093)  
IEEE C95.1-1999  
IEEE 1528-2003  
FCC OET Bulletin 65 supplement C  
FCC KDB 648474 D01 v01r05  
FCC KDB 941225 D01 v02  
FCC KDB 941225 D03 v01  
FCC KDB 941225 D04 v01  
FCC KDB 941225 D06 v01  
FCC KDB 248227 D01 v01r02

Test Result : Complied

The Test Results relate only to the samples tested.  
 The test report shall not be reproduced except in full without the written approval of  
 Inventec Appliances(Pudong) Corporation

Documented By : *Kelly Lin* Mar 16, 2012  
 Kelly Lin/Engineer

Tested By : *Byran Hung* Mar 16, 2012  
 Byran Hung/Senior Engineer

Approved By : *Jeff Huang* Mar 16, 2012  
 Jeff Huang/Director of Operations

# TABLE OF CONTENTS

Description	Page
<b>1. GENERAL INFORMATION-----</b>	<b>5</b>
1.1. APPLICANT-----	5
1.2. MANUFACTURER-----	5
1.3. TEST ENVIRONMENT-----	5
<b>2. SAR MEASUREMENT SYSTEM-----</b>	<b>6</b>
2.1. ALSAS-10U SYSTEM DESCRIPTION-----	6
2.1.1 Applications-----	6
2.1.2 Area Scans-----	7
2.1.3 Zoom Scan (Cube Scan Averaging)-----	7
2.1.4 ALSAS-10U Interpolation and Extrapolation Uncertainty-----	7
2.2 ISOTROPIC E-FIELD PROBE-----	8
2.2.1 ISOTROPIC E-FIELD PROBE SPECIFICATION-----	9
2.3 BOUNDARY DETECTION UNIT AND PROBE MOUNTING DEVICE-----	9
2.4 DAQ-PAQ (ANALOG TO DIGITAL ELECTRONICS)-----	10
2.5 AXIS ARTICULATED ROBOT-----	10
2.6 ALSAS UNIVERSAL WORKSTATION-----	11
2.7 UNIVERSAL DEVICE POSITIONER-----	11
2.8 PHONTOM TYPES-----	12
2.8.1 APREL SAM Phantoms-----	12
2.8.2 APREL Laboratories Universal Phantom-----	12
<b>3. TISSUE SIMULATING LIQUID-----</b>	<b>13</b>
3.1. THE COMPOSITION OF THE TISSUE SIMULATING LIQUID-----	13
3.2. TISSUE CALIBRATION RESULT-----	13
3.3. TISSUE DIELECTRIC PARAMETERS FOR HEAD AND BODY PHANTOMS-----	14
<b>4. SAR MEASUREMENT PROCEDURE-----</b>	<b>16</b>
4.1. SAR SYSTEM VALIDATION-----	16
4.1.1. VALIDATION DIPOLES-----	16
4.1.2. Validation Result-----	17
4.2. ARRANGEMENT ASSESSMENT SETUP-----	25
4.2.1. Test Positions of Device Relative to Head-----	25
4.2.2.1. Definition of the "Cheek" Position-----	25
4.2.1.2. Definition of the "Tilted" Position-----	26
4.2.2. Test Positions for body-worn-----	27
4.3. SAR MEASUREMENT PROCEDURE-----	27

---

5. SAR EXPOSURE LIMITS----- 28

6. TEST EQUIPMENT LIST ----- 29

7. MEASUREMENT UNCERTAINTY ----- 30

8. TEST RESULTS ----- 31

8.1. SAR TEST RESULTS SUMMARY ----- 31

8.2. CONDUCTED POWER(UNIT:DBM)----- 35

8.3. SAR MEASUREMENT DATA ----- 39

**1. GENERAL INFORMATION****1.1. Applicant**

Company Name: MFOURTEL MEXICO S.A. DE C.V.

Address: Montecito 38, Piso 23, Oficina 15. Colonia Nápoles. C.P. 03810 Mexico

**1.2. Manufacturer**

Company Name: CK Telecom Limited

Address: Technology Road.High-Tech Development Zone. Heyuan, Guangdong,P.R.China.

**1.3. Test Environment**

Ambient conditions in the laboratory:

Items	Required	Actural
Temperature(°C)	15~30	21.4
Humidity(%RH)	30~70	46

## 2. SAR Measurement System

### 2.1. ALSAS-10U System Description

ALSAS-10-U is fully compliant with the technical and scientific requirements of IEEE 1528, IEC 62209, CENELEC, ARIB, ACA, and the Federal Communications Commission. The system comprises of a six axes articulated robot which utilizes a dedicated controller.

ALSAS-10U uses the latest methodologies and FDTD order to provide a platform which is repeatable with minimum uncertainty.

#### 2.1.1 Applications

Predefined measurement procedures compliant with the guidelines of CENELEC, IEEE, IEC, FCC, etc are utilized during the assessment for the device. Automatic detection for all SAR maxima are embedded within the core architecture for the system, ensuring that peak locations used for centering the zoom scan are within a 1mm resolution and a 0.05mm repeatable position. System operation range currently is available up to 6 GHz in simulated tissue.



### 2.1.2 Area Scans

Area Scans are defined prior to the measurement process being executed with a user defined variable spacing between each measurement point (integral) allowing low uncertainty measurements to be conducted. Scans defined for FCC applications utilize a  $10\text{mm}^2$  step integral, with 1mm interpolation used to locate the peak SAR area used for zoom scan assessments.

Where the system identifies multiple SAR peaks (which are within 25% of peak value) the system will provide the user with the option of assessing each peak location individually for zoom scan averaging.

### 2.1.3 Zoom Scan (Cube Scan Averaging)

The averaging zoom scan volume utilized in the ALSAS-10U software is in the shape of a cube and the side dimension of a 1g or 10g mass is dependent on the density of the liquid representing the simulated tissue. A density of  $1000\text{Kg/m}^3$  is used to represent the head and body tissue density and not the phantom liquid density, in order to be consistent with the definition of the liquid dielectric properties, i.e. the side length of the 1g cube is 10mm, with the side length of the 10g cube 21.5mm.

When the cube intersects with the surface of the phantom, it is oriented so that 3 vertices touch the surface of the shell or the center of a face is tangent to the surface.

The zoom Scan integer steps can be user defined so as to reduce uncertainty, but normal practice for typical test applications (including FCC) utilize a physical step of  $5 \times 5 \times 8$  (8mm $\times$ 8mm $\times$ 5mm) providing a volume of 32mm in the X & Y axis, and 35mm in the Z axis.

### 2.1.4 ALSAS-10U Interpolation and Extrapolation Uncertainty

The overall uncertainty for the methodology and algorithms the used during the SAR calculation was evaluated using the data from IEEE 1528 based on the example f3 algorithm:

$$f_3(x, y, z) = A \frac{a^2}{\frac{a^2}{4} + x'^2 + y'^2} \cdot \left( e^{-\frac{2z}{a}} + \frac{a^2}{2(a + 2z)^2} \right)$$

## 2.2 Isotropic E-Field Probe

The isotropic E-Field probe has been fully calibrated and assessed for isotropic, and boundary effect within a controlled environment. Depending on the frequency for which the probe is calibrated the method utilized for calibration will change. A number of methods is used for calibrating probes, and these are outlined in the table below:

Calibration Frequency	Air Calibration	Tissue Calibration
900MHz	TEM Cell	Temperature
1800MHz	TEM Cell	Temperature

The E-Field probe utilizes a triangular sensor arrangement as detailed in the diagram below:

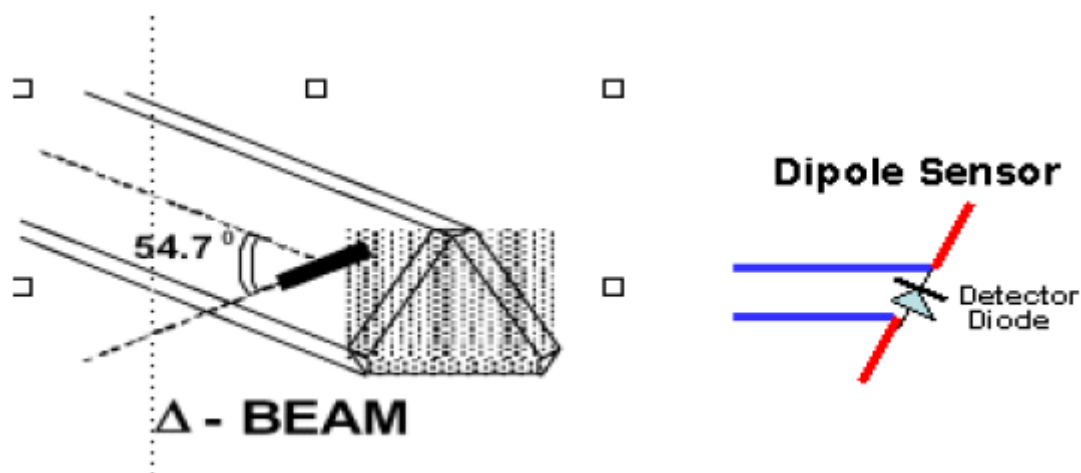

SAR is assessed with a calibrated probe which moves at a default height of 5mm from the center of the diode, which is mounted to the sensor, to the phantom surface (in the Z Axis). The 5mm offset height has been selected so as to minimize any resultant boundary effect due to the probe being in close proximity to the phantom surface.

The following algorithm is an example of the function used by the system for linearization of the output from the probe when measuring complex modulation schemes.

$$V_i = U_i + U_i^2 \cdot \frac{cf}{dcp_i}$$



### 2.2.1 Isotropic E-Field Probe Specification

<b>Calibration in Air</b>	Frequency Dependent Below 2GHz Calibration in air performed in a TEM Cell Above 2GHz Calibration in air performed in waveguide
<b>Sensitivity</b>	0.70 $\mu\text{V}/(\text{V}/\text{m})^2$ to 0.85 $\mu\text{V}/(\text{V}/\text{m})^2$
<b>Dynamic Range</b>	0.0005 W/kg to 100W/kg
<b>Isotropic Response</b>	Better than 0.2dB
<b>Diode Compression point (DCP)</b>	Calibration for Specific Frequency
<b>Probe Tip Radius</b>	< 5mm
<b>Sensor Offset</b>	1.56 (+/- 0.02mm)
<b>Probe Length</b>	290mm
<b>Video Bandwidth</b>	@ 500 Hz: 1dB @1.02 KHz: 3dB
<b>Boundary Effect</b>	Less than 2% for distance greater than 2.4mm
<b>Spatial Resolution</b>	Diameter less than 5mm Compliant with Standards

Probe model no: ALS-E-020, S/N:500-00273

### 2.3 Boundary detection Unit and Probe Mounting Device

ALSAS-10U incorporates a boundary detection unit with a sensitivity of 0.05mm for detecting all types of surfaces. The robust design allows for detecting during probe tilt (probe normalize) exercises, and utilizes a second stage emergency stop. The signal electronics are directly into the robot controller for high accuracy surface detection in lateral and axial detection modes (X, Y, &Z).

The probe is mounted directly onto the Boundary Detection unit for accurate tooling and displacement calculations controlled by the robot kinematics. The probe is connected to an isolated probe interconnect where the output stage of the probe is fed directly into the amplifier stage of the Daq-Paq.

## 2.4 Daq-Paq (Analog to Digital Electronics)

ALSAS-10U incorporates a fully calibrated Daq-Paq (analog to digital conversion system) which has a 4 channel input stage, sent via a 2 stage auto-set amplifier module. The input signal is amplified accordingly so as to offer a dynamic range from  $5 \mu\text{V}$  to 800mV. Integration of the fields measured is carried out at board level utilizing a Co-Processor which then sends the measured fields down into the main computational module in digitized form via a RS232 communications port. Probe linearity and duty cycle compensation is carried out within the main Daq-Paq module.

<b>ADC</b>	12 Bit
Amplifier Range	20mV to 200mV and 150mV to 800mV
Field Integration	Local Co-Processor utilizing proprietary integration algorithms
Number of Input Channels	4 in total 3 dedicated and 1 spare
Communication	Packet data via RS232

## 2.5 Axis Articulated Robot

ALSAS-10U utilizes a six articulated robot, which is controlled using a Pentium based real-time movement controller. The movement kinematics engine utilizes proprietary (Thermo CRS) interpolation and extrapolation algorithms, which allow full freedom of movement for each of the six joints within the working envelop. Utilization of joint 6 allows for full probe rotation with a tolerance better than 0.05mm around the central axis.



<b>Robot/Controller Manufacturer</b>	Thermo CRS
<b>Number of Axis</b>	Six independently controlled axis
<b>Positioning Repeatability</b>	0.05mm
<b>Controller Type</b>	Single phase Pentium based C500C
<b>Robot Reach</b>	710mm
<b>Communication</b>	RS232 and LAN compatible

## 2.6 ALSAS Universal Workstation

ALSAS Universal workstation allows for repeatability and fast adaptability. It allows users to do calibration, testing and measurement using different types of phantoms with one set up, which significantly speeds up the measurement process.

## 2.7 Universal Device Positioner

The universal device positioner allows complete freedom of movement of the EUT. Developed to hold a EUT in a free-space scenario any additional loading attributable to the material used in the construction of the positioner has been eliminated. Repeatability has been enhanced through the linear scales which form the design used to indicate positioning for any given test scenario in all major axes. A 15° tilt movements for head SAR analysis. Overall uncertainty for measurements has been reduced due to the design of the Universal device positioner, which allows positioning of a device in as near to a free-space scenario as possible, and by providing the means for complete repeatability.



## 2.8 Phantom Types

The ALSAS-10U allows the integration of multiple phantom types. SAM Phantoms fully compliant with IEEE 1528, Universal Phantom, and Universal Flat.

### 2.8.1 APREL SAM Phantoms

The SAM phantoms developed using the IEEE SAM CAD file. They are fully compliant with the requirements for both IEEE 1528 and FCC Supplement C. Both the left and right SAM phantoms are interchangeable, transparent and include the IEEE 1528 grid with visible NF and MB lines.

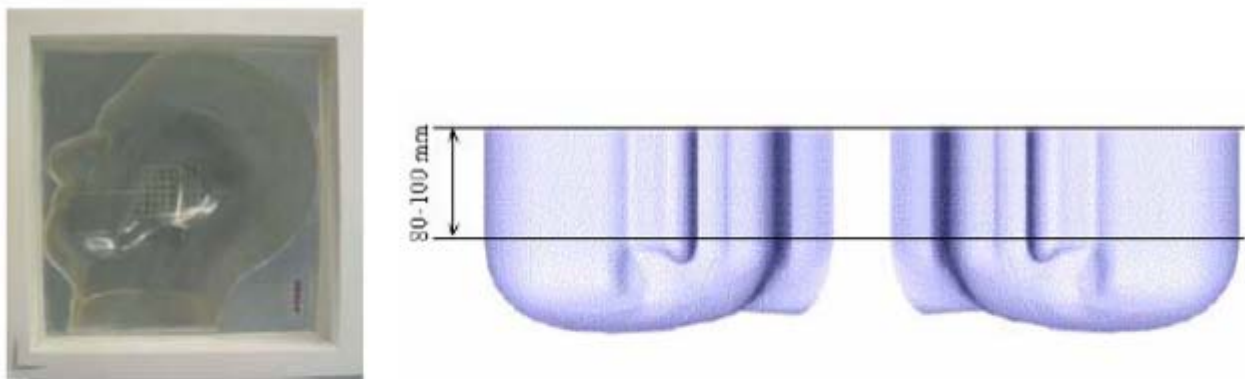

### 2.8.2 APREL Laboratories Universal Phantom

The Universal Phantom is used on the ALSAS-10U as a system validation phantom. The Universal Phantom has been fully validated both experimentally from 800MHz to 6GHz and numerically using XFDTD numerical software. The shell thickness is 2mm overall, with a 4mm spacer located at the NF/MB intersection providing an overall thickness of 6mm in line with the requirements of IEEE-1528.



The design allows for fast and accurate measurements, of handsets, by allowing the conservative SAR to be evaluated at on frequency for both left and right head experiments in one measurement.

### 3. Tissue Simulating Liquid

#### 3.1. The composition of the tissue simulating liquid

INGREDIENT ( % Weight)	850MHz	1900MHZ	850MHZ	1900MHz	2450MHz
	Head	Head	Body	Body	Body
Water	40.45%	54.9%	45.0%	70.17%	73.2%
Salt	1.45%	0.18%	52.4%	0.39%	0%
Sugar	57.6%	0%	1.4%	0%	0%
HEC	0.4%	0%	1.0%	0%	0%
Preventol	0.1%	0%	0.1%	0%	0%
DGBE	0%	44.92%	0%	29.44%	26.76%

#### 3.2. Tissue Calibration Result

The dielectric parameters of the liquids were verified prior to SAR evaluation using APREL Dielectric Probe Kit and Agilent E5071B Vector Network Analyzer.

Head Tissue Simulate Measurement				
Frequency (MHz)	Description	Dielectric Parameters		Tissue Temp.(°C)
		$\epsilon_r$	$\sigma$ (s/m)	
850MHz	Reference result	41.5	0.90	NA
	+/-5% window	39.425to43.575	0.855to0.945	
	13-Mra-12	40.38	0.92	20.7
1900MHz	Reference result	40.0	1.40	NA
	+/-5% window	38to42	1.33 to 1.47	
	13-Mra-12	40.09	1.42	20.7

2450MHz	Reference result	39.2	1.80	NA
	+/-5% window	37.24to41.16	1.71to1.89	
	13-Mar-12	40.01	1.83	20.7

Body Tissue Simulate Measurement				
Frequency (MHz)	Description	Dielectric Parameters		Tissue Temp.(°C)
		$\epsilon_r$	$\sigma$ (s/m)	
850MHz	Reference result	55.2	0.97	NA
	+/-5% window	52.44to57.96	0.922to1.019	
	13-Mar-12	54.08	0.95	20.7
1900MHz	Reference result	53.3	1.52	NA
	+/-5% window	50.635to55.965	1.444to1.596	
	13-Mar-12	52.13	1.54	20.7
2450MHz	Reference result	52.7	1.95	NA
	+/-5% window	50.065to55.335	1.852to2.0475	
	13-Mra-12	52.09	1.92	20.7

### 3.3. Tissue Dielectric Parameters for Head and Body Phantoms

The head tissue dielectric parameters recommended by the IEEE SCC-34/SC-2 in PP1528 have been incorporated in the following table. These head parameters are derived from planar layer models simulating the highest expected SAR for the dielectric

properties and tissue thickness variations in a human head. Other head and body tissue parameters that have not been specified in P1428 are derived from the tissue dielectric parameters computed from the 4-Cole-Cole equations described in Reference [12] and extrapolated according to the head parameters specified in P1528.

Target Frequency (MHz)	Head		Body	
	$\epsilon_r$	$\sigma$ (S/m)	$\epsilon_r$	$\sigma$ (S/m)
150	52.3	0.76	61.9	0.80
300	45.3	0.87	58.2	0.92
450	43.5	0.87	56.7	0.94
835	41.5	0.90	55.2	0.97
900	41.5	0.97	55.0	1.05
915	41.5	0.98	55.0	1.06
1450	40.5	1.20	54.0	1.30
1610	40.3	1.29	53.8	1.40
1800 – 2000	40.0	1.40	53.3	1.52
2450	39.2	1.80	52.7	1.95
3000	38.5	2.40	52.0	2.73
5800	35.3	5.27	48.2	6.00

( $\epsilon_r$ =relative permittivity,  $\sigma$ =conductivity and  $\rho=1000 \text{ Kg/m}^3$ )

**4. SAR Measurement Procedure**

**4.1. SAR System Validation**

**4.1.1. Validation Dipoles**

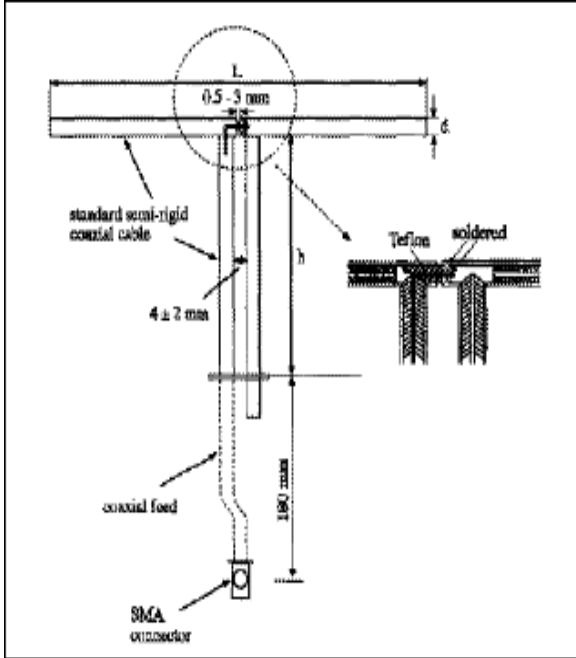

The dipoles used are based on the IEEE-1528 standard, and is complied with mechanical and electrical specifications in line with the requirements of both IEEE and FCC Supplement C. The table below provides details for the mechanical and electrical specifications for the dipoles.

Frequency	L(mm)	h(mm)	d(mm)
850MHz	161	89.8	3.6
1900MHz	67.1	38.9	3.6
2450MHz	51.5	30.4	3.6



## 4.1.2. Validation Result

## Head System Performance Check at 850MHz&amp;1900MHz

## Validation Kit: ASL-D-850-S-2

Frequency(MHz)	Description	SAR(W/Kg) 1g	SAR(W/Kg) 10g	Tissue Temp.(°C)
850MHz	Reference result	9.590	6.003	N/A
	+/-5%window	9.110to10.07	5.702to6.303	
	13-Mar-12(1W)	9.156	5.790	20.7

## Validation Kit: ASL-D-1900-S-2

Frequency(MHz)	Description	SAR(W/Kg) 1g	SAR(W/Kg) 10g	Tissue Temp.(°C)
1900MHz	Reference result	39.387	19.668	N/A
	+/-5%window	37.418to41.356	18.685to20.651	
	13-Mar-12(1W)	38.096	18.906	20.7

## Validation Kit: ASL-D-2450-S-2

Frequency(MHz)	Description	SAR(W/Kg) 1g	SAR(W/Kg) 10g	Tissue Temp.(°C)
24500MHz	Reference result	52.456	23.603	N/A
	+/-5%window	49.833to55.078	22.423to24.783	
	13-Mar-12(1W)	51.625	22.976	20.7

Note: All SAR values are normalized to 1 W forward power.

Body System Performance Check at 850MHz&1900MHz&2450MHz				
Validation Kit: ASL-D-850-S-2				
Frequency(MHz)	Description	SAR(W/Kg) 1g	SAR(W/Kg) 10g	Tissue Temp.(°C)
850MHz	Reference result	9.981	6.006	N/A
	+/-5%window	9.482to10.48	5.706to6.306	
	13-Mar-12(1W)	9.540	5.741	20.7
Validation Kit: ASL-D-1900-S-2				
Frequency(MHz)	Description	SAR(W/Kg) 1g	SAR(W/Kg) 10g	Tissue Temp.(°C)
1900MHz	Reference result	39.654	19.668	N/A
	+/-5%window	37.671to41.637	18.685to20.651	
	13-Mar-12(1W)	39.527	19.726	20.7
Validation Kit: ASL-D-2450-S-2				
Frequency(MHz)	Description	SAR(W/Kg) 1g	SAR(W/Kg) 10g	Tissue Temp.(°C)
2450MHz	Reference result	52.592	24.461	N/A
	+/-5%window	49.962to55.222	23.238to25.684	
	13-Mar-12(1W)	50.414	23.326	20.7
Note: All SAR values are normalized to 1W forward power.				

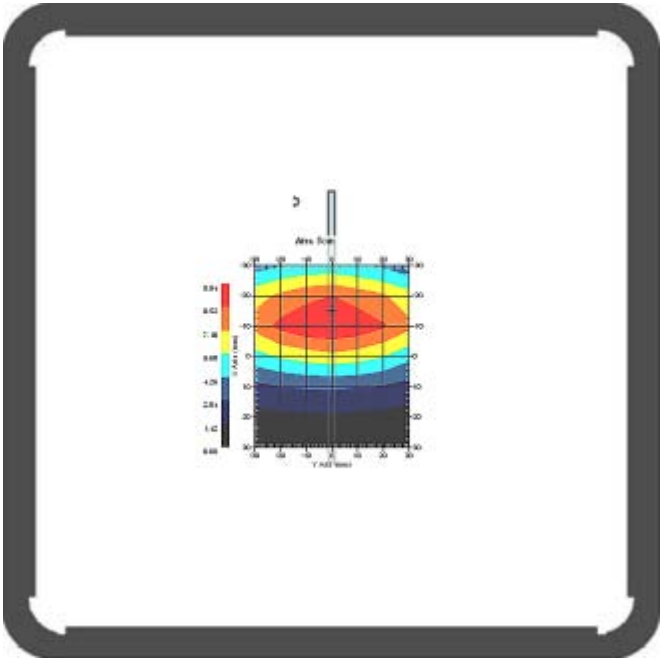
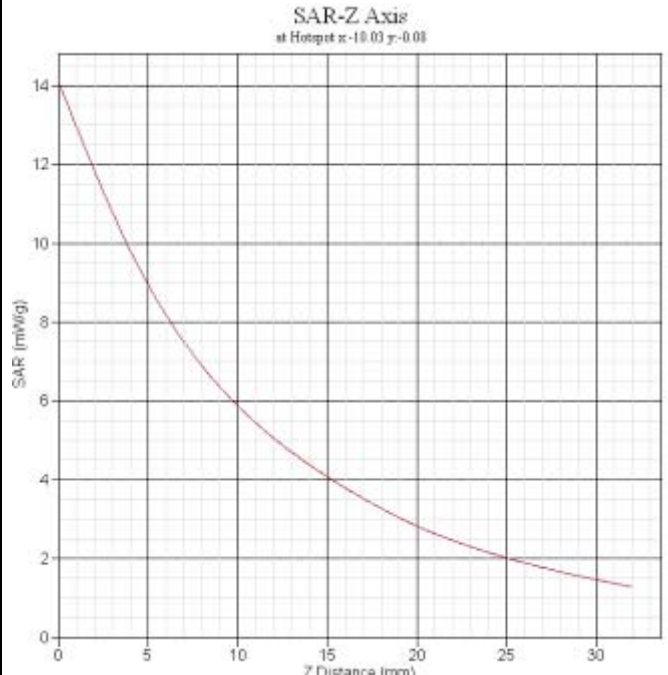
Frequency(MHz)	850
Relative permittivity(real part)	40.38
Conductivity(S/m)	0.92
Variation(%)	-0.320
Duty Cycle Factor	1
Crest factor	1
Conversion Fator	6.5
Probe Sensitivity	1.20 1.20 1.20 $\mu V/(V/m)^2$
Data	2012-03-13
	
SAR 1g(W/Kg)	9.156
SAR 10g(W/Kg)	5.790

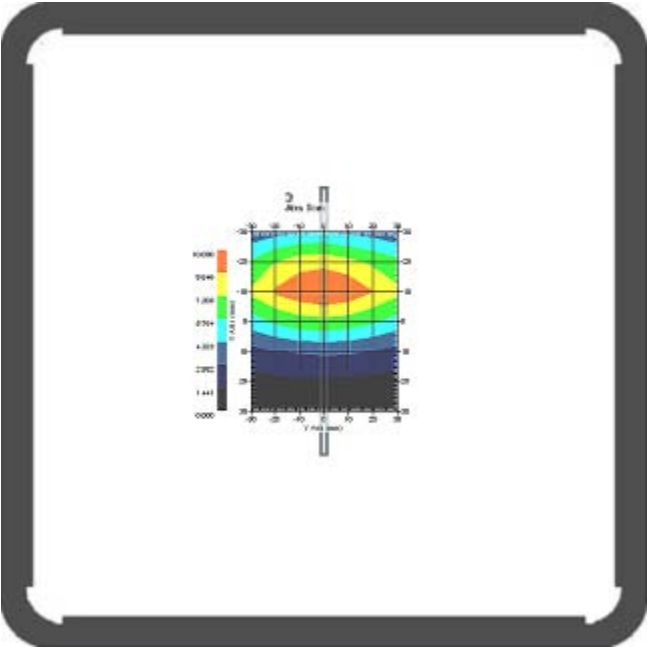
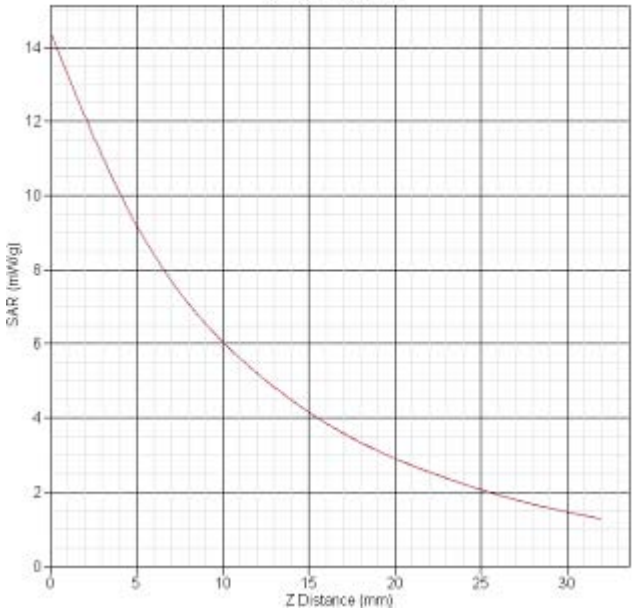
Frequency(MHz)	850
Relative permittivity(real part)	54.08
Conductivity(S/m)	0.95
Variation(%)	0.955
Duty Cycle Factor	1
Crest factor	1
Conversion Fator	6.4
Probe Sensitivity	1.20 1.20 1.20 $\mu V/(V/m)^2$
Data	2012-03-13
	<p>SAR-Z Axis at Hotspot x: 9.98 y: 0.13</p> 
SAR 1g(W/Kg)	9.540
SAR 10g(W/Kg)	5.741

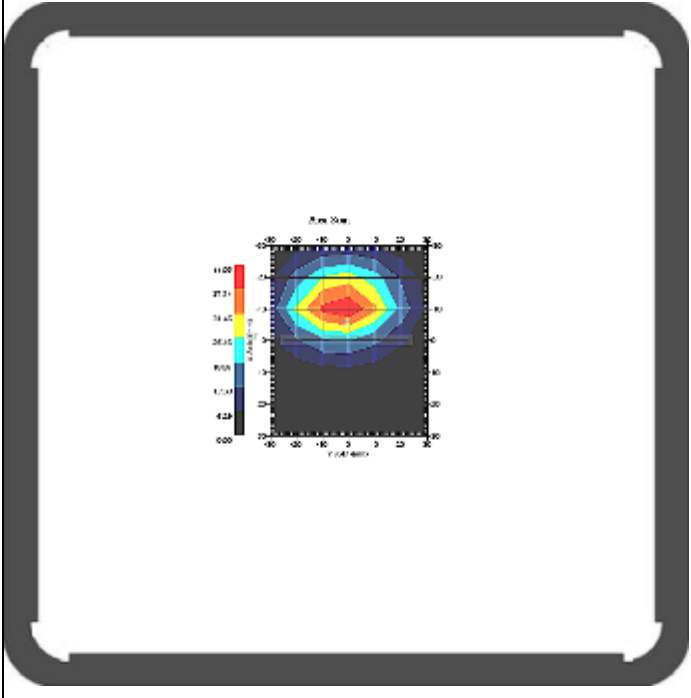
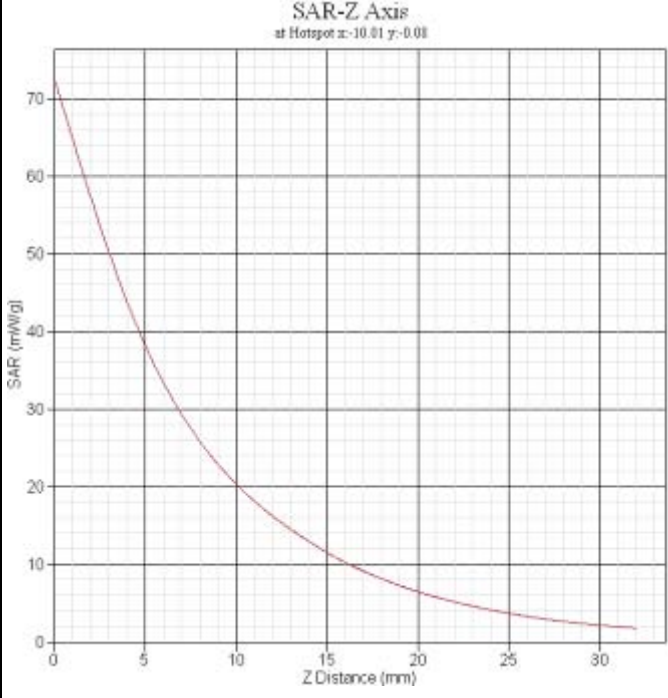
Frequency(MHz)	1900
Relative permittivity(real part)	40.09
Conductivity(S/m)	1.42
Variation(%)	1.186
Duty Cycle Factor	1
Crest factor	1
Conversion Fator	5.7
Probe Sensitivity	1.20 1.20 1.20 $\mu$ V/(V/m) <sup>2</sup>
Data	2012-03-13
	
SAR 1g(W/Kg)	38.096
SAR 10g(W/Kg)	18.906

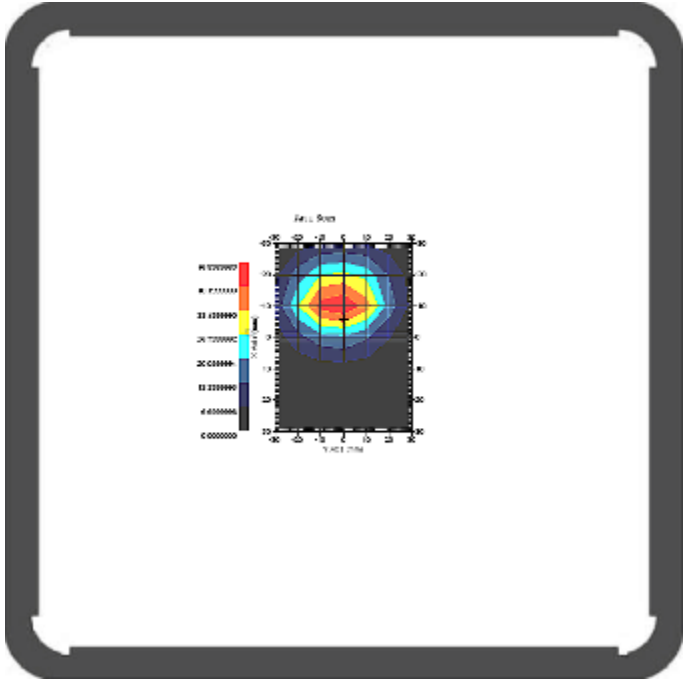
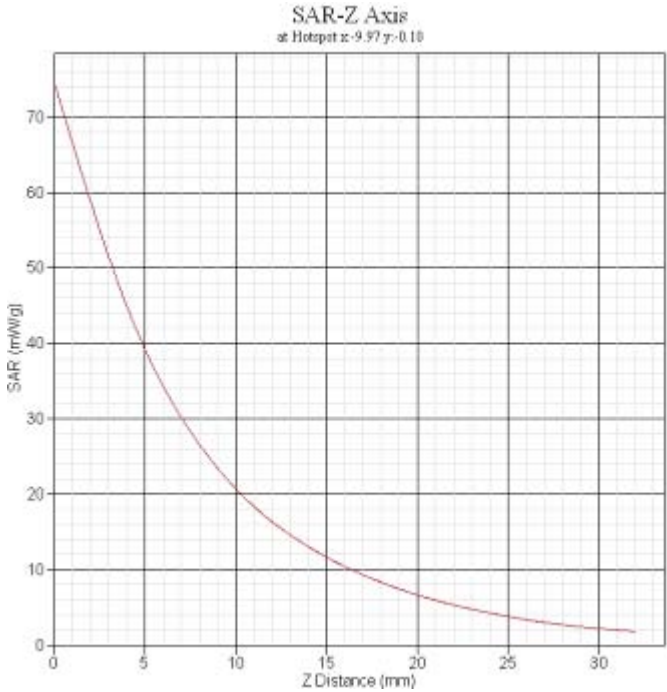
Frequency(MHz)	1900
Relative permittivity(real part)	52.13
Conductivity(S/m)	1.54
Variation(%)	0.199
Duty Cycle Factor	1
Crest factor	1
Conversion Fator	5.4
Probe Sensitivity	1.20 1.20 1.20 $\mu$ V/(V/m) <sup>2</sup>
Data	2012-03-13
	
SAR 1g(W/Kg)	39.527
SAR 10g(W/Kg)	19.726

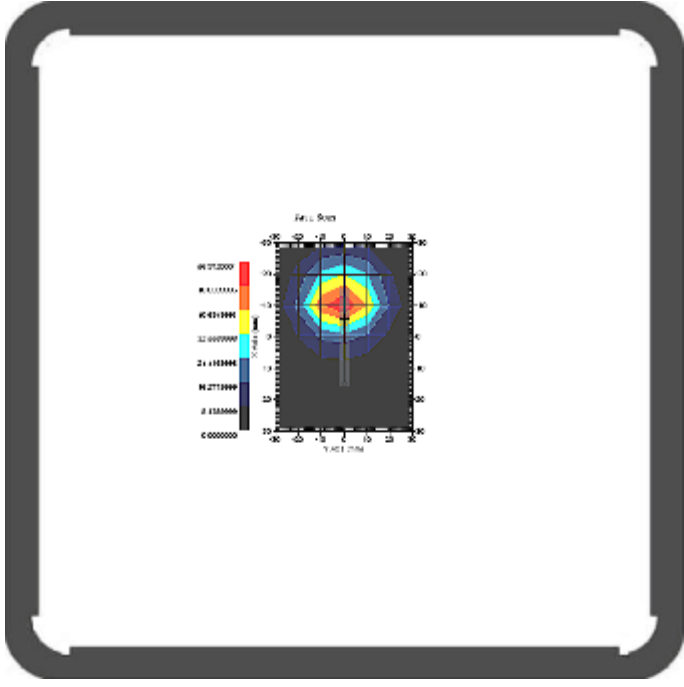
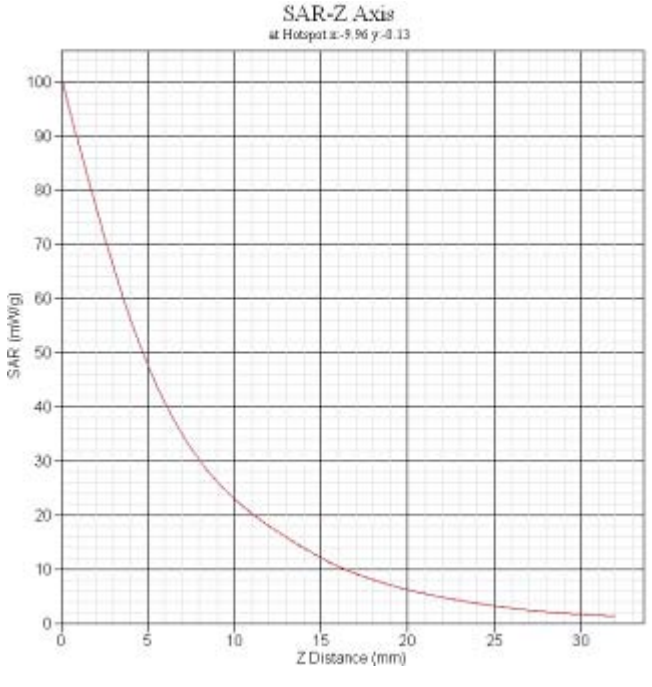
Frequency(MHz)	2450
Relative permittivity(real part)	40.01
Conductivity(S/m)	1.83
Variation(%)	1.024
Duty Cycle Factor	1
Crest factor	1
Conversion Fator	4.4
Probe Sensitivity	1.20 1.20 1.20 $\mu$ V/(V/m) <sup>2</sup>
Data	2012-03-13
	
SAR 1g(W/Kg)	51.625
SAR 10g(W/Kg)	23.976

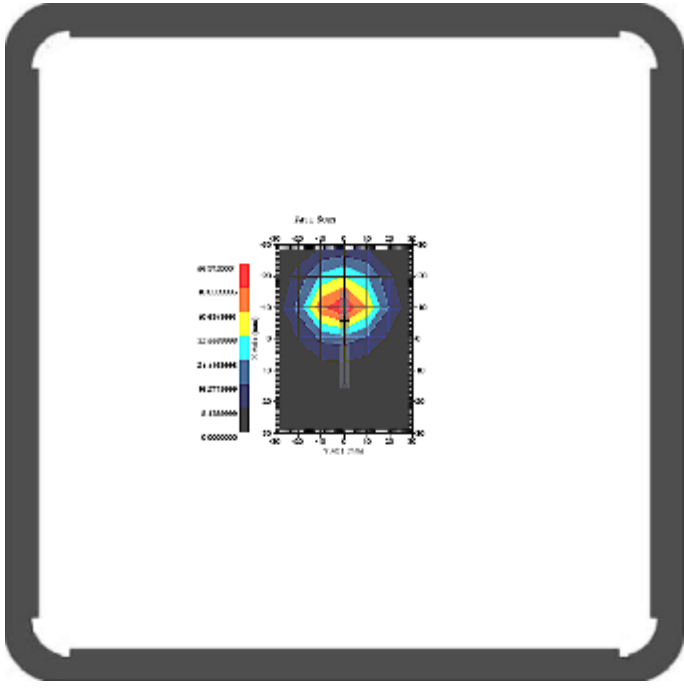
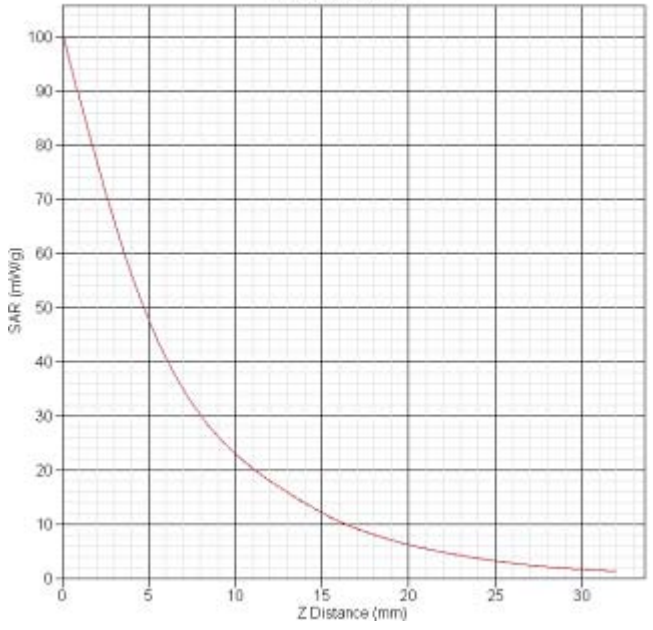
Frequency(MHz)	2450
Relative permittivity(real part)	52.09
Conductivity(S/m)	1.92
Variation(%)	-3.103
Duty Cycle Factor	1
Crest factor	1
Conversion Fator	4.4
Probe Sensitivity	1.20 1.20 1.20 $\mu$ V/(V/m) <sup>2</sup>
Data	2012-03-13
	
SAR 1g(W/Kg)	50.414
SAR 10g(W/Kg)	23.326



## 4.2. Arrangement Assessment Setup

### 4.2.1. Test Positions of Device Relative to Head

This specifies exactly two test positions for the handset against the head phantom, the “cheek” position and the “tilted” position. The handset should be tested in both positions on the left and right sides of the SAM phantom. If the handset construction is such that it cannot be positioned using the handset positioning procedures described in 4.2.2.1 and 4.2.2.2 to represent normal use conditions (e.g. asymmetric handset), alternative alignment procedures should be considered with details provided in the test report.

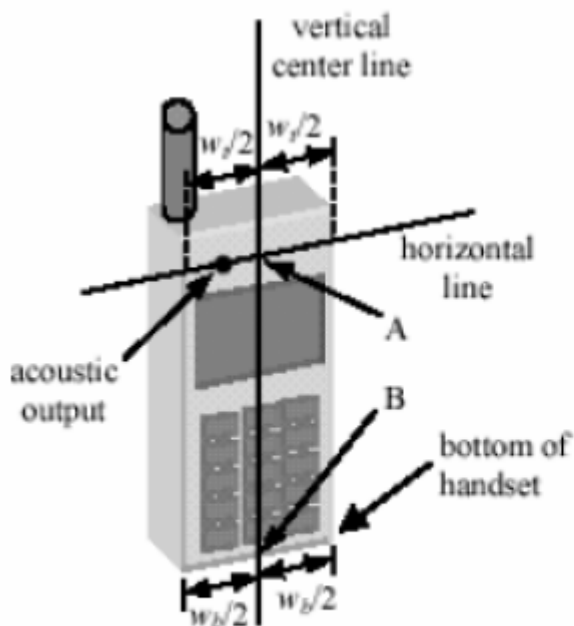

Figure 4.1a Internal Case

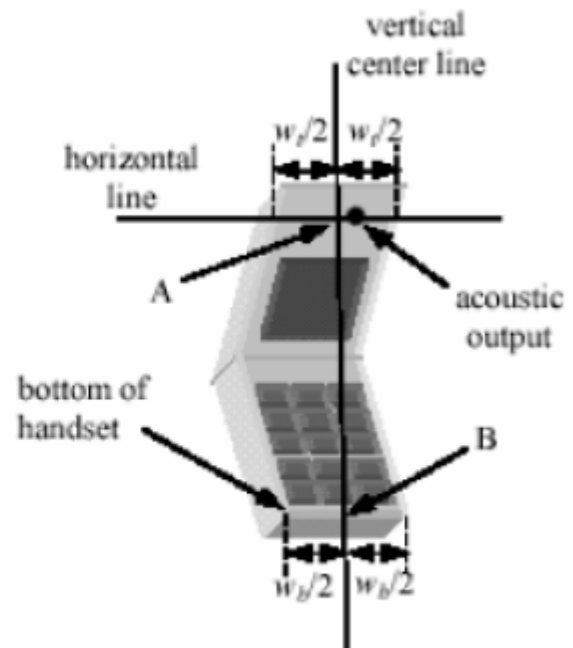

Figure 4.1b Clam Shell

#### 4.2.2.1. Definition of the “Cheek” Position

The “cheek” position is defined as follows:

- a. Ready the handset for talk operation, if necessary. For example, for hand sets with a cover piece, open the cover. (If the handset can also be used with the cover closed both configurations must be tested.)
- b. Define two imaginary lines on the handset: the vertical centerline and the horizontal line. The vertical centerline passes through two points on the front side of the handset: the midpoint of the width  $w_t$  of the handset at the level of the acoustic output (point A on Figures 4.1 a and 4.1 b), and the midpoint of the width  $w_b$  of the bottom of the handset through the center of the acoustic output (see Figure 4.1 a). The two lines intersect at point A. Note that for many handsets, point A coincides with the center of the acoustic output. However, the acoustic output may be located

- elsewhere on the horizontal line. Also note that the vertical centerline is not necessarily parallel to the front face of the handset (see Figure 4.1 b), especially for clamshell handsets, handsets with flip pieces, and other irregularly-shaped handsets.
- c. Position the handset close to the surface of the phantom such that point A is on the (virtual) extension of the line passing through points RE and LE on the phantom (see 4.2), such that the plan defined by the vertical center line and the horizontal line of the handset is approximately parallel to the sagittal plane of the phantom.
  - d. Translate the handset towards the phantom along the line passing through RE and LE until the handset touches the pinna.
  - e. While maintaining the handset in this plane, rotate it around the LE-RE line until the vertical centerline is in the plane normal to MB-NF including the line MB (called the reference plane).
  - f. Rotate the handset around the vertical centerline until the handset (horizontal line) is symmetrical with respect to the line NF.

While maintaining the vertical centerline in the reference plane, keeping point A on the line passing through RE and LE and maintaining the handset contact with the pinna, rotate the handset about the line NF until any point on the handset is in contact with a phantom point below the pinna (cheek). See Figure 4.2 the physical angles of rotation should be noted.

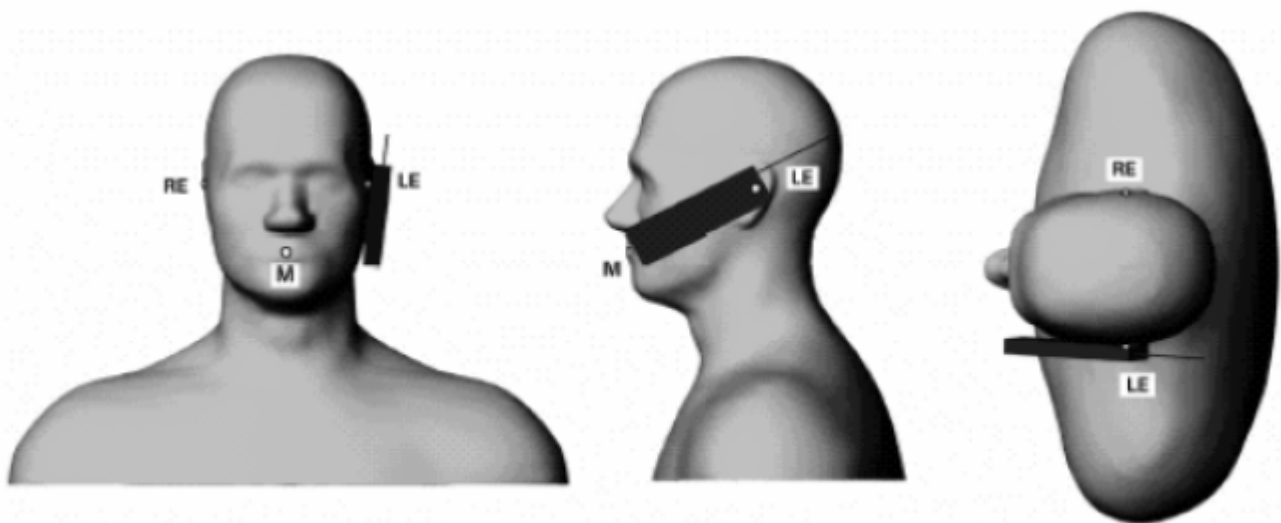

Figure 4.2 – Phone position 1, “cheek” or “touch” position.

#### 4.2.1.2 Definition of the “Tilted” Position

The “tilted” position is defined as follows:

- a. Repeat steps (a) – (g) of 4.2.1.1 to place the device in the “cheek position”.
- b. While maintaining the orientation of the handset move the handset away from the pinna along the line passing through RE and LE in order to enable a rotation of the handset by 15 degrees.
- c. Rotate the handset around the horizontal line by 15 degrees.

d. While maintaining the orientation of the handset, move the handset towards the phantom on a line passing through RE and LE until any part of the handset touches the ear. The tilted position is obtained when the contact is on the pinna. If the contact is at any location other than the pinna (e.g. the antenna with the bottom of the phantom head), the angle of the handset should be reduced. In this case, the tilted position is obtained if any part of the handset is in contact with the pinna as well as a second part of the handset is contact with the phantom (e.g. the antenna with bottom of the head).

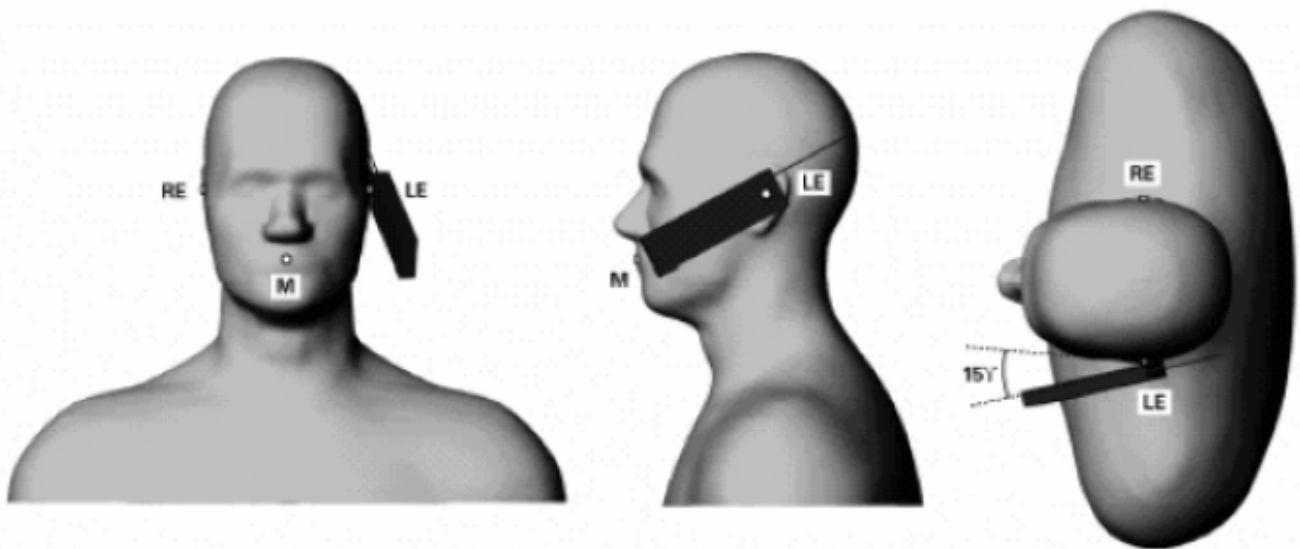

Figure 4.3 – Phone position 2, “tilted” position.

#### 4.2.2 Test Positions for body-worn

Body-worn operating configurations should be tested with the belt-clips and holsters attached to the device and positioned against a flat phantom in normal use configurations. A separation distance of 1.5 cm between the bottom of the device and a flat phantom is recommended for testing body-worn SAR compliance under such circumstances. Other separation distance may be use, but not exceed 2.5cm.

### 4.3. SAR Measurement Procedure

The ALSAS-10U calculates SAR using the following equation,

$$SAR = \frac{\sigma |E|^2}{\rho}$$

$\sigma$  :represents the simulated tissue conductivity

$\rho$  :represents the tissue density

The EUT is set to transmit at the required power in line with product specification, at each frequency relating to the LOW, MID, and HIGH channel settings.

Pre-scans are made on the device to establish the location for the transmitting antenna, using a large area scan in either air or tissue simulation fluid.

The EUT is placed against the Universal Phantom where the maximum area scan dimensions are large than the physical size of the resonating antenna. When the scan size is not large enough to cover the peak SAR distribution, it is modified by either extending the area scan size in both the X and Y directions, or the device is shifted within the predefined area.

The area scan is then run to establish the peak SAR location (interpolated resolution set at 1 mm<sup>2</sup>) which is then used to orient the center of the zoom scan. The zoom scan is then executed and the 1g and 10g averages are derived from the zoom scan volume (interpolated resolution set at 1 mm<sup>3</sup>).

## 5. SAR Exposure Limits

SAR assessments have been made in line with the requirements of IEEE C95.1-1999, IEEE 1528-2003 , FCC OET Bulletin 65 supplement C.

Type Exposure (W/kg)	Uncontrolled Environment Limit
Spatial Peak SAR (10g cube tissue for head and trunk)	1.60 W/kg
Spatial Average SAR (whole body)	0.08 W/kg
Spatial Peak SAR (10g for limb)	4.00 W/kg

**6. Test Equipment List**

Instrument	Manufacture	Model No.	Serial No.	Last Calibration
Universal Work Station	Aprl	ALS-UWS	100-00154	NCR
Data Acquisition Package	Aprl	ALS-DAQ-PAQ-3	110-00215	NCR
Probe Mounting Device and Boundary Detection Sensor System	Aprl	ALS-PMDPS-3	120-00265	NCR
Miniature E-Field Probe	Aprl	ALS-E-020	500-00282	Oct.01,2011
Left ear SAM Phantom	Aprl	ALS-P-SAM-L	130-00312	NCR
Right ear SAM Phantom	Aprl	ALS-P-SAM-R	140-00362	NCR
Universal SAM Phantom	Aprl	ALS-P-SU-1	150-00410	NCR
Reference Validation Dipole 850MHz	Aprl	ALS-D-850-S-2	180-00556	May.19,2011
Reference Validation Dipole 1900MHz	Aprl	ALS-D-1900-S-2	210-00707	May.16,2011
Reference Validation Dipole 2450MHz	Aprl	ALS-D-2450-S-2	220-00755	May.19,2011
Dielectric Probe Kit	Aprl	ALS-PR-DIEL	260-00955	NCR
Device Holder 2.0	Aprl	ALS-H-E-SET-2	170-00506	NCR
SAR software	Aprl	ALS-SAR-AL-10	Ver.2.3.8	NCR
CRS C500C Controller	Thermo	ALS-C500	RCF0504291	NCR
CRS F3 Robot	Aprl	ALS-F3-SW	N/A	NCR
Power Amplifier	Mini-Circuit	ZHL- 42	040306	Jul.13,2011
Directional Coupler	Agilent	778D-012	51011	Jul.13,2011
Universal Radio Communication Tester	Agilent	E5515C	104845	Mar.1,2012
Vector Network	Agilent	E5071B	MY4230146	Jul.18,2011
Signal Generator	Agilent	E8257D	N/A	Dec.05,2011
Power Meter	Rohde&Schwarz	NRP	N/A	Dec.05,2011

**Note: All equipment upon which need to be calibrated are with calibration period of 1 year.**

## 7. Measurement Uncertainty

### Exposure Assessment Measurement Uncertainty

Source of Uncertainty	Tolerance Value	Probability Distribution	Divisor	$c_i^1$ (1-g)	$c_i^1$ (10-g)	Standard Uncertainty (1-g) %	Standard Uncertainty (10-g) %
Measurement System							
Probe Calibration	3.5	normal	1	1	1	3.5	3.5
Axial Isotropy	3.7	rectangular	$\sqrt{3}$	$(1-cp)^{1/2}$	$(1-cp)^{1/2}$	1.5	1.5
Hemispherical Isotropy	10.9	rectangular	$\sqrt{3}$	$\sqrt{cp}$	$\sqrt{cp}$	4.4	4.4
Boundary Effect	1.0	rectangular	$\sqrt{3}$	1	1	0.6	0.6
Linearity	4.7	rectangular	$\sqrt{3}$	1	1	2.7	2.7
Detection Limit	1.0	rectangular	$\sqrt{3}$	1	1	0.6	0.6
Readout Electronics	1.0	normal	1	1	1	1.0	1.0
Response Time	0.8	rectangular	$\sqrt{3}$	1	1	0.5	0.5
Integration Time	1.7	rectangular	$\sqrt{3}$	1	1	1.0	1.0
RF Ambient Condition	3.0	rectangular	$\sqrt{3}$	1	1	1.7	1.7
Probe Positioner Mech.	0.4	rectangular	$\sqrt{3}$	1	1	0.2	0.2
Restriction							
Probe Positioning with respect to Phantom Shell	2.9	rectangular	$\sqrt{3}$	1	1	1.7	1.7
Extrapolation and Integration	3.7	rectangular	$\sqrt{3}$	1	1	2.1	2.1
Test Sample Positioning	4.0	normal	1	1	1	4.0	4.0
Device Holder Uncertainty	2.0	normal	1	1	1	2.0	2.0
Drift of Output Power	0.6	rectangular	$\sqrt{3}$	1	1	0.3	0.3
Phantom and Setup							
Phantom Uncertainty(shape & thickness tolerance)	3.4	rectangular	$\sqrt{3}$	1	1	2.0	2.0
Liquid Conductivity(target)	5.0	rectangular	$\sqrt{3}$	0.7	0.5	2.0	1.4
Liquid Conductivity(meas.)	0.0	normal	1	0.7	0.5	0.0	0.0

Liquid Permittivity(target)	5.0	rectangular	$\sqrt{3}$	0.6	0.5	1.7	1.4
Liquid Permittivity(meas.)	2.4	normal	1	0.6	0.5	1.4	1.2
Combined Uncertainty		RSS				9.3	9.2
Combined Uncertainty (coverage factor=2)		Normal (k=2)				18.7	18.3

## 8. Test Results

### 8.1. SAR Test Results Summary

SAR MEASUREMENT					
Ambient Temperature (°C): 21.2 ± 2			Relative Humidity (%): 46		
Liquid Temperature (°C): 20.5 ± 2			Depth of Liquid (cm):>15		
Product: GSM Mobile Phone					
Test Mode: GSM850					
Test Position Head	Antenna Position	Frequency		SAR 1g (W/kg)	Limit (W/kg)
		Channel	MHz		
Left-Cheek	Internal	190	836.6	0.610	1.6
Left-Tilted	Internal	190	836.6	0.488	1.6
Right- Cheek	Internal	190	836.6	0.595	1.6
Right -Tilted	Internal	190	836.6	0.448	1.6
Left- Cheek	Internal	128	824.2	0.551	1.6
Left- Cheek	Internal	251	848.8	0.598	1.6

SAR MEASUREMENT					
Ambient Temperature (°C): 21.2 ± 2			Relative Humidity (%): 46		
Liquid Temperature (°C): 20.5 ± 2			Depth of Liquid (cm):>15		
Product:GSM Mobile Phone					
Test Mode: PCS 1900					
Test Position Head	Antenna Position	Frequency		SAR 1g (W/kg)	Limit (W/kg)
		Channel	MHz		
Left-Cheek	Internal	661	1880.0	1.018	1.6
Left- Tilted	Internal	661	1880.0	0.358	1.6
Right-Cheek	Internal	661	1880.0	1.056	1.6
Right -Tilted	Internal	661	1880.0	0.266	1.6
Left-Cheek	Internal	512	1850.2	0.997	1.6
Left-Cheek	Internal	810	1909.8	1.004	1.6
Right-Cheek	Internal	512	1850.2	0.891	1.6
Right-Cheek	Internal	810	1909.8	0.958	1.6

SAR MEASUREMENT					
Ambient Temperature (°C): 21.2 ± 2			Relative Humidity (%): 46		
Liquid Temperature (°C): 20.5 ± 2			Depth of Liquid (cm):>15		
Product: GSM Mobile Phone					
Test Mode: 802.11b					
Test Position Head	Antenna Position	Frequency		SAR 1g (W/kg)	Limit (W/kg)
		Channel	MHz		
Left-Cheek	Internal	6	2437	0.060	1.6
Left- Tilted	Internal	6	2437	0.026	1.6
Right-Cheek	Internal	6	2437	0.055	1.6
Right -Tilted	Internal	6	2437	0.029	1.6



SAR MEASUREMENT					
Ambient Temperature (°C): 21.2 ± 2			Relative Humidity (%): 46		
Liquid Temperature (°C): 20.5 ± 2			Depth of Liquid (cm):>15		
Product: GSM Mobile Phone					
Test Mode: 802.11g					
Test Position Head	Antenna Position	Frequency		SAR 1g (W/kg)	Limit (W/kg)
		Channel	MHz		
Left-Cheek	Internal	6	2437	0.034	1.6
Left- Tilted	Internal	6	2437	0.035	1.6
Right-Cheek	Internal	6	2437	0.036	1.6
Right -Tilted	Internal	6	2437	0.020	1.6

#### DUT with Flat Phantom 1.5cm Gap

SAR MEASUREMENT					
Ambient Temperature (°C): 21.2 ± 2			Relative Humidity (%): 46		
Liquid Temperature (°C): 20.5 ± 2			Depth of Liquid (cm):>15		
Product:GSM Mobile Phone					
Test Mode: GPRS850+Earphone					
Test Position Body	Antenna Position	Frequency		SAR 1g (W/kg)	Limit (W/kg)
		Channel	MHz		
Body face	Internal	190	836.6	0.699	1.6
Body bottom	Internal	190	836.6	0.885	1.6
Body bottom	Internal	128	824.2	0.736	1.6
Body bottom	Internal	251	848.8	1.051	1.6

**DUT with Flat Phantom 1.5cm Gap**

SAR MEASUREMENT					
Ambient Temperature (°C): 21.2 ± 2			Relative Humidity (%): 46		
Liquid Temperature (°C): 20.5 ± 2			Depth of Liquid (cm):>15		
Product: GSM Mobile Phone					
Test Mode: GPRS 1900+Earphone					
Test Position Body	Antenna Position	Frequency		SAR 10g (W/kg)	Limit (W/kg)
		Channel	MHz		
Body face	Internal	661	1880.0	1.111	1.6
Body bottom	Internal	661	1880.0	0.995	1.6
Body bottom	Internal	512	1850.2	0.739	1.6
Body bottom	Internal	810	1909.8	0.724	1.6
Body face	Internal	512	1850.2	0.965	1.6
Body face	Internal	810	1909.8	0.840	1.6

**DUT with Flat Phantom 1.5cm Gap**

SAR MEASUREMENT					
Ambient Temperature (°C): 21.2 ± 2			Relative Humidity (%): 46		
Liquid Temperature (°C): 20.5 ± 2			Depth of Liquid (cm):>15		
Product: GSM Mobile Phone					
Test Mode: 802.11b					
Test Position Body	Antenna Position	Frequency		SAR 1g (W/kg)	Limit (W/kg)
		Channel	MHz		
Body face	Internal	6	2437	0.137	1.6
Body bottom	Internal	6	2437	0.349	1.6

## DUT with Flat Phantom 1.5cm Gap

SAR MEASUREMENT					
Ambient Temperature (°C): 21.2 ± 2			Relative Humidity (%): 46		
Liquid Temperature (°C): 20.5 ± 2			Depth of Liquid (cm):>15		
Product: GSM Mobile Phone					
Test Mode: 802.11g					
Test Position Body	Antenna Position	Frequency		SAR 1g (W/kg)	Limit (W/kg)
		Channel	MHz		
Body face	Internal	6	2437	0.041	1.6
Body bottom	Internal	6	2437	0.195	1.6

**Note:**

According to the above tables:

Summation SAR=1.111 (face,GPRS1900,ch661) +0.349(bottom,802.11b,ch2437) =1.46

According to KDB 648474, the sum of SAR values for GPRS and WiFi < 1.6W/kg, so the simultaneous transmission SAR was not required.

**8.2 Conducted Power(Unit:dBm)**

Band	GSM850			GSM1900		
	Channel	128	190	251	512	661
Frequency(MHz)	824.2	836.6	848.8	1850.2	1880.0	1909.8
GSM	31.35	31.49	31.42	29.64	29.71	29.70

Band	Conducted Power (dBm)			Factor (dB)	Average Power (dBm)		
	Channel	128	190		251	128	190
Frequency(MHz)	824.2	836.6	848.8		824.2	836.6	848.8
GPRS8(1up)	30.54	30.57	30.60	-9.03	21.24	21.54	21.57
GPRS10(2up)	30.59	30.61	30.64	-6.02	24.57	24.59	24.62
GPRS12(4up)	29.61	29.92	29.87	-3.01	26.6	26.91	26.86

Band	Conducted Power (dBm)			Factor (dB)	Average Power (dBm)		
	Channel	512	661		810	512	661
Frequency(MHz)	1850.2	1880.0	1909.8		1850.2	1880.0	1909.8
GPRS8(1up)	29.43	29.55	29.51	-9.03	20.4	20.52	20.48
GPRS10(2up)	28.42	28.57	28.55	-6.02	22.4	22.55	22.53
GPRS12(4up)	27.93	28.17	28.57	-3.01	24.92	25.16	25.56

**NOTES:**

Division Factors:

To average the power, the division factor is as follows:

1TX-slot = 1 transmit time slot out of 8 time slots=> conducted power divided by (8/1) => -9.03dB

2TX-slots = 2 transmit time slots out of 8 time slots=> conducted power divided by (8/2) => -6.02dB

3TX-slots = 3 transmit time slots out of 8 time slots=> conducted power divided by (8/3) => -4.26dB

4TX-slots = 4 transmit time slots out of 8 time slots=> conducted power divided by (8/4) => -3.01dB

**According to the conducted power as above, the body measurements are performed in GPRS Class 12 Channel 190 for 850 band and GPRS12 Channel 661 for 1900 Band.**

**WIFI and Bluetooth Function:**

The distance between BT antenna and GSM antenna is 13mm.

The distance between BT antenna and WLAN antenna is 36mm.

The distance between WLAN antenna and GSM antenna is 43mm. The location of the antennas inside mobile phone is shown below:



The conducted power for BT antenna is as following:

Channel	Frequency	Bluetooth RF Output Power (dBm)		
		Data Rate / Modulation		
		GFSK	$\pi$ /4-DQPSK	8-DPSK
		1Mbps	2Mbps	3Mbps
Ch00	2402MHz	<b>8.31</b>	7.74	7.82
Ch39	2441MHz	8.09	7.31	7.53
Ch78	2480MHz	7.92	7.13	7.23

The conducted power for WiFi is as following:

Channel	Frequency	2.4GHz 802.11b RF Power (dBm)			
		At DSSS Data Rate			
		1 Mbps	2 Mbps	5.5 Mbps	11 Mbps
CH 01	2412 MHz	17.45	16.94	17.33	17.01
CH 06	2437 MHz	<b>17.58</b>	16.62	17.03	17.03
CH 11	2462 MHz	17.42	17.12	16.83	16.68

Channel	Frequency	2.4GHz 802.11g RF Power (dBm)							
		At OFDM Data Rate							
		6	9	12	18	24	36	48	54
		Mbps	Mbps	Mbps	Mbps	Mbps	Mbps	Mbps	Mbps
CH01	2412MHz	17.66	17.08	17.66	16.97	17.53	17.11	17.39	17.35
CH06	2437MHz	<b>17.82</b>	16.93	17.69	17.62	17.47	17.25	17.27	17.52
CH11	2462MHz	17.58	17.38	17.52	17.82	17.62	17.12	17.18	17.62

The BT conduct Power is 6.78mW <12mW(PRef) and its antenna is < 2.5 cm from other antenna. we can draw the conclusion that: SAR for BT is required.

The conducted power for WiFi transmitter is 60.53mW > 24mW(2PRef) and its antenna is < 5 cm from other antenna. we can draw the conclusion that: When the output of an unlicensed transmitter is > 2PRef and its antenna(s) is < 5.0 cm from other antennas, stand-alone SAR evaluation is also not required for that unlicensed transmitter. Because the conducted power for WiFi transmitter is > 2PRef and its antenna is < 5cm from other antenna, stand-alone SAR for WiFi should be performed. Then, simultaneous transmission SAR for WiFi is considered with measurement results of GSM and WiFi.

## References:

- [1] FCC 47 CFR Part 2 “Frequency Allocations and Radio Treaty Matters; General Rules and Regulations”
- [2] IEEE Std. C95.1-1999, “IEEE Standard for Safety Levels with Respect to Human Exposure to Radio Frequency Electromagnetic Fields, 3 kHz to 300 GHz”, 1999
- [3] IEEE Std. 1528-2003, “Recommended Practice for Determining the Peak Spatial-Average Specific Absorption Rate (SAR) in the Human Head from Wireless Communications Devices: Measurement Techniques”, December 2003
- [4] FCC OET Bulletin 65 (Edition 97-01) Supplement C (Edition 01-01), “Evaluating Compliance with FCC Guidelines for Human Exposure to Radiofrequency Electromagnetic Fields”, June 2001
- [5] SPEAG DASY System Handbook
- [6] FCC KDB 248227 D01 v01r02, “SAR Measurement Procedures for 802.11 a/b/g Transmitters”, May 2007
- [7] FCC KDB 447498 D01 v04, “Mobile and Portable Device RF Exposure Procedures and Equipment Authorization Policies”, November 2009
- [8] FCC KDB 447498 D02 v02, “SAR Measurement Procedures for USB Dongle Transmitters”, November 2009
- [9] FCC KDB 616217 D01 v01r01, “SAR Evaluation Considerations for Laptop Computers with Antennas Built-in on Display Screens”, November 2009
- [10] FCC KDB 616217 D03 v01, “SAR Evaluation Considerations for Laptop/Notebook/Netbook and Tablet Computers”, November 2009
- [11] FCC KDB 648474 D01 v01r05, “SAR Evaluation Considerations for Handsets with Multiple Transmitters and Antennas”, September 2008
- [12] FCC KDB 941225 D01 v02, “SAR Measurement Procedures for 3G Devices – CDMA 2000 / Ev-Do / WCDMA / HSDPA / HSPA”, October 2007
- [13] FCC KDB 941225 D03 v01, “Recommended SAR Test Reduction Procedures for GSM / GPRS /EDGE”, December 2008
- [14] KDB 941225 D04 SAR for GSM E GPRS Dual Xfer Mode v01
- [15] 941225 D06 Hot Spot SAR v01

8.3. SAR Measurement Data

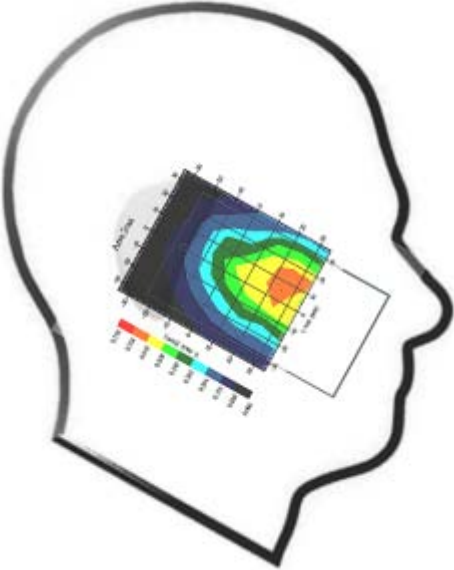
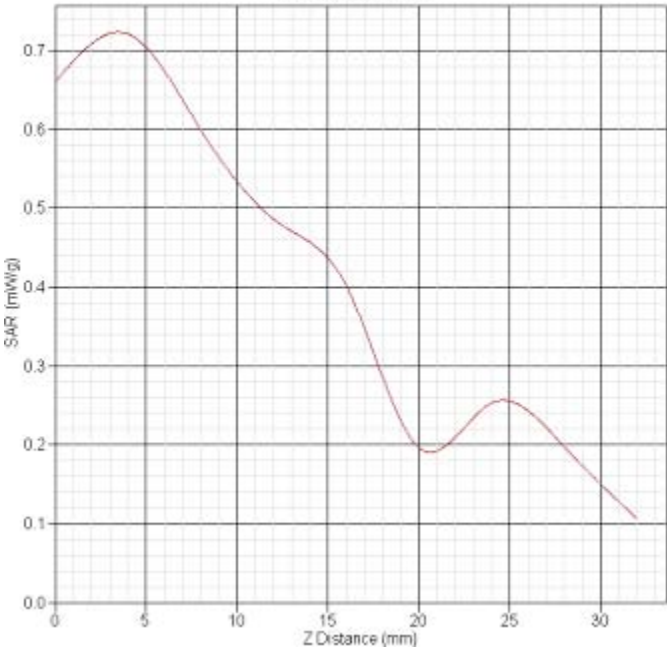
<b>GSM850 left cheek ch190</b>	
Frequency(MHz)	836.6
Relative permittivity(real part)	40.38
Conductivity(S/m)	0.92
Variation(%)	-3.512
Duty Cycle Factor	8
Crest factor	8
Conversion Fator	6.5
Probe Sensitivity	1.20 1.20 1.20 $\mu$ V/(V/m) <sup>2</sup>
Data	2012-03-13
	<p><b>SAR-Z AXIS</b> at Hotspot: x=0.11 y=4.96</p> 
SAR 1g(W/Kg)	0.610
SAR 10g(W/Kg)	0.408

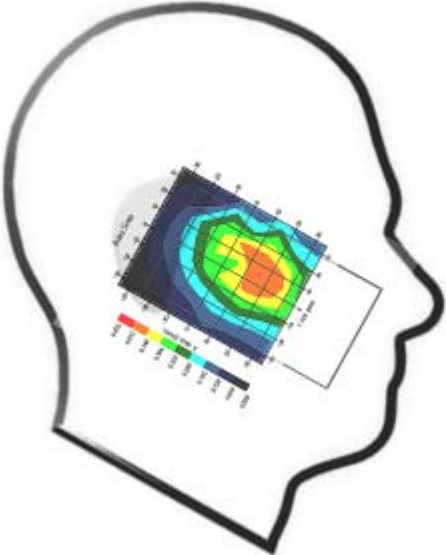
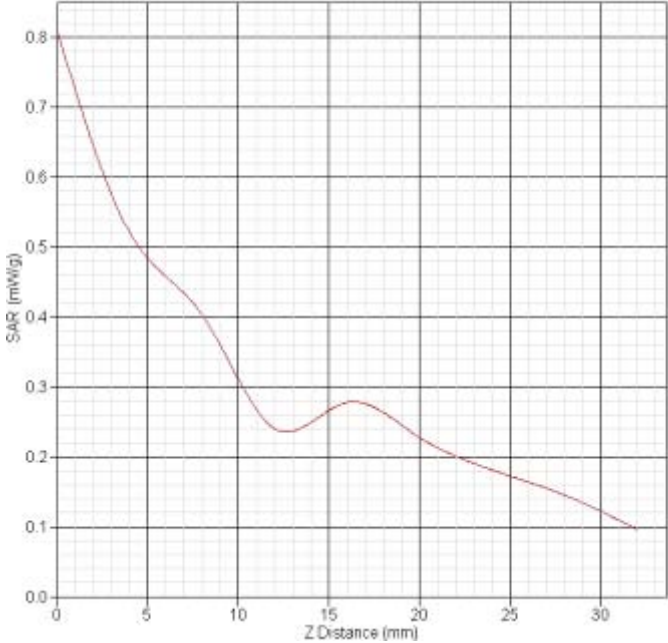
<b>GSM850 left tilt ch190</b>																	
Frequency(MHz)	836.6																
Relative permittivity(real part)	40.38																
Conductivity(S/m)	0.92																
Variation(%)	-1.541																
Duty Cycle Factor	8																
Crest factor	8																
Conversion Fator	6.5																
Probe Sensitivity	1.20 1.20 1.20 $\mu$ V/(V/m) <sup>2</sup>																
Data	2012-03-13																
	<p>SAR-Z Axis at Hotspot x:30.13 y:4.93</p>  <table border="1"> <caption>SAR-Z Axis Data Points (Estimated)</caption> <thead> <tr> <th>Z Distance (mm)</th> <th>SAR (mW/kg)</th> </tr> </thead> <tbody> <tr><td>0</td><td>0.80</td></tr> <tr><td>5</td><td>0.50</td></tr> <tr><td>10</td><td>0.30</td></tr> <tr><td>15</td><td>0.28</td></tr> <tr><td>20</td><td>0.22</td></tr> <tr><td>25</td><td>0.18</td></tr> <tr><td>30</td><td>0.10</td></tr> </tbody> </table>	Z Distance (mm)	SAR (mW/kg)	0	0.80	5	0.50	10	0.30	15	0.28	20	0.22	25	0.18	30	0.10
Z Distance (mm)	SAR (mW/kg)																
0	0.80																
5	0.50																
10	0.30																
15	0.28																
20	0.22																
25	0.18																
30	0.10																
SAR 1g(W/Kg)	0.488																
SAR 10g(W/Kg)	0.327																

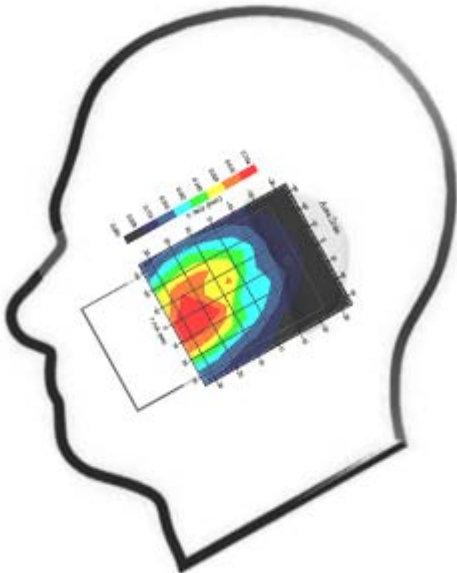
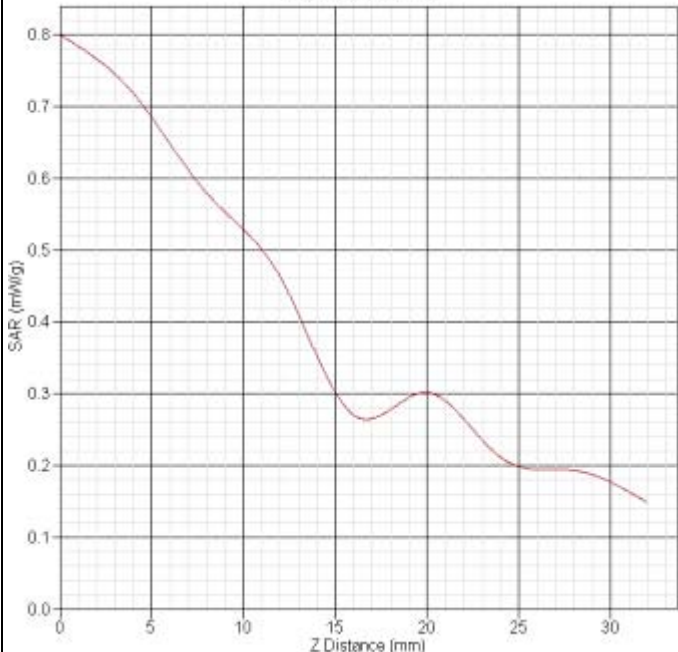

<b>GSM850 Right cheek ch190</b>	
Frequency(MHz)	836.6
Relative permittivity(real part)	40.38
Conductivity(S/m)	0.92
Variation(%)	3.357
Duty Cycle Factor	8
Crest factor	8
Conversion Fator	6.5
Probe Sensitivity	1.20 1.20 1.20 $\mu$ V/(V/m) <sup>2</sup>
Data	2012-03-13
	<p>SAR-Z Axis at Hotspot x:40.07 y:-2.99</p> 
SAR 1g(W/Kg)	0.595
SAR 10g(W/Kg)	0.415

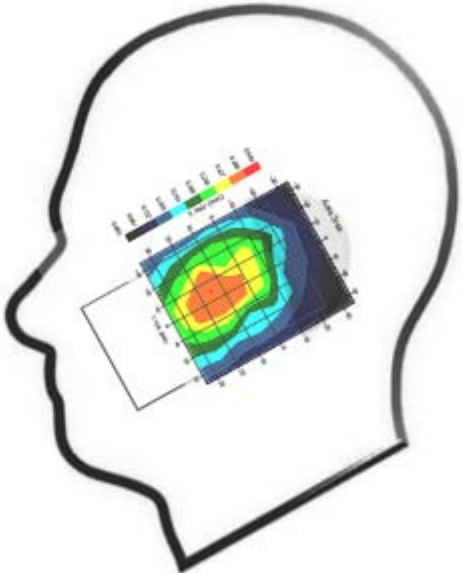
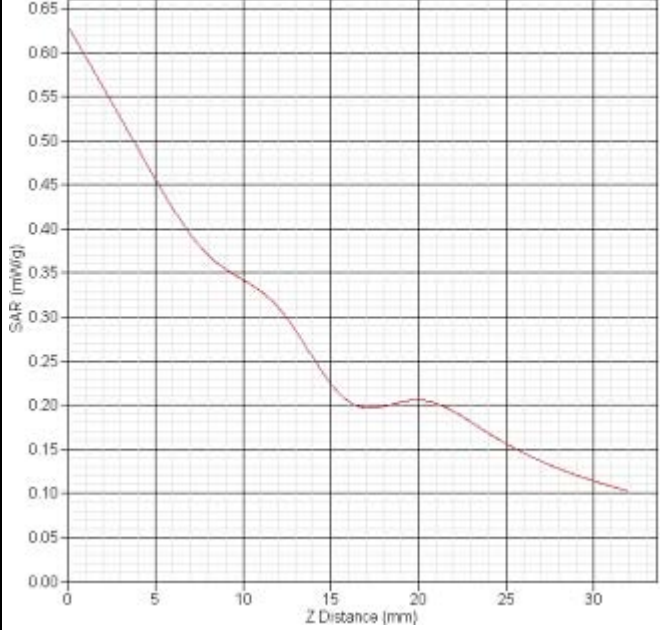
<b>GSM850 Right tilt CH190</b>																	
Frequency(MHz)	836.6																
Relative permittivity(real part)	40.38																
Conductivity(S/m)	0.92																
Variation(%)	-0.756																
Duty Cycle Factor	8																
Crest factor	8																
Conversion Fator	6.5																
Probe Sensitivity	1.20 1.20 1.20 $\mu$ V/(V/m) <sup>2</sup>																
Data	2012-03-13																
	<p>SAR-Z Axis at Hotspot x 30.13 y -4.91</p>  <table border="1"> <caption>SAR-Z Axis Data</caption> <thead> <tr> <th>Z Distance (mm)</th> <th>SAR (mW/kg)</th> </tr> </thead> <tbody> <tr><td>0</td><td>0.65</td></tr> <tr><td>5</td><td>0.45</td></tr> <tr><td>10</td><td>0.35</td></tr> <tr><td>15</td><td>0.20</td></tr> <tr><td>20</td><td>0.21</td></tr> <tr><td>25</td><td>0.15</td></tr> <tr><td>30</td><td>0.10</td></tr> </tbody> </table>	Z Distance (mm)	SAR (mW/kg)	0	0.65	5	0.45	10	0.35	15	0.20	20	0.21	25	0.15	30	0.10
Z Distance (mm)	SAR (mW/kg)																
0	0.65																
5	0.45																
10	0.35																
15	0.20																
20	0.21																
25	0.15																
30	0.10																
SAR 1g(W/Kg)	0.448																
SAR 10g(W/Kg)	0.298																

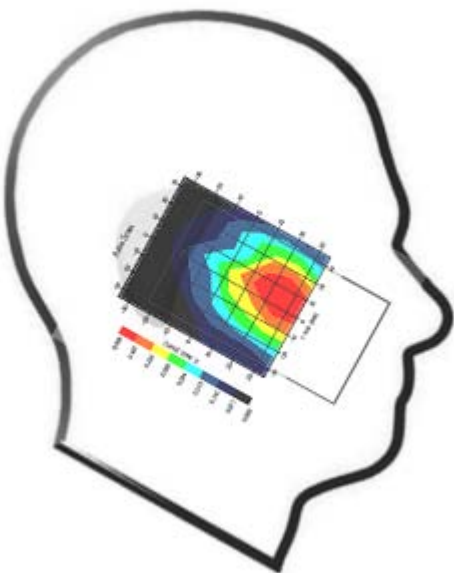
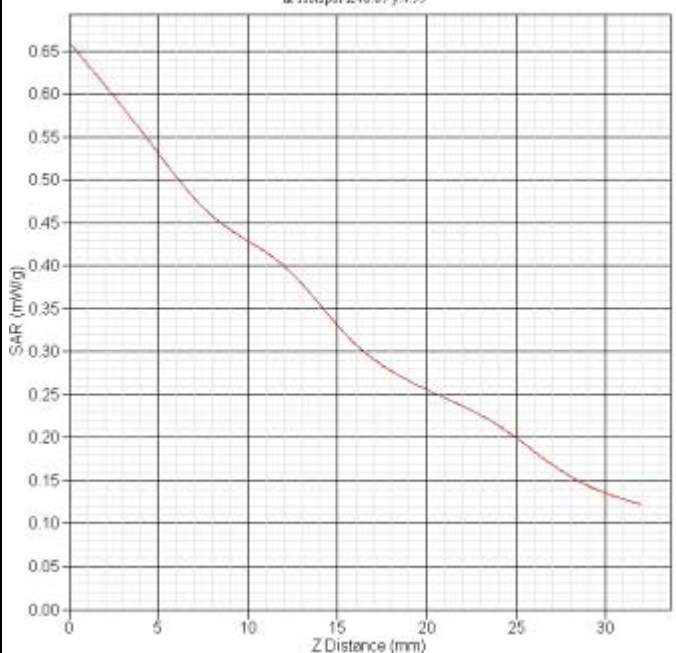
<b>GSM850 Left cheek ch128</b>	
Frequency(MHz)	824.2
Relative permittivity(real part)	40.38
Conductivity(S/m)	0.92
Variation(%)	-1.238
Duty Cycle Factor	8
Crest factor	8
Conversion Fator	6.5
Probe Sensitivity	1.20 1.20 1.20 $\mu$ V/(V/m) <sup>2</sup>
Data	2012-03-13
	<p>SAR-Z Axis at Hotspot x:40.07 y:4.99</p> 
SAR 1g(W/Kg)	0.551
SAR 10g(W/Kg)	0.358

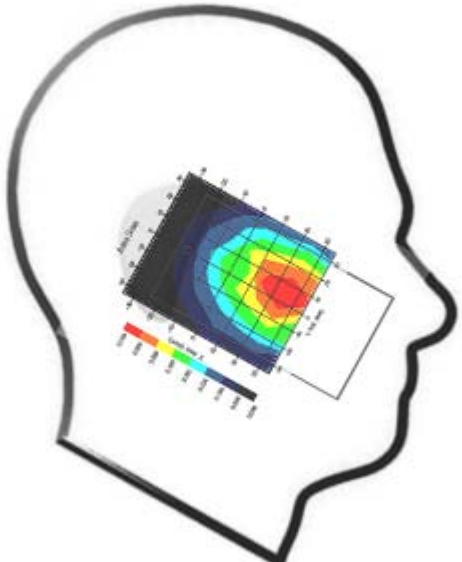
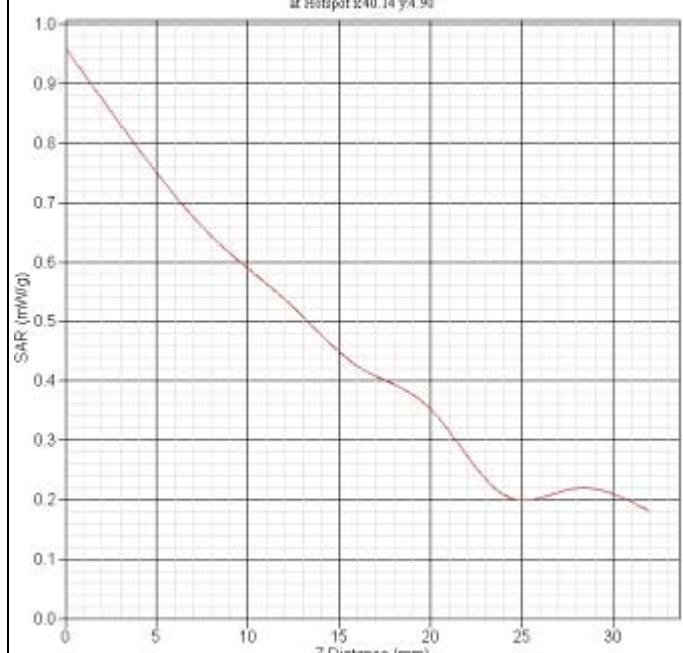
<b>GSM850 Left cheek ch128</b>	
Frequency(MHz)	848.8
Relative permittivity(real part)	40.38
Conductivity(S/m)	0.92
Variation(%)	-4.726
Duty Cycle Factor	8
Crest factor	8
Conversion Fator	6.5
Probe Sensitivity	1.20 1.20 1.20 $\mu$ V/(V/m) <sup>2</sup>
Data	2012-03-13
	
SAR 1g(W/Kg)	0.598
SAR 10g(W/Kg)	0.490

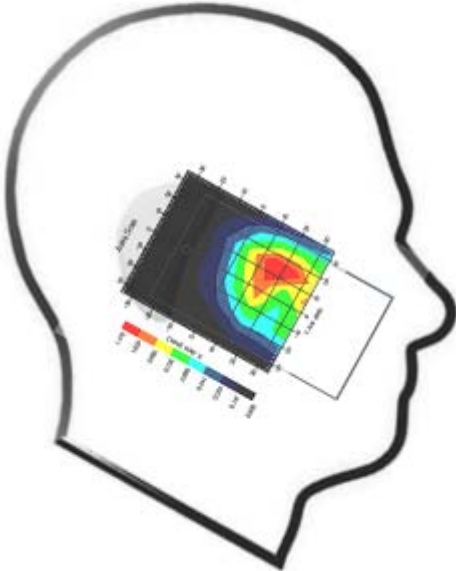
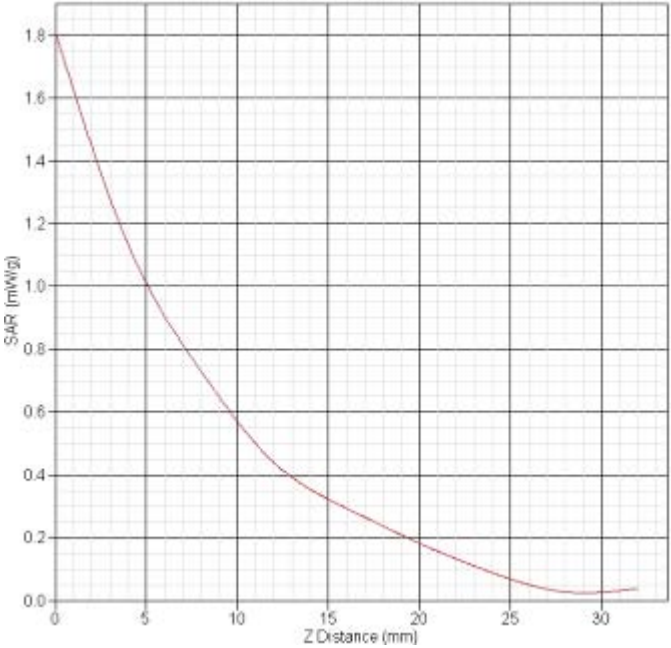
<b>GSM1900 Left cheek CH661</b>																	
Frequency(MHz)	1880.0																
Relative permittivity(real part)	40.09																
Conductivity(S/m)	1.42																
Variation(%)	-0.660																
Duty Cycle Factor	8																
Crest factor	8																
Conversion Fator	5.7																
Probe Sensitivity	1.20 1.20 1.20 $\mu$ V/(V/m) <sup>2</sup>																
Data	2012-03-13																
	<p>SAR-Z Axis at Hotspot at: 18.07 y 14.99</p>  <table border="1"> <caption>SAR-Z Axis Data</caption> <thead> <tr> <th>Z Distance (mm)</th> <th>SAR (mW/kg)</th> </tr> </thead> <tbody> <tr><td>0</td><td>1.8</td></tr> <tr><td>5</td><td>1.0</td></tr> <tr><td>10</td><td>0.55</td></tr> <tr><td>15</td><td>0.3</td></tr> <tr><td>20</td><td>0.18</td></tr> <tr><td>25</td><td>0.1</td></tr> <tr><td>30</td><td>0.05</td></tr> </tbody> </table>	Z Distance (mm)	SAR (mW/kg)	0	1.8	5	1.0	10	0.55	15	0.3	20	0.18	25	0.1	30	0.05
Z Distance (mm)	SAR (mW/kg)																
0	1.8																
5	1.0																
10	0.55																
15	0.3																
20	0.18																
25	0.1																
30	0.05																
SAR 1g(W/Kg)	1.018																
SAR 10g(W/Kg)	0.546																

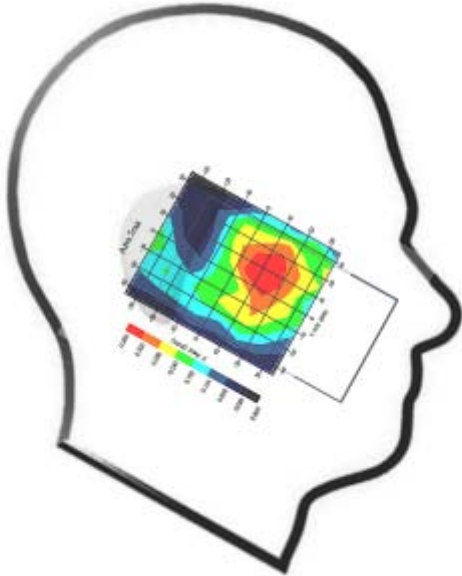
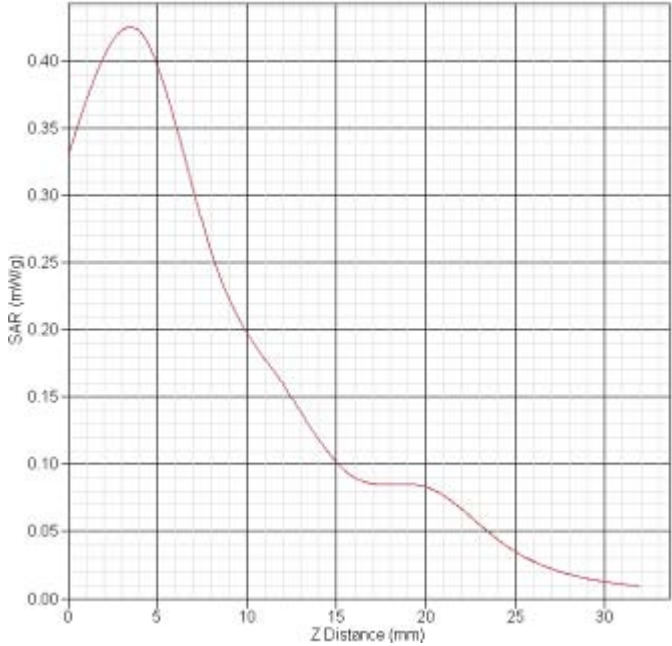
<b>GSM1900 Left tilt CH661</b>																					
Frequency(MHz)	1880.0																				
Relative permittivity(real part)	40.09																				
Conductivity(S/m)	1.42																				
Variation(%)	4.980																				
Duty Cycle Factor	8																				
Crest factor	8																				
Conversion Fator	5.7																				
Probe Sensitivity	1.20 1.20 1.20 $\mu$ V/(V/m) <sup>2</sup>																				
Data	2012-03-13																				
	<p>SAR-Z Axis at Hotspot x:22.08 y:12.98</p>  <table border="1"> <caption>SAR-Z Axis Data Points (Estimated)</caption> <thead> <tr> <th>Z Distance (mm)</th> <th>SAR (mW/kg)</th> </tr> </thead> <tbody> <tr><td>0</td><td>0.33</td></tr> <tr><td>2</td><td>0.40</td></tr> <tr><td>4</td><td>0.42</td></tr> <tr><td>6</td><td>0.38</td></tr> <tr><td>10</td><td>0.20</td></tr> <tr><td>15</td><td>0.10</td></tr> <tr><td>20</td><td>0.08</td></tr> <tr><td>25</td><td>0.04</td></tr> <tr><td>30</td><td>0.01</td></tr> </tbody> </table>	Z Distance (mm)	SAR (mW/kg)	0	0.33	2	0.40	4	0.42	6	0.38	10	0.20	15	0.10	20	0.08	25	0.04	30	0.01
Z Distance (mm)	SAR (mW/kg)																				
0	0.33																				
2	0.40																				
4	0.42																				
6	0.38																				
10	0.20																				
15	0.10																				
20	0.08																				
25	0.04																				
30	0.01																				
SAR 1g(W/Kg)	0.358																				
SAR 10g(W/Kg)	0.207																				

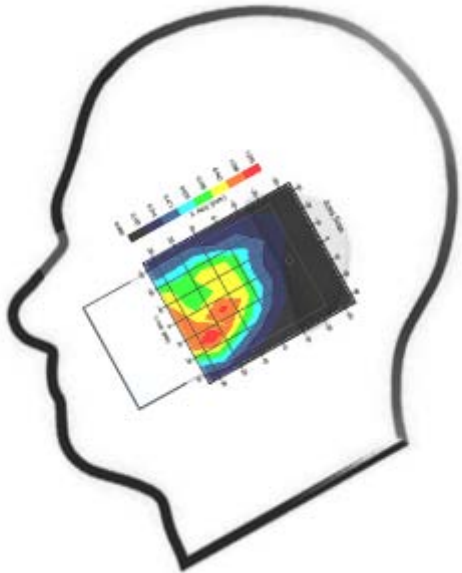
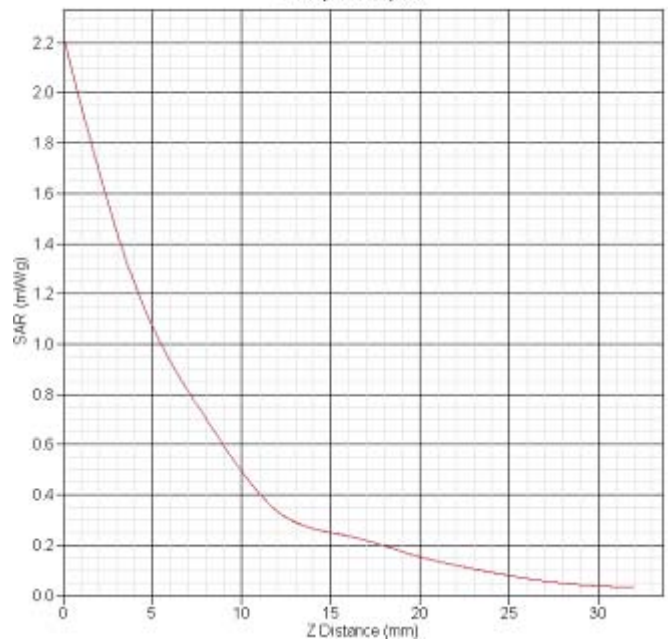
<b>GSM1900 Right cheek CH661</b>	
Frequency(MHz)	1880.0
Relative permittivity(real part)	40.09
Conductivity(S/m)	1.42
Variation(%)	1.152
Duty Cycle Factor	8
Crest factor	8
Conversion Fator	5.7
Probe Sensitivity	1.20 1.20 1.20 $\mu$ V/(V/m) <sup>2</sup>
Data	2012-03-13
	<p>SAR-Z Axis at Hotspot x:30.06 y:4.99</p> 
SAR 1g(W/Kg)	1.056
SAR 10g(W/Kg)	0.553

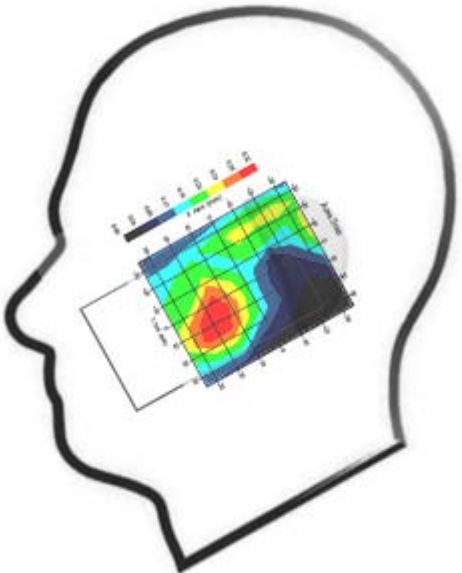
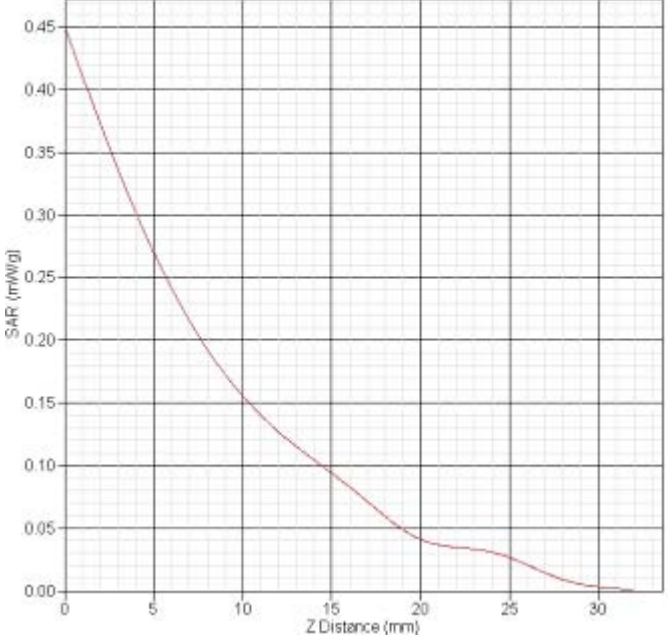

<b>GSM1900 Right tilt CH661</b>																	
Frequency(MHz)	1880.0																
Relative permittivity(real part)	40.09																
Conductivity(S/m)	1.42																
Variation(%)	-2.629																
Duty Cycle Factor	8																
Crest factor	8																
Conversion Fator	5.7																
Probe Sensitivity	1.20 1.20 1.20 $\mu$ V/(V/m) <sup>2</sup>																
Data	2012-03-13																
	<p><b>SAR-Z Axis</b> at Hotspot x:32.06 y:15.01</p>  <table border="1"> <caption>SAR-Z Axis Data Points (Approximate)</caption> <thead> <tr> <th>Z Distance (mm)</th> <th>SAR (mW/kg)</th> </tr> </thead> <tbody> <tr><td>0</td><td>0.45</td></tr> <tr><td>5</td><td>0.28</td></tr> <tr><td>10</td><td>0.16</td></tr> <tr><td>15</td><td>0.10</td></tr> <tr><td>20</td><td>0.05</td></tr> <tr><td>25</td><td>0.03</td></tr> <tr><td>30</td><td>0.01</td></tr> </tbody> </table>	Z Distance (mm)	SAR (mW/kg)	0	0.45	5	0.28	10	0.16	15	0.10	20	0.05	25	0.03	30	0.01
Z Distance (mm)	SAR (mW/kg)																
0	0.45																
5	0.28																
10	0.16																
15	0.10																
20	0.05																
25	0.03																
30	0.01																
SAR 1g(W/Kg)	0.266																
SAR 10g(W/Kg)	0.142																

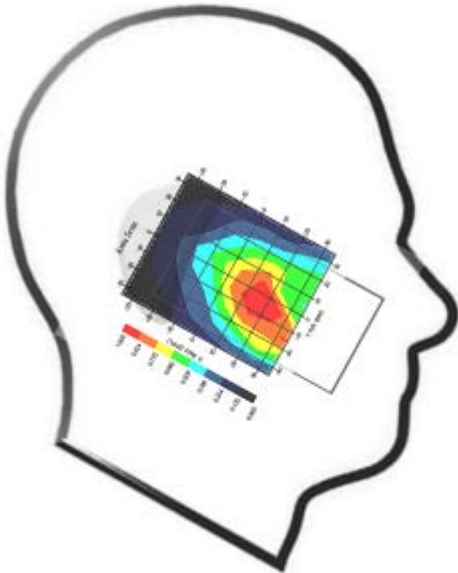
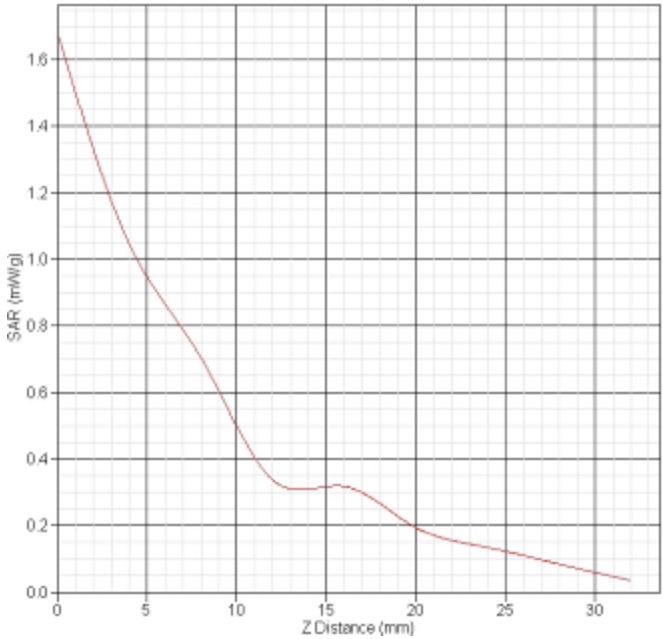

<b>GSM1900 Left cheek CH512</b>																	
Frequency(MHz)	1850.2																
Relative permittivity(real part)	40.09																
Conductivity(S/m)	1.42																
Variation(%)	-1.920																
Duty Cycle Factor	8																
Crest factor	8																
Conversion Fator	5.7																
Probe Sensitivity	1.20 1.20 1.20 $\mu$ V/(V/m) <sup>2</sup>																
Data	2012-03-29																
	<p><b>SAR-Z Axis</b> at Hotspot at 38.11 y-13.07</p>  <table border="1"> <caption>Approximate data points from SAR-Z Axis graph</caption> <thead> <tr> <th>Z Distance (mm)</th> <th>SAR (mW/kg)</th> </tr> </thead> <tbody> <tr><td>0</td><td>1.6</td></tr> <tr><td>5</td><td>1.0</td></tr> <tr><td>10</td><td>0.5</td></tr> <tr><td>15</td><td>0.3</td></tr> <tr><td>20</td><td>0.2</td></tr> <tr><td>25</td><td>0.1</td></tr> <tr><td>30</td><td>0.05</td></tr> </tbody> </table>	Z Distance (mm)	SAR (mW/kg)	0	1.6	5	1.0	10	0.5	15	0.3	20	0.2	25	0.1	30	0.05
Z Distance (mm)	SAR (mW/kg)																
0	1.6																
5	1.0																
10	0.5																
15	0.3																
20	0.2																
25	0.1																
30	0.05																
SAR 1g(W/Kg)	0.997																
SAR 10g(W/Kg)	0.546																

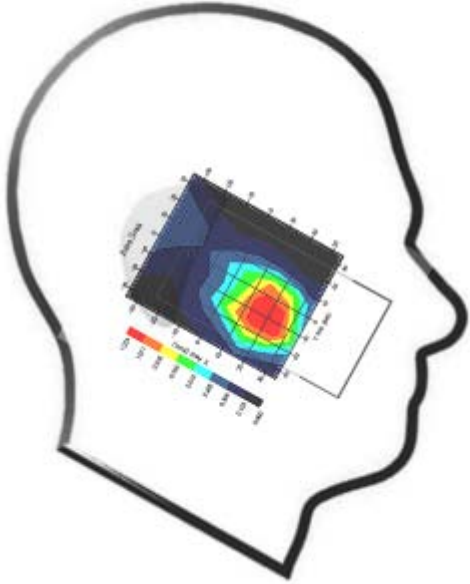
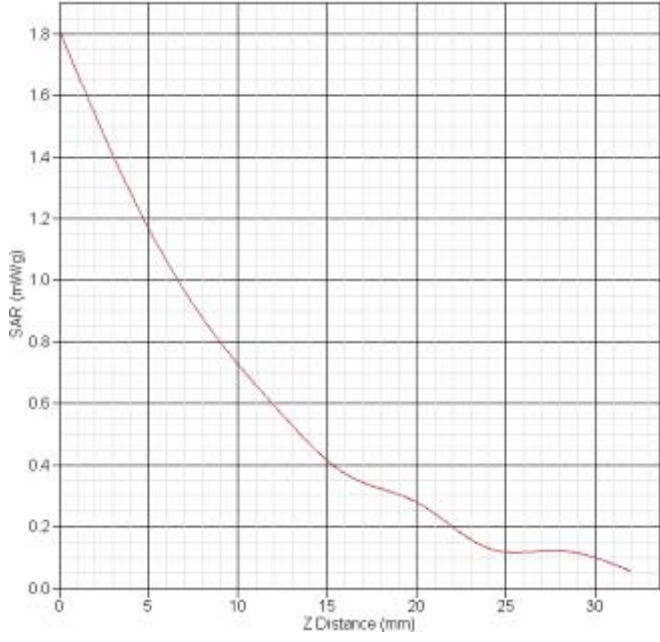
<b>GSM1900 Left cheek CH810</b>																	
Frequency(MHz)	1909.8																
Relative permittivity(real part)	40.09																
Conductivity(S/m)	1.42																
Variation(%)	2.712																
Duty Cycle Factor	8																
Crest factor	8																
Conversion Fator	5.7																
Probe Sensitivity	1.20 1.20 1.20 $\mu$ V/(V/m) <sup>2</sup>																
Data	2012-03-29																
	<p><b>SAR-Z Axis</b> at Hotspot x:32.14 y:-7.11</p>  <table border="1"> <caption>SAR-Z Axis Data</caption> <thead> <tr> <th>Z Distance (mm)</th> <th>SAR (mW/kg)</th> </tr> </thead> <tbody> <tr><td>0</td><td>1.8</td></tr> <tr><td>5</td><td>1.2</td></tr> <tr><td>10</td><td>0.8</td></tr> <tr><td>15</td><td>0.4</td></tr> <tr><td>20</td><td>0.3</td></tr> <tr><td>25</td><td>0.15</td></tr> <tr><td>30</td><td>0.1</td></tr> </tbody> </table>	Z Distance (mm)	SAR (mW/kg)	0	1.8	5	1.2	10	0.8	15	0.4	20	0.3	25	0.15	30	0.1
Z Distance (mm)	SAR (mW/kg)																
0	1.8																
5	1.2																
10	0.8																
15	0.4																
20	0.3																
25	0.15																
30	0.1																
SAR 1g(W/Kg)	1.004																
SAR 10g(W/Kg)	0.560																

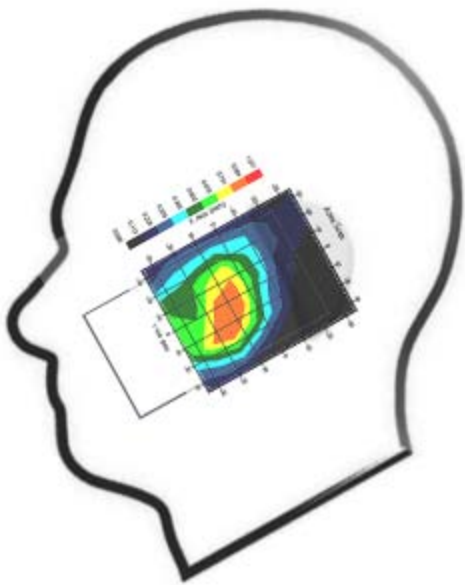
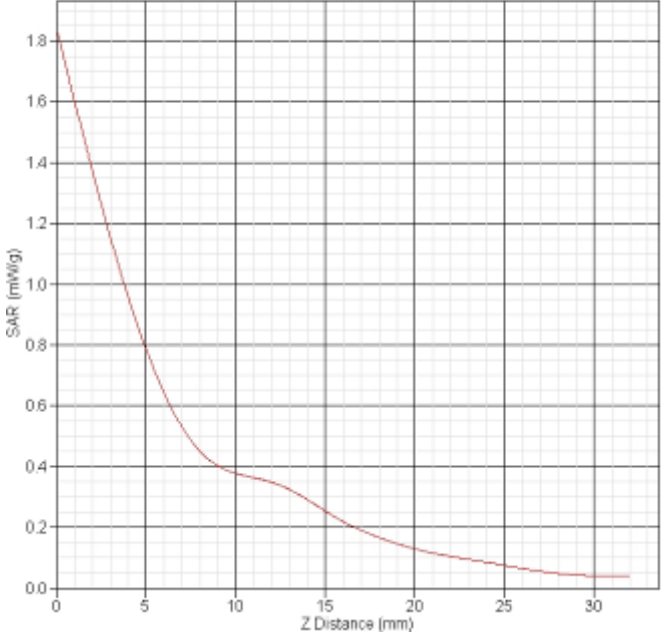
<b>GSM1900 Right cheek CH512</b>																	
Frequency(MHz)	1850.2																
Relative permittivity(real part)	40.09																
Conductivity(S/m)	1.42																
Variation(%)	-2.751																
Duty Cycle Factor	8																
Crest factor	8																
Conversion Fator	5.7																
Probe Sensitivity	1.20 1.20 1.20 $\mu$ V/(V/m) <sup>2</sup>																
Data	2012-03-13																
	<p>SAR-Z Axis at Hotspot x:28.06 y:3.01</p>  <table border="1"> <caption>Approximate data points from SAR-Z Axis graph</caption> <thead> <tr> <th>Z Distance (mm)</th> <th>SAR (mW/kg)</th> </tr> </thead> <tbody> <tr><td>0</td><td>1.8</td></tr> <tr><td>5</td><td>0.8</td></tr> <tr><td>10</td><td>0.4</td></tr> <tr><td>15</td><td>0.25</td></tr> <tr><td>20</td><td>0.15</td></tr> <tr><td>25</td><td>0.1</td></tr> <tr><td>30</td><td>0.08</td></tr> </tbody> </table>	Z Distance (mm)	SAR (mW/kg)	0	1.8	5	0.8	10	0.4	15	0.25	20	0.15	25	0.1	30	0.08
Z Distance (mm)	SAR (mW/kg)																
0	1.8																
5	0.8																
10	0.4																
15	0.25																
20	0.15																
25	0.1																
30	0.08																
SAR 1g(W/Kg)	0.891																
SAR 10g(W/Kg)	0.439																

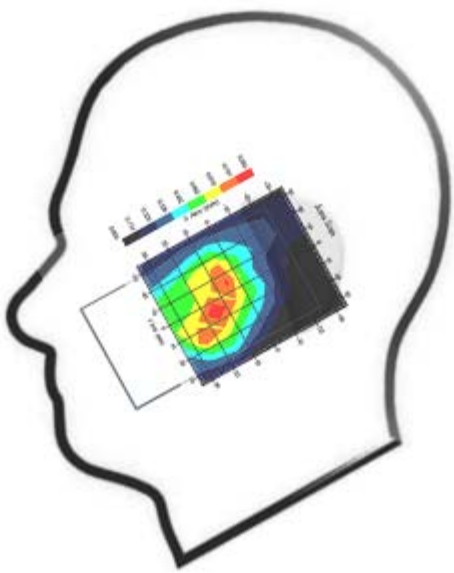
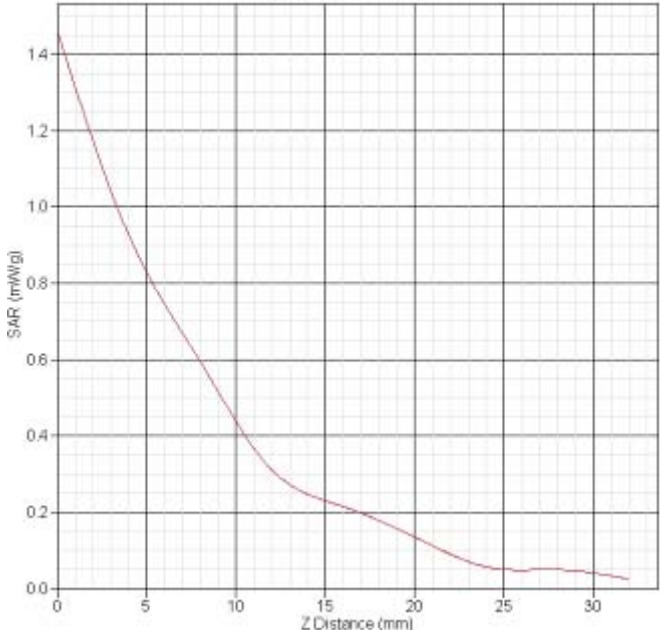
<b>GSM1900 Right cheek CH810</b>																	
Frequency(MHz)	1909.8																
Relative permittivity(real part)	40.09																
Conductivity(S/m)	1.42																
Variation(%)	1.631																
Duty Cycle Factor	8																
Crest factor	8																
Conversion Fator	5.7																
Probe Sensitivity	1.20 1.20 1.20 $\mu$ V/(V/m) <sup>2</sup>																
Data	2012-03-13																
	<p>SAR-Z Axis at Hstop: x:24.03 y:-0.96</p>  <table border="1"> <caption>Approximate data points from the SAR-Z Axis graph</caption> <thead> <tr> <th>Z Distance (mm)</th> <th>SAR (mW/kg)</th> </tr> </thead> <tbody> <tr><td>0</td><td>1.4</td></tr> <tr><td>5</td><td>0.8</td></tr> <tr><td>10</td><td>0.4</td></tr> <tr><td>15</td><td>0.25</td></tr> <tr><td>20</td><td>0.15</td></tr> <tr><td>25</td><td>0.1</td></tr> <tr><td>30</td><td>0.08</td></tr> </tbody> </table>	Z Distance (mm)	SAR (mW/kg)	0	1.4	5	0.8	10	0.4	15	0.25	20	0.15	25	0.1	30	0.08
Z Distance (mm)	SAR (mW/kg)																
0	1.4																
5	0.8																
10	0.4																
15	0.25																
20	0.15																
25	0.1																
30	0.08																
SAR 1g(W/Kg)	0.958																
SAR 10g(W/Kg)	0.534																

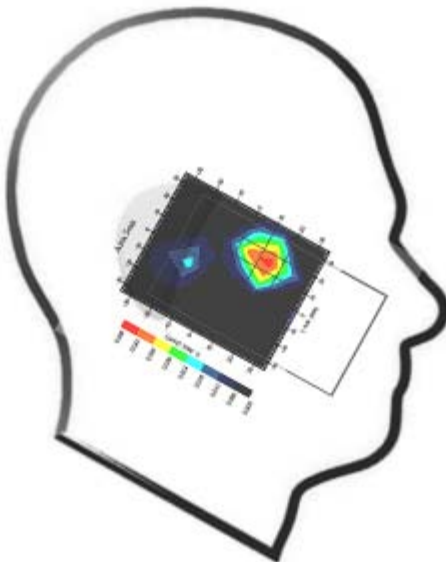
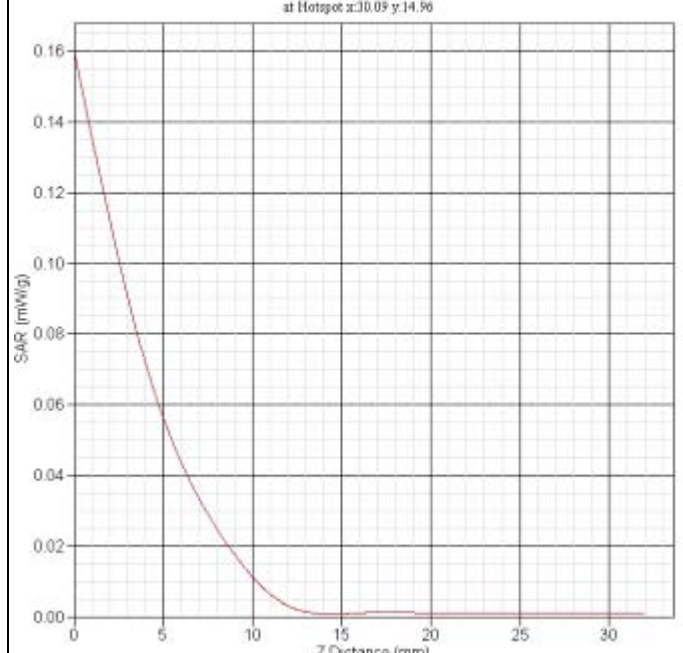
<b>802.11b Left cheek CH6</b>																	
Frequency(MHz)	2437																
Relative permittivity(real part)	40.01																
Conductivity(S/m)	1.83																
Variation(%)	-1.239																
Duty Cycle Factor	1																
Crest factor	1																
Conversion Fator	4.65																
Probe Sensitivity	1.20 1.20 1.20 $\mu V/(V/m)^2$																
Data	2012-03-13																
	<p>SAR-Z Axis at Hotspot x:30.09 y:14.96</p>  <table border="1"> <caption>SAR-Z Axis Data</caption> <thead> <tr> <th>Z Distance (mm)</th> <th>SAR (mW/kg)</th> </tr> </thead> <tbody> <tr><td>0</td><td>0.16</td></tr> <tr><td>5</td><td>0.06</td></tr> <tr><td>10</td><td>0.01</td></tr> <tr><td>15</td><td>0.00</td></tr> <tr><td>20</td><td>0.00</td></tr> <tr><td>25</td><td>0.00</td></tr> <tr><td>30</td><td>0.00</td></tr> </tbody> </table>	Z Distance (mm)	SAR (mW/kg)	0	0.16	5	0.06	10	0.01	15	0.00	20	0.00	25	0.00	30	0.00
Z Distance (mm)	SAR (mW/kg)																
0	0.16																
5	0.06																
10	0.01																
15	0.00																
20	0.00																
25	0.00																
30	0.00																
SAR 1g(W/Kg)	0.060																
SAR 10g(W/Kg)	0.020																

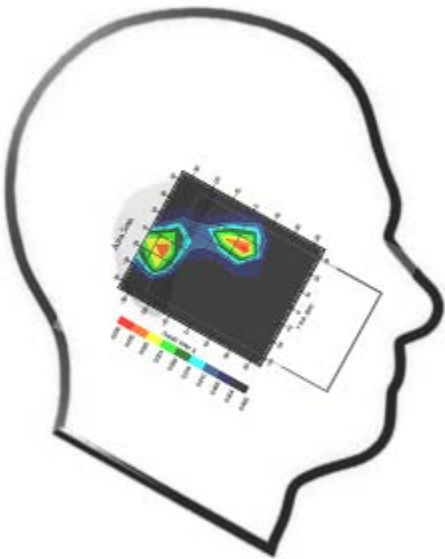
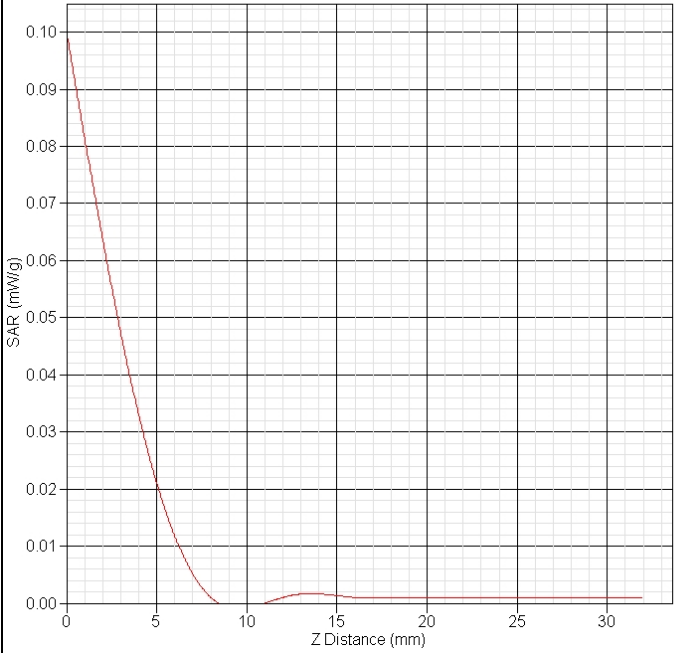
<b>802.11b Left tilt CH6</b>	
Frequency(MHz)	2437
Relative permittivity(real part)	40.01
Conductivity(S/m)	1.83
Variation(%)	3.245
Duty Cycle Factor	1
Crest factor	1
Conversion Fator	4.65
Probe Sensitivity	1.20 1.20 1.20 $\mu$ V/(V/m) <sup>2</sup>
Data	2012-03-13
	<p>SAR-Z Axis at Hotspot x:12.11 y:14.96</p> 
SAR 1g(W/Kg)	0.026
SAR 10g(W/Kg)	0.009

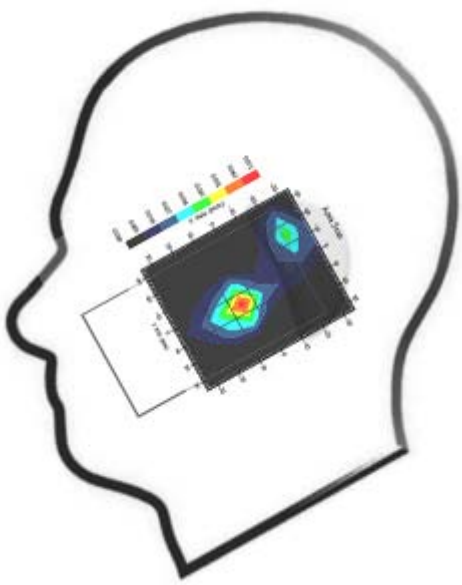
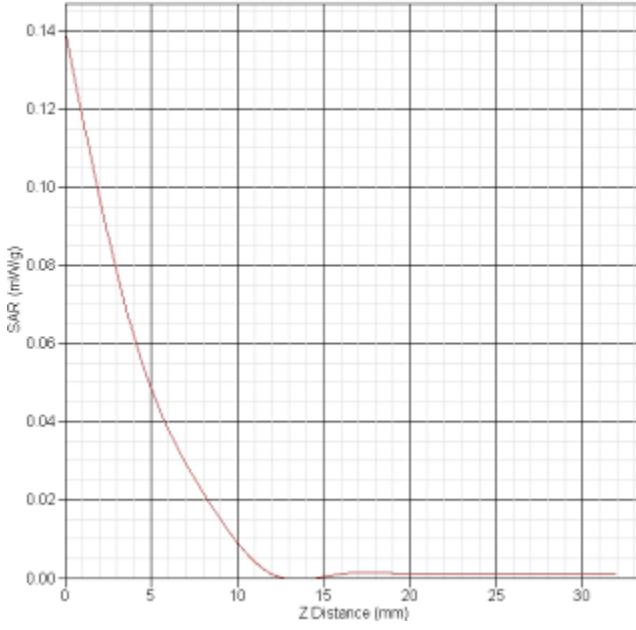
<b>802.11b Right cheek CH6</b>	
Frequency(MHz)	2437
Relative permittivity(real part)	40.01
Conductivity(S/m)	1.83
Variation(%)	-4.136
Duty Cycle Factor	1
Crest factor	1
Conversion Fator	4.65
Probe Sensitivity	1.20 1.20 1.20 $\mu$ V/(V/m) <sup>2</sup>
Data	2012-03-13
	<p>SAR-Z Axis at Hotspot x:20.11 y:5.06</p> 
SAR 1g(W/Kg)	0.055
SAR 10g(W/Kg)	0.020

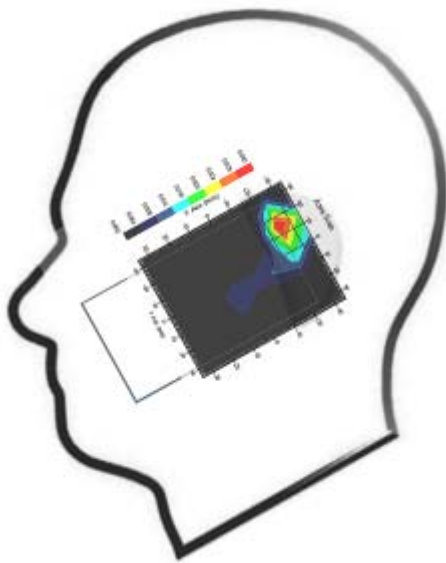
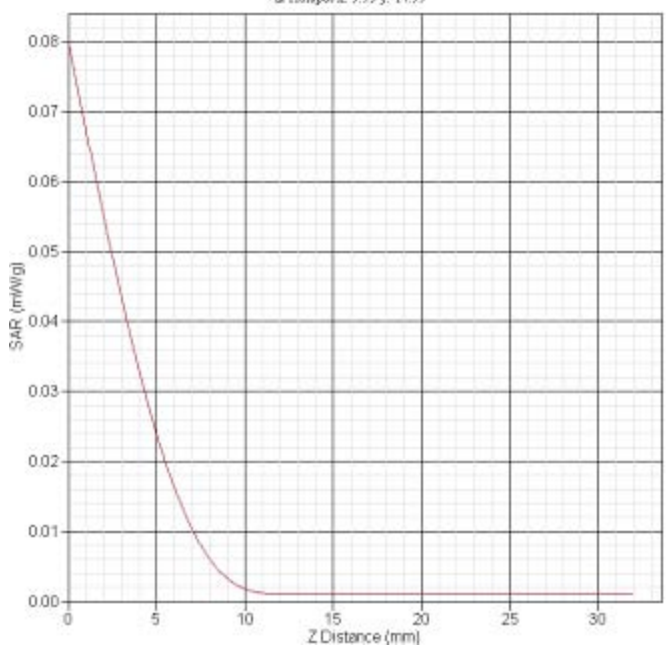
<b>802.11b Right tilt CH6</b>	
Frequency(MHz)	2437
Relative permittivity(real part)	40.01
Conductivity(S/m)	1.83
Variation(%)	-2.523
Duty Cycle Factor	1
Crest factor	1
Conversion Fator	4.65
Probe Sensitivity	1.20 1.20 1.20 $\mu$ V/(V/m) <sup>2</sup>
Data	2012-03-13
	<p>SAR-Z Axis at Hotspot x:-9.95 y:-14.99</p> 
SAR 1g(W/Kg)	0.029
SAR 10g(W/Kg)	0.010

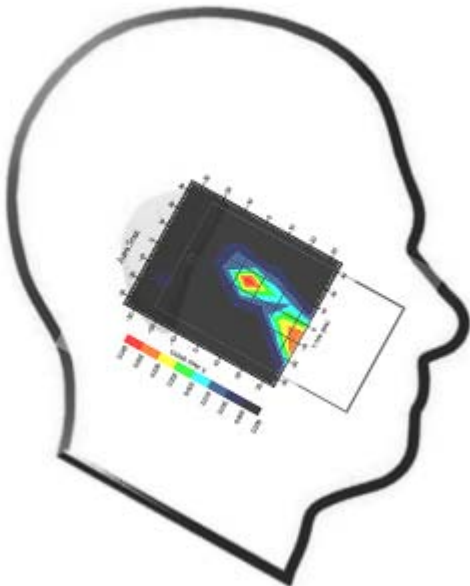
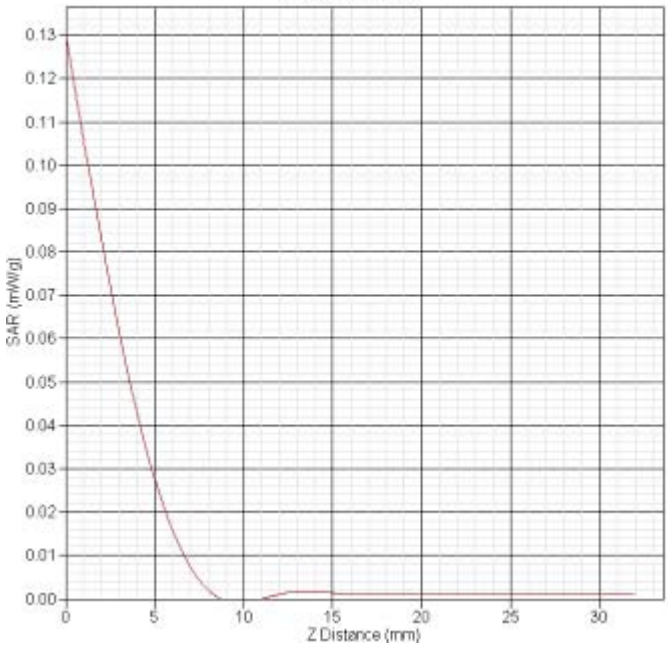

<b>802.11g Left cheek CH6</b>	
Frequency(MHz)	2437
Relative permittivity(real part)	40.01
Conductivity(S/m)	1.83
Variation(%)	-0.769
Duty Cycle Factor	1
Crest factor	1
Conversion Fator	4.65
Probe Sensitivity	1.20 1.20 1.20 $\mu$ V/(V/m) <sup>2</sup>
Data	2012-03-13
	<p>SAR-Z Axis at Hotspot x:20.18 y:4.86</p> 
SAR 1g(W/Kg)	0.034
SAR 10g(W/Kg)	0.010

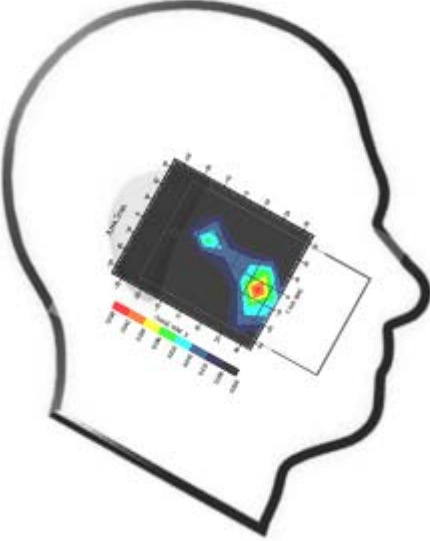
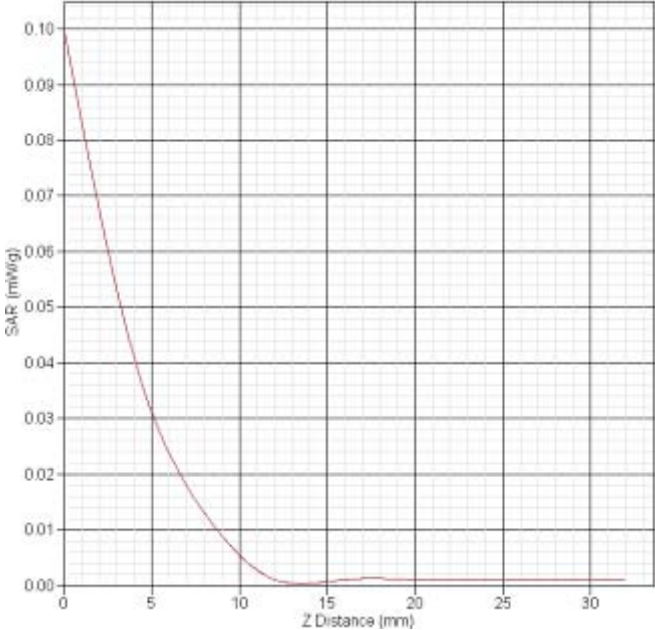
<b>802.11g Left tilt CH6</b>	
Frequency(MHz)	2437
Relative permittivity(real part)	40.01
Conductivity(S/m)	1.83
Variation(%)	3.759
Duty Cycle Factor	1
Crest factor	1
Conversion Fator	4.65
Probe Sensitivity	1.20 1.20 1.20 $\mu$ V/(V/m) <sup>2</sup>
Data	2012-03-13
	<p>SAR-Z AXIS at Hotspot x:40.13 y:-5.09</p> 
SAR 1g(W/Kg)	0.035
SAR 10g(W/Kg)	0.013

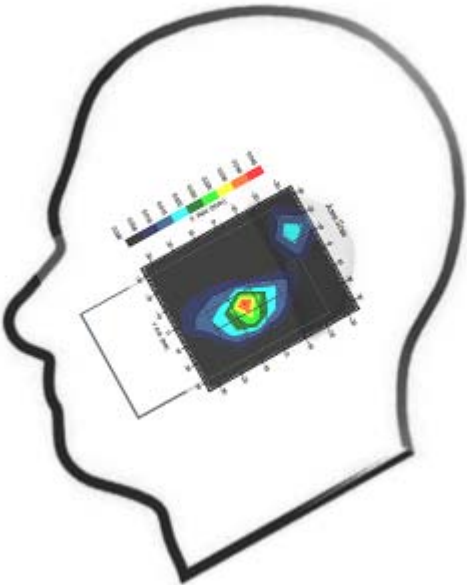
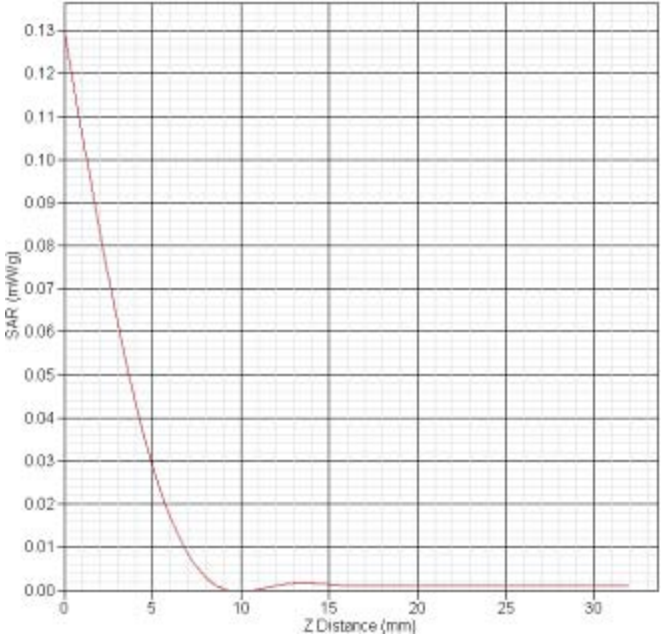
<b>802.11g Right cheek CH6</b>	
Frequency(MHz)	2437
Relative permittivity(real part)	40.01
Conductivity(S/m)	1.83
Variation(%)	-0.996
Duty Cycle Factor	1
Crest factor	1
Conversion Fator	4.65
Probe Sensitivity	1.20 1.20 1.20 $\mu$ V/(V/m) <sup>2</sup>
Data	2012-03-13
	<p>SAR-Z Axis at Hotspot x:20.04 y:4.98</p> 
SAR 1g(W/Kg)	0.036
SAR 10g(W/Kg)	0.012

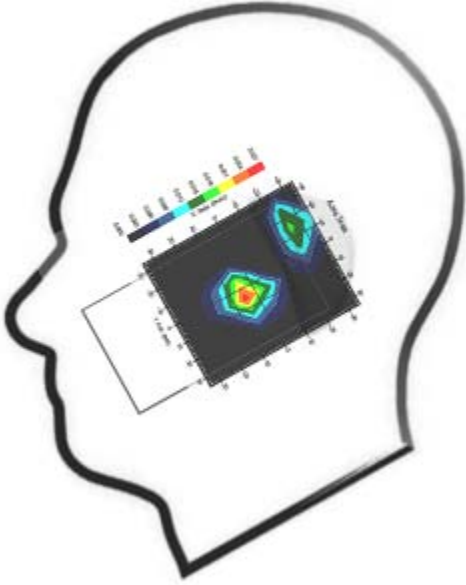
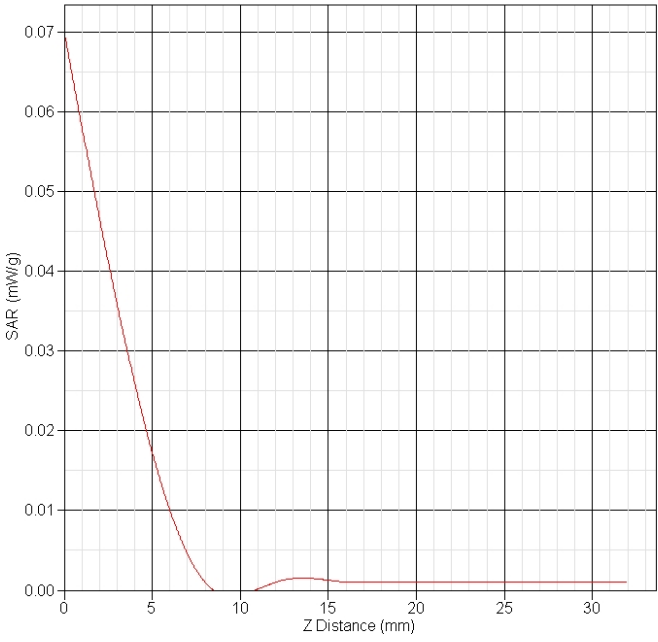
<b>802.11g Right tilt CH6</b>	
Frequency(MHz)	2437
Relative permittivity(real part)	40.01
Conductivity(S/m)	1.83
Variation(%)	-3.755
Duty Cycle Factor	1
Crest factor	1
Conversion Fator	4.65
Probe Sensitivity	1.20 1.20 1.20 $\mu V/(V/m)^2$
Data	2012-03-13
	<p>SAR-Z Axis at Hotspot x:20.11 y:5.09</p> 
SAR 1g(W/Kg)	0.020
SAR 10g(W/Kg)	0.006

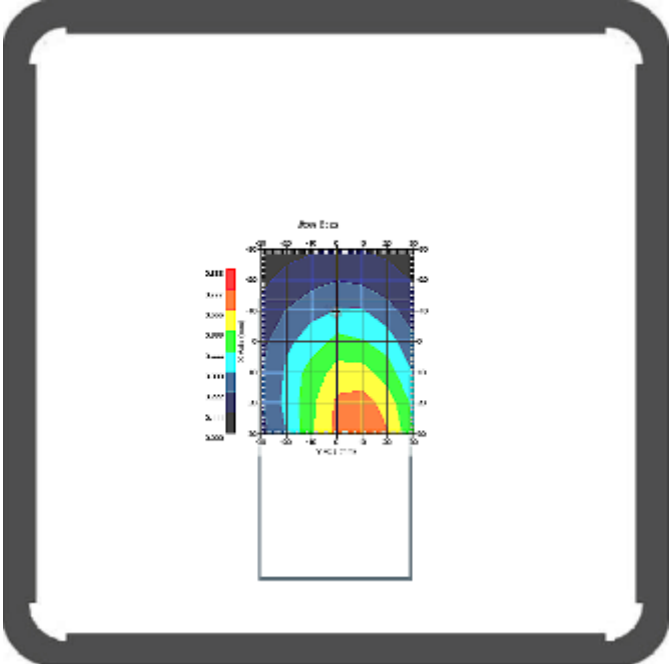
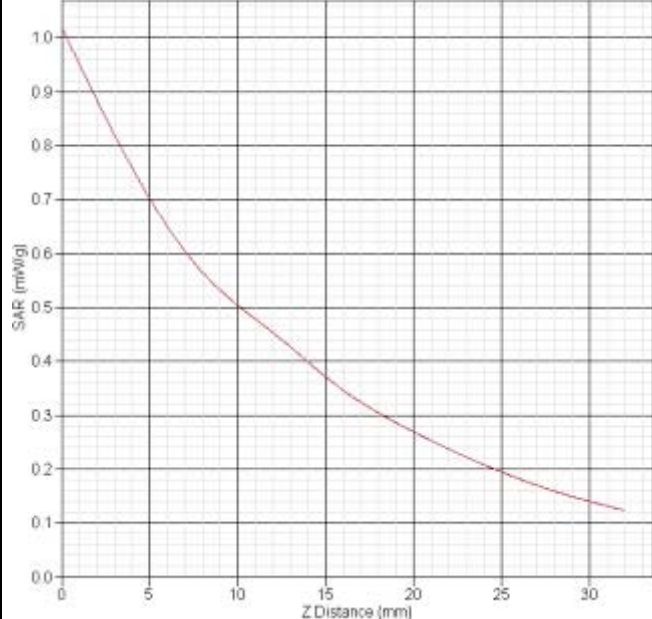
<b>GPRS850 +Earphone body face CH190</b>																	
Frequency(MHz)	826.6																
Relative permittivity(real part)	54.08																
Conductivity(S/m)	0.95																
Variation(%)	0.587																
Duty Cycle Factor	4																
Crest factor	4																
Conversion Fator	6.4																
Probe Sensitivity	1.20 1.20 1.20 $\mu$ V/(V/m) <sup>2</sup>																
Data	2012-03-14																
	<p>SAR-Z AXIS at Hotspot x:31.02 y:9.39</p>  <table border="1"> <caption>SAR-Z AXIS Data</caption> <thead> <tr> <th>Z Distance (mm)</th> <th>SAR (mW/kg)</th> </tr> </thead> <tbody> <tr><td>0</td><td>1.0</td></tr> <tr><td>5</td><td>0.7</td></tr> <tr><td>10</td><td>0.5</td></tr> <tr><td>15</td><td>0.38</td></tr> <tr><td>20</td><td>0.28</td></tr> <tr><td>25</td><td>0.2</td></tr> <tr><td>30</td><td>0.12</td></tr> </tbody> </table>	Z Distance (mm)	SAR (mW/kg)	0	1.0	5	0.7	10	0.5	15	0.38	20	0.28	25	0.2	30	0.12
Z Distance (mm)	SAR (mW/kg)																
0	1.0																
5	0.7																
10	0.5																
15	0.38																
20	0.28																
25	0.2																
30	0.12																
SAR 1g(W/Kg)	0.699																
SAR 10g(W/Kg)	0.449																

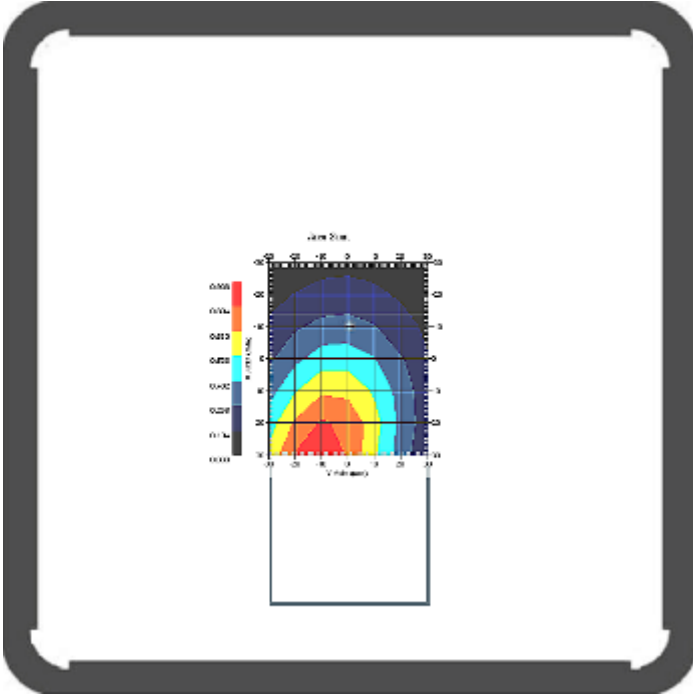
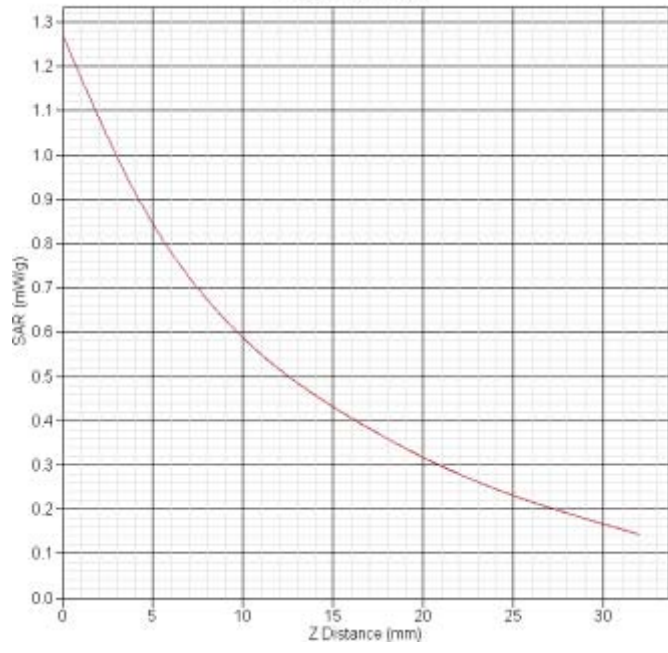
<b>GPRS850 +Earphone body bottom CH190</b>																	
Frequency(MHz)	826.6																
Relative permittivity(real part)	54.08																
Conductivity(S/m)	0.95																
Variation(%)	-0.986																
Duty Cycle Factor	4																
Crest factor	4																
Conversion Fator	6.4																
Probe Sensitivity	1.20 1.20 1.20 $\mu$ V/(V/m) <sup>2</sup>																
Data	2012-03-14																
	<p><b>SAR-Z Axis</b> at Hotspot x:30.83 y:-6.11</p>  <table border="1"> <caption>SAR-Z Axis Data</caption> <thead> <tr> <th>Z Distance (mm)</th> <th>SAR (mW/kg)</th> </tr> </thead> <tbody> <tr><td>0</td><td>1.25</td></tr> <tr><td>5</td><td>0.85</td></tr> <tr><td>10</td><td>0.60</td></tr> <tr><td>15</td><td>0.45</td></tr> <tr><td>20</td><td>0.35</td></tr> <tr><td>25</td><td>0.25</td></tr> <tr><td>30</td><td>0.15</td></tr> </tbody> </table>	Z Distance (mm)	SAR (mW/kg)	0	1.25	5	0.85	10	0.60	15	0.45	20	0.35	25	0.25	30	0.15
Z Distance (mm)	SAR (mW/kg)																
0	1.25																
5	0.85																
10	0.60																
15	0.45																
20	0.35																
25	0.25																
30	0.15																
SAR 1g(W/Kg)	0.885																
SAR 10g(W/Kg)	0.602																

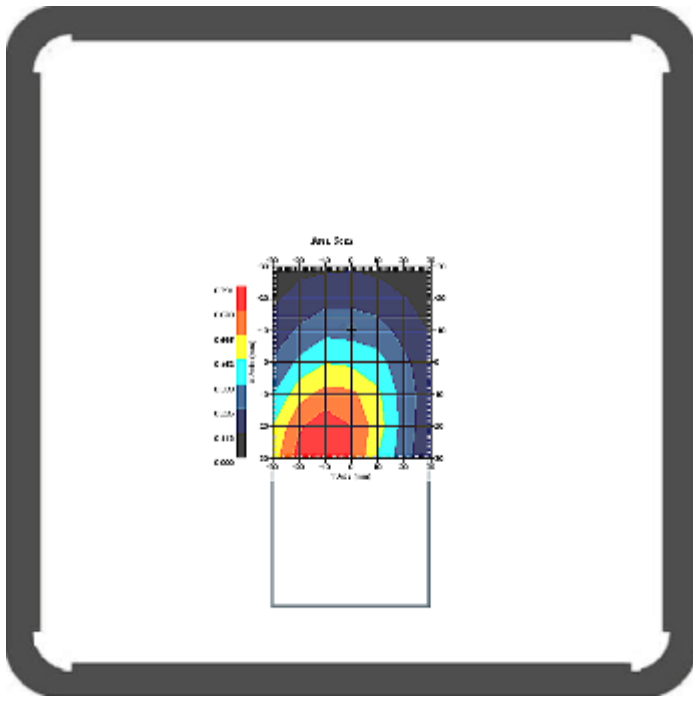
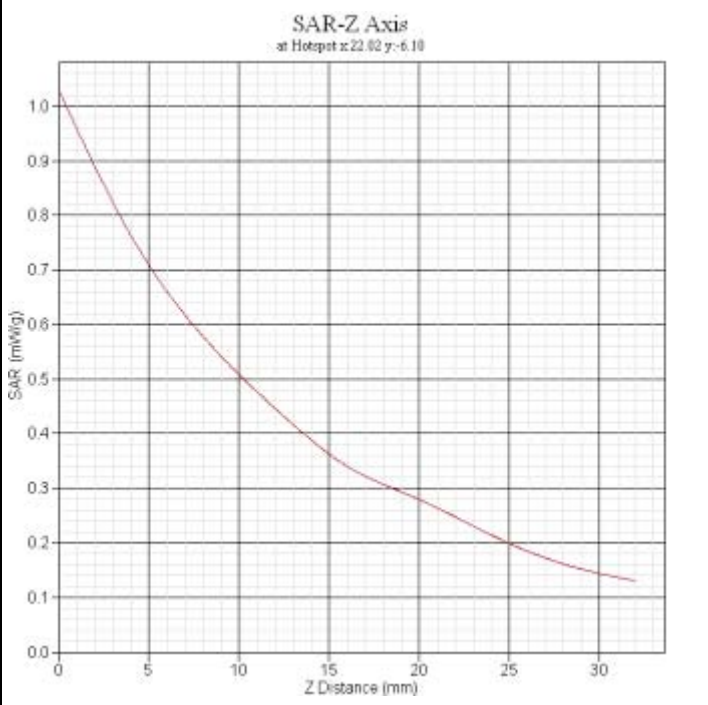
<b>GPRS850 +Earphone body bottom CH128</b>	
Frequency(MHz)	824.2
Relative permittivity(real part)	54.08
Conductivity(S/m)	0.95
Variation(%)	2.805
Duty Cycle Factor	4
Crest factor	4
Conversion Fator	6.4
Probe Sensitivity	1.20 1.20 1.20 $\mu$ V/(V/m) <sup>2</sup>
Data	2012-03-14
	
SAR 1g(W/Kg)	0.736
SAR 10g(W/Kg)	0.502

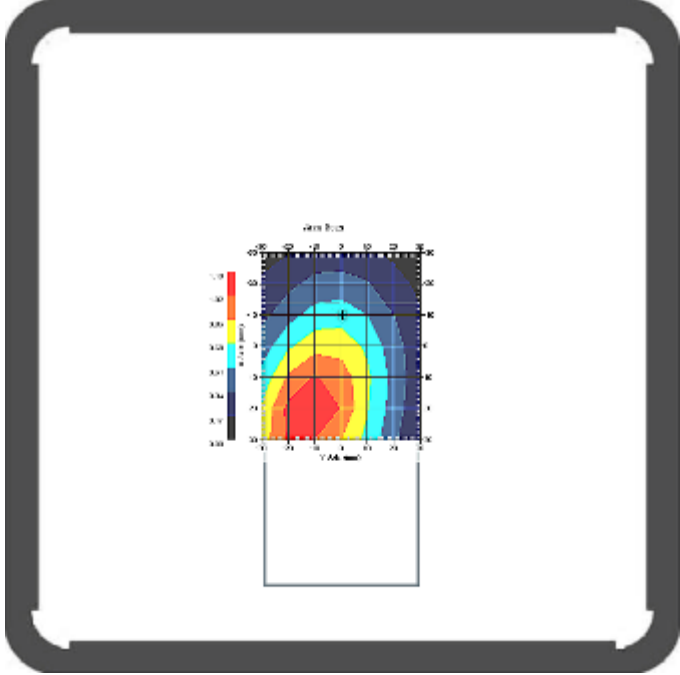
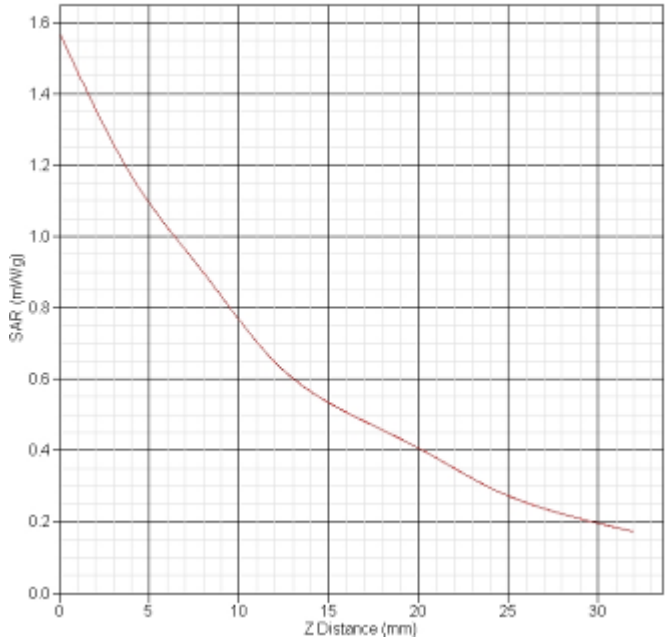
<b>GPRS850+Earphone body bottom CH251</b>	
Frequency(MHz)	848.8
Relative permittivity(real part)	54.08
Conductivity(S/m)	0.95
Variation(%)	-0.530
Duty Cycle Factor	4
Crest factor	4
Conversion Fator	6.4
Probe Sensitivity	1.20 1.20 1.20 $\mu V/(V/m)^2$
Data	2012-03-14
	<p><b>SAR-Z Axis</b> at Hotspot x:20.05 y:-10.14</p> 
SAR 1g(W/Kg)	1.051
SAR 10g(W/Kg)	0.666

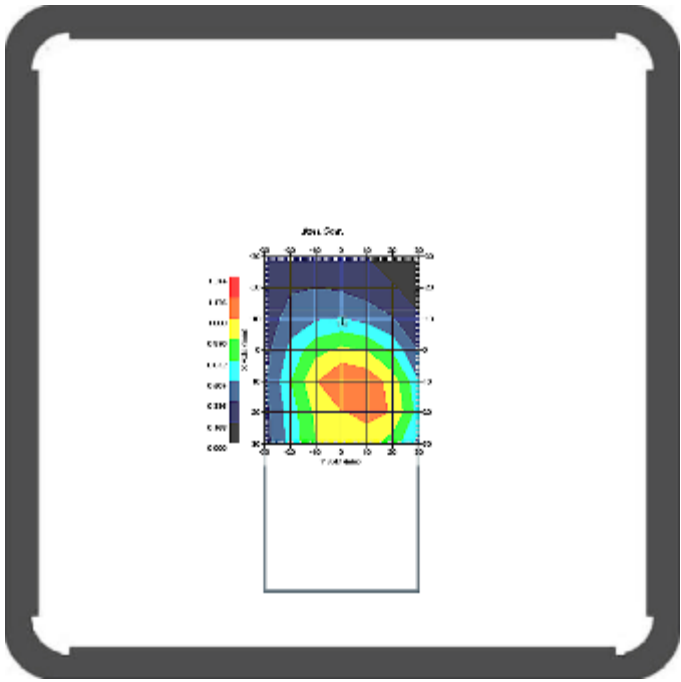
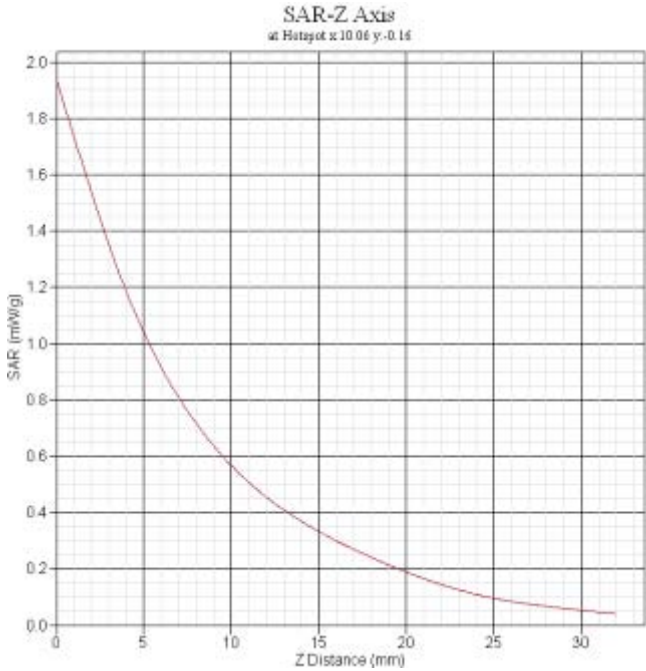

<b>GPRS1900 +Earphone body face CH661</b>	
Frequency(MHz)	1880.0
Relative permittivity(real part)	52.13
Conductivity(S/m)	1.54
Variation(%)	-2.006
Duty Cycle Factor	4
Crest factor	4
Conversion Fator	5.4
Probe Sensitivity	1.20 1.20 1.20 $\mu$ V/(V/m) <sup>2</sup>
Data	2012-03-14
	
SAR 1g(W/Kg)	1.111
SAR 10g(W/Kg)	0.624

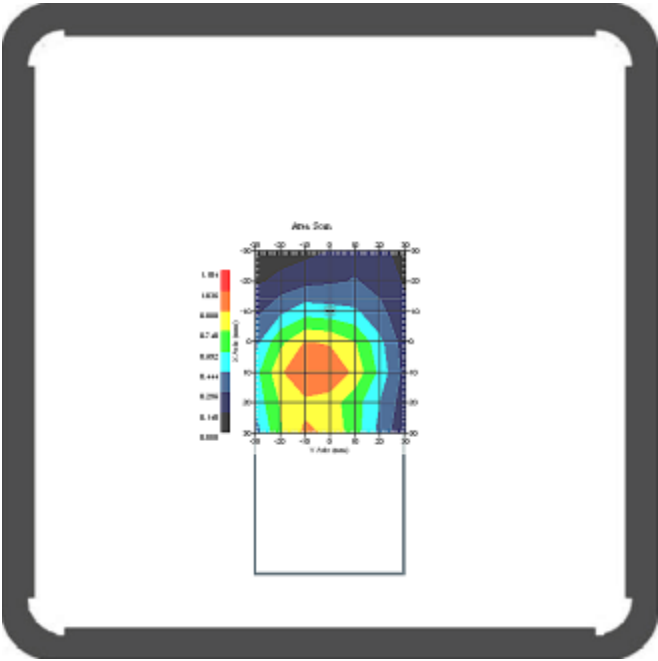
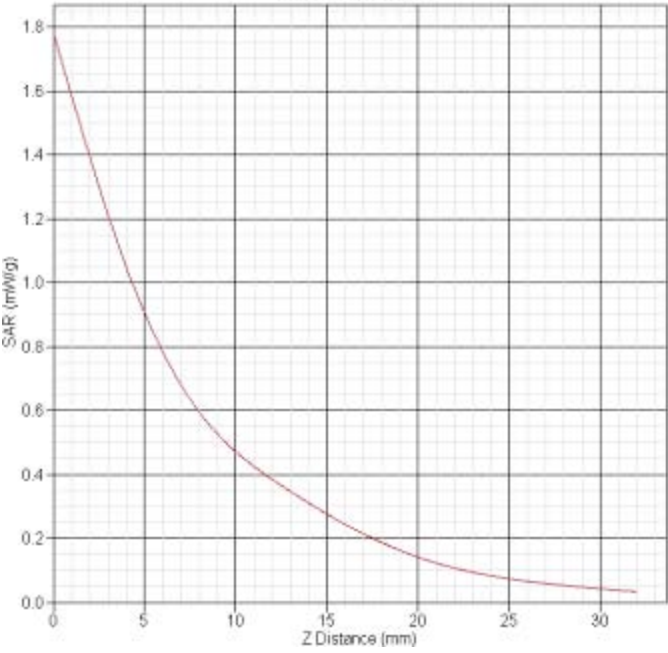

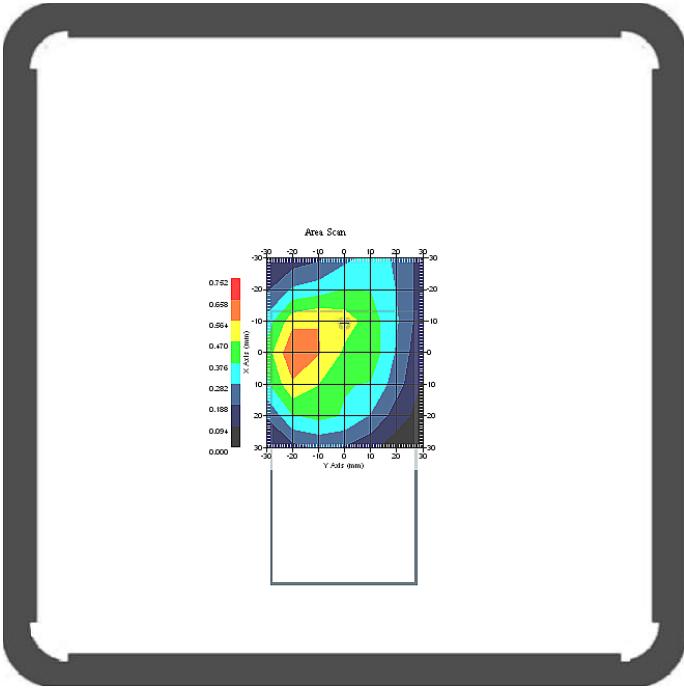
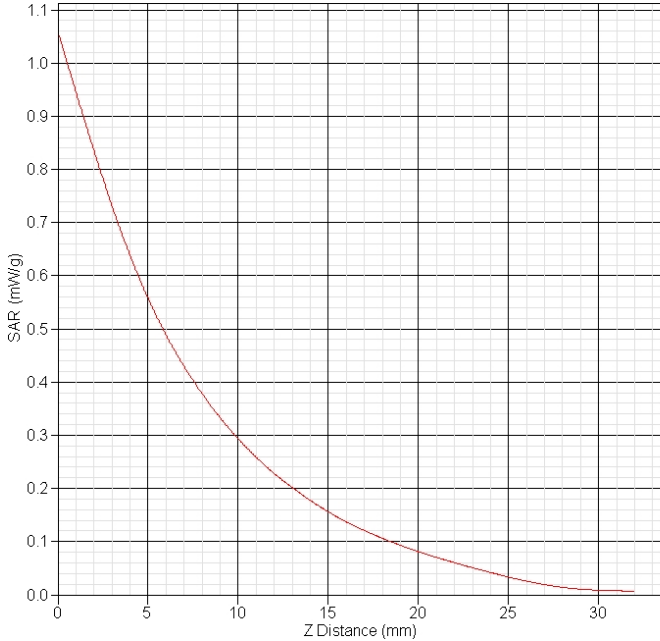
<b>GPRS1900 +Earphone body bottom CH661</b>	
Frequency(MHz)	1880.0
Relative permittivity(real part)	52.13
Conductivity(S/m)	1.54
Variation(%)	1.817
Duty Cycle Factor	4
Crest factor	4
Conversion Fator	5.4
Probe Sensitivity	1.20 1.20 1.20 $\mu$ V/(V/m) <sup>2</sup>
Data	2012-03-14
	<p>SAR-Z Axis at Hotspot x:10.01 y:-2.11</p> 
SAR 1g(W/Kg)	0.995
SAR 10g(W/Kg)	0.553

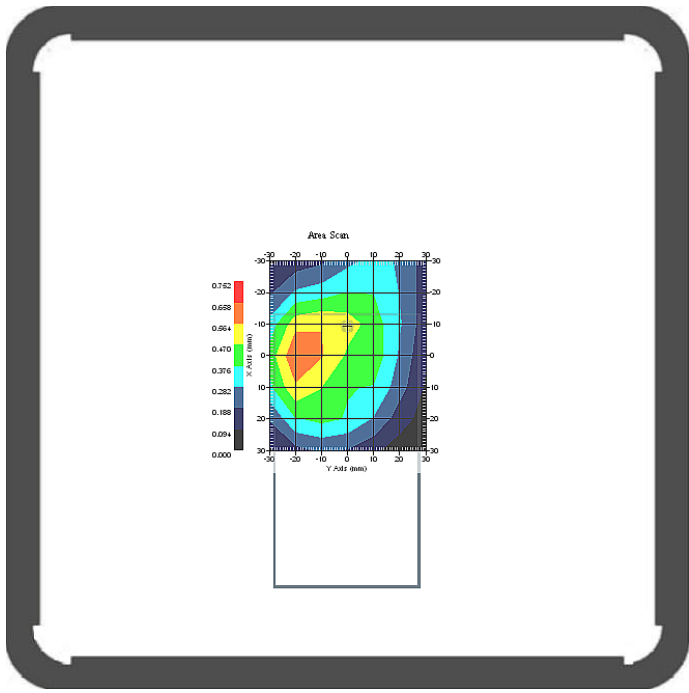
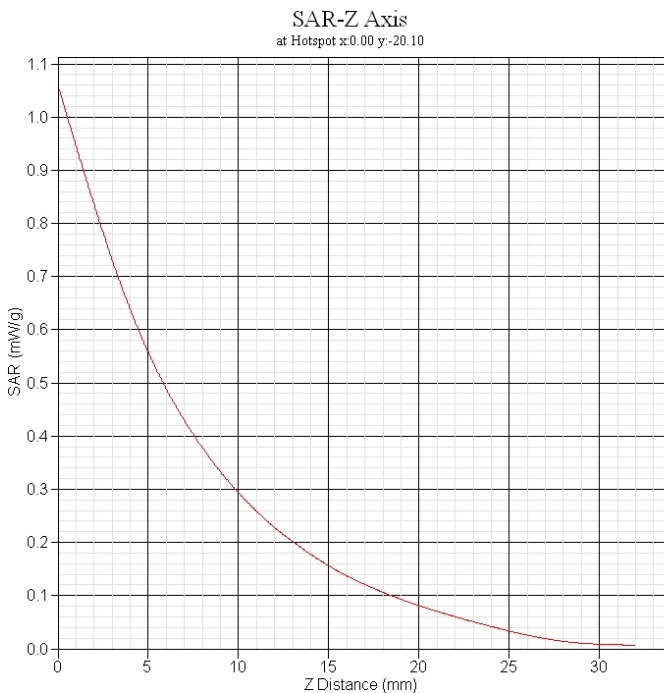
<b>GPRS1900 +Earphone body bottom CH512</b>	
Frequency(MHz)	1850.2
Relative permittivity(real part)	52.13
Conductivity(S/m)	1.54
Variation(%)	1.628
Duty Cycle Factor	4
Crest factor	4
Conversion Fator	5.4
Probe Sensitivity	1.20 1.20 1.20 $\mu$ V/(V/m) <sup>2</sup>
Data	2012-03-30
	<p>SAR-Z Axis at Hotspot x:0.00 y:-20.10</p> 
SAR 1g(W/Kg)	0.739
SAR 10g(W/Kg)	0.513

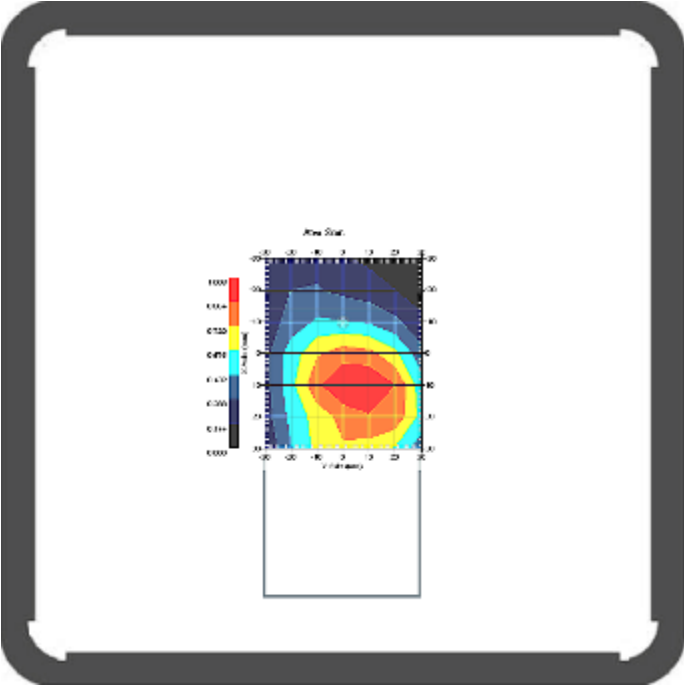
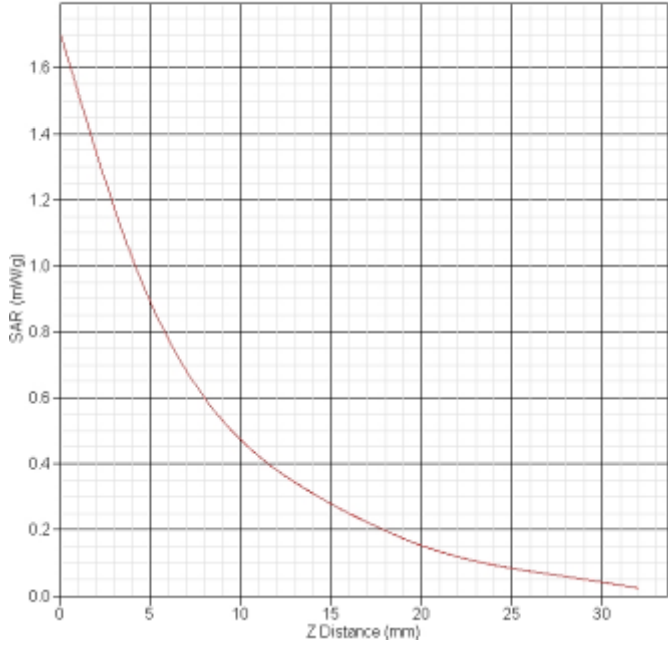
<b>GPRS1900 +Earphone body bottom CH810</b>	
Frequency(MHz)	1909.8
Relative permittivity(real part)	52.13
Conductivity(S/m)	1.54
Variation(%)	-1.703
Duty Cycle Factor	4
Crest factor	4
Conversion Fator	5.4
Probe Sensitivity	1.20 1.20 1.20 $\mu$ V/(V/m) <sup>2</sup>
Data	2012-03-30
	 <p style="text-align: center;">SAR-Z Axis at Hotspot x:0.00 y:-20.10</p>
SAR 1g(W/Kg)	0.724
SAR 10g(W/Kg)	0.501

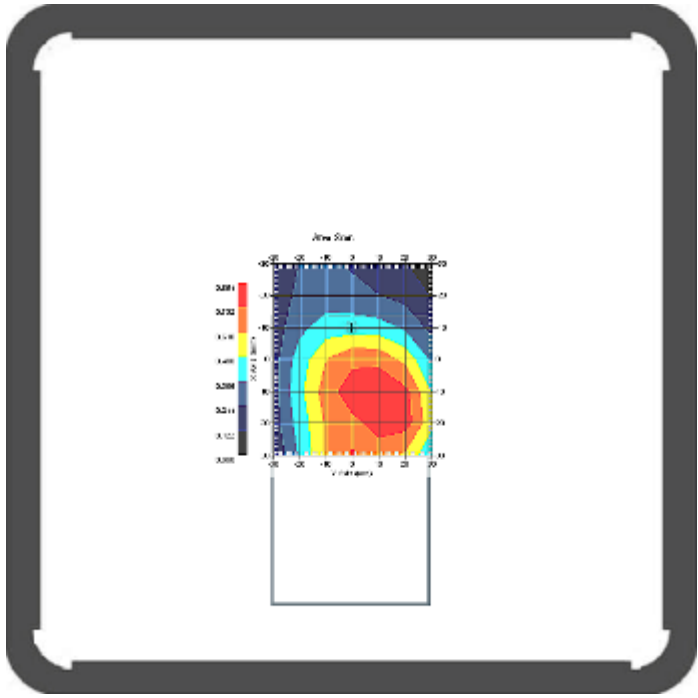
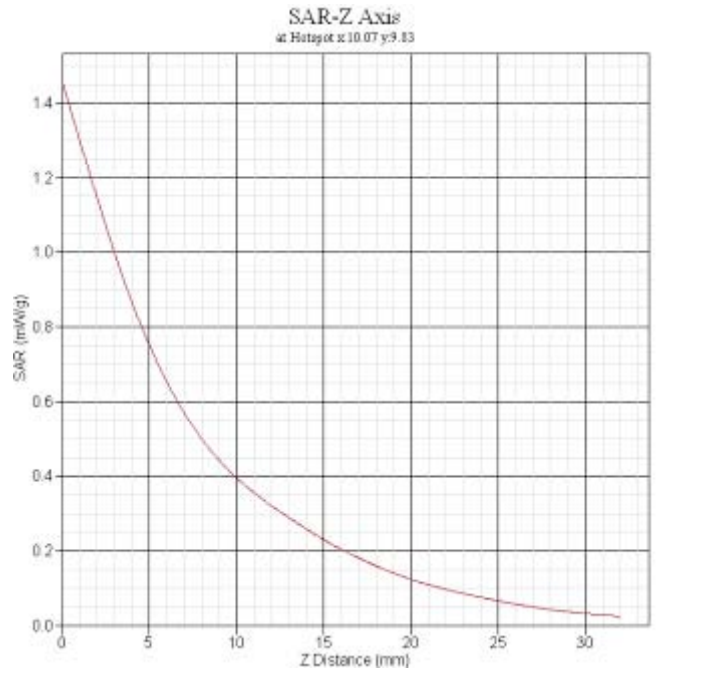
<b>GPRS1900+Earphone body face CH512</b>	
Frequency(MHz)	1850.2
Relative permittivity(real part)	52.13
Conductivity(S/m)	1.54
Variation(%)	-1.689
Duty Cycle Factor	4
Crest factor	4
Conversion Fator	5.4
Probe Sensitivity	1.20 1.20 1.20 $\mu$ V/(V/m) <sup>2</sup>
Data	2012-03-14
	<p>SAR-Z Axis at Hotspot x:10.86 y:9.90</p> 
SAR 1g(W/Kg)	0.965
SAR 10g(W/Kg)	0.534

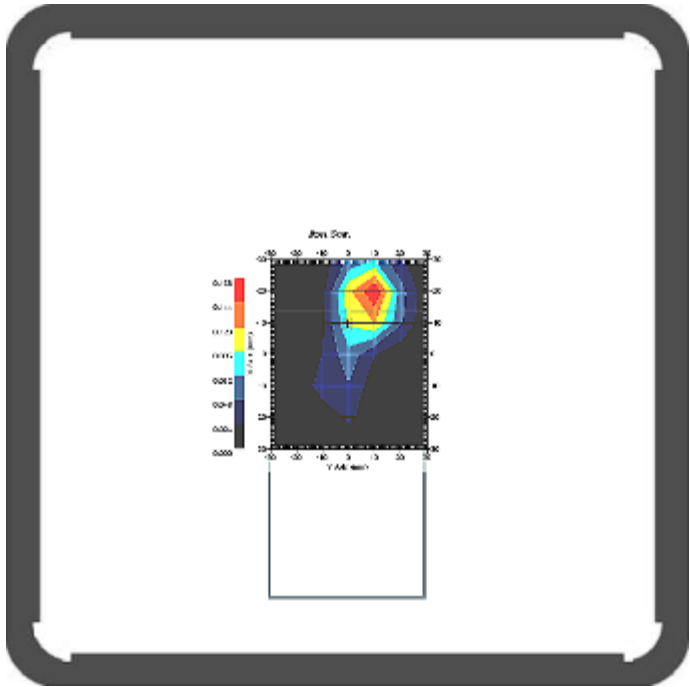
<b>GPRS1900+Earphone body face CH810</b>	
Frequency(MHz)	1909.8
Relative permittivity(real part)	52.13
Conductivity(S/m)	1.54
Variation(%)	-2.742
Duty Cycle Factor	4
Crest factor	4
Conversion Fator	5.4
Probe Sensitivity	1.20 1.20 1.20 $\mu$ V/(V/m) <sup>2</sup>
Data	2012-03-14
	
SAR 1g(W/Kg)	0.840
SAR 10g(W/Kg)	0.473

<b>802.11b body face CH6</b>	
Frequency(MHz)	2437
Relative permittivity(real part)	52.09
Conductivity(S/m)	1.92
Variation(%)	-2.984
Duty Cycle Factor	1
Crest factor	1
Conversion Fator	4.4
Probe Sensitivity	1.20 1.20 1.20 $\mu$ V/(V/m) <sup>2</sup>
Data	2012-03-15
	
SAR 1g(W/Kg)	0.137
SAR 10g(W/Kg)	0.049

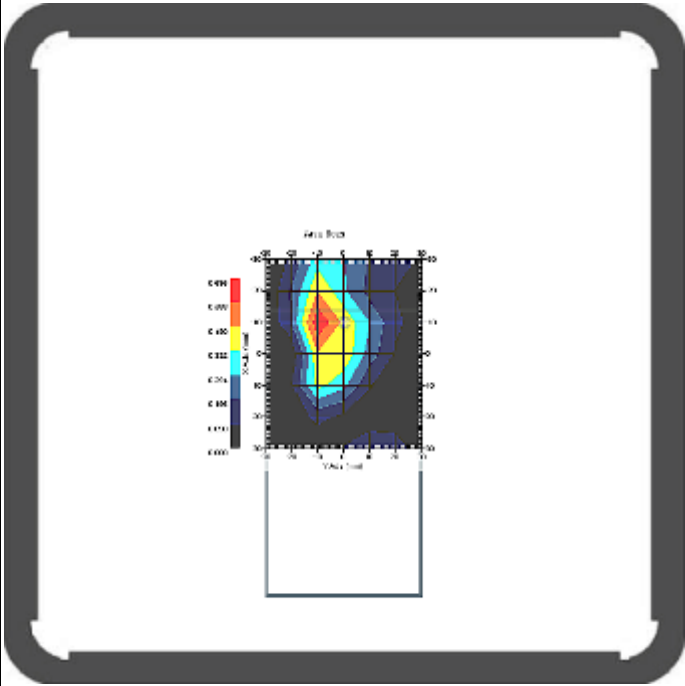
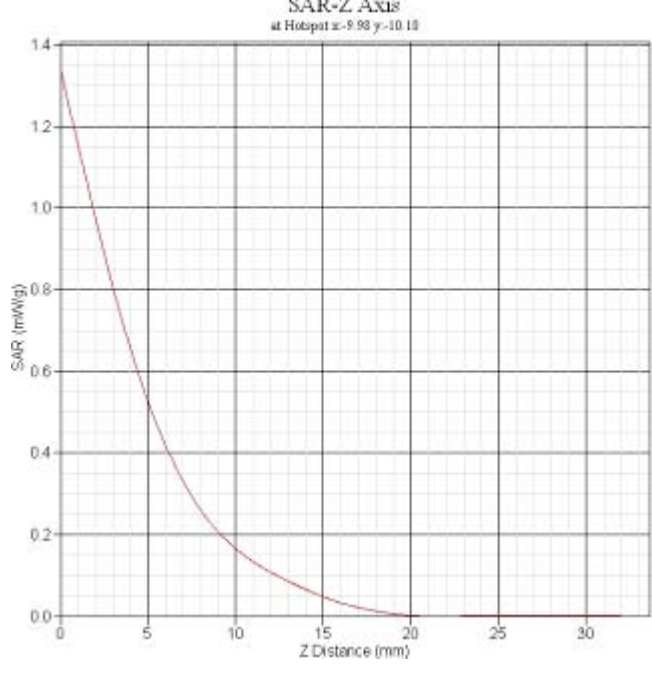
<b>802.11b body bottom CH6</b>	
Frequency(MHz)	2437
Relative permittivity(real part)	52.09
Conductivity(S/m)	1.92
Variation(%)	-3.093
Duty Cycle Factor	1
Crest factor	1
Conversion Fator	4.4
Probe Sensitivity	1.20 1.20 1.20 $\mu$ V/(V/m) <sup>2</sup>
Data	2012-03-15
	
SAR 1g(W/Kg)	0.349
SAR 10g(W/Kg)	0.223

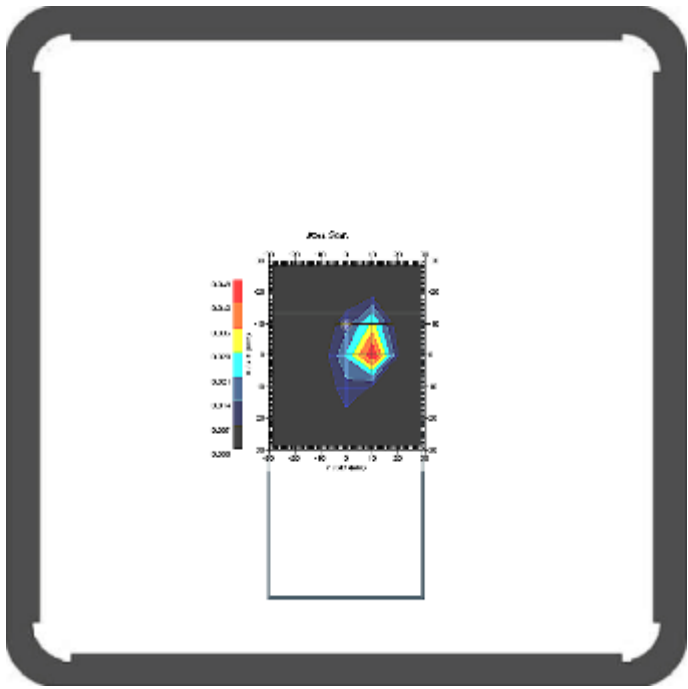
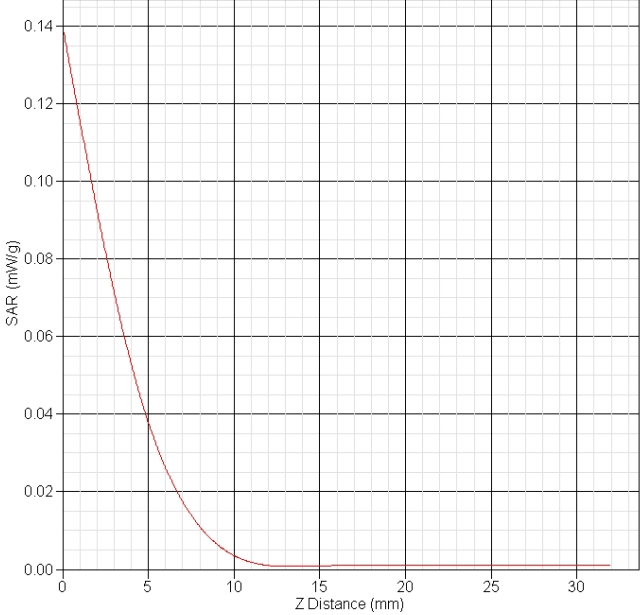

<b>802.11g body face CH6</b>	
Frequency(MHz)	2437
Relative permittivity(real part)	52.09
Conductivity(S/m)	1.92
Variation(%)	-2.316
Duty Cycle Factor	1
Crest factor	1
Conversion Fator	4.4
Probe Sensitivity	1.20 1.20 1.20 $\mu$ V/(V/m) <sup>2</sup>
Data	2012-03-15
	<p>SAR-Z Axis at Hotspot x:0.10 y:9.81</p> 
SAR 1g(W/Kg)	0.041
SAR 10g(W/Kg)	0.012

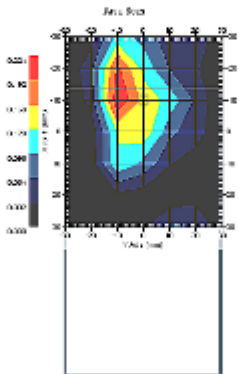
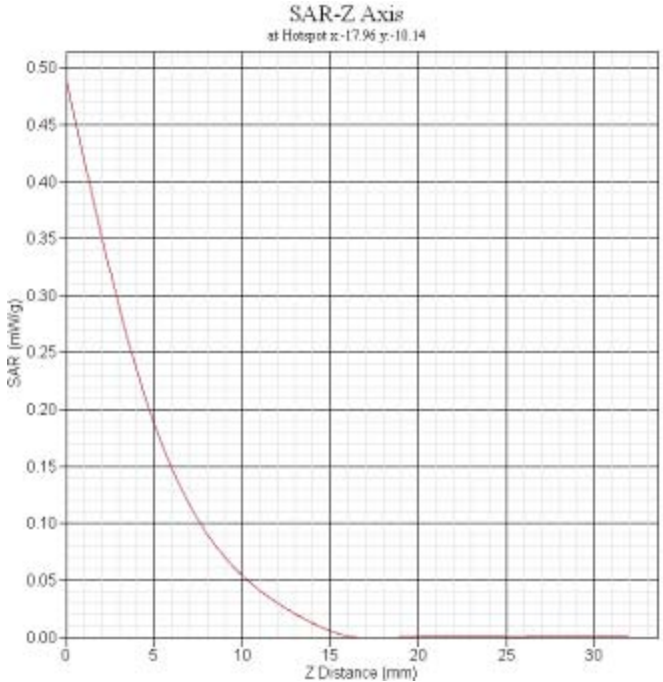
<b>802.11g body bottom CH6</b>	
Frequency(MHz)	2437
Relative permittivity(real part)	52.09
Conductivity(S/m)	1.92
Variation(%)	-0.479
Duty Cycle Factor	1
Crest factor	1
Conversion Fator	4.4
Probe Sensitivity	1.20 1.20 1.20 $\mu$ V/(V/m) <sup>2</sup>
Data	2012-03-15
	
SAR 1g(W/Kg)	0.195
SAR 10g(W/Kg)	0.074