



# FCC SAR TEST REPORT

**Report No.:** SET2014-00063

**Product:** GSM/WCDMA MOBILE PHONE

**Model No.:** M4 SS1050

**FCC ID:** CLNSS1050

**Applicant:** MFOURTEL MEXICO S.A. DE C.V.

**Address:** Homero No. 136 – 101 Col. Chapultepec Morales, C.P. 11570, Delegación Miguel Hidalgo

**Issued by:** CCIC-SET

**Lab Location:** Electronic Testing Building, Shahe Road, Xili, Nanshan District, Shenzhen, 518055, P. R. China

**Tel:** 86 755 26627338      **Fax:** 86 755 26627238

**Mail:** manager@ccic-set.com      **Website:** <http://www.ccic-set.com>

This test report consists of **128** pages in total. It may be duplicated completely for legal use with the approval of the applicant. It should not be reproduced except in full, without the written approval of our laboratory. The client should not use it to claim product endorsement by CCIC-SET. The test results in the report only apply to the tested sample. The test report shall be invalid without all the signatures of testing engineers, reviewer and approver. Any objections must be raised to CCIC-SET within 15 days since the date when the report is received. It will not be taken into consideration beyond this limit.



### Test Report

**Product**.....: GSM/WCDMA MOBILE PHONE  
**Model No.** .....: M4 SS1050  
**Brand Name**.....: M4  
**FCC ID**.....: CLNSS1050  
**Applicant**.....: MFOURTEL MEXICO S.A. DE C.V.  
**Applicant Address**.....: Homero No. 136 – 101 Col. Chapultepec Morales, C.P. 11570, Delegación Miguel Hidalgo

**Manufacturer**.....: CK Telecom Limited  
**Manufacturer Address**.....: Technology Road.High-Tech Development Zone. Heyuan, Guangdong,P.R.China.

**Test Standards**.....: **47CFR § 2.1093-** Radiofrequency Radiation Exposure Evaluation: Portable Devices;  
**FCC OET Bulletin 65 (Edition 97-01), Supplement C (Edition 01-01):** Evaluating Compliance with FCC Guidelines for Human Exposure to Radiofrequency Electromagnetic Fields;  
**ANSI C95.1–1999:** IEEE Standard for Safety Levels with Respect to Human Exposure to Radio Frequency Electromagnetic Fields, 3 kHz to 300 GHz;  
**RSS-102–2010:** Radio Frequency (RF) Exposure Compliance of Radio communication Apparatus (All Frequency Bands)

**Test Result**.....: Pass

**Tested by** .....: *Mei Chun* 2014-01-06  
 \_\_\_\_\_  
 Chun Mei, Test Engineer

**Reviewed by**.....: *Shuangwen Zhang* 2014-01-06  
 \_\_\_\_\_  
 Shuangwen Zhang, Senior EGINEER

**Approved by**.....: *Wu Lian* 2014-01-06  
 \_\_\_\_\_  
 Wu Li'an , Manager



# Contents

- 1. **GENERAL CONDITIONS**-----4
- 2. **ADMINISTRATIVE DATA**-----5
  - 2.1. Identification of the Responsible Testing Laboratory-----5
  - 2.2. Identification of the Responsible Testing Location(s)-----5
  - 2.3. Organization Item-----5
  - 2.4. Identification of Applicant-----5
  - 2.5. Identification of Manufacture-----5
- 3. **EQUIPMENT UNDER TEST (EUT)**-----6
- 4. **OPERATIONAL CONDITIONS DURING TEST**-----7
  - 4.1. Introduction-----7
  - 4.2. SAR Definition-----7
  - 4.3. Phantoms-----8
  - 4.4. Device Holder-----8
  - 4.5. Probe Specification-----9
- 5. **OPERATIONAL CONDITIONS DURING TEST**-----10
  - 5.1. Schematic Test Configuration-----10
  - 5.2. SAR Measurement System-----10
  - 5.3. Equipments and results of validation testing-----14
  - 5.4. SAR measurement procedure-----17
  - 5.5. Antennas position and test position-----18
- 6. **CHARACTERISTICS OF THE TEST**-----19
  - 6.1. Applicable Limit Regulations-----19
  - 6.2. Applicable Measurement Standards-----19
- 7. **LABORATORY ENVIRONMENT**-----20
- 8. **CONDUCTED RF OUTPUT POWER**-----21
- 9. **TEST RESULTS**-----27
- 10. **MEASUREMENT UNCERTAINTY**-----33
- 11. **MAIN TEST INSTRUMENTS**-----35

**This Test Report consists of the following Annexes:**

<b>Annex A: Accreditation Certificate</b> -----	36
<b>Annex B: Test Layout</b> -----	38
<b>Annex C: Sample Photographs</b> -----	45
<b>Annex D: System Performance Check Data and Highest SAR Plots</b> -----	47
<b>Annex E: Calibration Certificate of Probe and Dipoles</b> -----	87



## **1. GENERAL CONDITIONS**

**1.1 This report only refers to the item that has undergone the test.**

**1.2 This report standalone does not constitute or imply by its own an approval of the product by the certification Bodies or competent Authorities.**

**1.3 This document is only valid if complete; no partial reproduction can be made without written approval of CCIC-SET**

**1.4 This report cannot be used partially or in full for publicity and/or promotional purposes without previous written approval of CCIC-SET and the Accreditation Bodies, if it applies.**



## 2. Administrative Date

### 2.1. Identification of the Responsible Testing Laboratory

**Company Name:** CCIC-SET

**Department:** EMC & RF Department

**Address:** Electronic Testing Building, Shahe Road, Nanshan District, ShenZhen, P. R. China

**Telephone:** +86-755-26629676

**Fax:** +86-755-26627238

**Responsible Test Lab Managers:** Mr. Wu Li'an

### 2.2. Identification of the Responsible Testing Location(s)

**Company Name:** CCIC-SET

**Address:** Electronic Testing Building, Shahe Road, Nanshan District, Shenzhen, P. R. China

### 2.3. Organization Item

**CCIC-SET Report No.:** SET2014-00063

**CCIC-SET Project Leader:** Mr. Li Sixiong

**CCIC-SET Responsible for accreditation scope:** Mr. Wu Li'an

**Start of Testing:** 2013-12-26

**End of Testing:** 2013-12-27

### 2.4. Identification of Applicant

**Company Name:** MFOURTEL MEXICO S.A. DE C.V.

**Address:** Homero No. 136 – 101 Col. Chapultepec Morales, C.P. 11570, Delegación Miguel Hidalgo

### 2.5. Identification of Manufacture

**Company Name:** CK Telecom Limited

**Address:** Technology Road.High-Tech Development Zone. Heyuan, Guangdong,P.R.China.

**Notes:** This data is based on the information by the applicant.

### 3. Equipment Under Test (EUT)

#### 3.1. Identification of the Equipment under Test

**Sample Name:** GSM/WCDMA MOBILE PHONE

**Type Name:** M4 SS1050

**Brand Name:** M4

	Support Band	GSM850MHz/1900MHz/900MHz/1800MHz WCDMA 850MHz/1900MHz Wi-Fi802.11b,802.11g,802.11n-20,802.11n-40, Bluetooth
	Test Band	GSM 850MHz/ GSM 1900MHz WCDMA 850MHz/ WCDMA 1900MHz Wi-Fi 802.11b
	Multislot Class	GPRS:Class 12
<b>General description:</b>	GPRS Class	Class B
	Development Stage	Identical Prototype
	Accessories	Power Supply
	Antenna type	PIFA Antenna
	Operation mode	GSM / GPRS/WCDMA / Bluetooth / WIFI
	Modulation mode	GMSK, 8PSK, QPSK,16QAM,DSSS, OFDM, GFSK/π /4-DQPSK/8-DPSK
	Max. RF Power	32.24dBm
	Max. SAR Value	Head:0.794w/kg; Body:0.867w/kg

#### NOTE:

- a. The above EUT's information was declared by manufacturer. Please refer to the specifications or user's manual for more detailed description.
- b. This device supports GPRS operation up to class12  
(max.uplin:4, max.downlink:4, total timeslots:5)
- c. The EUT does not support uplink function in EDGE mode.

## 4 Specific Absorption Rate (SAR)

### 4.1 Introduction

SAR is related to the rate at which energy is absorbed per unit mass in an object exposed to a radio field. The SAR distribution in a biological body is complicated and is usually carried out by experimental techniques or numerical modeling. The standard recommends limits for two tiers of groups, occupational/controlled and general population/uncontrolled, based on a person's awareness and ability to exercise control over his or her exposure. In general, occupational/controlled exposure limits are higher than the limits for general population/uncontrolled.

### 4.2 SAR Definition

The SAR definition is the time derivative (rate) of the incremental energy (dW) absorbed by (dissipated in) an incremental mass (dm) contained in a volume element (dv) of a given density ( $\rho$ ). The equation description is as below:

$$\text{SAR} = \frac{d}{dt} \left( \frac{dW}{dm} \right) = \frac{d}{dt} \left( \frac{dW}{\rho dv} \right)$$

SAR is expressed in units of Watts per kilogram (W/kg)

SAR measurement can be either related to the temperature elevation in tissue by

$$\text{SAR} = C \frac{\delta T}{\delta t}$$

where C is the specific heat capacity,  $\delta T$  is the temperature rise and  $\delta t$  the exposure duration, or related to the electrical field in the tissue by

$$\text{SAR} = \frac{\sigma |E|^2}{\rho}$$

where  $\sigma$  is the conductivity of the tissue,  $\rho$  is the mass density of the tissue and E is the rms electrical field strength.

However for evaluating SAR of low power transmitter, electrical field measurement is typically applied.

### 4.3 Phantoms

The phantom used for all tests i.e. for both system checks and device testing, was the twin-headed "SAM Phantom", manufactured by SATIMO. The SAM twin phantom is a fiberglass shell phantom with 2mm shell thickness (except the ear region, where shell thickness increases to 6mm).

System checking was performed using the flat section, whilst Head SAR tests used the left and right head profile sections. Body SAR testing also used the flat section between the head profiles.



SAM Twin Phantom

### 4.4 Device Holder

The device was placed in the device holder (illustrated below) that is supplied by SATIMO as an integral part of the COMOSAR test system.

The device holder is designed to cope with the different positions given in the standard. It has two scales for device rotation (with respect to the body axis) and device inclination (with respect to the line between the ear reference points). The rotation centers for both scales is the ear reference point (ERP). Thus the device needs no repositioning when changing the angles.

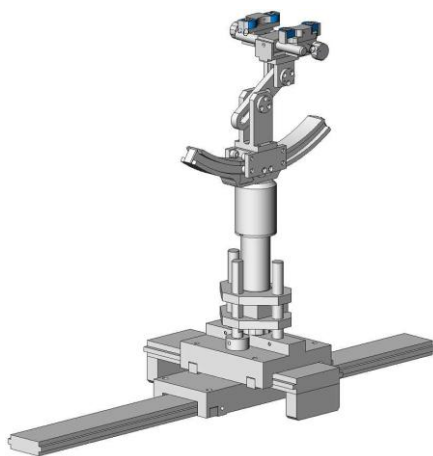

Device holder



## 4.5 Probe Specification



Construction	Symmetrical design with triangular core Interleaved sensors Built-in shielding against static charges PEEK enclosure material (resistant to organic solvents, e.g., DGBE)
Calibration	ISO/IEC 17025 calibration service available.
Frequency	700 MHz to 3 GHz; Linearity: $\pm 0.5$ dB (700 MHz to 3 GHz)
Directivity	$\pm 0.25$ dB in HSL (rotation around probe axis) $\pm 0.5$ dB in tissue material (rotation normal to probe axis)
Dynamic Range	1.5 $\mu$ W/g to 100 mW/g; Linearity: $\pm 0.5$ dB
Dimensions	Overall length: 330 mm (Tip: 20 mm) Tip diameter: 5 mm (Body: 8 mm) Distance from probe tip to dipole centers: <2.7 mm
Application	General dosimetry up to 3 GHz Dosimetry in strong gradient fields Compliance tests of mobile phones
Compatibility	COMOSAR

### Isotropic E-Field Probe

The isotropic E-Field probe has been fully calibrated and assessed for isotropicity, and boundary effect within a controlled environment. Depending on the frequency for which the probe is calibrated the method utilized for calibration will change.

The E-Field probe utilizes a triangular sensor arrangement as detailed in the diagram below:

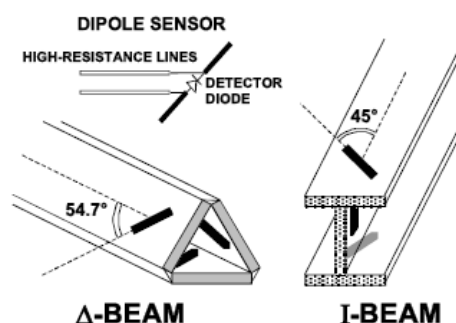

## 5 OPERATIONAL CONDITIONS DURING TEST

### 5.1 Schematic Test Configuration

During SAR test, EUT was operating in Traffic Mode (Channel Allocated) at Normal Voltage Condition. A communication link is set up with a System Simulator (SS) by air link, and a call is established.

The Absolute Radio Frequency Channel Number (ARFCN) was allocated to 128, 190 and 251 respectively in the case of GSM 850MHz, or to 512, 661 and 810 respectively in the case of PCS 1900MHz, or to 4132, 4183 and 4233 respectively in the case of WCDMA 850MHz, or to 9262, 9400 and 9538 respectively in the case of WCDMA 1900 MHz. The EUT was commanded to operate at maximum transmitting power.

The EUT should use its internal transmitter. The antenna(s), battery and accessories shall be those specified by the manufacturer. The EUT battery must be fully charged and checked periodically during the test to ascertain uniform power output. If a wireless link was used, the antenna connected to the output of the base station simulator shall be placed at least 50 cm away from the handset.

The signal transmitted by the simulator to the antenna feeding point should be lower than the output power level of the handset by at least 35 dB

### 5.2 SAR Measurement System

The SAR measurement system being used is the SATIMO system, the system is controlled remotely from a PC, which contains the software to control the robot and data acquisition equipment. The software also displays the data obtained from test scans.

In operation, the system first does an area (2D) scan at a fixed depth within the liquid from the inside wall of the phantom. When the maximum SAR point has been found, the system will then carry out a 3D scan centred at that point to determine volume averaged SAR level.

#### 5.2.1 Tissue Dielectric Parameters for Head and Body Phantoms

The head tissue dielectric parameters recommended by the IEEE SCC-34/SC-2 in P1528 have been incorporated in the following table. These head parameters are derived from planar layer models simulating the highest expected SAR for the dielectric properties and tissue thickness Power drifts in a human head. Other head and body tissue parameters that have not been specified in P1528 are derived from the tissue dielectric parameters computed from the 4-Cole-Cole equations described in Reference [12] and extrapolated according to the head parameters specified in P1528.

Table 1: Recommended Dielectric Performance of Tissue

Ingredients (% by weight )	Frequency (MHz)									
	450		835		915		1900		2450	
Tissue Type	Head	Body	Head	Body	Head	Body	Head	Body	Head	Body
Water	38.56	51.16	41.45	52.4	41.05	56.0	54.9	40.4	62.7	73.2
Salt (Nacl)	3.95	1.49	1.45	1.4	1.35	0.76	0.18	0.5	0.5	0.04
Sugar	56.32	46.78	56.0	45.0	56.5	41.76	0.0	58.0	0.0	0.0
HEC	0.98	0.52	1.0	1.0	1.0	1.21	0.0	1.0	0.0	0.0
Bactericide	0.19	0.05	0.1	0.1	0.1	0.27	0.0	0.1	0.0	0.0
Triton x-100	0.0	0.0	0.0	0.0	0.0	0.0	0.0	0.0	36.8	0.0
DGBE	0.0	0.0	0.0	0.0	0.0	0.0	44.92	0.0	0.0	26.7
Dielectric Constant	43.42	58.0	42.54	56.1	42.0	56.8	39.9	54.0	39.8	52.5
Conductivity (s/m)	0.85	0.83	0.91	0.95	1.0	1.07	1.42	1.45	1.88	1.78

Table 2 Recommended Tissue Dielectric Parameters

Frequency (MHz)	Head Tissue		Body Tissue	
	$\epsilon_r$	$\sigma$ (S/m)	$\epsilon_r$	$\sigma$ (S/m)
150	52.3	0.76	61.9	0.80
300	45.3	0.87	58.2	0.92
450	43.5	0.87	56.7	0.94
835	41.5	0.90	55.2	0.97
900	41.5	0.97	55.0	1.05
915	41.5	0.98	55.0	1.06
1450	40.5	1.20	54.0	1.30
1610	40.3	1.29	53.8	1.40
1800-2000	40.0	1.40	53.3	1.52
2450	39.2	1.80	52.7	1.95
3000	38.5	2.40	52.0	2.73
5800	35.3	5.27	48.2	6.00

## 5.2.2 Simulant liquids

For measurements against the phantom head, the “cheek” and “tilt” position on both the left hand and the right hand sides of the phantom. For body-worn measurements, the EUT was tested against flat phantom representing the user body. The EUT was put on in the belt holder. Simulant liquids that are used for testing at frequencies of GSM 850MHz, GSM 1900MHz, WCDMA 850MHz, WCDMA 1900MHz, and Wi-Fi 2.4GHz, which are made mainly of sugar, salt and water solutions may be left in the phantoms.

Table 3: Dielectric Performance of Head Tissue Simulating Liquid

Temperature: 23.2°C; Humidity: 64%;					
/	Frequency	Permittivity $\epsilon$	Conductivity $\sigma$ (S/m)	Deviation (%)	
Target value	835MHz	41.5	0.90	$\epsilon$	$\sigma$
Validation value (December 26th, 2013)	835MHz	41.38	0.94	-0.5	4.4
Target value	1900MHz	40.0	1.40	--	--
Validation value (December 26th, 2013)	1900MHz	39.98	1.42	-0.3	1.4
Target value	2450MHz	39.2	1.80	--	--
Validation value (December 26th, 2013)	2450MHz	38.98	1.79	-0.5	-0.6

Table 4: Dielectric Performance of Body Tissue Simulating Liquid

Temperature: 23.2°C; Humidity: 64%;					
/	Frequency	Permittivity $\epsilon$	Conductivity $\sigma$ (S/m)	Deviation (%)	
Target value	835MHz	55.2	0.97	$\epsilon$	$\sigma$
Validation value (December 27th, 2013)	835MHz	55.48	0.99	0.3	2.1
Target value	1900MHz	53.3	1.52	--	--
Validation value (December 27th, 2013)	1900MHz	53.57	1.51	0.7	-0.7
Target value	2450MHz	52.7	1.95	--	--
Validation value (December 27th, 2013)	2450MHz	52.58	1.97	-0.0	1.0

Table 5: Dielectric Performance of Tissue Simulating Liquid at test channel

Band	Channel	Frequency (MHz)	Permittivity $\epsilon$		Conductivity $\sigma$ (S/m)	
			Head	Body	Head	Body
GSM 850	128	824.2	41.94	0.92	55.96	0.97
	190	836.4	41.28	0.94	55.38	0.99
	251	848.8	40.92	0.95	55.12	1.01
GSM 1900	512	1850.2	41.25	1.36	54.25	1.46
	661	1880.0	40.84	1.39	53.98	1.49
	810	1909.8	39.72	1.42	53.43	1.51
WCDMA 850	4132	826.4	41.94	0.92	55.96	0.97
	4183	836.4	41.28	0.94	55.38	0.99
	4183	846.6	40.92	0.95	55.12	1.01
WCDMA 1900	9262	1852.4	41.25	1.36	54.25	1.46
	9400	1880.0	40.84	1.39	53.98	1.49
	9538	1907.6	39.72	1.42	53.43	1.51
WLAN	1	2412	39.47	1.78	52.95	1.94
	6	2437	39.12	1.79	52.70	1.97
	11	2462	38.84	1.81	52.33	2.02

According to Annex F (IEC62209-2), the delta SAR refers to the percent change in SAR relative to the percent change in dielectric properties versus the target values. A negative delta SAR would translate to a lower measured SAR value than what would be measured if using dielectric properties equal to the target values. A positive delta SAR would translate to a higher measured SAR value than what would be measured if using dielectric properties equal to the target values. SAR correction shall not be made when the delta SAR has a positive sign to provide a conservative SAR value. The SAR is only corrected when delta SAR has a negative sign. The  $\Delta$  SAR were given as follow:

 Table 6:  $\Delta$  SAR of each band

Frequency	SAR correction formula	$\Delta$ SAR	
		Head	Body
835MHz	$0.7521 \cdot \Delta \sigma(\%) - 0.2194 \cdot \Delta \epsilon(\%)$	>0	>0
1900MHz	$0.594 \cdot \Delta \sigma(\%) - 0.1556 \cdot \Delta \epsilon(\%)$	>0	>0
2450MHz	$0.4801 \cdot \Delta \sigma(\%) - 0.225 \cdot \Delta \epsilon(\%)$	>0	>0

Since each band has a positive  $\Delta$  SAR, the SAR correction is not required.



Fig. 1 Configuration of body tissue

### 5.3 Equipments and results of validation testing

Important equipments :

Equipment description	Manufacturer/Model	Identification No.
System Simulator	E5515C	GB 47200710
SAR Probe	SATIMO	SN 09/13 EP169
Dipole	SID835	SN 09/13 DIP 0G835-217
Dipole	SID1900	SN 09/13 DIP 1G900-218
Dipole	SID2450	SN 09/13 DIP 2G450-220
Vector Network Analyzer	ZVB8	A0802530
Signal Generator	SMR27	A0304219
Amplifier	Nucletudes	143060
Power Meter	NRVS	1020.1809.02
Power Sensor	NRV-Z4	100069
Multimeter	Keithley-2000	4014020
Device Holder	SATIMO	SN 09/13 MSH80
SAM Phantom	SAM97	SN 09/13 SAM97

Prior to the assessment, the system validation kit was used to test whether the system was operating within its specifications of  $\pm 10\%$ . The validation results are tabulated below. And also the corresponding SAR plot is attached as well in the SAR plots files.

The following procedure, recommended for performing validation tests using box phantoms is based on the procedures described in the draft IEEE standard P1528. Setup

according to the setup diagram below :

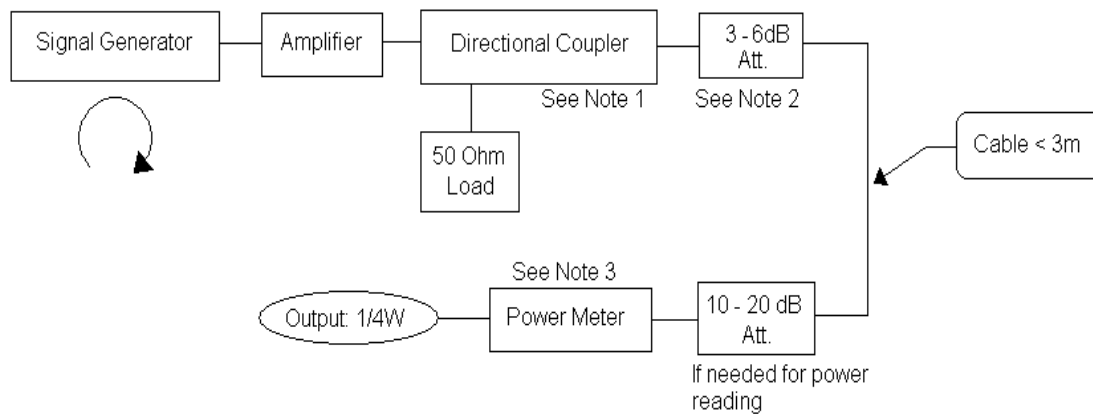

With the SG and Amp and with directional coupler in place, set up the source signal at the relevant frequency and use a power meter to measure the power at the end of the SMA cable that you intend to connect to the balanced dipole. Adjust the SG to make this, say, 0.25W (24 dBm). If this level is too high to read directly with the power meter sensor, insert a calibrated attenuator (e.g. 10 or 20 dB) and make a suitable correction to the power meter reading.

Note 1: In this method, the directional coupler is used for monitoring rather than setting the exact feed power level. If, however, the directional coupler is used for power measurement, you should check the frequency range and power rating of the coupler and measure the coupling factor (referred to output) at the test frequency using a VNA.

Note 2: Remember that the use of a 3dB attenuator (as shown in Figure 8.1 of P1528) means that you need an RF amplifier of 2 times greater power for the same feed power. The other issue is the cable length. You might get up to 1dB of loss per meter of cable, so the cable length after the coupler needs to be quite short.

Note 3: For the validation testing done using CW signals, most power meters are suitable. However, if you are measuring the output of a modulated signal from either a signal generator or a handset, you must ensure that the power meter correctly reads the modulated signals.

The measured 1-gram averaged SAR values of the device against the phantom are provided in Tables 7 and Table 8. The humidity and ambient temperature of test facility were 64% and 23.2°C respectively. The body phantom were full of the body tissue simulating liquid. The EUT was supplied with full-charged battery for each measurement.

The distance between the back of the EUT and the bottom of the flat phantom is 10 mm (taking into account of the IEEE 1528 and the place of the antenna).

Table 7: Head Liquid Verification Results (1g)

Frequency	Duty cycle	Target value (W/kg)	Test value (W/kg)		Deviation (%)
			250 mW	1W	
835MHz (December 26th, 2013)	1:1	9.72	2.48	9.92	3.2
1900MHz (December 26th, 2013)	1:1	40.95	9.78	39.12	-1.5
2450MHz (December 26th, 2013)	1:1	53.33	13.15	52.60	0.6

Note: Target value was referring to the measured value in the calibration certificate of reference dipole.

Note: All SAR values are normalized to 1W forward power.

Table 8: Body Liquid Verification Results (1g)

Frequency	Duty cycle	Target value (W/kg)	Test value (W/kg)		Deviation (%)
			250 mW	1W	
835MHz (December 27th, 2013)	1:1	9.92	2.42	9.68	-0.5
1900MHz (December 27th, 2013)	1:1	40.29	9.98	39.92	-0.7
2450MHz (December 27th, 2013)	1:1	51.99	13.13	52.52	0.8

\*Note: All SAR values are normalized to 1W forward power.



## 5.4 SAR measurement procedure

The SAR test against the head phantom was carried out as follow:

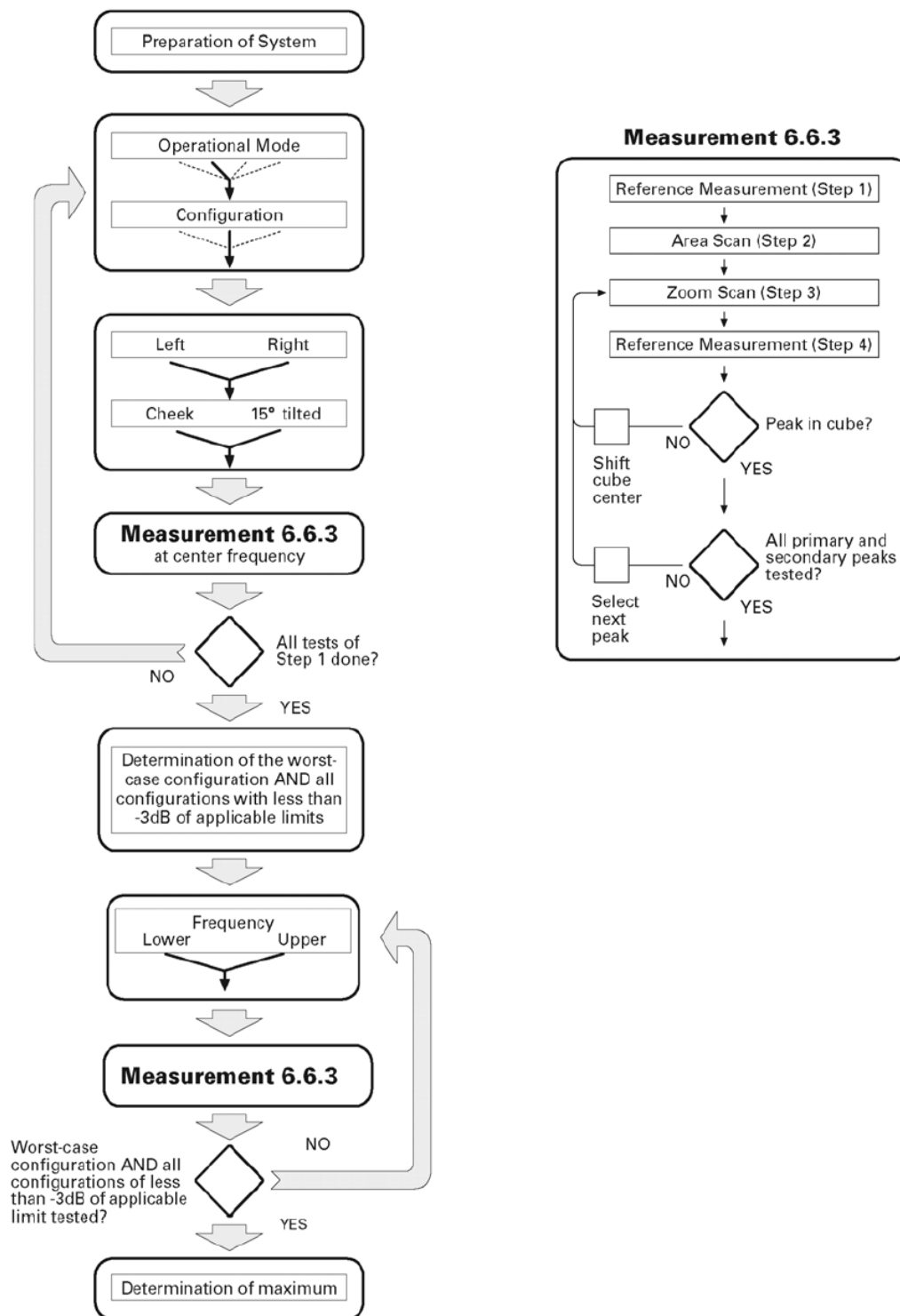

Establish a call with the maximum output power with a base station simulator, the connection between the EUT and the base station simulator is established via air interface.

After an area scan has been done at a fixed distance of 8mm from the surface of the phantom on the source side, a 3D scan is set up around the location of the maximum spot SAR. First, a point within the scan area is visited by the probe and a SAR reading taken at

the start of testing. At the end of testing, the probe is returned to the same point and a second reading is taken. Comparison between these start and end readings enables the power drift during measurement to be assessed.

Above is the scanning procedure flow chart and table from the IEEE p1528 standard. This is the procedure for which all compliant testing should be carried out to ensure that all variations of the device position and transmission behaviour are tested.

For body-worn measurement, the EUT was tested under two position: face upward and back upward.

### 5.5 Transmitting antenna information

There are two antennas (GSM & WCDMA antenna, WIFI & BT antenna) inside the EUT, the former two antennas are the transmitting source, and they are a type of IFA antenna.

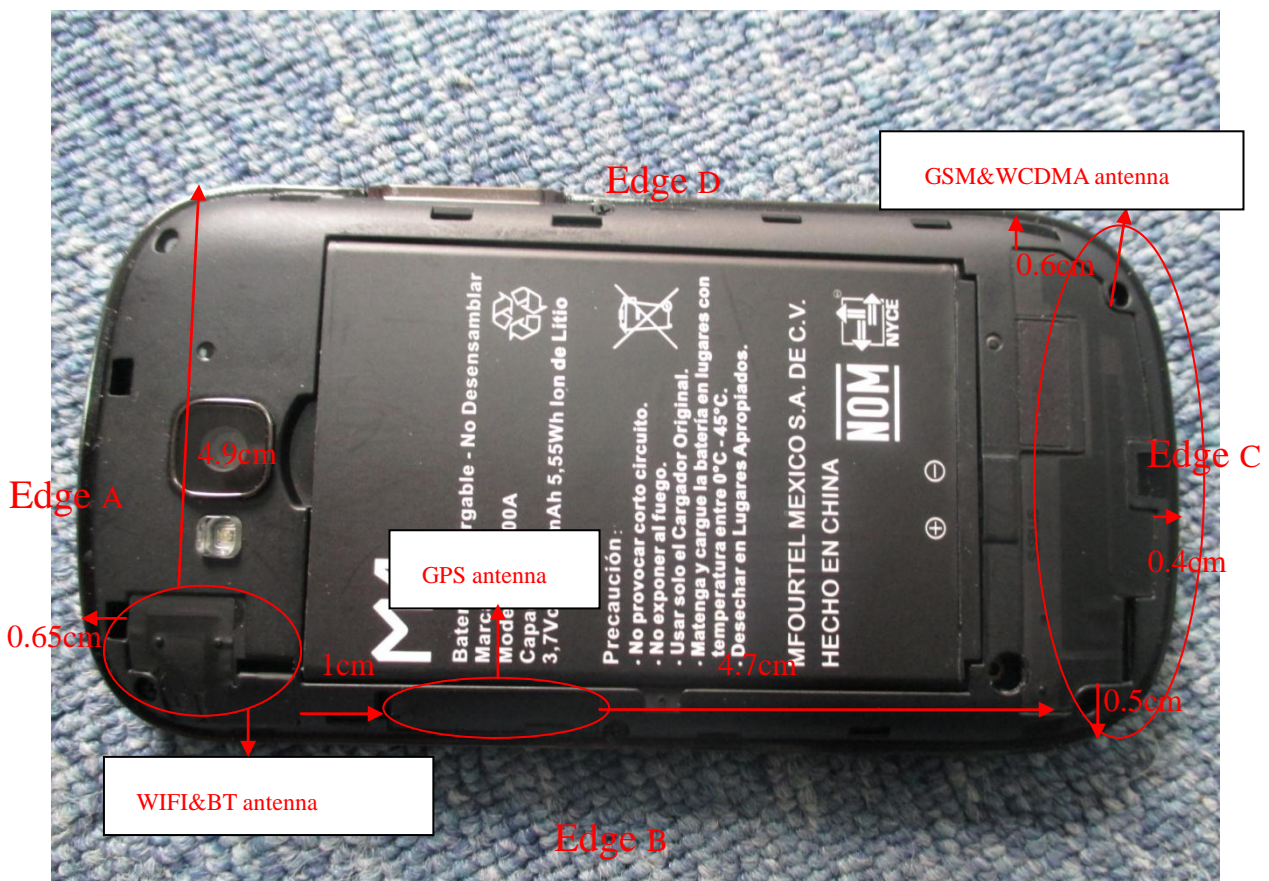

Fig. 3 Position of the antennas

### HOTSPOT MODE EVALUATION PROCEDURE

The SAR evaluation procedures for Portable Devices with Wireless Router function is according to KDB 941225 D06 Hot Spot SAR v01.



SAR must be tested for all surfaces and edges(side) with a transmitting antenna with in 2.5cm from that surface or edge, at a test separation distance of 10mm, in the wireless modes that support wireless routing.

Assessment		Hotspot side for SAR				
Test distance:10mm						
Antennas	Back	Front	Edge A	Edge B	Edge C	Edge D
GSM/WCDMA	Yes	Yes	No	Yes	Yes	Yes
WLAN/BT	Yes	Yes	Yes	Yes	No	No

## 6 CHARACTERISTICS OF THE TEST

### 6.1 Applicable Limit Regulations

**47CFR § 2.1093-** Radiofrequency Radiation Exposure Evaluation: Portable Devices;

**FCC OET Bulletin 65 (Edition 97-01), Supplement C (Edition 01-01):** Evaluating Compliance with FCC Guidelines for Human Exposure to Radiofrequency Electromagnetic Fields;

**ANSI C95.1–1999:** IEEE Standard for Safety Levels with Respect to Human Exposure to Radio Frequency Electromagnetic Fields, 3 kHz to 300 GHz;

**RSS-102–2010:** Radio Frequency (RF) Exposure Compliance of Radio communication Apparatus (All Frequency Bands)

It specifies the maximum exposure limit of **1.6 W/kg** as averaged over any 1 gram of tissue for portable devices being used within 20 cm of the user in the uncontrolled environment.

### 6.2 Applicable Measurement Standards

The Specific Absorption Rate (SAR) testing specification, method, and procedure for this is in accordance with the following standards:

FCC 47 CFR Part2 (2.1093)

ANSI/IEEE C95.1-1992

IEEE 1528-2003

IC RSS 102 Issue 4

FCC KDB 447498 D01 v05r01 General RF Exposure Guidance v05r01



FCC KDB 648474 D04 v01r01 SAR Evaluation Considerations for Wireless Handsets  
 FCC KDB 248227 D01 v01r02 SAR Measurement Procedures-802.11a/b/g Transmitters  
 FCC KDB 865664 D01 v01r01 SAR Measurement 100MHz to 6GHz  
 FCC KDB 865664 D02 v01r01 SAR Reporting  
 FCC KDB 941225 D01 v02 SAR test for 3G devices  
 FCC KDB 941225 D03 v01 Recommended SAR Test Reduction Procedures for GSM/GPRS/EDGE  
 FCC KDB 941225 D04 v01 Evaluating SAR for GSM/(E)GPRS Dual Transfer Mode  
 FCC KDB 941225 D06 v01r01 Hot Spot SAR

## 7 LABORATORY ENVIRONMENT

### 7.1 The Ambient Conditions during SAR Test

Temperature	Min. = 15 ° C, Max. = 30 ° C
Atmospheric pressure	Min.=86 kPa, Max.=106 kPa
Relative humidity	Min. = 30%, Max. = 70%
Ground system resistance	< 0.5 Ω
Ambient noise is checked and found very low and in compliance with requirement of standards.	
Reflection of surrounding objects is minimized and in compliance with requirement of standards.	

### 7.2 Test Configuration

For WWAN SAR testing, the device was controlled by using a base station emulator. Communication between the device and the emulator was established by air link. The distance between the EUT and the antenna of the emulator is larger than 50 cm and the output power radiated from the emulator antenna is at least 30dB smaller than output power of EUT.

During WLAN SAR testing EUT is configured with the WLAN continuous TX tool, and the transmission duty factor was monitored on the spectrum analyzer with zero-span setting

Duty factor observed as below:

WLAN 2.4GHz 802.11b, 1Mbps:97.5%

For WLAN SAR testing, WLAN engineering testing software installed on the EUT can provide continuous transmitting RF signal.



## 8. Conducted RF Output Power

### 8.1 GSM Conducted Power

Band		Burst Average Power (dBm)			Frame-Average Power (dBm)		
GSM850	TX Channel	128	190	251	128	190	251
	Frequency(MHz)	824.2	836.4	848.8	824.2	836.4	848.8
	GSM (Slot 1)	32.23	32.24	32.18	23.20	23.21	23.15
	GPRS (Slot 1)	28.32	28.32	28.41	19.29	19.29	19.38
	GPRS (Slot 2)	29.51	29.54	29.52	23.49	23.52	23.50
	GPRS (Slot 3)	30.42	30.45	30.43	26.16	26.19	26.17
	GPRS (Slot 4)	31.46	31.49	31.39	28.45	28.48	28.38
GSM1900	TX Channel	512	661	810	512	661	810
	Frequency(MHz)	1850.2	1880	1909.8	1850.2	1880	1909.8
	GSM (Slot 1)	29.76	29.75	29.82	20.73	20.72	20.79
	GPRS (Slot 1)	25.72	25.76	25.74	16.69	16.73	16.71
	GPRS (Slot 2)	26.93	26.92	26.96	20.91	20.9	20.94
	GPRS (Slot 3)	27.83	27.87	27.94	23.57	23.61	23.68
	GPRS (Slot 4)	29.01	29.19	29.29	26.00	26.18	26.28

**Note:**

- Per KDB 447498 D01 v05r01, the maximum output power channel is used for SAR testing and for further SAR test reduction.

**Timeslot consignations:**

No. Of Slots	Slot 1	Slot 2	Slot 3	Slot 4
Slot Consignation	1Up4Down	2Up3Down	3Up2Down	4Up1Down
Duty Cycle	1:8	1:4	1:267	1:2
Crest Factor	-9.03dB	-6.02dB	-4.26dB	-3.01dB

## 8.2 WCDMA Conducted peak output Power

Item	band	WCDMA 850			WCDMA 1900		
	ARFCN	4132	4183	4233	9262	9400	9538
	subtest	dBm			dBm		
WCDMA		22.58	22.64	22.49	22.66	22.43	22.58
HSDPA	1	22.18	22.33	22.30	22.34	22.21	22.28
	2	22.10	22.18	22.18	22.17	22.23	22.42
	3	21.55	21.99	21.76	21.84	21.85	21.88
	4	21.66	21.83	21.83	21.77	22.38	21.84
HSUPA	1	22.20	22.14	22.20	21.85	22.09	21.71
	2	22.33	22.22	22.31	21.48	21.82	21.49
	3	22.37	22.19	22.37	22.33	22.17	22.07
	4	22.25	22.20	22.38	21.80	21.33	21.45
	5	22.09	22.31	22.19	22.13	22.11	22.13
Note:	The Conducted RF Output Power test of WCDMA /HSDPA /HSUPA was tested by power meter.						

### Note:

1. WCDMA SAR was tested under PMC 12.2kbps with HSPA Inactive per KDB Publication 941225 D01.HSPA SAR was not requires since the average output power of the HSPA subtests was not more than 0.25dB higher than the RMC level and SAR was less than 1.2W/kg.
2. It is expected by the manufacturer that MPR for some HSPA subtests may be up to 2dB more than specified by 3GPP, but also as low as 0dB according to the chipset implementation in this model.

### 8.3 WLAN 2.4GHz Band Conducted Power

Channel	Frequency (MHz)	WIFI Output Power(dBm)		
		802.11b	802.11g	802.11n-20
CH 01	2412	17.30	16.79	15.71
CH 06	2437	17.20	16.78	15.80
CH 11	2462	17.16	16.78	15.76

Channel	Frequency (MHz)	WIFI Output Power(dBm)
		802.11n-40
CH 03	2422	15.10
CH 06	2437	15.17
CH 09	2452	15.27

#### Note:

1. Per KDB 248227 D01 v01r02, choose the highest output power channel to test SAR and determine further SAR exclusion
2. For each frequency band, testing at higher data rates and higher order modulations is not required when the maximum average output power for each of these configurations is less than 1/4dB higher than those measured at lowest data rate
3. Per KDB 248227 D01 v01r02, 802.11g /11n-HT20/11n-HT40 is not required, for the maximum average output power is less than 1/4dB higher than measured on the corresponding 802.11b mode. Thus the SAR can be excluded.

**Bluetooth Conducted Power**

Channel	Frequency (MHz)	BT3.0 Output Power(dBm)		
		GFSK	$\Pi$ /4-DQPSK	8-DPSK
CH 0	2402	6.97	6.30	6.21
CH 39	2441	7.20	6.65	6.59
CH 78	2480	7.18	6.40	6.48

Channel	Frequency (MHz)	BT 4.0
CH 0	2402	-0.78
CH 20	2442	-0.35
CH 39	2480	-0.35

**Note:**

- Per KDB 447498 D01v05r01, the 1-g and 10-g SAR test exclusion thresholds for 100MHz to 6GHz at test separation distances  $\leq 50$ mm are determined by: [(max. power of channel, including tune-up tolerance, mW)/(min. test separation distance, mm)]  $\cdot [\sqrt{f}$  (GHz)]  $\leq 3.0$  for 1-g SAR and  $\leq 7.5$  for 10-g extremity SAR

- (1) f(GHz) is the RF channel transmit frequency in GHz
- (2) Power and distance are round to the nearest mW and mm before calculation
- (3) The result is rounded to one decimal place for comparison
- (4) If the test separation distance(antenna-user) is < 5mm, 5mm is used for excluded SAR calculation

Bluetooth Max Power (dBm)	mW	Test Distance (mm)	Frequency(GHz)	Exclusion Thresholds
8	6.310	5	2.4	1.955

- Per KDB 447498 D01v05r01 exclusion thresholds is 1.955<3, RF exposure evaluation is not required.





General Note:

1. Per KDB 447498 D01v05r01, the reported SAR is the measured SAR value adjusted for maximum tune-up tolerance.
  - a. Tune-up scaling Factor = tune-up limit power(mW)/EUT RF power(mW), where tune-up limit is the maximum rated power among all production units.
  - b. For SAR testing of WLAN signal with non-100% duty cycle , the measured SAR is scaled-up by the duty cycle scaling factor which is equal to “1/(duty cycle)”
  - c. For WWAN: Reported SAR(W/kg)=Measured SAR(W/kg)\*Tune-up Scaling Factor
  - d. For WLAN: Reported SAR(W/kg)=Measured SAR(W/kg)\*Duty Cycle scaling factor \* Tune-up scaling factor
2. Per KDB 447498 D01v05r01, for each exposure position, if the highest output channel reported SAR≤0.8W/kg, other channels SAR testing is not necessary.
3. For SAR testing of WLAN signal with non-100% duty cycle, the measured SAR is scaled-up by the duty cycle scaling factor which is equal to “1/(duty cycle)”
4. Body-worn SAR testing was performed at 10mm separation, and this distance is determined by the handset manufacturer that there will be body-worn accessories with the required minimum separation.
5. Per KDB 648474 D04v01r01,when the reported SAR for a body-worn accessory measured without a headset connected to the handset is ≤1.2W/kg, SAR testing with a headset connected to the handset is not required.
6. Scaling Factor calculation

Operation Mode	Channel	Max. Output Power(dBm)	Tune up Power in tolerance(dBm)	Scaling Factor
GSM 850	128	32.23	31.75±0.5	1.005
	190	32.24	31.75±0.5	1.002
	251	32.18	31.75±0.5	1.016
GPRS 850	128	31.46	31.02±0.5	1.014
	190	31.49	31.02±0.5	1.007
	251	31.39	31.02±0.5	1.030
GSM1900	512	29.76	29.35±0.5	1.021
	661	29.75	29.35±0.5	1.023
	810	29.82	29.35±0.5	1.007
GPRS1900	512	29.01	28.85±0.5	1.081
	661	29.19	28.85±0.5	1.038
	810	29.29	28.85±0.5	1.014
WCDMA850	4132	22.58	22.25±0.5	1.040
	4183	22.64	22.25±0.5	1.026
	4233	22.49	22.25±0.5	1.062
WCDMA1900	9262	22.66	22.25±0.5	1.021
	9400	22.43	22.25±0.5	1.076
	9538	22.58	22.25±0.5	1.040
802.11b	2412	17.30	17.00±0.5	1.047



BT 3.0 GFSK	2441	7.20	7.00±1	1.202
-------------	------	------	--------	-------

### Simultaneous SAR

Description of Simultaneous Transmit Capabilities				
No.	Transmitter Combinations	Scenario Supported or not	Supported for Mobile Hotspot or not	Explanation
1	GSM(Voice)+GSM(Data)	No	No	Note 1
2	WCDMA(Voice)+WCDMA(Data)	Yes	No	
3	GSM(Voice)+ WCDMA(Data)	No	No	
4	WCDMA(Voice)+GSM(Data)	No	No	
5	GSM(Voice)+ WCDMA(Voice)	No	No	
6	GSM(Voice)+Wifi(/BT)	Yes	Yes	Note 2
7	WCDMA(Voice) +Wifi(/BT)	Yes	Yes	
8	WCDMA(Voice)+WCDMA(Data)+ Wifi(/BT)	Yes	Yes	
9	GSM(Data)+wifi	Yes	Yes	
10	WCDMA(Data) +wifi	Yes	Yes	

Not applicable	Applicable	Head	Body-worn	Hotspot
1,3,4,5	2,6,7,8,9,10	2,6,7,8	2,6,7,8,9,10	6,7,8,9,10

Note :

1. EUT system architecture support simultaneous voice and data(except on WCDMA), multiple voice channels, or multiple data channels during a single session on the cellular net work.
2. Support for mobile hotspot operation.
3. When the user enables the personal wireless router functions for the handset, actual operations include simultaneous transmission of both the WiFi transmitter and another licensed transmitter. Both transmitter often do not transmit at the same transmitting frequency and thus cannot be evaluated for SAR under actual use conditions. The “Portable Hotspot” feature on the handset was not activated, to ensure the SAR measurements were evaluated for a single transmission frequency RF signal.
4. The hotspot SAR result may overlap with the body-worn accessory SAR requirements, per KDB 941225 D06, the more conservative configurations can be considered, thus excluding some unnecessary body-worn accessory SAR tests.
5. WCDMA supports voice and data transmission simultaneously.
6. Simultaneous Transmission SAR evaluation is not required for BT and WiFi, because the software mechanism have been incorporated to guarantee that the WLAN and Bluetooth transmitters would not simultaneously operate.

7. For Scenario No.2,7,8,10 , WCDMA and WiFi is tested separately, the WCDMA mode is test with 12.2kbps RMC and TPC set to all “1”, if maximum SAR for 12.2kbps RMC is  $\leq 75\%$  of the SAR limit(i.e. 1.2W/kg 1g) and maximum average output of each RF channel with HSDPA/HSUPA active is less than 1/4 dB Middle than that measured without HSDPA/HSUPA using 12.2kbps RMC, according to KDB 941224 D01v02, SAR is not required for this handset with HSPA capabilities.

8. For Scenario No.6 to 10, GSM, WCDMA, BT and WiFi is tested separately, the GSM mode do not supports voice and data transmission simultaneously, voic (GSM) and data(GPRS) is tested separately.

### Applicable Multiple Scenario Evaluation

Test Position	WCDMA&GSM SAR Max.(W/Kg)	Wifi SAR Max.(W/Kg)	Bluetooth Max.(W/Kg)	$\Sigma$ 1-gSARMAX.(W/Kg)	
				BT&Main Ant	Wifi&Main Ant
Head SAR	0.794	0.023	0.261	1.055	0.817
Body SAR	0.867	0.258	0.130	0.997	1.125

Simultaneous Transmission SAR evaluation is not required for Wifi and WCDMA&GSM, because the sum of 1g SAR Max is 1.125W/Kg<1.6 W/Kg for Wifi and WCDMA&GSM.

Simultaneous Transmission SAR evaluation is not required for BT and WCDMA&GSM, because the sum of 1g SAR Max is 1.055W/Kg<1.6 W/Kg for BT and WCDMA&GSM.

(According to KDB 447498D01v05,the sum of the Highest reported SAR of each antenna does not exceed the limit, simultaneous transmission SAR evaluation is not required.)

## 9 TEST RESULTS

### 9.1 Summary of Power Measurement Results

According the description above, the measurements against the head phantom were executed on the operation mode: GSM850 /1900MHz, WCDMA850/1900MHz and WIFI 802.11b, while the tests against the body-worn were carried out on the operation mode : GSM850/1900MHz, GPRS 850 /1900MHz, WCDMA850/1900MHz,WIFI 802.11b.



Table 1: SAR Values of GSM 850MHz Band

Temperature: 23.0~23.5°C, humidity: 62~64%.					
Test Positions		Channel /Frequency (MHz)	SAR(W/Kg), 1.6 (1g average)		
			SAR(W/Kg)1g Peak)	Scaled SAR(W/Kg),1g	
Right Side of Head	Cheek	128/824.2	0.421	0.423	
		190/836.6	0.434	0.435	
		251/848.8	0.412	0.419	
	Tilt 15 degrees	190/836.6	0.211	0.211	
Left Side of Head	Cheek	128/824.2	0.445	0.447	
		190/836.6	<b>0.452</b>	0.453	
		251/848.8	0.437	0.444	
	Tilt 15 degrees	190/836.6	0.192	0.192	
Body (10mm Separation)	GSM	Face Upward	128/824.2	0.608	0.611
			190/836.6	0.618	0.619
			251/848.8	0.587	0.597
		Back Upward	128/824.2	0.764	0.768
			190/836.6	<b>0.777</b>	0.779
			251/848.8	0.753	0.765
		Edge B	128/824.2	0.421	0.423
			190/836.6	0.432	0.433
			251/848.8	0.409	0.416
		Edge C	190/836.6	0.022	0.022
		Edge D	128/824.2	0.403	0.405
			190/836.6	0.414	0.415
	251/848.8		0.398	0.404	
	GPRS	Face Upward	128/824.2	0.584	0.592
			190/836.6	0.597	0.601
			251/848.8	0.578	0.596
		Back Upward	128/824.2	0.724	0.734
			190/836.6	<b>0.735</b>	0.740
			251/848.8	0.719	0.741
		Edge B	190/836.6	0.360	0.362
		Edge C	190/836.6	0.022	0.022
		Edge D	190/836.6	0.374	0.377



Table 2: SAR Values of GSM1900 MHz Band

Temperature: 23.0~23.5°C, humidity: 62~64%.					
Test Positions		Channel /Frequency (MHz)	SAR(W/Kg), 1.6 (1g average)		
			SAR(W/Kg)1g Peak)	Scaled SAR(W/Kg),1g	
Right Side of Head	Cheek	512/1850.2	0.521	0.532	
		661/1880.0	0.513	0.525	
		810/1909.8	<b>0.536</b>	0.540	
	Tilt 15 degrees	810/1909.8	0.095	0.096	
Left Side of Head	Cheek	810/1909.8	0.298	0.300	
	Tilt 15 degrees	810/1909.8	0.091	0.092	
Body (10mm Separation)	GSM	Face Upward	810/1909.8	0.238	0.240
		Back Upward	810/1909.8	0.381	0.384
		Edge B	810/1909.8	0.181	0.182
		Edge C	512/1850.2	0.421	0.430
			661/1880.0	0.418	0.428
			810/1909.8	<b>0.429</b>	0.432
		Edge D	810/1909.8	0.100	0.101
	GPRS	Face Upward	810/1909.8	0.219	0.222
		Back Upward	810/1909.8	0.276	0.280
		Edge B	810/1909.8	0.166	0.168
		Edge C	512/1850.2	0.430	0.465
			661/1880.0	0.421	0.437
			810/1909.8	<b>0.444</b>	0.450
		Edge D	810/1909.8	0.083	0.084



Table 3: SAR Values of WCDMA850

Temperature: 23.0~23.5°C, humidity: 62~64%.

Test Positions		Channel /Frequency (MHz)	SAR(W/Kg), 1.6 (1g average)	
			SAR(W/Kg)1g Peak	Scaled SAR(W/Kg),1g
Right Side of Head	Cheek	4183/836.6	0.270	0.277
	Tilt 15 degrees	4183/836.6	0.183	0.188
Left Side of Head	Cheek	4183/836.6	<b>0.292</b>	0.299
	Tilt 15 degrees	4183/836.6	0.151	0.155
Body (10mm Separation)	Face Upward	4132/826.4	0.409	0.425
		4183/836.6	0.422	0.433
		4233/846.6	0.397	0.421
	Back Upward	4132/826.4	0.597	0.621
		4183/836.6	<b>0.613</b>	0.629
		4233/846.6	0.572	0.607
	Edge B	4183/836.6	0.309	0.317
	Edge C	4183/836.6	0.022	0.023
	Edge D	4183/836.6	0.338	0.347

Table 4: SAR Values of WCDMA1900

Temperature: 23.0~23.5°C, humidity: 62~64%.				
Test Positions		Channel /Frequency (MHz)	SAR(W/Kg), 1.6 (1g average)	
			SAR(W/Kg)1g Peak)	Scaled SAR(W/Kg),1g
Right Side of Head	Cheek	9262/1852.4	<b>0.753</b>	0.769
		9400/1880.0	0.738	0.794
		9538/1907.6	0.745	0.775
	Tilt 15 degrees	9262/1852.4	0.142	0.145
Left Side of Head	Cheek	9262/1852.4	0.352	0.359
	Tilt 15 degrees	9262/1852.4	0.123	0.126
Body (10mm Separation)	Face Upward	9262/1852.4	0.553	0.565
		9400/1880.0	0.527	0.567
		9538/1907.6	0.534	0.555
	Back Upward	9262/1852.4	<b>0.849</b>	0.867
		9262/1852.4 Repeated result	<b>0.832</b>	0.849
		9400/1880.0	0.784	0.844
		9538/1907.6	0.791	0.823
	Edge B	9262/1852.4	0.237	0.242
	Edge C	9262/1852.4	0.653	0.667
		9400/1880.0	0.637	0.686
		9538/1907.6	0.642	0.668
	Edge D	9262/1852.4	0.142	0.145

Table 5:SAR Values of Wi-Fi 802.11b

Temperature: 23.0~23.5°C, humidity: 62~64%.				
Test Positions		Channel /Frequency (MHz)	SAR(W/Kg), 1.6 (1g average)	
			SAR(W/Kg)1g Peak	Scaled SAR(W/Kg),1g
Right Side of Head	Cheek	1/2412	<b>0.022</b>	0.023
	Tilt 15 degrees	1/2412	0.012	0.013
Left Side of Head	Cheek	1/2412	0.009	0.009
	Tilt 15 degrees	1/2412	0.005	0.005
802.11b(10mm Separation)	Edge A	1/2412	0.084	0.088
	Edge B	1/2412	0.228	0.239
	Face Upward	1/2412	0.114	0.119
	Back Upward	1/2412	<b>0.246</b>	0.258

## Note:

a) According to KDB 941225 D01, since the maximum average output of each RF channel with HSDPA/HSUPA active is less than that measured without HSDPA/HSUPA using 12.2 kbps RMC and the maximum SAR for 12.2 kbps RMC is less 1.2 W/kg, the measurement against HSDPA and HSUPA were ignored in this report.

b) When the 1-g SAR for the mid-band channel or the channel with the Highest output power satisfy the following conditions, testing of the other channels in the band is not required.(Per KDB 447498 D01 General RF Exposure Guidance v05)

- $\leq 0.8$  W/kg, when the transmission band is  $\leq 100$  MHz
- $\leq 0.6$  W/kg, when the transmission band is between 100 MHz and 200 MHz
- $\leq 0.4$  W/kg, when the transmission band is  $\geq 200$  MHz

## 8.2 Conclusion

Localized Specific Absorption Rate (SAR) of this portable wireless device has been measured in all cases requested by the relevant standards cited in Clause 6 of this report. Maximum localized SAR is **below** exposure limits specified in the relevant standards.



## 10 Measurement Uncertainty

No.	Uncertainty Component	Type	Uncertainty Value (%)	Probability Distribution	k	ci	Standard Uncertainty (%) $u_i(\%)$	Degree of freedom $V_{eff}$ or $v_i$
<b>Measurement System</b>								
1	– Probe Calibration	B	7	N	3	1	3.5	$\infty$
2	– Axial isotropy	B	4.7	R	$\sqrt{3}$	0.5	4.3	$\infty$
3	– Hemispherical Isotropy	B	9.4	R	$\sqrt{3}$	0.5	4.3	$\infty$
4	– Boundary Effect	B	11.0	R	$\sqrt{3}$	1	6.4	$\infty$
5	– Linearity	B	4.7	R	$\sqrt{3}$	1	2.7	$\infty$
6	– System Detection Limits	B	1.0	R	$\sqrt{3}$	1	0.6	$\infty$
7	– Readout Electronics	B	1.0	N	3	1	1.00	$\infty$
8	– Response Time	B	0.00	R	$\sqrt{3}$	1	0.00	$\infty$
9	– Integration Time	B	0.00	R	$\sqrt{3}$	1	0.00	$\infty$
10	– RF Ambient Conditions	B	3.0	R	$\sqrt{3}$	1	1.73	$\infty$
11	– Probe Position Mechanical tolerance	B	0.4	R	$\sqrt{3}$	1	0.2	$\infty$
12	– Probe Position with respect to Phantom Shell	B	2.9	R	$\sqrt{3}$	1	1.7	$\infty$
13	– Extrapolation, Interpolation and Integration Algorithms for Max. SAR evaluation	B	3.9	R	$\sqrt{3}$	1	2.3	$\infty$

Uncertainties of the DUT								
14	–Position of the DUT	A	4.8	N	3	1	4.8	5
15	–Holder of the DUT	A	7.1	N	3	1	7.1	5
16	–Output Power Variation –SAR drift measurement	B	5.0	R	$\sqrt{3}$	1	2.9	$\infty$
Phantom and Tissue Parameters								
17	–Phantom Uncertainty(shape and thickness tolerances)	B	1.0	R	$\sqrt{3}$	1	0.6	$\infty$
18	–Liquid Conductivity Target –tolerance	B	5.0	R	$\sqrt{3}$	0.6	1.7	$\infty$
19	–Liquid Conductivity –measurement Uncertainty)	B	0.23	N	3	1	0.23	9
20	–Liquid Permittivity Target tolerance	B	5.0	R	$\sqrt{3}$	0.6	1.7	$\infty$
21	–Liquid Permittivity –measurement uncertainty	B	0.46	N	3	1	0.46	$\infty$
<b>Combined Standard Uncertainty</b>				RSS			12.92	44.15
<b>Expanded uncertainty</b> (Confidence interval of 95 %)				K=2			25.84	

**11 MAIN TEST INSTRUMENTS**

<b>No</b>	<b>EQUIPMENT</b>	<b>TYPE</b>	<b>Series No.</b>	<b>Due Date</b>
1	System Simulator	E5515C	GB 47200710	2014/02/23
2	SAR Probe	SATIMO	SN 09/13 EP169	2014/04/04
3	Dipole	SID835	SN 09/13 DIP 0G835-217	2014/04/04
4	Dipole	SID1900	SN 09/13 DIP 1G900-218	2014/04/04
5	Dipole	SID2450	SN 09/13 DIP 2G450-220	2014/04/04
6	Vector Network Analyzer	ZVB8	A0802530	2014/06/13
7	Signal Generator	SMR27	A0304219	2014/06/10
8	Amplifier	Nucletudes	143060	2014/04/05
9	Power Meter	NRVS	1020.1809.02	2014/06/13
10	Power Sensor	NRV-Z4	100069	2014/06/10
11	Multimeter	Keithley-2000	4014020	2014/01/29
12	Device Holder	SATIMO	SN 09/13 MSH80	2014/04/04
13	SAM Phantom	SAM97	SN 09/13 SAM97	2014/04/04



**ANNEX A**  
**of**  
**CCIC Southern Electronic Product Testing (Shenzhen) Co., Ltd.**

**CONFORMANCE TEST REPORT FOR**  
**HUMAN EXPOSURE TO ELECTROMAGNETIC FIELDS**

**SET2014-00063**

**MFOURTEL MEXICO S.A. DE C.V.**

**GSM/WCDMA MOBILE PHONE**

**Type Name: M4 SS1050**

**Hardware Version: SLSPLUS-V1.0**

**Software Version: M4\_SS1050\_S03\_Ver200**

**Accreditation Certificate**

**This Annex consists of 2 pages**

**Date of Report: 2014-01-06**



**China National Accreditation Service for Conformity Assessment**

**LABORATORY ACCREDITATION CERTIFICATE**

**(Registration No. CNAS L1659 )**

**CCIC Southern Electronic Product Testing (Shenzhen) Co., Ltd.**

Building 28/29, Shigudong, Xili Industrial Area, Xili Street,

Nanshan District, Shenzhen, Guangdong, China

*is accredited to ISO/IEC 17025:2005 General Requirements for the Competence of Testing and Calibration Laboratories(CNAS-CL01 Accreditation Criteria for the Competence of Testing and Calibration Laboratories) for the competence of testing and calibration.*

*The scope of accreditation is detailed in the attached appendices bearing the same registration number as above. The appendices form an integral part of this certificate.*

Date of Issue: 2012-09-29  
Date of Expiry: 2015-09-28  
Date of Initial Accreditation: 1999-08-03  
Date of Update: 2012-09-29

Signed on behalf of China National Accreditation Service for Conformity Assessment

China National Accreditation Service for Conformity Assessment (CNAS) is authorized by Certification and Accreditation Administration of the People's Republic of China (CNCA) to operate the national accreditation schemes for conformity assessment. CNAS is the signatory to International Laboratory Accreditation Cooperation Multilateral Recognition Arrangement (ILAC MRA) and Asia Pacific Laboratory Accreditation Cooperation Multilateral Recognition Arrangement (APLAC MRA).

No.CNAS AL 2

0005210



**ANNEX B**  
**of**  
**CCIC-SET**

**CONFORMANCE TEST REPORT FOR**  
**HUMAN EXPOSURE TO ELECTROMAGNETIC FIELDS**

**SET2014-00063**

**MFOURTEL MEXICO S.A. DE C.V.**

**GSM/WCDMA MOBILE PHONE**

**Type Name: M4 SS1050**

**Hardware Version: SLSPLUS-V1.0**

**Software Version: M4\_SS1050\_S03\_Ver200**

**TEST LAYOUT**

**This Annex consists of 7 pages**

**Date of Report: 2014-01-06**

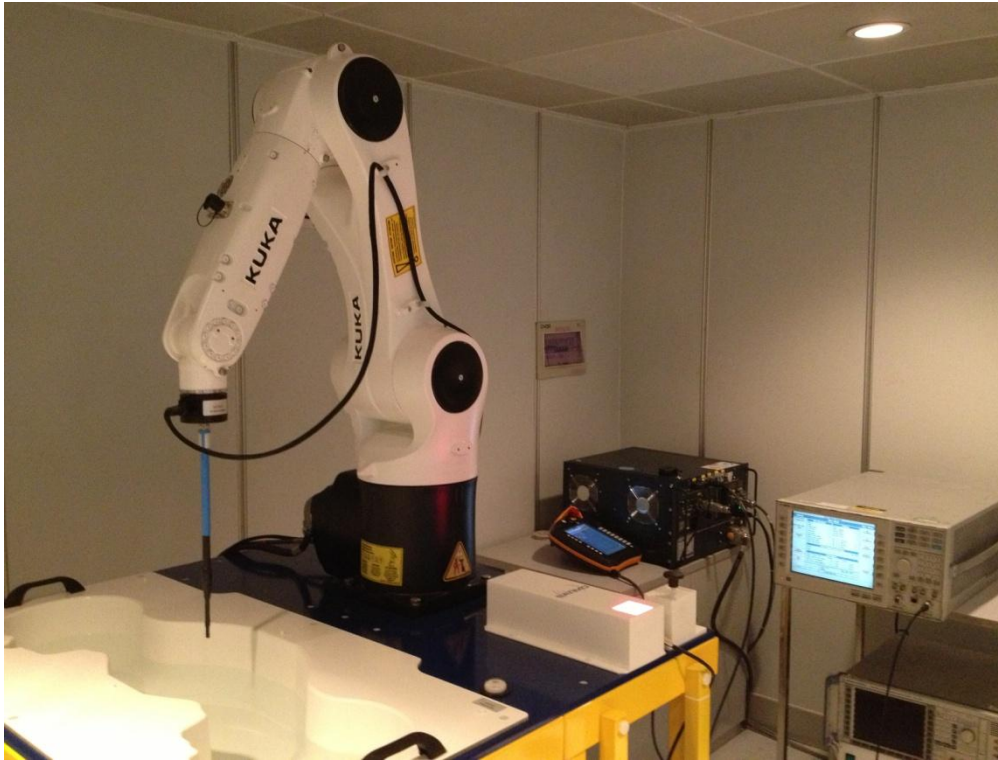

**Fig.1 COMO SAR Test System**

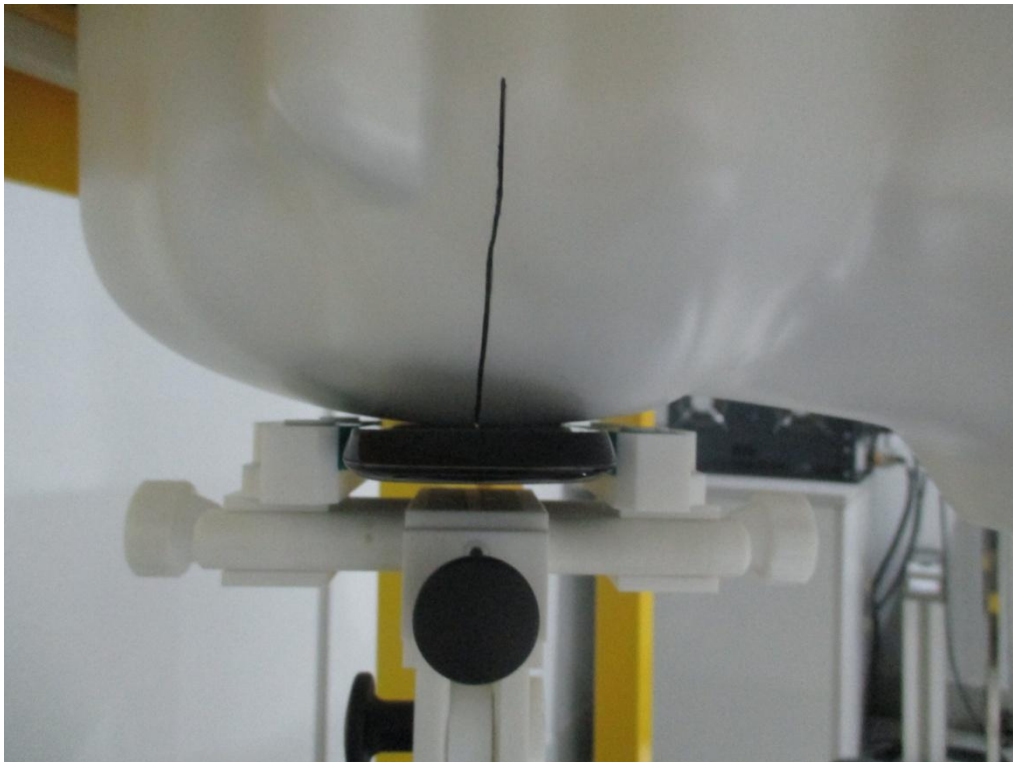

**Fig.2 Right\_Cheek**

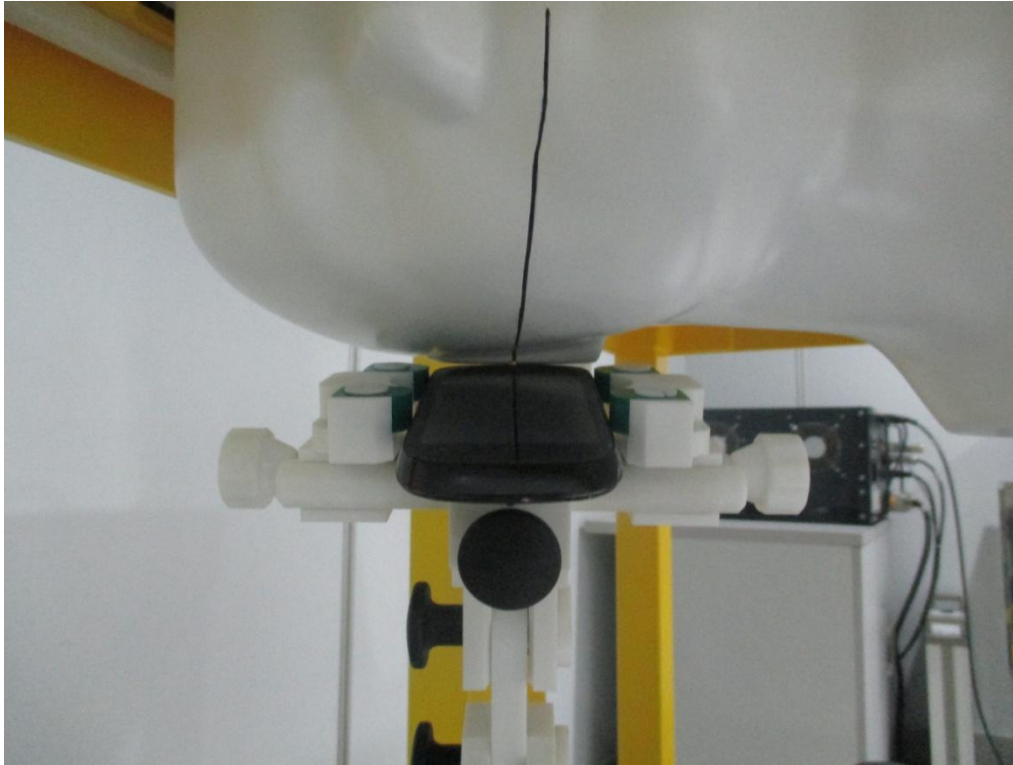

**Fig.3 Right\_Tilt**

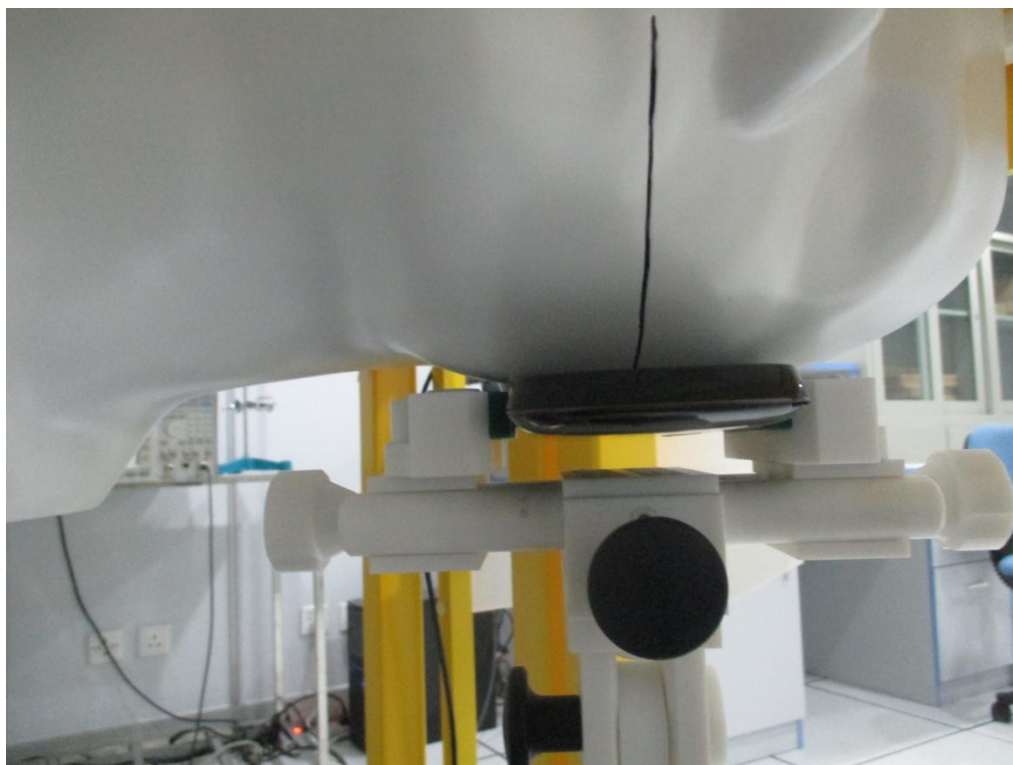
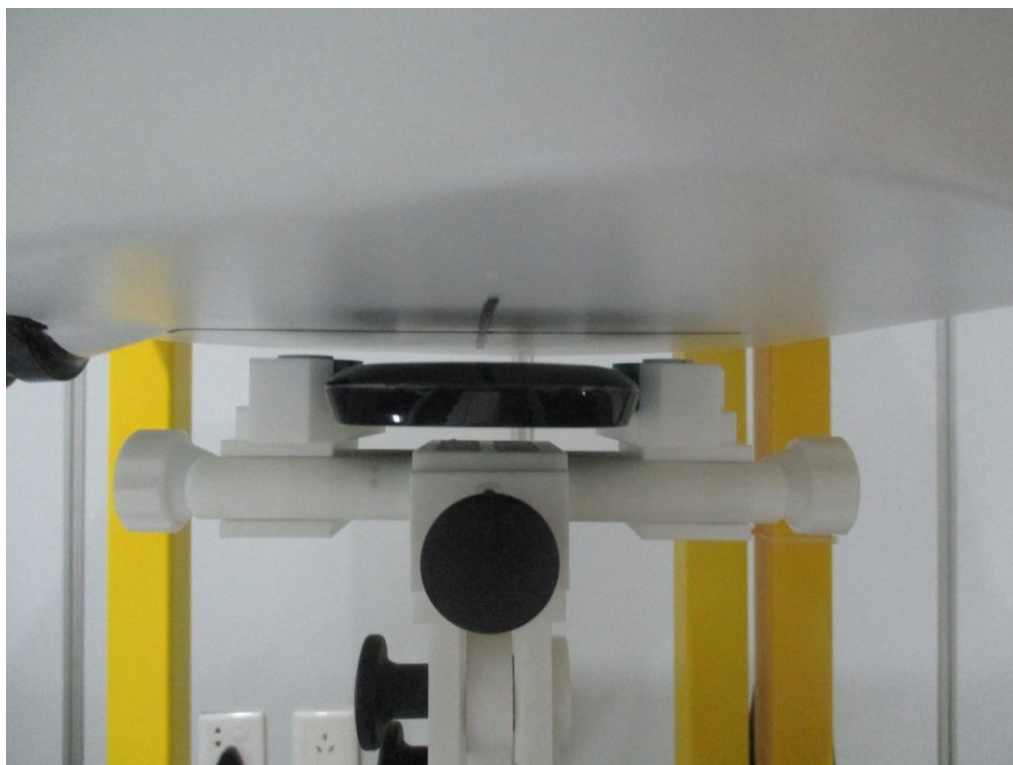

**Fig.4 Left Cheek**

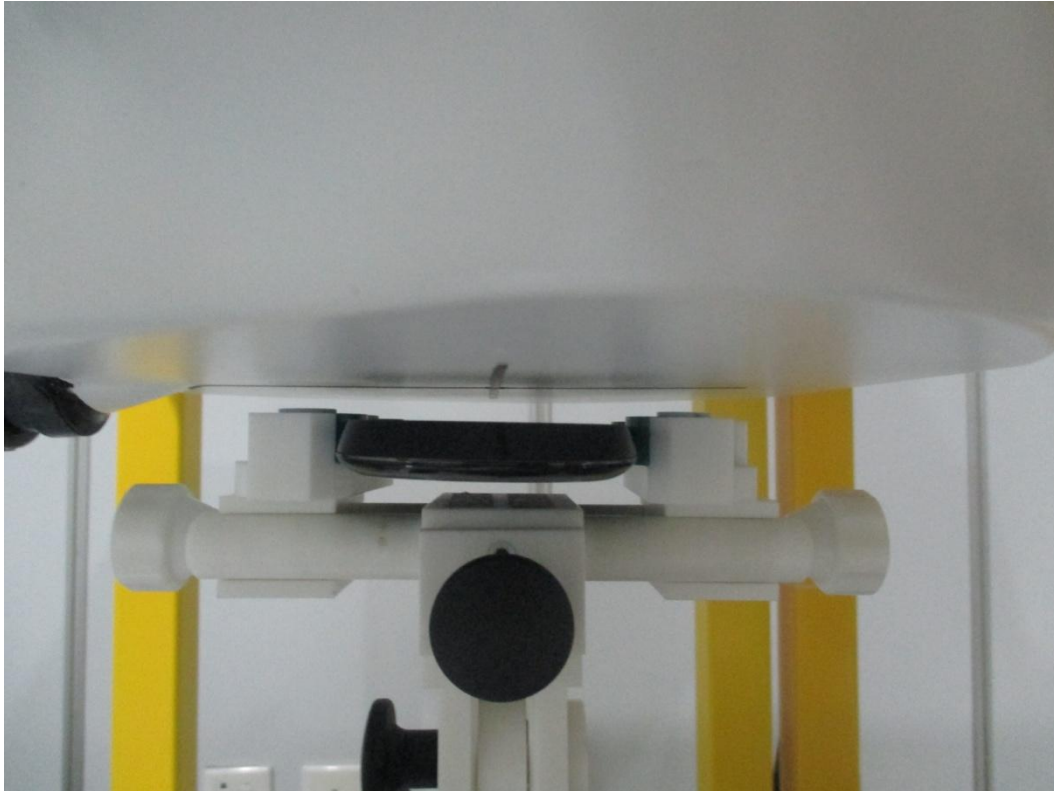



**Fig.5 Left\_Tilt**



**Fig.6 Body(Back upside,10mm seperation)**



**Fig.7 Body(Face upside,10mm separation)**

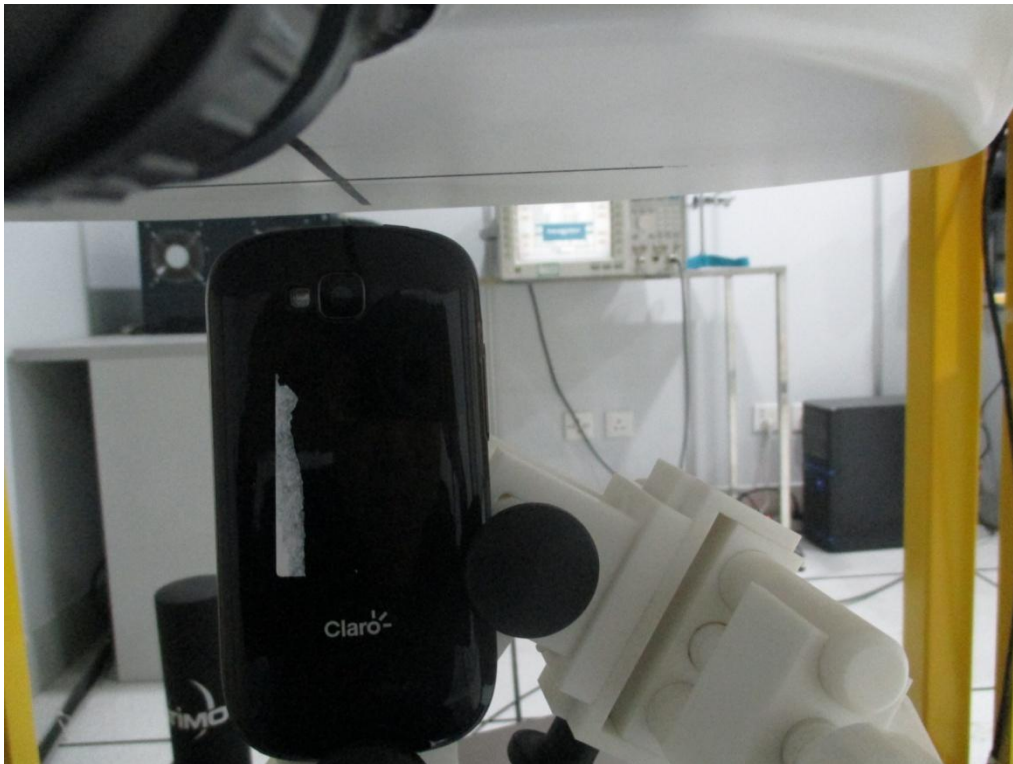

**Fig.8 Body Edge A(UP,10mm separation)**



**Fig.9 Body Edge B(Left upside,10mm separation)**

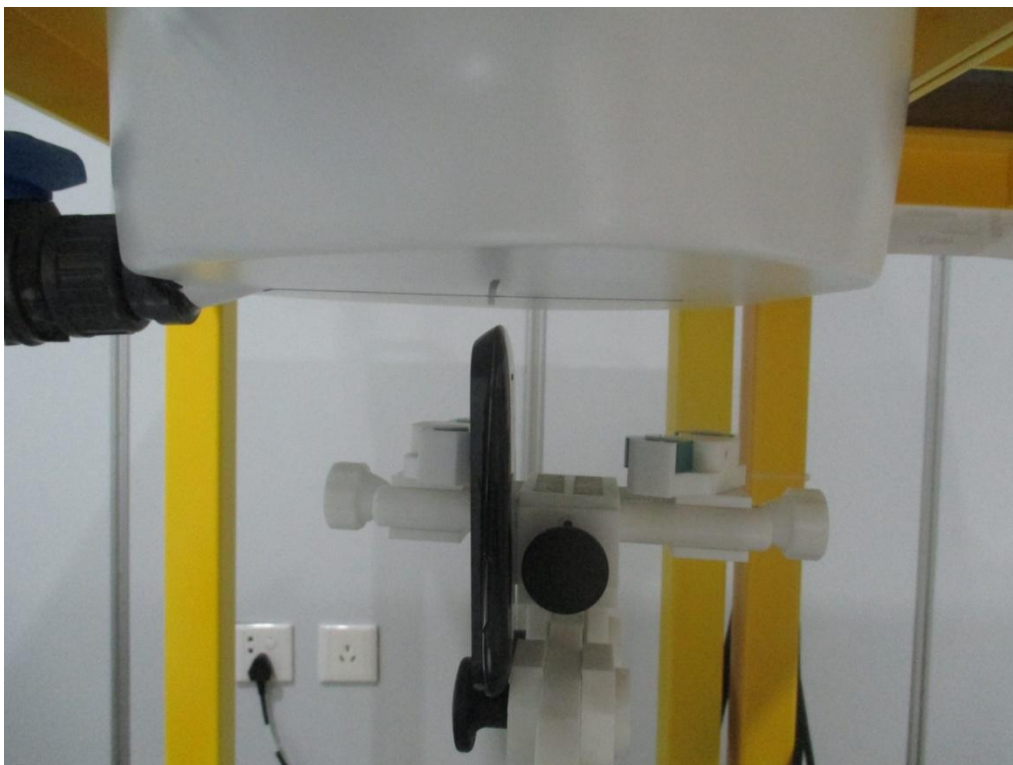

**Fig.10 Body Edge C(Down,10mm separation)**



**Fig.11 Body Edge D(Right upside,10mm separation)**



**ANNEX C**

**of**

**CCIC-SET**

**CONFORMANCE TEST REPORT FOR**

**HUMAN EXPOSURE TO ELECTROMAGNETIC FIELDS**

**SET2014-00063**

**GSM/WCDMA MOBILE PHONE**

**Type Name: M4 SS1050**

**Hardware Version: SLSPLUS-V1.0**

**Software Version: M4\_SS1050\_S03\_Ver200**

**Sample Photographs**

**This Annex consists of 2 pages**

**Date of Report: 2014-01-06**

### 1. Appearance



**Appearance and size (obverse)**



**Appearance and size (reverse)**



**ANNEX D**  
**of**  
**CCIC-SET**

**CONFORMANCE TEST REPORT FOR**  
**HUMAN EXPOSURE TO ELECTROMAGNETIC FIELDS**

**SET2014-00063**

**GSM/WCDMA MOBILE PHONE**

**Type Name: M4 SS1050**

**Hardware Version: SLSPLUS-V1.0**

**Software Version: M4\_SS1050\_S03\_Ver200**

**System Performance Check Data and Highest SAR Plots**

**This Annex consists of 40 pages**

**Date of Report: 2014-01-06**

**GRAPH TEST RESULTS**

<b>BAND</b>	<b>PAPAMETERS</b>
<b>GSM 850</b>	Left Head with Cheek device position on Middle Channel in GSM mode Flat Plane with Back Body device position on Middle Channel in GSM mode Flat Plane with Back Body device position on Middle Channel in GPRS mode
<b>GSM 1900</b>	Right Head with Cheek device position on High Channel in GSM mode Flat Plane with Edge C Body device position on High Channel in GSM mode Flat Plane with Edge C Body device position on High Channel in GPRS mode
<b>WCDMA 850</b>	Left Head with Cheek device position on Middle Channel in WCDMA mode Flat Plane with Back Body device position on Middle Channel in WCDMA mode
<b>WCDMA 1900</b>	Right Head with Cheek device position on Low Channel in WCDMA mode Flat Plane with Back Body device position on Low Channel in WCDMA mode Flat Plane with Back Body device position on Low Channel in WCDMA mode(repeat)
<b>WIFI 802.11b</b>	Right Head with Cheek device position on Low Channel in DSSS mode Flat Plane with Back Body device position on Low Channel in DSSS mode



## System Performance Check (Head, 835MHz)

Type: Phone measurement (Complete)

Area scan resolution: dx=8mm,dy=8mm

Zoom scan resolution: dx=8mm, dy=8mm, dz=5mm

Date of measurement:26/12/2013

Measurement duration: 12 minutes 57 seconds

### A. Experimental conditions.

<b>Phantom File</b>	surf_sam_plan.txt
<b>Phantom</b>	Flat Plane
<b>Device Position</b>	
<b>Band</b>	835MHz
<b>Channels</b>	
<b>Signal</b>	CW

### B. SAR Measurement Results

#### Band SAR

<b>Frequency (MHz)</b>	835.000000
<b>Relative permittivity (real part)</b>	41.382417
<b>Relative permittivity</b>	15.067700
<b>Conductivity (S/m)</b>	0.941371
<b>Power drift (%)</b>	-0.420000
<b>Ambient Temperature:</b>	23.2 °C
<b>Liquid Temperature:</b>	23.5 °C
<b>ConvF:</b>	5.52
<b>Duty factor:</b>	1:1

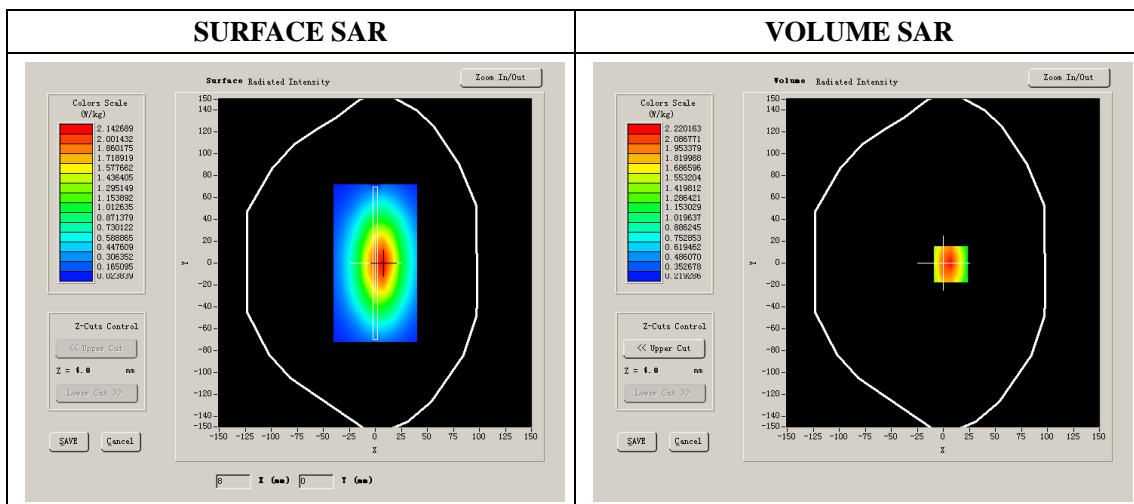

**Maximum location: X=7.00, Y=-1.00**

<b>SAR 10g (W/Kg)</b>	1.812316
<b>SAR 1g (W/Kg)</b>	2.483256

### Z Axis Scan

Z (mm)	0.00	4.00	9.00	14.00	19.00	24.00	29.00
SAR (W/Kg)	0.0000	2.5212	1.6625	1.1452	0.8068	0.5876	0.4154

**SAR, Z Axis Scan (X = 7, Y = -1)**

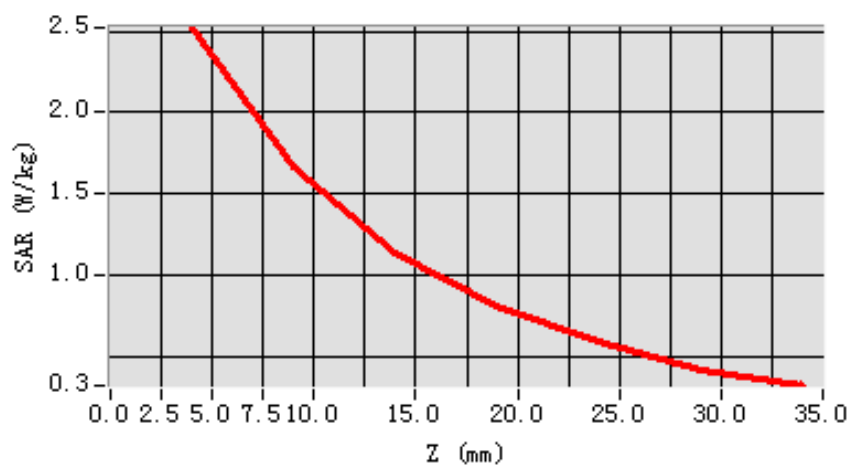

**3D scene shot**

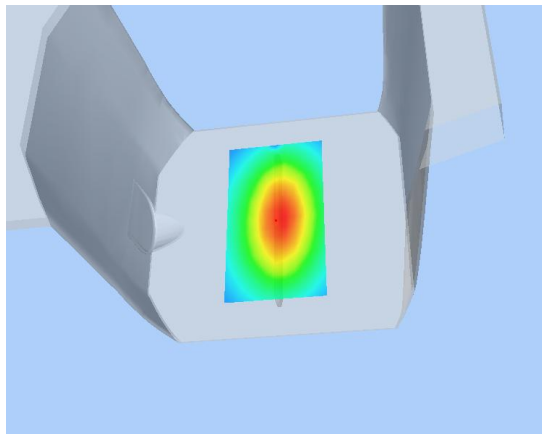

**Hot spot position**

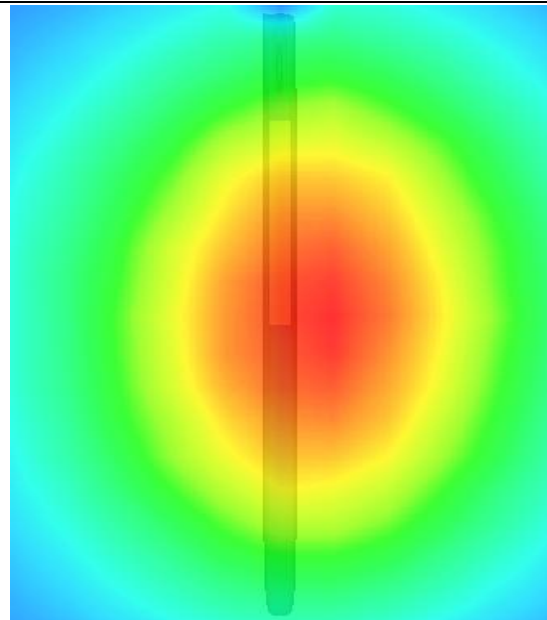

## System Performance Check (Head, 1900MHz)

Type: Phone measurement (Complete)

Area scan resolution: dx=8mm,dy=8mm

Zoom scan resolution: dx=8mm, dy=8mm, dz=5mm

Date of measurement: 26/12/2013

Measurement duration: 12 minutes 57 seconds

### A. Experimental conditions.

<b>Phantom File</b>	surf_sam_plan.txt
<b>Phantom</b>	Flat Plane
<b>Device Position</b>	
<b>Band</b>	1900MHz
<b>Channels</b>	
<b>Signal</b>	CW

### B. SAR Measurement Results

#### Band SAR

<b>Frequency (MHz)</b>	1900.000000
<b>Relative permittivity (real part)</b>	39.981243
<b>Relative permittivity</b>	15.067700
<b>Conductivity (S/m)</b>	1.4198057
<b>Power drift (%)</b>	-0.440000
<b>Ambient Temperature:</b>	22.3 °C
<b>Liquid Temperature:</b>	22.6 °C
<b>ConvF:</b>	5.48
<b>Duty factor:</b>	1:1

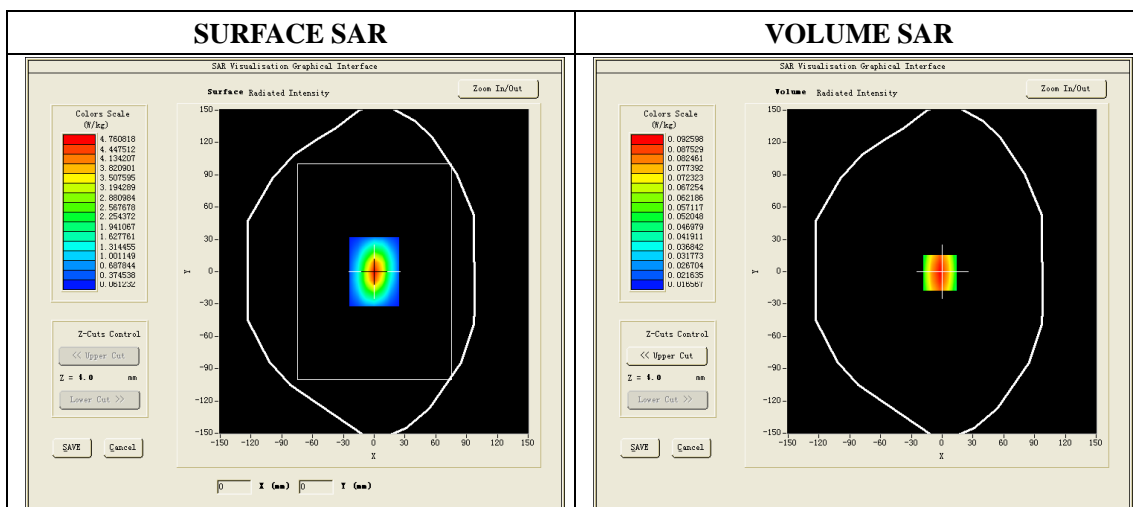

**Maximum location: X=6.00, Y=0.00**

<b>SAR 10g (W/Kg)</b>	5.165122
<b>SAR 1g (W/Kg)</b>	9.783416

### Z Axis Scan

<b>Z (mm)</b>	<b>0.00</b>	<b>4.00</b>	<b>9.00</b>	<b>14.00</b>	<b>19.00</b>	<b>24.00</b>	<b>29.00</b>
<b>SAR (W/Kg)</b>	<b>0.0000</b>	<b>10.6419</b>	<b>6.0043</b>	<b>3.7297</b>	<b>2.2606</b>	<b>1.5119</b>	<b>0.9792</b>

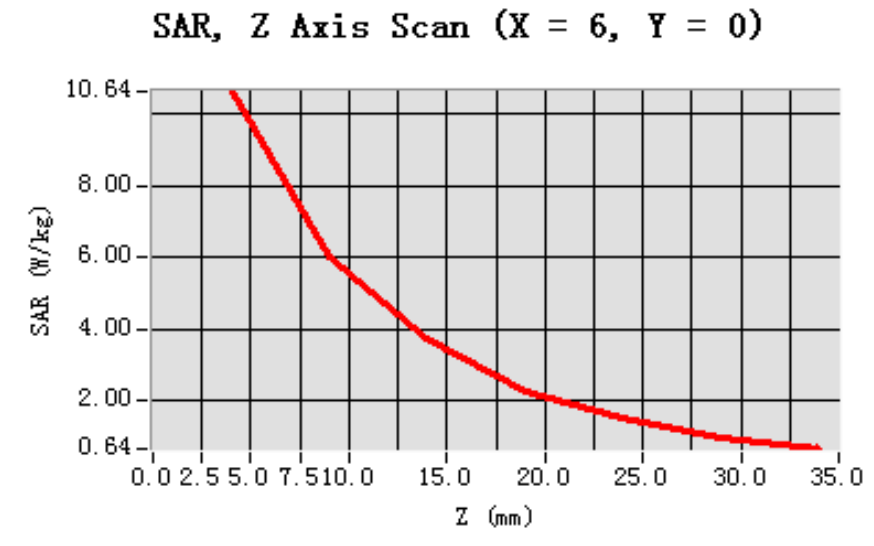
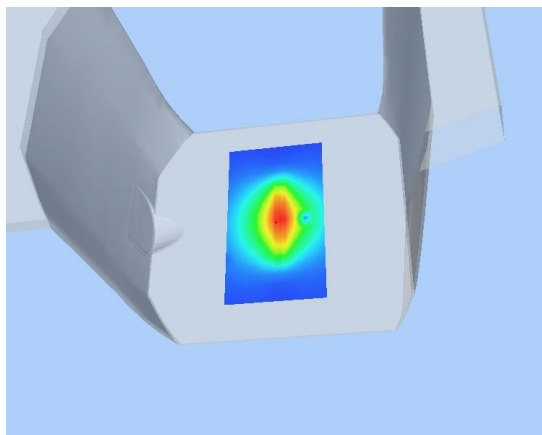
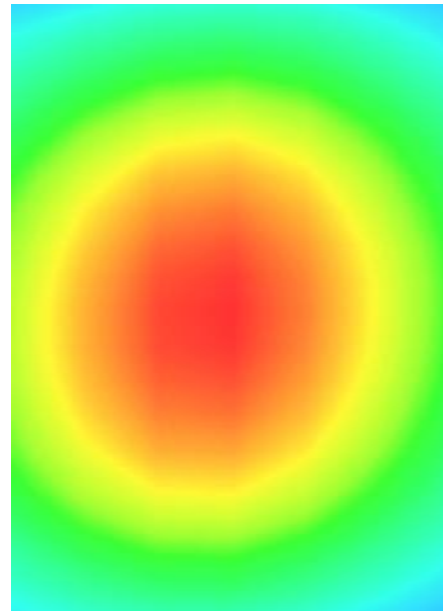
**3D scene shot**

**Hot spot position**

## System Performance Check (Head, 2450MHz)

Type: Phone measurement (Complete)

Area scan resolution: dx=8mm,dy=8mm

Zoom scan resolution: dx=8mm, dy=8mm, dz=5mm

Date of measurement: 26/12/2013

Measurement duration: 15 minutes 24 seconds

### A. Experimental conditions.

<b>Phantom File</b>	surf_sam_plan.txt
<b>Phantom</b>	Validation plane
<b>Device Position</b>	Dipole
<b>Band</b>	2450MHz
<b>Channels</b>	
<b>Signal</b>	CW

### B. SAR Measurement Results

#### Band SAR

<b>Frequency (MHz)</b>	2450.000000
<b>Relative permittivity (real part)</b>	38.98
<b>Relative permittivity</b>	13.19
<b>Conductivity (S/m)</b>	1.79
<b>Power Drift (%)</b>	0.160000
<b>ConvF:</b>	4.80
<b>Duty factor:</b>	1:1

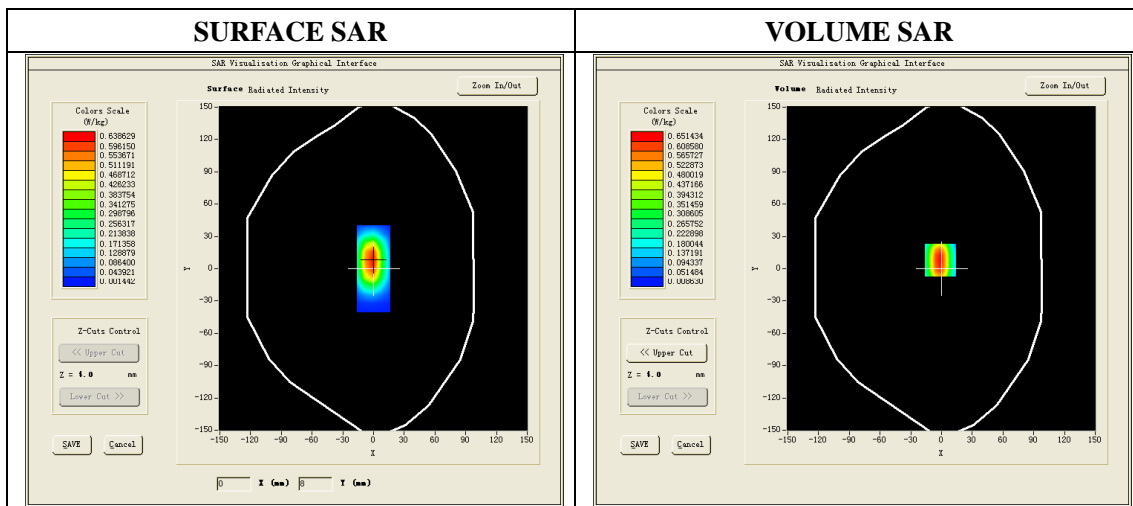

**Maximum location: X=0.00, Y=8.00**

<b>SAR 10g (W/Kg)</b>	5.902154
<b>SAR 1g (W/Kg)</b>	13.152314

### Z Axis Scan

Z (mm)	0.00	4.00	9.00	14.00	19.00
SAR (W/Kg)	20.3890	13.160218	3.8625	0.8019	0.2333

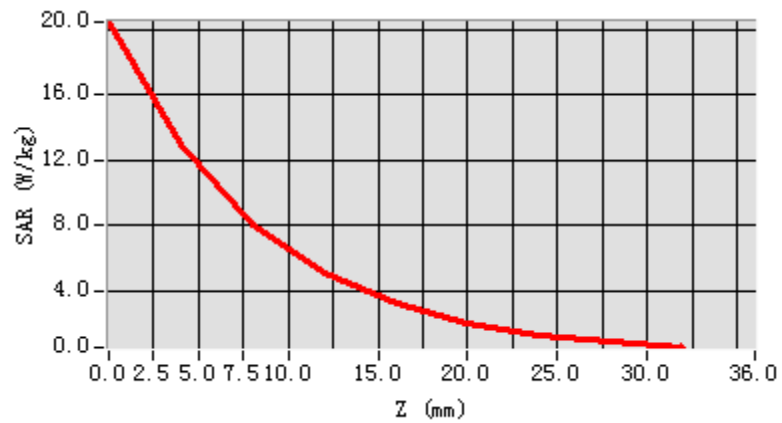
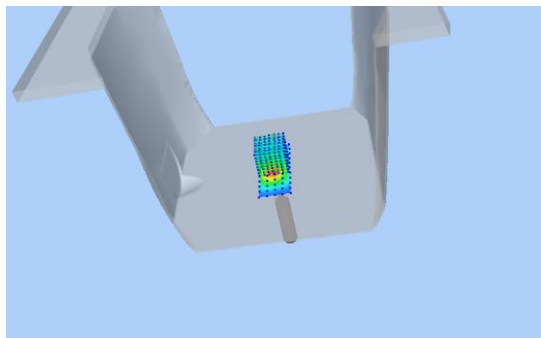
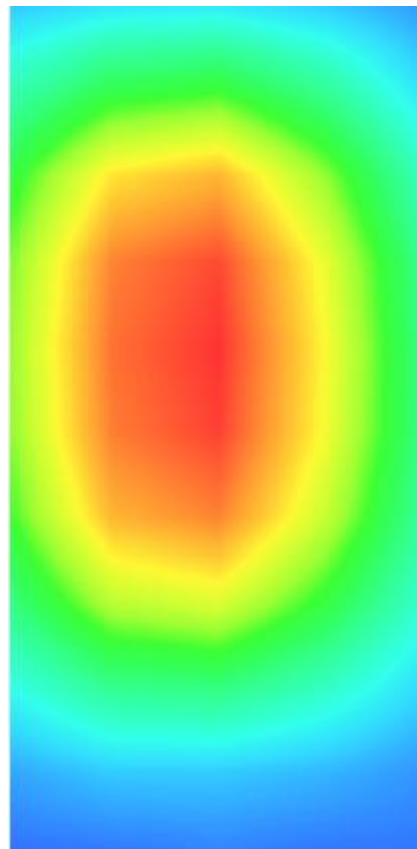
**3D scene shot**

**Hot spot position**



## System Performance Check (Body, 835MHz)

Type: Phone measurement (Complete)

Area scan resolution: dx=8mm,dy=8mm

Zoom scan resolution: dx=8mm, dy=8mm, dz=5mm

Date of measurement: 27/12/2013

Measurement duration: 13 minutes 12 seconds

### A. Experimental conditions.

<b>Phantom File</b>	surf_sam_plan.txt
<b>Phantom</b>	Flat Plane
<b>Device Position</b>	
<b>Band</b>	835MHz
<b>Channels</b>	
<b>Signal</b>	CW

### B. SAR Measurement Results

#### Band SAR

<b>Frequency (MHz)</b>	835.000000
<b>Relative permittivity (real part)</b>	55.479356
<b>Relative permittivity</b>	21.709999
<b>Conductivity (S/m)</b>	0.984352
<b>Power drift (%)</b>	-0.190000
<b>Ambient Temperature:</b>	23.2 °C
<b>Liquid Temperature:</b>	23.5 °C
<b>ConvF:</b>	5.67
<b>Duty factor:</b>	1:1

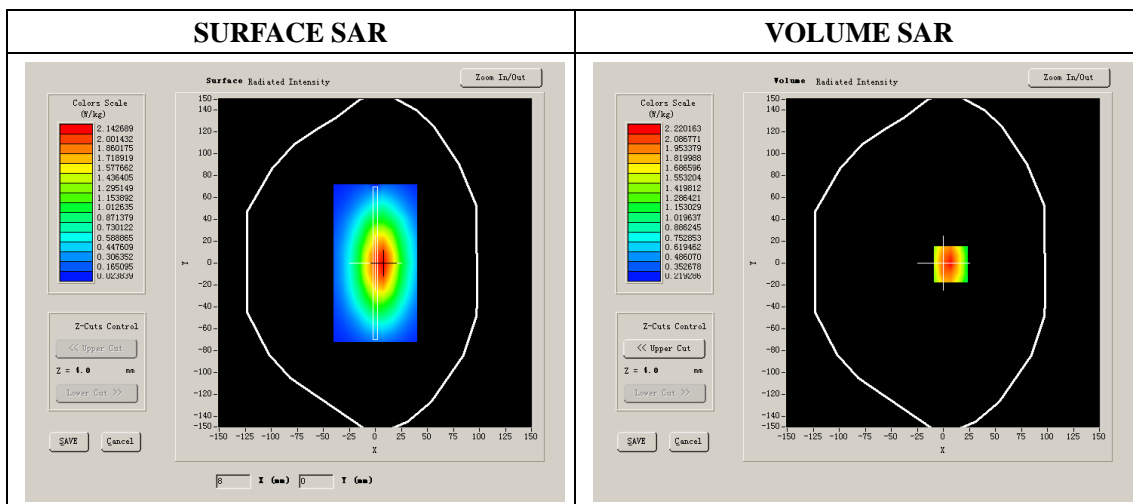

**Maximum location: X=7.00, Y=-1.00**

<b>SAR 10g (W/Kg)</b>	1.732324
<b>SAR 1g (W/Kg)</b>	2.421245

### Z Axis Scan

Z (mm)	0.00	4.00	9.00	14.00	19.00	24.00	29.00
SAR (W/Kg)	0.0000	2.5209	1.6629	1.1437	0.8075	0.5889	0.4143

**SAR, Z Axis Scan (X = 7, Y = -1)**

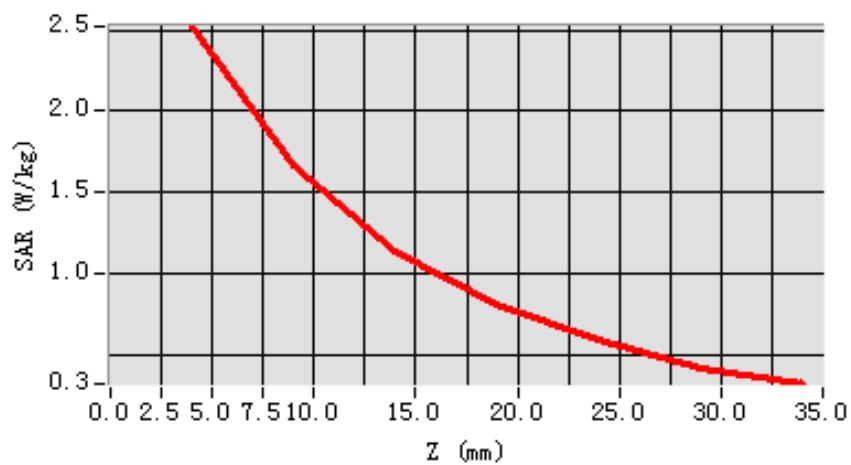

**3D scene shot**

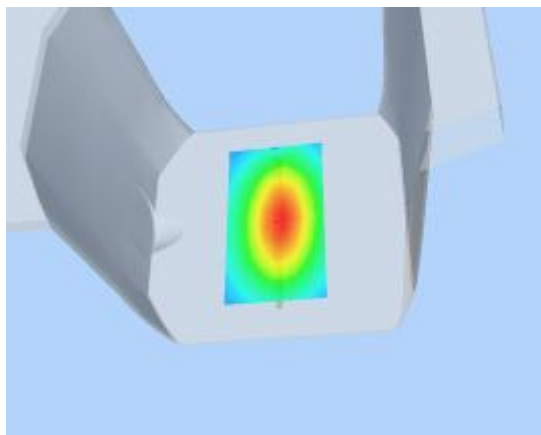

**Hot spot position**

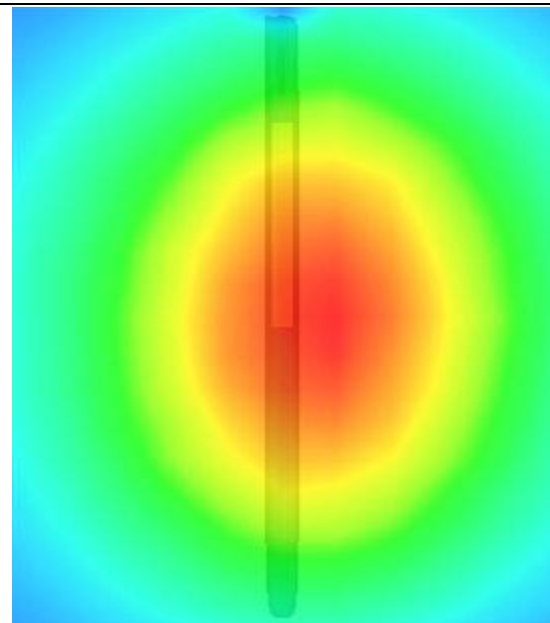



## System Performance Check (Body, 1900MHz)

Type: Phone measurement (Complete)

Area scan resolution: dx=8mm,dy=8mm

Zoom scan resolution: dx=8mm, dy=8mm, dz=5mm

Date of measurement: 27/12/2013

Measurement duration: 13 minutes 12 seconds

### A. Experimental conditions.

<b>Phantom File</b>	surf_sam_plan.txt
<b>Phantom</b>	Validation plane
<b>Device Position</b>	
<b>Band</b>	1900MHz
<b>Channels</b>	
<b>Signal</b>	CW

### B. SAR Measurement Results

#### Band SAR

<b>Frequency (MHz)</b>	1900.000000
<b>Relative permittivity (real part)</b>	53.570213
<b>Relative permittivity</b>	12.991650
<b>Conductivity (S/m)</b>	1.512476
<b>Power Drift (%)</b>	0.080000
<b>Ambient Temperature:</b>	22.0 °C
<b>Liquid Temperature:</b>	21.8 °C
<b>ConvF:</b>	5.64
<b>Duty factor:</b>	1:1

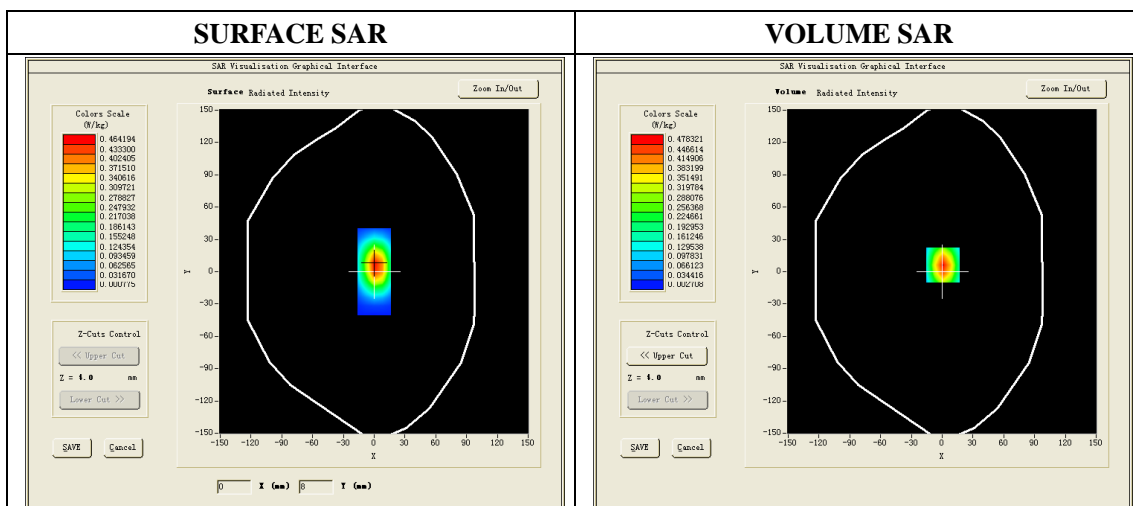

**Maximum location: X=1.00, Y=6.00**

<b>SAR 10g (W/Kg)</b>	5.212416
<b>SAR 1g (W/Kg)</b>	9.981023

### Z Axis Scan

Z (mm)	0.00	4.00	9.00	14.00	19.00
SAR (W/Kg)	0.0000	10.0613	5.7282	3.6529	2.0314

**SAR, Z Axis Scan (X = 1, Y = 6)**

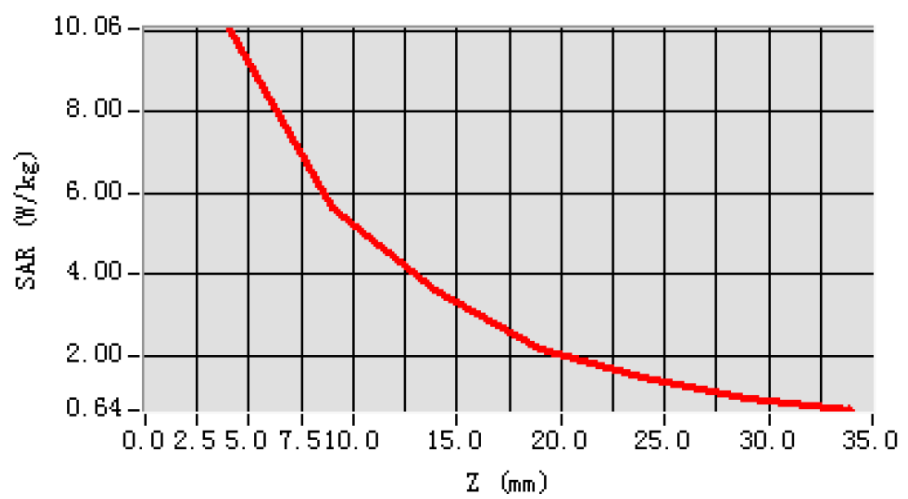

**3D scene shot**

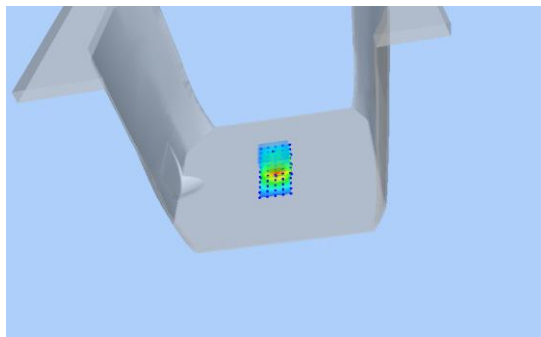

**Hot spot position**

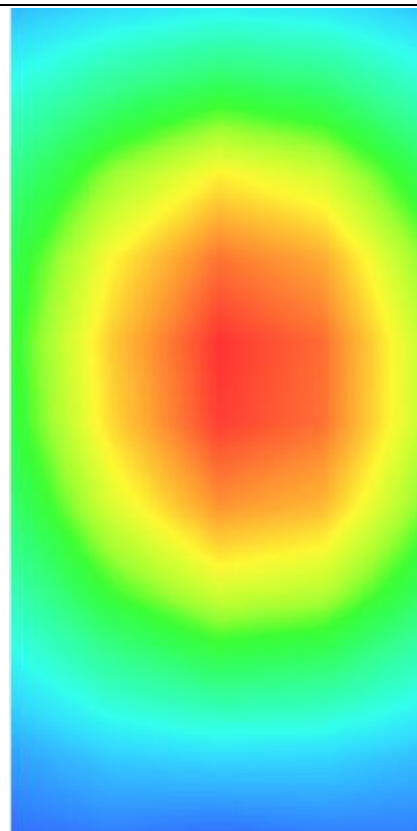

## System Performance Check (Body, 2450MHz)

Type: Phone measurement (Complete)

Area scan resolution: dx=8mm,dy=8mm

Zoom scan resolution: dx=8mm, dy=8mm, dz=5mm

Date of measurement: 27/12/2013

Measurement duration: 13 minutes 21 seconds

### A. Experimental conditions.

<b>Phantom File</b>	surf_sam_plan.txt
<b>Phantom</b>	Validation plane
<b>Device Position</b>	Dipole
<b>Band</b>	2450MHz
<b>Channels</b>	
<b>Signal</b>	CW

### B. SAR Measurement Results

#### Band SAR

<b>Frequency (MHz)</b>	2450.000000
<b>Relative permittivity (real part)</b>	52.58
<b>Relative permittivity</b>	13.024236
<b>Conductivity (S/m)</b>	1.972160
<b>Power Drift (%)</b>	-0.070000
<b>Duty factor:</b>	1:1
<b>ConvF:</b>	4.90

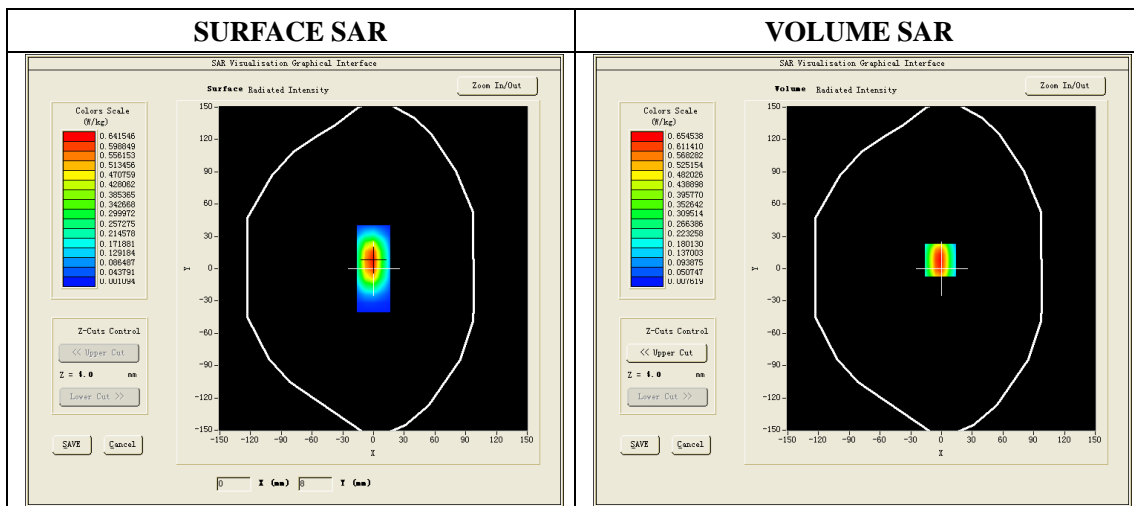

**Maximum location: X=0.00, Y=8.00**

<b>SAR 10g (W/Kg)</b>	5.921063
<b>SAR 1g (W/Kg)</b>	13.132613

### Z Axis Scan

Z (mm)	0.00	4.00	9.00	14.00	19.00
SAR (W/Kg)	0.0000	13.3122	3.8625	0.8019	0.2333

**SAR, Z Axis Scan (X = 0, Y = 8)**

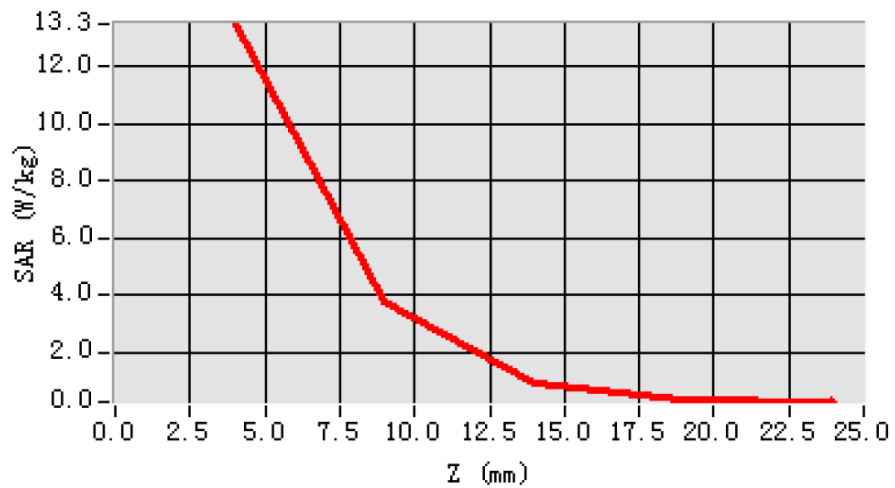

**3D scene shot**

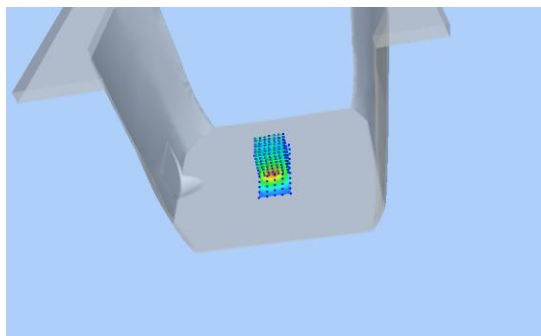

**Hot spot position**

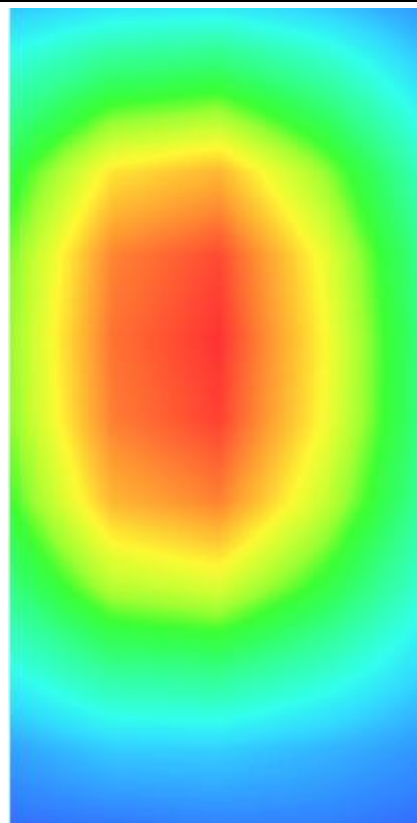

# GSM850, Left Cheek, Middle

Type: Phone measurement (Very fast, 11 points in the volume)

Date of measurement: 26/12/2013

Measurement duration: 6 minutes 35 seconds

Mobile Phone IMEI number: --

## A. Experimental conditions.

Area Scan	sam_direct_droit2_surf8mm.txt
ZoomScan	5x5x7,dx=8mm dy=8mm dz=5mm,Very fast
Phantom	Left head
Device Position	Cheek
Band	GSM850
Channels	190
Signal	GSM (Duty cycle: 1:8)

## B. SAR Measurement Results

Frequency (MHz)	836.6
Relative permittivity (real part)	41.382417
Relative permittivity (imaginary part)	15.067700
Conductivity (S/m)	0.941371
Variation (%)	-0.020000
ConvF:	5.52

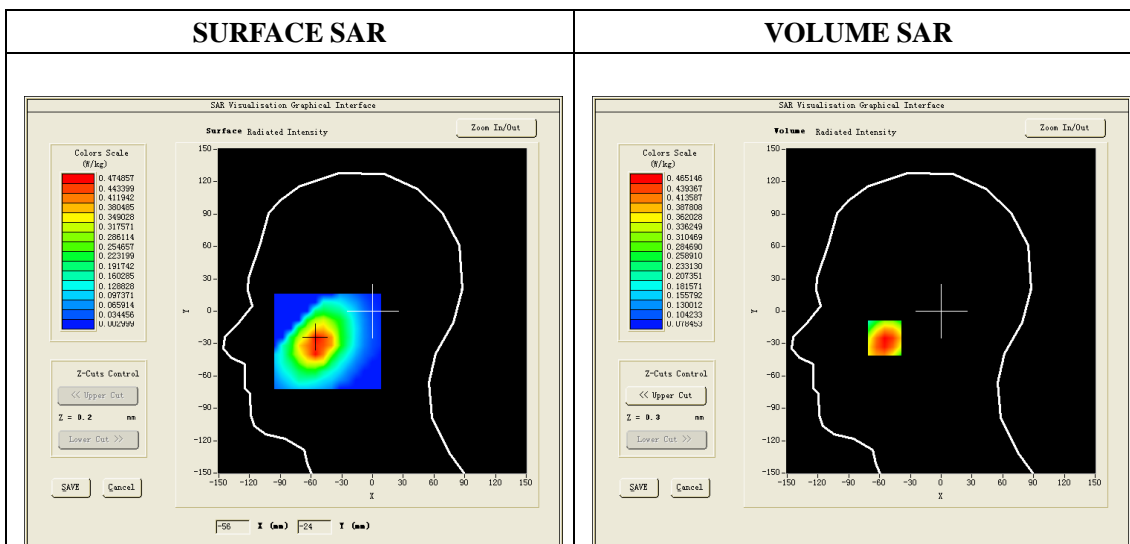

**Maximum location: X=-55.00, Y=-25.00**

SAR 10g (W/Kg)	0.341847
SAR 1g (W/Kg)	0.451925

**Z axis scan**

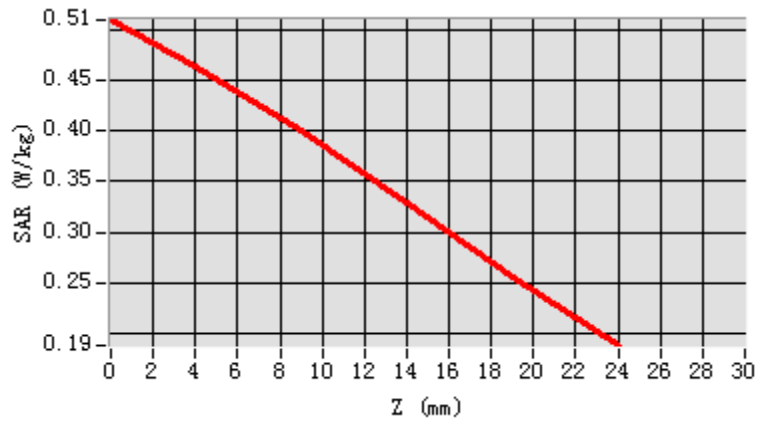

**3D screen shot**

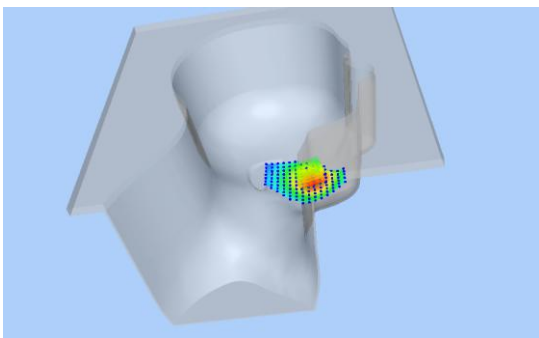

**Hot spot position**

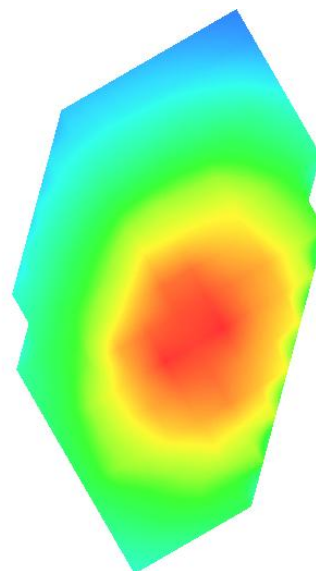

# GSM850, Back, Middle

Type: Phone measurement (Very fast, 11 points in the volume)

Date of measurement: 27/12/2013

Measurement duration: 7 minutes 32 seconds

Mobile Phone IMEI number: --

## A. Experimental conditions.

Area Scan	surf_sam_plan.txt
ZoomScan	5x5x7,dx=8mm dy=8mm dz=5mm,Very fast
Phantom	Validation plane
Device Position	Back
Band	GSM850
Channels	190
Signal	GSM(Duty cycle: 1:8)

## B. SAR Measurement Results

Frequency (MHz)	836.6
Relative permittivity (real part)	55.479356
Relative permittivity (imaginary part)	21.709999
Conductivity (S/m)	0.984352
Variation (%)	0.971708
ConvF:	5.67

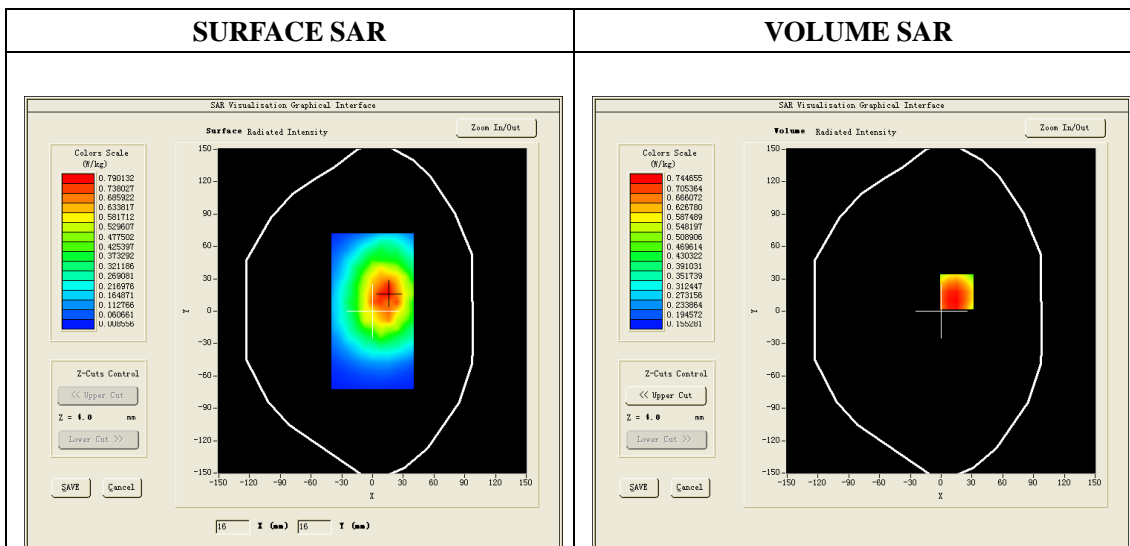

**Maximum location: X=15.00, Y=18.00**

SAR 10g (W/Kg)	0.565919
SAR 1g (W/Kg)	0.777212

### Z axis scan

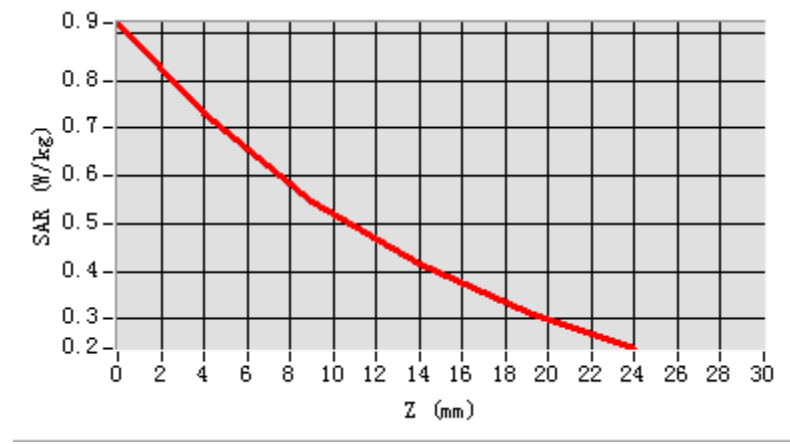

### 3D screen shot

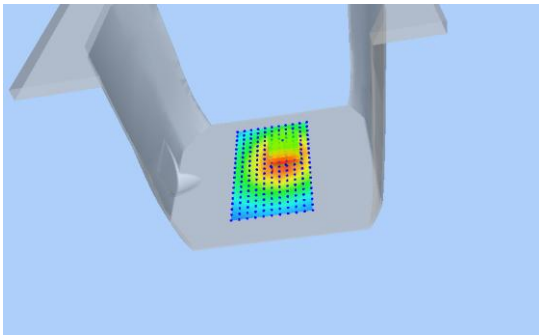

### Hot spot position

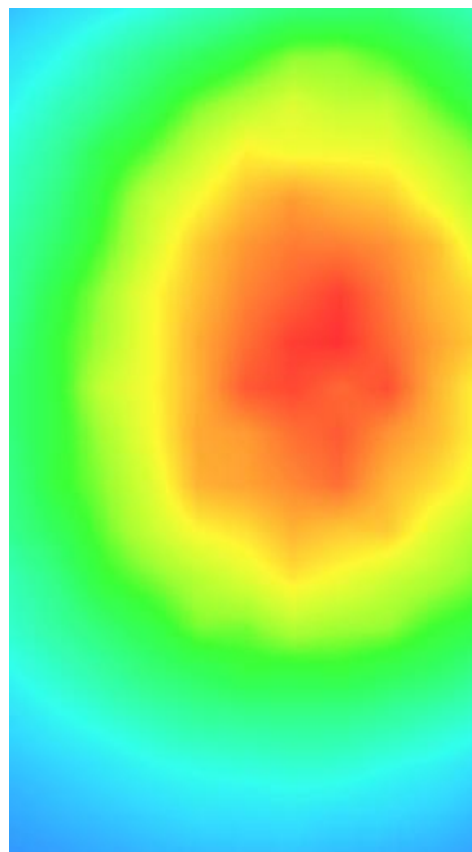



# GPRS 850, Back, Middle

Type: Phone measurement (Very fast, 11 points in the volume)

Date of measurement: 27/12/2013

Measurement duration: 7 minutes 33 seconds

Mobile Phone IMEI number: --

### A. Experimental conditions.

<b>Area Scan</b>	surf_sam_plan.txt
<b>ZoomScan</b>	5x5x7,dx=8mm dy=8mm dz=5mm,Very fast
<b>Phantom</b>	Validation plane
<b>Device Position</b>	Back
<b>Band</b>	CUSTOM (GPRS850_4Tx)
<b>Channels</b>	190
<b>Signal</b>	GPRS(Duty cycle: 1:2)

### B.SAR Measurement Results

<b>Frequency (MHz)</b>	836.6
<b>Relative permittivity (real part)</b>	55.479356
<b>Relative permittivity (imaginary part)</b>	21.709999
<b>Conductivity (S/m)</b>	0.984352
<b>Variation (%)</b>	3.470000
<b>ConvF:</b>	5.67

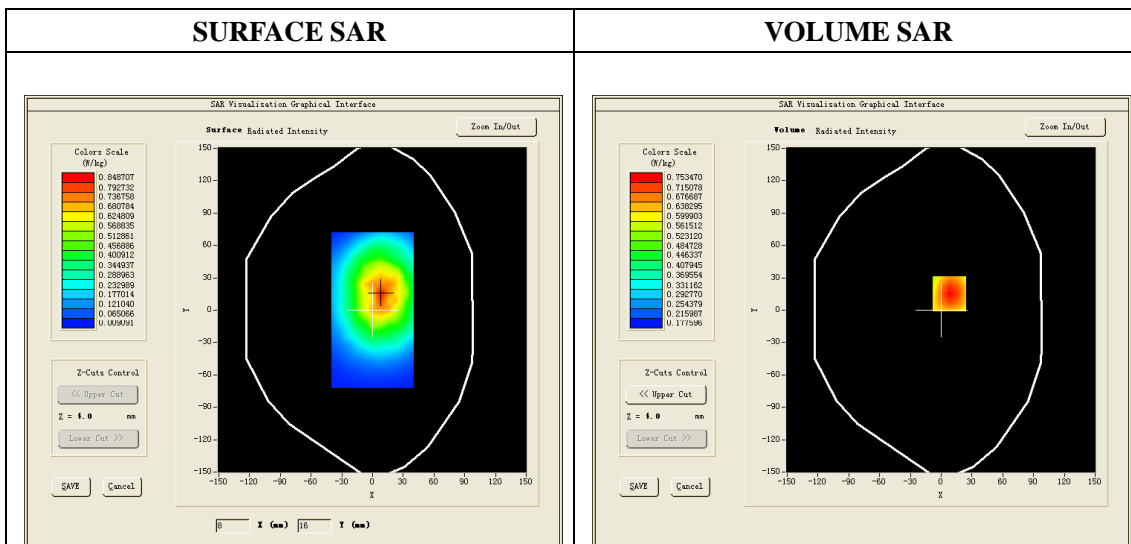

**Maximum location: X=8.00, Y=15.00**

<b>SAR 10g (W/Kg)</b>	0.535374
<b>SAR 1g (W/Kg)</b>	0.734913

### Z axis scan

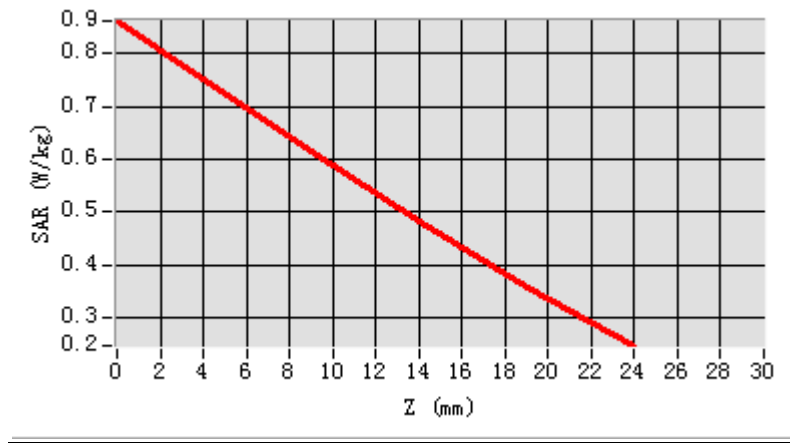

### 3D screen shot

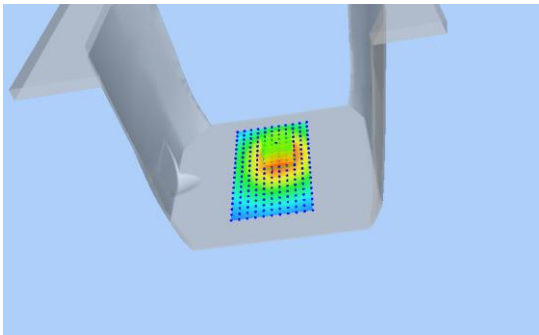

### Hot spot position

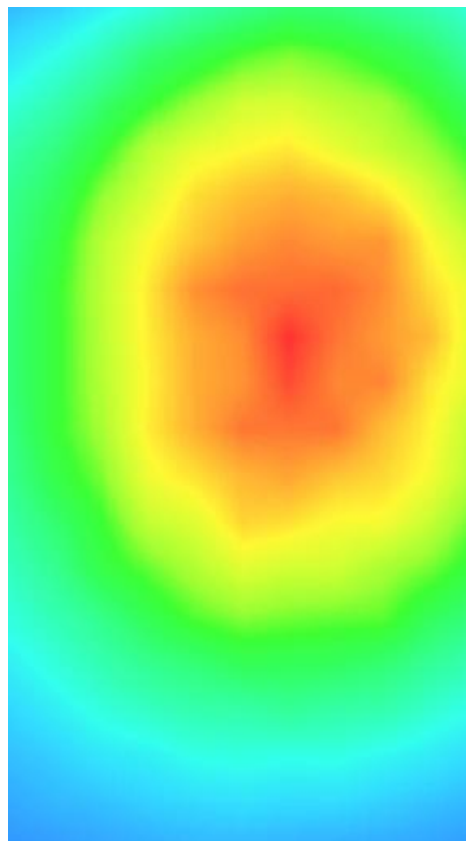

# GSM1900, Right Cheek, High

Type: Phone measurement (Very fast, 11 points in the volume)

Date of measurement: 26/12/2013

Measurement duration: 5 minutes 37 seconds

Mobile Phone IMEI number: --

## A. Experimental conditions.

Area Scan	sam_direct_droit2_surf8mm.txt
ZoomScan	5x5x7,dx=8mm dy=8mm dz=5mm,Very fast
Phantom	Right head
Device Position	Cheek
Band	GSM1900
Channels	810
Signal	GSM (Duty cycle: 1:8)

## B.SAR Measurement Results

Frequency (MHz)	1909.8
Relative permittivity (real part)	39.981243
Relative permittivity (imaginary part)	15.067700
Conductivity (S/m)	1.4198057
Variation (%)	0.270000
ConvF:	5.48

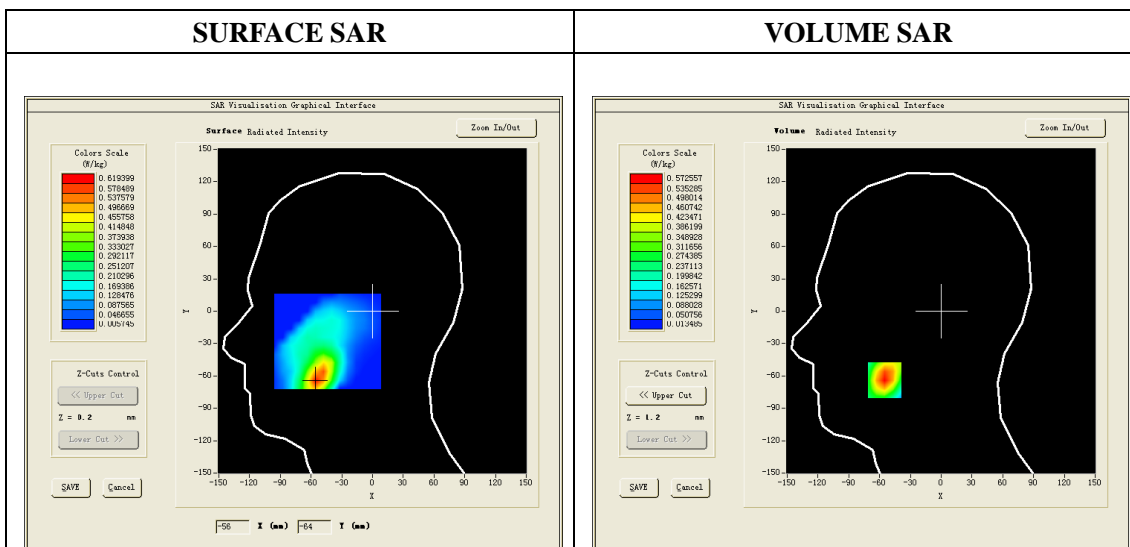

**Maximum location: X=-55.00, Y=-64.00**

<b>SAR 10g (W/Kg)</b>	0.293206
<b>SAR 1g (W/Kg)</b>	0.536428

**Z axis scan**

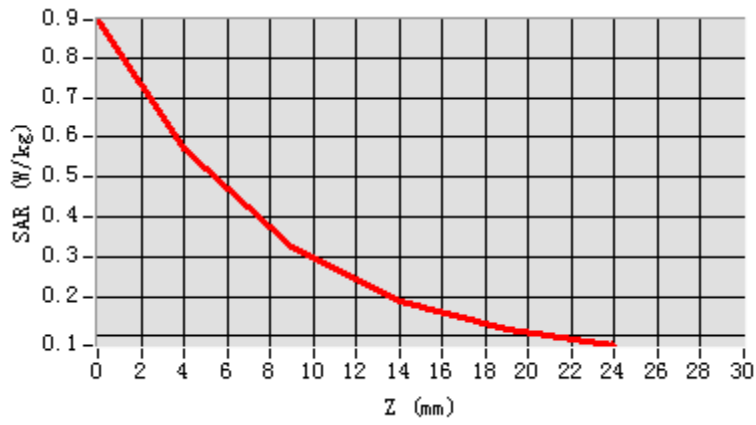

**3D screen shot**

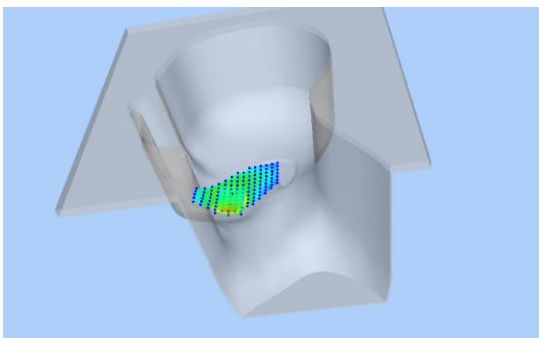

**Hot spot position**

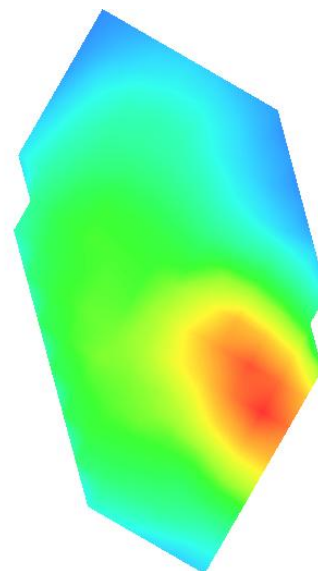

# GSM1900, Edge C, High

Type: Phone measurement (Very fast, 11 points in the volume)

Date of measurement: 27/12/2013

Measurement duration: 6 minutes 52 seconds

Mobile Phone IMEI number: --

## A. Experimental conditions.

Area Scan	dx=8mm dy=8mm
ZoomScan	5x5x7,dx=8mm dy=8mm dz=5mm,Very fast
Phantom	Validation plane
Device Position	Edge C
Band	GSM1900
Channels	810
Signal	GSM (Duty cycle: 1:8)

## B. SAR Measurement Results

Frequency (MHz)	1909.8
Relative permittivity (real part)	53.570213
Relative permittivity (imaginary part)	12.991650
Conductivity (S/m)	1.512476
Variation (%)	4.740000
ConvF:	5.64

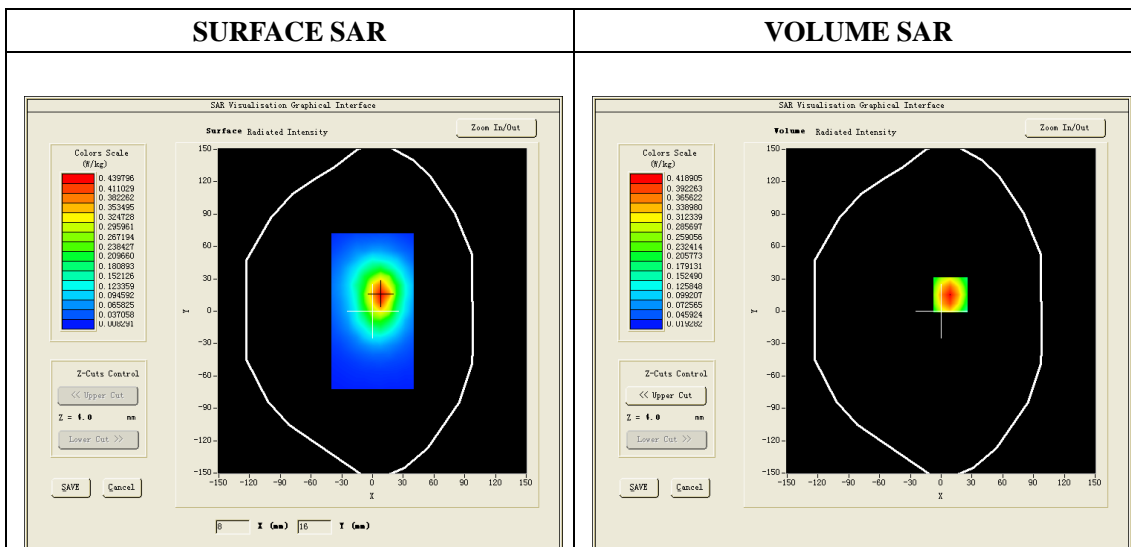

**Maximum location: X=9.00, Y=15.00**

<b>SAR 10g (W/Kg)</b>	0.241069
<b>SAR 1g (W/Kg)</b>	0.428522

### Z axis scan

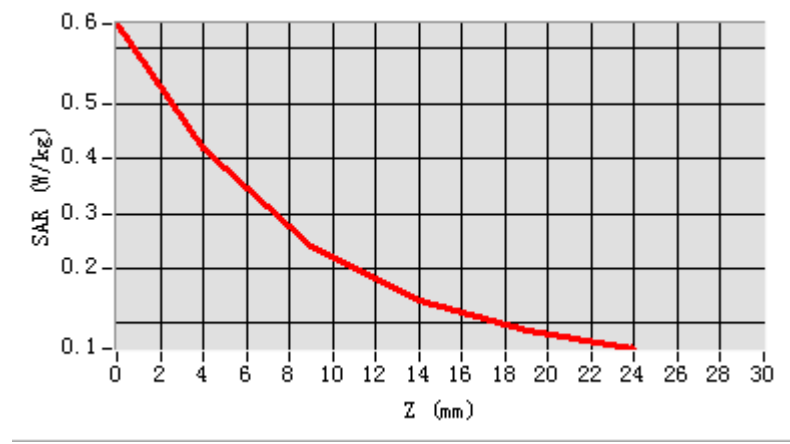

### 3D screen shot

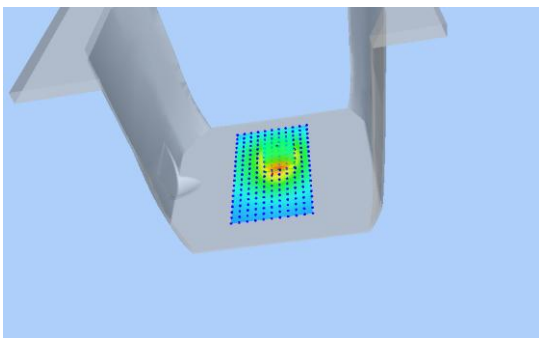

### Hot spot position

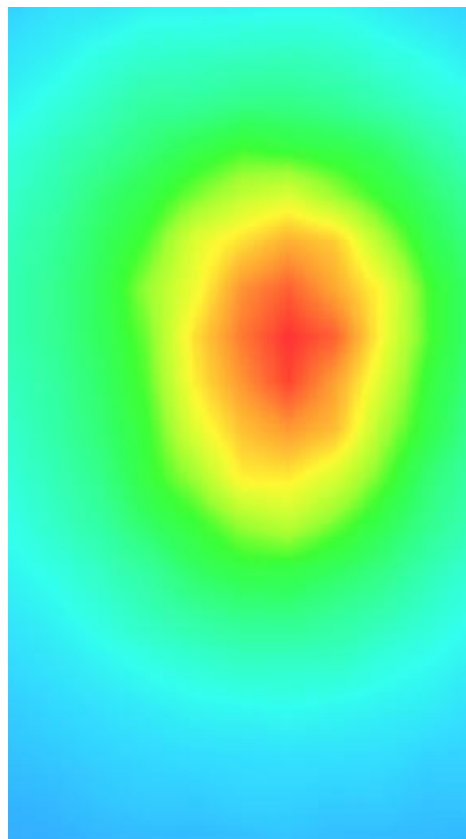

# GPRS1900, Edge C, High

Type: Phone measurement (Very fast, 11 points in the volume)

Date of measurement: 27/12/2013

Measurement duration: 7 minutes 31 seconds

Mobile Phone IMEI number: --

## A. Experimental conditions.

Area Scan	surf_sam_plan.txt
ZoomScan	5x5x7,dx=8mm dy=8mm dz=5mm,Very fast
Phantom	Validation plane
Device Position	Edge C
Band	CUSTOM (GPRS1900_4Tx)
Channels	810
Signal	GPRS (Duty cycle: 1:2)

## B. SAR Measurement Results

Frequency (MHz)	1909.8
Relative permittivity (real part)	53.570213
Relative permittivity (imaginary part)	12.991650
Conductivity (S/m)	1.512476
Variation (%)	1.520347
ConvF:	5.64

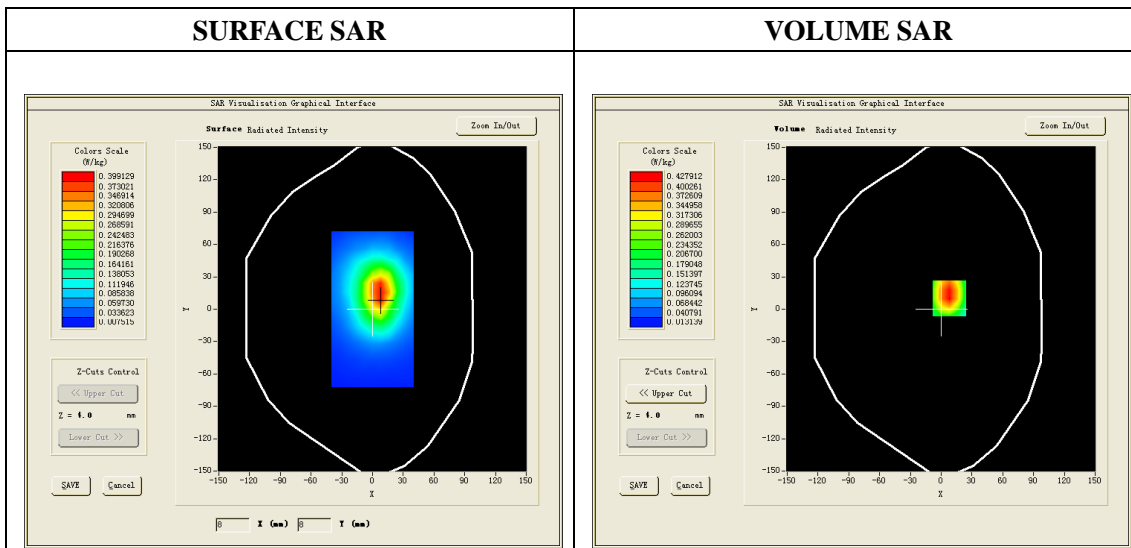

**Maximum location: X=8.00, Y=10.00**

<b>SAR 10g (W/Kg)</b>	0.241986
<b>SAR 1g (W/Kg)</b>	0.444296

### Z axis scan

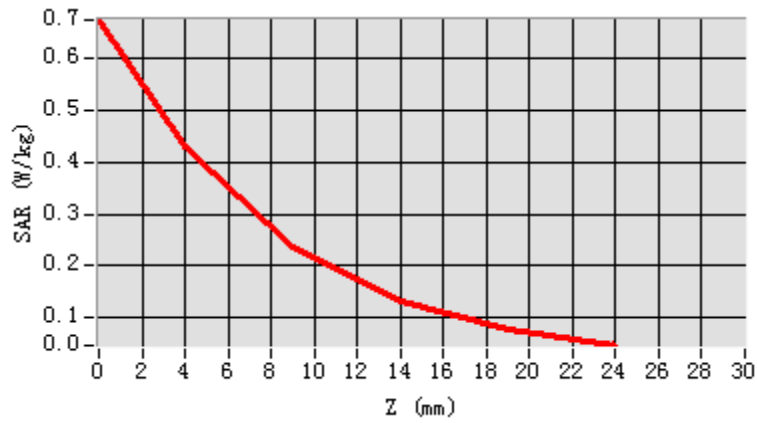

### 3D screen shot

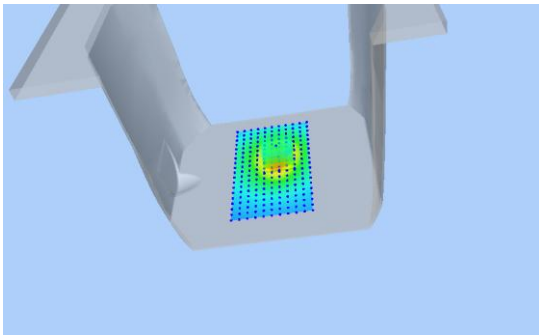

### Hot spot position

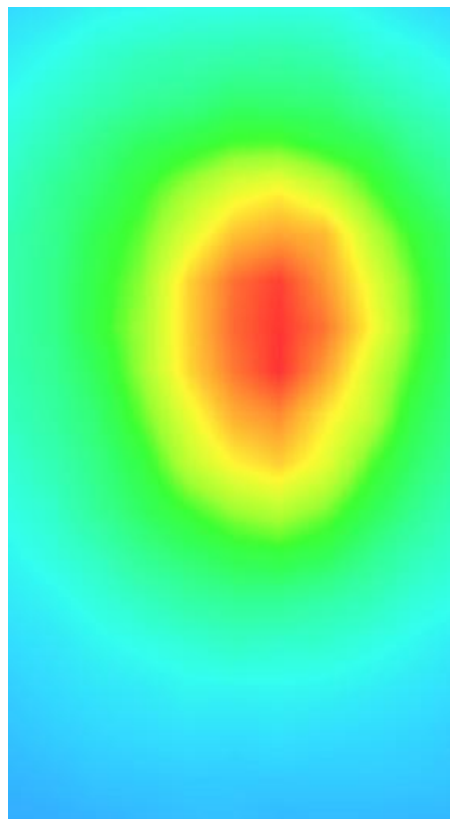



# WCDMA850, Left Cheek, Middle

Type: Phone measurement (Very fast, 11 points in the volume)

Date of measurement: 26/12/2013

Measurement duration: 5 minutes 19 seconds

Mobile Phone IMEI number: --

### A. Experimental conditions.

<b>Area Scan</b>	sam_direct_droit2_surf8mm.txt
<b>ZoomScan</b>	5x5x7,dx=8mm dy=8mm dz=5mm,Very fast
<b>Phantom</b>	Left head
<b>Device Position</b>	Cheek
<b>Band</b>	Band5_WCDMA850
<b>Channels</b>	4183
<b>Signal</b>	WCDMA (Duty cycle: 1:1)

### B. SAR Measurement Results

<b>Frequency (MHz)</b>	836.6
<b>Relative permittivity (real part)</b>	41.382417
<b>Relative permittivity (imaginary part)</b>	15.067700
<b>Conductivity (S/m)</b>	0.941371
<b>Variation (%)</b>	-4.770000
<b>ConvF:</b>	5.52

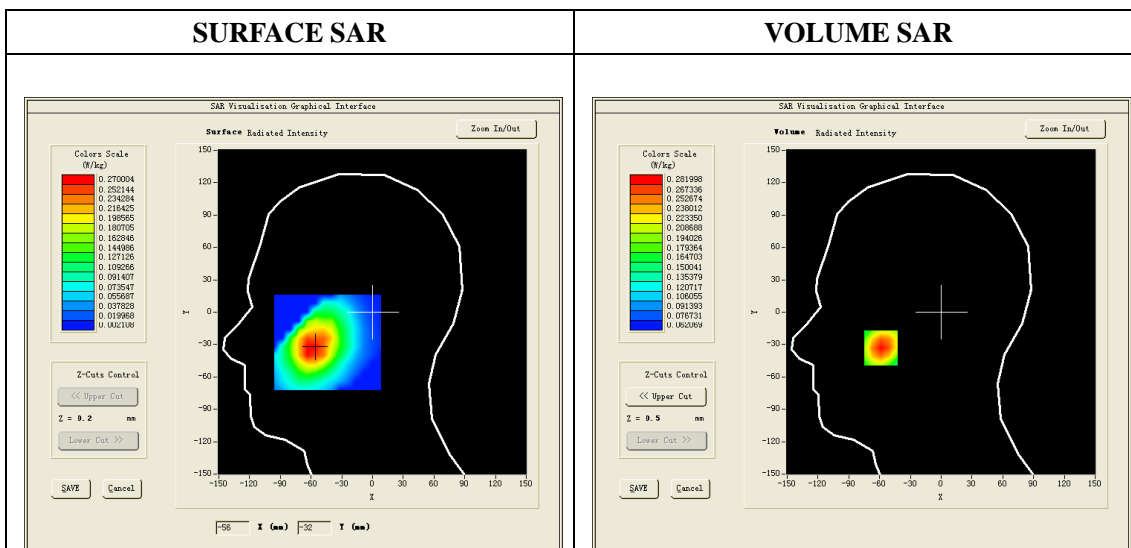

**Maximum location: X=-59.00, Y=-33.00**

<b>SAR 10g (W/Kg)</b>	0.213881
<b>SAR 1g (W/Kg)</b>	0.291621

### Z axis scan

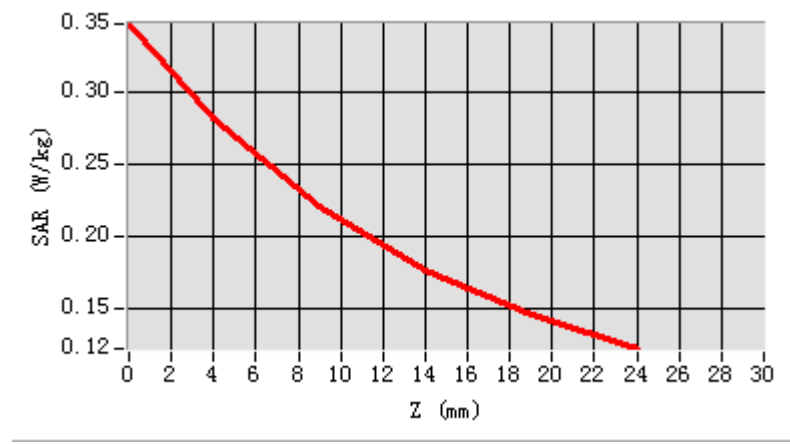

### 3D screen shot

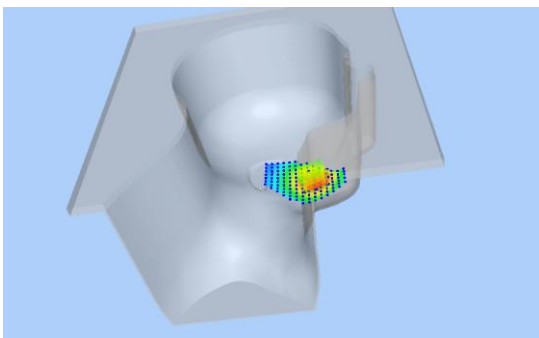

### Hot spot position

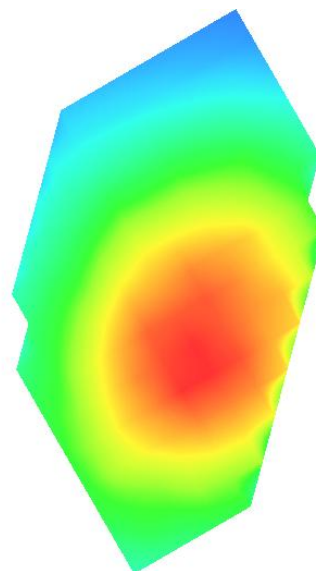

# WCDMA850, Back, Middle

Type: Phone measurement (Very fast, 11 points in the volume)

Date of measurement: 27/12/2013

Measurement duration: 7 minutes 26 seconds

Mobile Phone IMEI number: --

### A. Experimental conditions.

Area Scan	surf_sam_plan.txt
ZoomScan	5x5x7,dx=8mm dy=8mm dz=5mm,Very fast
Phantom	Validation plane
Device Position	Back
Band	Band5_WCDMA850
Channels	4183
Signal	WCDMA (Crest factor: 1:1)

### B. SAR Measurement Results

Frequency (MHz)	836.6
Relative permittivity (real part)	55.479356
Relative permittivity (imaginary part)	21.709999
Conductivity (S/m)	0.984352
Variation (%)	-1.480000
ConvF:	5.67

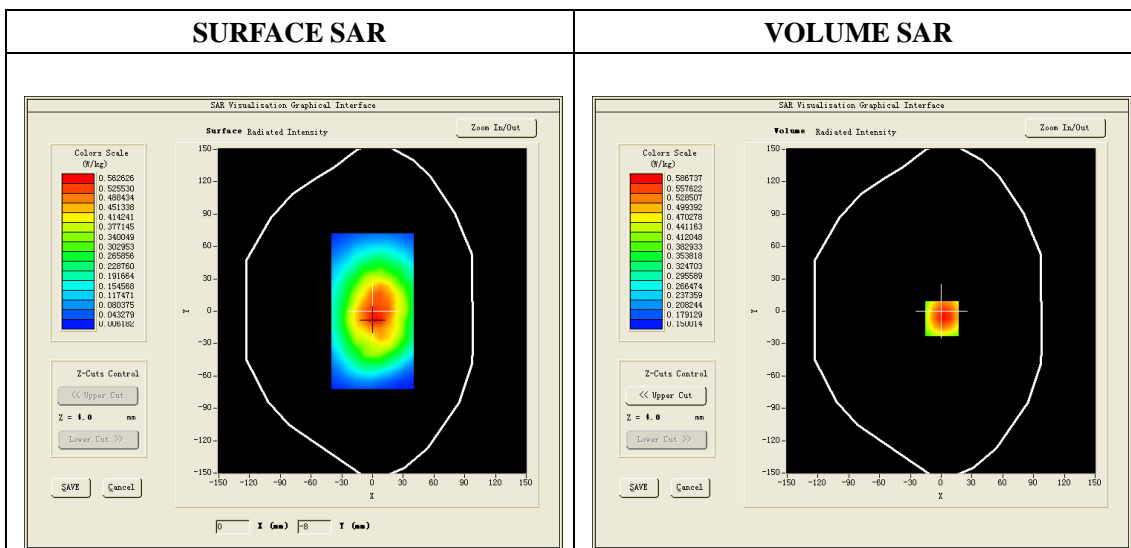

**Maximum location: X=1.00, Y=-7.00**

SAR 10g (W/Kg)	0.442750
SAR 1g (W/Kg)	0.613433

**Z axis scan**

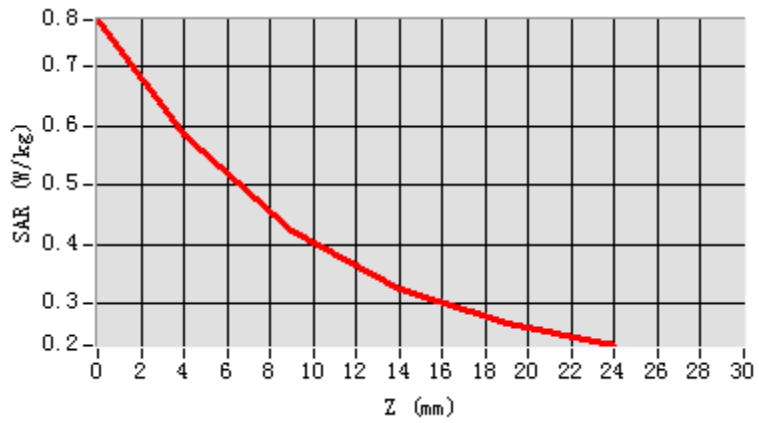

**3D screen shot**

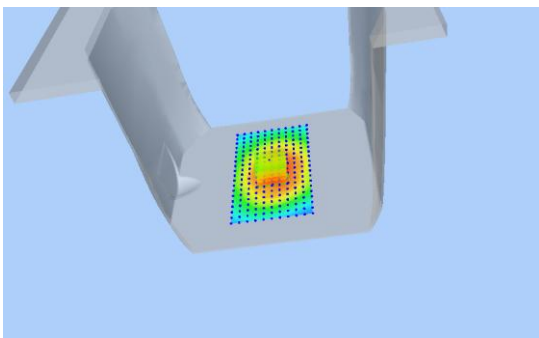

**Hot spot position**

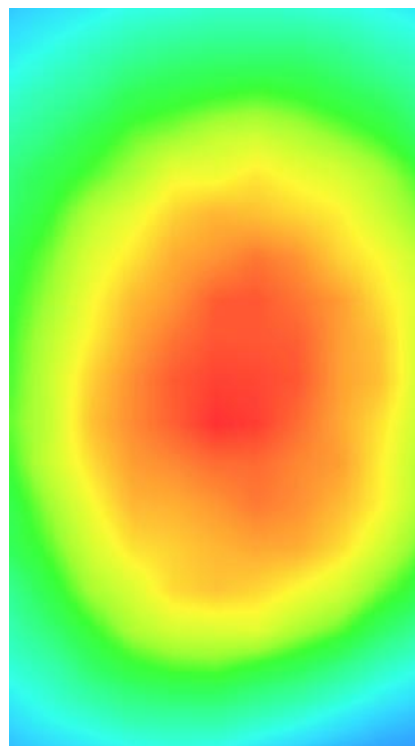

# WCDMA1900, Right Cheek, Low

Type: Phone measurement (Very fast, 11 points in the volume)

Date of measurement: 26/12/2013

Measurement duration: 6 minutes 6 seconds

Mobile Phone IMEI number: --

### A. Experimental conditions.

<b>Area Scan</b>	sam_direct_droit2_surf8mm.txt
<b>ZoomScan</b>	5x5x7,dx=8mm dy=8mm dz=5mm,Very fast
<b>Phantom</b>	Right head
<b>Device Position</b>	Cheek
<b>Band</b>	Band2_WCDMA1900
<b>Channels</b>	9262
<b>Signal</b>	WCDMA (Duty cycle: 1:1)

### B. SAR Measurement Results

<b>Frequency (MHz)</b>	1852.4
<b>Relative permittivity (real part)</b>	39.981243
<b>Relative permittivity (imaginary)</b>	15.067700
<b>Conductivity (S/m)</b>	1.4198057
<b>Variation (%)</b>	0.480000
<b>ConvF:</b>	5.48

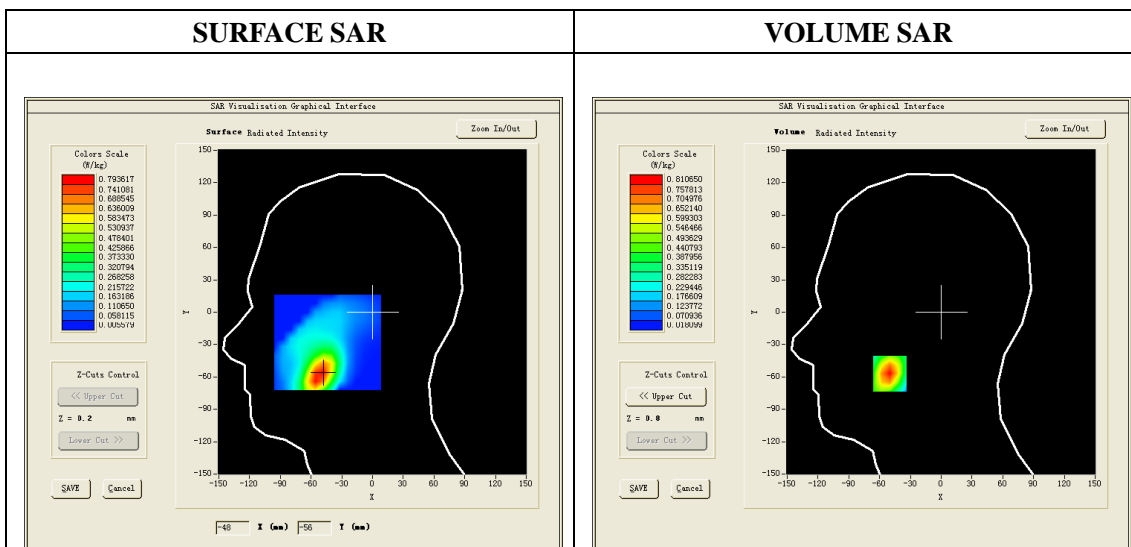

**Maximum location: X=-50.00, Y=-57.00**

<b>SAR 10g (W/Kg)</b>	0.413591
<b>SAR 1g (W/Kg)</b>	0.752798

### Z axis scan

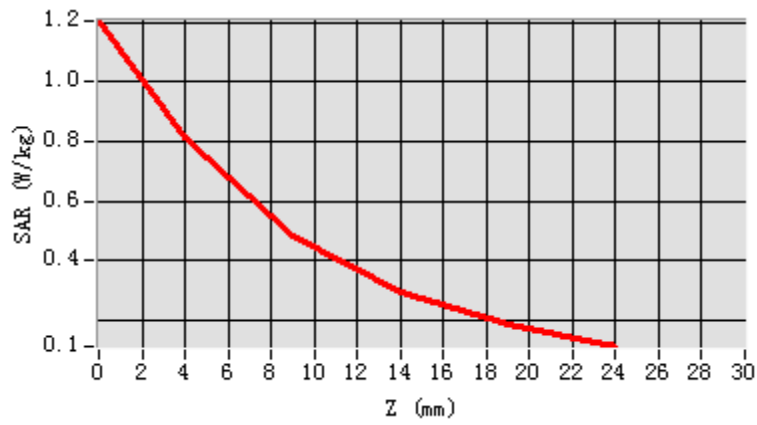

### 3D screen shot

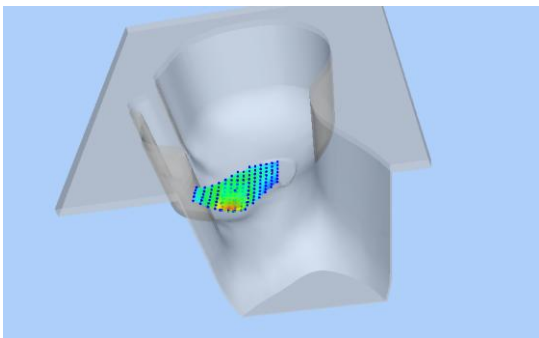

### Hot spot position

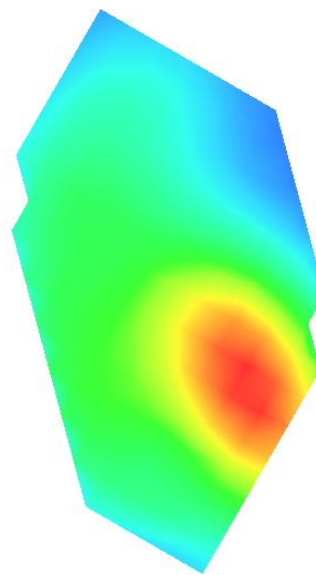

# WCDMA1900, Back, Low

Type: Phone measurement (Very fast, 11 points in the volume)

Date of measurement: 27/12/2013

Measurement duration: 7 minutes 37 seconds

Mobile Phone IMEI number: --

### A. Experimental conditions.

<b>Area Scan</b>	surf_sam_plan.txt
<b>ZoomScan</b>	5x5x7,dx=8mm dy=8mm dz=5mm,Very fast
<b>Phantom</b>	Validation plane
<b>Device Position</b>	Back
<b>Band</b>	Band2_WCDMA1900
<b>Channels</b>	9262
<b>Signal</b>	WCDMA (Duty cycle: 1:1)

### B. SAR Measurement Results

<b>Frequency (MHz)</b>	1852.4
<b>Relative permittivity (real part)</b>	53.570213
<b>Relative permittivity (imaginary)</b>	12.991650
<b>Conductivity (S/m)</b>	1.512476
<b>Variation (%)</b>	-0.670000
<b>ConvF:</b>	5.64

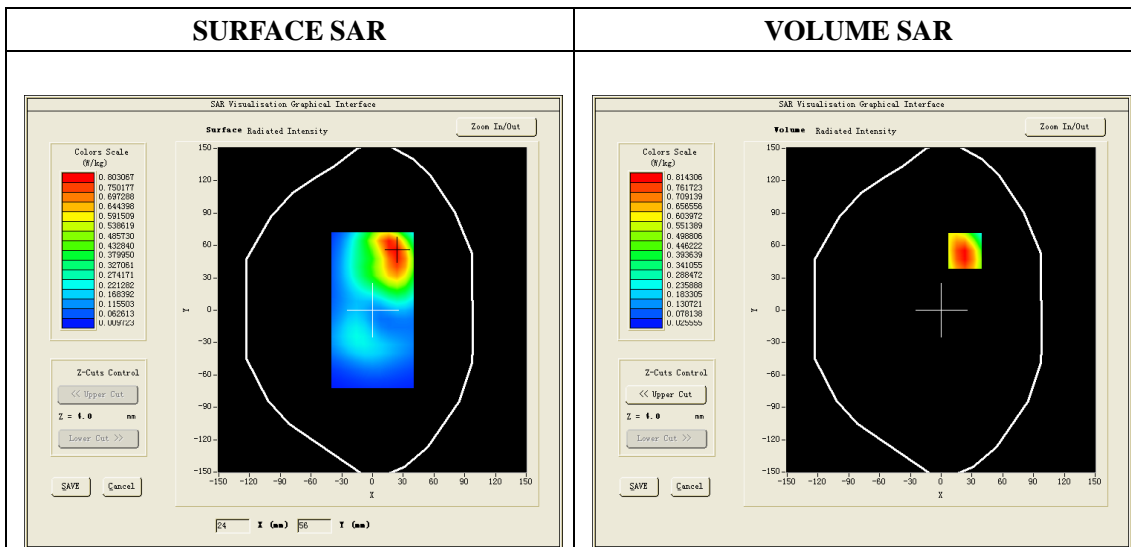

**Maximum location: X=23.00, Y=55.00**

<b>SAR 10g (W/Kg)</b>	0.487281
<b>SAR 1g (W/Kg)</b>	0.848856

**Z axis scan**

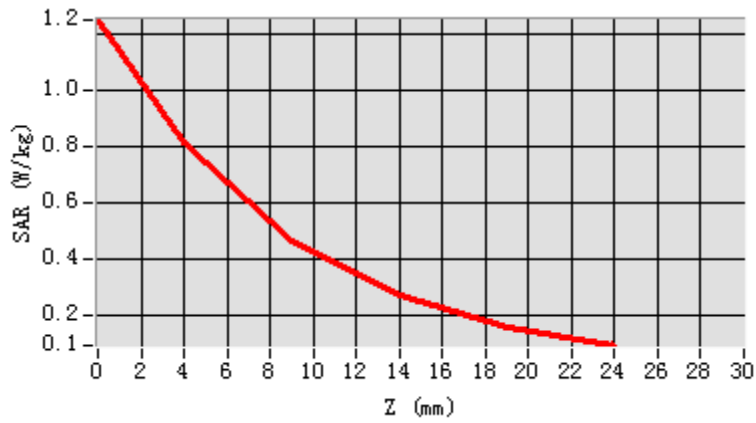

**3D screen shot**

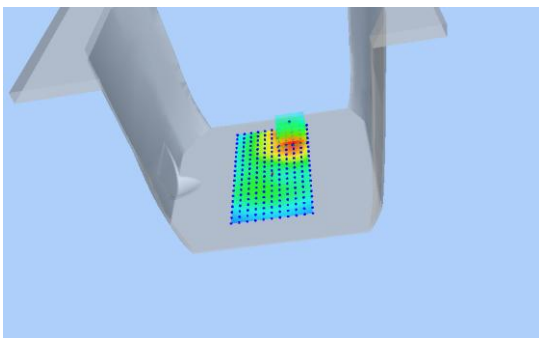

**Hot spot position**

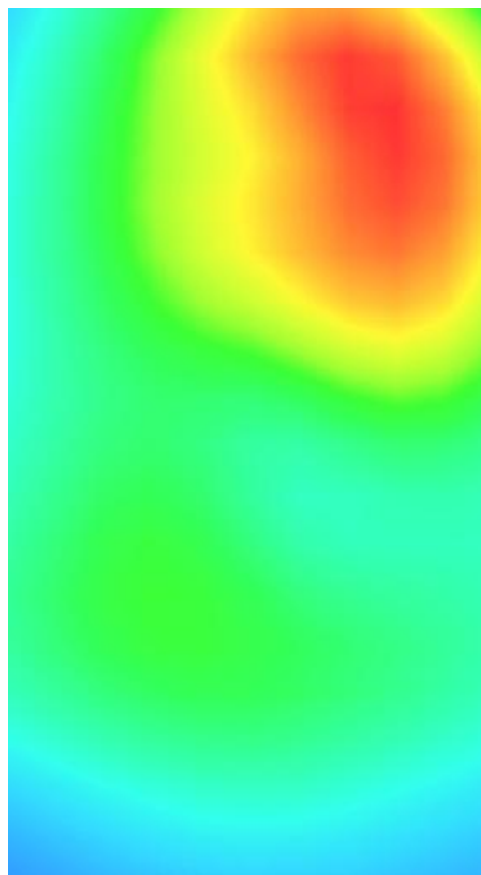



# WCDMA1900, Back, Low, repeat measurement

Type: Phone measurement (Very fast, 11 points in the volume)

Date of measurement: 27/12/2013

Measurement duration: 6 minutes 52 seconds

Mobile Phone IMEI number: --

## A. Experimental conditions.

<b>Area Scan</b>	dx=8mm dy=8mm
<b>ZoomScan</b>	5x5x7,dx=8mm dy=8mm dz=5mm,Very fast
<b>Phantom</b>	Validation plane
<b>Device Position</b>	Back
<b>Band</b>	Band2_WCDMA1900
<b>Channels</b>	9262
<b>Signal</b>	WCDMA (Duty cycle: 1:1)

## B. SAR Measurement Results

<b>Frequency (MHz)</b>	1852.4
<b>Relative permittivity (real part)</b>	53.570213
<b>Relative permittivity (imaginary part)</b>	12.991650
<b>Conductivity (S/m)</b>	1.512476
<b>Variation (%)</b>	-2.430000
<b>ConvF:</b>	5.64

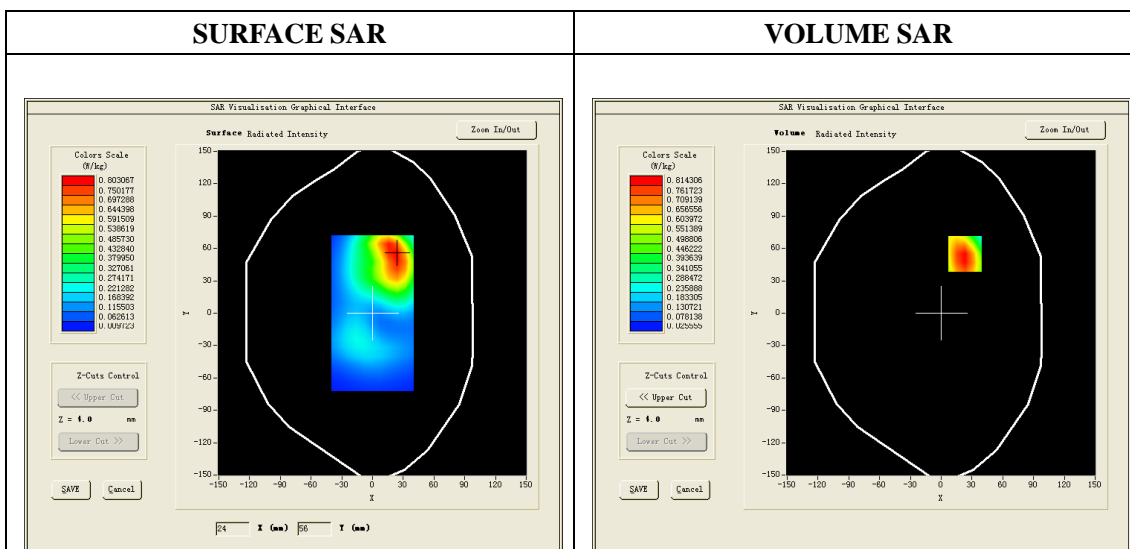

**Maximum location: X=23.00, Y=55.00**

<b>SAR 10g (W/Kg)</b>	0.485426
<b>SAR 1g (W/Kg)</b>	0.832134

### Z axis scan

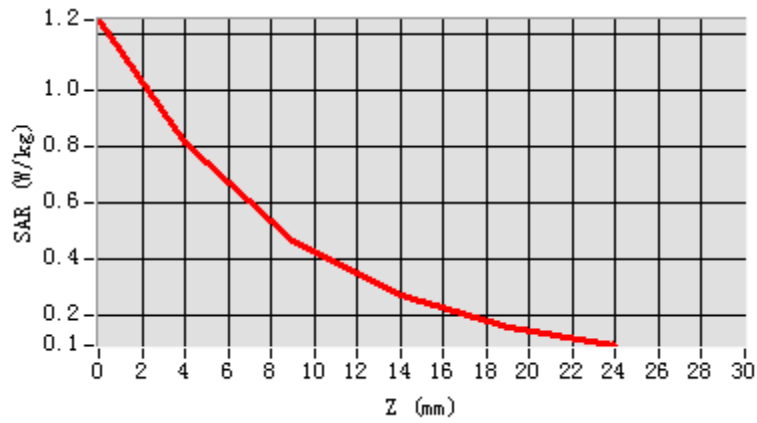

### 3D screen shot

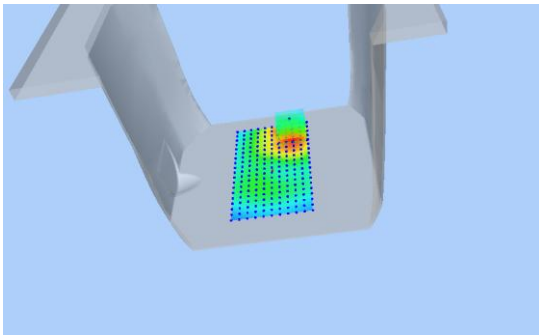

### Hot spot position

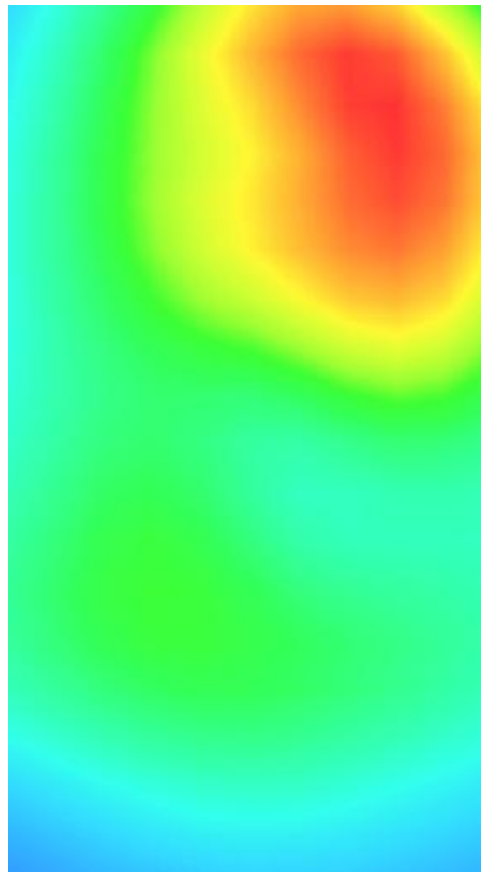

# Wi-Fi 802.11b ,Right Cheek, Low

Type: Phone measurement (Very fast, 11 points in the volume)

Date of measurement: 26/12/2013

Measurement duration: 7 minutes 21 seconds

Mobile Phone IMEI number: --

## A. Experimental conditions.

Area Scan	dx=8mm dy=8mm
ZoomScan	5x5x7,dx=8mm dy=8mm dz=5mm,Very fast
Phantom	Right head
Device Position	Cheek
Band	IEEE 802.11b ISM
Channels	1
Signal	DSSS (Crest factor: 1:1)

## B. SAR Measurement Results

Frequency (MHz)	2412
Relative permittivity (real part)	38.98
Relative permittivity (imaginary part)	13.19
Conductivity (S/m)	1.79
Variation (%)	-0.160000
ConvF:	4.80

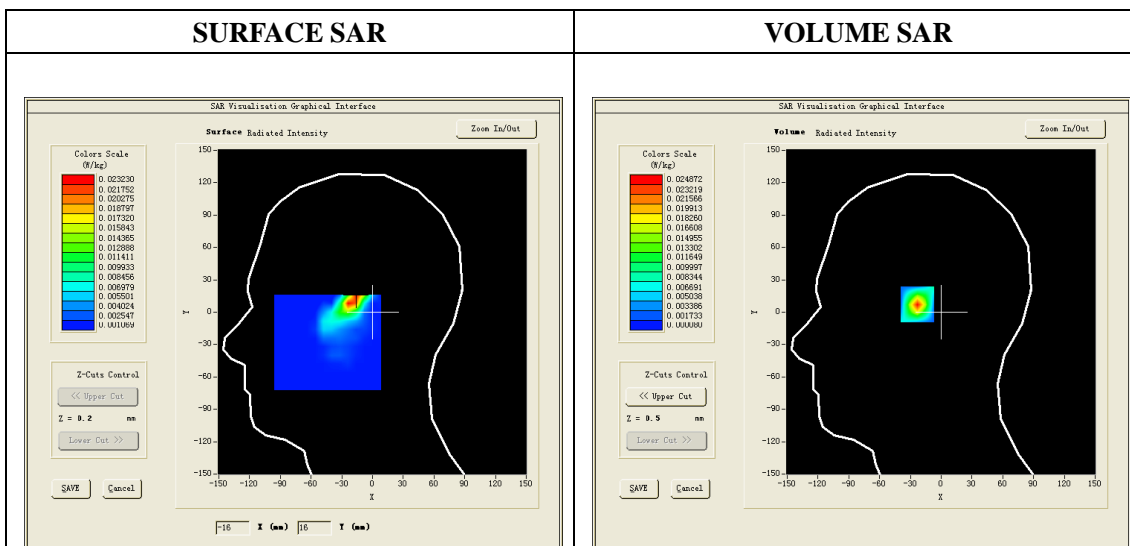

**Maximum location: X=-21.00, Y=8.00**

<b>SAR 10g (W/Kg)</b>	0.008641
<b>SAR 1g (W/Kg)</b>	0.021717

**Z axis scan**

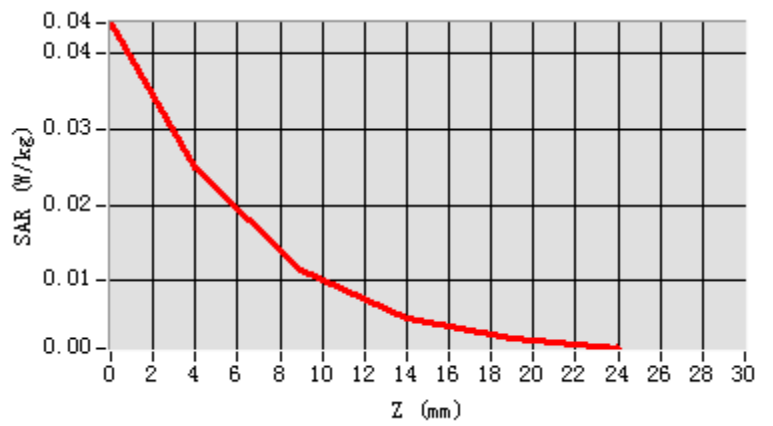

**3D screen shot**

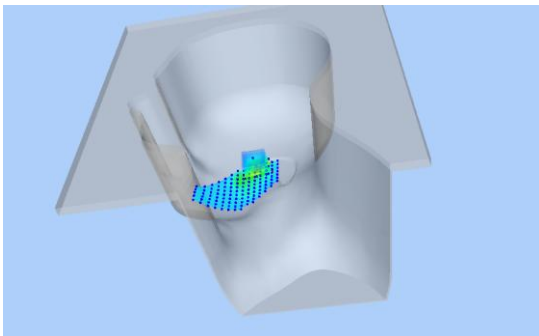

**Hot spot position**

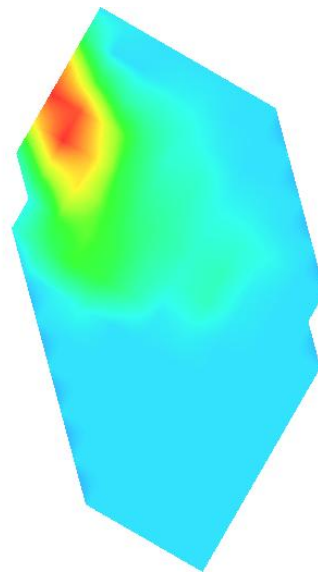

# Wi-Fi 802.11b , Back, Low

Type: Phone measurement (Very fast, 11 points in the volume)

Date of measurement: 27/12/2013

Measurement duration: 7 minutes 11 seconds

Mobile Phone IMEI number: --

### A. Experimental conditions.

<b>Area Scan</b>	dx=8mm dy=8mm
<b>ZoomScan</b>	5x5x7,dx=8mm dy=8mm dz=5mm,Very fast
<b>Phantom</b>	Validation plane
<b>Device Position</b>	Back
<b>Band</b>	IEEE 802.11b ISM
<b>Channels</b>	1
<b>Signal</b>	DSSS (Crest factor: 1:1)

### B. SAR Measurement Results

<b>Frequency (MHz)</b>	2412
<b>Relative permittivity (real part)</b>	52.58
<b>Relative permittivity (imaginary part)</b>	13.024236
<b>Conductivity (S/m)</b>	1.972160
<b>Variation (%)</b>	-0.220000
<b>ConvF:</b>	4.90

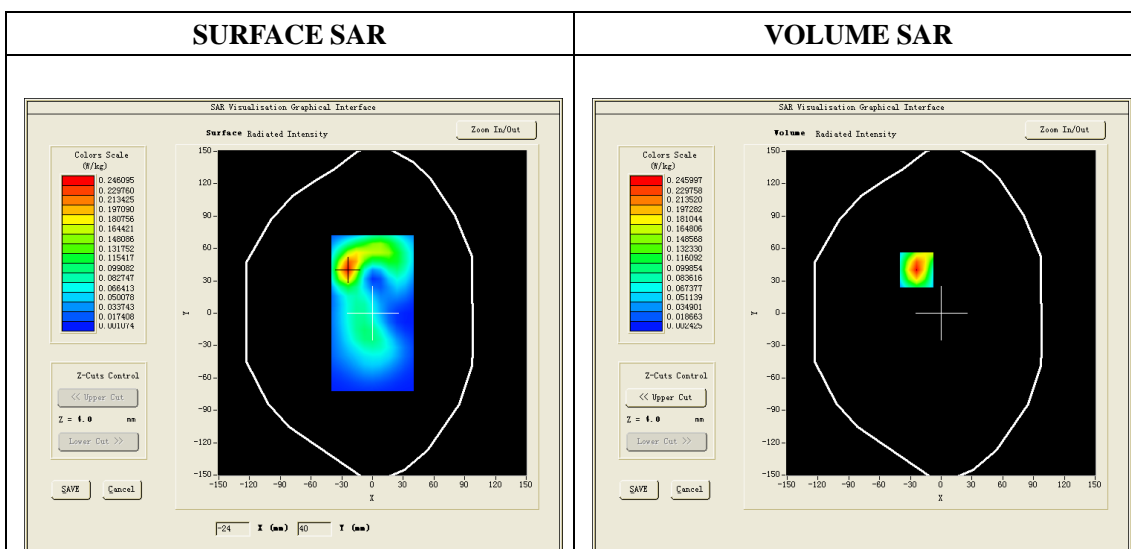

**Maximum location: X=-24.00, Y=40.00**

<b>SAR 10g (W/Kg)</b>	0.119062
<b>SAR 1g (W/Kg)</b>	0.245683

**Z axis scan**

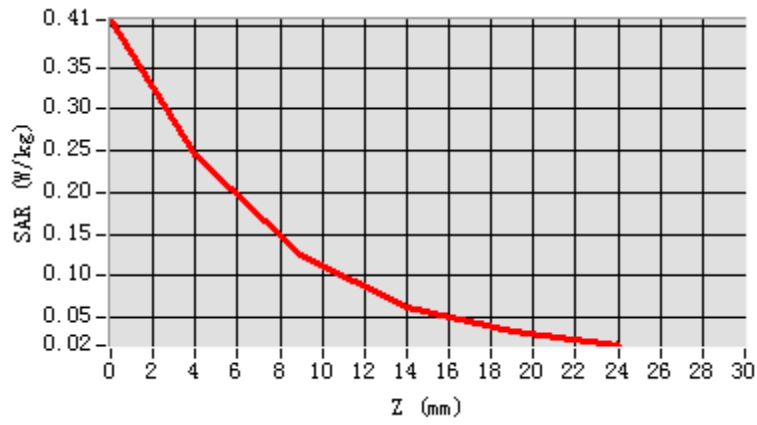

**3D screen shot**

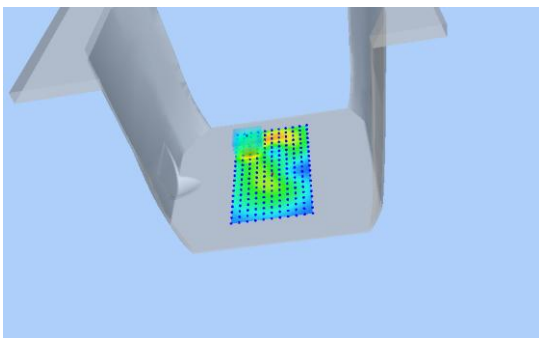

**Hot spot position**

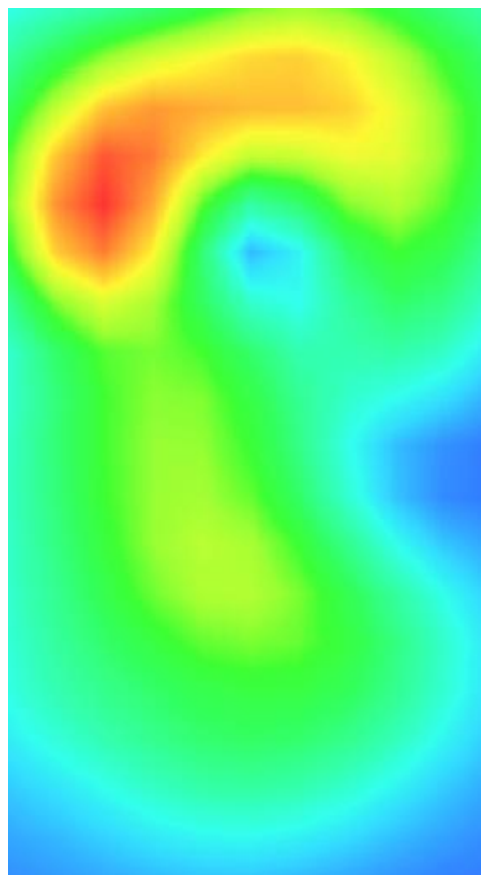



**ANNEX E**  
**of**  
**CCIC-SET**

**CONFORMANCE TEST REPORT FOR**  
**HUMAN EXPOSURE TO ELECTROMAGNETIC FIELDS**

**SET2014-00063**

**GSM/WCDMA MOBILE PHONE**

**Type Name: M4 SS1050**

**Hardware Version: SLSPLUS-V1.0**

**Software Version: M4\_SS1050\_S03\_Ver200**

**Calibration Certificate of Probe and Dipoles**

**This Annex consists of 42 pages**

**Date of Report: 2013-09-26**

**Probe Calibration Certificate****COMOSAR E-Field Probe Calibration Report**

Ref : ACR.96.2.13.SATU.A

**CCIC SOUTHERN ELECTRONIC PRODUCT TESTING  
(SHENZHEN) CO.,LTD  
ELECTRONIC TESTING BUILDING,SHAHE ROAD, XILI.  
TOWN SHENZHEN,P.R.CHINA  
SATIMO COMOSAR DOSIMETRIC E-FIELD PROBE  
SERIAL NO.: SN 09/13 EP169**

**Calibrated at SATIMO US  
2105 Barrett Park Dr. - Kennesaw, GA 30144**

**04/05/13***Summary:*

This document presents the method and results from an accredited COMOSAR Dosimetric E-Field Probe calibration performed in SATIMO USA using the CALISAR / CALIBAIR test bench, for use with a SATIMO COMOSAR system only. All calibration results are traceable to national metrology institutions.





## COMOSAR E-FIELD PROBE CALIBRATION REPORT

Ref ACR.96.2.13.SATU.A

	<i>Name</i>	<i>Function</i>	<i>Date</i>	<i>Signature</i>
<i>Prepared by :</i>	Jérôme LUC	Product Manager	4/5/2013	<i>JS</i>
<i>Checked by :</i>	Jérôme LUC	Product Manager	4/5/2013	<i>JS</i>
<i>Approved by :</i>	Kim RUTKOWSKI	Quality Manager	4/5/2013	<i>Kim Rutkowski</i>

	<i>Customer Name</i>
<i>Distribution :</i>	Shenzhen EMC-united Co., Ltd

<i>Issue</i>	<i>Date</i>	<i>Modifications</i>
A	4/5/2013	Initial release

Page: 2/10

*This document shall not be reproduced, except in full or in part, without the written approval of SATIMO.  
The information contained herein is to be used only for the purpose for which it is submitted and is not to be released in whole or part without written approval of SATIMO.*



TABLE OF CONTENTS

1 Device Under Test ..... 4

2 Product Description..... 4

    2.1 General Information ..... 4

3 Measurement Method..... 4

    3.1 Linearity ..... 4

    3.2 Sensitivity ..... 5

    3.3 Lower Detection Limit ..... 5

    3.4 Isotropy ..... 5

    3.5 Boundary Effect ..... 5

4 Measurement Uncertainty ..... 5

5 Calibration Measurement Results ..... 6

    5.1 Sensitivity in air ..... 6

    5.2 Linearity ..... 7

    5.3 Sensitivity in liquid ..... 7

    5.4 Isotropy ..... 8

6 List of Equipment ..... 10

*This document shall not be reproduced, except in full or in part, without the written approval of SATIMO. The information contained herein is to be used only for the purpose for which it is submitted and is not to be released in whole or part without written approval of SATIMO.*



**1 DEVICE UNDER TEST**

Device Under Test	
Device Type	COMOSAR DOSIMETRIC E FIELD PROBE
Manufacturer	Satimo
Model	SSE5
Serial Number	SN 09/13 EP169
Product Condition (new / used)	new
Frequency Range of Probe	0.7 GHz-3GHz
Resistance of Three Dipoles at Connector	Dipole 1: R1=0.223 MΩ Dipole 2: R2=0.233 MΩ Dipole 3: R3=0.222 MΩ

A yearly calibration interval is recommended.

**2 PRODUCT DESCRIPTION**

**2.1 GENERAL INFORMATION**

Satimo’s COMOSAR E field Probes are built in accordance to the IEEE 1528, OET 65 Bulletin C and CEI/IEC 62209 standards.



Figure 1 – Satimo COMOSAR Dosimetric E field Dipole

Probe Length	330 mm
Length of Individual Dipoles	4.5 mm
Maximum external diameter	8 mm
Probe Tip External Diameter	5 mm
Distance between dipoles / probe extremity	2.7 mm

**3 MEASUREMENT METHOD**

The IEEE 1528, OET 65 Bulletin C, CENELEC EN50361 and CEI/IEC 62209 standards provide recommended practices for the probe calibrations, including the performance characteristics of interest and methods by which to assess their affect. All calibrations / measurements performed meet the fore mentioned standards.

**3.1 LINEARITY**

The evaluation of the linearity was done in free space using the waveguide, performing a power sweep to cover the SAR range 0.01 W/kg to 100W/kg.



**3.2 SENSITIVITY**

The sensitivity factors of the three dipoles were determined using a two step calibration method (air and tissue simulating liquid) using waveguides as outlined in the standards.

**3.3 LOWER DETECTION LIMIT**

The lower detection limit was assessed using the same measurement set up as used for the linearity measurement. The required lower detection limit is 10 mW/kg.

**3.4 ISOTROPY**

The axial isotropy was evaluated by exposing the probe to a reference wave from a standard dipole with the dipole mounted under the flat phantom in the test configuration suggested for system validations and checks. The probe was rotated along its main axis from 0 - 360 degrees in 15 degree steps. The hemispherical isotropy is determined by inserting the probe in a thin plastic box filled with tissue-equivalent liquid, with the plastic box illuminated with the fields from a half wave dipole. The dipole is rotated about its axis (0°–180°) in 15° increments. At each step the probe is rotated about its axis (0°–360°).

**3.5 BOUNDARY EFFECT**

The boundary effect is defined as the deviation between the SAR measured data and the expected exponential decay in the liquid when the probe is oriented normal to the interface. To evaluate this effect, the liquid filled flat phantom is exposed to fields from either a reference dipole or waveguide. With the probe normal to the phantom surface, the peak spatial average SAR is measured and compared to the analytical value at the surface.

**4 MEASUREMENT UNCERTAINTY**

The guidelines outlined in the IEEE 1528, OET 65 Bulletin C, CENELEC EN50361 and CEI/IEC 62209 standards were followed to generate the measurement uncertainty associated with an E-field probe calibration using the waveguide technique. All uncertainties listed below represent an expanded uncertainty expressed at approximately the 95% confidence level using a coverage factor of k=2, traceable to the Internationally Accepted Guides to Measurement Uncertainty.

Uncertainty analysis of the probe calibration in waveguide					
ERROR SOURCES	Uncertainty value (%)	Probability Distribution	Divisor	ci	Standard Uncertainty (%)
Incident or forward power	3.00%	Rectangular	$\sqrt{3}$	1	1.732%
Reflected power	3.00%	Rectangular	$\sqrt{3}$	1	1.732%
Liquid conductivity	5.00%	Rectangular	$\sqrt{3}$	1	2.887%
Liquid permittivity	4.00%	Rectangular	$\sqrt{3}$	1	2.309%
Field homogeneity	3.00%	Rectangular	$\sqrt{3}$	1	1.732%
Field probe positioning	5.00%	Rectangular	$\sqrt{3}$	1	2.887%
Field probe linearity	3.00%	Rectangular	$\sqrt{3}$	1	1.732%