

LTE Band IV (Part27) result

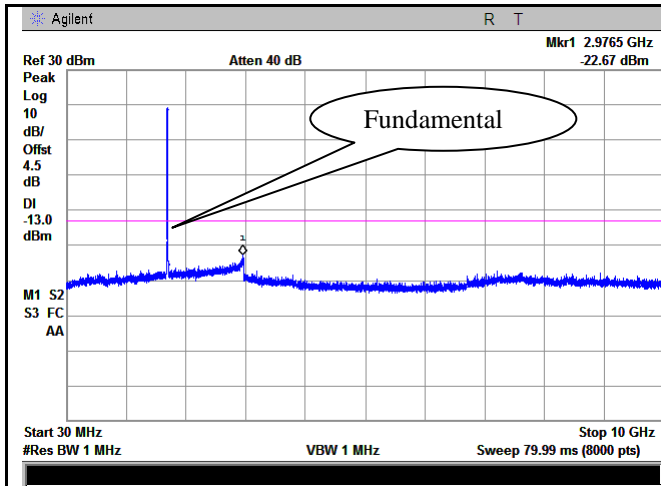

LTE Band IV - Low Channel-1

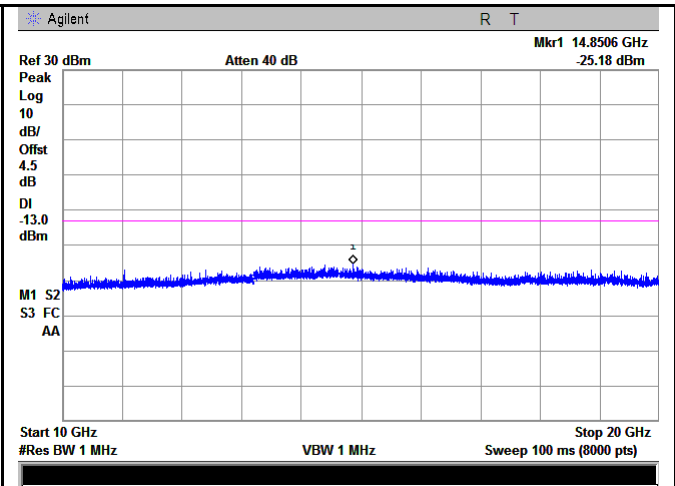

LTE Band IV - Low Channel-2

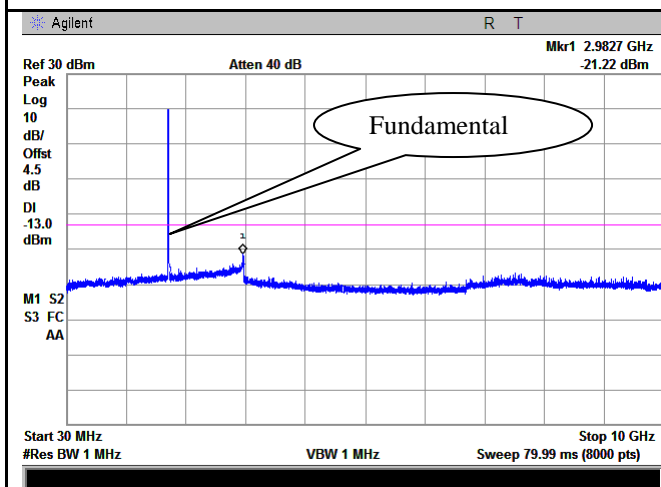

LTE Band IV - Middle Channel-1

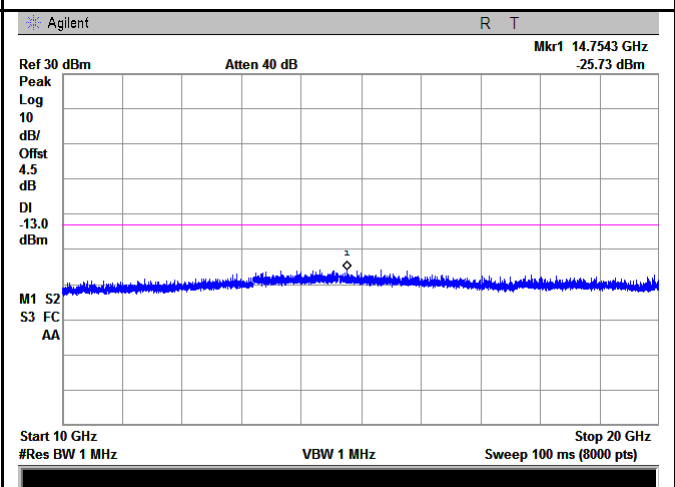

LTE Band IV - Middle Channel-2

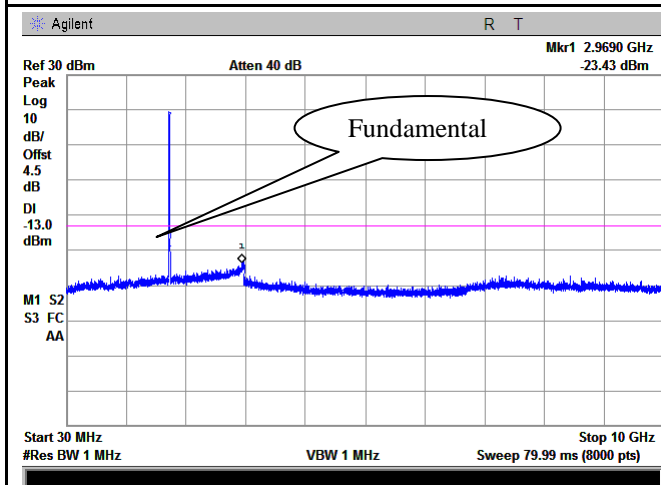

LTE Band IV - High Channel-1

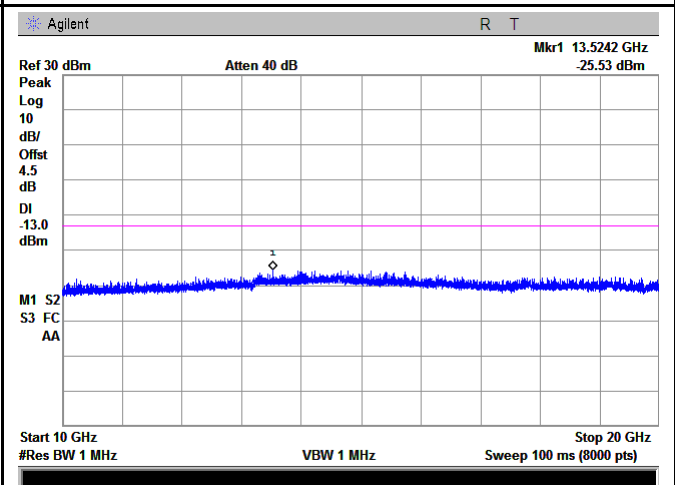

LTE Band IV - High Channel-2

LTE Band VII (Part 27)

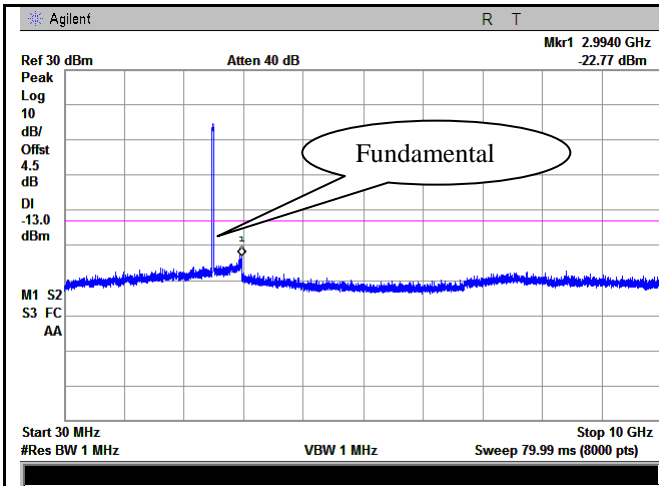

LTE Band VII - Low Channel-1

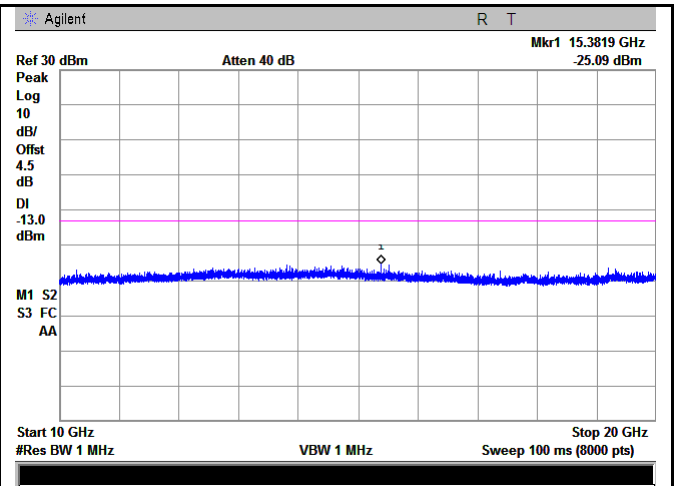

LTE Band VII - Low Channel-2

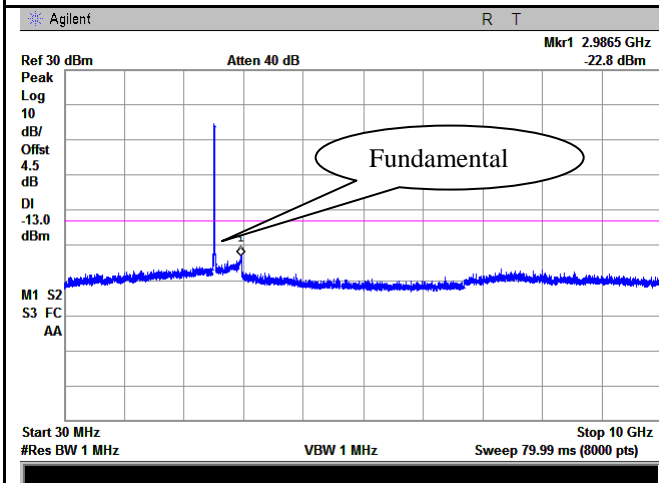

LTE Band VII - Middle Channel-1

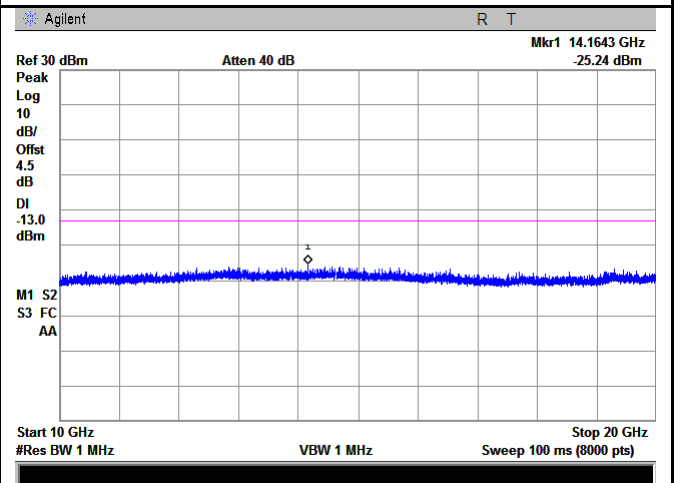

LTE Band VII - Middle Channel-2

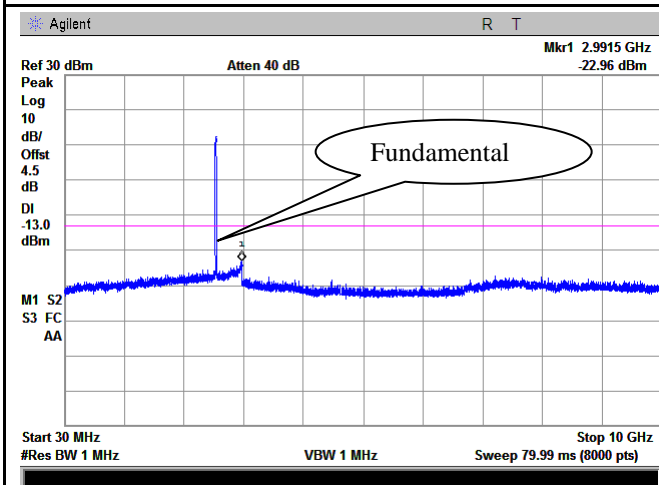

LTE Band VII - High Channel-1

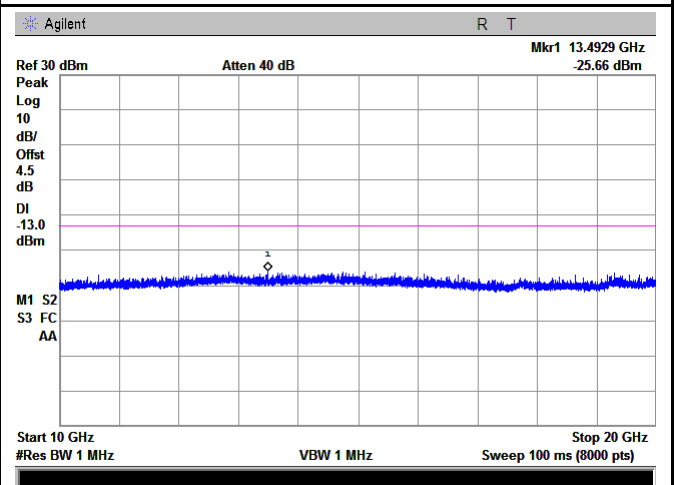

LTE Band VII - High Channel-2

LTE Band XII (Part 27)

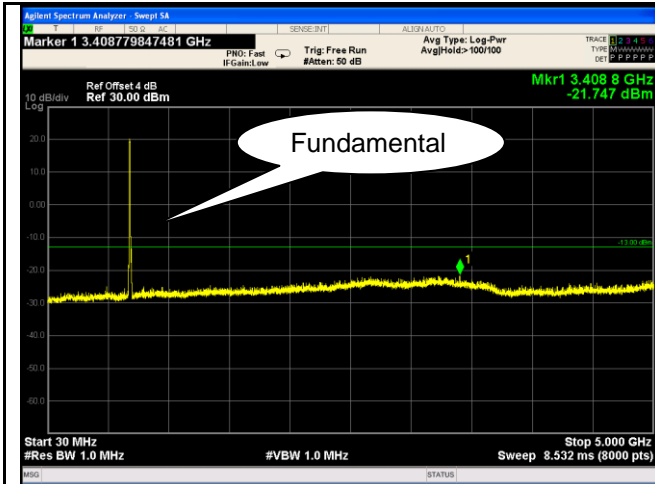

LTE Band XII - Low Channel-1

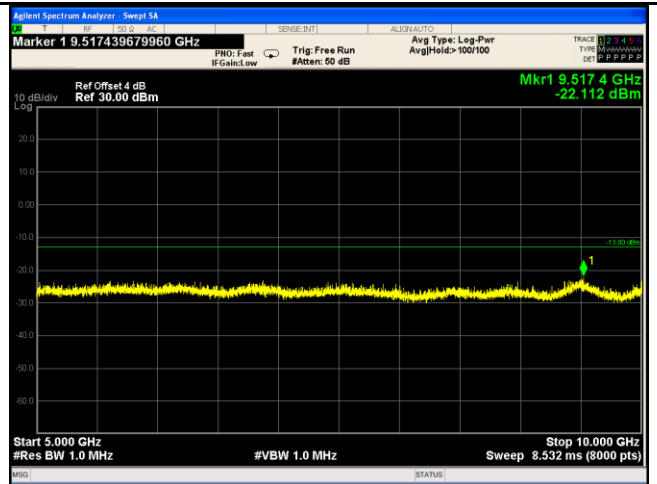

LTE Band XII - Low Channel-2

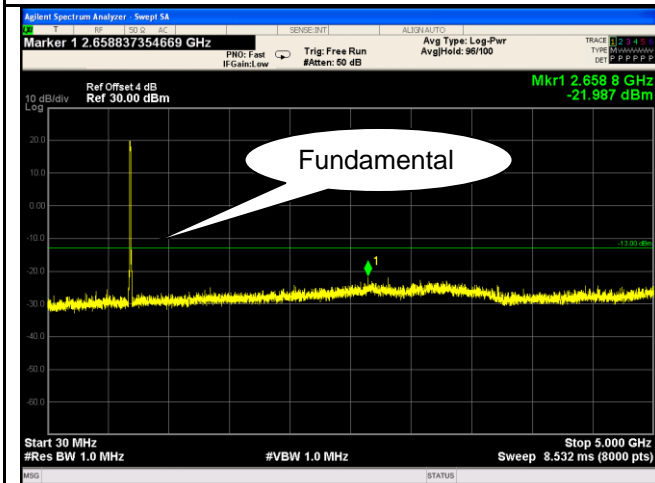

LTE Band XII - Middle Channel-1

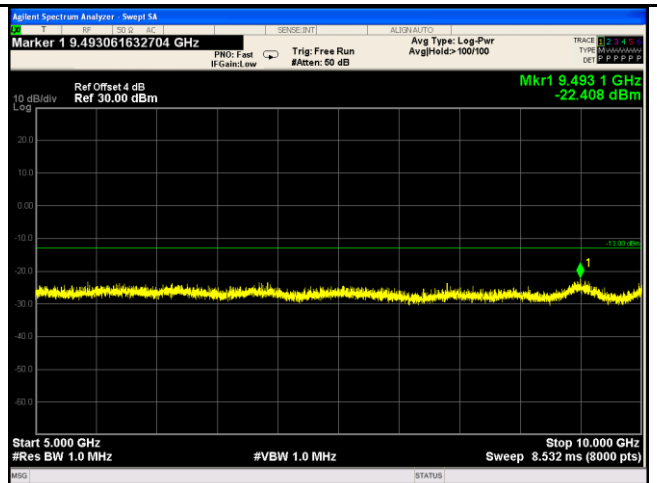

LTE Band XII - Middle Channel-2

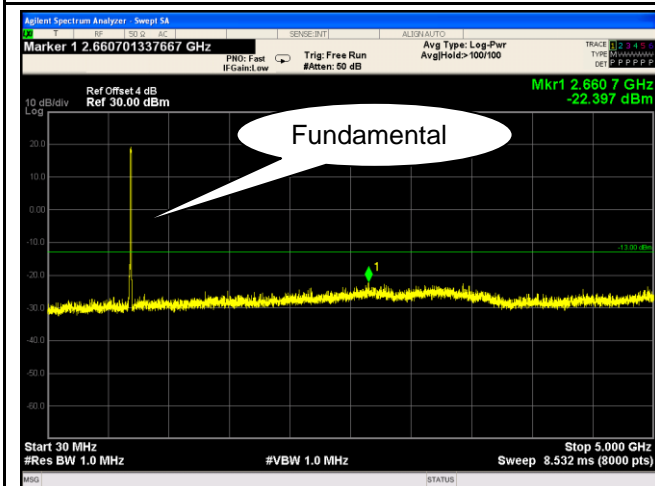

LTE Band XII - High Channel-1

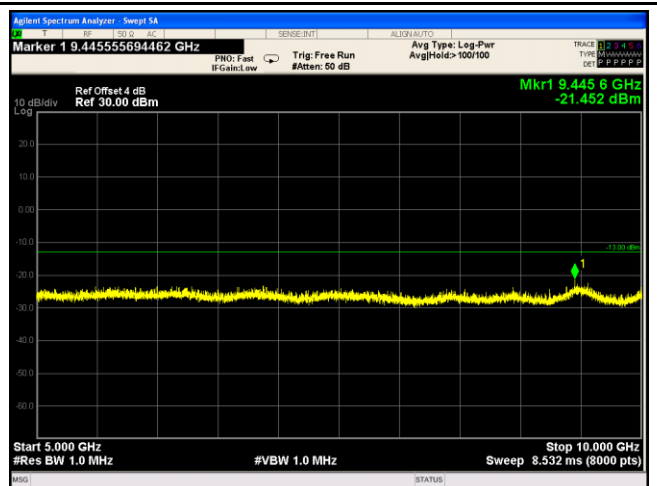

LTE Band XII - High Channel-2

6.6 Spurious Radiated Emissions

Temperature	25 °C
Relative Humidity	55%
Atmospheric Pressure	1022mbar
Test date :	November 31, 2017
Tested By :	Aaron Liang

Requirement(s):

Spec	Item	Requirement	Applicable
§2.1053, §22.917 & §24.238 § 27.53(h)	a)	The power of any emission outside of the authorized operating frequency ranges must be attenuated below the transmitter power (P) by a factor of at least $43 + 10 \log (P)$ dB. The spectrum is scanned from 30 MHz up to a frequency including its 10th harmonic.	<input checked="" type="checkbox"/>

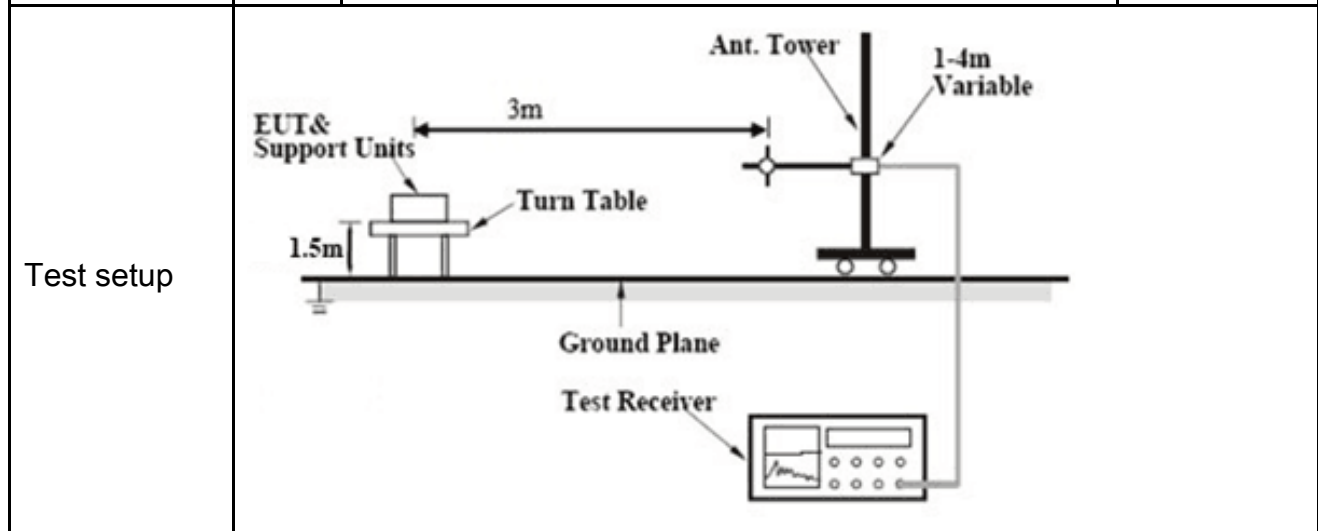

Test Procedure	<ol style="list-style-type: none"> The transmitter was placed on a wooden turntable, and it was transmitting into a non-radiating load which was also placed on the turntable. The measurement antenna was placed at a distance of 3 meters from the EUT. During the tests, the antenna height and polarization as well as EUT azimuth were varied in order to identify the maximum level of emissions from the EUT. The test was performed by placing the EUT on 3-orthogonal axis. Remove the EUT and replace it with substitution antenna. A signal generator was connected to the substitution antenna by a non-radiating cable. The absolute levels of the spurious emissions were measured by the substitution. <p>Sample Calculation:</p> $\text{EUT Field Strength} = \text{Raw Amplitude (dB}\mu\text{V/m)} - \text{Amplifier Gain (dB)} + \text{Antenna Factor (dB)} + \text{Cable Loss (dB)} + \text{Filter Attenuation (dB, if used)}$
----------------	---

Remark	
Result	<input checked="" type="checkbox"/> Pass <input type="checkbox"/> Fail

Test Data Yes N/A

Test Plot Yes (See below) N/A

LTE Band II (Part 24E) result

Low channel

Frequency (MHz)	Substituted level (dBm)	Polarity (H/V)	Antenna Gain Correction (dB)	Cable Loss (dB)	Corrected Reading (dBm)	Limit (dBm)	Margin (dB)
3720	-47.01	V	10.25	2.73	-39.49	-13	-26.49
3720	-46.36	H	10.25	2.73	-38.84	-13	-25.84
589.05	-45.35	V	6.14	0.36	-39.57	-13	-26.57
692.98	-49.14	H	6.12	0.35	-43.37	-13	-30.37

Middle channel

Frequency (MHz)	Substituted level (dBm)	Polarity (H/V)	Antenna Gain Correction (dB)	Cable Loss (dB)	Corrected Reading (dBm)	Limit (dBm)	Margin (dB)
3760	-45.94	V	10.25	2.73	-38.42	-13	-25.42
3760	-47.3	H	10.25	2.73	-39.78	-13	-26.78
455.58	-44.94	V	5.97	0.3	-39.27	-13	-26.27
621.39	-47.59	H	6.12	0.39	-41.86	-13	-28.86

High channel

Frequency (MHz)	Substituted level (dBm)	Polarity (H/V)	Antenna Gain Correction (dB)	Cable Loss (dB)	Corrected Reading (dBm)	Limit (dBm)	Margin (dB)
3800	-46.85	V	10.36	2.73	-39.22	-13	-26.22
3800	-46.52	H	10.36	2.73	-38.89	-13	-25.89
707.77	-46.15	V	6.07	0.37	-40.45	-13	-27.45
436.53	-47.08	H	5.98	0.29	-41.39	-13	-28.39

Note:

- 1, The testing has been conformed to $10 \times 1907.5 \text{ MHz} = 19,075 \text{ MHz}$
- 2, All other emissions more than 30 dB below the limit
- 3, X-Axis, Y-Axis and Z-Axis were investigated. The results above show only the worst case.
- 4, The radiated spurious test above 18GHz is subcontracted to SIEMIC (Nanjing-China) Laboratories. and found 30dB below the limit at least.

LTE Band IV (Part27) result

Low channel

Frequency (MHz)	Substituted level (dBm)	Polarity (H/V)	Antenna Gain Correction (dB)	Cable Loss (dB)	Corrected Reading (dBm)	Limit (dBm)	Margin (dB)
3440	-47.05	V	10.06	2.52	-39.51	-13	-26.51
3440	-46.47	H	10.06	2.52	-38.93	-13	-25.93
388	-44.53	V	6.01	0.29	-38.81	-13	-25.81
595.11	-48.28	H	6.06	0.36	-42.58	-13	-29.58

Middle channel

Frequency (MHz)	Substituted level (dBm)	Polarity (H/V)	Antenna Gain Correction (dB)	Cable Loss (dB)	Corrected Reading (dBm)	Limit (dBm)	Margin (dB)
3465	-47.46	V	10.09	2.52	-39.89	-13	-26.89
3465	-48.04	H	10.09	2.52	-40.47	-13	-27.47
559.55	-45.47	V	6.12	0.38	-39.73	-13	-26.73
304.7	-48.7	H	6	0.28	-42.98	-13	-29.98

High channel

Frequency (MHz)	Substituted level (dBm)	Polarity (H/V)	Antenna Gain Correction (dB)	Cable Loss (dB)	Corrected Reading (dBm)	Limit (dBm)	Margin (dB)
3490	-45.8	V	10.09	2.52	-38.23	-13	-25.23
3490	-47.48	H	10.09	2.52	-39.91	-13	-26.91
707.77	-45.64	V	6.07	0.36	-39.93	-13	-26.93
436.53	-47.19	H	5.97	0.32	-41.54	-13	-28.54

Note:

- 1, The testing has been conformed to $10 \times 1752.5 \text{ MHz} = 17,525 \text{ MHz}$
- 2, All other emissions more than 30 dB below the limit
- 3, X-Axis, Y-Axis and Z-Axis were investigated. The results above show only the worst case.

LTE Band VII (Part27) result

Low channel

Frequency (MHz)	Substituted level (dBm)	Polarity (H/V)	Antenna Gain Correction (dB)	Cable Loss (dB)	Corrected Reading (dBm)	Limit (dBm)	Margin (dB)
5020	-47.55	V	10.29	0.98	-38.24	-13	-25.24
5020	-47.06	H	10.29	0.98	-37.75	-13	-24.75
515.39	-45.33	V	5.99	0.31	-39.65	-13	-26.65
410.74	-48.24	H	5.99	0.27	-42.52	-13	-29.52

Middle channel

Frequency (MHz)	Substituted level (dBm)	Polarity (H/V)	Antenna Gain Correction (dB)	Cable Loss (dB)	Corrected Reading (dBm)	Limit (dBm)	Margin (dB)
5070	-47.26	V	10.3	0.99	-37.95	-13	-24.95
5070	-46.84	H	10.3	0.99	-37.53	-13	-24.53
410.55	-45.16	V	6.05	0.31	-39.42	-13	-26.42
583.65	-47.96	H	6.15	0.41	-42.22	-13	-29.22

High channel

Frequency (MHz)	Substituted level (dBm)	Polarity (H/V)	Antenna Gain Correction (dB)	Cable Loss (dB)	Corrected Reading (dBm)	Limit (dBm)	Margin (dB)
5120	-46.61	V	10.32	1	-37.29	-13	-24.29
5120	-46.05	H	10.32	1	-36.73	-13	-23.73
707.77	-44.92	V	6.14	0.34	-39.12	-13	-26.12
436.53	-47.24	H	6.03	0.31	-41.52	-13	-28.52

Note:

1, The testing has been conformed to $10 \times 2567.5 \text{ MHz} = 25,675 \text{ MHz}$

2, All other emissions more than 30 dB below the limit

3, X-Axis, Y-Axis and Z-Axis were investigated. The results above show only the worst case.

4, The radiated spurious test above 18GHz is subcontracted to SIEMIC (Nanjing-China) Laboratories. and found 30dB below the limit at least.

LTE Band XII (Part27) result

Low channel

Frequency (MHz)	Substituted level (dBm)	Polarity (H/V)	Antenna Gain Correction (dB)	Cable Loss (dB)	Corrected Reading (dBm)	Limit (dBm)	Margin (dB)
1408	-46.39	V	7.65	0.75	-39.49	-13	-26.49
1408	-46.6	H	7.65	0.75	-39.7	-13	-26.7
214.75	-45.64	V	5.99	0.26	-39.91	-13	-26.91
394.81	-48.63	H	5.99	0.26	-42.9	-13	-29.9

Middle channel

Frequency (MHz)	Substituted level (dBm)	Polarity (H/V)	Antenna Gain Correction (dB)	Cable Loss (dB)	Corrected Reading (dBm)	Limit (dBm)	Margin (dB)
1415	-47.41	V	7.65	0.75	-40.51	-13	-27.51
1415	-46.7	H	7.65	0.75	-39.8	-13	-26.8
482.25	-46.02	V	6.04	0.31	-40.29	-13	-27.29
270.51	-47.75	H	6.02	0.25	-41.98	-13	-28.98

High channel

Frequency (MHz)	Substituted level (dBm)	Polarity (H/V)	Antenna Gain Correction (dB)	Cable Loss (dB)	Corrected Reading (dBm)	Limit (dBm)	Margin (dB)
1422	-46.89	V	7.65	0.75	-39.99	-13	-26.99
1422	-47.56	H	7.65	0.75	-40.66	-13	-27.66
707.77	-44.83	V	6.14	0.38	-39.07	-13	-26.07
436.53	-47.01	H	6.02	0.26	-41.25	-13	-28.25

Note:

- 1, The testing has been conformed to $10 \times 715.3 \text{ MHz} = 7,153 \text{ MHz}$
- 2, All other emissions more than 30 dB below the limit
- 3, X-Axis, Y-Axis and Z-Axis were investigated. The results above show only the worst case.

6.7 Band Edge

Temperature	23 °C
Relative Humidity	55%
Atmospheric Pressure	1012mbar
Test date :	December 04, 2017
Tested By :	Aaron Liang

Requirement(s):

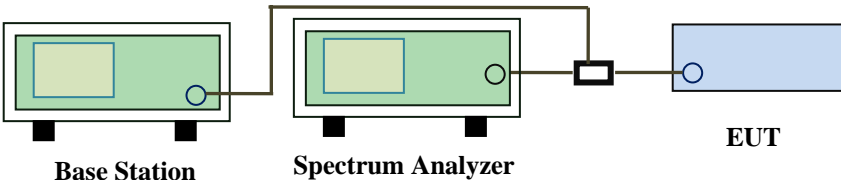
Spec	Item	Requirement	Applicable
§22.917(a) §24.238(a) § 27.53(h)	a)	The power of any emission outside of the authorized operating frequency ranges must be lower than the transmitter power (P) by a factor of at least $43 + 10 \log (P)$ dB.	<input checked="" type="checkbox"/>
Test setup	 <p>The diagram shows a Base Station (green box) connected to a Spectrum Analyzer (green box) and an EUT (blue box) via a power divider (black box). The Base Station and Spectrum Analyzer are connected to the power divider, which then splits the signal to the EUT.</p>		
Procedure	<ul style="list-style-type: none"> - The EUT was connected to Spectrum Analyzer and Base Station via power divider. - The Band Edges of low and high channels for the highest RF powers were measured. Setting RBW as roughly BW/100. 		
Remark			
Result	<input checked="" type="checkbox"/> Pass <input type="checkbox"/> Fail		

Test Data Yes N/A

Test Plot Yes (See below) N/A

LTE Band II (Part 24E) result

BW(MHz)	Channel	Frequency (MHz)	Mode	Emission (dBm)	Limit (dBm)
1.4	18607	1850	QPSK	-14.31	-13
			16QAM	-14.91	-13
1.4	18900	1910	QPSK	-15.30	-13
			16QAM	-15.62	-13
3	18615	1850	QPSK	-13.72	-13
			16QAM	-13.66	-13
3	19185	1910	QPSK	-15.18	-13
			16QAM	-14.10	-13
5	18625	1850	QPSK	-13.52	-13
			16QAM	-14.93	-13
5	19175	1910	QPSK	-15.74	-13
			16QAM	-15.50	-13
10	18650	1850	QPSK	-17.08	-13
			16QAM	-17.00	-13
10	19150	1910	QPSK	-17.93	-13
			16QAM	-17.57	-13
15	18675	1850	QPSK	-15.00	-13
			16QAM	-14.49	-13
15	19125	1910	QPSK	-19.04	-13
			16QAM	-18.93	-13
20	18700	1850	QPSK	-18.36	-13
			16QAM	-18.40	-13
20	19100	1910	QPSK	-18.90	-13
			16QAM	-19.20	-13

LTE Band IV (Part 27) result

BW(MHz)	Channel	Frequency (MHz)	Mode	Emission (dBm)	Limit (dBm)
1.4	19957	1709.9	QPSK	-22.42	-13
			16QAM	-22.49	-13
1.4	20393	1755	QPSK	-20.49	-13
			16QAM	-20.96	-13
3	19965	1709.9	QPSK	-18.86	-13
			16QAM	-18.44	-13
3	20385	1755	QPSK	-19.16	-13
			16QAM	-19.57	-13
5	19975	1709.9	QPSK	-15.13	-13
			16QAM	-17.94	-13
5	20375	1755	QPSK	-17.24	-13
			16QAM	-17.09	-13
10	20000	1709.9	QPSK	-16.97	-13
			16QAM	-19.43	-13
10	20350	1755	QPSK	-18.95	-13
			16QAM	-17.86	-13
15	20025	1709.9	QPSK	-20.59	-13
			16QAM	-20.43	-13
15	20325	1755	QPSK	-19.06	-13
			16QAM	-20.03	-13
20	20050	1709.9	QPSK	-23.81	-13
			16QAM	-23.30	-13
20	20300	1755	QPSK	-21.09	-13
			16QAM	-21.53	-13

LTE Band XII (Part 27) result

BW(MHz)	Channel	Frequency (MHz)	Mode	Emission (dBm)	Limit (dBm)
1.4	23017	699	QPSK	-28.650	-13
			16QAM	-29.267	-13
1.4	23173	716	QPSK	-28.202	-13
			16QAM	-28.512	-13
3	23025	699	QPSK	-20.999	-13
			16QAM	-20.540	-13
3	23165	716	QPSK	-19.406	-13
			16QAM	-20.509	-13
5	23035	699	QPSK	-15.730	-13
			16QAM	-16.774	-13
5	23155	716	QPSK	-17.396	-13
			16QAM	-17.352	-13
10	23060	698	QPSK	-17.438	-13
			16QAM	-17.479	-13
10	23130	716	QPSK	-15.949	-13
			16QAM	-15.913	-13

Test Plots

LTE Band II (Part 24E)

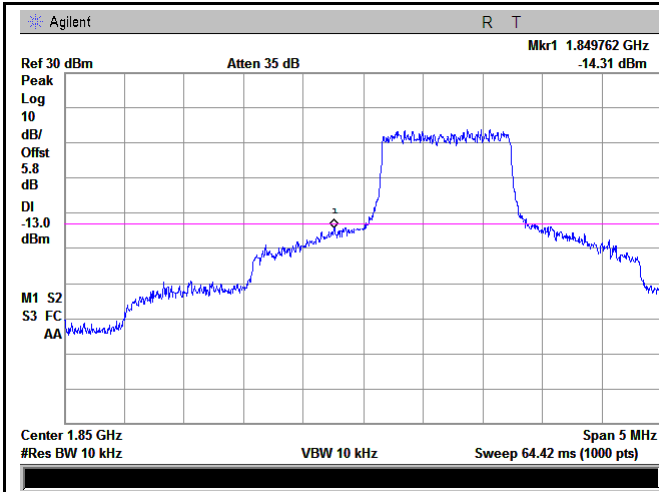

LTE Band II - Low Channel QPSK-1.4

Note: Offset=Cable loss (4.5) + 10log
(13.60)=4.5+1.3=5.8dB

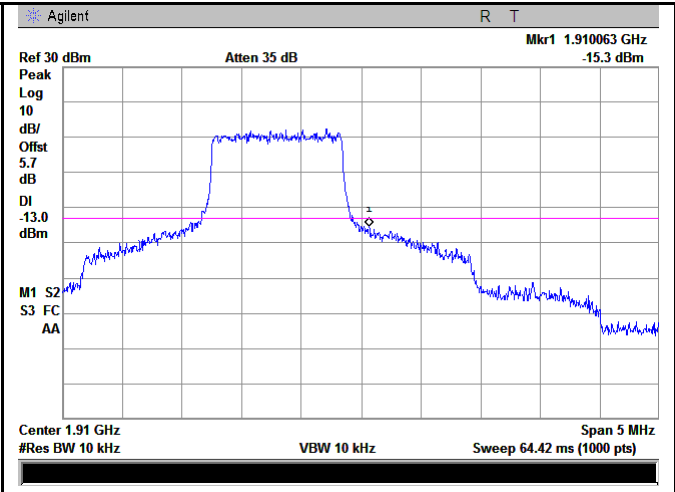

LTE Band II - High Channel QPSK-1.4

Note: Offset=Cable loss (4.5) + 10log
(13.14)=4.5+1.2=5.7dB

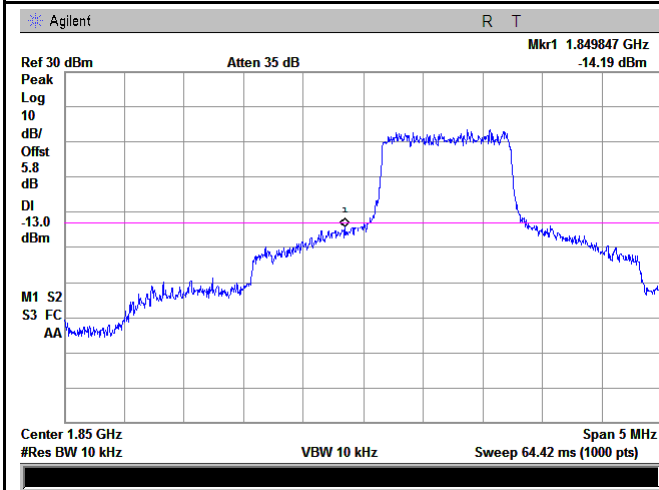

LTE Band II - Low Channel 16QAM-1.4

Note: Offset=Cable loss (4.5) + 10log
(13.58/10)=4.5+1.3=5.8 dB

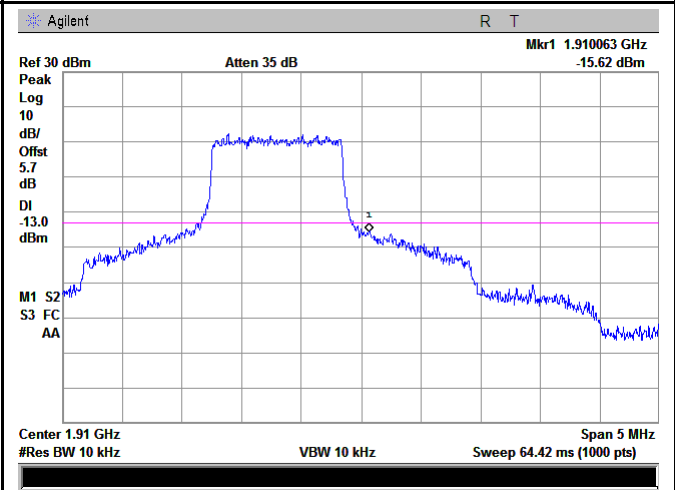

LTE Band II - High Channel 16QAM-1.4

Note: Offset=Cable loss (4.5) + 10log
(13.09/10)=4.5+1.2=5.7 dB

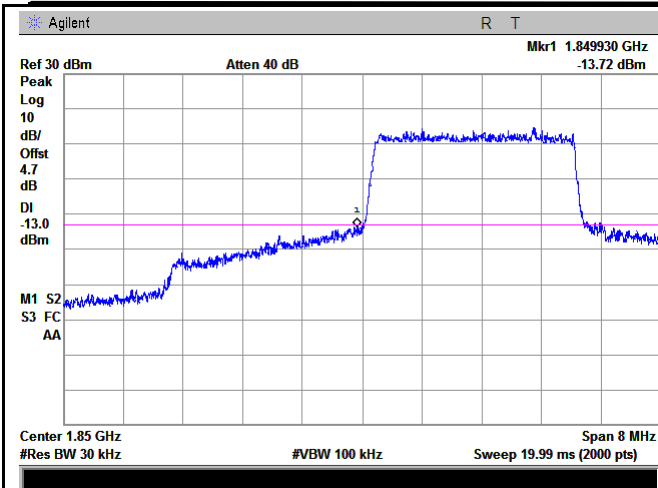

LTE Band II - Low Channel QPSK-3

Note: Offset=Cable loss (4.5) + 10log
(31.29/30)=4.5+0.2=4.7 dB

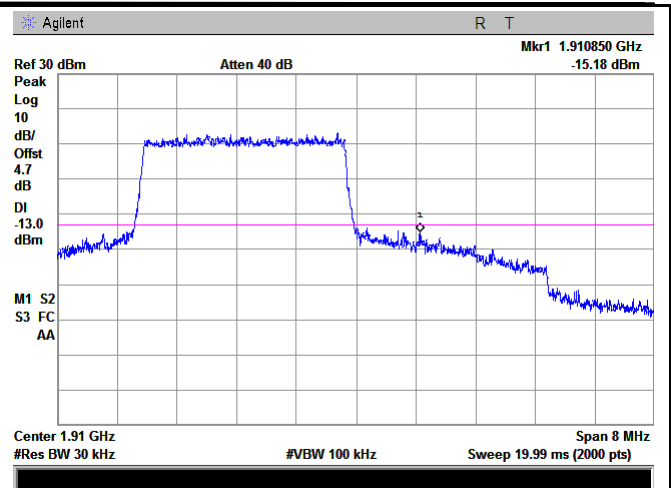

LTE Band II - High Channel QPSK-3

Note: Offset=Cable loss (4.5) + 10log
(31.26/30)=4.5+0.2=4.7 dB

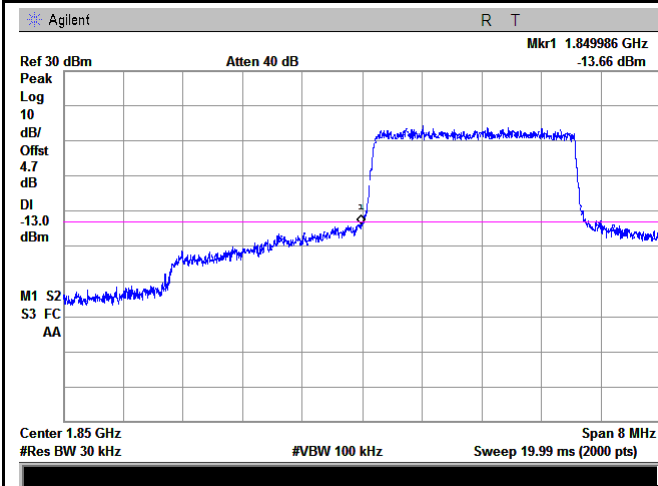

LTE Band II - Low Channel 16QAM-3

Note: Offset=Cable loss (4.5) + 10log
(31.14/30)=4.5+0.2=4.7 dB

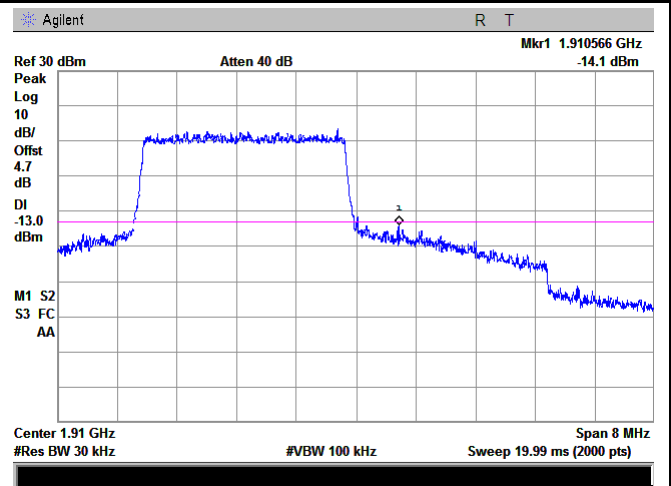

LTE Band II - High Channel 16QAM-3

Note: Offset=Cable loss (4.5) + 10log
(31.20/30)=4.5+0.2=4.7 dB

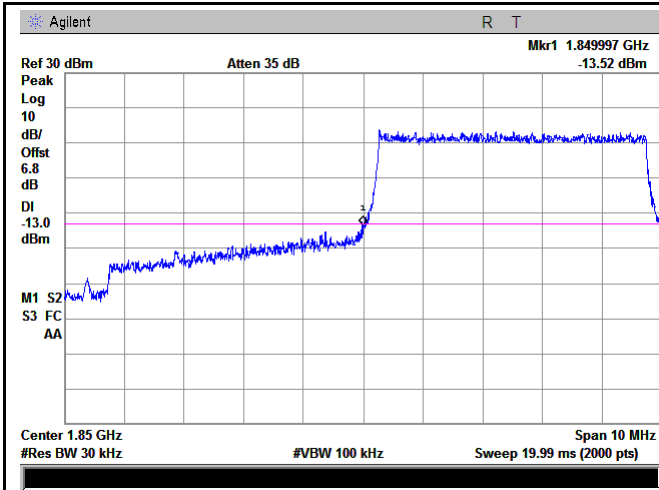

LTE Band II - Low Channel QPSK-5

Note: Offset=Cable loss (4.5) + 10log
(51.03/30)=4.5+2.3=6.8 dB

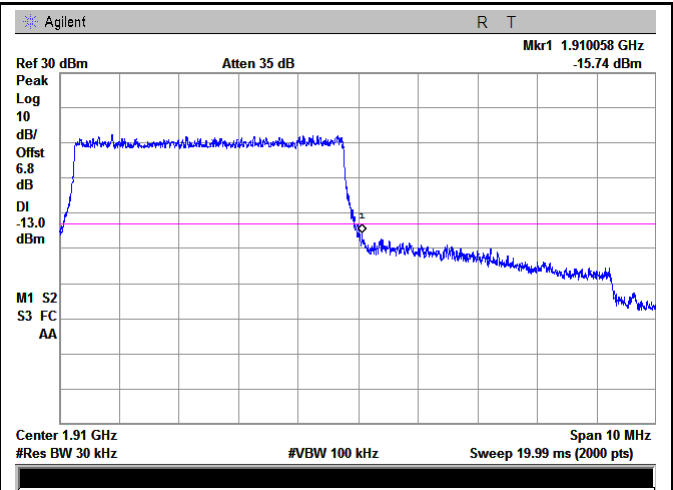

LTE Band II - High Channel QPSK-5

Note: Offset=Cable loss (4.5) + 10log
(50.90/30)=4.5+2.3=6.8 dB

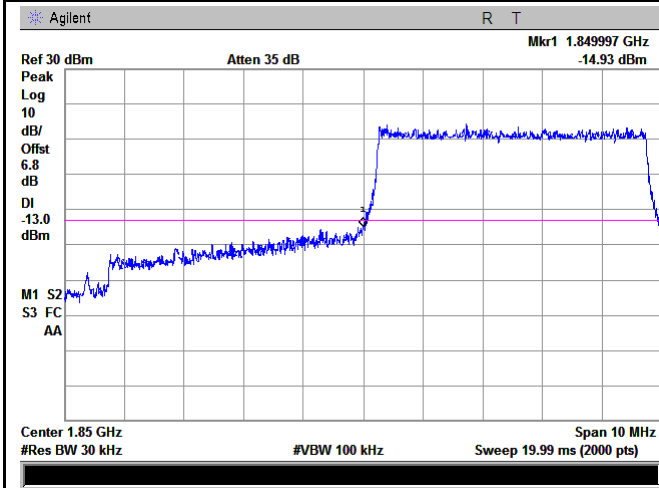

LTE Band II - Low Channel 16QAM-5

Note: Offset=Cable loss (4.5) + 10log
(50.94/30)=4.5+2.3=6.8 dB

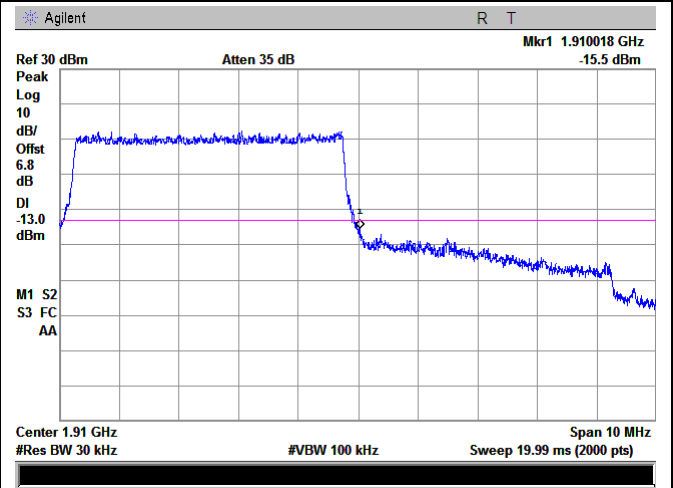

LTE Band II - High Channel 16QAM-5

Note: Offset=Cable loss (4.5) + 10log
(50.97/30)=4.5+2.3=6.8 dB

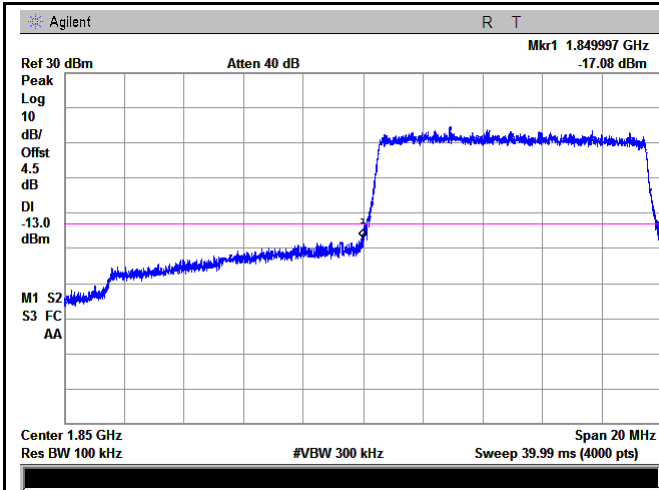

LTE Band II - Low Channel QPSK-10

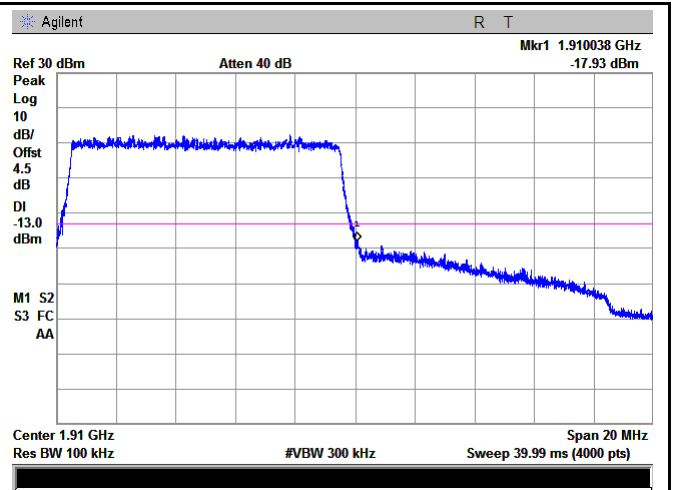

LTE Band II - High Channel QPSK-10

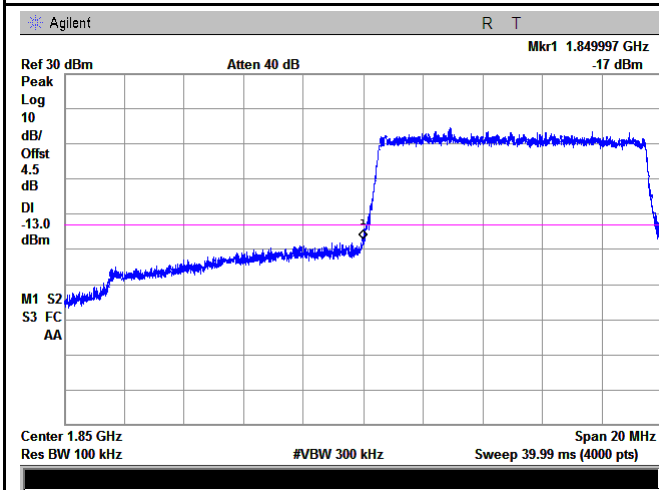

LTE Band II - Low Channel 16QAM-10

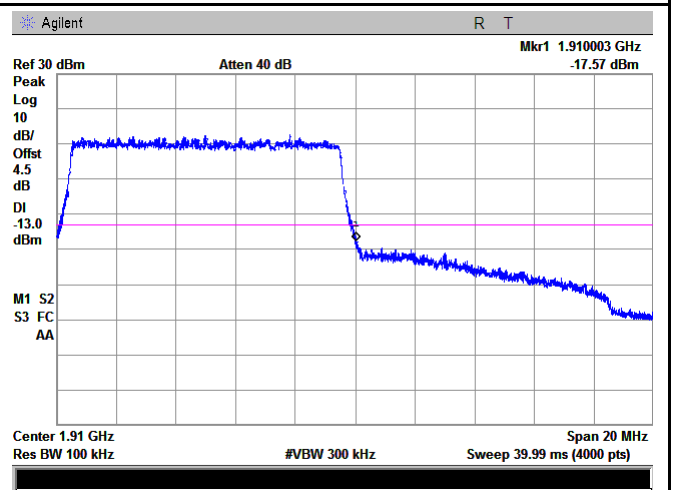

LTE Band II - High Channel 16QAM-10

Note: Offset=Cable loss (4.5) + 10log
(103.13/100)=4.5+0.0=4.5 dB

Note: Offset=Cable loss (4.5) + 10log
(102.62/100)=4.5+0.0=4.5 dB

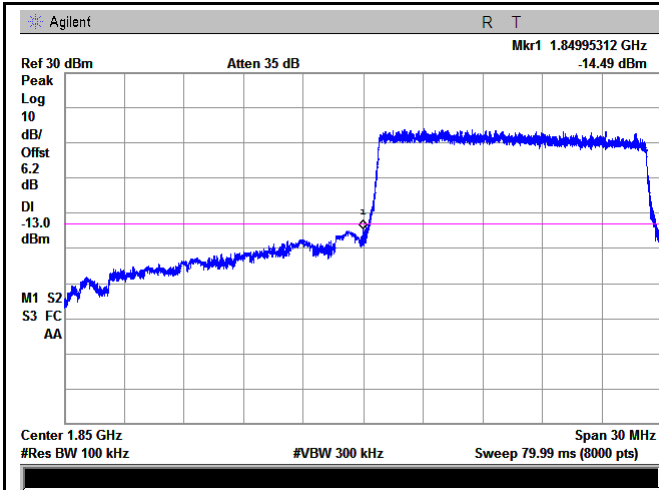

LTE Band II - Low Channel QPSK-15

Note: Offset=Cable loss (4.5) + 10log
(148.19/100)=4.5+1.7=6.2 dB

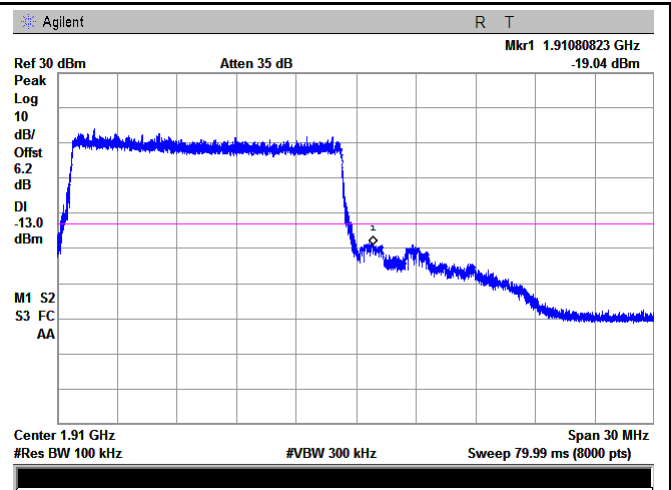

LTE Band II - High Channel QPSK-15

Note: Offset=Cable loss (4.5) + 10log
(148.64/100)=4.5+1.7=6.2 dB

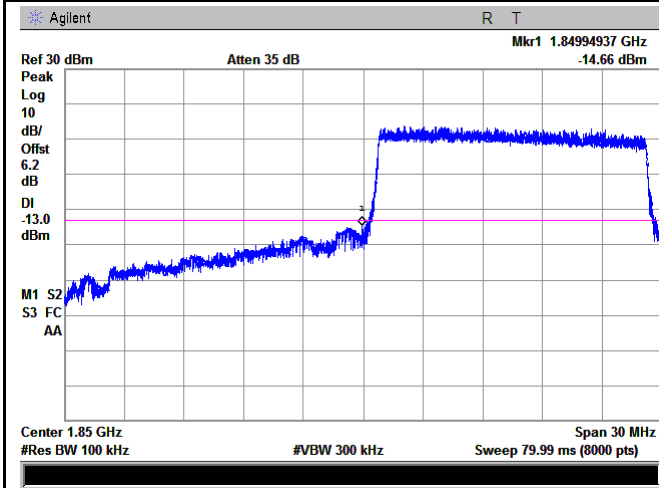

LTE Band II - Low Channel 16QAM-15

Note: Offset=Cable loss (4.5) + 10log
(148.03/100)=4.5+1.7=6.2 dB

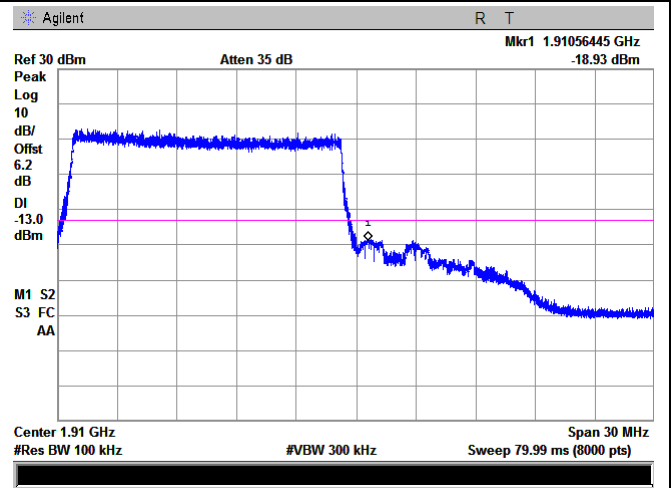

LTE Band II - High Channel 16QAM-15

Note: Offset=Cable loss (4.5) + 10log
(148.64/100)=4.5+1.7=6.2 dB

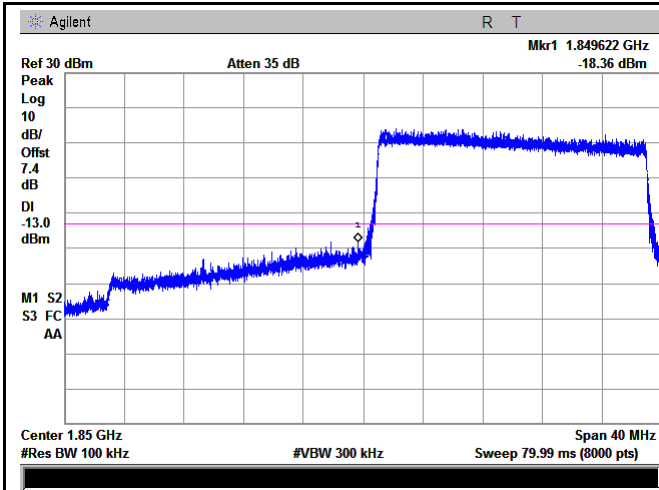

LTE Band II - Low Channel QPSK-20

Note: Offset=Cable loss (4.5) + 10log
(194.29/100)=4.5+2.9=7.4 dB

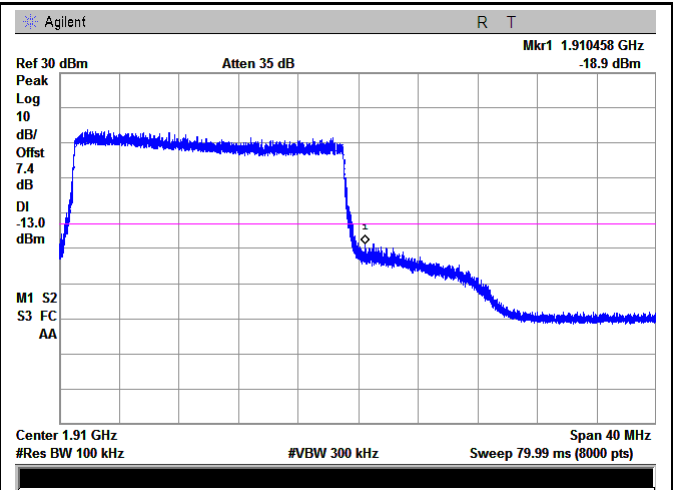

LTE Band II - High Channel QPSK-20

Note: Offset=Cable loss (4.5) + 10log
(194.64/100)=4.5+2.9=7.4 dB

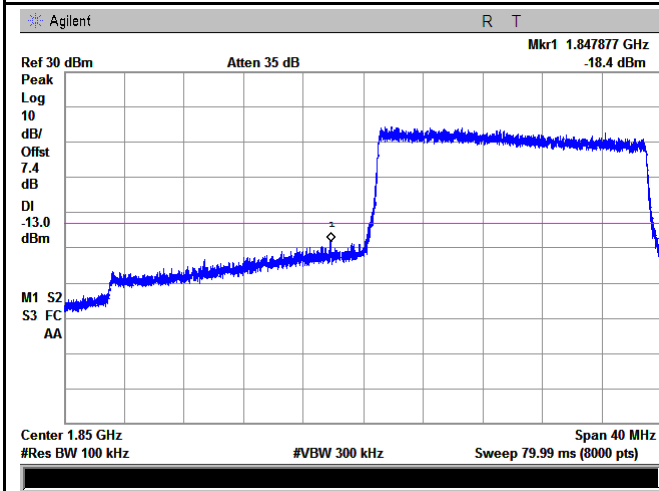

LTE Band II - Low Channel 16QAM-20

Note: Offset=Cable loss (4.5) + 10log
(194.20/100)=4.5+2.9=7.4 dB

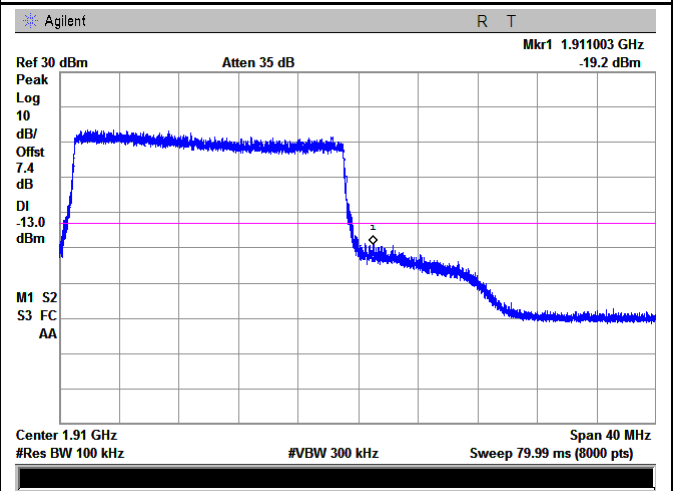

LTE Band II - High Channel 16QAM-20

Note: Offset=Cable loss (4.5) + 10log
(194.08/100)=4.5+2.9=7.4 dB

LTE Band IV (Part 27)

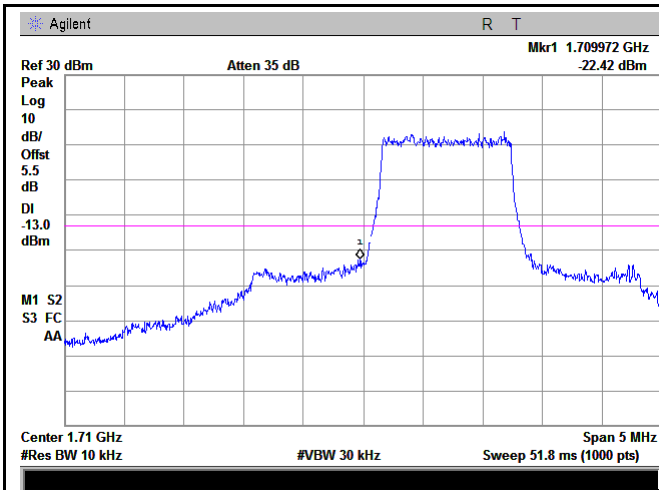

LTE Band IV - Low Channel QPSK-1.4

Note: Offset=Cable loss (4.5) + 10log
 $(12.72/10)=4.5+1.0=5.5$ dB

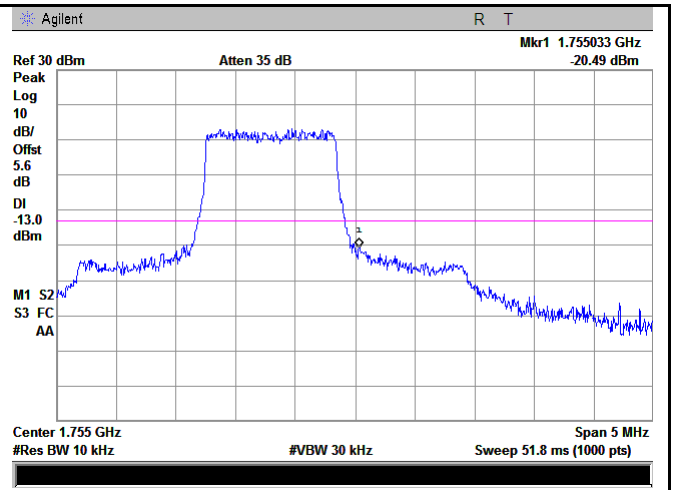

LTE Band IV - High Channel QPSK-1.4

Note: Offset=Cable loss (4.5) + 10log
 $(12.77/10)=4.5+1.1=5.6$ dB

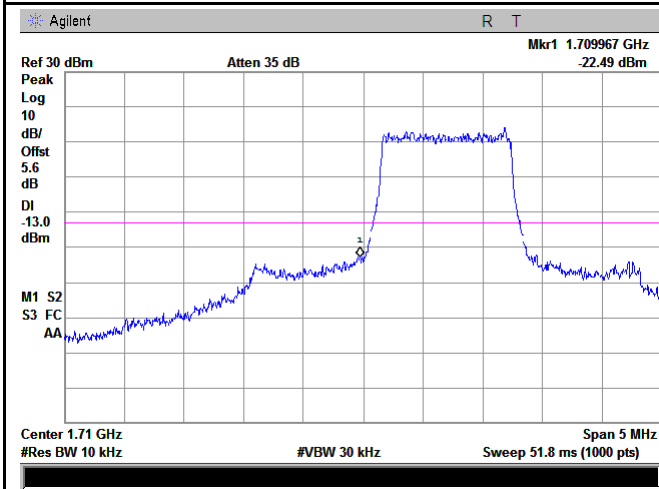

LTE Band IV - Low Channel 16QAM-1.4

Note: Offset=Cable loss (4.5) + 10log
 $(12.74/10)=4.5+1.1=5.6$ dB

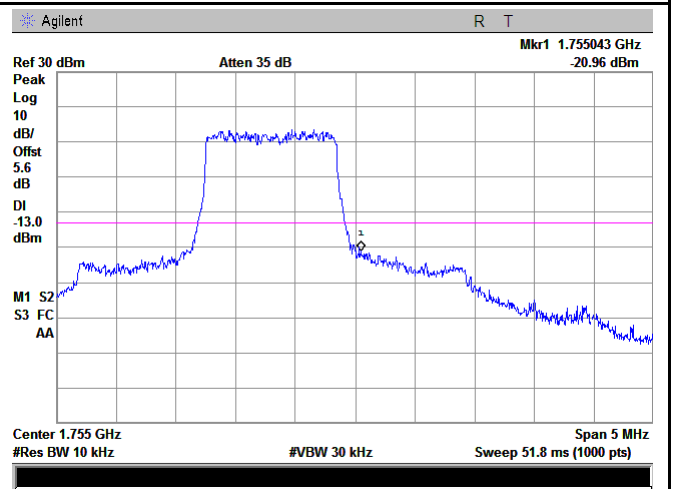

LTE Band IV - High Channel 16QAM-1.4

Note: Offset=Cable loss (4.5) + 10log
 $(12.79/10)=4.5+1.1=5.6$ dB

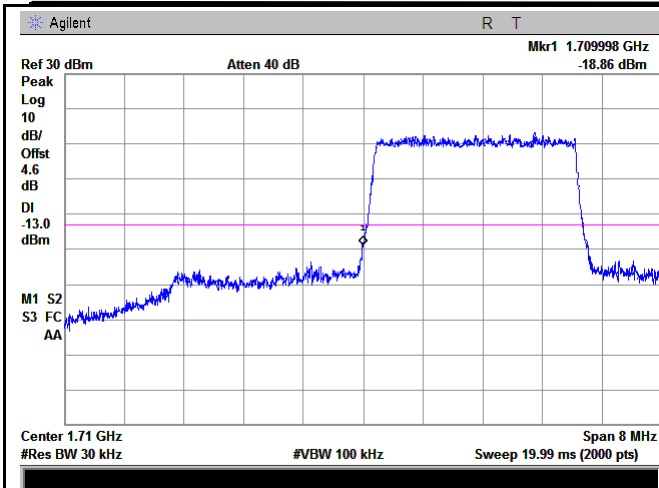

LTE Band IV - Low Channel QPSK-3

Note: Offset=Cable loss (4.5) + 10log
(30.81/30)=4.5+0.1=4.6 dB

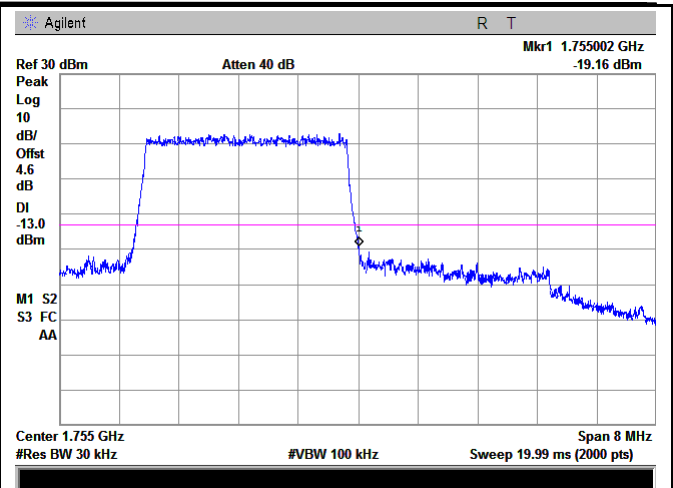

LTE Band IV - High Channel QPSK-3

Note: Offset=Cable loss (4.5) + 10log
(30.96/30)=4.5+0.1=4.6 dB

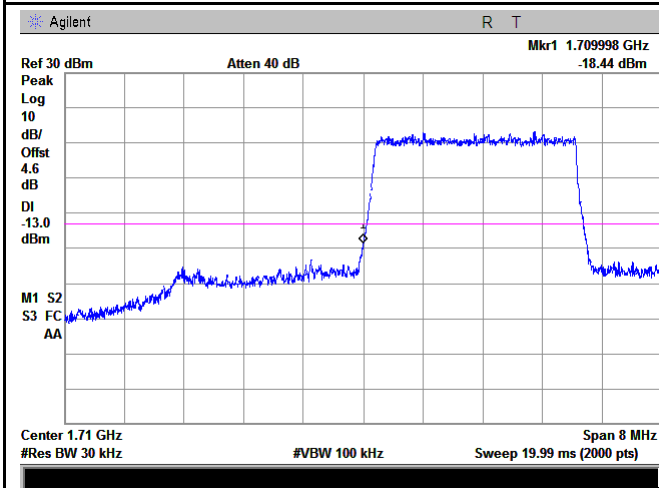

LTE Band IV - Low Channel 16QAM-3

Note: Offset=Cable loss (4.5) + 10log
(30.84/30)=4.5+0.1=4.6 dB

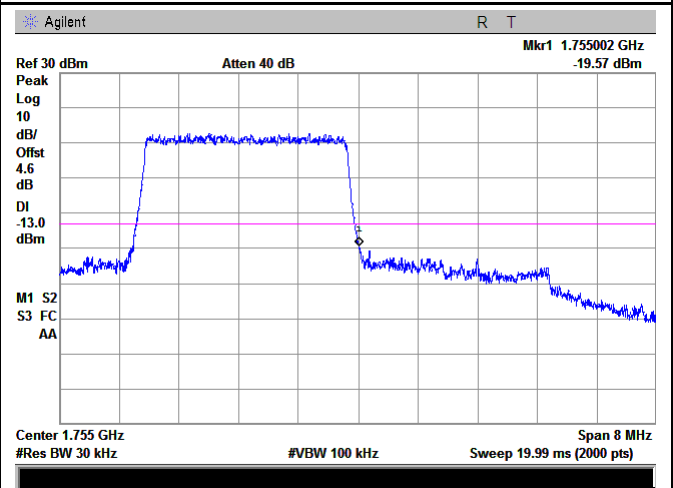

LTE Band IV - High Channel 16QAM-3

Note: Offset=Cable loss (4.5) + 10log
(30.97/30)=4.5+0.1=4.6 dB

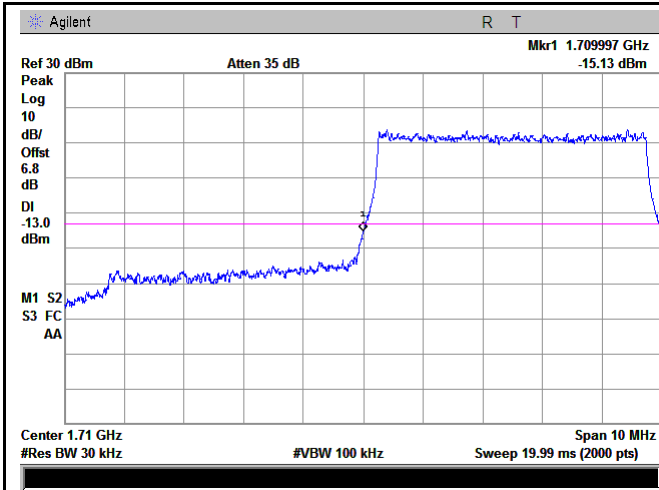

LTE Band IV - Low Channel QPSK-5

Note: Offset=Cable loss (4.5) + 10log
(50.80/30)=4.5+2.3=6.8 dB

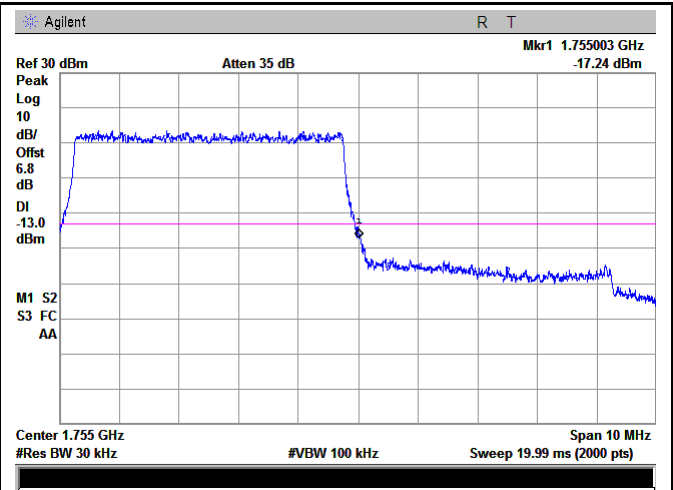

LTE Band IV - High Channel QPSK-5

Note: Offset=Cable loss (4.5) + 10log
(50.79/30)=4.5+2.3=6.8 dB

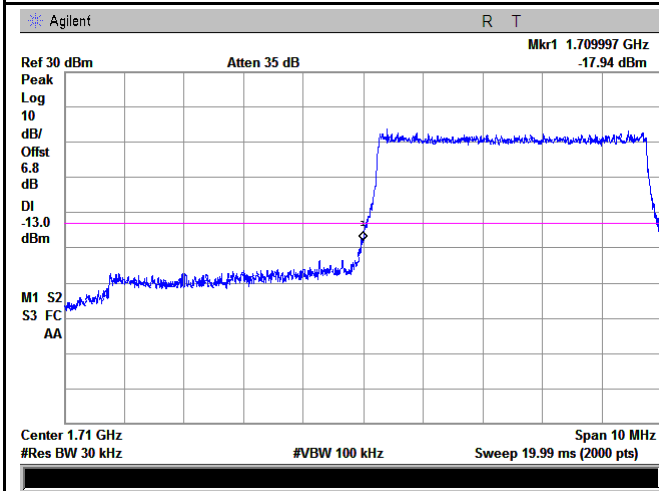

LTE Band IV - Low Channel 16QAM-5

Note: Offset=Cable loss (4.5) + 10log
(50.88/30)=4.5+2.3=6.8 dB

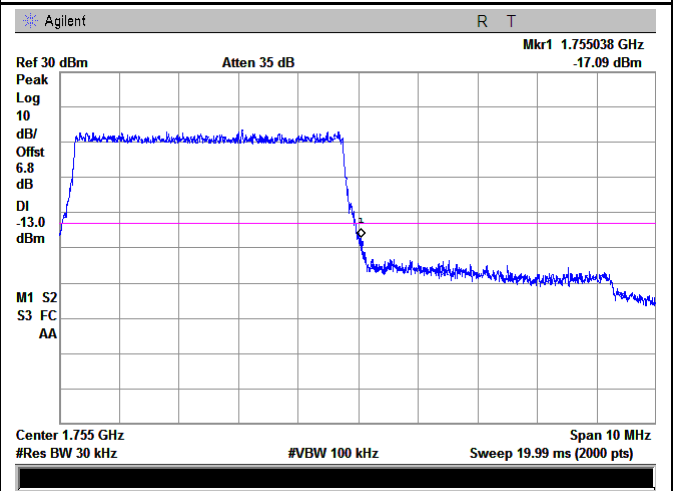

LTE Band IV - High Channel 16QAM-5

Note: Offset=Cable loss (4.5) + 10log
(50.78/30)=4.5+2.3=6.8 dB

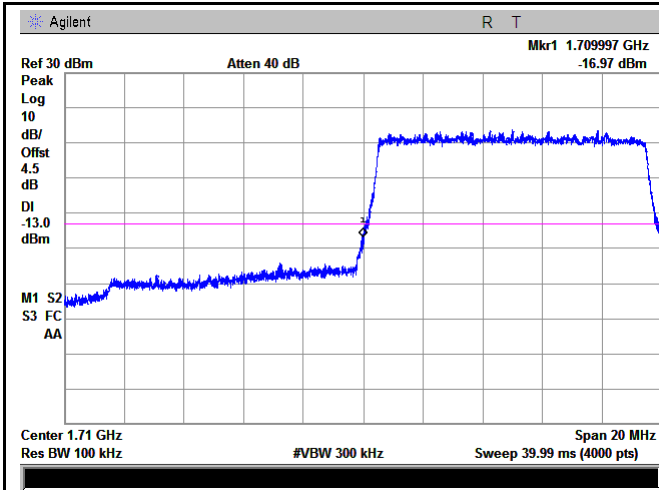

LTE Band IV - Low Channel QPSK-10

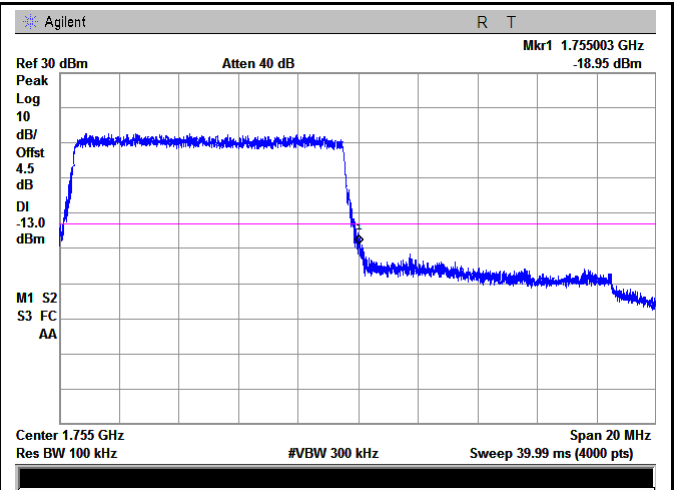

LTE Band IV - High Channel QPSK-10

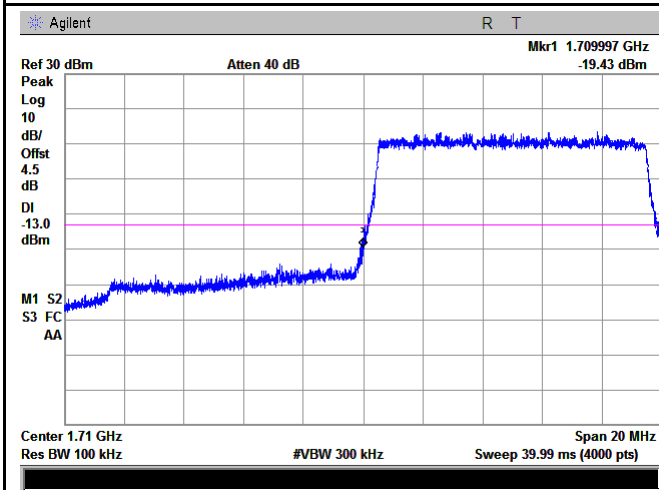

LTE Band IV - Low Channel 16QAM-10

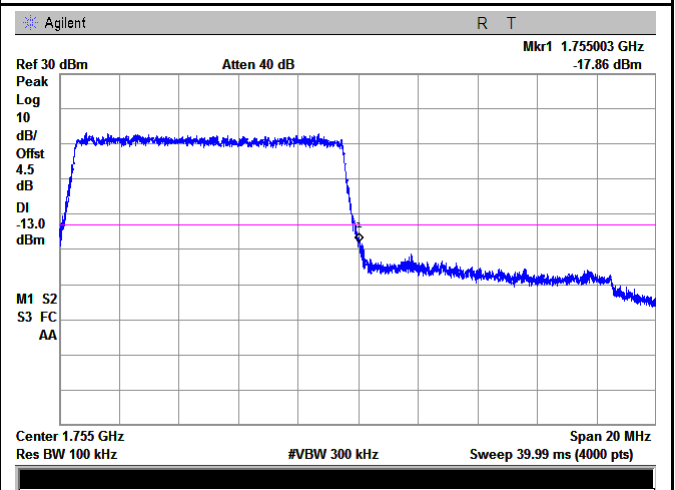

LTE Band IV - High Channel 16QAM-10

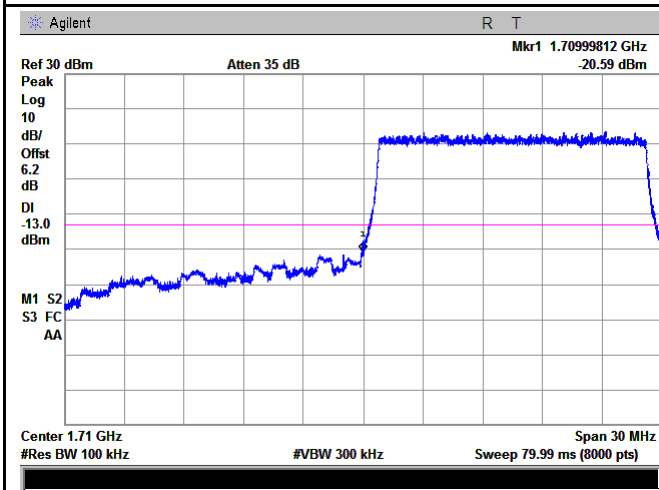

LTE Band IV - Low Channel QPSK-15

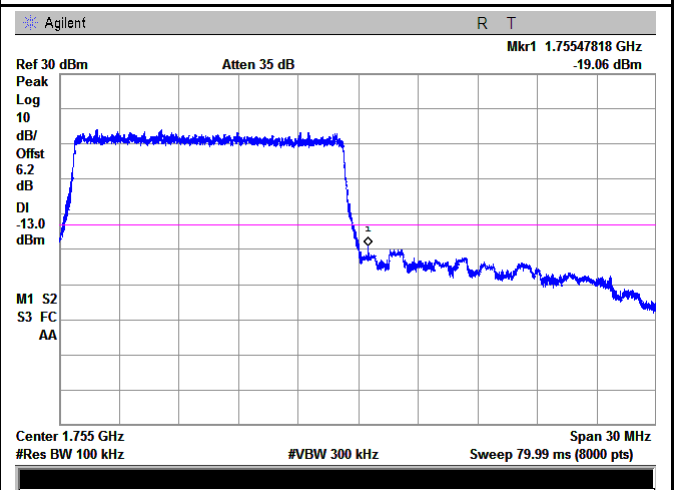

LTE Band IV - High Channel QPSK-15

Note: Offset=Cable loss (4.5) + 10log
(148.61/100)=4.5+1.7=6.2 dB

Note: Offset=Cable loss (4.5) + 10log
(14.941/100)=4.5+1.7=6.2 dB

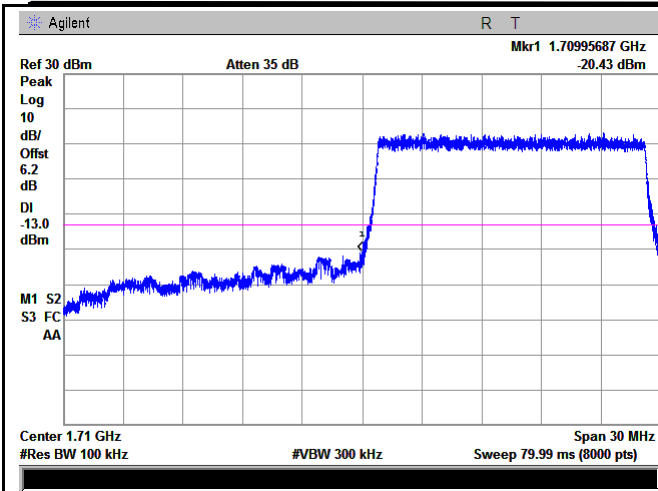

LTE Band IV - Low Channel 16QAM-15

Note: Offset=Cable loss (4.5) + 10log
 (148.34/100)=4.5+1.7=6.2 dB

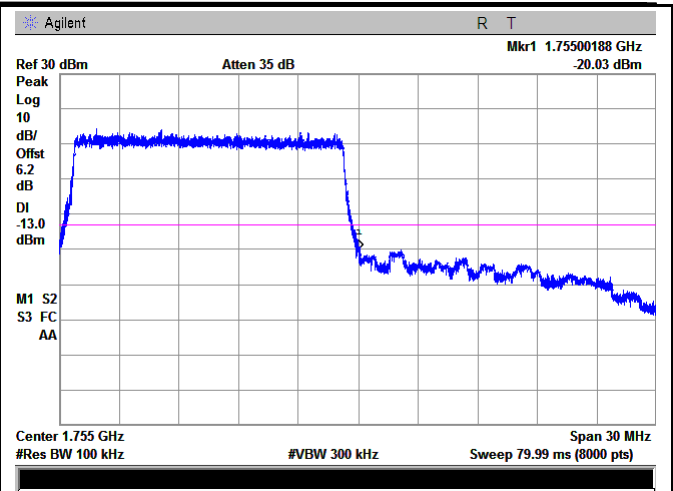

LTE Band IV - High Channel 16QAM-15

Note: Offset=Cable loss (4.5) + 10log
 (149.07/100)=4.5+1.7=6.2 dB

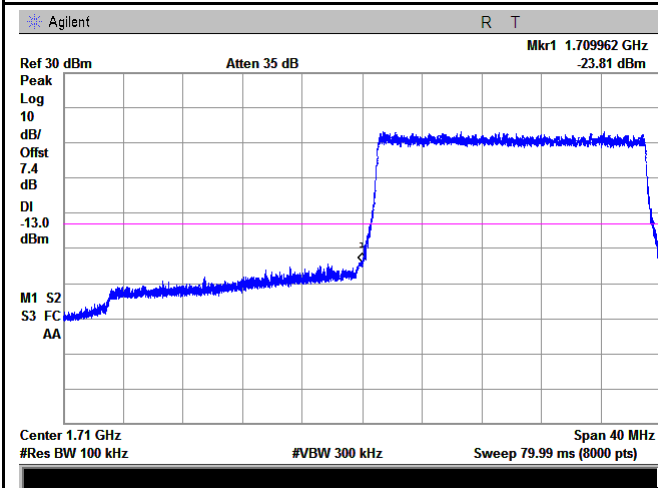

LTE Band IV - Low Channel QPSK-20

Note: Offset=Cable loss (4.5) + 10log
 (195.0/100)=4.5+2.9=7.4 dB

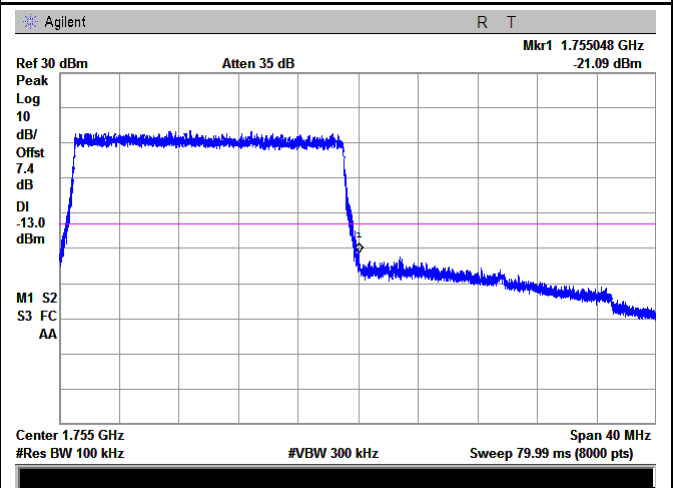

LTE Band IV - High Channel QPSK-20

Note: Offset=Cable loss (4.5) + 10log
 (194.18/100)=4.5+2.9=7.4 dB

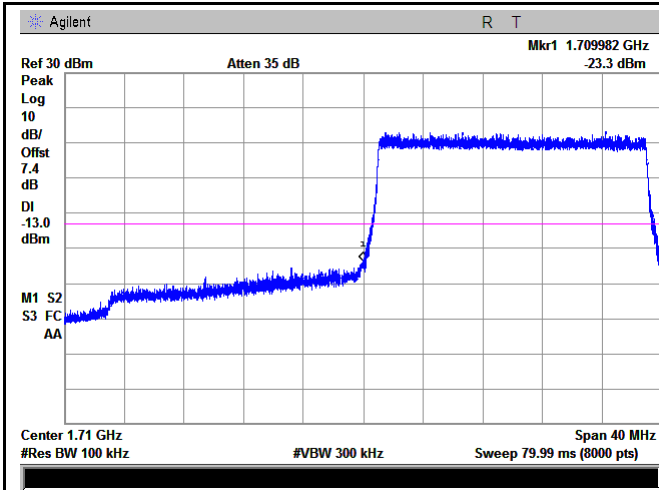

LTE Band IV - Low Channel 16QAM-20

Note: Offset=Cable loss (4.5) + 10log
(194.51/100)=4.5+2.9=7.4dB

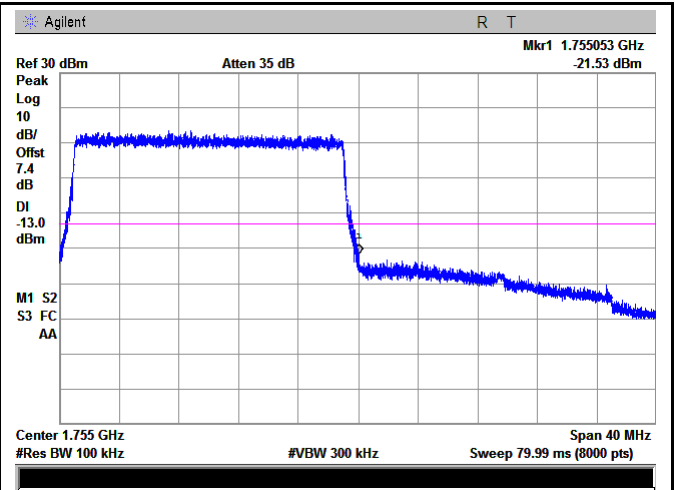

LTE Band IV - High Channel 16QAM-20

Note: Offset=Cable loss (4.5) + 10log
(194.18/100)=4.5+2.9=7.4 dB

LTE Band XII (Part 27)

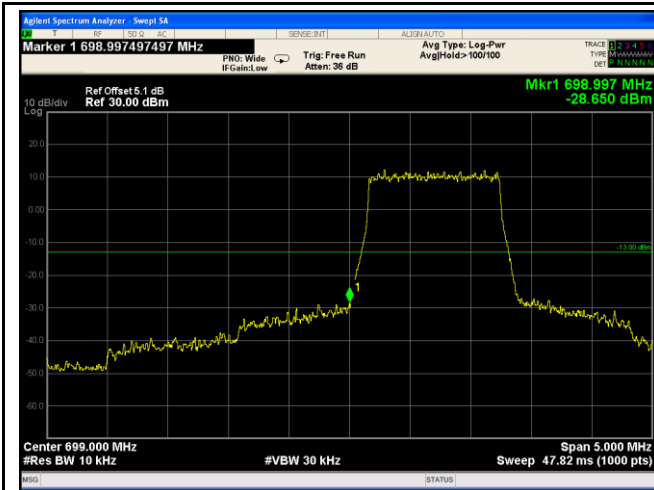

LTE Band XII - Low Channel QPSK-1.4

Note: Offset=Cable loss (4.5) + 10log
(12.96/10)=4.0+1.1=5.1 dB

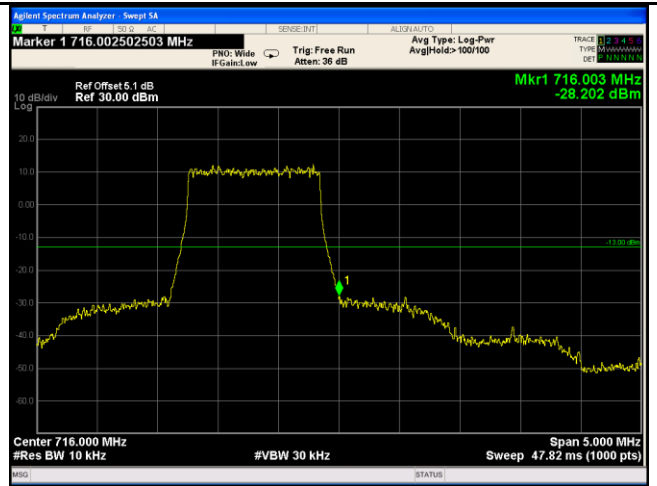

LTE Band XII - High Channel QPSK-1.4

Note: Offset=Cable loss (4.5) + 10log
(12.90/10)=4.0+1.1=5.1 dB

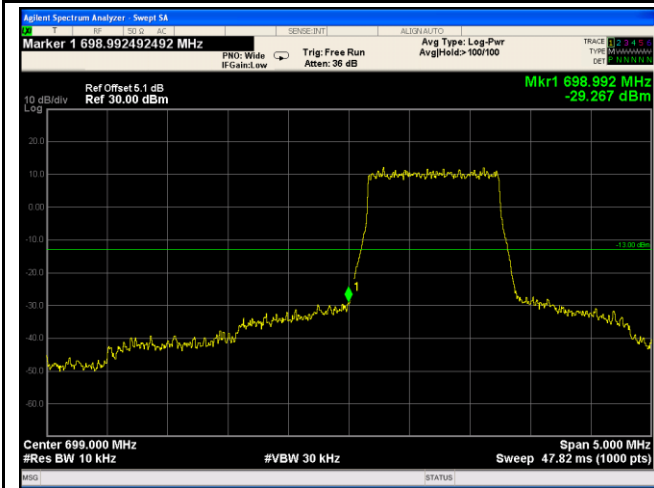

LTE Band XII - Low Channel 16QAM-1.4

Note: Offset=Cable loss (4.5) + 10log
(12.99/10)=4.0+1.1=5.1 dB

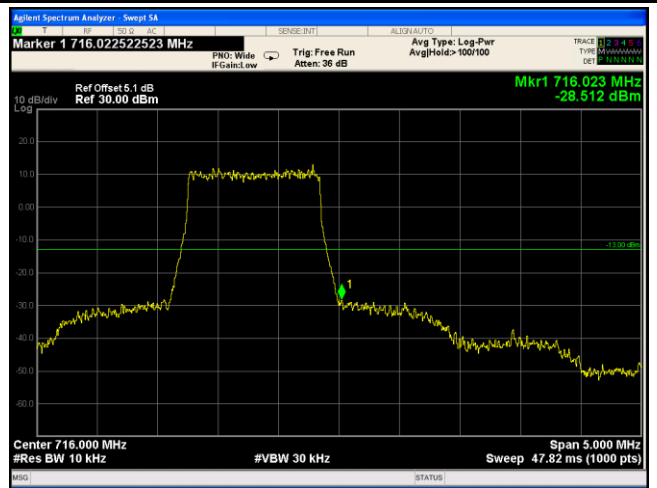

LTE Band XII - High Channel 16QAM-1.4

Note: Offset=Cable loss (4.5) + 10log
(12.84/10)=4.0+1.1=5.1 dB



LTE Band XII - Low Channel QPSK-3

Note: Offset=Cable loss (4.5) + 10log
(30.54/30)=4.0+0.1=4.1 dB

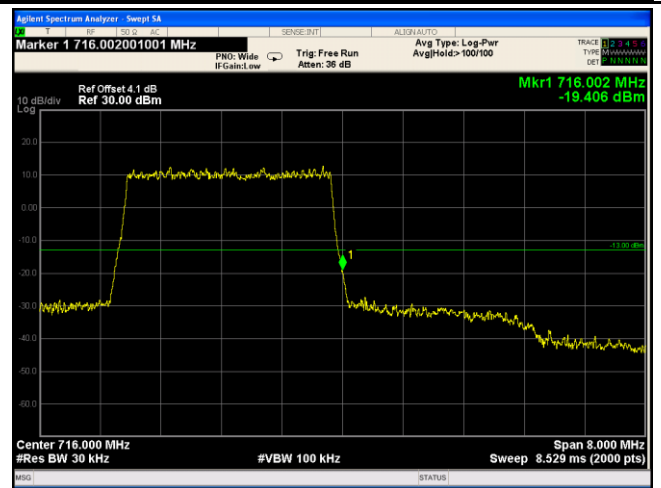

LTE Band XII - High Channel QPSK-3

Note: Offset=Cable loss (4.5) + 10log
(30.53/30)=4.0+0.1=4.1 dB

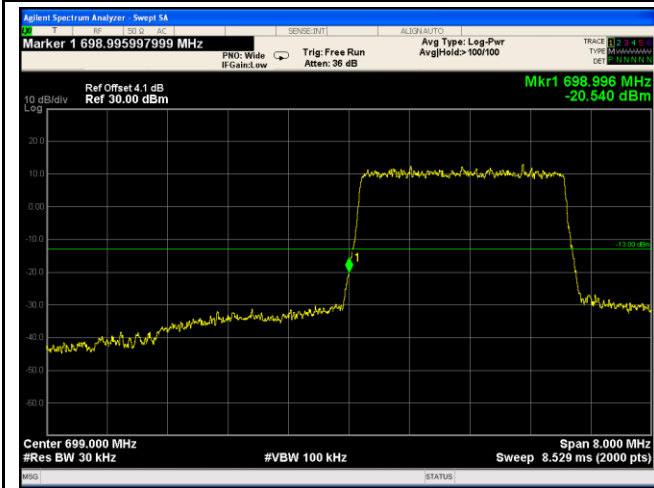

LTE Band XII - Low Channel 16QAM-3

Note: Offset=Cable loss (4.5) + 10log
(30.53/30)=4.0+0.1=4.1 dB

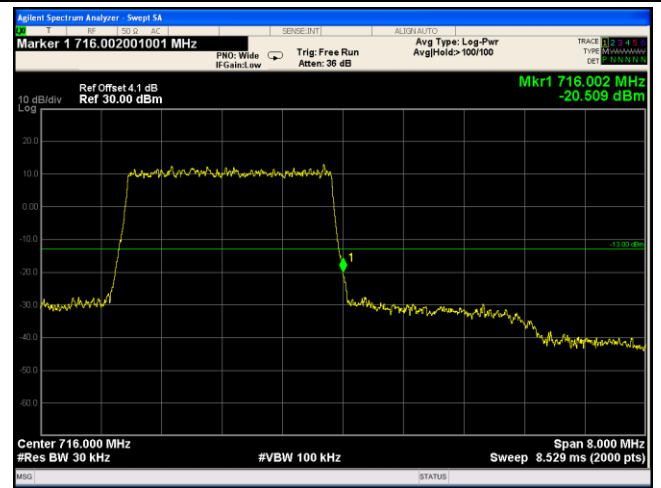

LTE Band XII - High Channel 16QAM-3

Note: Offset=Cable loss (4.5) + 10log
(30.62/30)=4.0+0.1=4.1 dB

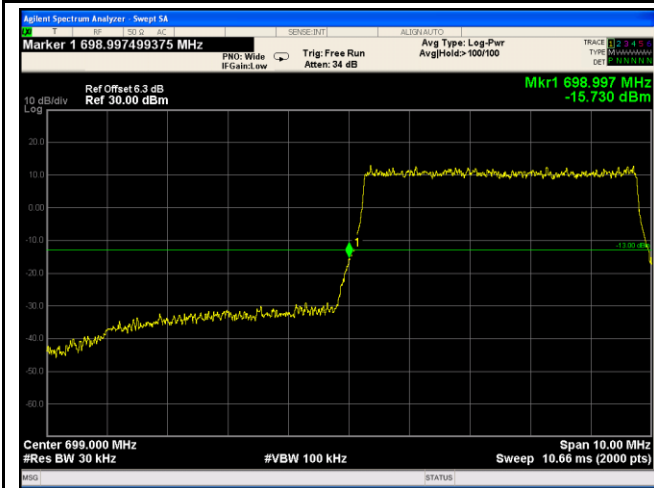

LTE Band XII - Low Channel QPSK-5

Note: Offset=Cable loss (4.5) + 10log
(51.07/30)=4.0+2.3=6.3 dB

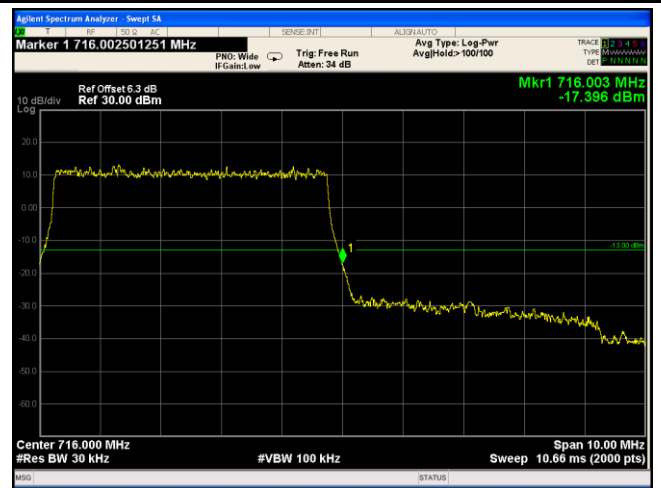

LTE Band XII - High Channel QPSK-5

Note: Offset=Cable loss (4.5) + 10log
(50.65/30)=4.0+2.3=6.3 dB

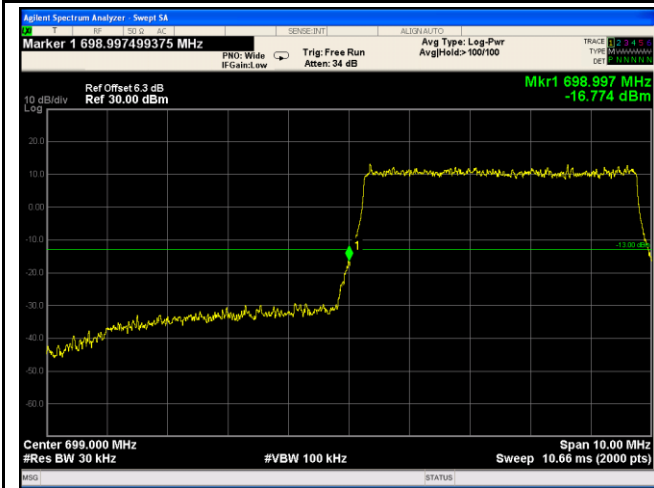

LTE Band XII - Low Channel 16QAM-5

Note: Offset=Cable loss (4.5) + 10log
(51.05/30)=4.0+2.3=6.3 dB

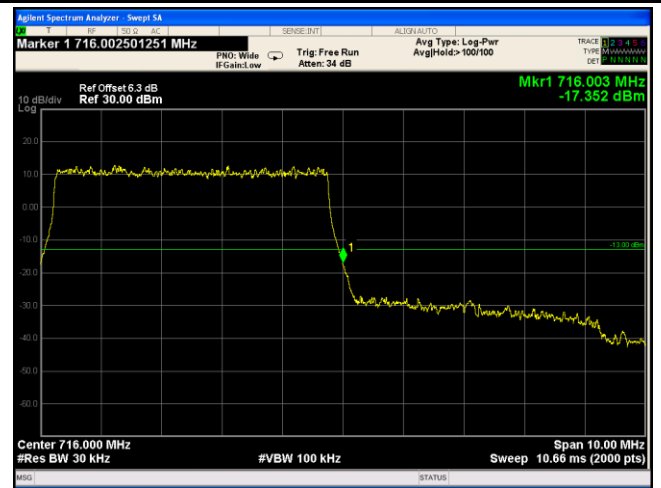

LTE Band XII - High Channel 16QAM-5

Note: Offset=Cable loss (4.5) + 10log
(50.68/30)=4.0+2.3=6.3 dB

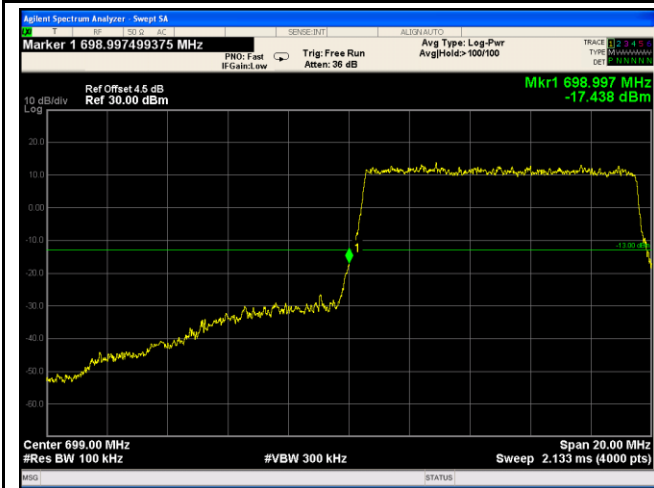

LTE Band XII - Low Channel QPSK-10

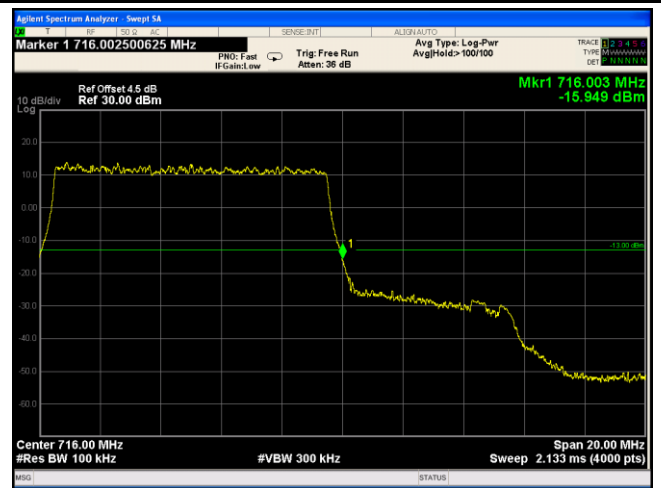

LTE Band XII - High Channel QPSK-10

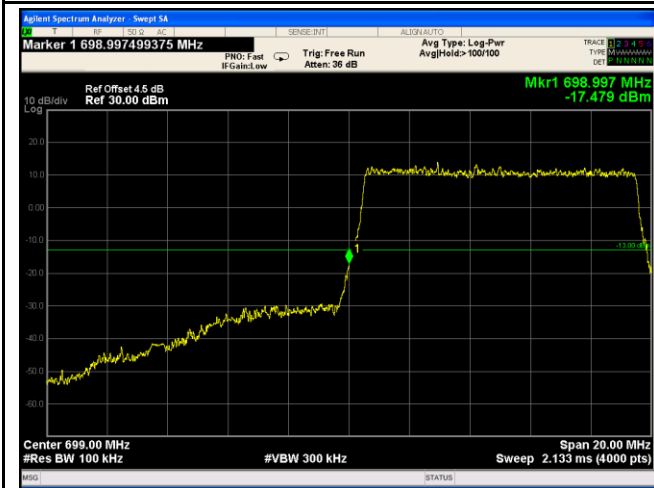

LTE Band XII - Low Channel 16QAM-10

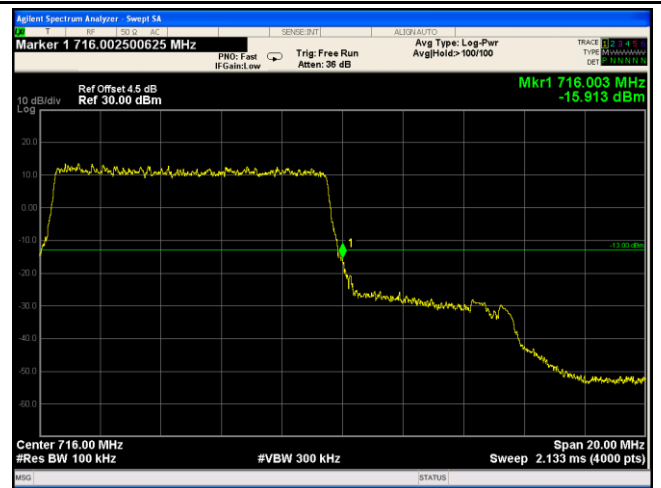

LTE Band XII - High Channel 16QAM-10

6.8 Band Edge 27.53(m)

Temperature	23 °C
Relative Humidity	55%
Atmospheric Pressure	1012mbar
Test date :	December 04, 2017
Tested By :	Aaron Liang

Requirement(s):

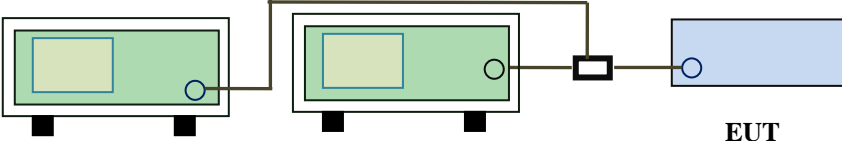
Spec	Requirement	Applicable
§27.53(m)	According to FCC 27.53(m)(4) specified that power of any emission outside of the channel edge must be attenuated below the transmitting power(P) by a factor shall be not less than $43+10\log(P)$ dB at the channel edge, the limit of emission equal to -13dBm. And $55+10\log(P)$ dB at 5.5MHz from the channel edges, the limit of emission equal to -25dBm. In the 1MHz bands immediately outside and adjacent to the frequency block a resolution bandwidth of at least one percent of the emission bandwidth of the fundamental emission of the transmitter may be employed.	<input checked="" type="checkbox"/>
Test Setup	 <p style="text-align: center;">Base Station Spectrum Analyzer EUT</p>	
Test Procedure	<ul style="list-style-type: none"> - The EUT was connected to Spectrum Analyzer and Base Station via power divider. - The 99% and 26 dB occupied bandwidth (BW) of the middle channel for the highest RF powers. 	
Remark		
Result	<input checked="" type="checkbox"/> Pass <input type="checkbox"/> Fail	

Test Data Yes N/A

Test Plot Yes (See below) N/A

LTE Band VII (Part 27) result

BW(MHz)	Channel	Frequency (MHz)	Mode	Emission (dBm)	Limit (dBm)
5	20775	2500	QPSK	-19.00	-13
			16QAM	-21.37	-13
5	21425	2570	QPSK	-18.18	-13
			16QAM	-18.31	-13
10	20800	2500	QPSK	-20.50	-13
			16QAM	-20.34	-13
10	21400	2570	QPSK	-19.70	-13
			16QAM	-19.88	-13
15	20825	2500	QPSK	-24.82	-13
			16QAM	-23.20	-13
15	21400	2570	QPSK	-29.85	-13
			16QAM	-24.70	-13
20	20850	2500	QPSK	-28.60	-13
			16QAM	-20.05	-13
20	21350	2571	QPSK	-24.90	-13
			16QAM	-26.74	-13

LTE Band VII (Part 27)

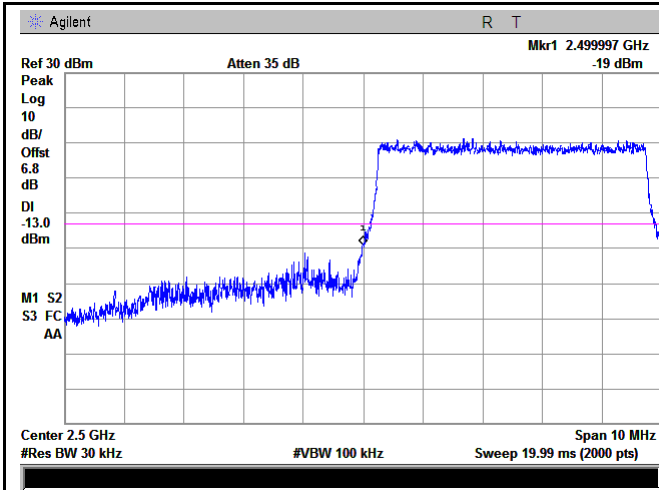

LTE Band VII - Low Channel QPSK-5

Note: Offset=Cable loss (4.5) + 10log
 $(50.91/30)=4.5+2.3=6.8$ dB

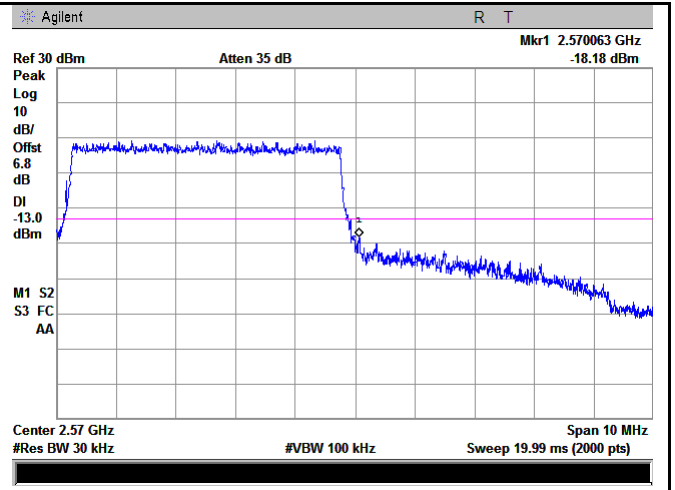

LTE Band VII - High Channel QPSK-5

Note: Offset=Cable loss (4.5) + 10log
 $(50.76/30)=4.5+2.3=6.8$ dB

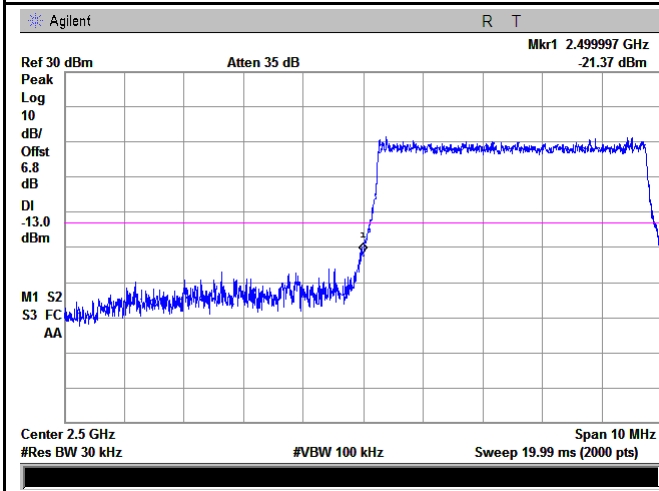

LTE Band VII - Low Channel 16QAM-5

Note: Offset=Cable loss (4.5) + 10log
 $(50.84/30)=4.5+2.3=6.8$ dB

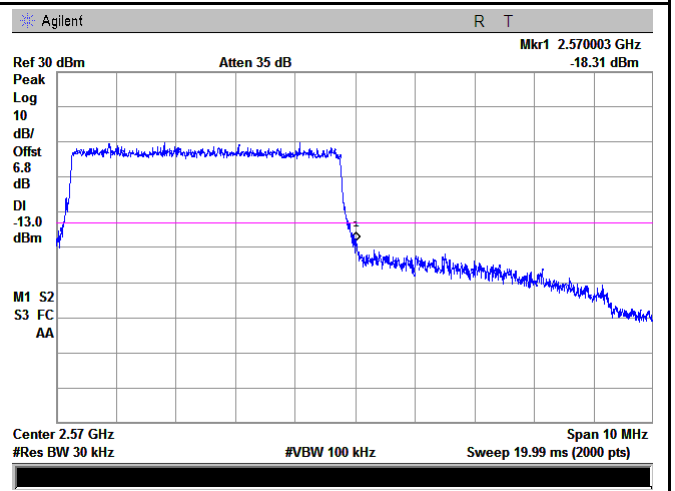

LTE Band VII - High Channel 16QAM-5

Note: Offset=Cable loss (4.5) + 10log
 $(50.88/30)=4.5+2.3=6.8$ dB

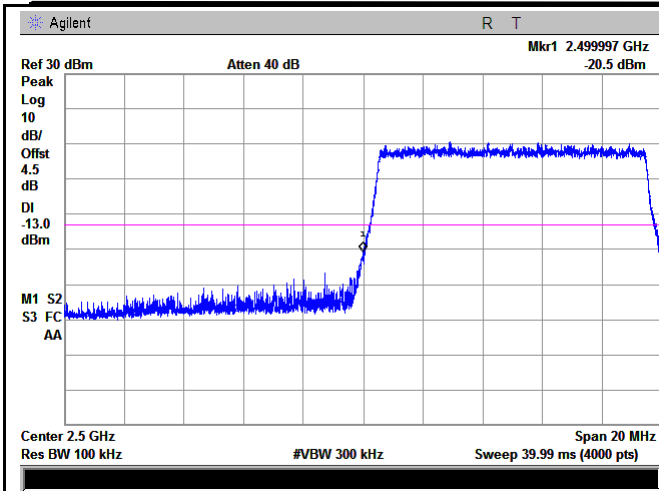

LTE Band VII - Low Channel QPSK-10

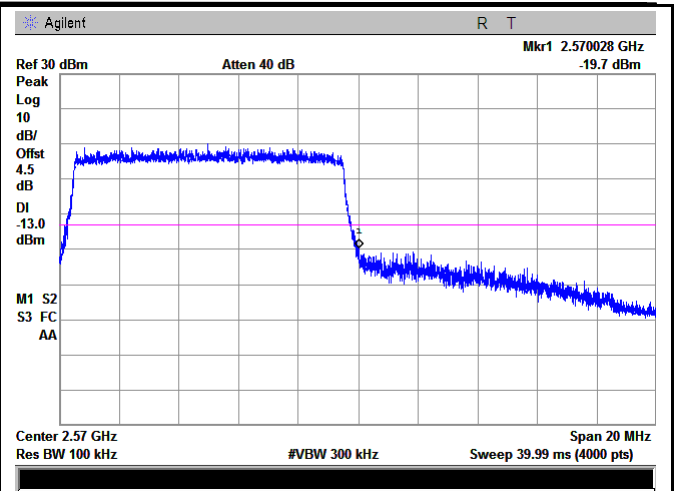

LTE Band VII - High Channel QPSK-10

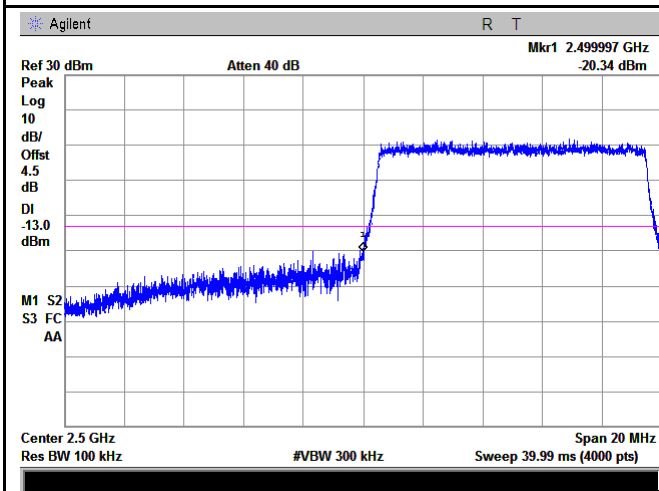

LTE Band VII - Low Channel 16QAM-10

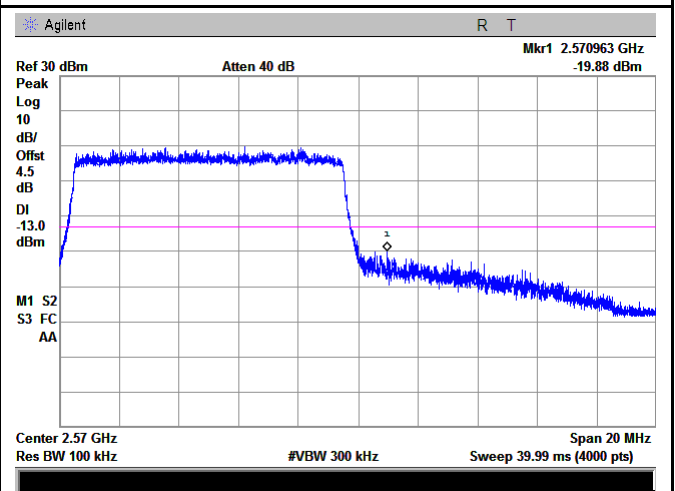

LTE Band VII - High Channel 16QAM-10

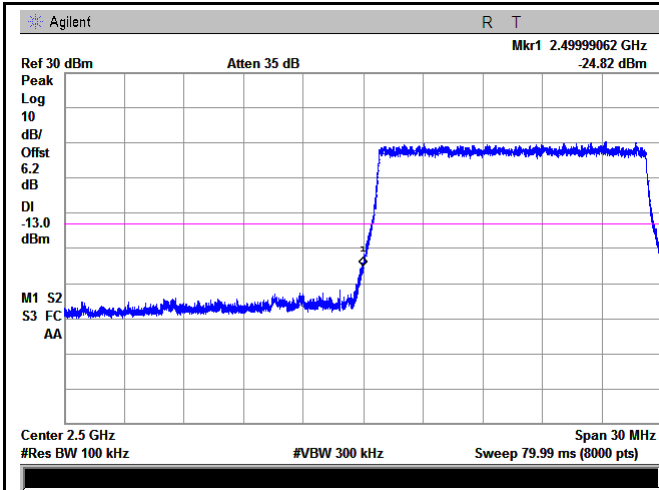

LTE Band VII - Low Channel QPSK-15

Note: Offset=Cable loss (4.5) + 10log
(149.59/100)=4.5+1.7=6.2 dB

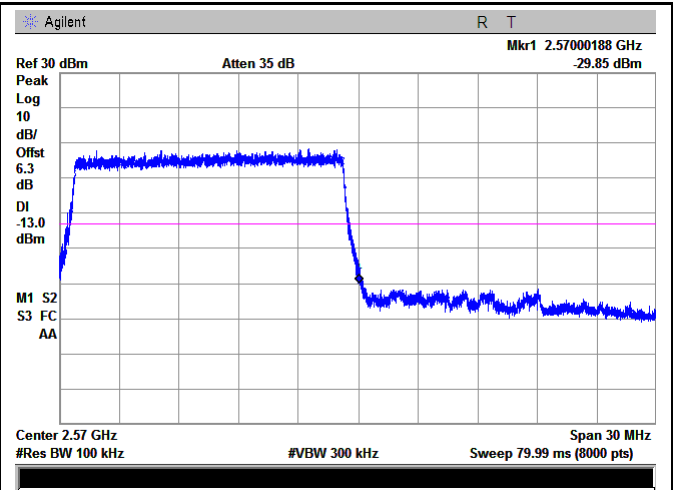

LTE Band VII - High Channel QPSK-15

Note: Offset=Cable loss (4.5) + 10log
(149.74/100)=4.5+1.8=6.3 dB

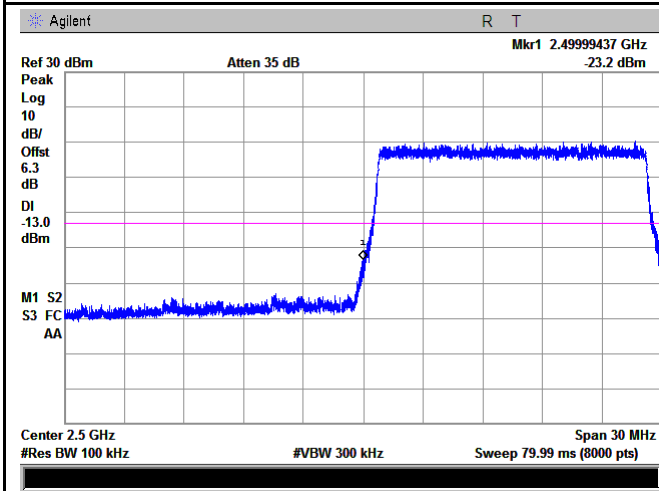

LTE Band VII - Low Channel 16QAM-15

Note: Offset=Cable loss (4.5) + 10log
(149.81/100)=4.5+1.8=6.3 dB

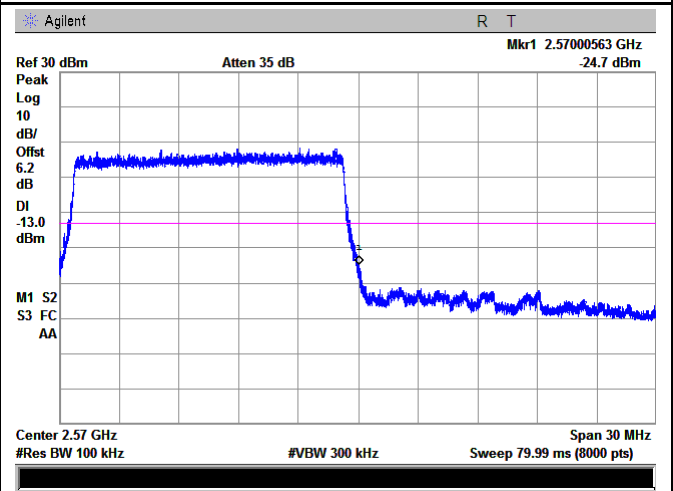

LTE Band VII - High Channel 16QAM-15

Note: Offset=Cable loss (4.5) + 10log
(149.44/100)=4.5+1.7=6.2 dB

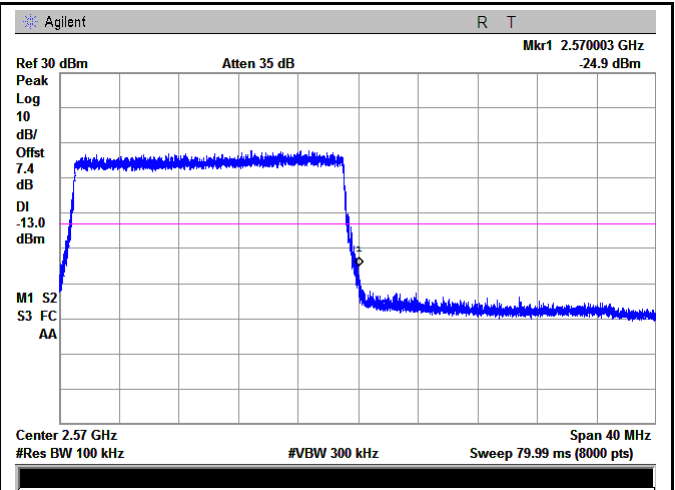
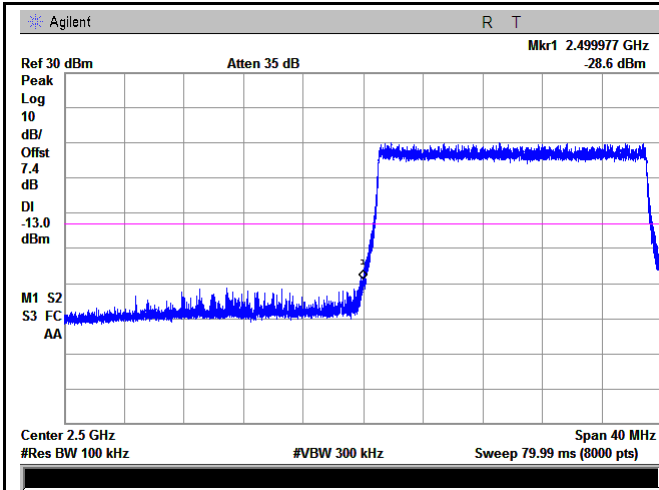

LTE Band VII - Low Channel QPSK-20

LTE Band VII - High Channel QPSK-20

Note: Offset=Cable loss (4.5) + 10log
 $(195.06/100)=4.5+2.9=7.4$ dB

Note: Offset=Cable loss (4.5) + 10log
 $(194.38/100)=4.5+2.9=7.4$ dB

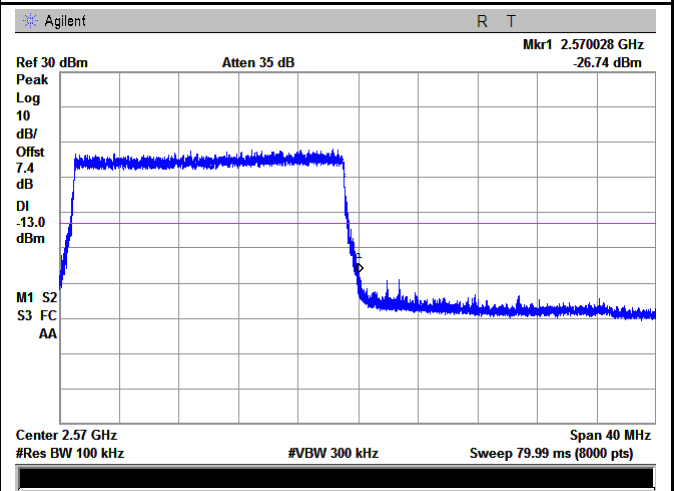
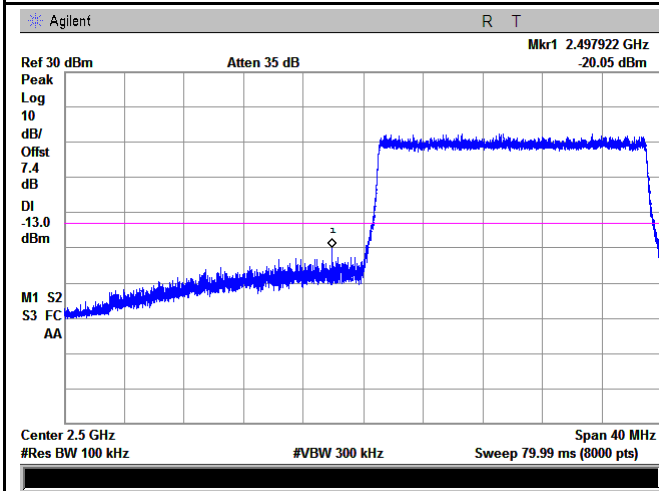

LTE Band VII - Low Channel 16QAM-20

LTE Band VII - High Channel 16QAM-20

Note: Offset=Cable loss (4.5) + 10log
 $(194.42/100)=4.5+2.9=7.4$ dB

Note: Offset=Cable loss (4.5) + 10log
 $(194.31/100)=4.5+2.9=7.4$ dB

6.9 Frequency Stability

Temperature	23 °C
Relative Humidity	55%
Atmospheric Pressure	1012mbar
Test date :	December 04, 2017
Tested By :	Aaron Liang

Requirement(s):

Spec	Item	Requirement	Applicable																																
§2.1055, §22.355 & §24.235 § 27.5(h); § 27.54	a)	<p>According to §22.355, the carrier frequency of each transmitter in the Public Mobile Services must be maintained within the tolerances given in Table below:</p> <p>Frequency Tolerance for Transmitters in the Public Mobile Services</p> <table border="1"> <thead> <tr> <th>Frequency Range (MHz)</th> <th>Base, fixed (ppm)</th> <th>Mobile ≤ 3 watts (ppm)</th> <th>Mobile ≤ 3 watts (ppm)</th> </tr> </thead> <tbody> <tr> <td>25 to 50</td> <td>20.0</td> <td>20.0</td> <td>50.0</td> </tr> <tr> <td>□□to 450</td> <td>5.0</td> <td>5.0</td> <td>50.0</td> </tr> <tr> <td>450 to 512</td> <td>2.5</td> <td>5.0</td> <td>5□0</td> </tr> <tr> <td>821 to 896</td> <td>1.5</td> <td>2.5</td> <td>2.5</td> </tr> <tr> <td>928 to 929.</td> <td>5.0</td> <td>N/A</td> <td>N/A</td> </tr> <tr> <td>929 to 960.</td> <td>1.5</td> <td>N/A</td> <td>N/A</td> </tr> <tr> <td>2110 to 2220</td> <td>10.0</td> <td>N/A</td> <td>N/A</td> </tr> </tbody> </table> <p>According to §24.235, the frequency stability shall be sufficient to ensure that the fundamental emissions stay within the authorized frequency block.</p> <p>According to §27.54, The frequency stability shall be sufficient to ensure that the fundamental emissions stay within the authorized bands of operation.</p>	Frequency Range (MHz)	Base, fixed (ppm)	Mobile ≤ 3 watts (ppm)	Mobile ≤ 3 watts (ppm)	25 to 50	20.0	20.0	50.0	□□to 450	5.0	5.0	50.0	450 to 512	2.5	5.0	5□0	821 to 896	1.5	2.5	2.5	928 to 929.	5.0	N/A	N/A	929 to 960.	1.5	N/A	N/A	2110 to 2220	10.0	N/A	N/A	<input checked="" type="checkbox"/>
		Frequency Range (MHz)	Base, fixed (ppm)	Mobile ≤ 3 watts (ppm)	Mobile ≤ 3 watts (ppm)																														
		25 to 50	20.0	20.0	50.0																														
		□□to 450	5.0	5.0	50.0																														
		450 to 512	2.5	5.0	5□0																														
		821 to 896	1.5	2.5	2.5																														
		928 to 929.	5.0	N/A	N/A																														
		929 to 960.	1.5	N/A	N/A																														
		2110 to 2220	10.0	N/A	N/A																														

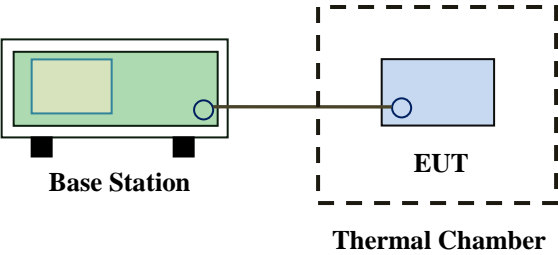
Test setup	 <p>The diagram illustrates the test setup. On the left, a green rectangular box labeled 'Base Station' is shown. A horizontal line connects it to a blue rectangular box labeled 'EUT' (Equipment Under Test) located inside a dashed-line rectangular box labeled 'Thermal Chamber'.</p>
Procedure	<p>A communication link was established between EUT and base station. The frequency error was monitored and measured by base station under variation of ambient temperature and variation of primary supply voltage.</p> <p>Limit: The frequency stability of the transmitter shall be maintained within $\pm 0.00025\%$ ($\pm 2.5\text{ppm}$) of the center frequency.</p>
Remark	<p>Frequency Stability versus Temperature: The Frequency tolerance of the carrier signal shall be maintained within 2.5ppm of the operating frequency over a temperature variation of -10°C to $+55^{\circ}\text{C}$ at normal supply voltage.</p>
Result	<input checked="" type="checkbox"/> Pass <input type="checkbox"/> Fail

Test Data Yes N/A

Test Plot Yes (See below) N/A

LTE Band II (Part 24E) result

Middle Channel, f ₀ = 1880 MHz				
Temperature (°C)	Power Supplied (V _{DC})	Frequency Error (Hz)	Frequency Error (ppm)	Limit (ppm)
-10	3.7	-12	0.0069	2.5
0		-12	0.0069	2.5
10		-12	0.0069	2.5
20		-15	0.0087	2.5
30		-9	0.0052	2.5
40		-17	0.0098	2.5
50		-17	0.0098	2.5
55		-15	0.0087	2.5
25	4.2	-15	0.0087	2.5
	3.5	-15	0.0087	2.5

LTE Band IV (Part 27) result

Middle Channel, f ₀ = 1732.5 MHz				
Temperature (°C)	Power Supplied (V _{DC})	Frequency Error (Hz)	Frequency Error (ppm)	Limit (ppm)
-10	3.7	-12	0.0069	2.5
0		-16	0.0092	2.5
10		-10	0.0058	2.5
20		-16	0.0092	2.5
30		-12	0.0069	2.5
40		-13	0.0075	2.5
50		-17	0.0098	2.5
55		-14	0.0081	2.5
25	4.2	-12	0.0069	2.5
	3.5	-12	0.0069	2.5

LTE Band VII (Part 27) result

Middle Channel, $f_0 = 2535$ MHz				
Temperature (°C)	Power Supplied (V _{DC})	Frequency Error (Hz)	Frequency Error (ppm)	Limit (ppm)
-10	3.7	-12	0.0069	2.5
0		-10	0.0058	2.5
10		-14	0.0081	2.5
20		-12	0.0069	2.5
30		-14	0.0081	2.5
40		-17	0.0098	2.5
50		-16	0.0092	2.5
55		-15	0.0087	2.5
25	4.2	-9	0.0052	2.5
	3.5	-8	0.0046	2.5

LTE Band XII (Part 27) result

Middle Channel, $f_0 = 707.5$ MHz				
Temperature (°C)	Power Supplied (V _{DC})	Frequency Error (Hz)	Frequency Error (ppm)	Limit (ppm)
-10	3.7	-12	0.0069	2.5
0		-14	0.0081	2.5
10		-11	0.0063	2.5
20		-12	0.0069	2.5
30		-17	0.0098	2.5
40		-12	0.0069	2.5
50		-11	0.0063	2.5
55		-17	0.0098	2.5
25	4.2	-13	0.0075	2.5
	3.5	-9	0.0052	2.5

Annex A. TEST INSTRUMENT

Instrument	Model	Serial #	Cal Date	Cal Due	In use
RF Conducted Test					
Agilent ESA-E SERIES SPECTRUM ANALYZER	E4407B	MY45108319	09/14/2017	09/13/2018	<input checked="" type="checkbox"/>
Power Splitter	1#	1#	08/30/2017	08/29/2018	<input checked="" type="checkbox"/>
Universal Radio Communication Tester	CMU200	121393	09/23/2017	09/22/2018	<input checked="" type="checkbox"/>
Wideband Radio Communication Tester	CMW500	120906	03/26/2017	03/25/2018	<input checked="" type="checkbox"/>
Temperature/Humidity Chamber	UHL-270	001	10/07/2017	10/06/2018	<input checked="" type="checkbox"/>
DC Power Supply	E3640A	MY40004013	09/15/2017	09/14/2018	<input checked="" type="checkbox"/>
RF Power Sensor	Dare RPR3006C/P/W	AY554013	09/15/2017	09/14/2018	<input checked="" type="checkbox"/>
Radiated Emissions					
EMI test receiver	ESL6	100262	09/15/2017	09/14/2018	<input checked="" type="checkbox"/>
OPT 010 AMPLIFIER (0.1-1300MHz)	8447E	2727A02430	08/30/2017	08/29/2018	<input checked="" type="checkbox"/>
Microwave Preamplifier (0.5 ~ 18GHz)	PAM-118	443008	08/30/2017	08/29/2018	<input checked="" type="checkbox"/>
Horn Antenna	BBHA9170	3145226D1	09/27/2017	09/26/2018	<input checked="" type="checkbox"/>
Bilog Antenna (30MHz~6GHz)	JB6	A110712	09/19/2017	09/18/2018	<input checked="" type="checkbox"/>
Bilog Antenna (30MHz~2GHz)	JB1	A112017	09/19/2017	09/18/2018	<input checked="" type="checkbox"/>
Double Ridge Horn Antenna (1 ~18GHz)	AH-118	71259	09/22/2017	09/21/2018	<input checked="" type="checkbox"/>
Double Ridge Horn Antenna (1 ~18GHz)	AH-118	71283	09/22/2017	09/21/2018	<input checked="" type="checkbox"/>
SYNTHESIZED SIGNAL GENERATOR	8665B	3744A01293	09/15/2017	09/14/2018	<input checked="" type="checkbox"/>

Test Report	17071294-FCC-R5
Page	116 of 134

Tunable Notch Filter	3NF-800/1000-S	AA4	08/30/2017	08/29/2018	<input checked="" type="checkbox"/>
Tunable Notch Filter	3NF-1000/2000-S	AM 4	08/30/2017	08/29/2018	<input checked="" type="checkbox"/>

Annex B. EUT And Test Setup Photographs

Annex B.i. Photograph: EUT External Photo

Whole Package View



Adapter - Lable View



EUT - Front View



EUT - Rear View



EUT - Top View



EUT - Bottom View

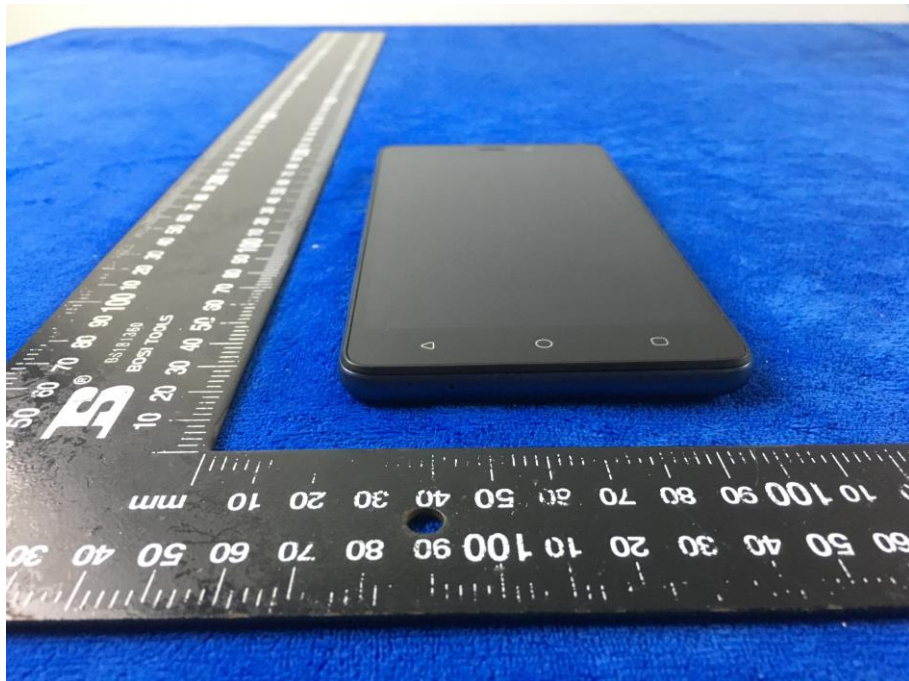

EUT - Left View

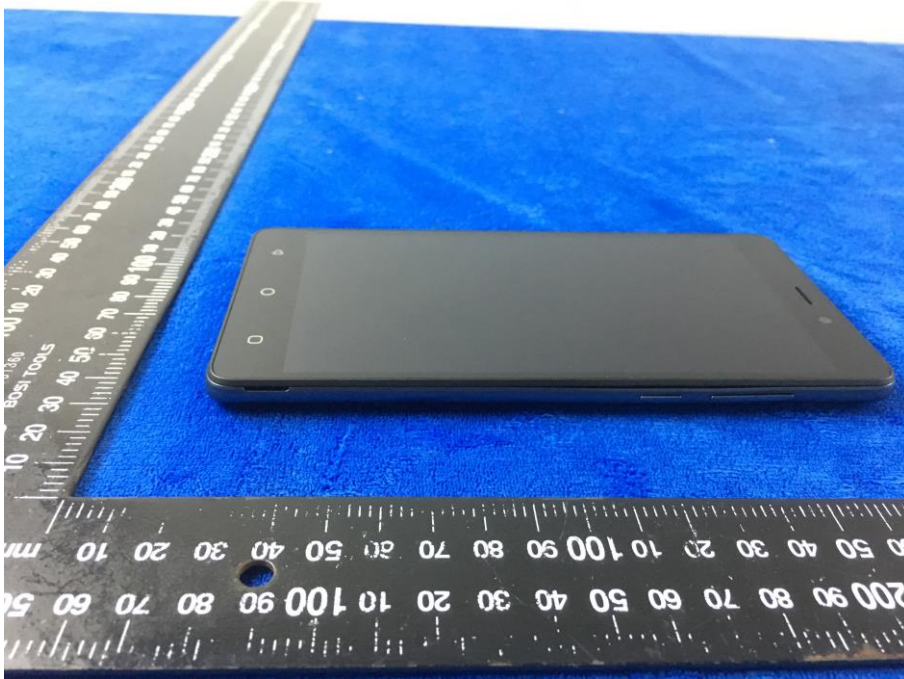

EUT - Right View

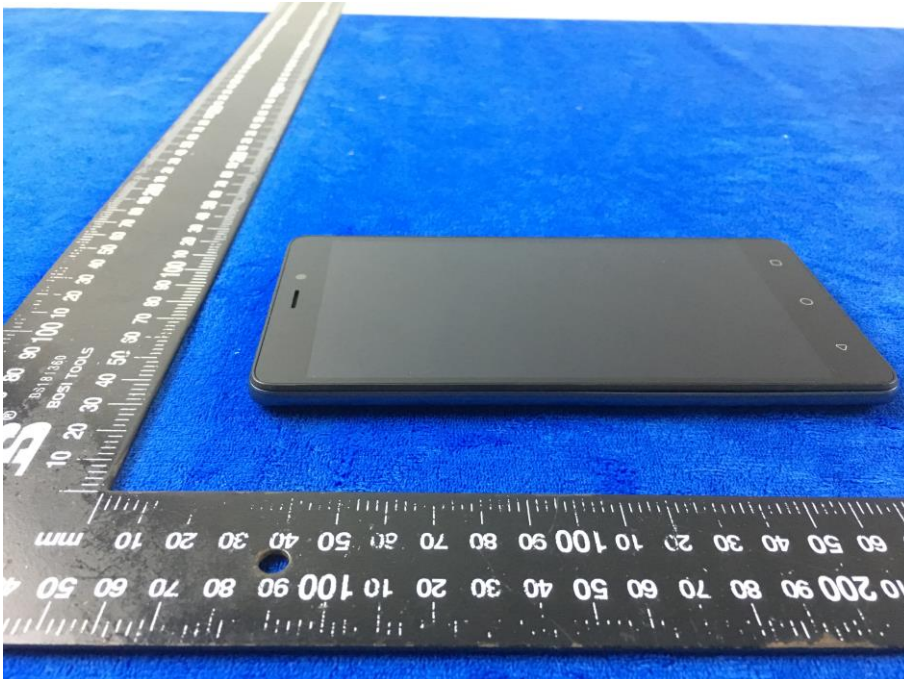

Annex B.ii. Photograph: EUT Internal Photo

Cover Off - Top View 1



Cover Off - Top View 2



Battery - Front View



Battery - Rear View

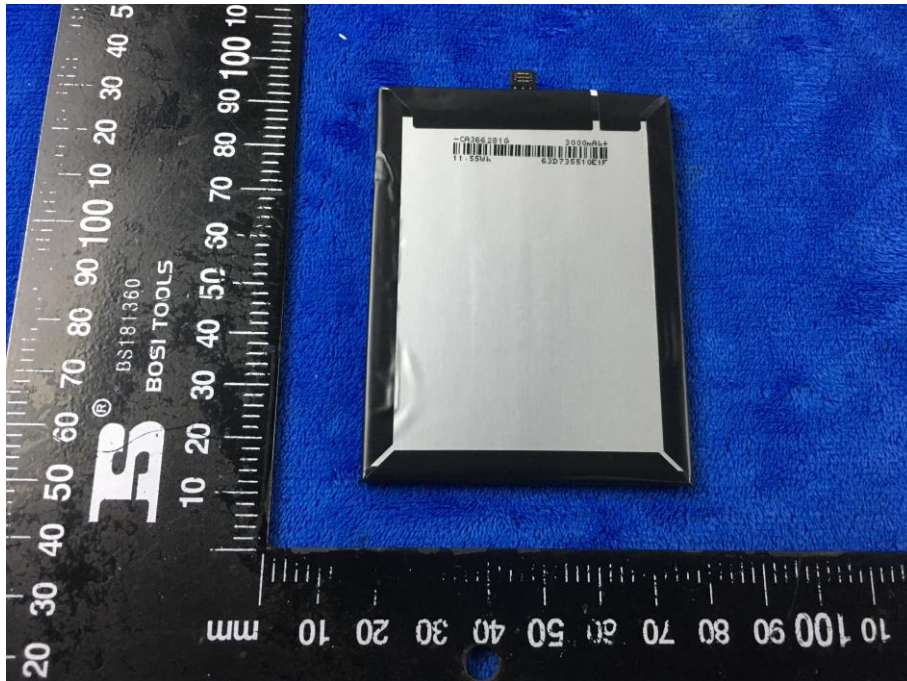

Mainboard with Shielding - Front View

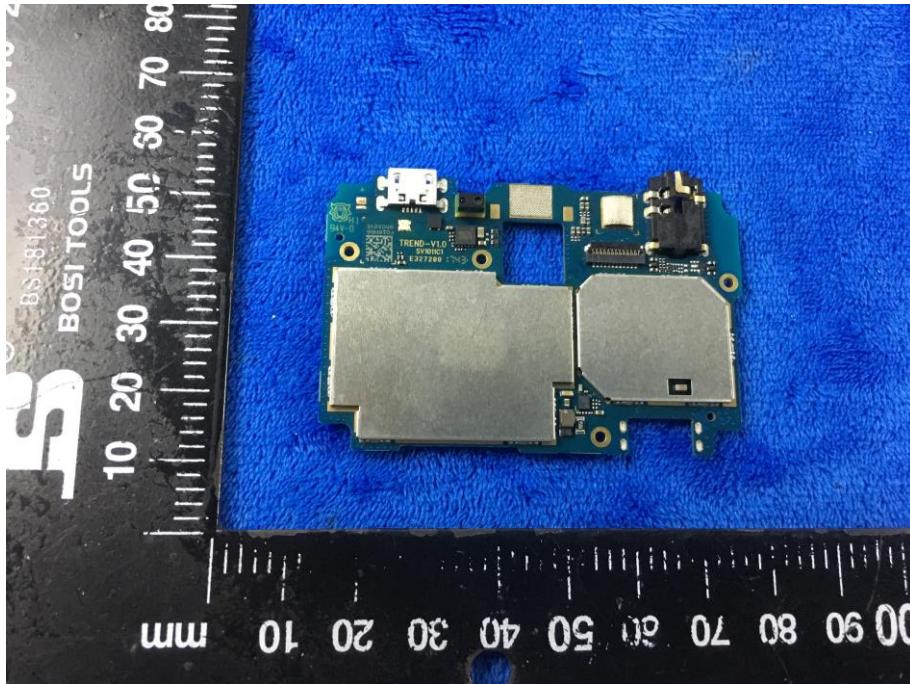

Mainboard with Shielding - Rear View

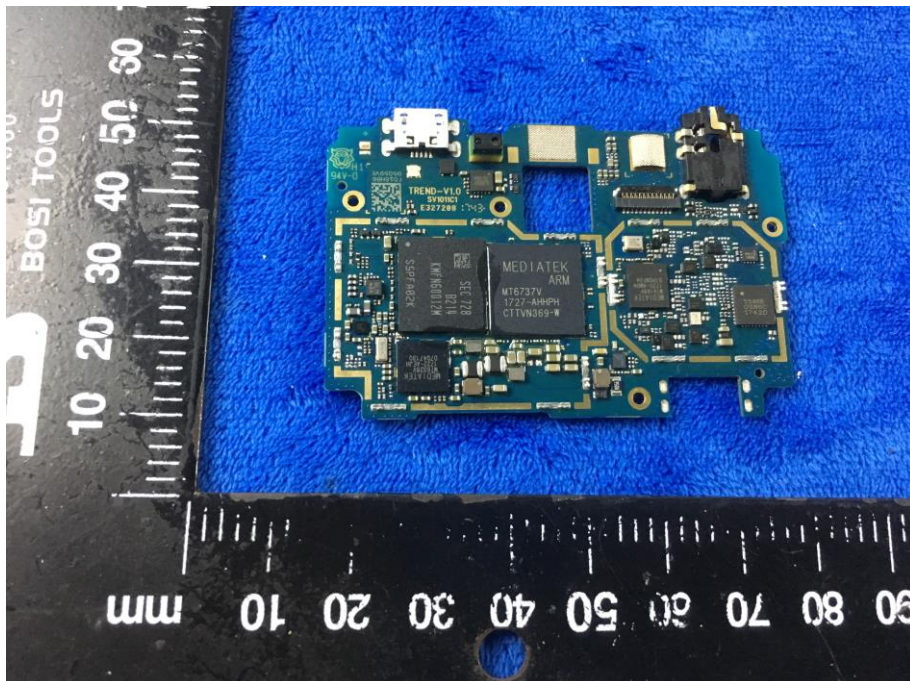

Mainboard without Shielding – Front View

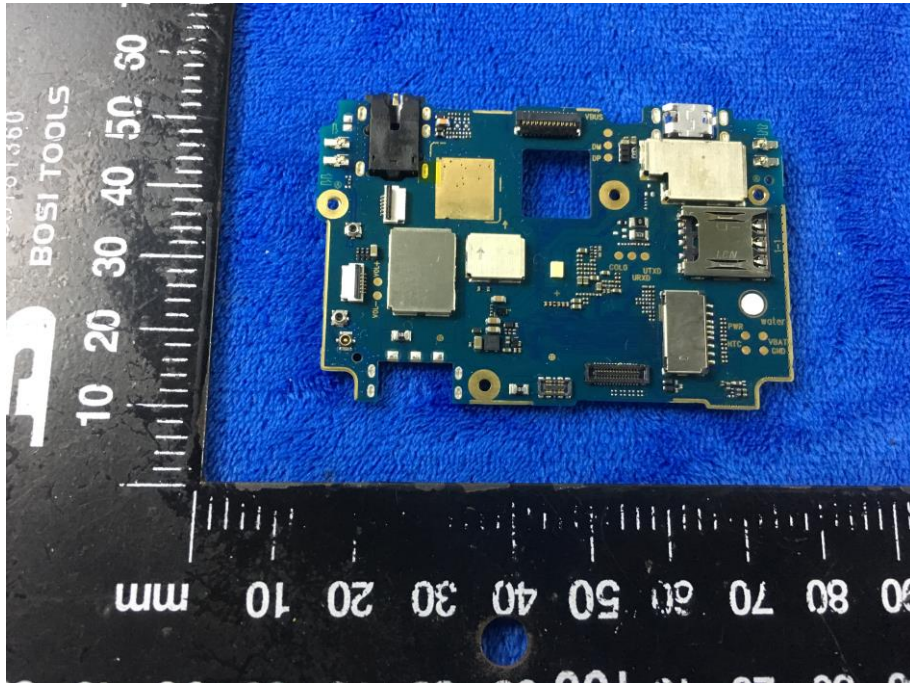

Mainboard without Shielding – Rear View

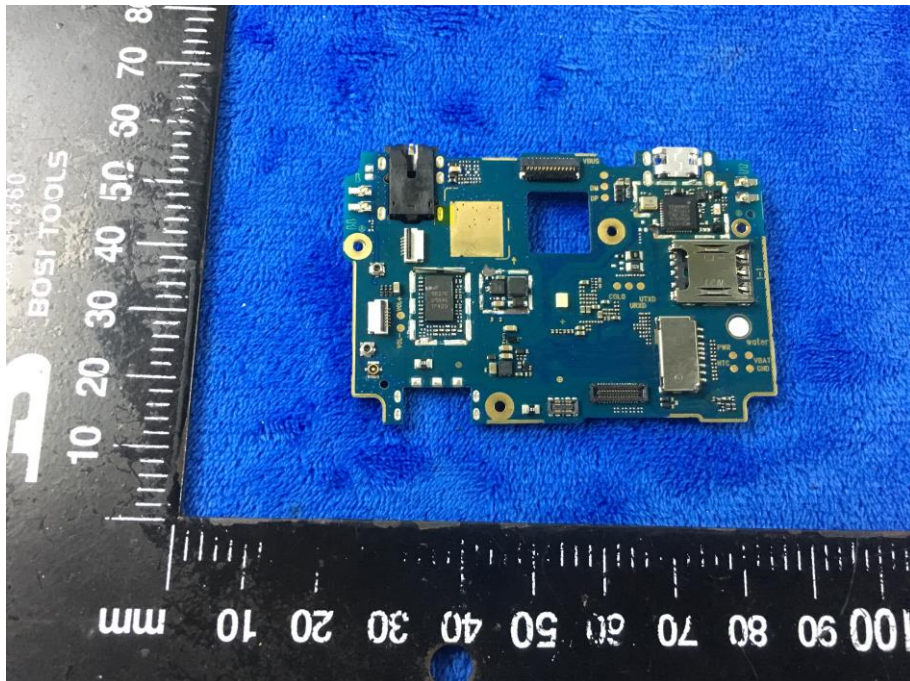

Smallboard – Front View

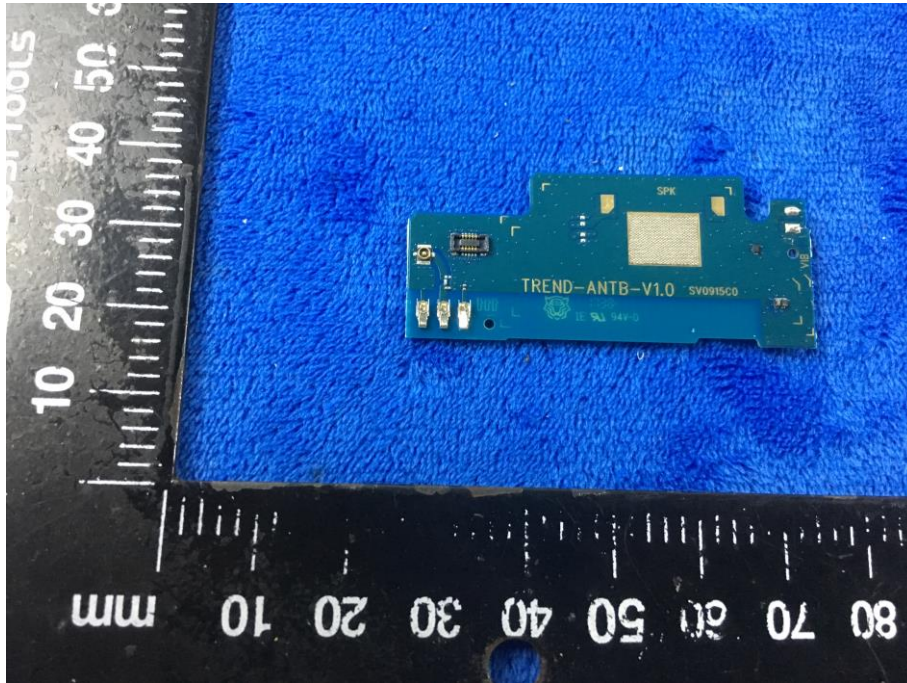

Smallboard – Rear View

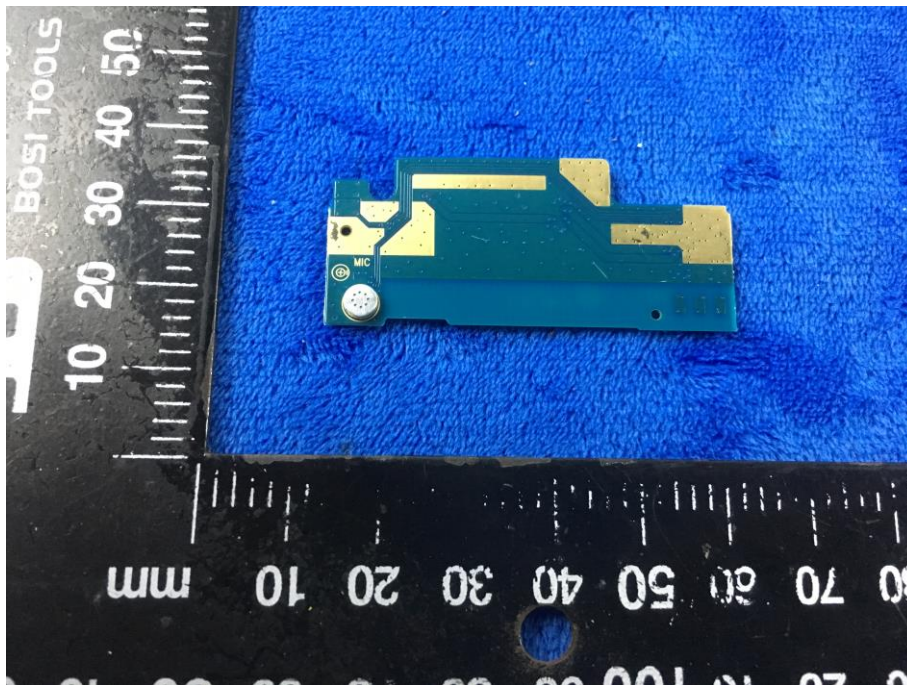

LCD – Front View



LCD – Rear View



GSM/PCS/UMTS-FDD/LTE Antenna View



WIFI/BT/BLE/GPS - Antenna View



RXD- Antenna View



Annex B.iii. Photograph: Test Setup Photo

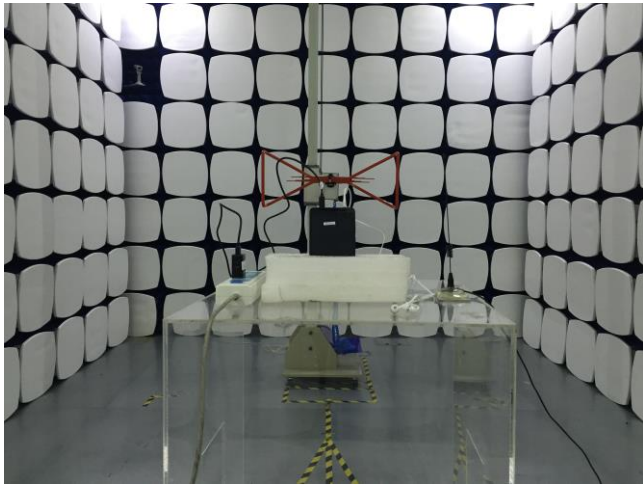

Radiated Spurious Emissions Test Setup Below 1GHz

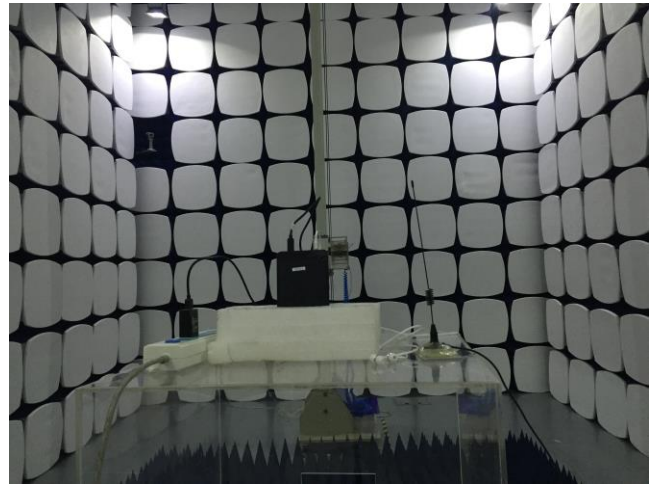

Radiated Spurious Emissions Test Setup Above
1GHz

Annex C. TEST SETUP AND SUPPORTING EQUIPMENT

Annex C.ii. TEST SET UP BLOCK

Block Configuration Diagram for Radiated Emissions

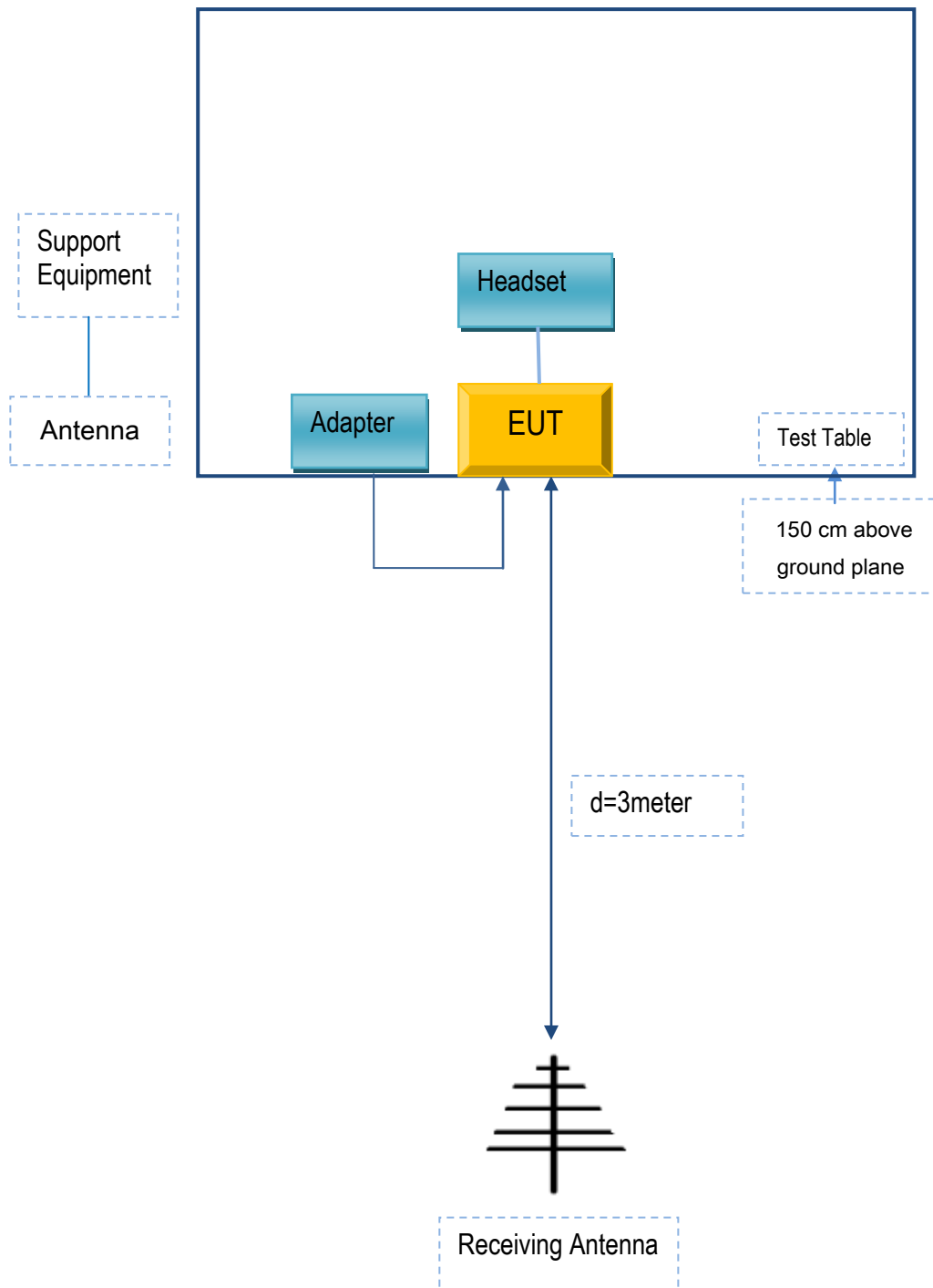

Annex C. ii. SUPPORTING EQUIPMENT DESCRIPTION

The following is a description of supporting equipment and details of cables used with the EUT.

Supporting Equipment:

Manufacturer	Equipment Description	Model	Serial No
MFOURTEL MEXICO S.A. DE C.V.	Adapter	M4	N/A
MFOURTEL MEXICO S.A. DE C.V.	headset	M4	N/A
Agilent	Wireless Connectivity Test Set	N4010A	N/A
OEM	omnidirectional antenna	AntSuck	N/A

Supporting Cable:

Cable type	Shield Type	Ferrite Core	Length	Serial No
USB Cable	Un-shielding	No	0.8m	N/A

Annex C.ii. EUT OPERATING CONKITIONS

N/A

Test Report	17071294-FCC-R5
Page	133 of 134

Annex D. User Manual / Block Diagram / Schematics / Partlist

Please see the attachment

Annex E. DECLARATION OF SIMILARITY

N/A