

Test Mode:	Transmitting Mode
-------------------	--------------------------

30MHz -1GHz

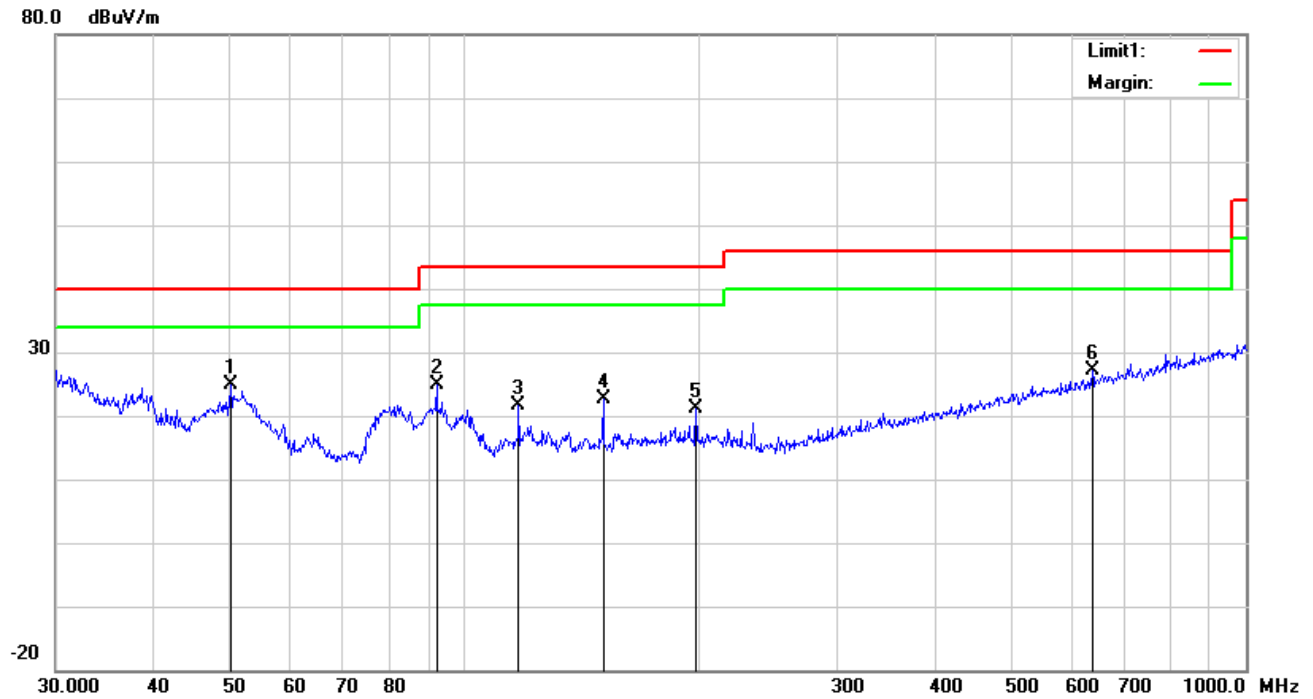

Test Data

Vertical Polarity Plot @3m

No.	P/L	Frequency	Reading	Detect or	Ant_F	PA_G	Cab_L	Result	Limit	Margin	Height	Degree
		(MHz)	(dBuV/m)		(dB/m)	(dB)	(dB)	(dBuV/m)	(dBuV/m)	(dB)	(cm)	(°)
1	V	50.2325	38.17	peak	8.37	22.38	0.80	24.96	40.00	-15.04	100	55
2	V	92.1388	37.61	peak	8.51	22.32	0.97	24.77	43.50	-18.73	100	346
3	V	117.3603	29.45	peak	13.44	22.35	1.16	21.70	43.50	-21.80	200	339
4	V	150.5378	31.06	peak	12.60	22.34	1.34	22.66	43.50	-20.84	100	47
5	V	197.8928	29.99	peak	11.98	22.37	1.54	21.14	43.50	-22.36	100	128
6	V	636.1340	26.65	peak	19.50	21.50	2.59	27.24	46.00	-18.76	100	320

30MHz -1GHz

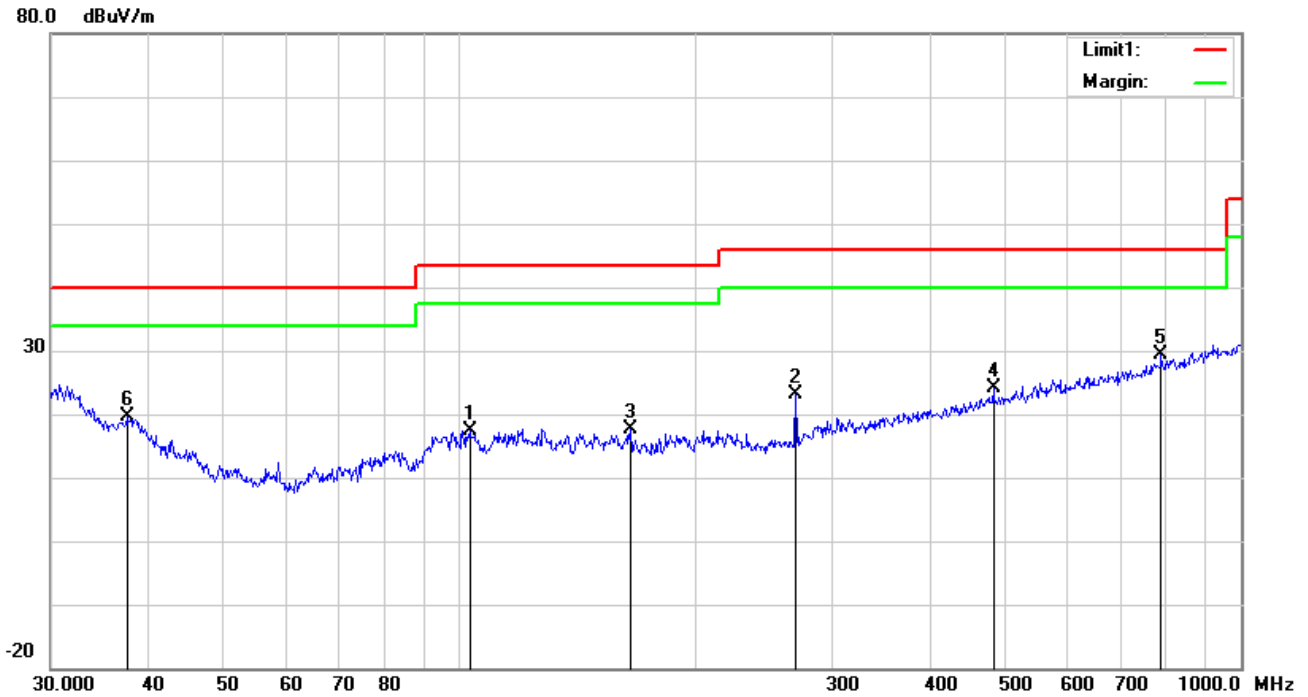

Test Data

Horizontal Polarity Plot @3m

N o.	P/ L	Frequency (MHz)	Reading (dBuV/m)	Detect or	Ant_F (dB/m)	PA_G (dB)	Cab_ L (dB)	Result (dBuV/m)	Limit (dBuV/m)	Margin (dB)	Height (cm)	Degr ee ()
1	H	103.0800	27.69	peak	10.94	22.33	1.14	17.44	43.50	-26.06	100	128
2	H	269.4284	31.49	peak	12.25	22.29	1.73	23.18	46.00	-22.82	200	320
3	H	165.4867	26.36	peak	12.16	22.26	1.37	17.63	43.50	-25.87	100	223
4	H	482.2156	26.30	peak	17.34	21.85	2.32	24.11	46.00	-21.89	100	168
5	H	790.6188	26.40	peak	21.29	21.17	2.94	29.46	46.00	-16.54	100	183
6	H	37.5479	25.31	peak	15.69	22.27	0.78	19.51	40.00	-20.49	100	101

Above 1GHz

Test Mode:	Transmitting Mode
-------------------	--------------------------

Low Channel (2412 MHz) (g mode worst case)

Frequency (MHz)	S.A. Reading (dB μ V)	Detector (PK/AV)	Polarity (H/V)	Ant. Factor (dB/m)	Cable Loss (dB)	Pre-Amp. Gain (dB)	Cord Amp. (dB μ V/m)	Limit (dB μ V/m)	Margin (dB)
4824	55.71	AV	V	33.39	7.22	48.46	47.86	54	-6.14
4824	53.22	AV	H	33.39	7.22	48.46	45.37	54	-8.63
4824	68.73	PK	V	33.39	7.22	48.46	60.88	74	-13.12
4824	63.99	PK	H	33.39	7.22	48.46	56.14	74	-17.86
12904	18.24	AV	V	40.86	14.34	47.55	25.89	54	-28.11
12904	20.7	AV	H	40.86	14.34	47.55	28.35	54	-25.65
12904	40.01	PK	V	40.86	14.34	47.55	47.66	74	-26.34
12904	40.81	PK	H	40.86	14.34	47.55	48.46	74	-25.54

Middle Channel (2437 MHz) (g mode worst case)

Frequency (MHz)	S.A. Reading (dB μ V)	Detector (PK/AV)	Polarity (H/V)	Ant. Factor (dB/m)	Cable Loss (dB)	Pre-Amp. Gain (dB)	Cord Amp. (dB μ V/m)	Limit (dB μ V/m)	Margin (dB)
4874	53.52	AV	V	33.62	7.53	48.36	46.31	54	-7.69
4874	54.81	AV	H	33.62	7.53	48.36	47.6	54	-6.4
4874	68.44	PK	V	33.62	7.53	48.36	61.23	74	-12.77
4874	63.14	PK	H	33.62	7.53	48.36	55.93	74	-18.07
8093	38.14	AV	V	38.15	7.75	46.35	37.69	54	-16.31
8093	39.18	AV	H	38.15	7.75	46.35	38.73	54	-15.27
8093	51.15	PK	V	38.15	7.75	46.35	50.7	74	-23.3
8093	52.21	PK	H	38.15	7.75	46.35	51.76	74	-22.24

High Channel (2462 MHz) (b mode worst case)

Frequency (MHz)	S.A. Reading (dB μ V)	Detector (PK/AV)	Polarity (H/V)	Ant. Factor (dB/m)	Cable Loss (dB)	Pre-Amp. Gain (dB)	Cord Amp. (dB μ V/m)	Limit (dB μ V/m)	Margin (dB)
4924	53.97	AV	V	33.74	7.78	48.34	47.15	54	-6.85
4924	53.55	AV	H	33.74	7.78	48.34	46.73	54	-7.27
4924	67.38	PK	V	33.74	7.78	48.34	60.56	74	-13.44
4924	64.69	PK	H	33.74	7.78	48.34	57.87	74	-16.13
17871	18.33	AV	V	42.3	19.24	44.2	35.67	54	-18.33
17904	19.51	AV	H	42.3	19.24	44.2	36.85	54	-17.15
17904	38.98	PK	V	42.3	19.24	44.2	56.32	74	-17.68
17904	40.58	PK	H	42.3	19.24	44.2	57.92	74	-16.08

Note:

- 1, The testing has been conformed to $10 \times 2462 \text{MHz} = 24,620 \text{MHz}$
- 2, All other emissions more than 30 dB below the limit
- 3, X-Axis, Y-Axis and Z-Axis were investigated. The results above show only the worst case.
- 4, The radiated spurious test above 18GHz is subcontracted to SIEMIC (Nanjing-China) Laboratories. and found 30dB below the limit at least.

Annex A. TEST INSTRUMENT

Instrument	Model	Serial #	Cal Date	Cal Due	In use
AC Line Conducted					
EMI test receiver	ESCS30	8471241027	09/15/2017	09/14/2018	<input checked="" type="checkbox"/>
Line Impedance	LI-125A	191106	09/23/2017	09/22/2018	<input checked="" type="checkbox"/>
Line Impedance	LI-125A	191107	09/23/2017	09/22/2018	<input checked="" type="checkbox"/>
ISN	ISN T800	34373	09/23/2017	09/22/2018	<input type="checkbox"/>
Transient Limiter	LIT-153	531118	08/30/2017	08/29/2018	<input type="checkbox"/>
RF conducted test					
Agilent ESA-E SERIES	E4407B	MY45108319	09/15/2017	09/14/2018	<input checked="" type="checkbox"/>
Power Splitter	1#	1#	08/30/2017	08/29/2018	<input checked="" type="checkbox"/>
DC Power Supply	E3640A	MY40004013	09/15/2017	09/14/2018	<input checked="" type="checkbox"/>
Radiated Emissions					
EMI test receiver	ESL6	100262	09/15/2017	09/14/2018	<input checked="" type="checkbox"/>
Positioning Controller	UC3000	MF780208282	11/17/2017	11/16/2018	<input checked="" type="checkbox"/>
OPT 010 AMPLIFIER (0.1-1300MHz)	8447E	2727A02430	08/30/2017	08/29/2018	<input checked="" type="checkbox"/>
Microwave Preamplifier (1 ~ 26.5GHz)	8449B	3008A02402	03/23/2017	03/22/2018	<input checked="" type="checkbox"/>
Horn Antenna	BBHA9170	3145226D1	09/27/2017	09/26/2018	<input checked="" type="checkbox"/>
Active Antenna (9kHz-30MHz)	AL-130	121031	10/12/2017	10/11/2018	<input checked="" type="checkbox"/>
Bilog Antenna (30MHz~6GHz)	JB6	A110712	09/19/2017	09/18/2018	<input checked="" type="checkbox"/>
Double Ridge Horn Antenna (1 ~18GHz)	AH-118	71283	09/22/2017	09/21/2018	<input checked="" type="checkbox"/>
Universal Radio Communication Tester	CMU200	121393	09/23/2017	09/22/2018	<input checked="" type="checkbox"/>

Annex B. EUT and Test Setup Photographs

Annex B.i. Photograph: EUT External Photo

Whole Package View



Adapter - Label View



EUT - Front View



EUT - Rear View



EUT - Top View



EUT - Bottom View

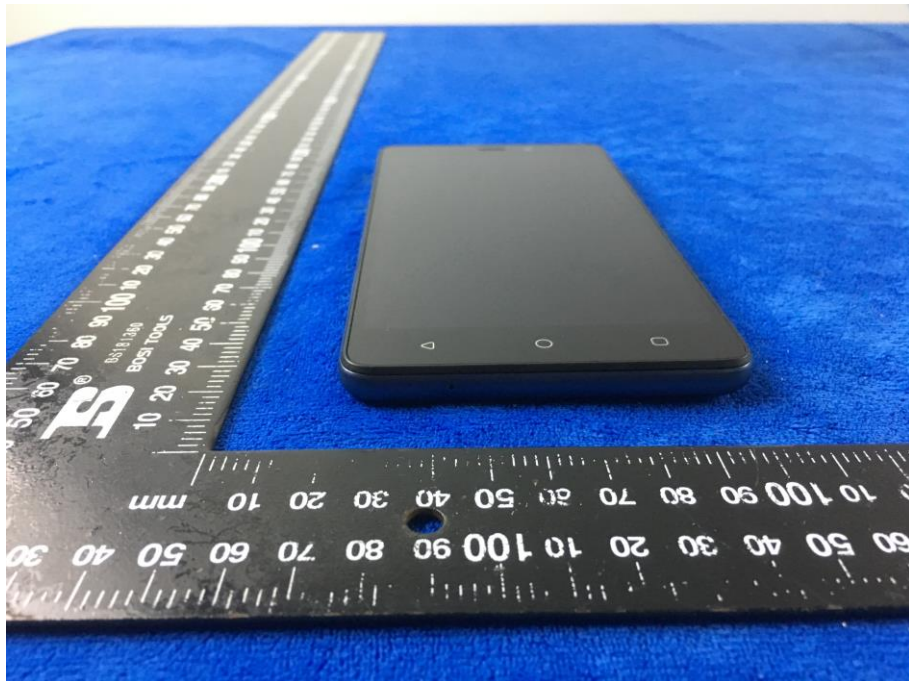

EUT - Left View

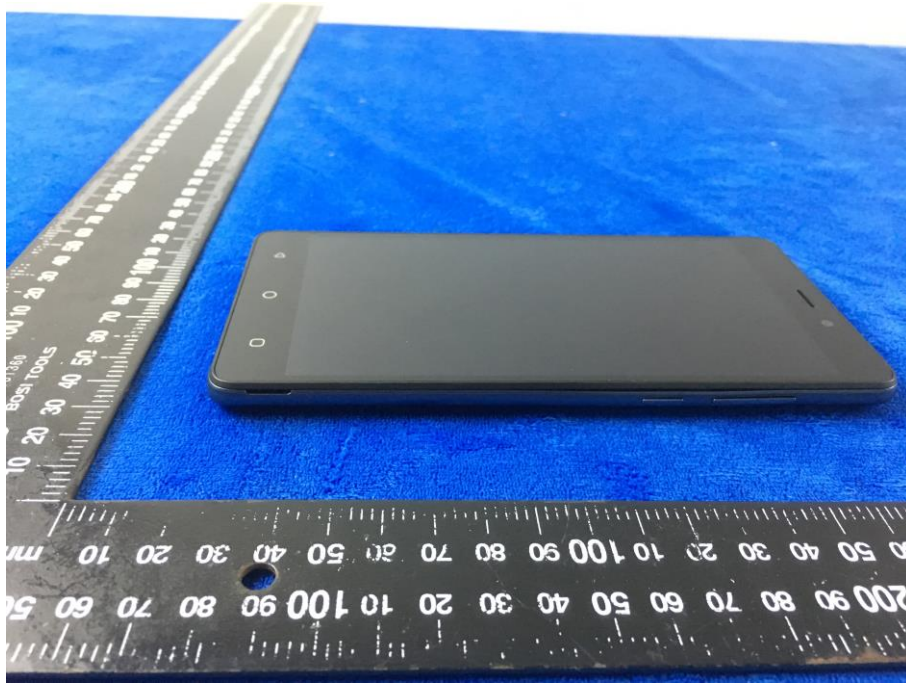

EUT - Right View



Annex B.ii. Photograph: EUT Internal Photo

Cover Off - Top View 1



Cover Off - Top View 2



Test Report No.	17071294-FCC-R2
Page	51 of 64

Battery - Front View



Battery - Rear View

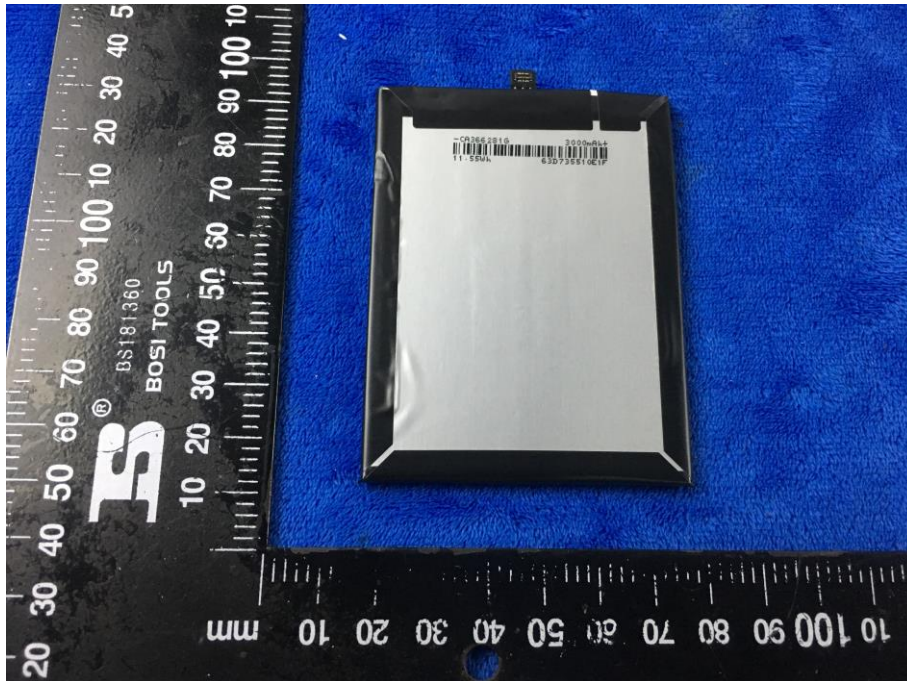

Mainboard with Shielding - Front View

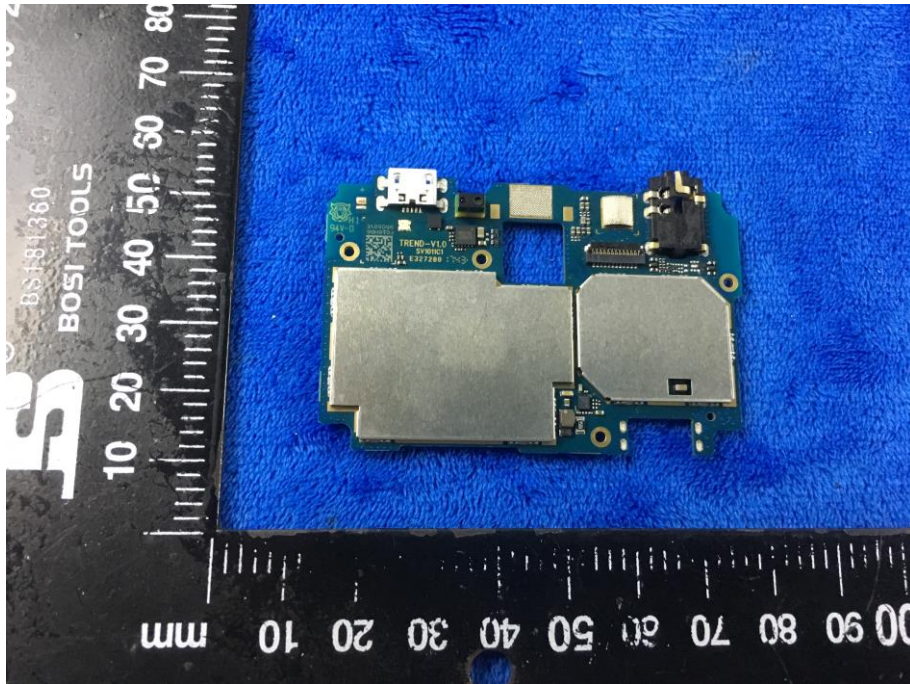

Mainboard with Shielding - Rear View

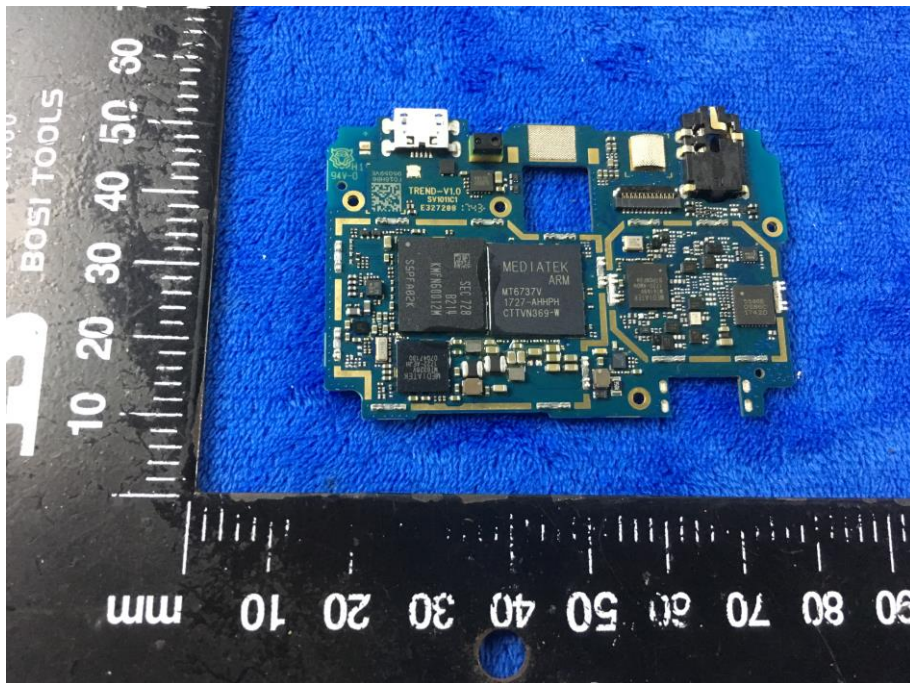

Mainboard without Shielding – Front View

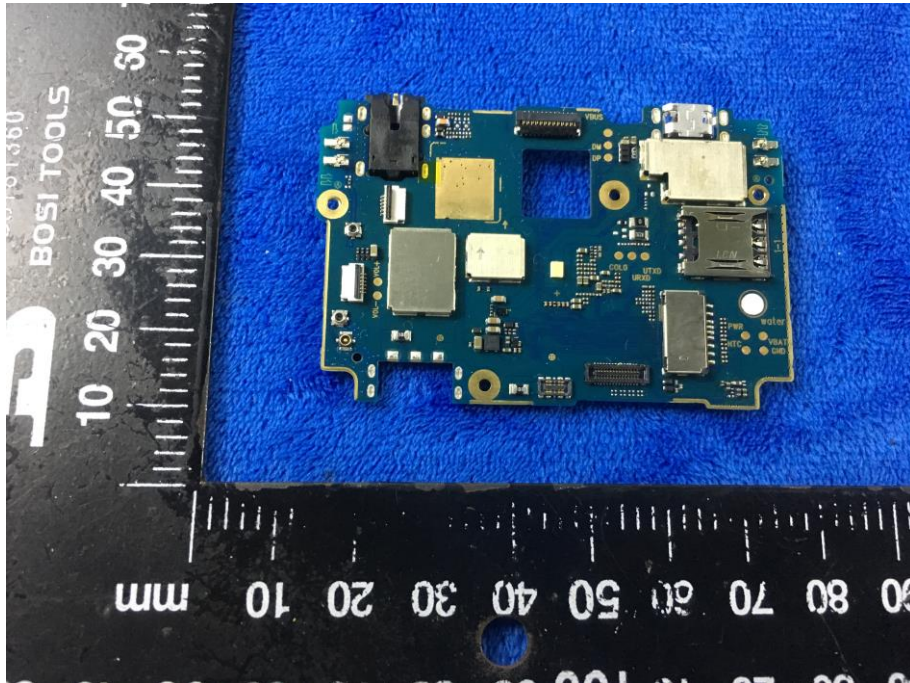

Mainboard without Shielding – Rear View

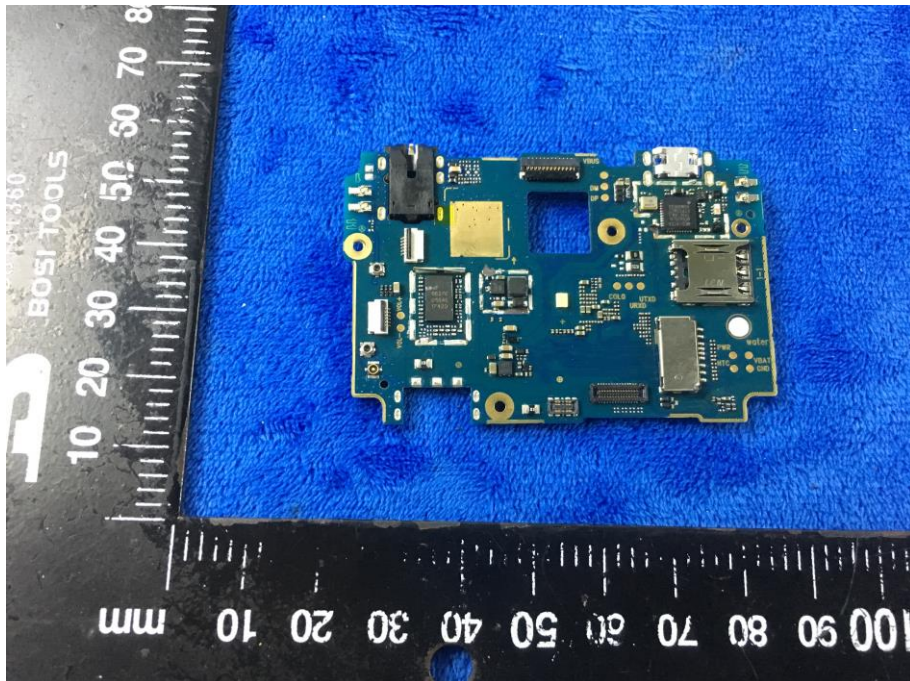

Smallboard – Front View

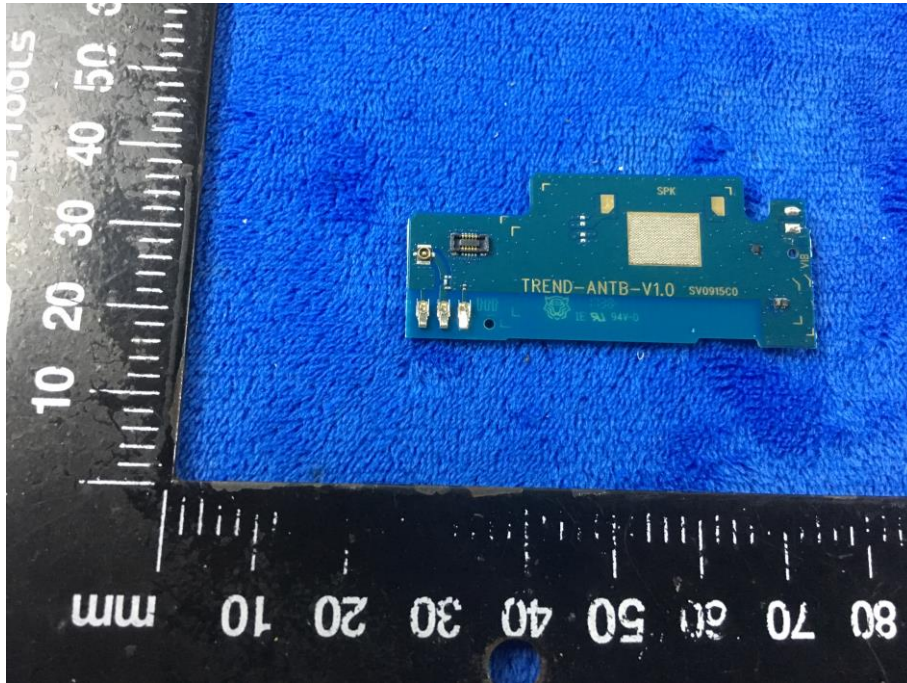

Smallboard – Rear View

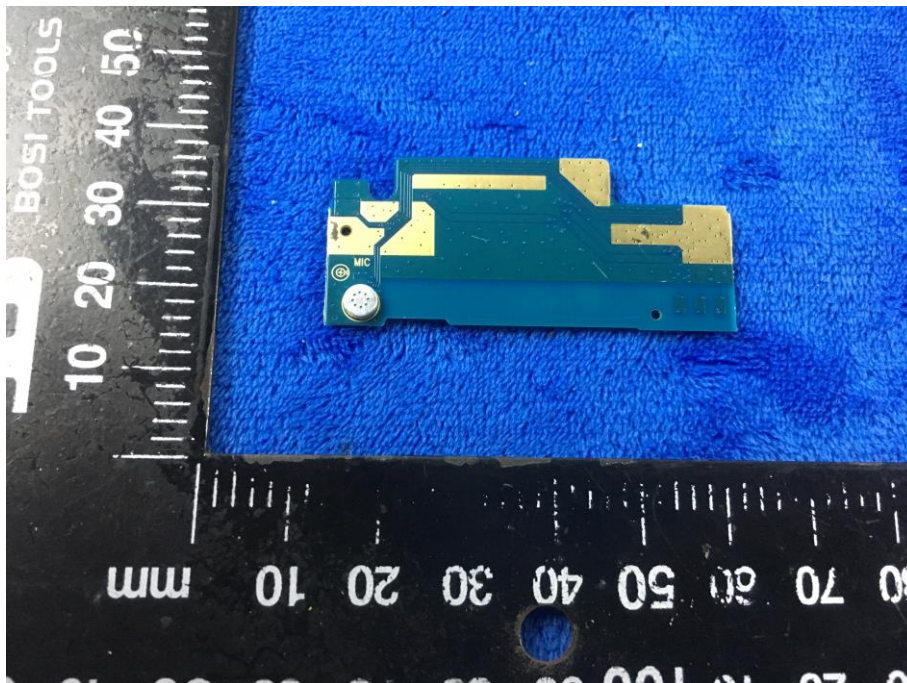

LCD – Front View



LCD – Rear View

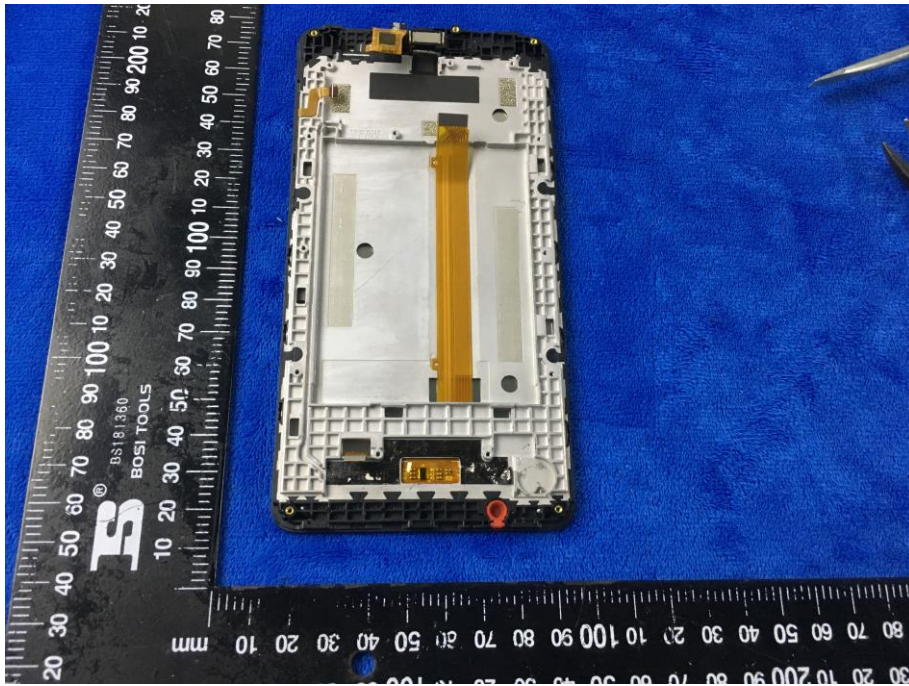

GSM/PCS/UMTS-FDD/LTE Antenna View



WIFI/BT/BLE/GPS - Antenna View



RXD- Antenna View



Annex B.iii. Photograph: Test Setup Photo



Conducted Emissions Test Setup Front View



Conducted Emissions Test Setup Side View

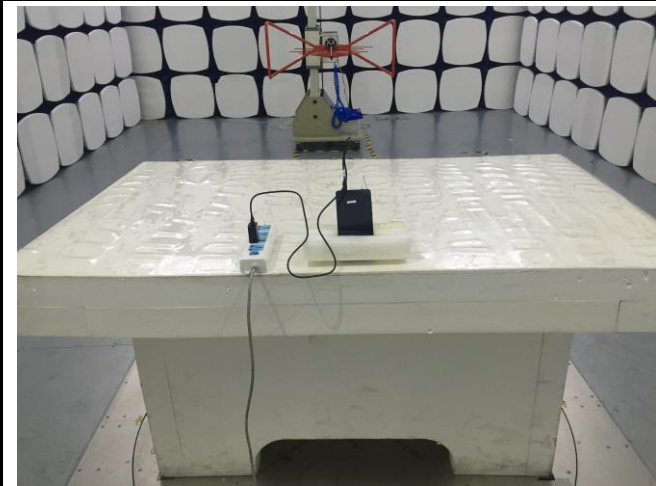

Radiated Spurious Emissions Test Setup Below 1GHz

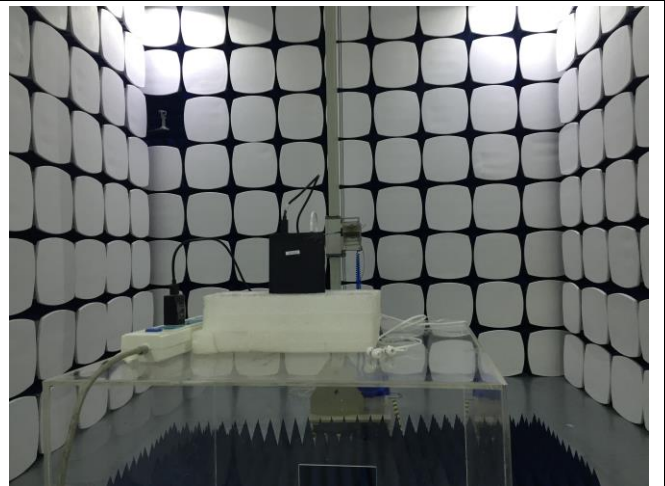

Radiated Spurious Emissions Test Setup Above
1GHz

Annex C. TEST SETUP AND SUPPORTING EQUIPMENT

Annex C.ii. TEST SET UP BLOCK

Block Configuration Diagram for AC Line Conducted Emissions

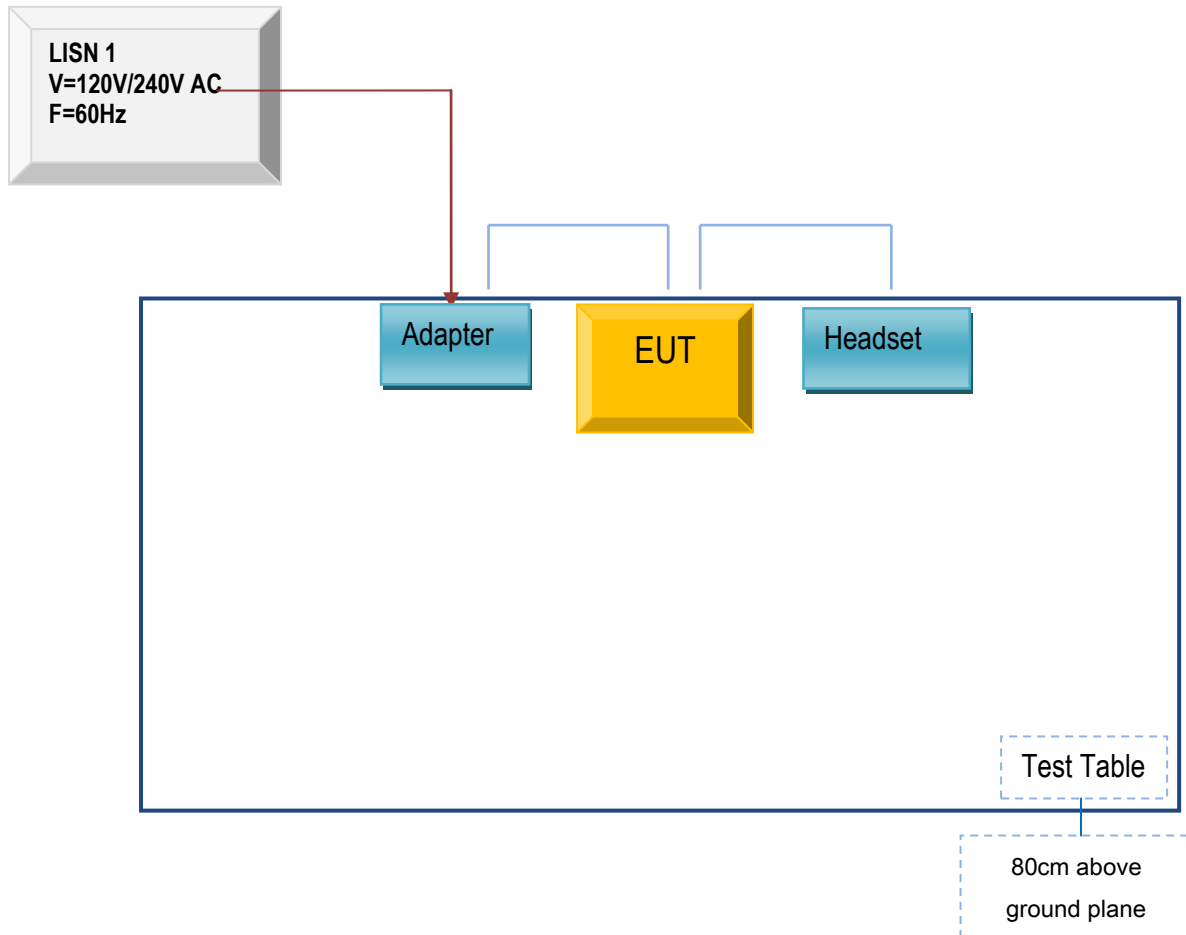

Block Configuration Diagram for Radiated Emissions (Below 1GHz) .

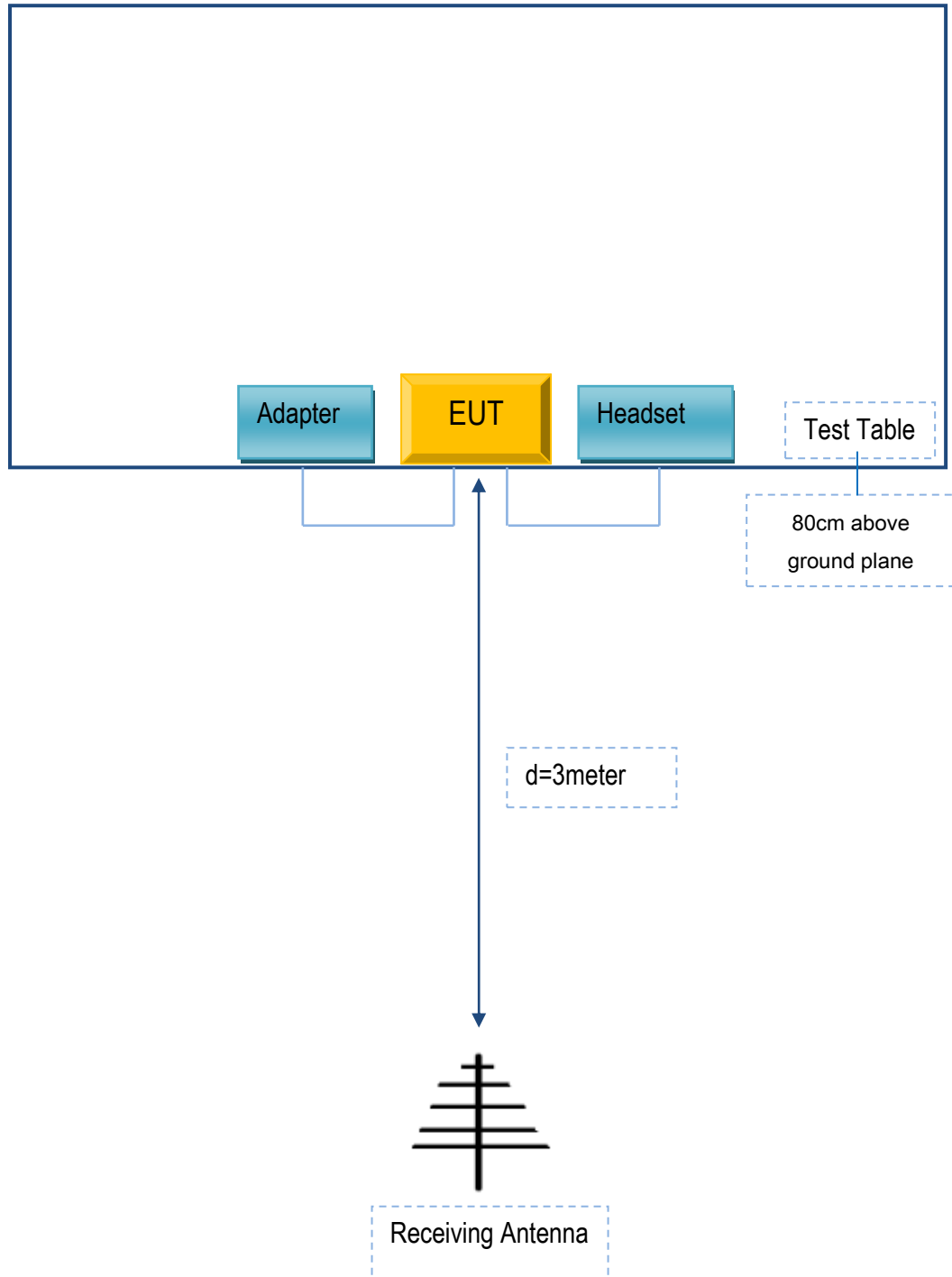

Block Configuration Diagram for Radiated Emissions (Above 1GHz) .

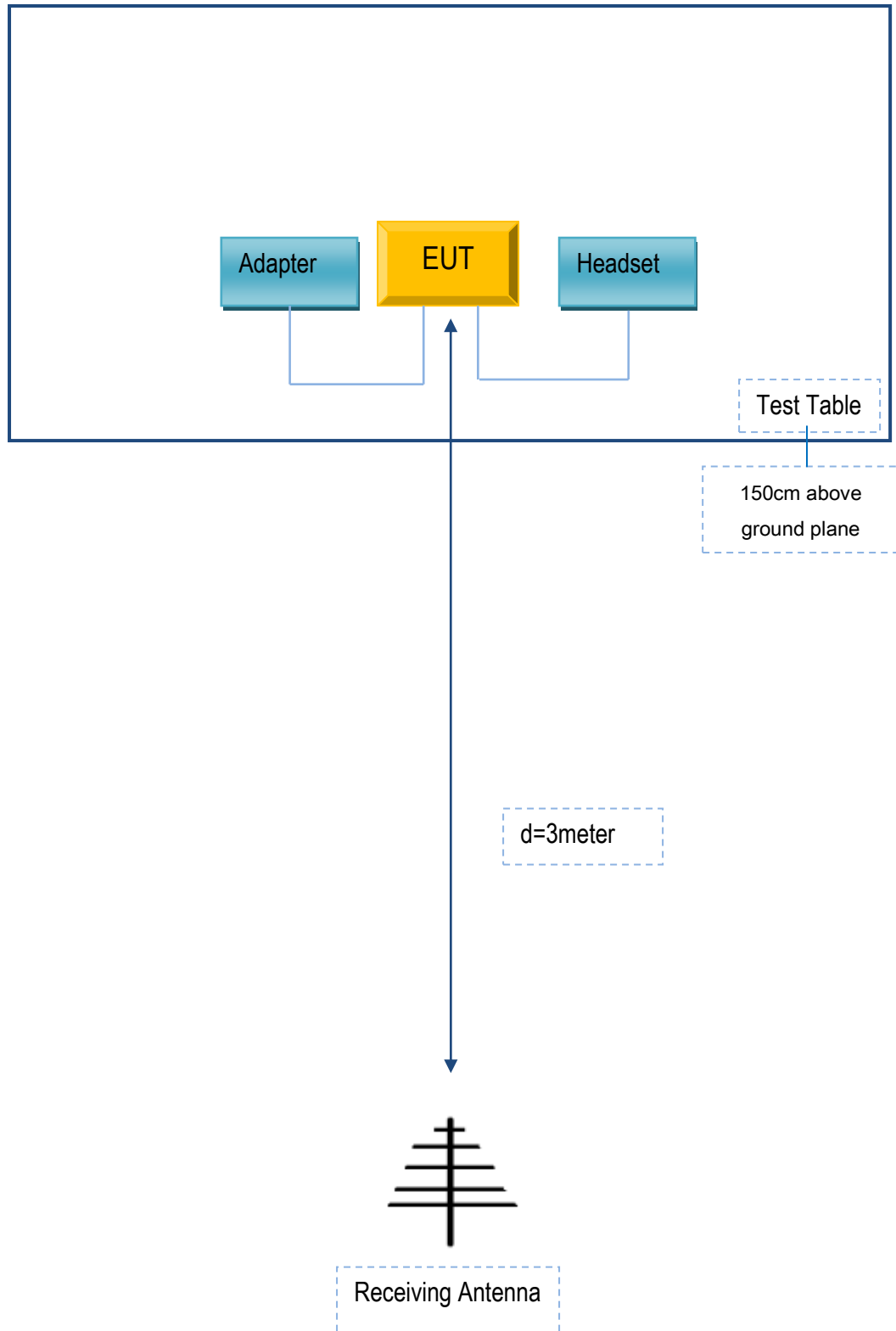

Annex C. ii. SUPPORTING EQUIPMENT DESCRIPTION

The following is a description of supporting equipment and details of cables used with the EUT.

Supporting Equipment:

Manufacturer	Equipment Description	Model	Serial No
MFOURTEL MEXICO S.A. DE C.V.	Adapter	M4	N/A
MFOURTEL MEXICO S.A. DE C.V.	headset	M4	N/A

Supporting Cable:

Cable type	Shield Type	Ferrite Core	Length	Serial No
USB Cable	Un-shielding	No	0.8m	N/A

Test Report No.	17071294-FCC-R2
Page	63 of 64

Annex D. User Manual / Block Diagram / Schematics / Partlist

Please see the attachment

Test Report No.	17071294-FCC-R2
Page	64 of 64

Annex E. DECLARATION OF SIMILARITY

N/A