

FCC TEST REPORT

For

Embed International Pty Ltd

Color-Glo HD AiO Swiper

Model No.: SWR-001

Prepared for : Embed International Pty Ltd
Address : 2 Neil Street, Osborne Park Perth, Western Australia 6017 Australia

Prepared by : Shenzhen LCS Compliance Testing Laboratory Ltd.
Address : 1/F., Xingyuan Industrial Park, Tongda Road, Bao'an Avenue,
Bao'an District, Shenzhen, Guangdong, China

Date of receipt of test sample : March 03, 2014
Number of tested samples : 1
Serial number : Prototype
Date of Test : March 03, 2014 - April 08, 2014
Date of Report : April 08, 2014

FCC TEST REPORT
FCC CFR 47 PART 15 C(15.247): 2012

Report Reference No. : LCS140303036TF

Date of Issue : April 08, 2014

Testing Laboratory Name : Shenzhen LCS Compliance Testing Laboratory Ltd.

Address : 1/F., Xingyuan Industrial Park, Tongda Road, Bao'an Avenue,
 Bao'an District, Shenzhen, Guangdong, China

Testing Location/ Procedure : Full application of Harmonised standards
 Partial application of Harmonised standards
 Other standard testing method

Applicant's Name..... : Embed International Pty Ltd

Address : 2 Neil Street, Osborne Park Perth, Western Australia 6017
 Australia

Test Specification

Standard : FCC CFR 47 PART 15 C(15.247): 2012

Test Report Form No..... : LCSEMC-1.0

TRF Originator : Shenzhen LCS Compliance Testing Laboratory Ltd.

Master TRF : Dated 2011-03

Shenzhen LCS Compliance Testing Laboratory Ltd. All rights reserved.

This publication may be reproduced in whole or in part for non-commercial purposes as long as the Shenzhen LCS Compliance Testing Laboratory Ltd. is acknowledged as copyright owner and source of the material. Shenzhen LCS Compliance Testing Laboratory Ltd. takes no responsibility for and will not assume liability for damages resulting from the reader's interpretation of the reproduced material due to its placement and context.

Test Item Description. : Color-Glo HD AiO Swiper

Trade Mark : N/A

Model/ Type reference..... : SWR-001

Ratings : DC 12V

Result : **Positive**

Compiled by:

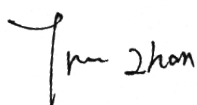

Tree Zhan/ File administrators

Supervised by:

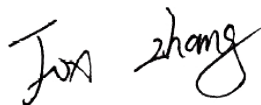

Fox Zhang/ Technique principal

Approved by:



Gavin Liang/ Manager

TABLE OF CONTENTS

Description	Page
1. GENERAL INFORMATION	5
1.1. DESCRIPTION OF DEVICE (EUT)	5
1.2. HOST SYSTEM CONFIGURATION LIST AND DETAILS	5
1.3. EXTERNAL I/O	5
1.4. DESCRIPTION OF TEST FACILITY	6
1.5. STATEMENT OF THE MEASUREMENT UNCERTAINTY	6
1.6. MEASUREMENT UNCERTAINTY	6
1.7. DESCRIPTION OF TEST MODES	7
2. TEST METHODOLOGY	8
2.1. EUT CONFIGURATION	8
2.2. EUT EXERCISE	8
2.3. GENERAL TEST PROCEDURES	8
3. SYSTEM TEST CONFIGURATION	9
3.1. JUSTIFICATION	9
3.2. EUT EXERCISE SOFTWARE	9
3.3. SPECIAL ACCESSORIES	9
3.4. BLOCK DIAGRAM/SCHEMATICS	9
3.5. EQUIPMENT MODIFICATIONS	9
3.6. TEST SETUP	9
4. SUMMARY OF TEST RESULTS.....	10
5. TEST RESULT	11
5.1. MAXIMUM CONDUCTED OUTPUT POWER MEASUREMENT	11
5.2. POWER SPECTRAL DENSITY MEASUREMENT	12
5.3. 6 dB SPECTRUM BANDWIDTH MEASUREMENT	15
5.4. OCCUPIED BANDWIDTH	18
5.5. RADIATED EMISSIONS MEASUREMENT	21
5.6. CONDUCTED SPURIOUS EMISSIONS AND BAND EDGES TEST	30
5.7. POWER LINE CONDUCTED EMISSIONS	34
***NOTE: PRE-SCAN ALL MODE AND RECORDED THE WORST CASE RESULTS IN THIS REPORT.	35
5.8. ANTENNA REQUIREMENTS	36
6. LIST OF MEASURING EQUIPMENTS.....	37
7. MANUFACTURER/ APPROVAL HOLDER DECLARATION	38

1. GENERAL INFORMATION

1.1. Description of Device (EUT)

EUT : Color-Glo HD AiO Swiper

Model Number : SWR-001

Power Supply : DC 12V

Frequency Range : 2405.00-2480.00MHz, (Channel Number: 16, Channel Frequency=2405+5(K-1), K=1, 2, 316)

Modulation Technology : GFSK

Channel Number : 16

Channel Spacing : 5MHz

Antenna Gain : PCB antenna, 3.6dBi(Max.)

1.2. Host System Configuration List and Details

Manufacturer	Description	Model	Serial Number	Certificate
MEAN WELL ENTE RPRISES CO LTD	AC/DC SWITCHING ADAPTOR	GS188B12	--	VOC

1.3. External I/O

I/O Port Description	Quantity	Cable
--	--	--

1.4. Description of Test Facility

Site Description

EMC Lab.

: Accredited by CNAS, June 04, 2010

The Certificate Registration Number. is L4595.

Accredited by FCC, July 14, 2011

The Certificate Registration Number. is 899208.

Accredited by Industry Canada, May. 02, 2011

The Certificate Registration Number. is 9642A-1

1.5. Statement of The Measurement Uncertainty

The data and results referenced in this document are true and accurate. The reader is cautioned that there may be errors within the calibration limits of the equipment and facilities. The measurement uncertainty was calculated for all measurements listed in this test report acc. To CISPR 16 – 4 “Specification for radio disturbance and immunity measuring apparatus and methods – Part 4: Uncertainty in EMC Measurements” and is documented in the LCS quality system acc. To DIN EN ISO/IEC 17025. Furthermore, component and process variability of devices similar to that tested may result in additional deviation. The manufacturer has the sole responsibility of continued compliance of the device.

1.6. Measurement Uncertainty

Test Item	Frequency Range	Uncertainty	Note
Radiation Uncertainty	9KHz~30MHz	$\pm 3.10\text{dB}$	(1)
	30MHz~200MHz	$\pm 2.96\text{dB}$	(1)
	200MHz~1000MHz	$\pm 3.10\text{dB}$	(1)
	1GHz~26.5GHz	$\pm 3.80\text{dB}$	(1)
	26.5GHz~40GHz	$\pm 3.90\text{dB}$	(1)
Conduction Uncertainty	150kHz~30MHz	$\pm 1.63\text{dB}$	(1)
Power disturbance	30MHz~300MHz	$\pm 1.60\text{dB}$	(1)

(1). This uncertainty represents an expanded uncertainty expressed at approximately the 95% confidence level using a coverage factor of $k=2$.

1.7. Description Of Test Modes

Bluetooth operates in the unlicensed ISM Band at 2.4GHz. The following operating modes were applied for the related test items.

This test was performed with EUT in X, Y, Z position and the worse case was found when EUT in X position. All test modes were tested, only the result of the worst case was recorded in the report.

Mode of Operations	Frequency Range (MHz)	Data Rate (Mbps)
GFSK	2405	1
	2445	1
	2480	1
For Conducted Emission		
Test Mode	TX Mode	
For Radiated Emission		
Test Mode	TX Mode	

2. TEST METHODOLOGY

All measurements contained in this report were conducted with ANSI C63.4, American National Standard for Methods of Measurement of Radio-Noise Emissions from Low-Voltage Electrical and Electronic Equipment in the range of 9 kHz to 40 GHz.

The radiated testing was performed at an antenna-to-EUT distance of 3 meters. All radiated and conducted emissions measurement was performed at Shenzhen LCS Compliance Testing Laboratory Ltd..

2.1. EUT Configuration

The EUT configuration for testing is installed on RF field strength measurement to meet the Commissions requirement and operating in a manner that intends to maximize its emission characteristics in a continuous normal application.

2.2. EUT Exercise

The EUT was operated in the engineering mode to fix the TX frequency that was for the purpose of the measurements.

According to FCC's request, Test Procedure KDB558074 is required to be used for this kind of FCC 15.247 digital modulation device.

According to its specifications, the EUT must comply with the requirements of the Section 15.203, 15.205, 15.207, 15.209 and 15.247 under the FCC Rules Part 15 Subpart C

2.3. General Test Procedures

2.3.1 Conducted Emissions

The EUT is placed on the turntable, which is 0.8 m above ground plane. According to the requirements in Section 13.1.4.1 of ANSI C63.4 Conducted emissions from the EUT measured in the frequency range between 0.15 MHz and 30MHz using Quasi-peak and average detector modes.

2.3.2 Radiated Emissions

The EUT is placed on a turn table, which is 0.8 m above ground plane. The turntable shall rotate 360 degrees to determine the position of maximum emission level. EUT is set 3m away from the receiving antenna, which varied from 1m to 4m to find out the highest emission. And also, each emission was to be maximized by changing the polarization of receiving antenna both horizontal and vertical. In order to find out the maximum emissions, exploratory radiated emission measurements were made according to the requirements in Section 13.1.4.1 of ANSI C63.4

3. SYSTEM TEST CONFIGURATION

3.1. Justification

The system was configured for testing in a continuous transmit condition.

3.2. EUT Exercise Software

N/A

3.3. Special Accessories

N/A

3.4. Block Diagram/Schematics

Please refer to the related document

3.5. Equipment Modifications

Shenzhen LCS Compliance Testing Laboratory Ltd. has not done any modification on the EUT.

3.6. Test Setup

Please refer to the test setup photo.

4. SUMMARY OF TEST RESULTS

Applied Standard: FCC Part 15 Subpart C & RSS-210			
FCC Rules	IC Rules	Description of Test	Result
§15.247(b)	A8.4	Maximum Conducted Output Power	Compliant
§15.247(e)	A8.2(b)	Power Spectral Density	Compliant
§15.247(a)(2)	A8.2(a)	6dB Bandwidth	Compliant
§15.247(a)	A8.2(a)	Occupied Bandwidth	Compliant
§15.209, §15.247(d)	A8.5	Radiated and Conducted Spurious Emissions	Compliant
§15.205	A8.5	Emissions at Restricted Band	Compliant
§15.207(a)	RSS-Gen	Line Conducted Emissions	Compliant
§15.203	RSS-Gen	Antenna Requirements	Compliant

5. TEST RESULT

5.1. Maximum Conducted Output Power Measurement

5.1.1. Standard Applicable

According to §15.247(b) & A8.4: Frequency hopping systems shall have hopping channel carrier frequencies separated by a minimum of 25 kHz or the 20 dB bandwidth of the hopping channel, whichever is greater. Alternatively, frequency hopping systems operating in the 2400-2483.5 MHz band may have hopping channel carrier frequencies that are separated by 25 kHz or two-thirds of the 20 dB bandwidth of the hopping channel, whichever is greater, provided the systems operate with an output power no greater than 125mW.

According to §15.247(b)(3), for systems using digital modulation in the bands of 902-928 MHz, 2400-2483.5 MHz, and 5725-5850 MHz: 1 Watt.

5.1.2. Measuring Instruments

Please refer to section 6 of equipments list in this report.

5.1.3. Test Procedures

The transmitter output (antenna port) was connected to the power meter.

5.1.4. Test Setup Layout

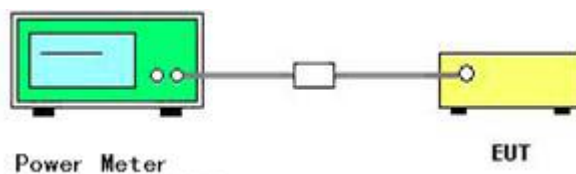

5.1.5. EUT Operation during Test

The EUT was programmed to be in continuously transmitting mode.

5.1.6. Test Result of Maximum Conducted Output Power(Peak)

Modulation	Frequency (MHz)	Output Power (dBm)	Output Power (mW)	Limit (mW)	Result
GFSK	2405	1.35	1.36	1000	Pass
	2445	1.41	1.38	1000	Pass
	2480	1.50	1.41	1000	Pass

5.2. Power Spectral Density Measurement

5.2.1. Standard Applicable

According to §15.247(e) & A8.2(b): For digitally modulated systems, the power spectral density conducted from the intentional radiator to the antenna shall not be greater than 8 dBm in any 3 kHz band during any time interval of continuous transmission.

5.2.2. Measuring Instruments

Please refer to section 6 of equipments list in this report.

5.2.3. Test Procedures

1. The transmitter was connected directly to a Spectrum Analyzer through a directional couple.
2. The power was monitored at the coupler port with a Spectrum Analyzer. The power level was set to the maximum level.
3. Set the RBW = 3 kHz.
4. Set the VBW $\geq 3 \times$ RBW.
5. Set the span to 1.5 times the DTS channel bandwidth.
6. Detector = peak.
7. Sweep time = auto couple.
8. Trace mode = max hold.
9. Allow trace to fully stabilize.
10. Use the peak marker function to determine the maximum power level in any 3 kHz band segment within the fundamental EBW.

5.2.4. Test Setup Layout

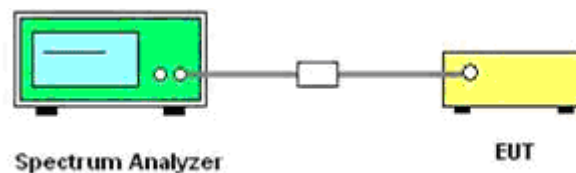

5.2.5. EUT Operation during Test

The EUT was programmed to be in continuously transmitting mode.

5.2.6. Test Result of Power Spectral Density

Modulation	Frequency (MHz)	Reading Level (dBm)	Max. Limit (dBm/3KHz)	Result
GFSK	2405	-14.85	8	Pass
	2445	-14.40	8	Pass
	2480	-14.54	8	Pass

The test data refer to the following page.

Low Channel, 2405MHz

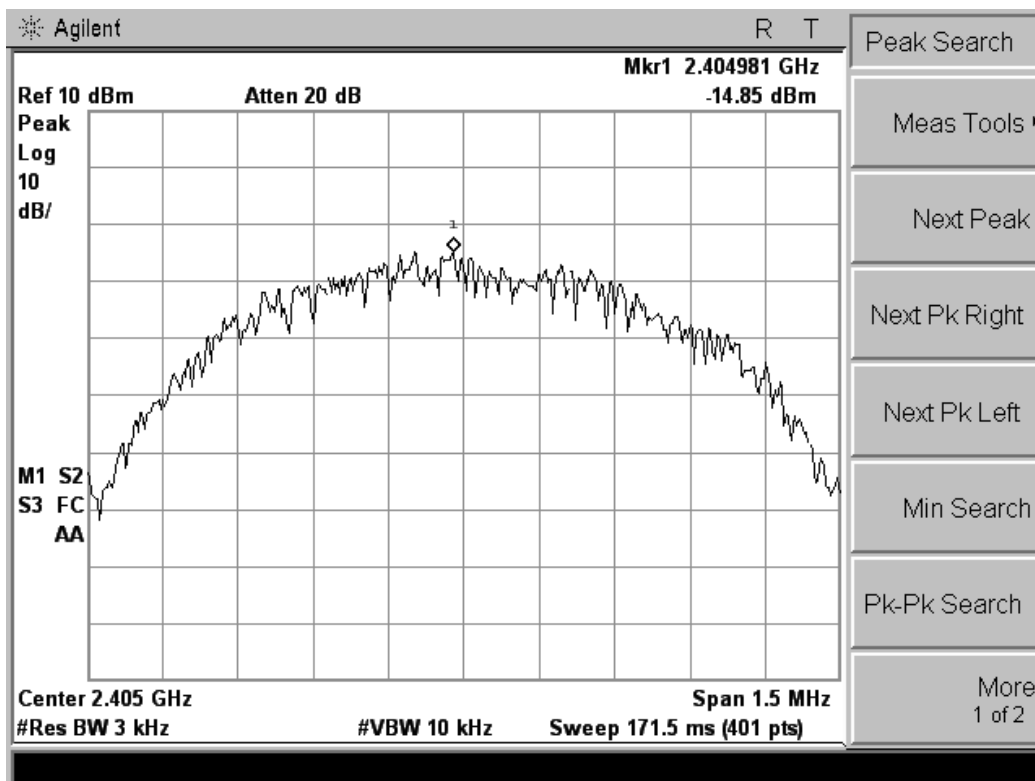

Middle Channel, 2445MHz

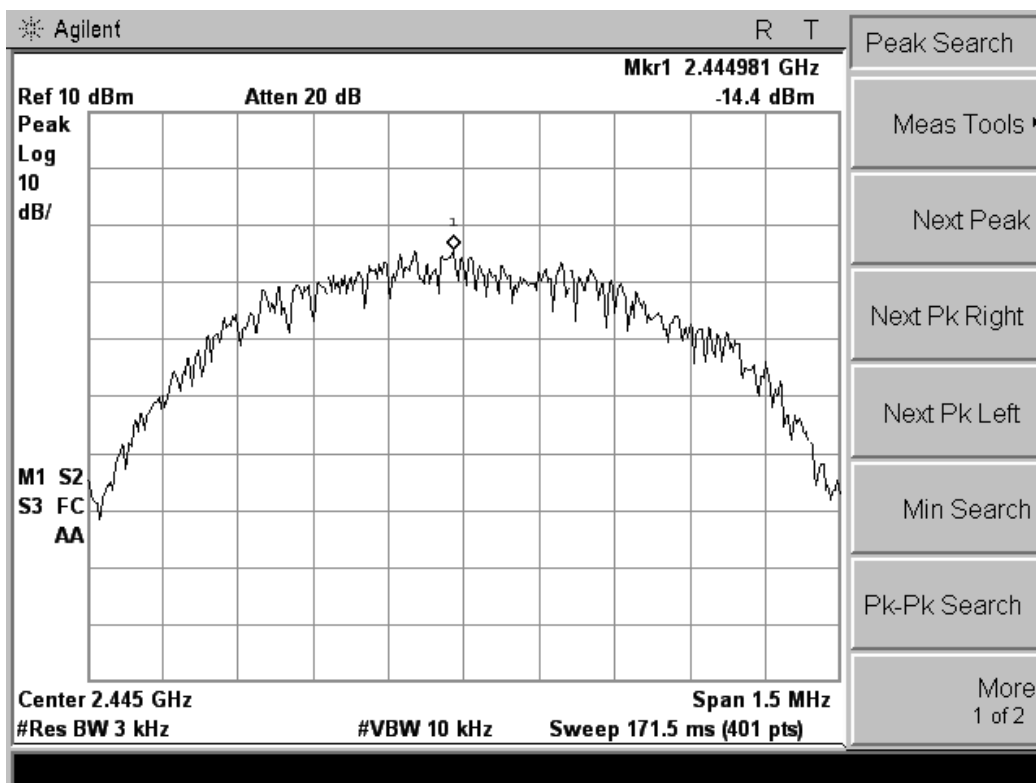

High Channel, 2480MHz

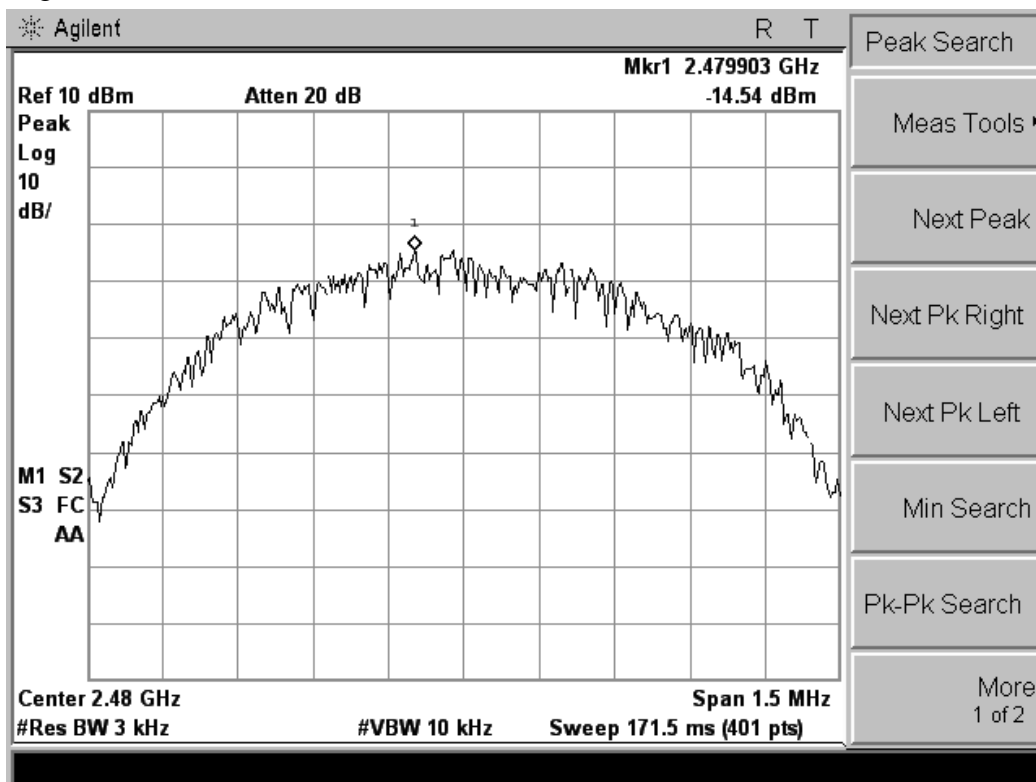

5.3. 6 dB Spectrum Bandwidth Measurement

5.3.1. Standard Applicable

According to §15.247(a)(2) & A8.2(a): For digital modulation systems, the minimum 6 dB bandwidth shall be at least 500 kHz.

5.3.2. Measuring Instruments and Setting

Please refer to section 6 of equipments list in this report. The following table is the setting of the Spectrum Analyzer.

Spectrum Parameter	Setting
Attenuation	Auto
Span Frequency	> RBW
Detector	Peak
Trace	Max Hold
Sweep Time	Auto

5.3.3. Test Procedures

1. The transmitter output (antenna port) was connected to the spectrum analyser in peak hold mode.
2. The resolution bandwidth and the video bandwidth were set according to KDB558074.
3. Measured the spectrum width with power higher than 6dB below carrier.

5.3.4. Test Setup Layout

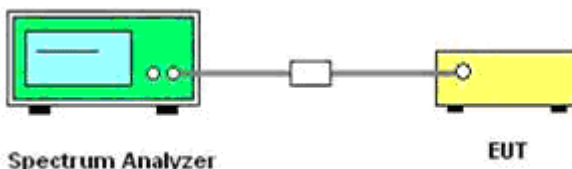

5.3.5. EUT Operation during Test

The EUT was programmed to be in continuously transmitting mode.

5.3.6. Test Result of 6dB Spectrum Bandwidth

Modulation	Frequency (MHz)	6dB Bandwidth (KHz)	Min. Limit (KHz)	Result
GFSK	2405	660.574	500	Complies
	2445	661.714	500	Complies
	2480	662.115	500	Complies

The test data refer to the following page.

Low Channel, 2405MHz

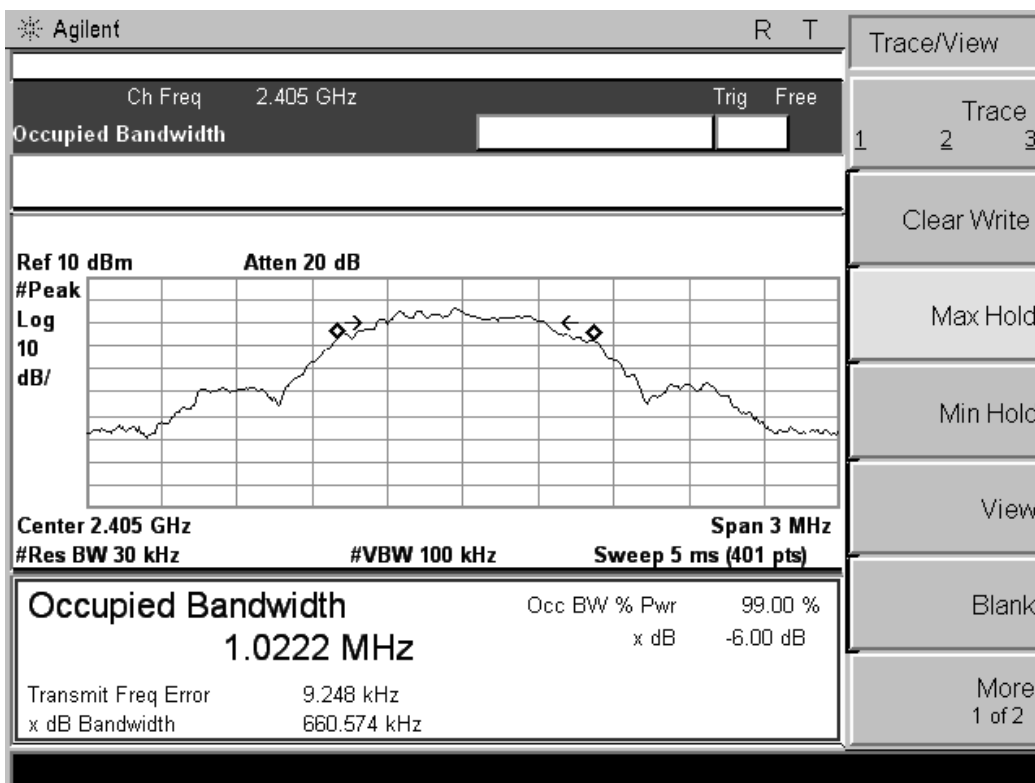

Middle Channel, 2445MHz

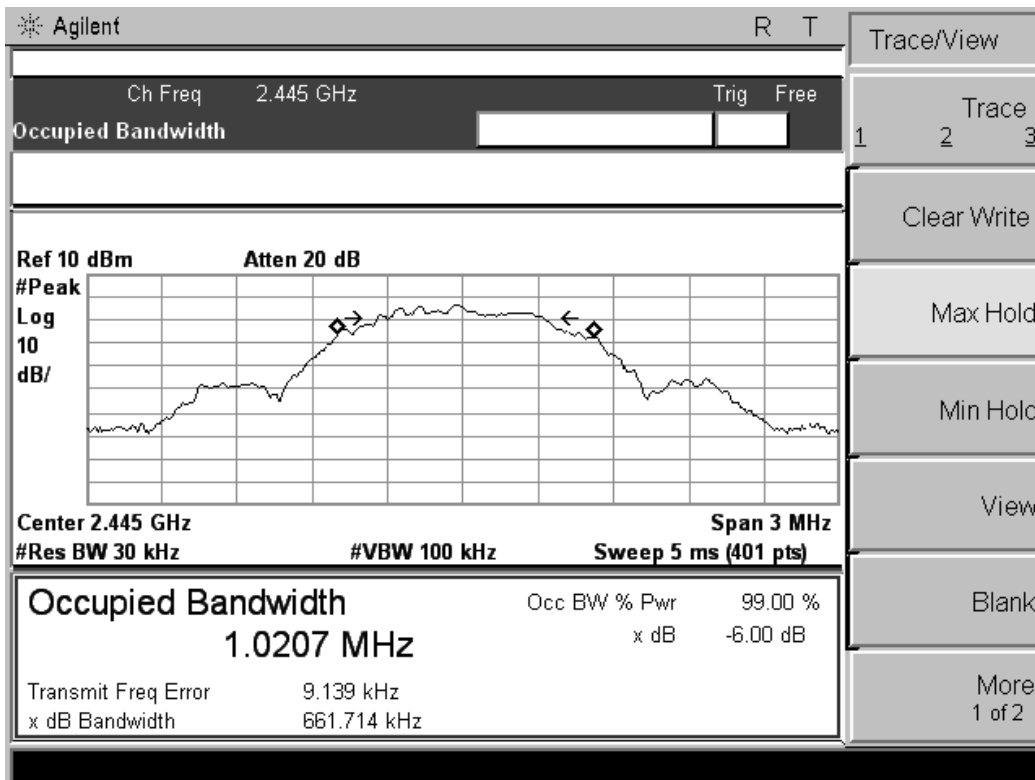

High Channel, 2480MHz

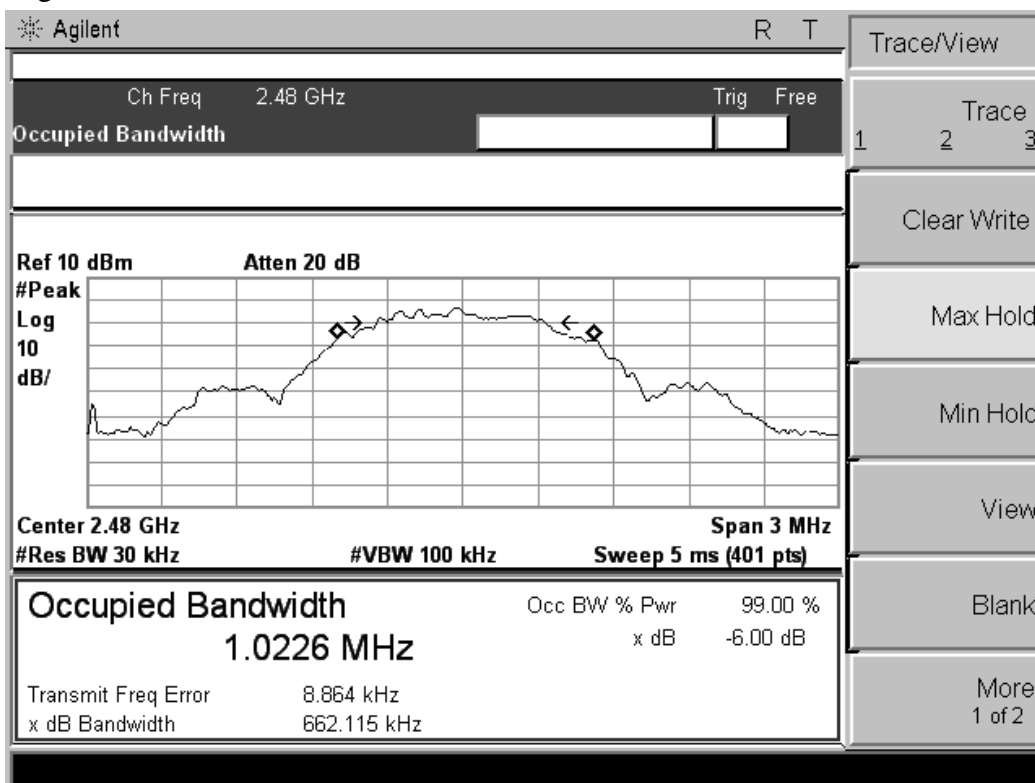

5.4. Occupied Bandwidth

5.4.1. Standard Applicable

According to §15.247(a) & A8.2(a): Operation under the provisions of this section is limited to frequency hopping and digitally modulated intentional radiators that comply with the following provisions:

For systems using digital modulation techniques, the EUT may operate in the 902-928 MHz, 2400-2483.5 MHz and 5725-5850 MHz bands. The minimum 6dB bandwidth shall be at least 500 kHz.

5.4.2. Measuring Instruments and Setting

Please refer to section 6 of equipments list in this report. The following table is the setting of the Spectrum Analyzer.

Spectrum Parameter	Setting
Attenuation	Auto
Span Frequency	> RBW
RBW	1% to 3% of the band
VBW	3 times the RBW
Detector	Peak
Trace	Max Hold
Sweep Time	Auto

5

5.4.3. Test Procedures

The transmitter output is connected to the spectrum analyzer. The RBW is set to 1% to 3% of the bandwidth. The VBW is set to 3 times the RBW. The sweep time is coupled. The spectrum analyzer internal bandwidth measurement function is utilized.

5.4.4. Test Setup Layout

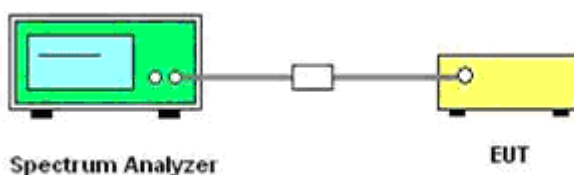

5.4.5. EUT Operation during Test

The EUT was programmed to be in continuously transmitting mode.

5.4.6. Test Result of 99% Occupied Bandwidth.

Channel	Frequency	99% OBW (MHz)
1	2405	1.0223
9	2445	1.0229
16	2480	1.0235

The test data refer to the following page:

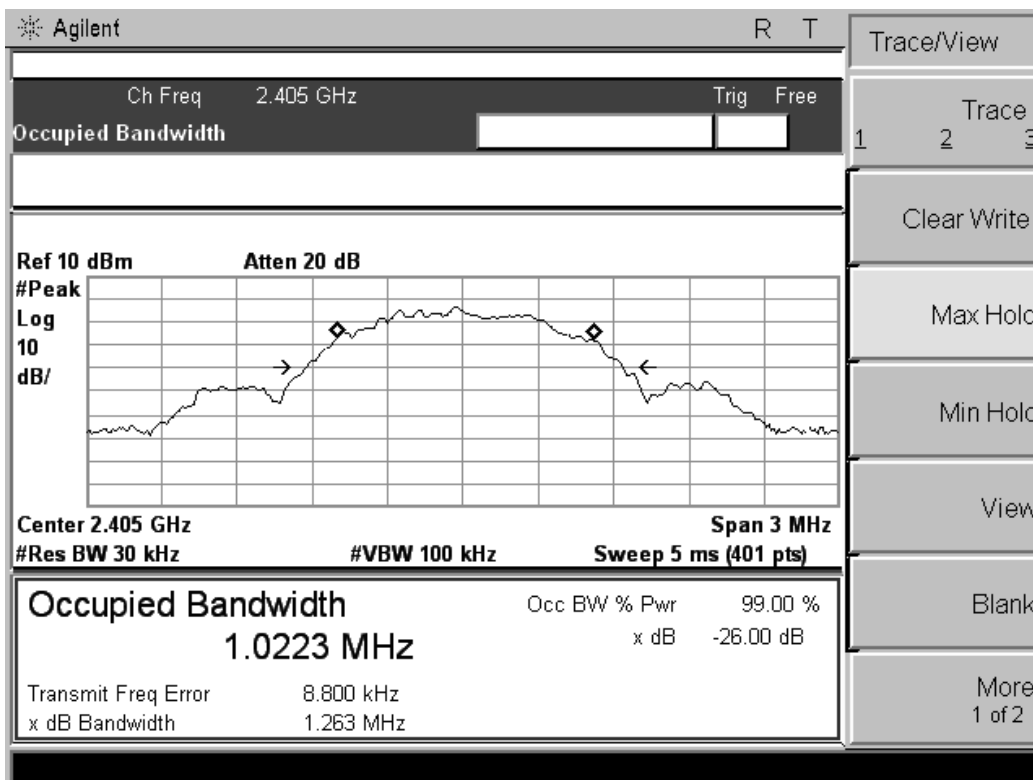

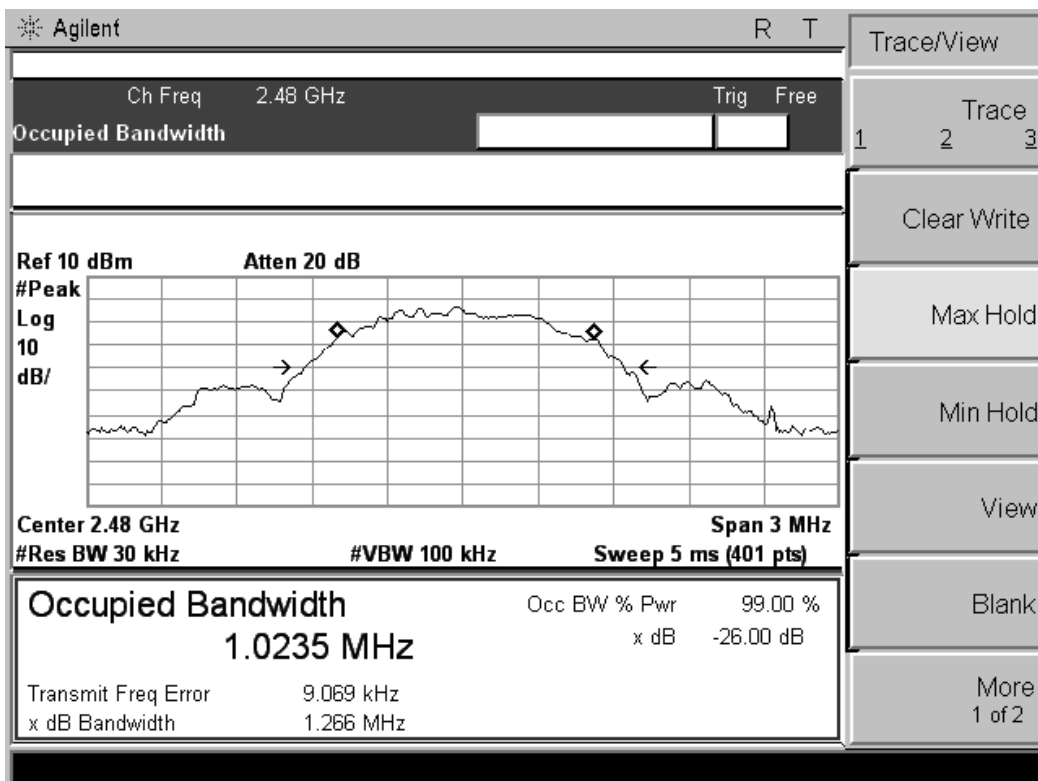
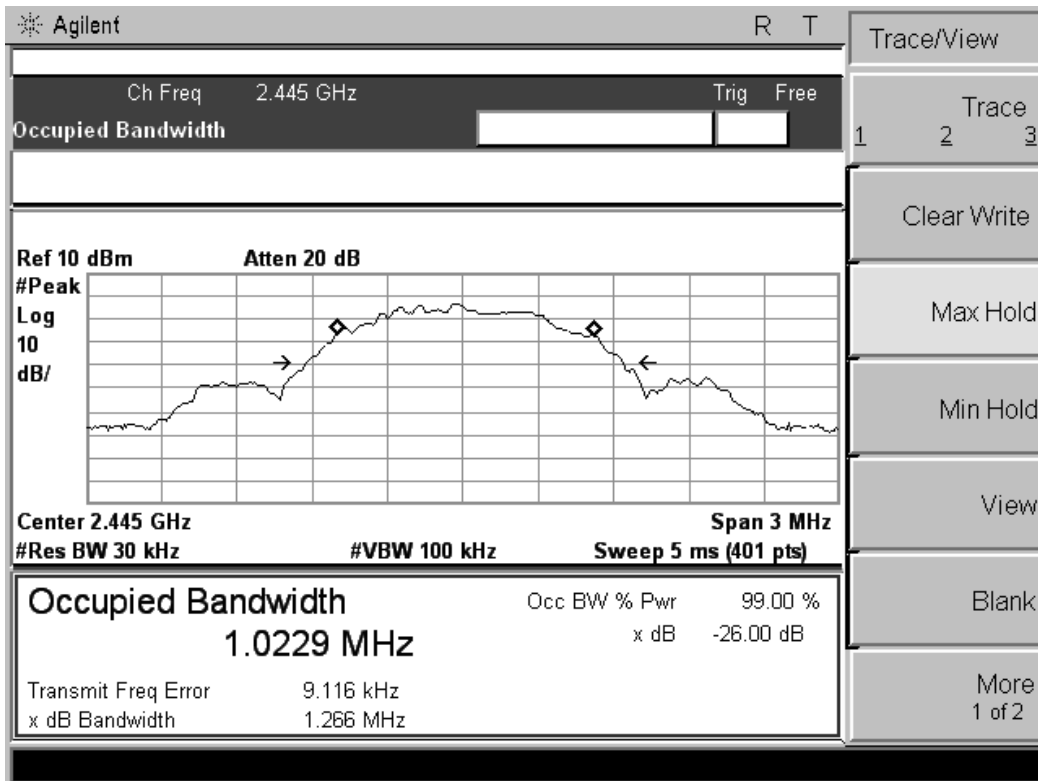

5.5. Radiated Emissions Measurement

5.5.1. Standard Applicable

According to §15.247 (d) & A8.5: 20dBc in any 100 kHz bandwidth outside the operating frequency band. In case the emission fall within the restricted band specified on 15.205(a), then the 15.209(a) limit in the table below has to be followed.

Frequencies(MHz)	Field Strength(microvolts/meter)	Measurement Distance(meters)
0.009~0.490	2400/F(KHz)	300
0.490~1.705	24000/F(KHz)	30
1.705~30.0	30	30
30~88	100	3
88~216	150	3
216~960	200	3
Above 960	500	3

5.5.2. Measuring Instruments and Setting

Please refer to section 6 of equipments list in this report. The following table is the setting of spectrum analyzer and receiver.

Spectrum Parameter	Setting
Attenuation	Auto
Start Frequency	1000 MHz
Stop Frequency	10th carrier harmonic
RB / VB (Emission in restricted band)	1MHz / 1MHz for Peak, 1 MHz / 10Hz for Average
RB / VB (Emission in non-restricted band)	1MHz / 1MHz for Peak, 1 MHz / 10Hz for Average

Spectrum Parameter	Setting
Attenuation	Auto
Start ~ Stop Frequency	9kHz~150kHz / RB 200Hz for QP
Start ~ Stop Frequency	150kHz~30MHz / RB 9kHz for QP
Start ~ Stop Frequency	30MHz~1000MHz / RB 100kHz for QP

5.5.3. Test Procedures

1. Configure the EUT according to ANSI C63.4. The EUT was placed on the top of the turntable 0.8 meter above ground. The phase center of the receiving antenna mounted on the top of a height-variable antenna tower was placed 3 meters far away from the turntable.
2. Power on the EUT and all the supporting units. The turntable was rotated by 360 degrees to determine the position of the highest radiation.
3. The height of the broadband receiving antenna was varied between one meter and four meters above ground to find the maximum emissions field strength of both horizontal and vertical polarization.
4. For each suspected emissions, the antenna tower was scan (from 1 m to 4 m) and then the

turntable was rotated (from 0 degree to 360 degrees) to find the maximum reading

5. Set the test-receiver system to Peak or CISPR quasi-peak Detect Function with specified bandwidth under Maximum Hold Mode.

6. For emissions above 1GHz, use 1MHz VBW and RBW for peak reading. Then 1MHz RBW and 10Hz VBW for average reading in spectrum analyzer.

7. When the radiated emissions limits are expressed in terms of the average value of the emissions, and pulsed operation is employed, the measurement field strength shall be determined by averaging over one complete pulse train, including blanking intervals, as long as the pulse train does not exceed 0.1 seconds. As an alternative (provided the transmitter operates for longer than 0.1 seconds) or in cases where the pulse train exceeds 0.1 seconds, the measured field strength shall be determined from the average absolute voltage during a 0.1 second interval during which the field strength is at its maximum value.

8. If the emissions level of the EUT in peak mode was 3 dB lower than the average limit specified, then testing will be stopped and peak values of EUT will be reported, otherwise, the emissions which do not have 3 dB margin will be repeated one by one using the quasi-peak method for below 1GHz.

9. For testing above 1GHz, the emissions level of the EUT in peak mode was lower than average limit (that means the emissions level in peak mode also complies with the limit in average mode), then testing will be stopped and peak values of EUT will be reported, otherwise, the emissions will be measured in average mode again and reported.

10. In case the emission is lower than 30MHz, loop antenna has to be used for measurement and the recorded data should be QP measured by receiver. High – Low scan is not required in this case.

5.5.4. Test Setup Layout

For radiated emissions below 30MHz

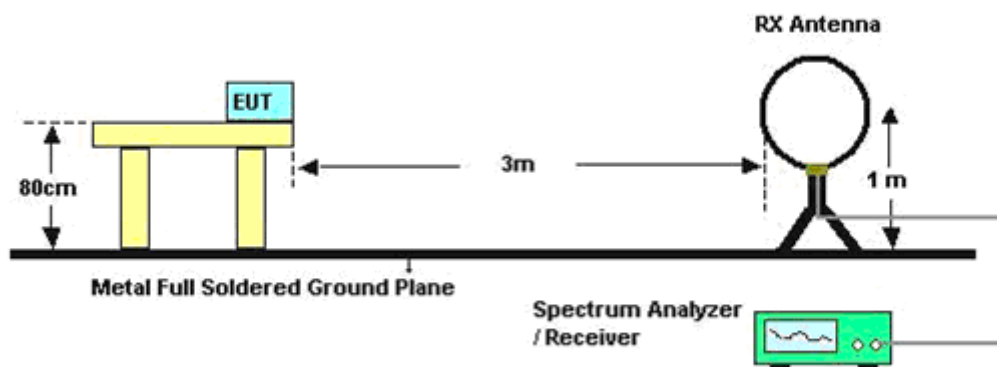

For radiated emissions above 30MHz

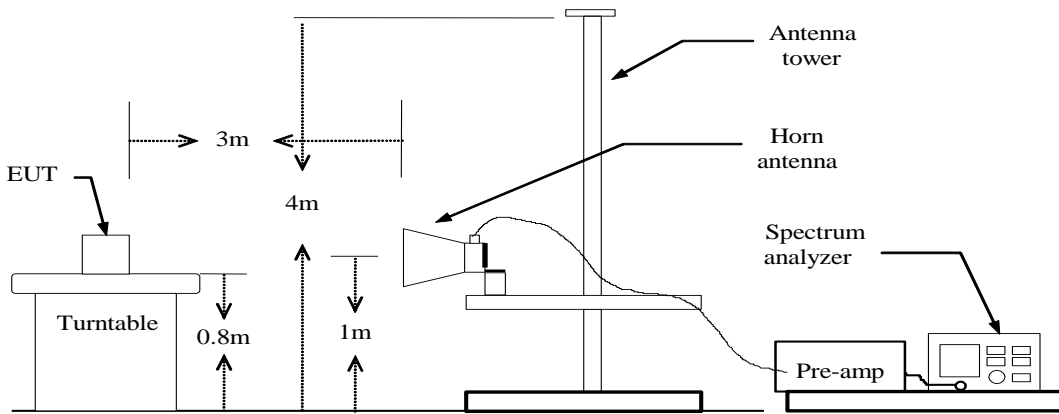
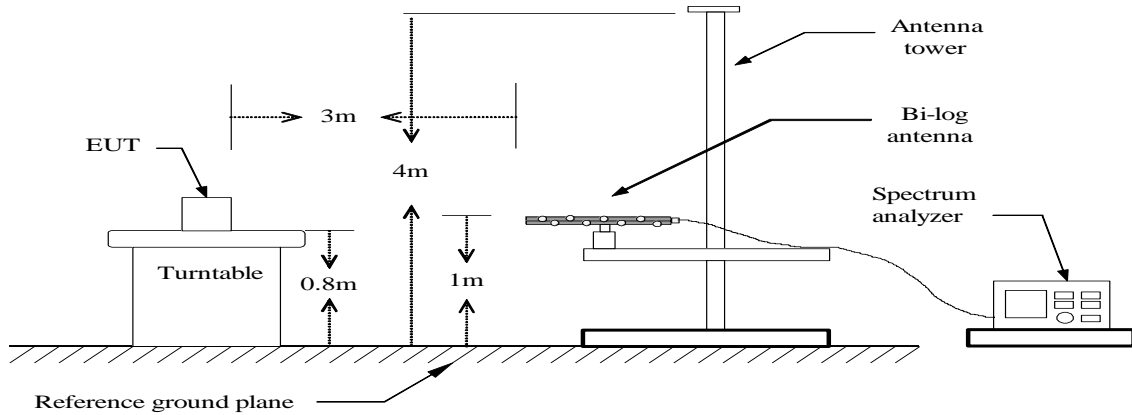

Above 10 GHz shall be extrapolated to the specified distance using an extrapolation factor of 20 dB/decade from 3m to 1.5m.

Distance extrapolation factor = $20 \log (\text{specific distance [3m]} / \text{test distance [1.5m]})$ (dB);

Limit line = specific limits (dBuV) + distance extrapolation factor [6 dB].

5.5.5. EUT Operation during Test

The EUT was programmed to be in continuously transmitting mode.

5.5.6. Results of Radiated Emissions (9kHz~30MHz)

Temperature	25°C	Humidity	60%
Test Engineer	Tree	Configurations	TX

Freq. (MHz)	Level (dBuV)	Over Limit (dB)	Over Limit (dBuV)	Remark
-	-	-	-	See Note

Note:

The amplitude of spurious emissions which are attenuated by more than 20 dB below the permissible value has no need to be reported.

Distance extrapolation factor = $40 \log(\text{specific distance} / \text{test distance})$ (dB);

Limit line = specific limits (dBuV) + distance extrapolation factor.

5.5.7. Results of Radiated Emissions (30MHz~1GHz)

PASS.

The test data please refer to following page:

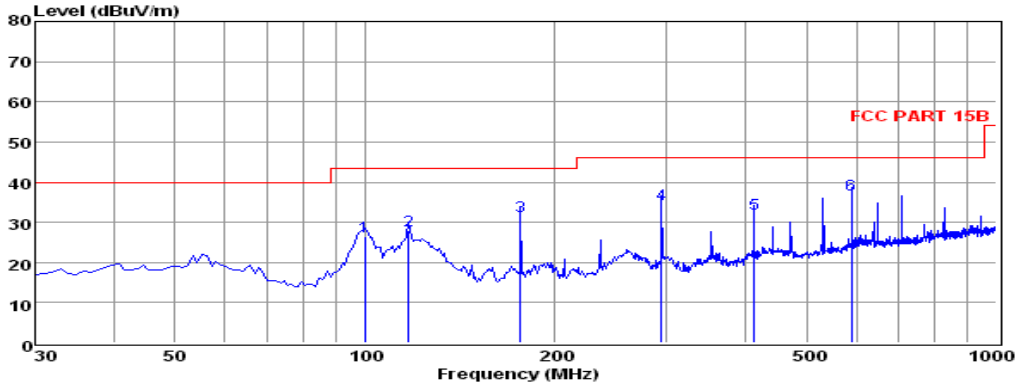

Env./Ins: 24°C/56%
 EUT: Color-Glo HD AiO Swiper
 M/N: SWR-001
 Power Rating: DC 12V
 Test Mode: TX-2405
 Operator: Tree
 Memo:
 pol: HORIZONTAL

	Freq	Reading	CabLos	Antfac	Measured	Limit	Over	Remark
	MHz	dBuV	dB	dB/m	dBuV/m	dBuV/m	dB	
1	99.84	12.85	0.60	13.15	26.60	43.50	-16.90	QP
2	117.30	16.37	0.68	10.96	28.01	43.50	-15.49	QP
3	176.47	21.38	0.73	9.43	31.54	43.50	-11.96	QP
4	294.81	20.50	1.08	12.96	34.54	46.00	-11.46	QP
5	413.15	15.41	1.35	15.33	32.09	46.00	-13.91	QP
6	589.69	17.12	1.40	18.26	36.78	46.00	-9.22	QP

Note: 1. All readings are Quasi-peak values.
 2. Measured= Reading + Antenna Factor + Cable Loss
 3. The emission that ate 20db blow the official limit are not reported

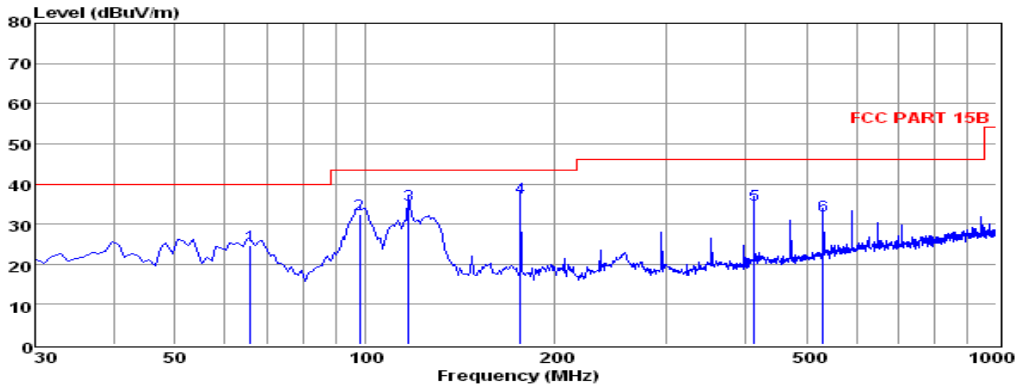

Env./Ins: 24°C/56%
 EUT: Color-Glo HD AiO Swiper
 M/N: SWR-001
 Power Rating: DC 12V
 Test Mode: TX-2405
 Operator: Tree
 Memo:
 pol: VERTICAL

	Freq	Reading	CabLos	Antfac	Measured	Limit	Over	Remark
	MHz	dBuV	dB	dB/m	dBuV/m	dBuV/m	dB	
1	65.89	13.69	0.52	10.34	24.55	40.00	-15.45	QP
2	97.90	18.70	0.61	13.03	32.34	43.50	-11.16	QP
3	117.30	23.17	0.68	10.96	34.81	43.50	-8.69	QP
4	176.47	26.28	0.73	9.43	36.44	43.50	-7.06	QP
5	413.15	18.07	1.35	15.33	34.75	46.00	-11.25	QP
6	531.49	13.52	1.36	17.17	32.05	46.00	-13.95	QP

Note: 1. All readings are Quasi-peak values.
 2. Measured= Reading + Antenna Factor + Cable Loss
 3. The emission that ate 20db blow the official limit are not reported

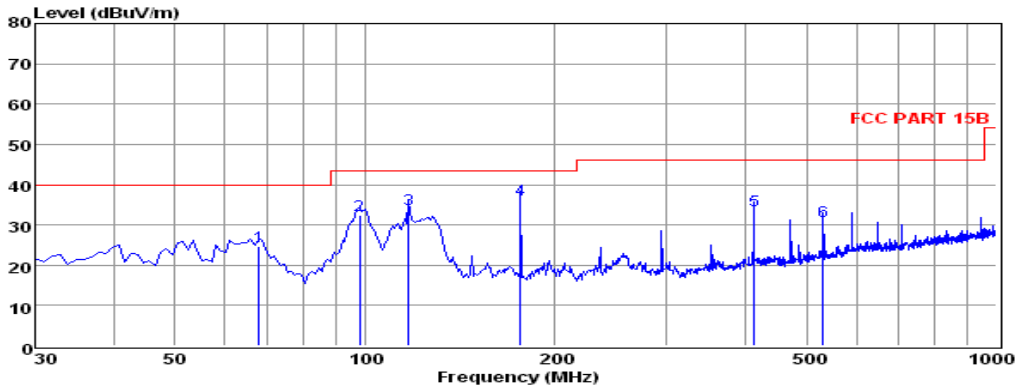

Env./Ins: 24°C/56%
 EUT: Color-Glo HD AiO Swiper
 M/N: SWR-001
 Power Rating: DC 12V
 Test Mode: TX-2445
 Operator: Tree
 Memo:
 pol: VERTICAL

	Freq	Reading	CabLos	Antfac	Measured	Limit	Over	Remark
	MHz	dBuV	dB	dB/m	dBuV/m	dBuV/m	dB	
1	67.83	14.52	0.51	9.54	24.57	40.00	-15.43	QP
2	97.90	18.63	0.61	13.03	32.27	43.50	-11.23	QP
3	117.30	22.40	0.68	10.96	34.04	43.50	-9.46	QP
4	176.47	26.12	0.73	9.43	36.28	43.50	-7.22	QP
5	413.15	16.97	1.35	15.33	33.65	46.00	-12.35	QP
6	531.49	12.42	1.36	17.17	30.95	46.00	-15.05	QP

Note: 1. All readings are Quasi-peak values.
 2. Measured= Reading + Antenna Factor + Cable Loss
 3. The emission that ate 20db blow the official limit are not reported

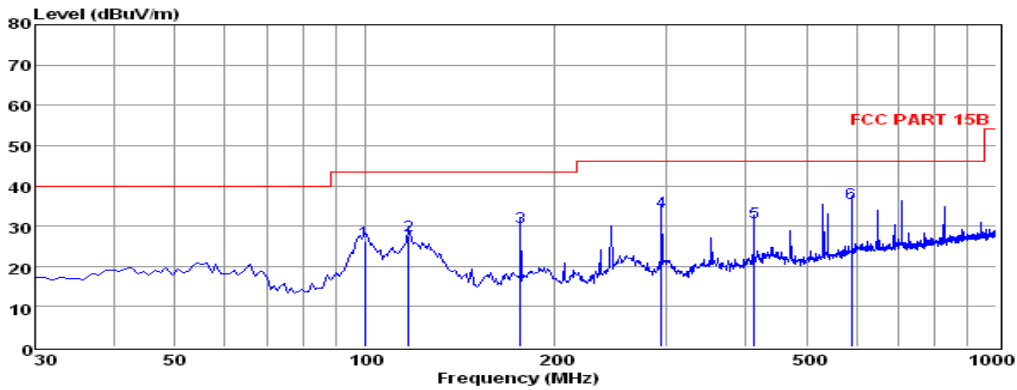

Env./Ins: 24°C/56%
 EUT: Color-Glo HD AiO Swiper
 M/N: SWR-001
 Power Rating: DC 12V
 Test Mode: TX-2445
 Operator: Tree
 Memo:
 pol: HORIZONTAL

	Freq	Reading	CabLos	Antfac	Measured	Limit	Over	Remark
	MHz	dBuV	dB	dB/m	dBuV/m	dBuV/m	dB	
1	99.84	12.57	0.60	13.15	26.32	43.50	-17.18	QP
2	117.30	16.02	0.68	10.96	27.66	43.50	-15.84	QP
3	176.47	19.53	0.73	9.43	29.69	43.50	-13.81	QP
4	294.81	19.44	1.08	12.96	33.48	46.00	-12.52	QP
5	413.15	14.11	1.35	15.33	30.79	46.00	-15.21	QP
6	589.69	15.96	1.40	18.26	35.62	46.00	-10.38	QP

Note: 1. All readings are Quasi-peak values.
 2. Measured= Reading + Antenna Factor + Cable Loss
 3. The emission that ate 20db blow the official limit are not reported

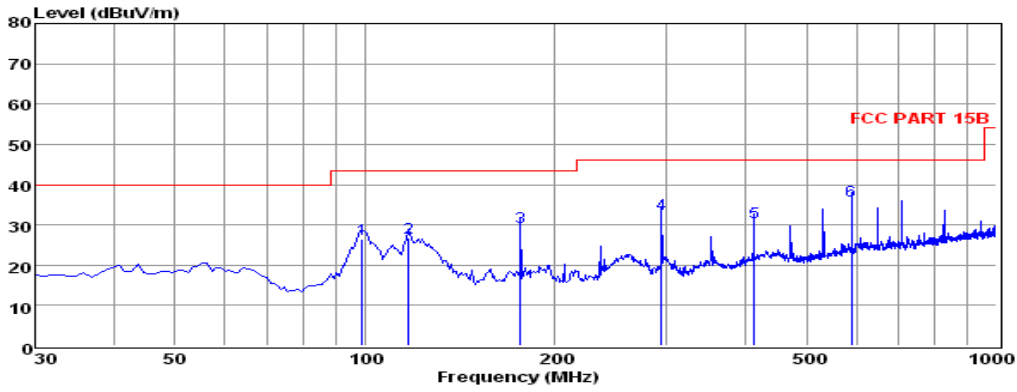

Env./Ins: 24°C/56%
 EUT: Color-Glo HD AiO Swiper
 M/N: SWR-001
 Power Rating: DC 12V
 Test Mode: TX-2480
 Operator: Tree
 Memo:
 pol: HORIZONTAL

	Freq	Reading	CabLos	Antfac	Measured	Limit	Over	Remark
	MHz	dBuV	dB	dB/m	dBuV/m	dBuV/m	dB	
1	98.87	12.85	0.61	13.09	26.55	43.50	-16.95	QP
2	117.30	15.11	0.68	10.96	26.75	43.50	-16.75	QP
3	176.47	19.36	0.73	9.43	29.52	43.50	-13.98	QP
4	294.81	18.60	1.08	12.96	32.64	46.00	-13.36	QP
5	413.15	13.94	1.35	15.33	30.62	46.00	-15.38	QP
6	589.69	16.30	1.40	18.26	35.96	46.00	-10.04	QP

Note: 1. All readings are Quasi-peak values.
 2. Measured= Reading + Antenna Factor + Cable Loss
 3. The emission that ate 20db blow the official limit are not reported

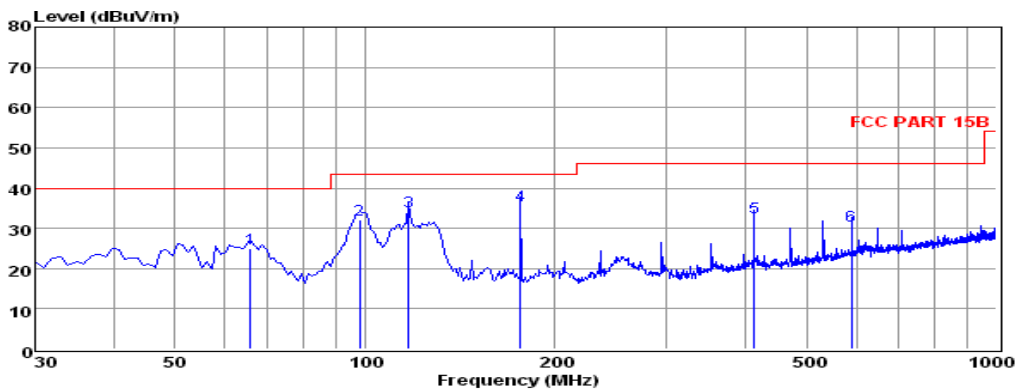

Env./Ins: 24°C/56%
 EUT: Color-Glo HD AiO Swiper
 M/N: SWR-001
 Power Rating: DC 12V
 Test Mode: TX-2480
 Operator: Tree
 Memo:
 pol: VERTICAL

	Freq	Reading	CabLos	Antfac	Measured	Limit	Over	Remark
	MHz	dBuV	dB	dB/m	dBuV/m	dBuV/m	dB	
1	65.89	14.14	0.52	10.34	25.00	40.00	-15.00	QP
2	97.90	18.52	0.61	13.03	32.16	43.50	-11.34	QP
3	117.30	22.66	0.68	10.96	34.30	43.50	-9.20	QP
4	176.47	25.53	0.73	9.43	35.69	43.50	-7.81	QP
5	413.15	15.91	1.35	15.33	32.59	46.00	-13.41	QP
6	589.69	11.07	1.40	18.26	30.73	46.00	-15.27	QP

Note: 1. All readings are Quasi-peak values.
 2. Measured= Reading + Antenna Factor + Cable Loss
 3. The emission that ate 20db blow the official limit are not reported

Note:

Emission level (dBuV/m) = 20 log Emission level (uV/m).

Corrected Reading: Antenna Factor + Cable Loss + Read Level - Preamp Factor = Measured Level.

5.5.8. Results for Radiated Emissions (Above 1GHz)

Channel 1

Freq. MHz	Reading Level dBuV	Ant. Fac. dB/m	Pre. Fac. dB	Cab. Loss dB	Measured dBuV/m	Limit dBuV/m	Margin dB	Remark	Pol.
4810.04	47.32	33.06	35.04	3.94	49.28	74	-24.72	Peak	Horizontal
4810.07	38.23	33.06	35.04	3.94	40.19	54	-13.81	Average	Horizontal
4810.04	47.97	33.06	35.04	3.94	49.93	74	-24.07	Peak	Vertical
4810.07	38.86	33.06	35.04	3.94	40.82	54	-13.18	Average	Vertical

Channel 9

Freq. MHz	Reading Level dBuV	Ant. Fac. dB/m	Pre. Fac. dB	Cab. Loss dB	Measured dBuV/m	Limit dBuV/m	Margin dB	Remark	Pol.
4890.08	46.71	33.16	35.15	3.96	48.68	74	-25.32	Peak	Horizontal
4890.14	37.08	33.16	35.15	3.96	39.05	54	-14.95	Average	Horizontal
4890.08	47.90	33.16	35.15	3.96	49.87	74	-24.13	Peak	Vertical
4890.14	38.71	33.16	35.15	3.96	40.68	54	-13.32	Average	Vertical

Channel 16

Freq. MHz	Reading Level dBuV	Ant. Fac. dB/m	Pre. Fac. dB	Cab. Loss dB	Measured dBuV/m	Limit dBuV/m	Margin dB	Remark	Pol.
4960.32	46.42	33.26	35.14	3.98	48.52	74	-25.48	Peak	Horizontal
4960.37	36.45	33.26	35.14	3.98	38.55	54	-15.45	Average	Horizontal
4960.32	47.26	33.26	35.14	3.98	49.36	74	-24.64	Peak	Vertical
4960.38	38.38	33.26	35.14	3.98	40.48	54	-13.52	Average	Vertical

Notes:

1. Measuring frequencies from 9k~10th harmonic (ex. 26GHz), No emission found between lowest internal used/generated frequency to 30 MHz.
2. Radiated emissions measured in frequency range from 9k~10th harmonic (ex. 26GHz) were made with an instrument using Peak detector mode.
3. Data of measurement within this frequency range shown " --- " in the table above means the reading of emissions are attenuated more than 20dB below the permissible limits or the field strength is too small to be measured.

5.5.9. Results for Band edge Testing (Radiated)

Tx-2405

Freq. MHz	Reading Level dBuV	Ant. Fac. dB/m	Pre. Fac. dB	Cab. Loss dB	Measured dBuV/m	Limit dBuV/m	Margin dB	Remark	Pol.
2370.05	44.66	32.89	35.16	3.51	45.90	74	-28.10	Peak	Horizontal
2370.13	34.87	32.90	35.16	3.51	36.12	54	-17.88	Average	Horizontal
2400.00	48.82	32.92	35.16	3.54	50.12	74	-23.88	Peak	Horizontal
2400.01	39.47	32.92	35.16	3.54	40.77	54	-13.23	Average	Horizontal
2370.18	45.22	32.89	35.16	3.51	46.46	74	-27.54	Peak	Vertical
2370.22	36.32	32.90	35.16	3.51	37.57	54	-16.43	Average	Vertical
2400.01	49.26	32.92	35.16	3.54	50.56	74	-23.44	Peak	Vertical
2400.00	39.06	32.92	35.16	3.54	40.36	54	-13.64	Average	Vertical

Tx-2480

Freq. MHz	Reading Level dBuV	Ant. Fac. dB/m	Pre. Fac. dB	Cab. Loss dB	Measured dBuV/m	Limit dBuV/m	Margin dB	Remark	Pol.
2483.50	45.68	33.06	35.18	3.60	47.16	74	-26.84	Peak	Horizontal
2483.49	35.73	33.08	35.18	3.60	37.23	54	-16.77	Average	Horizontal
2486.87	46.22	33.08	35.18	3.62	47.74	74	-26.26	Peak	Horizontal
2486.94	36.14	33.08	35.18	3.62	37.66	54	-16.34	Average	Horizontal
2483.50	46.55	33.06	35.18	3.60	48.03	74	-25.97	Peak	Vertical
2483.51	35.79	33.08	35.18	3.60	37.29	54	-16.71	Average	Vertical
2486.83	46.76	33.08	35.18	3.62	48.28	74	-25.72	Peak	Vertical
2486.91	36.77	33.08	35.18	3.62	38.29	54	-15.71	Average	Vertical

5.6. Conducted Spurious Emissions And Band Edges Test

5.6.1. Standard Applicable

According to §15.247 (d) & A8.5: In any 100 kHz bandwidth outside the frequency band in which the spread spectrum or digitally modulated intentional radiator is operating, the radio frequency power that is produced by the intentional radiator shall be at least 20 dB below that in the 100 kHz bandwidth within the band that contains the highest level of the desired power, based on either an RF conducted or a radiated measurement. Attenuation below the general limits specified in Section 15.209(a) is not required. In addition, radiated emissions which fall in the restricted bands, as defined in Section 15.205(a), must also comply with the radiated emission limits specified in Section 15.209(a) (see Section 15.205(c)).

5.6.2. Measuring Instruments and Setting

Please refer to section 6 of equipments list in this report. The following table is the setting of the spectrum analyzer.

Spectrum Parameter	Setting
Detector	Peak
Attenuation	Auto
RB / VB (Emission in restricted band)	100KHz/300KHz
RB / VB (Emission in non-restricted band)	100KHz/300KHz

5.6.3. Test Procedures

The transmitter output is connected to a spectrum analyzer. The resolution bandwidth is set to 100 kHz. The video bandwidth is set to 300 kHz

The spectrum from 30 MHz to 26 GHz is investigated with the transmitter set to the lowest, middle, and highest channels.

5.6.4. Test Setup Layout

This test setup layout is the same as that shown in section 5.4.4.

5.6.5. EUT Operation during Test

The EUT was programmed to be in continuously transmitting mode.

5.6.6. Test Results of Conducted Spurious Emissions

Test Result of Low Channel:

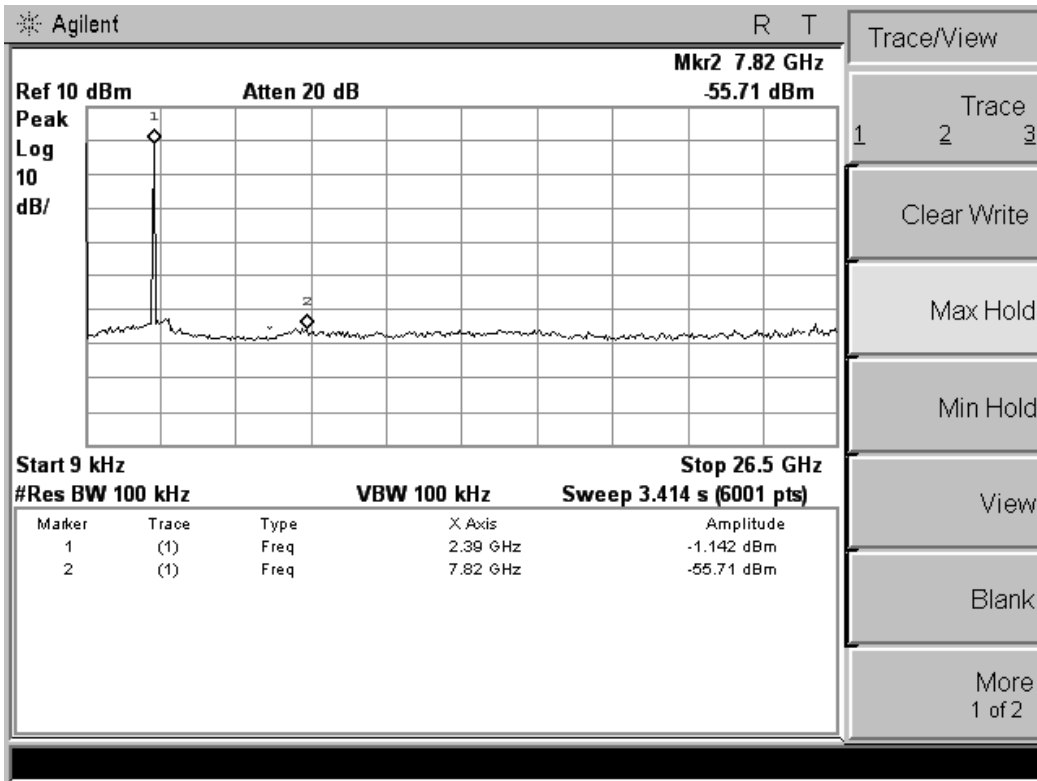

Test Result of Middle Channel:

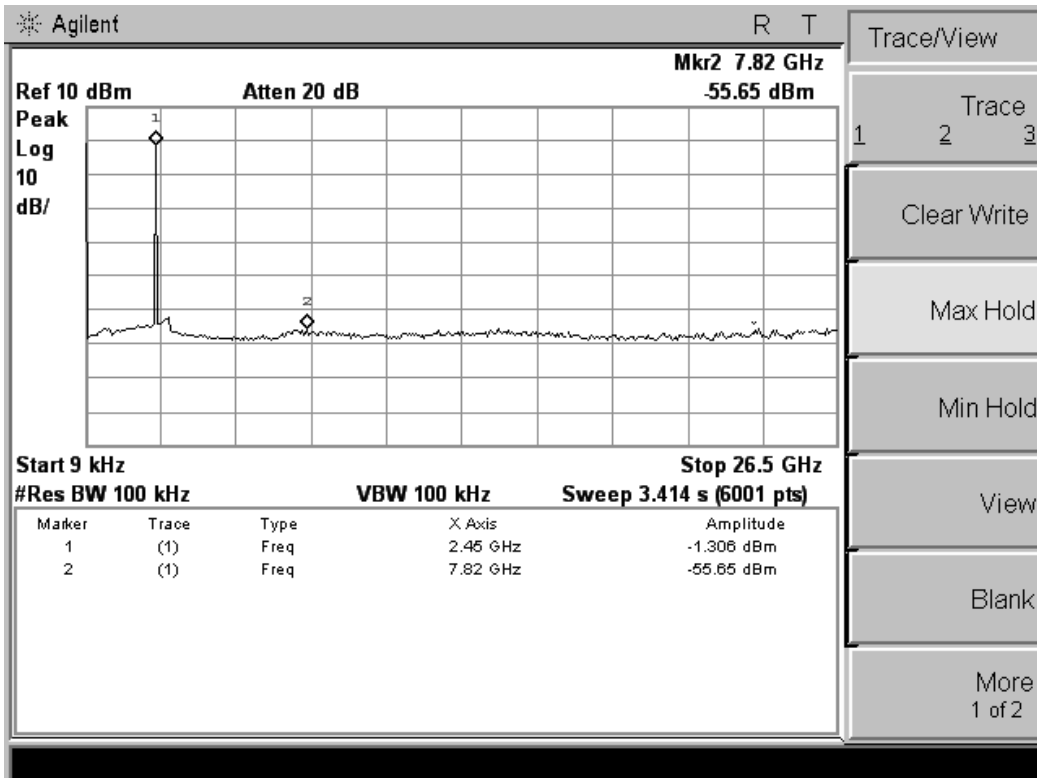

Test Result of High Channel:

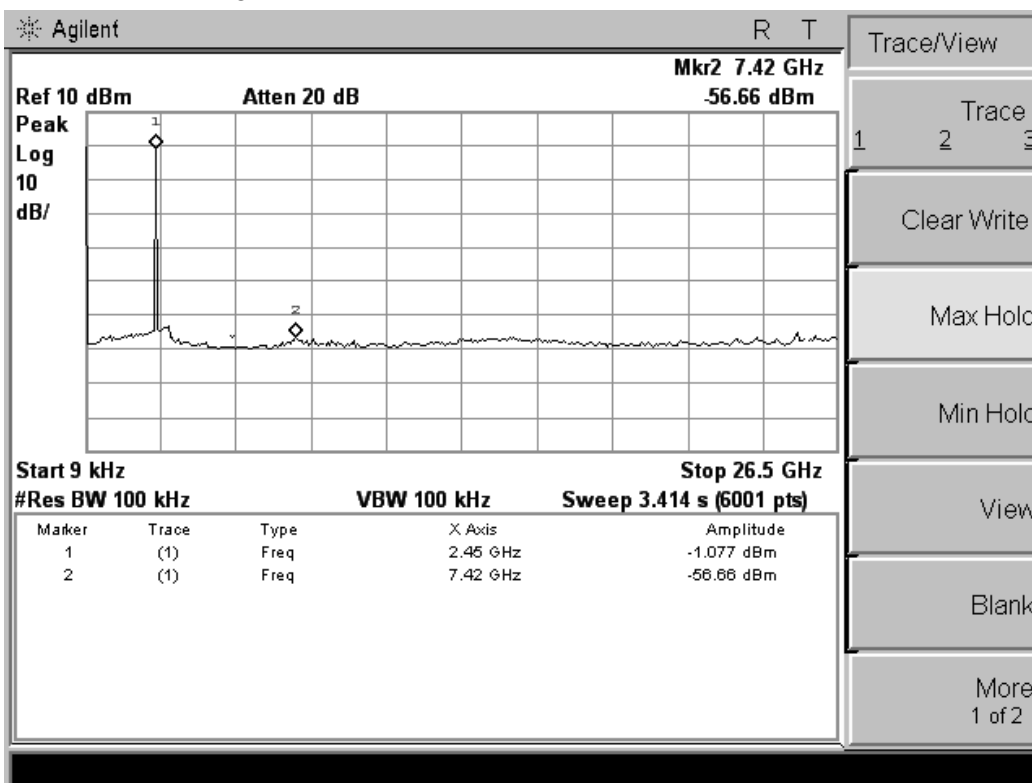

5.6.7. Test Results of Band Edges Test

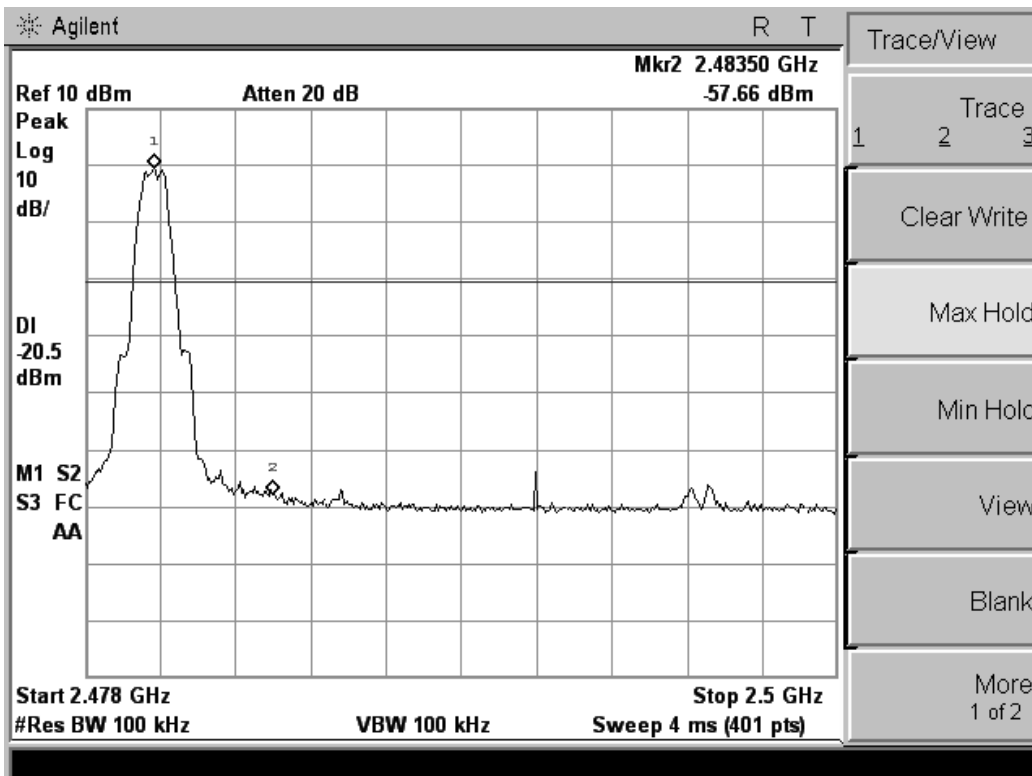
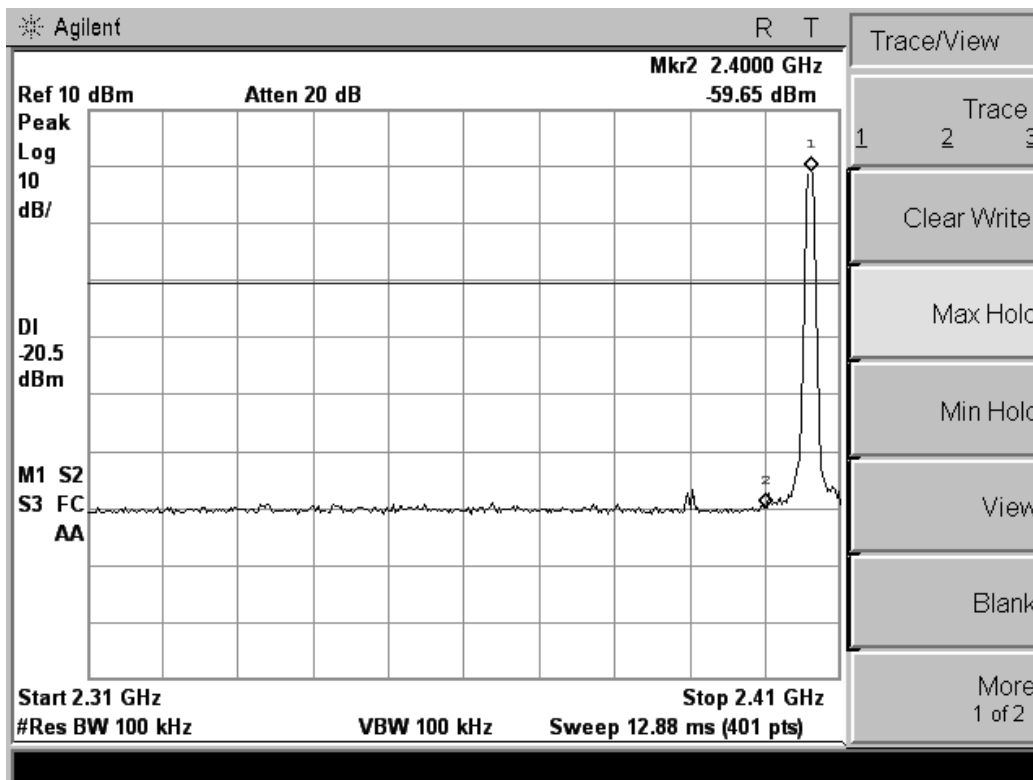

5.7. Power line conducted emissions

5.7.1 Standard Applicable

According to §15.207 (a) or RSS-Gen: For an intentional radiator which is designed to be connected to the public utility (AC) power line, the radio frequency voltage that is conducted back onto the AC power line on any frequency or frequencies within the band 150 kHz to 30 MHz shall not exceed 250 microvolts (The limit decreases linearly with the logarithm of the frequency in the range 0.15 MHz to 0.50 MHz). The limits at specific frequency range is listed as follows:

Frequency Range (MHz)	Limits (dBµV)	
	Quasi-peak	Average
0.15 to 0.50	66 to 56	56 to 46
0.50 to 5	56	46
5 to 30	60	50

5.7.2 Block Diagram of Test Setup

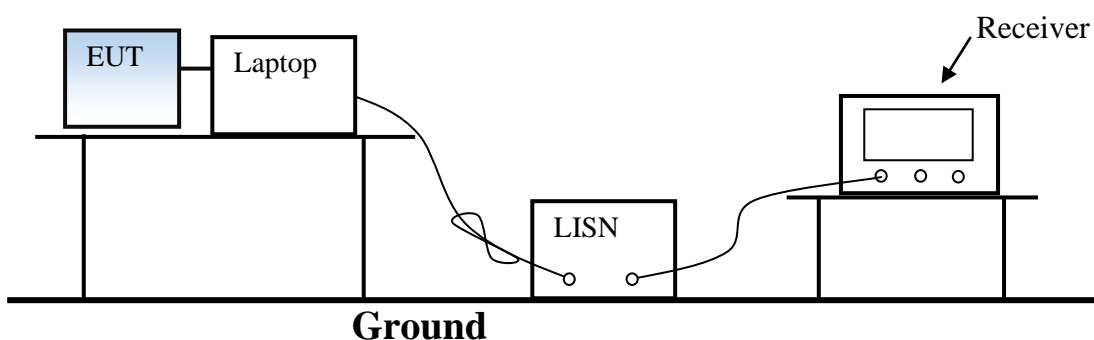

5.7.3 Test Results

PASS.

The test data please refer to following page.

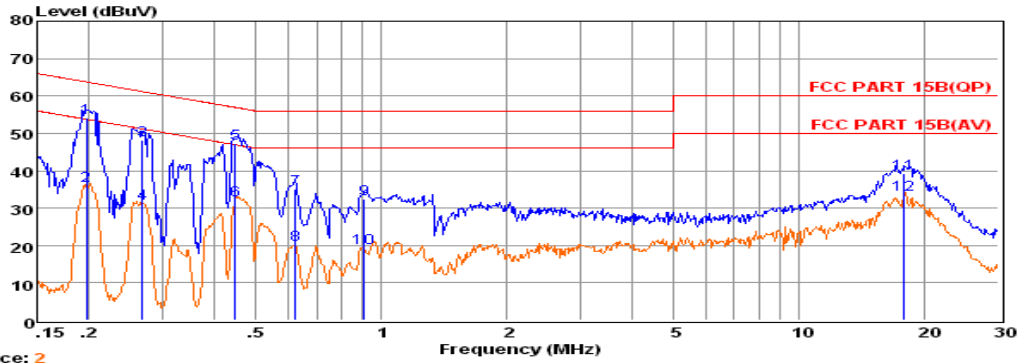

Trace: 2
 Env. Ins: 24*/56%
 EUT: Color-Glo HD Aio Swiper
 M/N: SWR-001
 Power Rating: AC 120V/60Hz
 Test Mode: TX
 Operator: Tree
 Memo:
 Pol: LINE

Freq	Reading	LisnFac	CabLos	Measured	Limit	Over	Remark	
MHz	dBuV	dB	dB	dBuV	dBuV	dB		
1	0.19654	43.91	0.19	0.02	54.12	63.76	-9.64	QP
2	0.19657	25.90	0.19	0.02	36.11	53.75	-17.64	Average
3	0.26866	38.19	0.03	0.03	48.25	61.16	-12.91	QP
4	0.26867	21.32	0.03	0.03	31.38	51.16	-19.78	Average
5	0.44679	37.08	0.03	0.04	47.15	56.93	-9.78	QP
6	0.44680	22.00	0.03	0.04	32.07	46.93	-14.86	Average
7	0.62383	25.04	0.02	0.04	35.10	56.00	-20.90	QP
8	0.62384	10.21	0.02	0.04	20.27	46.00	-25.73	Average
9	0.90874	22.26	0.03	0.05	32.34	56.00	-23.66	QP
10	0.90875	9.32	0.03	0.05	19.40	46.00	-26.60	Average
11	7.84926	28.97	0.23	0.11	39.31	60.00	-20.69	QP
12	17.85026	23.30	0.23	0.11	33.64	50.00	-16.36	Average

Remarks: 1. Measured = Reading + Lisn Factor +Cable Loss.
 2. The emission levels that are 20dB below the official limit are not reported.

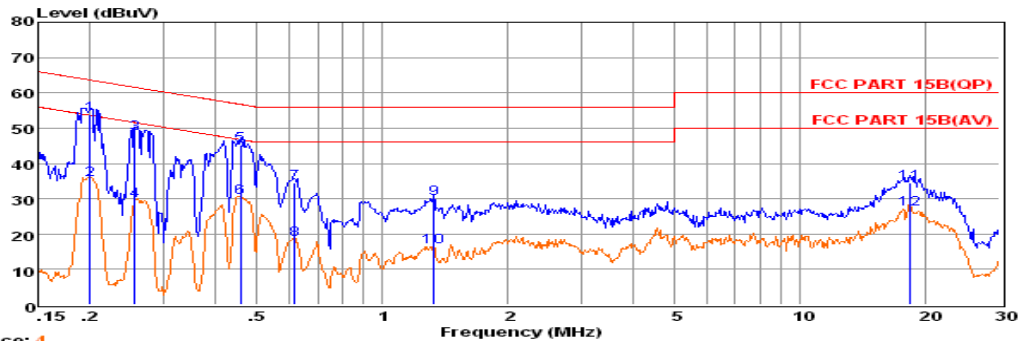

Trace: 4
 Env. Ins: 24*/56%
 EUT: Color-Glo HD Aio Swiper
 M/N: SWR-001
 Power Rating: AC 120V/60Hz
 Test Mode: TX
 Operator: Tree
 Memo:
 Pol: LINE

Freq	Reading	LisnFac	CabLos	Measured	Limit	Over	Remark	
MHz	dBuV	dB	dB	dBuV	dBuV	dB		
1	0.19969	43.45	0.26	0.02	53.73	63.62	-9.89	QP
2	0.19970	25.25	0.26	0.02	35.53	53.62	-18.09	Average
3	0.25615	38.32	0.03	0.03	48.38	61.56	-13.18	QP
4	0.25616	19.33	0.03	0.03	29.39	51.56	-22.17	Average
5	0.45878	35.19	0.03	0.04	45.26	56.71	-11.45	QP
6	0.45881	20.12	0.03	0.04	30.19	46.71	-16.52	Average
7	0.61726	24.52	0.02	0.04	34.58	56.00	-21.42	QP
8	0.61727	8.26	0.02	0.04	18.32	46.00	-27.68	Average
9	1.33081	19.91	0.04	0.05	30.00	56.00	-26.00	QP
10	1.33169	6.29	0.04	0.05	16.38	46.00	-29.62	Average
11	18.32844	24.12	0.23	0.11	34.46	60.00	-25.54	QP
12	18.32874	16.62	0.23	0.11	26.96	50.00	-23.04	Average

Remarks: 1. Measured = Reading + Lisn Factor +Cable Loss.
 2. The emission levels that are 20dB below the official limit are not reported.

***Note: Pre-scan all mode and recorded the worst case results in this report.

5.8. Antenna Requirements

5.8.1. Standard Applicable

According to § 15.203 & RSS-Gen, an intentional radiator shall be designed to ensure that no antenna other than that furnished by the responsible party shall be used with the device.

5.8.2. Antenna Connector Construction

The directional gains of antenna used for transmitting is 3.6dBi(Max.), and it is permanently attached and no consideration of replacement. Please see EUT photo for details.

5.8.3. Results: Compliance.

6. LIST OF MEASURING EQUIPMENTS

Instrument	Manufacturer	Model No.	Serial No.	Characteristics	Cal Date	Due Date
EMC Receiver	R&S	ESCS 30	100174	9kHz – 2.75GHz	June 18,2013	June 17,2014
Signal analyzer	Agilent	E4448A(External mixers to 40GHz)	US44300469	9kHz~40GHz	July 16,2013	July 15,2014
LISN	MESS Tec	NNB-2/16Z	99079	9KHz-30MHz	June 18,2013	June 17,2014
LISN (Support Unit)	EMCO	3819/2NM	9703-1839	9KHz-30MHz	June 18,2013	June 17,2014
RF Cable-CON	UTIFLEX	3102-26886-4	CB049	9KHz-30MHz	June 18,2013	June 17,2014
ISN	SCHAFFNER	ISN ST08	21653	9KHz-30MHz	June 18,2013	June 17,2014
3m Semi Anechoic Chamber	SIDT FRANKONIA	SAC-3M	03CH03-HY	30M-1GHz 3m	June 18,2013	June 17,2014
Amplifier	SCHAFFNER	COA9231A	18667	9kHz-2GHz	June 18,2013	June 17,2014
Amplifier	Agilent	8449B	3008A02120	1GHz-26.5GHz	July 16,2013	July 15,2014
Amplifier	MITEQ	AMF-6F-260400	9121372	26.5GHz-40GHz	July 16,2013	July 15,2014
Spectrum Analyzer	Agilent	E4407B	MY41440292	9k-26.5GHz	July 16,2013	July 15,2014
Loop Antenna	R&S	HFH2-Z2	860004/001	9k-30MHz	June 18,2013	June 17,2014
By-log Antenna	SCHWARZBECK	VULB9163	9163-470	30MHz-1GHz	June 10,2013	June 09,2014
Horn Antenna	EMCO	3115	6741	1GHz-18GHz	June 10,2013	June 09,2014
Horn Antenna	SCHWARZBECK	BBHA9170	BBHA9170154	15GHz-40GHz	June 10,2013	June 09,2014
RF Cable-R03m	Jye Bao	RG142	CB021	30MHz-1GHz	June 18,2013	June 17,2014
RF Cable-HIGH	SUHNER	SUCOFLEX 106	03CH03-HY	1GHz-40GHz	June 18,2013	June 17,2014
Spectrum Meter	R&S	FSP 30	100023	9kHz-30GHz	July 16,2013	July 15,2014
Power Meter	R&S	NRVS	100444	DC-40GHz	June 18,2013	June 17,2014
Power Sensor	R&S	NRV-Z51	100458	DC-30GHz	June 18,2013	June 17,2014
Power Sensor	R&S	NRV-Z32	10057	30MHz-6GHz	June 18,2013	June 17,2014
AC Power Source	HPC	HPA-500E	HPA-9100024	AC 0~300V	June 18,2013	June 17,2014
DC power Soure	GW	GPC-6030D	C671845	DC 1V-60V	June 18,2013	June 17,2014
Temp. and Humidigy	Giant Force	GTH-225-20-S	MAB0103-00	N/A	June 18,2013	June 17,2014
RF CABLE-1m	JYE Bao	RG142	CB034-1m	20MHz-7GHz	June 18,2013	June 17,2014
RF CABLE-2m	JYE Bao	RG142	CB)35-2m	20MHz-1GHz	June 18,2013	June 17,2014
Vector signal Generator	R&S	SMU200A	102098	100kHz~6GHz	June 18,2013	June 17,2014
Signal Generator	R&S	SMR40	10016	10MHz~40GHz	July 16,2013	July 15,2014
Universal Radio Communication	R&S	CMU200	112012	N/A	July 18,2013	July 17,2014

Note: All equipment through GRGT EST calibration

7. MANUFACTURER/ APPROVAL HOLDER DECLARATION

The following series model(s):

--	--	--	--
----	----	----	----

Belong to the tested device:

Product description : Color-Glo HD AiO Swiper

Model name : SWR-001

Remark: No additional models were tested.

-----THE END OF REPORT-----