

**Operation Manual
for
THE NTG-420 SOLID STATE
TRANSMITTER-RECEIVER**

Document No.7ZPRR0002

APR 2016



Revision Hsitory

Revision	Description	Issued

TABLE OF CONTENTS

SAFETY INFORMATION	4
1. Overview	10
2. Operation	11
2.1 How to start the system	11
2.2 How stop the System	13
2.3 Radar Control Module (N_Cont. exe) Main Window	13
2.4 Solid State Radar Signal Input Module(N_Solid.exe)	22
2.4.1 Icon	22
2.4.2 Start-up the Screen	23
2.4.3 Main Menu	23
2.4.3.1 File	23
2.4.3.2 View	24
2.4.3.3 Help	24
2.4.4 Tree Menu and Functional Description	25
2.4.4.1 Radar Image	26
2.4.4.2 Input Image	37
2.4.4.3 Failure history	43
2.4.4.4 Simulation	43
2.4.4.5 Sweep Tag	44
2.5.5 Admin Menu	47
2.5.5.1 Radar Image	47
2.5.5.2 On Error Reboot	48
2.5.5.3 Admin Password	48
2.5.5.4 Process	48
2.5.5.5 Common Memory	49
2.5.5.6. Debug	49
2.6 Startup parameter	49
3. Specification	50
FCC Caution	52
IC (Indutry Canada)	52

SAFETY INFORMATION

To prevent harm to those who use this product or other people and damages to property, safety precautions to be followed are described as follows.

- ★ The degrees of harm and damages caused by misuse with neglecting indications are classified and described as follows.



DANGER

This indication means "Hazard can cause severe injury or



WARNING

This indication means "Hazard can cause injury or only physical damages."

- ★ Kinds of precautions to be followed are classified and described with the following icons. (A few examples of icons are as follows.)



This icon is to call attentions.



This icon is to prohibit some actions



This icon is to force some actions.



DANGER

Plug in completely



Incomplete plugging may generate heat to cause a shock or a fire.

In case of malfunctions or abnormal conditions (smoke, foul odor, sound, etc.), turn the power off and turn off the breaker of the power distributor.



Turn the power off and consult with our company. Do not repair the device by yourself because it is dangerous.

Unplug

Do not put the device on unstable places(a shaky stand, tilted place, etc.).



Dropping or falling down of the device may cause injury.

Prohibition

Do not wet or water the device.



Wetting the device may cause a shock or a fire.

Do not wet

Do not put things (containers with liquid, flower pots, etc.) or creatures on the device.



Entering of liquid or excrement may cause a shock or a fire.

Prohibition

- ★ In case of entering, unplug from the outlet and consult with our company.

Do not put liquid such as water, metals or inflammable objects inside the device.



Entering may cause a shock or a fire.

Prohibition

- In case of entering, unplug from the outlet and consult with our company.

	DANGER
---	---------------

Do not drop or bump the device.

 Physical shock may cause a shock or a fire.

Prohibition

Do not use the device under a voltage other than the indicated power-supply voltage.

 Malfunction may occur to cause a shock or a fire.

Prohibition

Do not remove the back lid, the cabinet or the cover, or do not modify the device.

 Consult with our company for internal inspection and repair.

Do not decompose

When thunder has started, do not touch the power cables, the signal cables and the device.

 Touching will cause a shock

Do not touch

Do not damage the power cord or the plug.

 Damaging, processing, loading, heating, bending and twisting forcedly or pulling may deteriorate insulation of coating, expose cores or break the cord to cause a shock or a fire.

Prohibition

★ In the case of damages, unplug from the outlet and ask our company

 **WARNINGS**

Carry the CRT monitor by more than one person since the monitor is heavy.

 Stumbling, etc. may cause injury.

Disconnect the plug and the connection lines when moving the device.

 Damage of cords may cause a shock or a fire.

Unplug

Unplug with holding the plug.

 Damage of cords may cause a shock or a fire.

Unplug

Unplug from the outlet for safety when maintaining

 A shock may be caused.

Unplug

 **WARNINGS**

Do not unplug with wet hands

 A shock may be caused.

Prohibition

Do not block the ventilation holes of the cabinet.

 Heating up internally may cause malfunction or a fire. Pay attention to the following:

Prohibition

★Do not turn over, lay down or set upside down the device

Do not put the device where much moisture or dust exists, and greasy fumes or steam is generated.

 Putting the device on a cooking table or near a heater may cause a shock or a fire.

Prohibition

Ask our company for internal inspection and cleaning periodically.

 Without cleaning for a long time, dust gathered inside the device may cause malfunction or a fire.

Unplug from the outlet when not using for a long time.

 Dust gathered on the plug may cause a fire or a shock.

Unplug

CAUTIONS

Do not put other devices (a TV, a display device, etc.) or magnetized objects near the CRT monitor. Installing the CRT monitor near those may have an effect on the screen (disturbing colors or swaying the screen).

★ Move the device seemed to effect away as possible. In case the phenomenon does not stop even so.

Ground the earth wire of the plug.



A shock may be caused without grounding the earth wire.

Furthermore, poor reception for TV's, radios, etc. may

Do not put the device in direct sunshine or in the heat of heating apparatus.

Heat may cause deformation of the cabinet or malfunction of parts.

Do not use the device in a dark place at close range for a long time. Using the device in a dark place at close range for long time may weary eyes or weaken eyesight.

★ Use the device at a distance of 40 or 50 cm in a bright place where newspaper can read easily. Take a rest for eyes every 30 minutes.

Do not contact the cabinet with rubber or plastic products for a long time.

The quality of the cabinet may alter or the coating may come off.

1. Overview

This manual describes operation function of the NTG-420 Solid State Transmitter-Receiver that is used for the land based radar surveillance system.

Figure-1.1 shows total system illustration diagram of the NTG-420 and peripheral equipments. And Figure-1.2 shows functional data flow of the NTG-420.

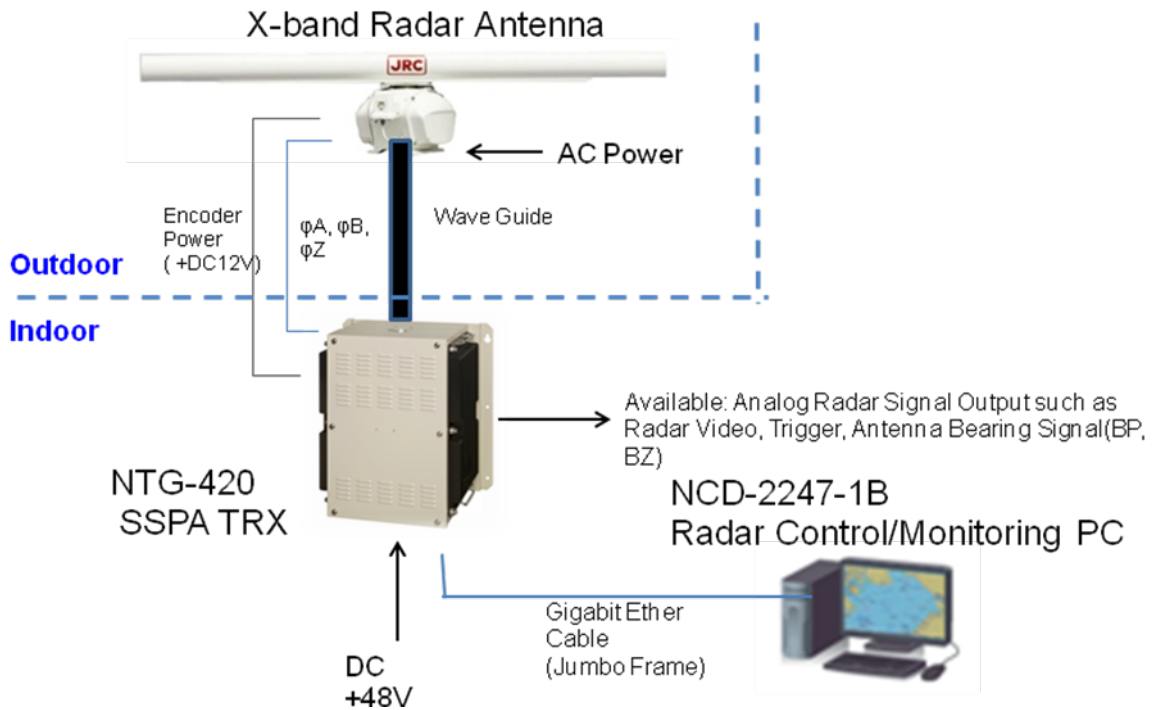

Figure-1.1 Total System Illustration Diagram of the Radar System.

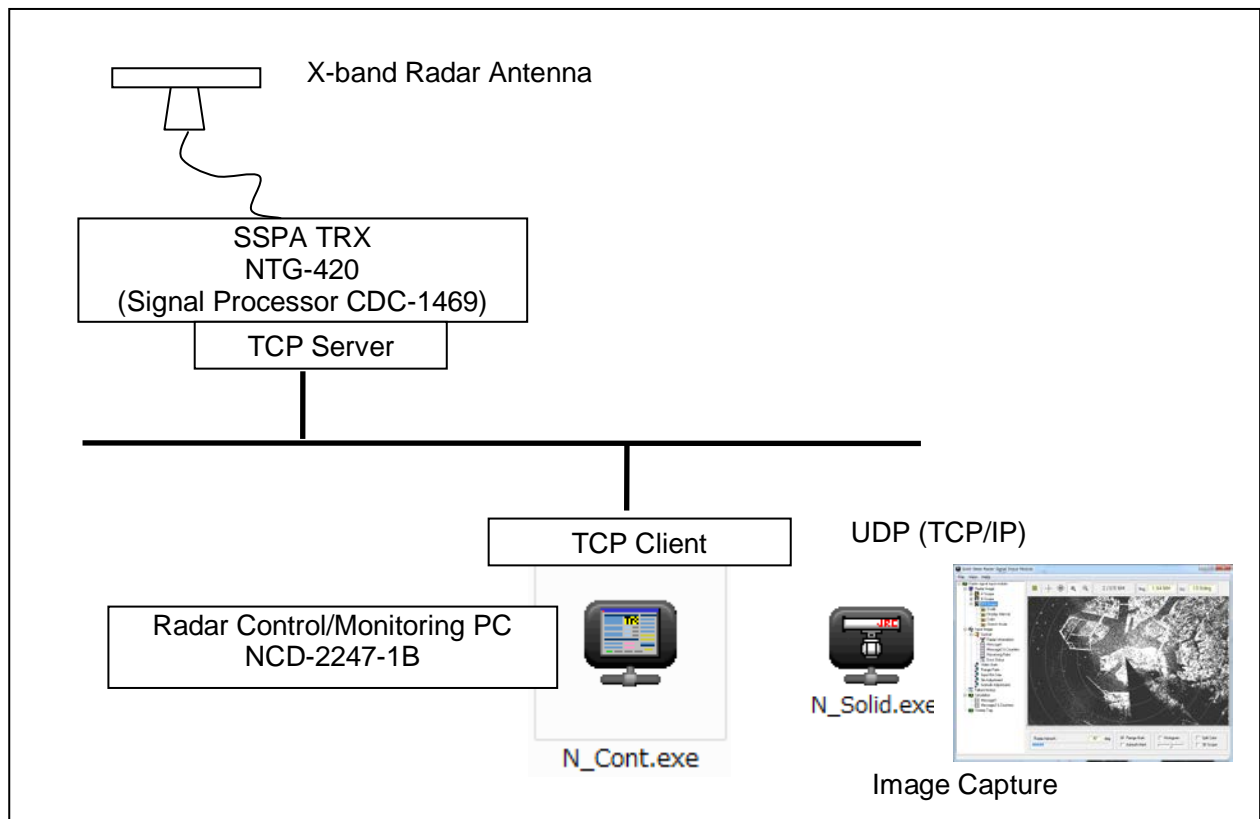
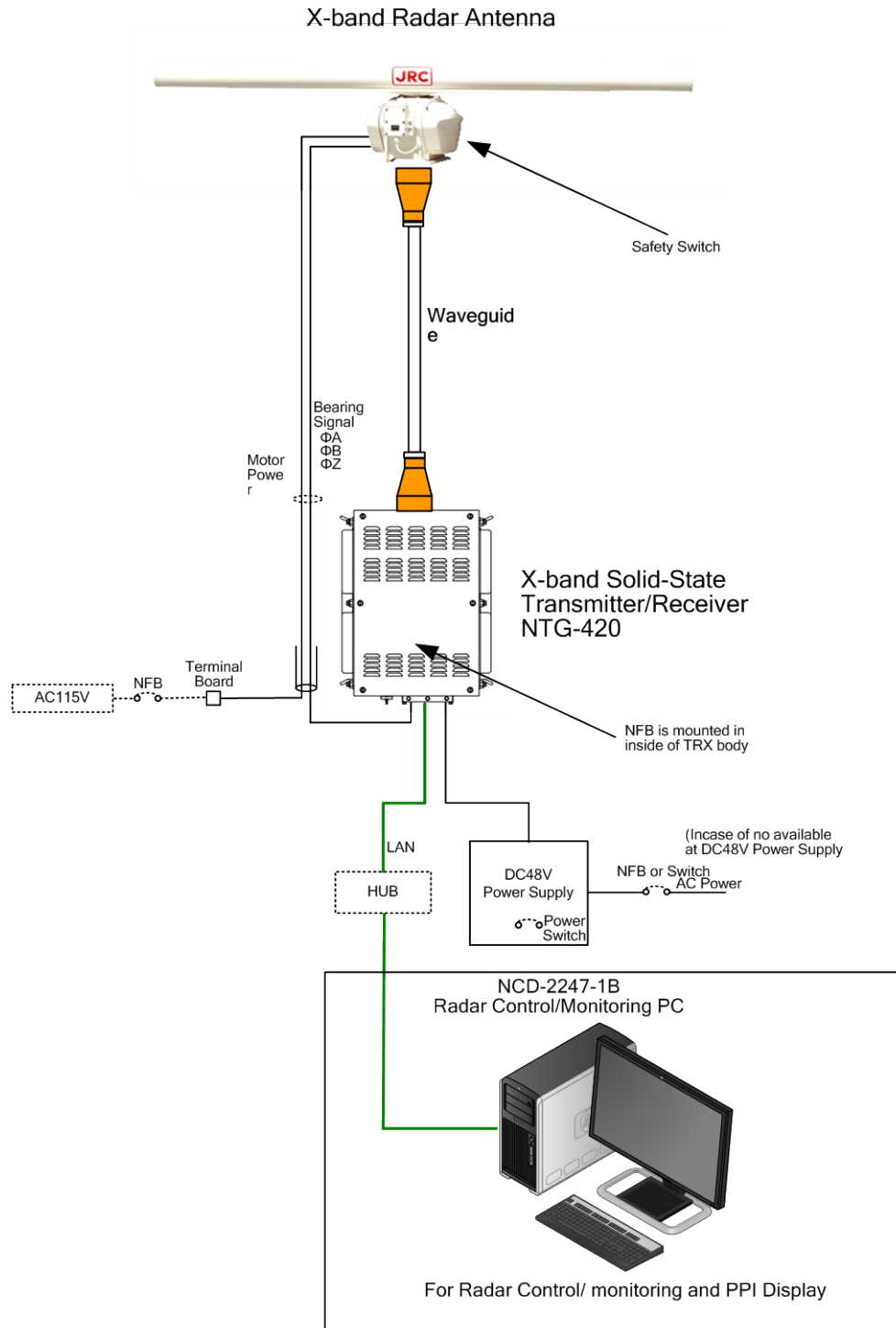

Fig. 1.2 Functional Data flow of the Radar System

2. Operation

2.1 How to start the system

- 1) Turn on the DC48V Power Supply by it's switch or attached NFB.



- 2) Turn on the power switch on the NCD-2247-1B
- 3) Open the main menu Window (CDC-1469 control module by LAN (NMEA).
See paragraph 2.3
- 4) Confirm the no error indication on main menu.
- 5) Turn on Antenna motor NFB. **(Before turn on, It checks that there are no people near the antenna.**
- 6) Click the Transmit ON button on the main menu
- 7) Echo will appear on the "Solid State radar Signal Input Module window". See paragraph 2.4

2.2 How stop the System.

- 1) Stop the system by reverse procedure of the how to start.

2.3 Radar Control Module (N_Cont. exe) Main Window

The following indication will be displayed when NTG-420 and NCD-2247-1B are connected normally.

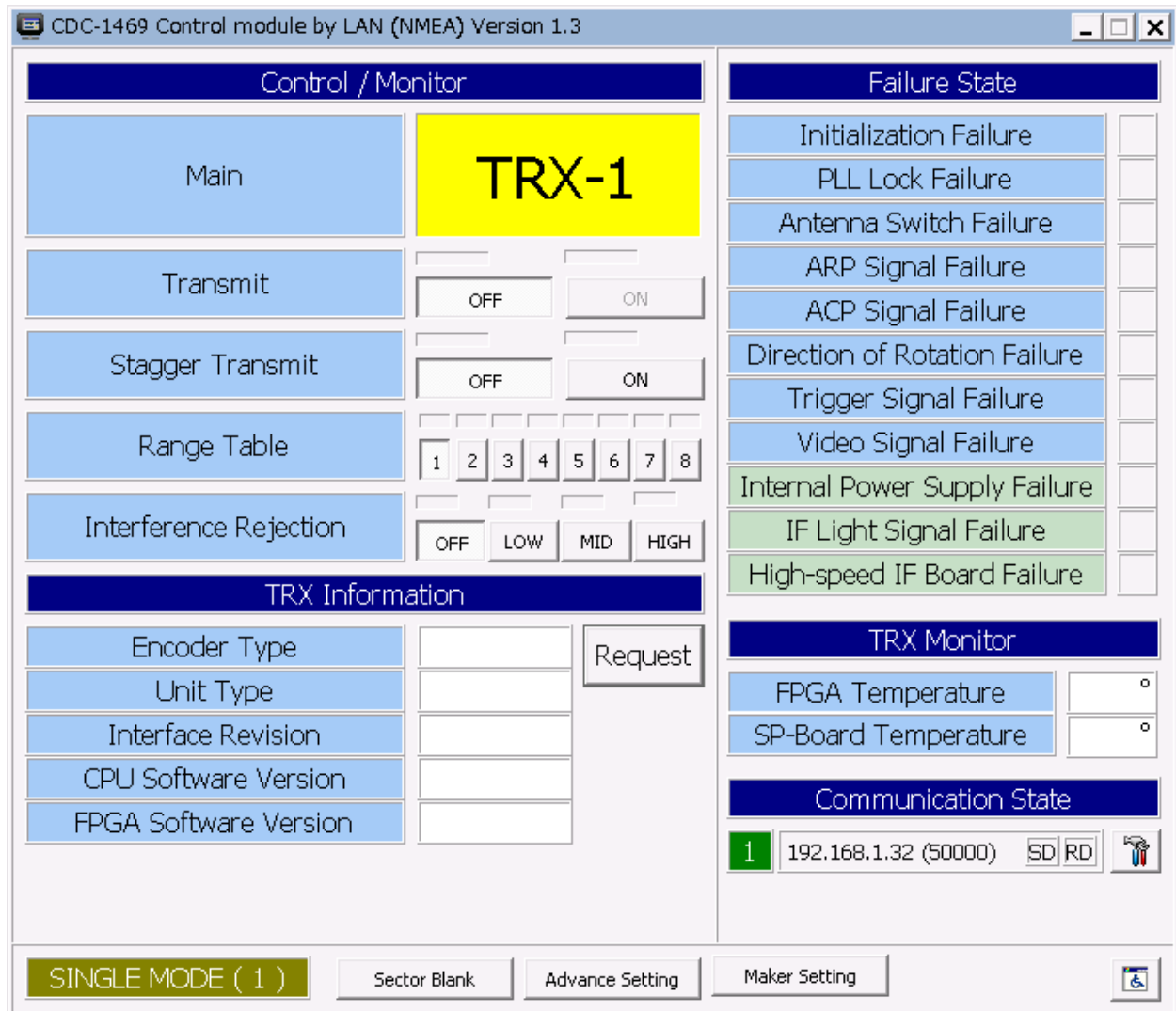

SIGNAL MODE(1) window menu

Control/Monitor

Main :TRX-1 displayed

Transmit : OFF: Transition turned off, ON: Transmission turned on

Stagger Transmit : OFF: Stagger Transition turned off, ON: Stagger Transmission turned on

Range Table : Selects Range Table shown as table below.

Table No.	No.1. Transmit		No.2 Transmit		PRF (Hz)	Tm1 (us)
	PW(us)	FM(MHz)	PW(us)	FM(MHz)		
1	0.07	0	2.8	30	2280	97.52
2	0.15	0	4.6	30	2280	97.52
3	0.3	0	9.1	20	2280	97.52
4	0.15	0	18.3	30	1280	97.52
5	0.15	0	28.0	30	640	97.52
6	0.3	0	9.1	30	1864	97.52
7	0.6	0	9.1	30	1280	97.52
8	0.07	0	2.8	30	4100	97.52

Remarks;

PW: Pulse Width, FM: Frequency Modulation range,

PRF: Pulse Repetition Frequency,

TM1: Time interval between No.1 and No.2 transmission

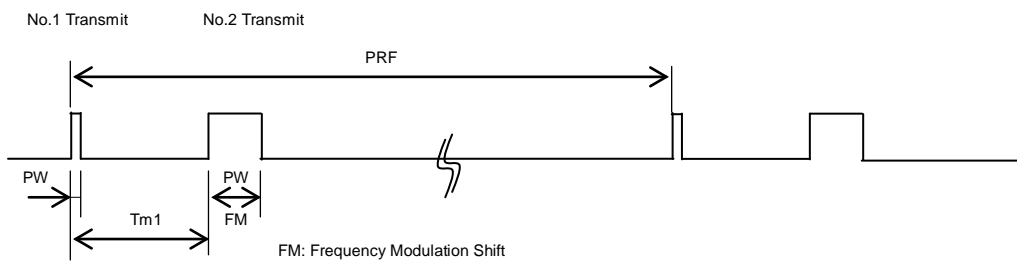

Interference Rejection: Adjusts the interference rejection strength level
Off / Low / Middle / High

TRX Information

- Encoder Type** : 2048 (Encoder pulse numbers)
- Unit Type** : CDC-1469 (Signal Processor Model)
- Interface Revision** : 00
- CPU Software Version** : 0000
- FPGA Software Version** : 0000

Request : Updated when click this button

Failure State

- Initialization Failure** : FPGA initialization failure.
- PLL Lock Failure** : PLL lock failure on the master clock of signal processor.
- Antenna Switch Failure** : Antenna Safety Switch turned ON.
- ARP Signal Failure** : Lacked the Antenna encoder reference pulse.
- ACP Signal Failure** : Lacked the Antenna encoder pulse.
- Direction of Rotation Failure** : Antenna is reverse rotation.
- Trigger Signal Failure** : Lacked the Radar trigger signal.
- Video Signal Failure** : Lacked the radar video signal during specified period.
- Internal Power Supply Failure** : TRX internal power supply became abnormal condition. TRX.

IF Light Signal Failure : IF Optical Fiber signal Lost.

High-speed IF Board Failure : AVAL Optical Board is Failure.

TRX Monitor

FPGA Temperature : xxx° shows temperature

SP-Board Temperature : xxx° shows temperature

Communication State

1 192.168.1.32(50000) SD RD : Green :Normal condition, Red :Abnormal(See below)

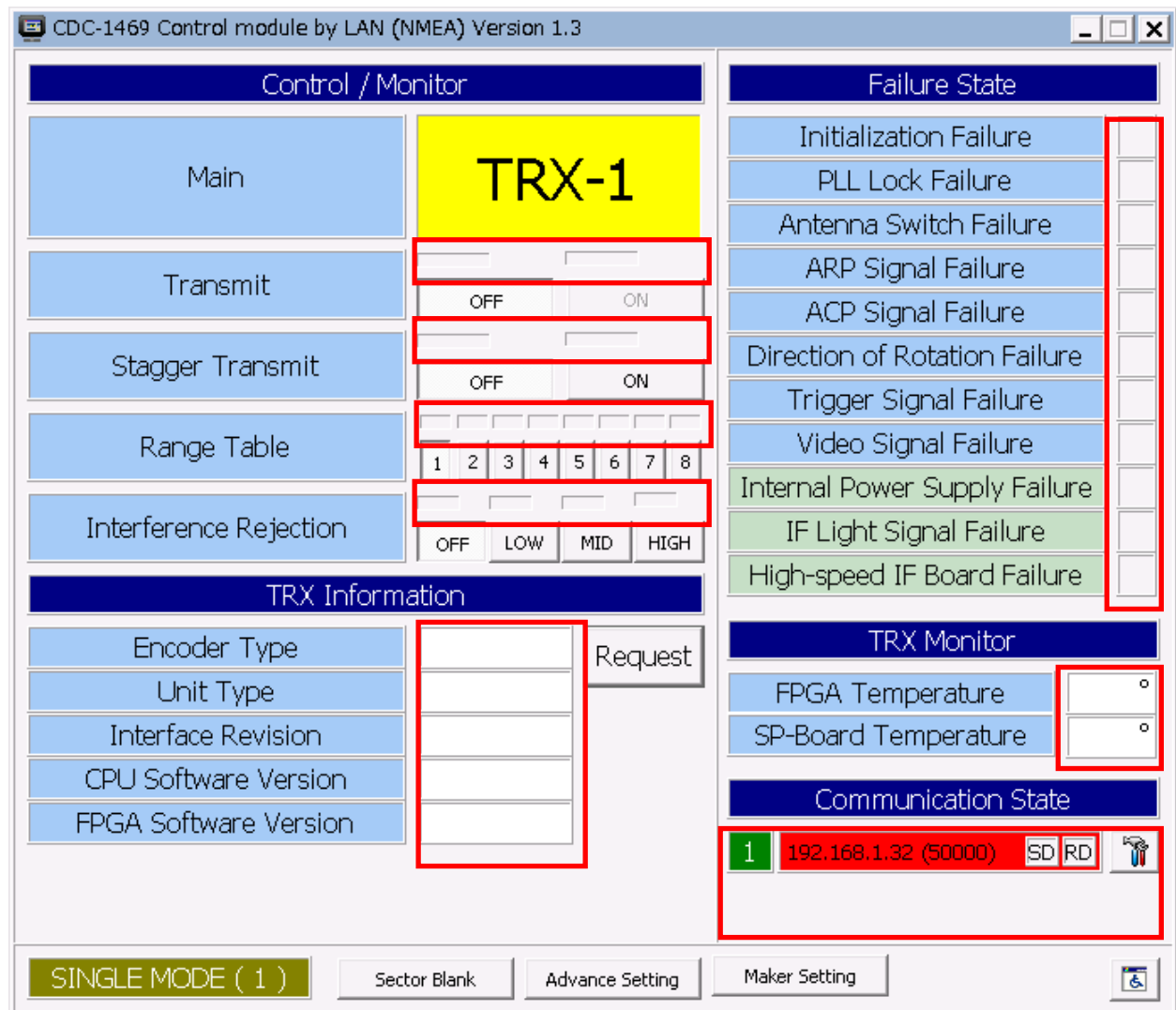

Sector Blank window menu

Transmission Sector blanking angle can be presentable.

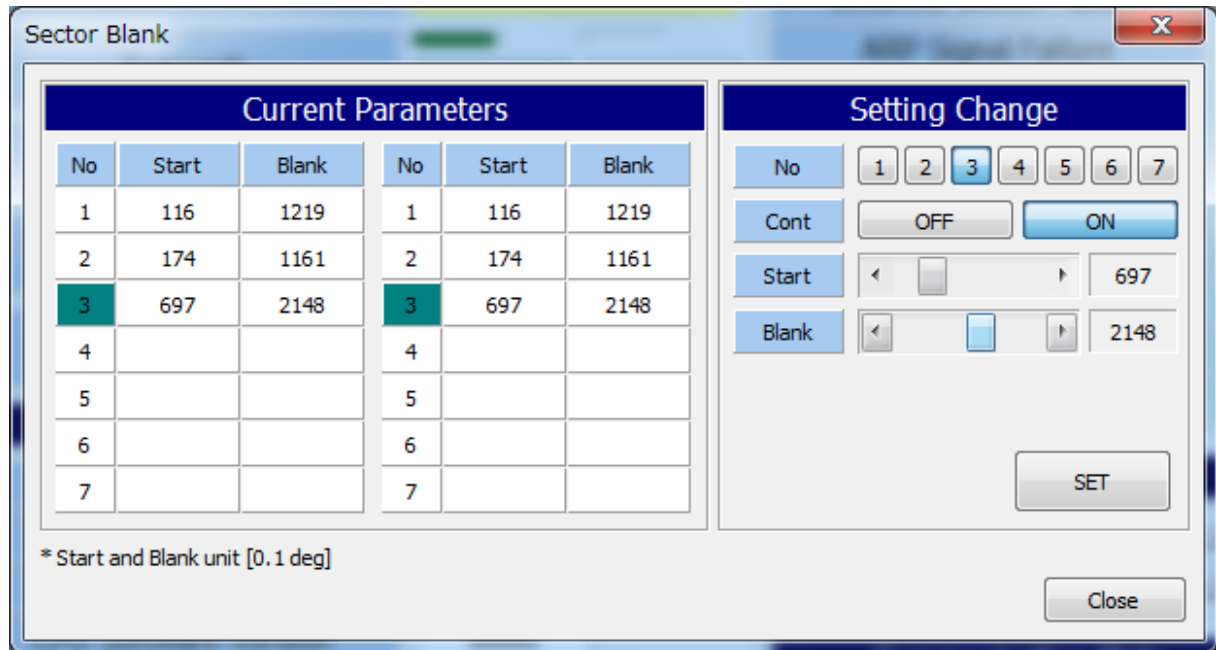

This radar system has 7(seven) sector blanking area which are presentable individually.

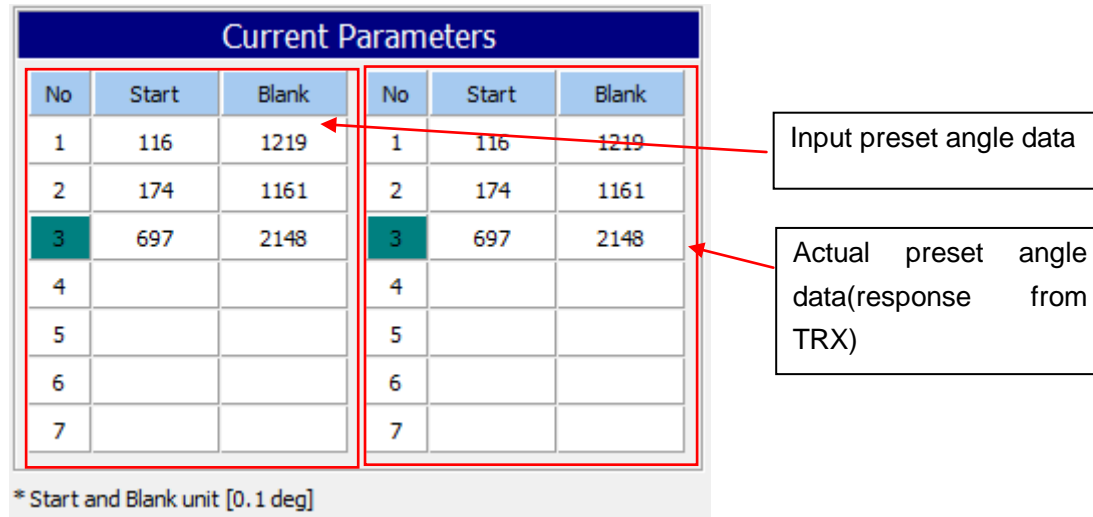

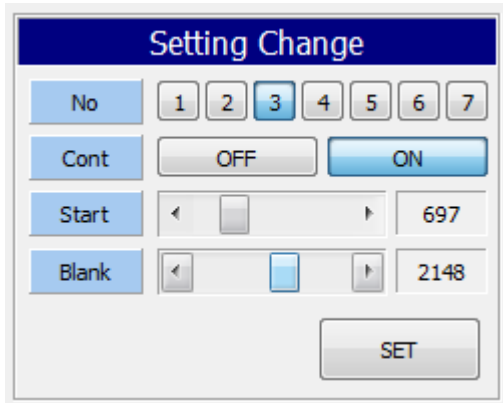

The blanking data of an input is reflected by pushing a **SET** button.

Advanced Setting window menu

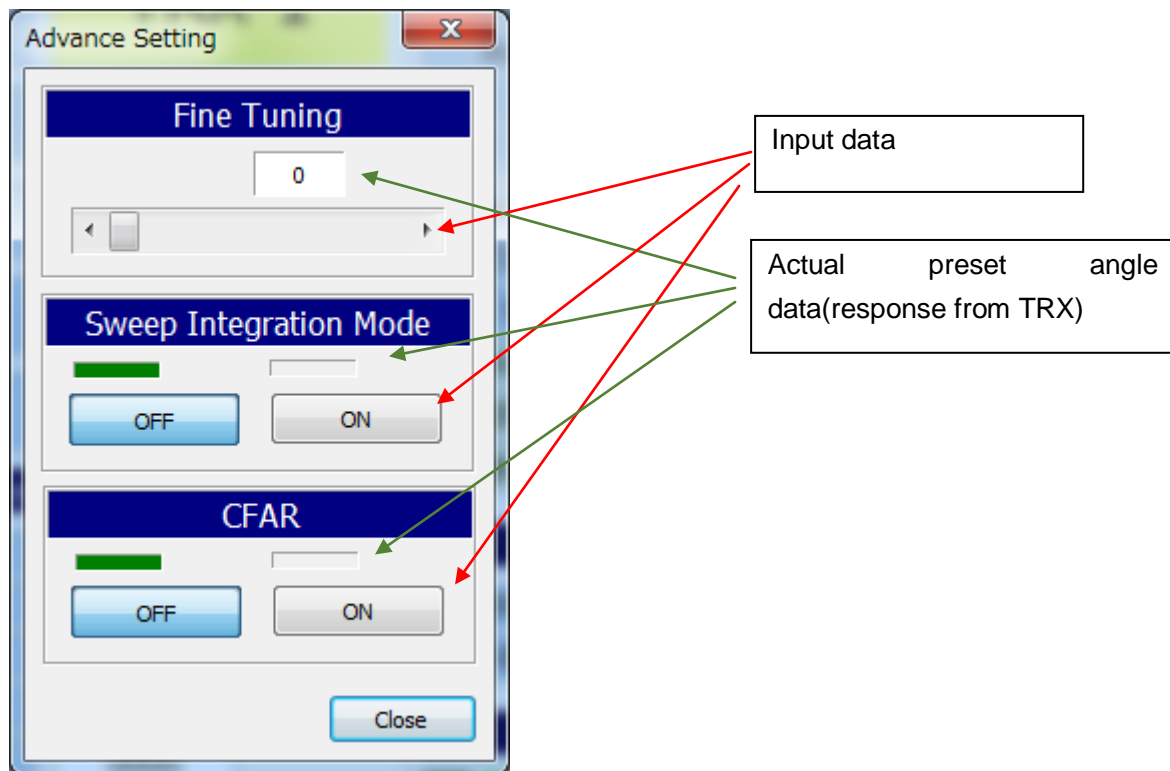

Fine Tuning : Reserved Function.

Sweep Integration Mode : ON or OFF (Reduce the Noise and Clutter echo)

CFAR : ON or OFF (Constant False Alarm Rate)

Maker Setting window menu

This menu is presented by manufacture's factory, so that please do not change recklessly..

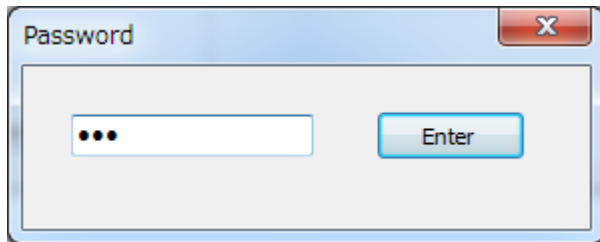

A password input is required when open the maker setting window.
Initial password is "admin".

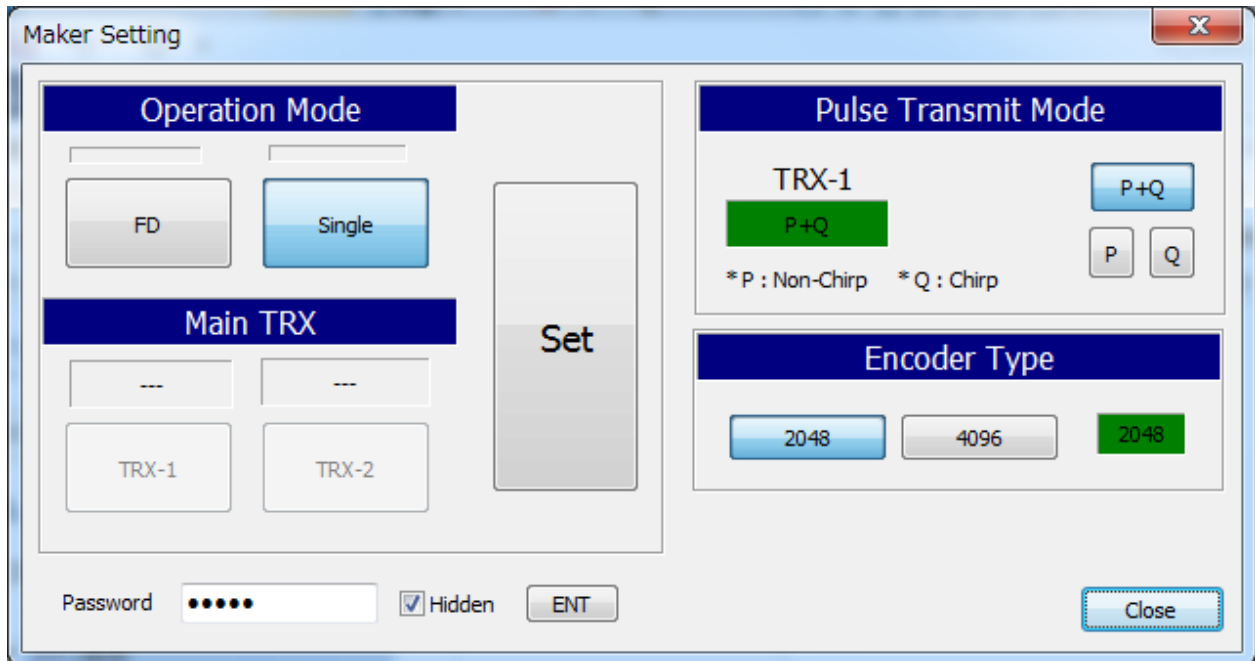

Setting of Password

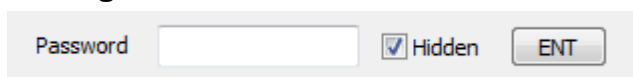

Hidden The mask of the inputted password is canceled temporarily.

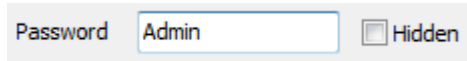
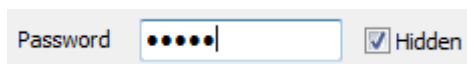

Click the ENT button and password will be memorized.

- * When a blank is set up, attestation with a password is not carried out.
- * It is enciphered and the inputted password is saved at an initialization file.

Operation Mode

FD : Not used

This system can be used only

Main TRX

Not used in this system.

Pulse Transmit Mode (Default is P+Q)

TRX-1 : P+Q (Indicate current transmission mode)

P+Q : Select Both P(non-chirp) and Q(chirp) transmission pulse

P : Select P pulse only

Q : Select Q pulse only

Encoder Type

2048 : Select antenna encoder 2048 pulse type

4096 : Select antenna encoder 4096 pulse type

2048 Green indication (Indicate current selected encoder type)

Communication Preset Window

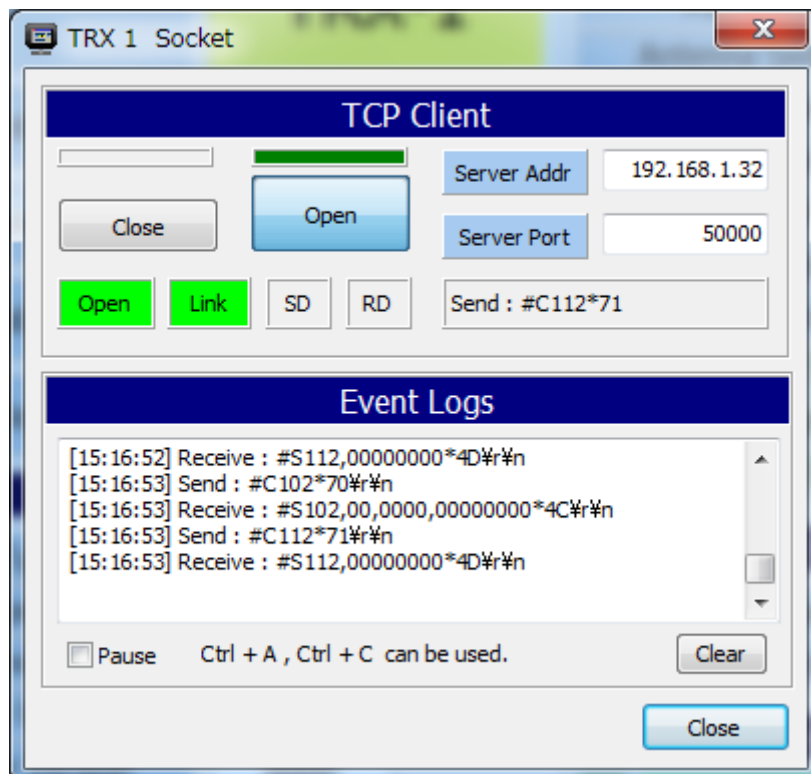

TCP Client



Open/Close a socket

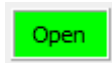

Socket open state



Socket connection state



Flashing at sending and receiving



Server IP address

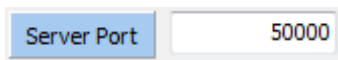

Server port number

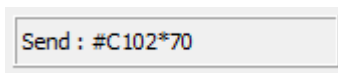

Indicate the communication event

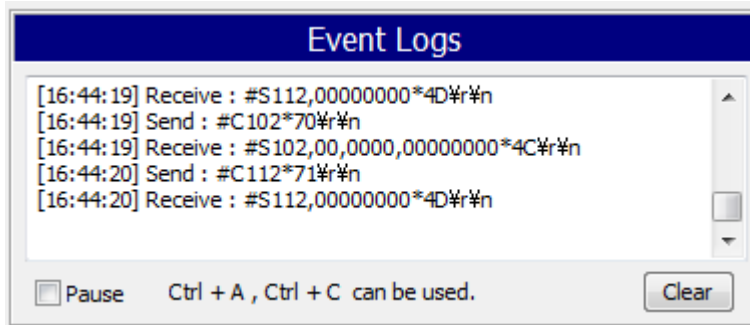

Communication Event Log indication

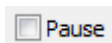

Update of the log of a communication event is stopped.

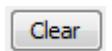

The log of a communication event is cleared.

※ If you want to save the contents that are displayed in the file, copy it to the clipboard using such as Ctrl + A and Ctrl + C, please save the file using Memo-pad etc.

History of Failures Log Window indication

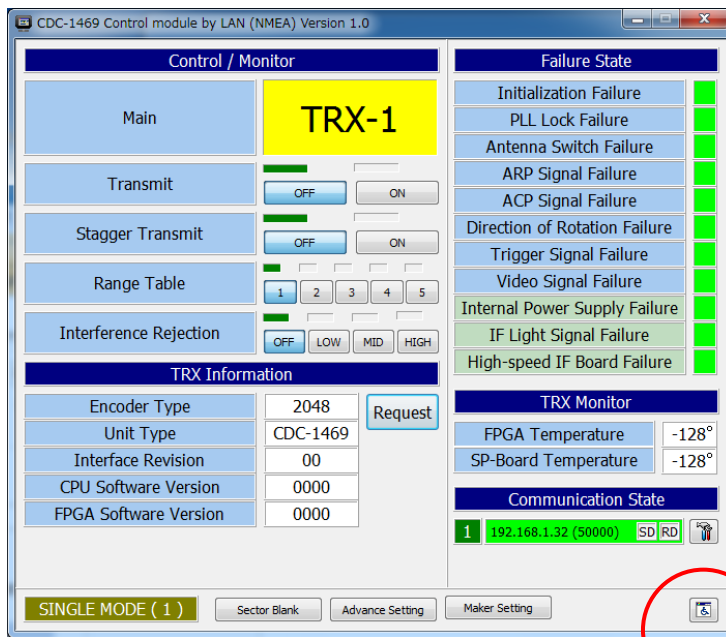

Click the here

The history of failure window displayed.

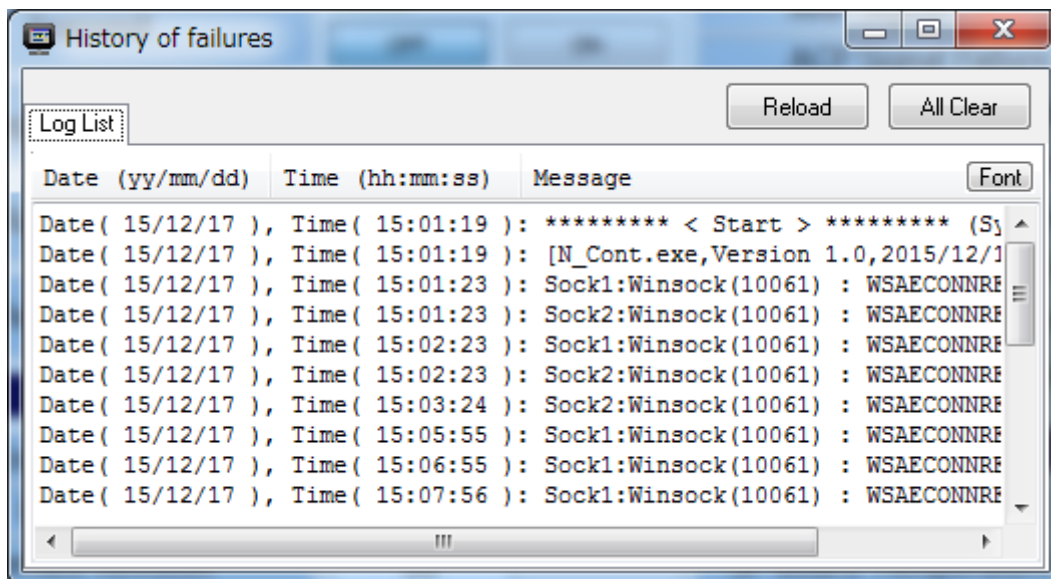

2.4 Solid State Radar Signal Input Module(N_Solid.exe)

This module captures in a radar picture using an UDP socket (TCP/IP) from a solid-state TRX signal processing circuit (CDC-1469). The captured radar picture is provided through a shared memory to other applications. Also, Radar PPI image can be monitored using this module.

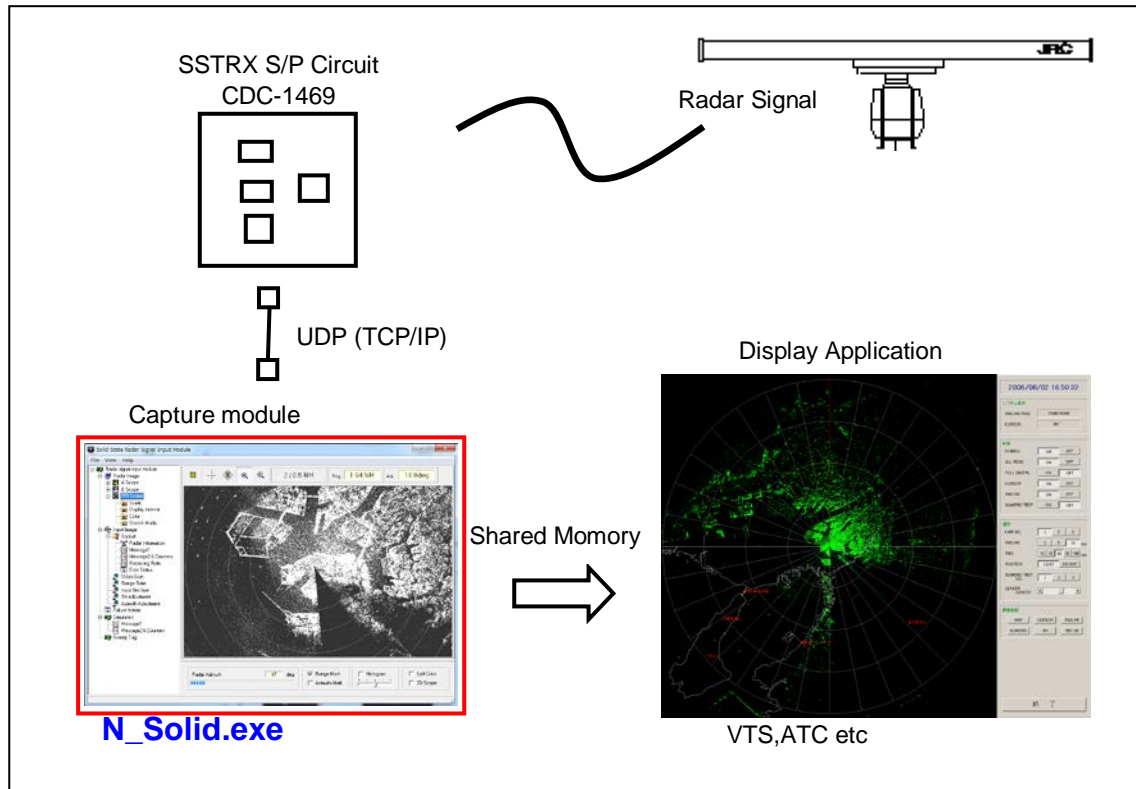

2.4.1 Icon



2.4.2 Start-up the Screen

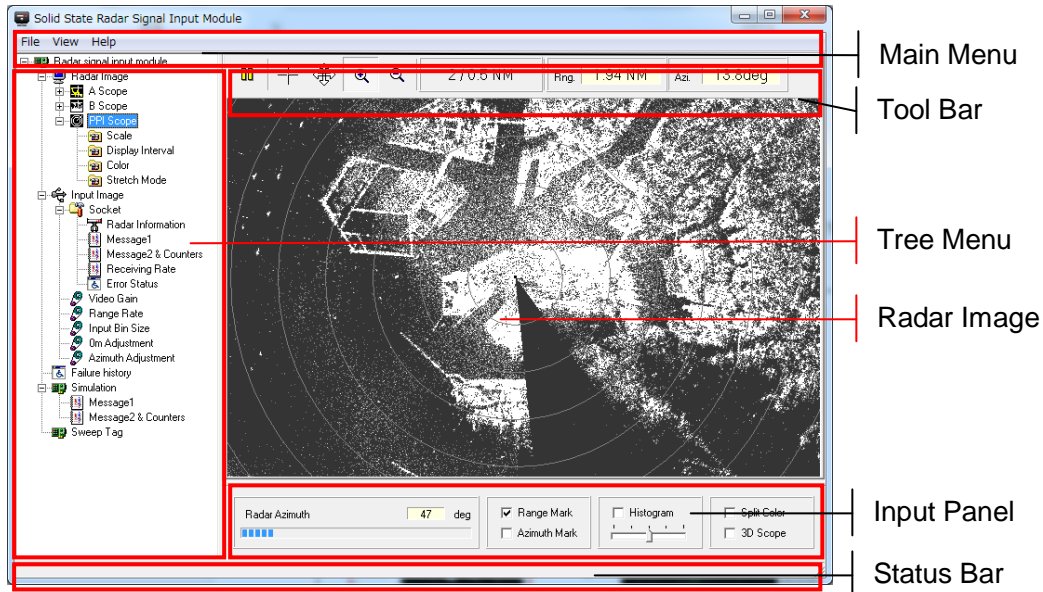

2.4.3 Main Menu

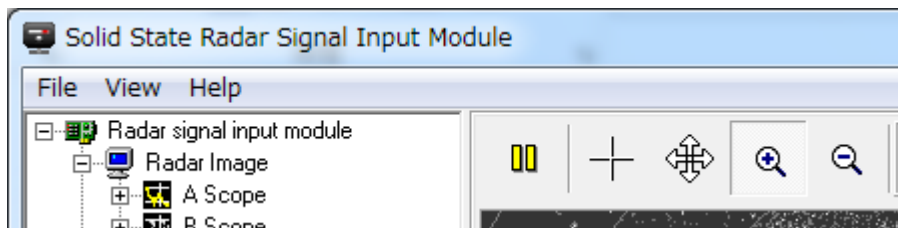

2.4.3.1 File

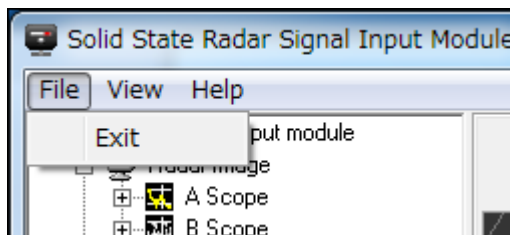

(1) Exit

Exit the Application

Note: When this application is started according to the launcher process (Stater2.exe) of exclusive use, a window is closed and it operates in the background.

2.4.3.2 View

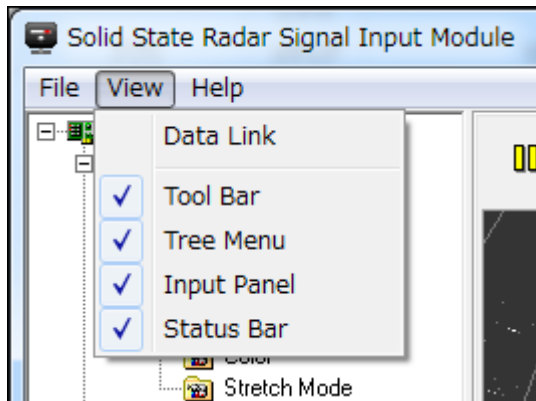

Data Link : Display the Data Link Screen

Tool Bar : Display on/off of the tool bar

Tree Menu : Display on/off of the tree menu

Input Panel : Display on/off the input panel

Status Bar : Display on/off of the status bar

(1) Data Link screen

Class	Group Name	Link Name	Status	Size	Type	Value	Notice
Listener	(no name)	bRemote	Enabled	1	bool	false	リモート制御 入/切 (true/false)
Slave	(no name)	wGAIN	Enabled	2	WORD	0x0000	利得制御 レベル (0~255)
Broadcast	(no name)	wAZIMUTH	Enabled	2	WORD	0x0000	方位オフセット (0~0xffff)
Slave	(no name)	bGyroAdjust	Enabled	1	bool	false	Gyrolによる方位制御 入/切 (true/false)
Slave	(no name)	bGyroSmooth	Enabled	1	bool	false	Gyrolによる方位制御 方式 (trueでスムーズ制御)
Slave	(no name)	dGyroAzimuth	Enabled	8	double	0	Gyrolによる方位制御 船首方位(度)
Broadcast	(no name)	IsActivated	Enabled	1	bool	true	Is N_Solid.exe active ?

Other applications and the state of InterProcess communication are displayed.

2.4.3.3 Help

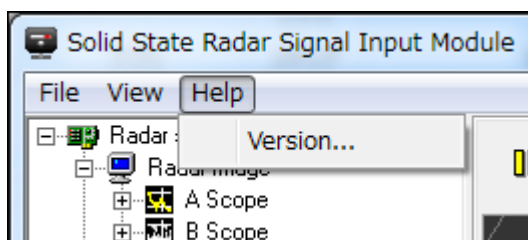

(1) Version

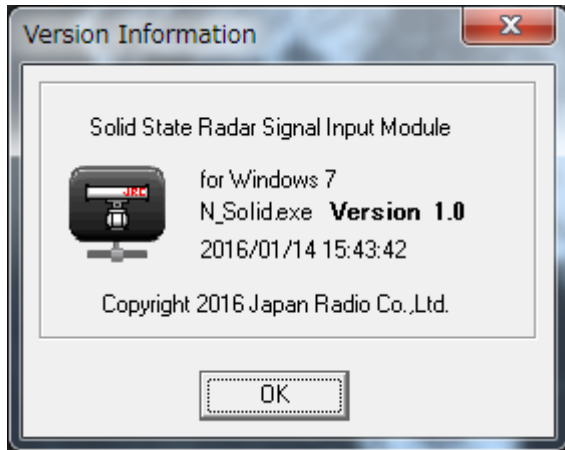

2.4.4 Tree Menu and Functional Description

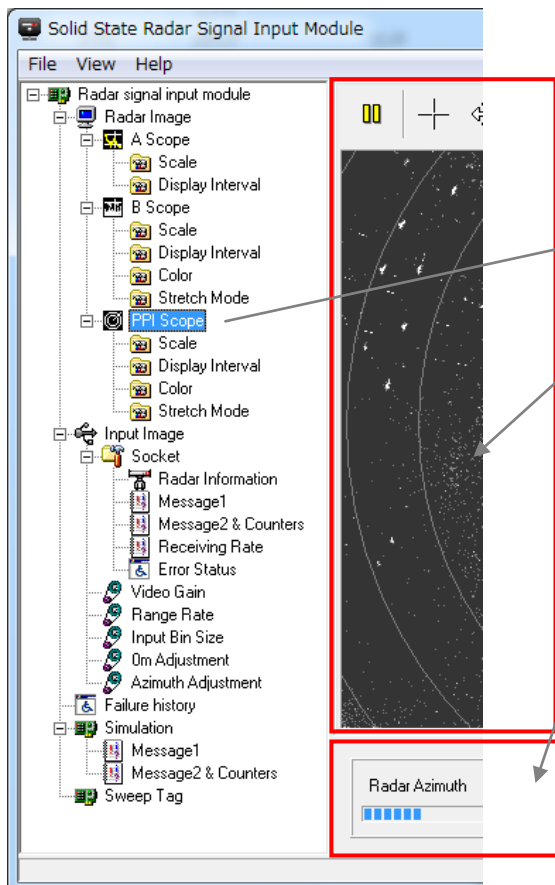



The picture and input panel relevant to the selected function name are

A function name is displayed in tree form. When a function name is selected, a related picture and a related input panel are displayed.

2.4.4.1 Radar Image

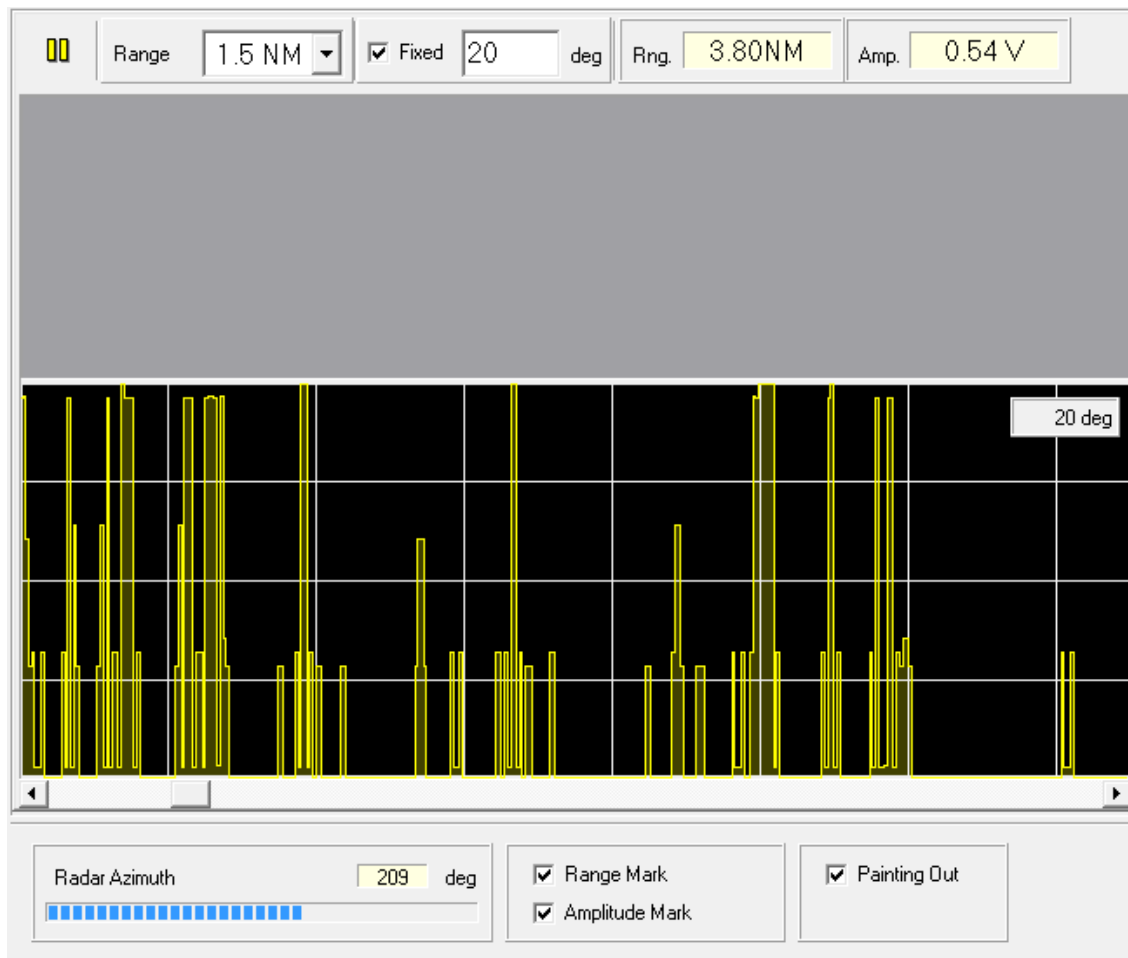
(1) A Scope



 : Image update is stopped when this switch turned ON.

Range: Selects radar display range.

0.5 NM, 0.75 NM, 1.5 NM, 3 NM, 6 NM, 12 NM, 24 NM, 48 NM, 96 NM, 192 NM,

Fixed: Fixed the display azimuth.

Rng.: Displays distance of cursor position.

Amp.: Displays echo level(amplitude) of the cursor position (reference value).

Input Panel

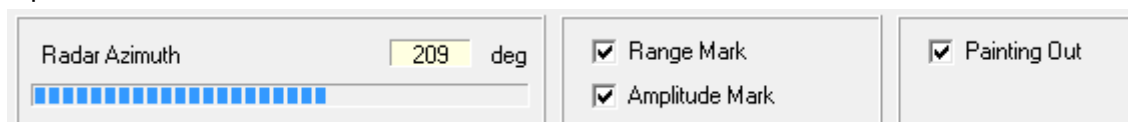

Radar Azimuth: Displays the radar antenna azimuth angle.

Range Mark: Selects display on/off of the Range Marker.

Amplitude Mark: Selects display on/off of the amplitude marker.

Paint Out: : Selects painting out on/off.

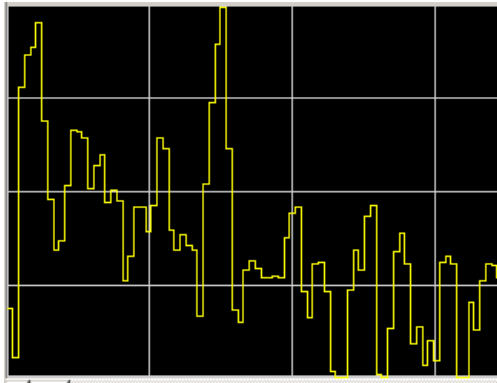

Painting out off

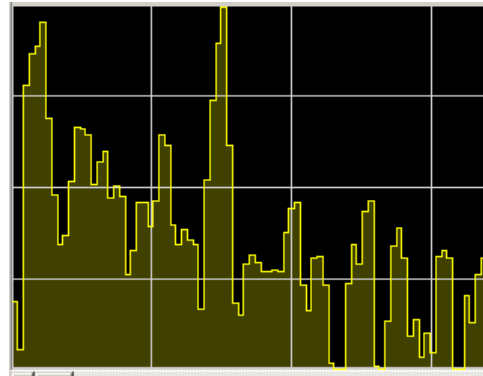

Painting out on

(Please select according to CPU load)

1) Scale

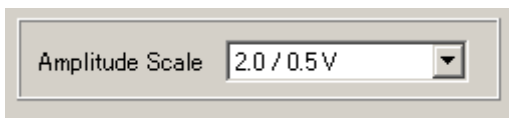

Amplitude Scale: Selects amplitude scale.(Scale/Marker Interval)

- 0.5 / 0.1 V
- 1.0 / 0.2 V
- 2.0 / 0.5 V
- 5.0 / 1.0 V

(Amplitude(level) is reference value).

2) Display Interval

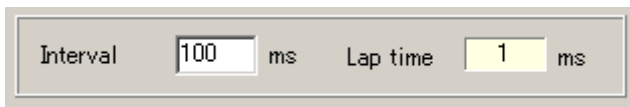

Interval: Presets the update interval of radar picture. (Preset range:10~1000mS)

Lap time: Displays the radar picture depiction lap time.

If an updating cycle is shortened, the load of CPU will increase.

(Please preset according to CPU load)

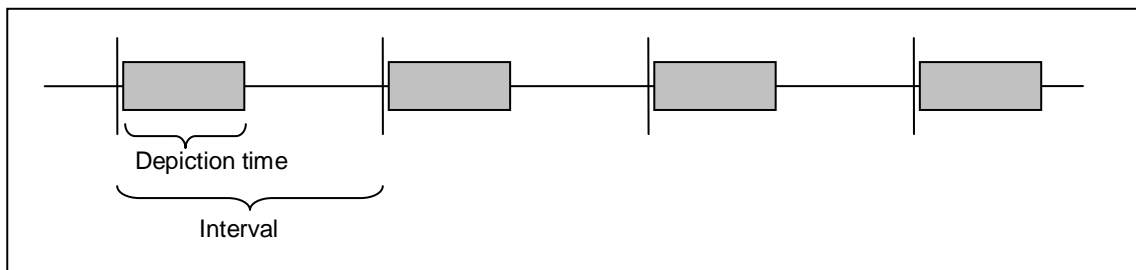

(2) B-Scope

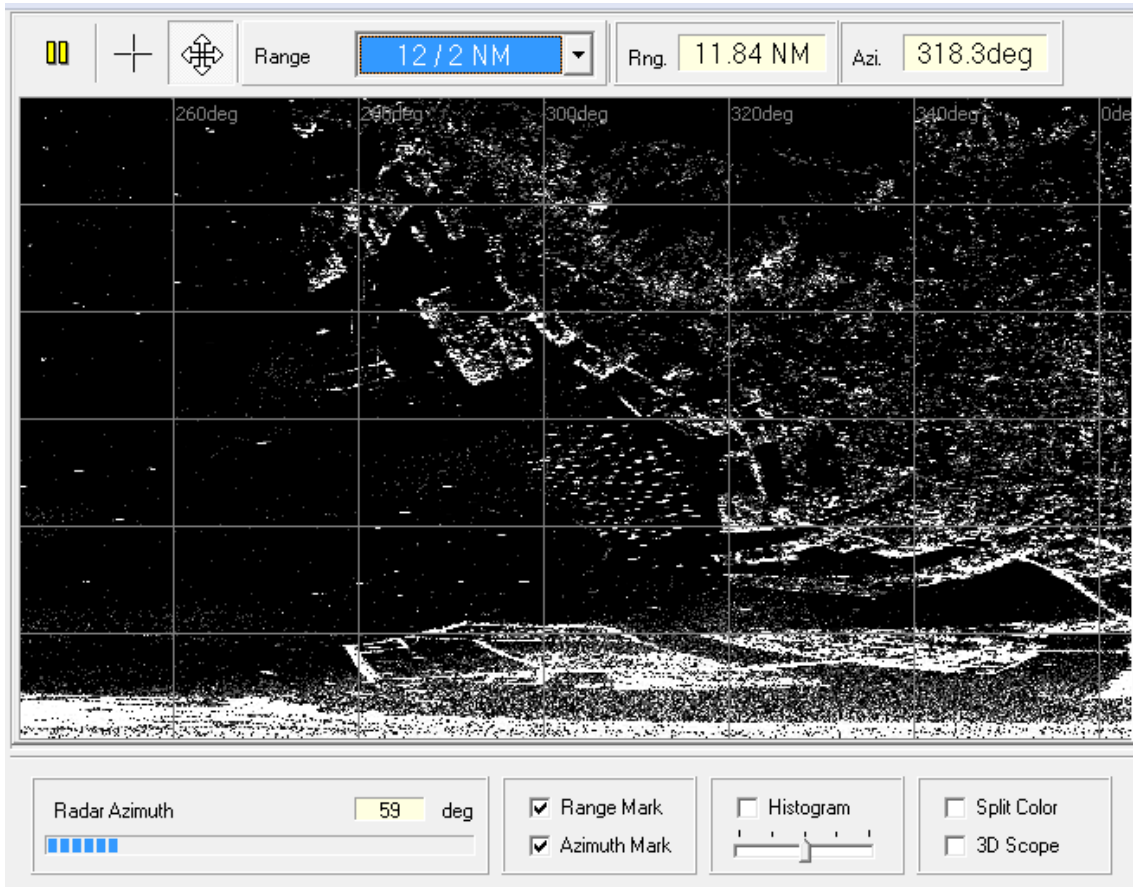

: Image update is stopped when this switch turned ON.



: Shows cursor position in the picture.



: Moves picture position.

Range: Selects radar display range.

Rng.: Displays distance of cursor position.

Azi.: Displays azimuth angle of cursor position.

Input Panel

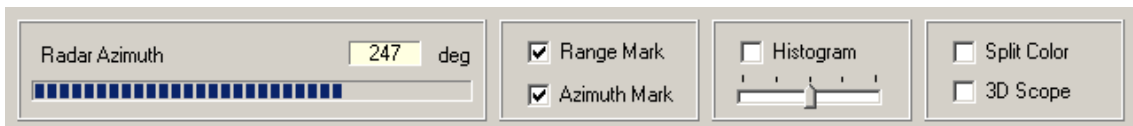

Radar Azimuth : Displays the radar antenna azimuth angle.

Range Mark : Selects display on/off of the Range Marker.

Azimuth Mark : Selects display on/off of the azimuth marker.

Histogram : Selects display on/off of the histogram.

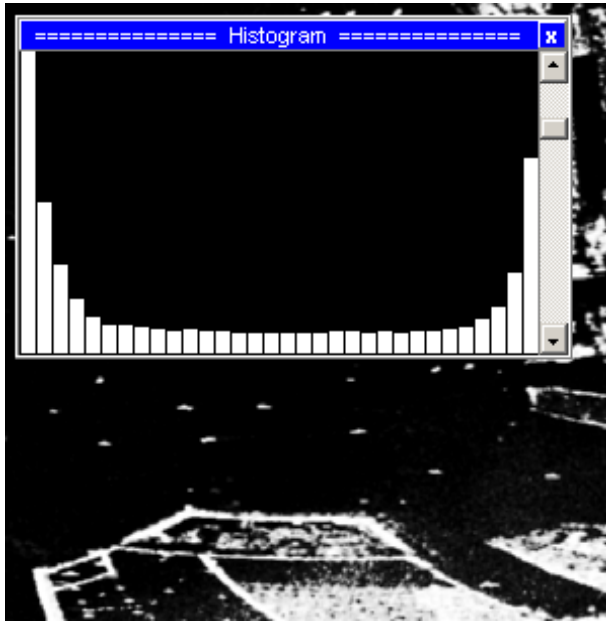

: Selects the histogram section width.

1 x 256, 4 x 64, 8 x 32, 16 x 16, 32 x 8

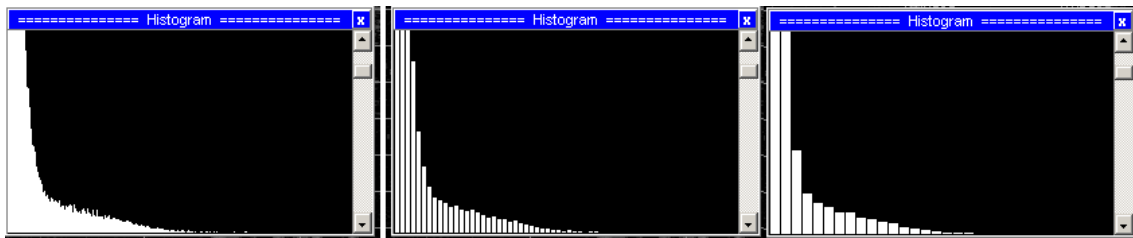

1 x 256

4 x 64

8 x 32

Split Color: Display on/off of the function to classify a radar picture by color to two gradation is changed.

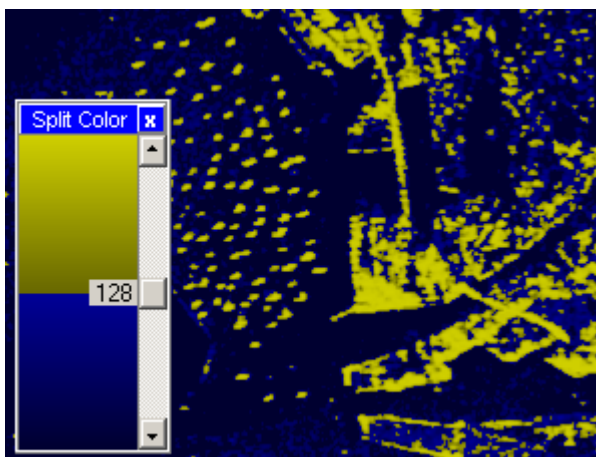

3D Scope : Selects the 3D display on/off.

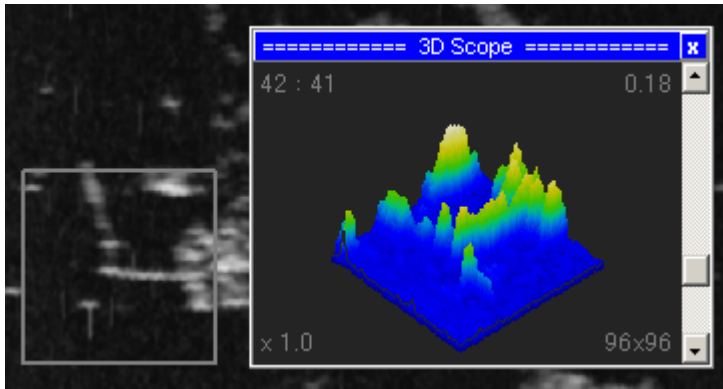

1) Scale

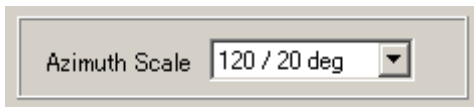

Azimuth Scale: Selects azimuth scale. (Scale/Marker interval)

- 30 / 5 deg
- 60 / 10 deg
- 90 / 15 deg
- 120 / 20 deg
- 180 / 30 deg
- 270 / 45 deg
- 360 / 60 deg

2) Display Interval

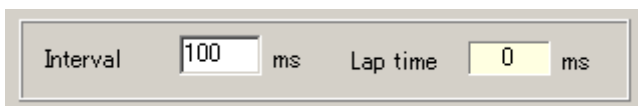

Interval: Presets the update interval of radar picture. (Preset range:10~1000mS)

Lap time: Displays the radar picture depiction lap time.

If an updating cycle is shortened, the load of CPU will increase.

(Please preset according to CPU load)

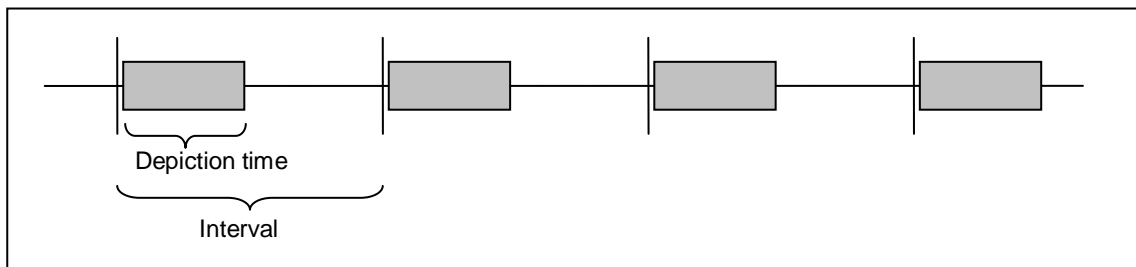

3) Color



White Button: Sets the radar picture display color to white monochrome.

Green Button: Sets the radar picture display color to green monochrome.

Yellow Button: Sets the radar picture display color to yellow monochrome.

Red Slide Bar: Adjusts the red level of radar picture color.

Green Slide Bar: Adjusts the green level of radar picture color.

Blue Slide Bar: Adjusts the blue level of radar picture color.

Reset Button: Resets the gradation curvature.

Brightness Scroll Bar: Adjusts the brightness of gradation curvature.

Contrast Scroll Bar: Adjusts the contrast of gradation curvature.

Gamma Scroll Bar: Adjusts the gamma level of gradation curvature.

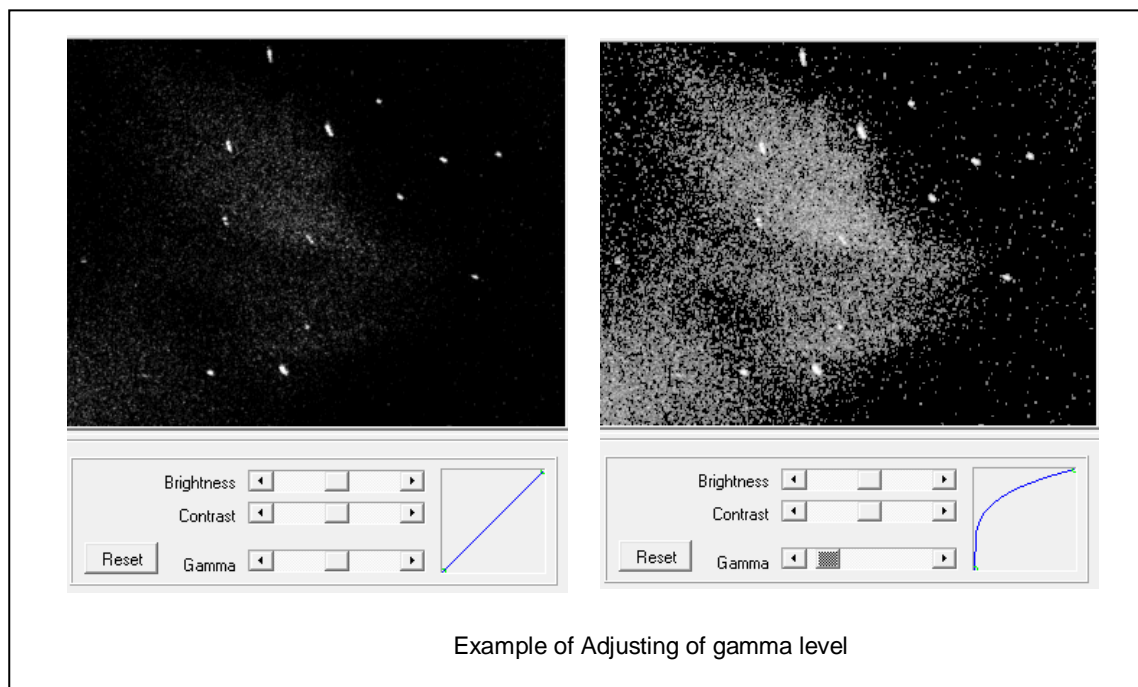

4) Stretch Mode

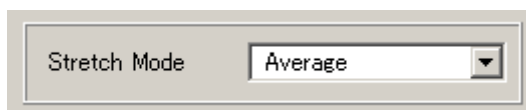

Stretch Mode: Selects the pixel composite method for B-scope conversion.

- None : Pixel composition is not carried out.
- Peak Hold :Maximum value is used.
- Average : Average value is used.

- Minimum : Minimum value is used.

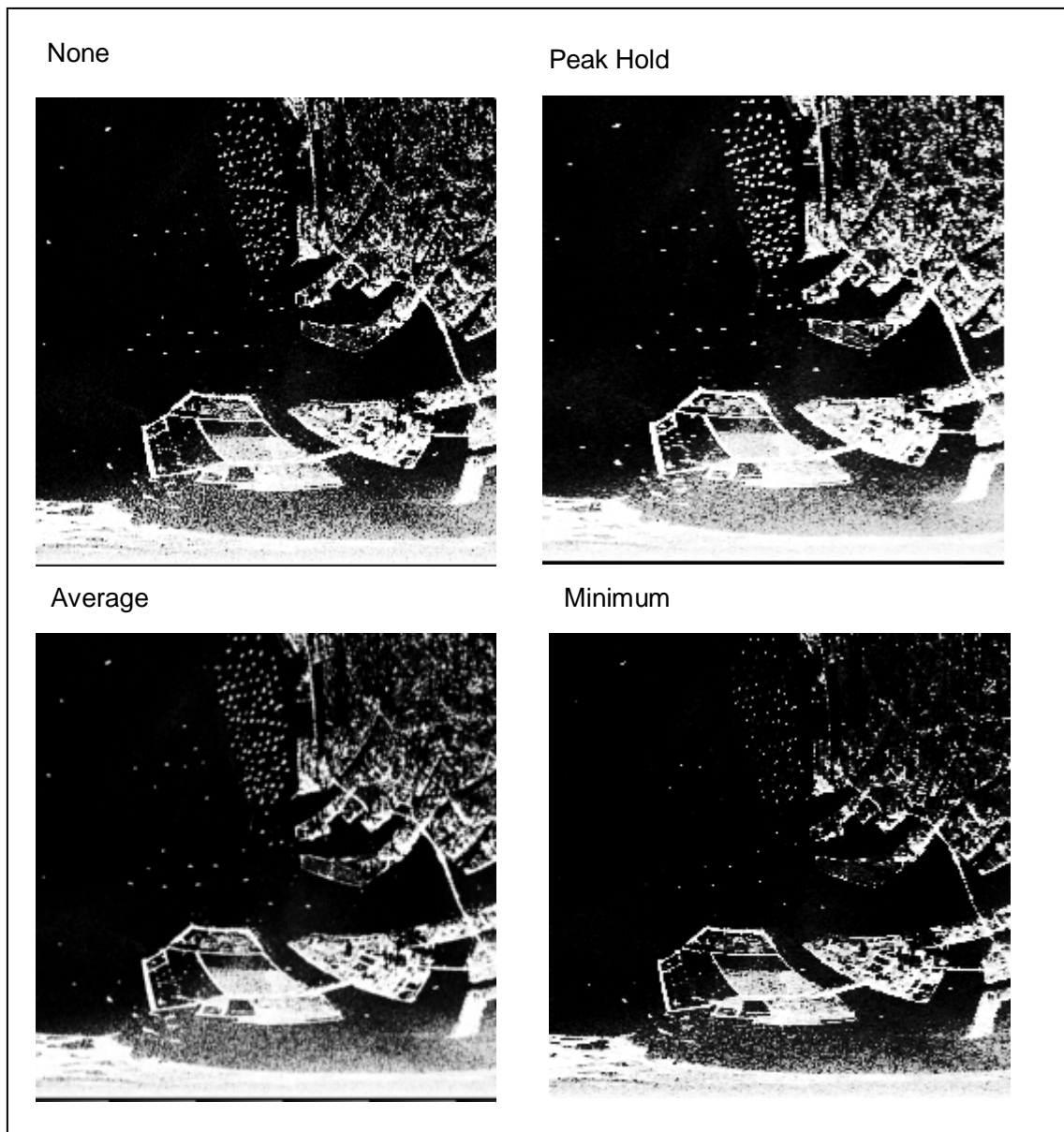

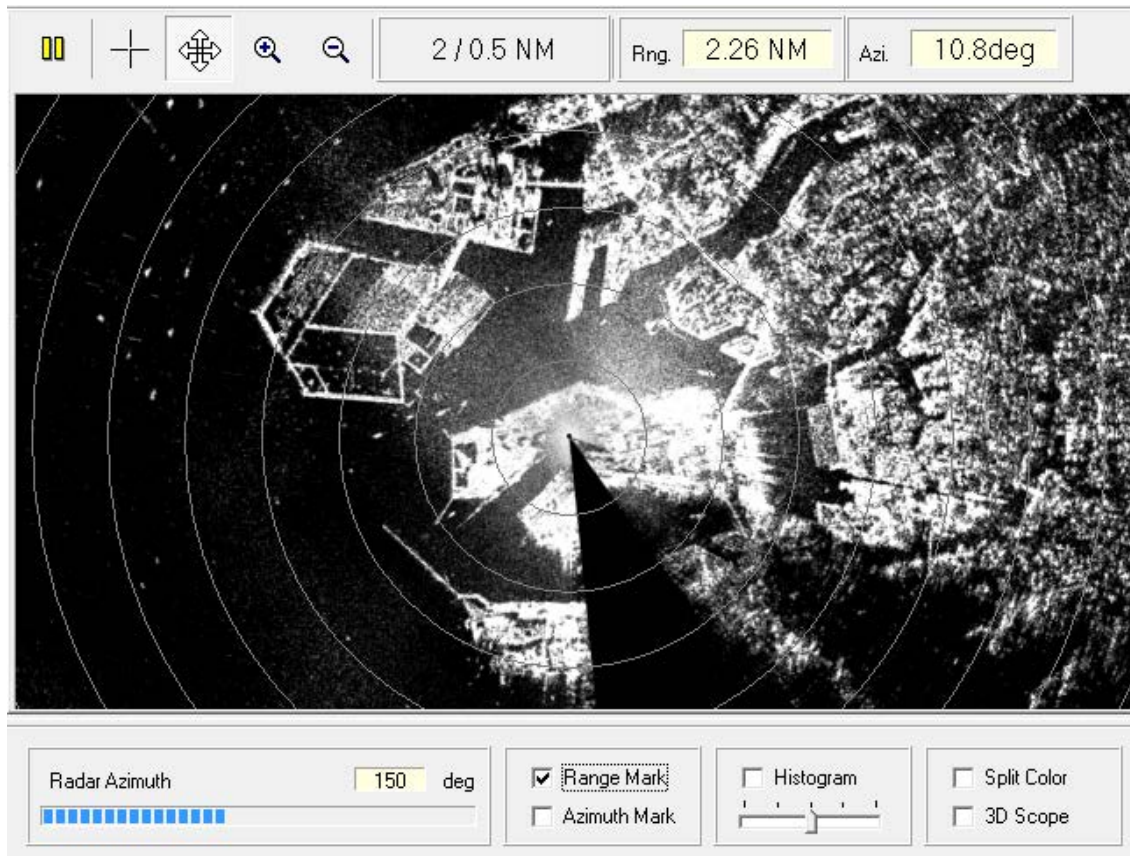

(3) PPI Scope



 : Image update is stopped when this switch turned ON.

 : Shows cursor position in the picture.

 : Moves picture position. (Off-Center)

 :Expand the position of cursor. (Zoom-in)

 : Reduce the position of cursor. (Zoom-out)

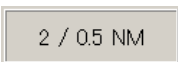
 : Shows display range and range marker interval.

Rng. : Displays distance of cursor position.

Azi. : Displays azimuth angle of cursor position.

Input Panel

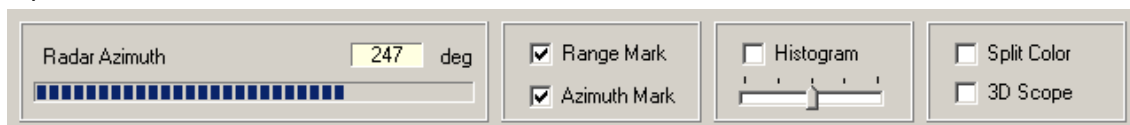

Radar Azimuth : Displays the radar antenna azimuth angle.

Range Mark : Selects display on/off of the Range Marker.

Azimuth Mark : Selects display on/off of the azimuth marker.

Histogram : Selects display on/off of the histogram.

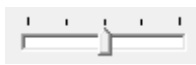
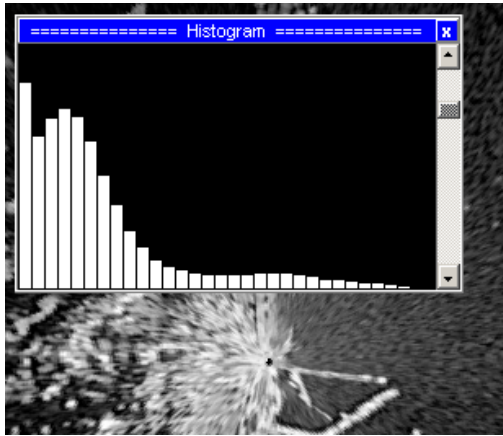

: Selects the histogram section width.

1 x 256, 4 x 64, 8 x 32, 16 x 16, 32 x 8

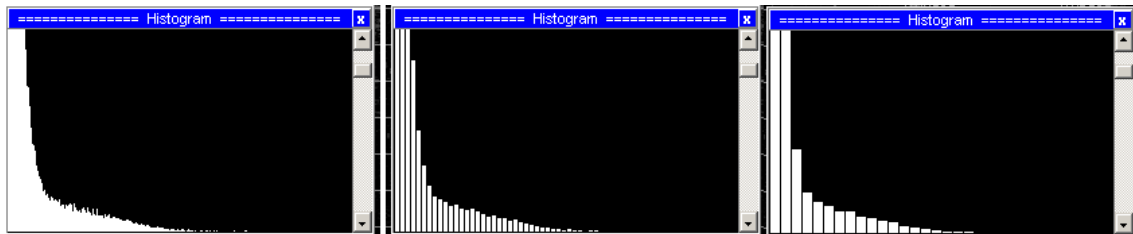

1 x 256

4 x 64

8 x 32

Split Color: Display on/off of the function to classify a radar picture by color to two gradation is changed.

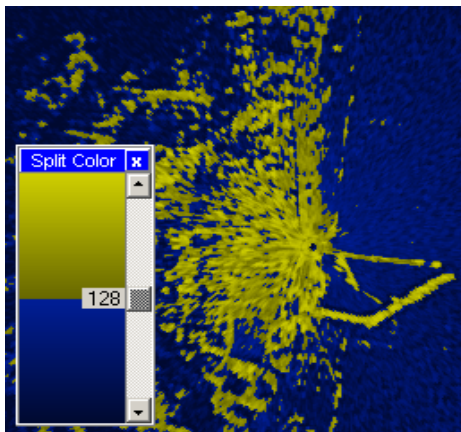

3D Scope : Selects the 3D display on/off.

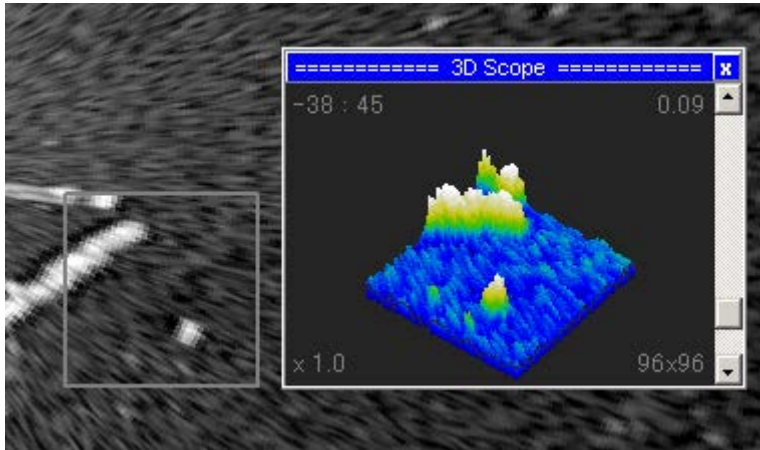

1) Scale

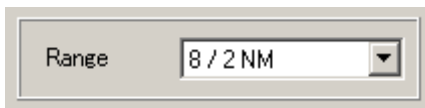

Range: Selects the display range scale. (Range/Range Marker Interval)

- 0.25 / 0.05 NM
- 0.5 / 0.1 NM
- 1 / 0.2 NM
- 2 / 0.5 NM
- 4 / 1 NM
- 8 / 2 NM
- 16 / 5 NM
- 32 / 10 NM
- 64 / 20 NM
- 128 / 50 NM

2) Display Interval

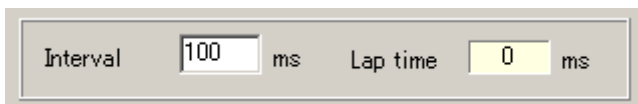

Interval: Presets the update interval of radar picture. (Preset range:10~1000mS)

Lap time: Displays the radar picture depiction lap time.

If an updating cycle is shortened, the load of CPU will increase.

(Please preset according to CPU load)

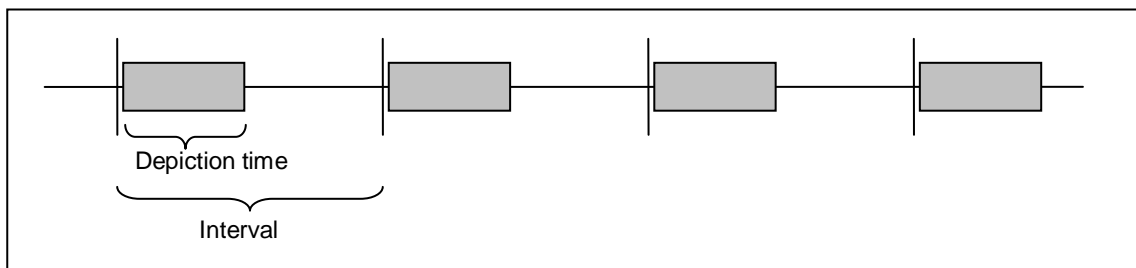

3) Color

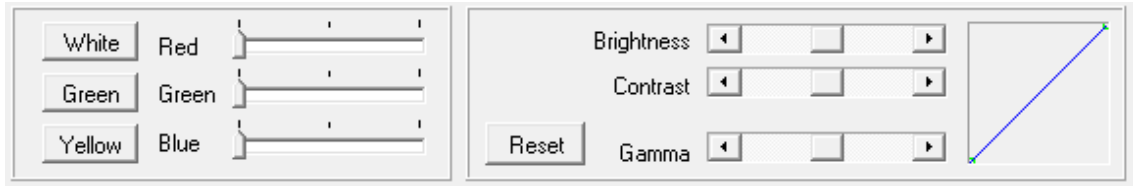

- White Button: Sets the radar picture display color to white monochrome.
- Green Button: Sets the radar picture display color to green monochrome.
- Yellow Button: Sets the radar picture display color to yellow monochrome.
- Red Slide Bar: Adjusts the red level of radar picture color.
- Green Slide Bar: Adjusts the green level of radar picture color.
- Blue Slide Bar: Adjusts the blue level of radar picture color.
- Reset Button: Resets the gradation curvature.
- Brightness Scroll Bar: Adjusts the brightness of gradation curvature.
- Contrast Scroll Bar: Adjusts the contrast of gradation curvature.
- Gamma Scroll Bar: Adjusts the gamma level of gradation curvature.

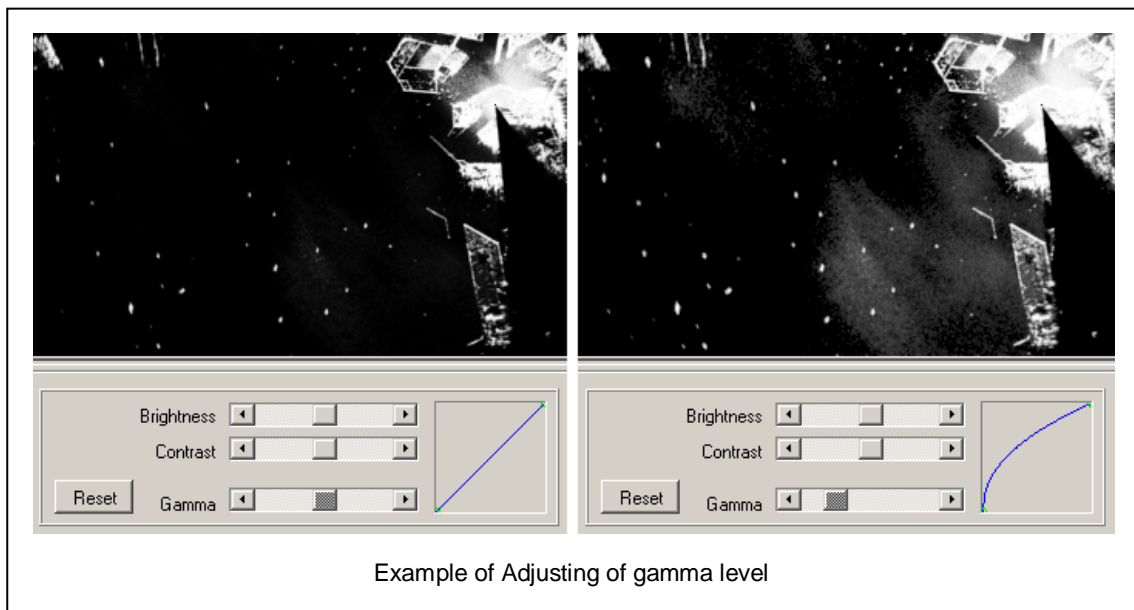

4) Stretch Mode

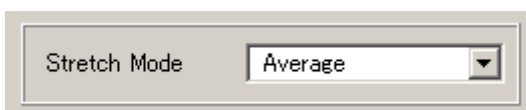

- Stretch Mode: Selects the pixel composite method for B-scope conversion.
- None : Pixel composition is not carried out.
 - Peak Hold :Maximum value is used.
 - Average : Average value is used.
 - Minimum : Minimum value is used.

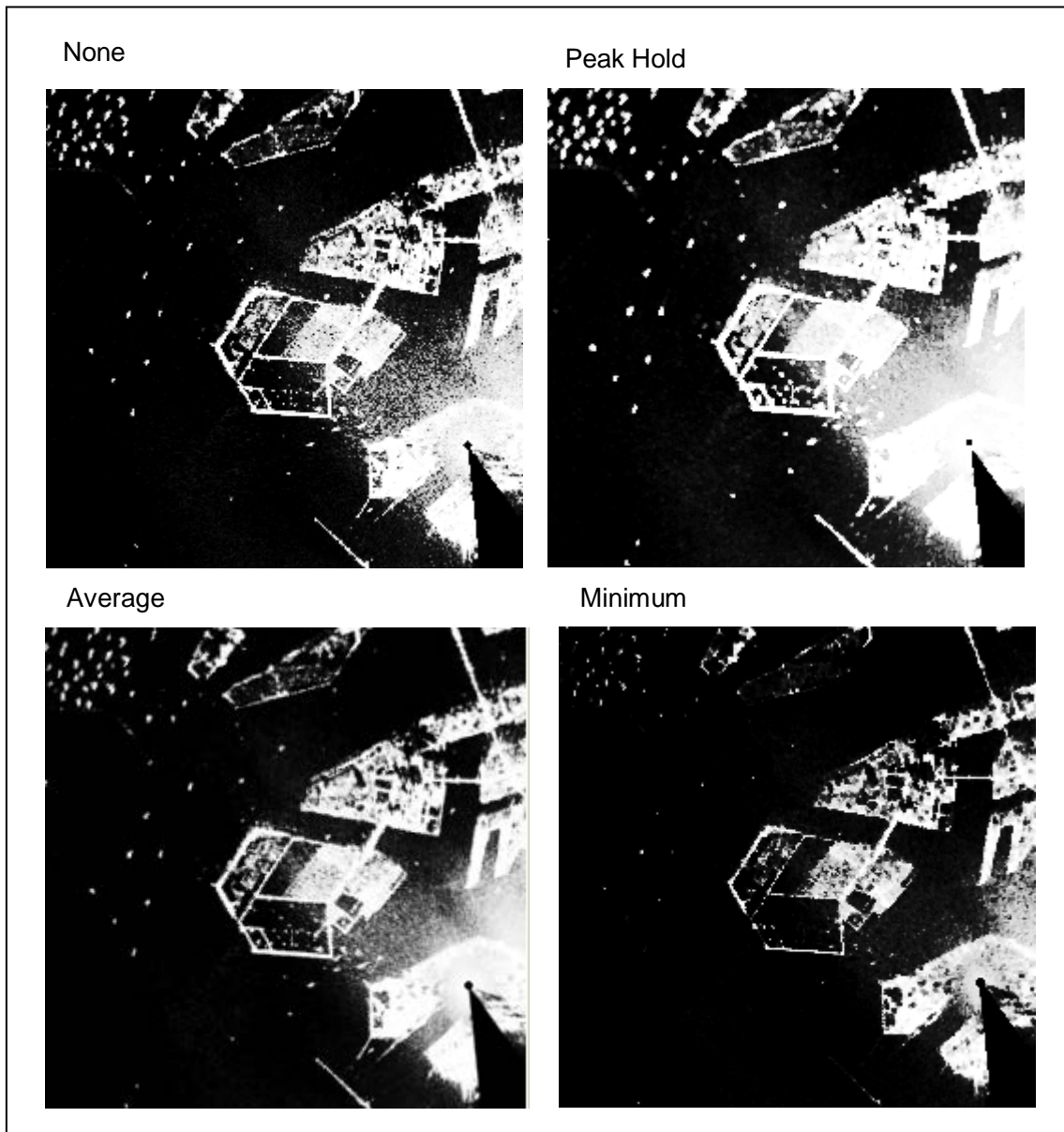

2.4.4.2 Input Image

Selects the input source

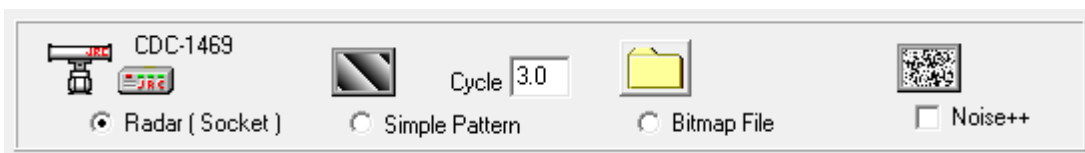

Radar (Socket) : Selects radar signal.

Simple Pattern : Selects the Test Pattern.

Cycle: Presets the test pattern rotation speed.

Bitmap File: Makes the bitmap file.



: Selects the bitmap file.

Noise++ : Superimpose the noise signal. (This setup is not saved.)

(1) Socket

The TCP/IP UDP client socket for connecting with radar signal processing equipment (CDC-1469) on NTG-420 SSTRX is set up.

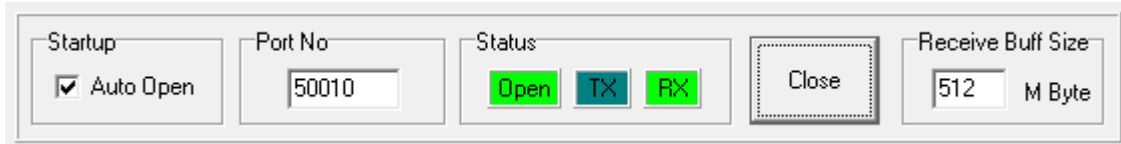

Startup – Auto Open: Automatically sets the socket to the application startup in the case to be open.

Port No: Presets the receiving port number of UDP socket.

Status : Status of UDP socket.

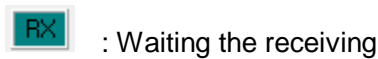
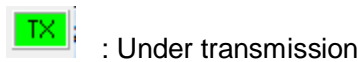
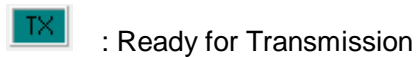
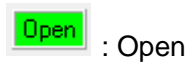

Open(or Close) Button : Open (or close) the socket

Receive Buff Size : Presets the receiving buffer size. (1 - 512MB)

1) Radar Information

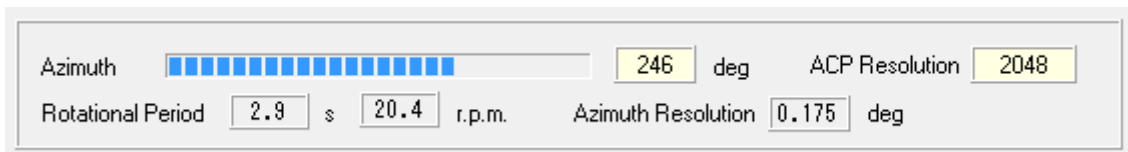

Azimuth : Displays radar antenna azimuth angle. (Latest sweep message angle)

ACP Resolution : Displays ACP resolution.

Rotational Period : Displays Antenna revolution period and rotation speed(rpm).

Azimuth Resolution]: Displays azimuth resolution. (The value which divided 360 degrees by the number of sweeps)

2) Message1

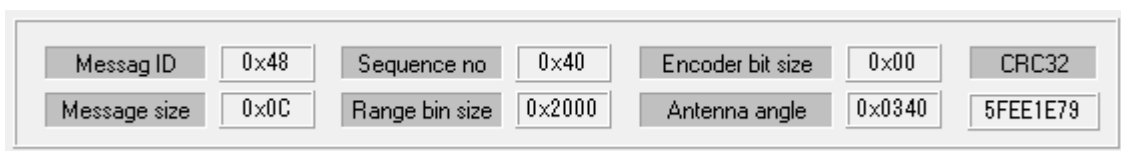

Display the header information of the receiving message.

Format of Receiving Message

Type	Size	Description
Header	12 bytes	Message ID (0x48) Message size(12) Sequence Number(0 – 255) Range bin size Antenna encoder bit number(0x00:11,0x01:12) Antenna Angle information CRC32c
Sweep data	Range bin size +3bytes	Message ID (0 x 44) Message size(Range bin size + 3) Data (Echo strength data)

3) Message2 & Counters

Message ID :Displays the message ID of sweep data (0 x 44).

Message Size :Displays the message size of sweep data.

*Message size = Range bin size+3.

Event Counters :Displays event counters of sweep message receiving process.

Contents of event counters

Location	Outline	Detailed
Upper1	It is interrupted 2 seconds or more during message reception.	If received during the reception of the message is interrupted for two seconds, and discard the message received up to the middle of its sweep. The number of times.
Upper2	Sequence number error	Number of times that the header sequence number is not correctly incremented.
Upper3	Azimuth error(skipping)	Number of times that the angle is open more than once of the orientation information in the header.
Upper4	Invalid data before Header	In a state of waiting for reception of the header, bytes on read-and-discard mode of data that is not recognized as a header.
Upper5	Split receiving of header	In a state of waiting for reception of the header, the header is received over a plurality of reception processing. The number of times.
Lower1	Sweep data ID error	In a state of waiting for the reception of the sweep data, the number of bytes on read-and-discard mode when the message ID is not detected.
Lower2	Mismatching of sweep data range bin number 1	Indicates the number of times the number of data of the range bins number and sweep data of the header do not match.
Lower3	Mismatching of sweep data range bin number 2	Always 0. The counter to be detected above is always 0.
Lower4	Occurrence of exception during sweep data receiving	Always 0. (Referred to debugging)

Lower5	Sweep number	Shows maximum sweep number in received data at 1 time receiving by application. Indication of whether it is processed smoothly.
--------	--------------	---

4) Receiving Rate

Read Size: : Display the maximum of the data size processed by one reception processing.

Receive Rate: Display the maximum of the receiving data size per second.

Counter Reset Button: Clear the maximum value of both Read Size and Receive Rate.

5) Error Status

It will display an error of application definition that occurred during the receiving process.

Error Code: Display the error number.

Error File: Display the error of occurred location (source file name).

Error Line: : Display the places that have occurred error (line number on the source file).

Clear Button: Clear the error display.

(2) Video Gain

Video Gain Scroll Bar: Adjust the radar video gain. (-1.00~+1.00)

: Reset the Video Gain to default value. (+1.00)

Video Offset Scroll Bar: Adjust the offset voltage of radar video. (-1.00~+1.00)

: Reset the Video Offset to default value. (0.00)

Profit Offset: Gain offset. This value is controlled by other module.

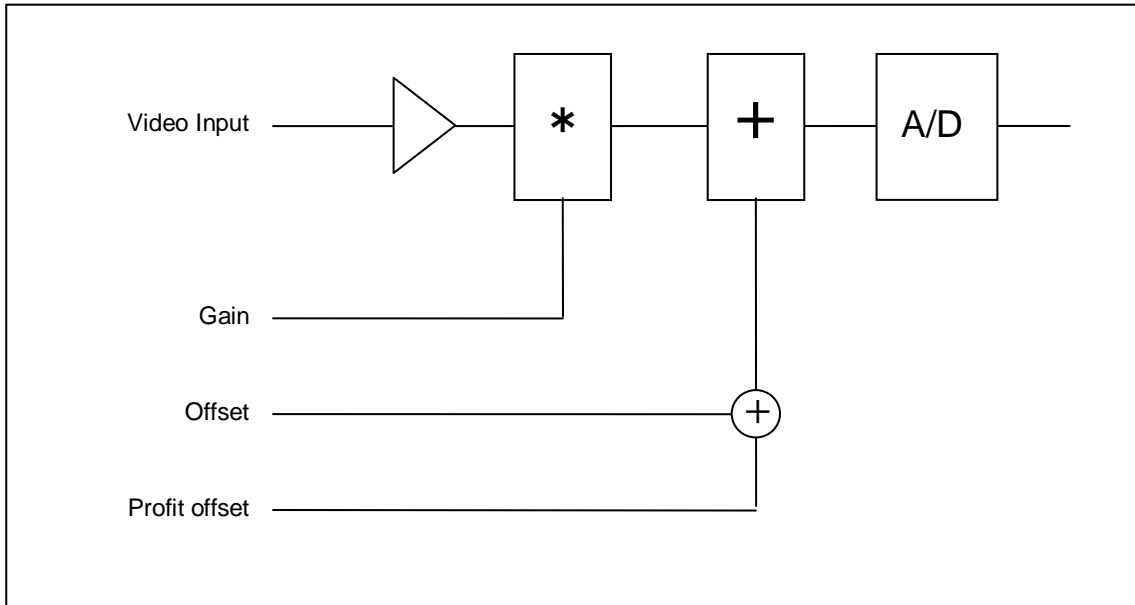

(3) RangeRate

Range Rate	7.5m/pixel(20MHz)	▼
Input Bin Size	8192	(512 - 8192)

Range Rate: Select the Range Rate (Resolution)

- 0 - 7.5m/pixel (20MHz)
- 1 - 15m/pixel (10MHz)
- 2 - 22.5m/pixel
- 3 - 30m/pixel (5MHz)
- 4 - 37.5m/pixel
- 5 - 45m/pixel
- 6 - 52.5m/pixel
- 7 - 60m/pixel (2.5MHz)
- 8 - 67.5m/pixel
- 9 - 75m/pixel (2MHz)
- 10 - 82.5m/pixel
- 11 - 90m/pixel
- 12 - 97.5m/pixel
- 13 - 105m/pixel
- 14 - 112.5m/pixel
- 15 - 120m/pixel (1.25MHz)

(4) Input Bin Size

Range Rate	7.5m/pixel(20MHz)	▼
Input Bin Size	8192	(512 - 8192)

Input Bin Size: Specify the input range bin size. (512 – 8192)

*By shortening the capture range bin size(length), you can reduce the CPU load.

(5) 0m Adjustment

0m Adjustment	<input type="text" value="0"/>	(-2500 m - 2500 m)
Azimuth Adjustment	<input type="text" value="0x0000"/>	(0x0000 - 0xFFFF)
	<input type="text" value="0.0"/>	deg

0m Adjustment: Adjust the radar echo start range bin. (-2500m - +2500m))

This adjustment is for adjusting the center of the radar image and shift the radar image on the home side in pixels.

(6) Azimuth Adjustment

0m Adjustment	<input type="text" value="0"/>	(-2500 m - 2500 m)
Azimuth Adjustment	<input type="text" value="0x0000"/>	(0x0000 - 0xFFFF)
	<input type="text" value="0.0"/>	deg

Azimuth Adjustment: Adjust the radar azimuth angle. (0x0000 - 0xFFFF)

This is for radar echo azimuth angle. Resolution is 360/65536(deg.)

2.4.4.3 Failure history

Failure history will be displayed for the troubleshooting.

Date(yy/mm/dd)	Time(hh:mm:ss)	Message
Date[16/02/02]	Time[03:06:19]	***** < Start > ***** (SysTime:3515s)
Date[16/02/02]	Time[03:06:19]	[N_Solid.exe,Version 1.0,2016/01/14 15:43:42]
Date[16/02/02]	Time[03:37:24]	***** < End > ***** (SysTime:5379s)
Date[16/02/02]	Time[03:37:24]	
Date[16/02/02]	Time[05:38:15]	***** < Start > ***** (SysTime:12631s)
Date[16/02/02]	Time[05:38:15]	[N_Solid.exe,Version 1.0,2016/01/14 15:43:42]

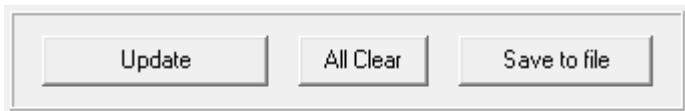

Update Button: Update the current logging information.

All Clear Button: Clear the all logging information.

Save to file Button: Save the current logging data with file name.

2.4.4.4 Simulation

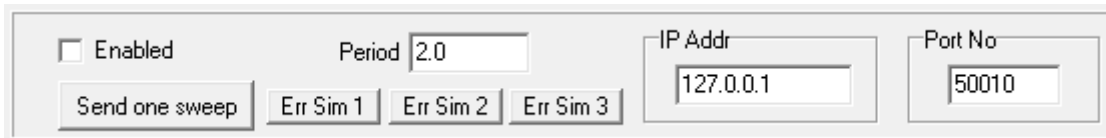

This function is to simulate the output of the message of the CDC-1469. It can not use that it has not Open the receiving socket so to send will use the socket for reception.

Enabled: This is switch for simulation on/off.

Period: Specify the radar antenna rotation speed for the simulation.

IP Addr: Specify the output IP address. (127.0.0.1 is special IP which mean own IP address)

Port No: Specify the output port number.

Send one sweep Button: Outputs the message of one sweep data as single.

Outputs the whether Enabled check box is off.

Err Sim 1 Button: Outputs the CRC32C of header with taking small interval.

Err Sim 2 Button: Outputs any of the data before header.

Err Sim 3 Button: Lack the message of 1 sweep length.

*These functions are for communication confirmation and debugging.

(1) Message1

Message ID	0x48	Sequence no	0x00	Encoder bit size	0x00
Message size	0x0C	Range bin size	0x4000	Antenna angle	0x0000

Specify the header information of simulated sweep message.

Type	Size	Description
Header	12 bytes	Message ID (0x48) Message size(12) Sequence Number(0 – 255) Range bin size Antenna encoder bit number(0x00:11,0x01:12) Antenna Angle information CRC32c
Sweep Data	Range bin size + 3 bytes	Message ID (0 x 44) Message size(Range bin size + 3) Data (Echo strength data)

(2) Message2 & Counters

Message ID	0x44	<input checked="" type="radio"/> Send Counter Number of bytes 0 <input type="radio"/> Receive Counter <input type="radio"/> Difference Number of sweeps 0	Clear
Message size	0x4003		

Message ID : Specify the message ID of simulated sweep data (0 x 44).

Message Size : Specify the message size od simulated sweep data.

*Message size = Range bin size+3.

Send Counter : Select the both sending data counter and sweep counter.

Receive Counter: Select the both receiving data counter and sweep counter.

Difference :Select the different. (Send Counter) – (Receive Counter)

Number of bytes: Display the data counter.

Number of sweeps: Display the sweep counter.

Clear Button: Clear the above counter.

2.4.4.5 Sweep Tag

Tag Format (Size)		
<input type="radio"/> None (0)	<input checked="" type="radio"/> PciRvi (4 bytes)	<input type="radio"/> Nams (10 bytes)
<input type="radio"/> PCIvdi (16 bytes)	<input type="radio"/> PciRvi (16 bytes)	<input type="radio"/> Nams (16 bytes)

Tag Format (Size):

None(0): No hardware Tag.

Range bin	Description	Remarks
4080~4095	Padding data 16bytes	0 Fixed
3~4079	Radar picture data 3 - 4079	Valid
2	Radar picture data 2	Valid
1	Radar picture data 1	Valid
0	Radar picture data 0	Valid

PciVdo(16): Pci – Vdi format

Range bin	Description	Remarks
16~4095	Radar picture data 0 - 4079	Valid
15	Command register H	0 Fixed
14	Command register L	0 Fixed
13	End distance H	Valid
12	End distance L	Valid
11	Start distance H	0 Fixed
10	Start distance L	0 Fixed
9	Times of day H	0 Fixed
8	Times of day L	0 Fixed
7	Dummy	uncertainty
6	PPS counter value H	0 Fixed
5	PPS counter value M	0 Fixed
4	PPS canter value L	0 Fixed
3	External Tag H	0 Fixed
2	External Tag L	0 Fixed
1	Radar antenna azimuth H [65536 / 360]	Valid
0	Radar antenna azimuth L [65536 / 360]	Valid

PciRvi(4) : Pci – Rvi format

Range bin	Description	Remarks
4084~4095	Padding data 12 bytes	0 Fixed
4~4083	Radar picture data 0 - 4079	Valid
3	External Tag H	0 Fixed
2	External Tag L	0 Fixed
1	Radar antenna azimuth H [65536 / 360]	Valid
0	Radar antenna azimuth L [65536 / 360]	Valid

PciRvi(16): Pci – Rvi format + 12 bytes padding

Range bin	Description	Remarks
16~4095	Radar picture data 0 - 4079	Valid
4~15	Padding data 12bytes	0 Fixed
3	External Tag H	0 Fixed
2	External Tag L	0 Fixed
1	Radar antenna azimuth H [65536 / 360]	Valid
0	Radar antenna azimuth L [65536 / 360]	Valid

Nams(10): Nams format

Range bin	Description	Remarks
4090~4095	Padding data 6bytes (=0)	0 Fixed
10~4089	Radar picture data 0 - 4079	Valid
9	End distance H	Valid
8	End distance L	Valid
7	Start distance H	0 Fixed
6	Start distance L	0 Fixed
5	Radar antenna azimuth H [65536 / 360]	Valid
4	Radar antenna azimuth L [65536 / 360]	Valid
3	PPS times of day H	0 Fixed
2	PPS times of day MH	0 Fixed
1	PPS times of day ML	0 Fixed
0	PPS times of day L	0 Fixed

Nams(16): Nams format + 6bytes padding

Range bin	Description	Remarks
16~4095	Radar picture data 0 - 4079	Valid
10~15	Padding data 6bytes	0 Fixed
9	End distance H	Valid
8	End distance L	Valid
7	Start distance H	0 Fixed
6	Start distance L	0 Fixed
5	Radar antenna azimuth H [65536 / 360]	Valid
4	Radar antenna azimuth L [65536 / 360]	Valid
3	PPS times of day H	0 Fixed
2	PPS times of day MH	0 Fixed
1	PPS times of day ML	0 Fixed
0	PPS times of day L	0 Fixed

2.5.5 Admin Menu

This menu is a summary of the settings to be performed when the system is introduced. This is not used in normal. To display this menu, complete the following steps.

- i. Click the File of main menu with pushing the Ctrl key.
- ii. Select the Admin Menu of Menu.
- iii. Push the OK button after input the password.
(Initial password: "Admin")

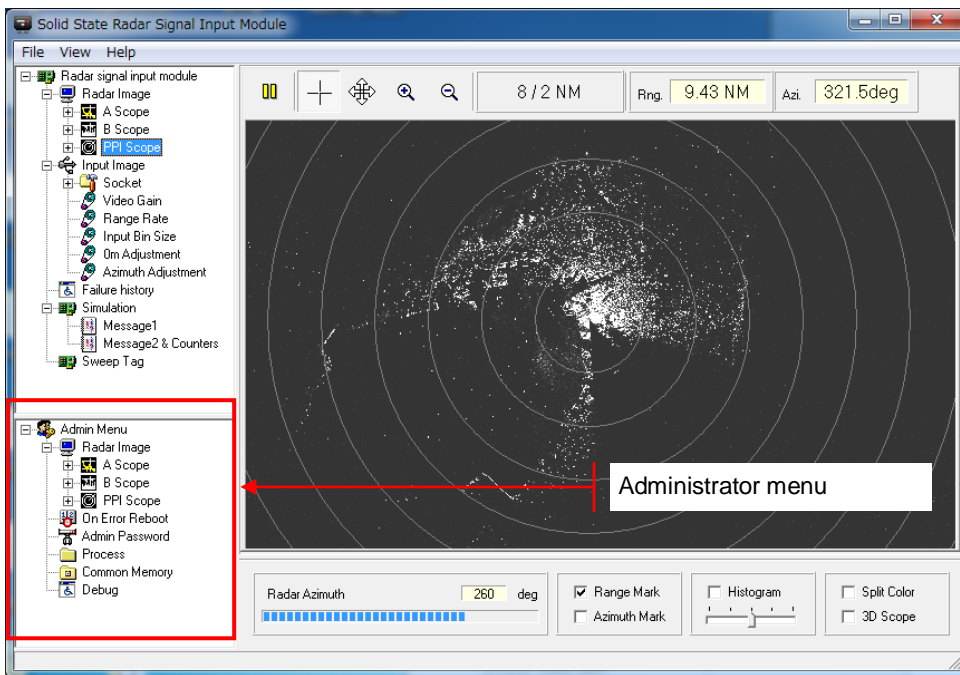

2.5.5.1 Radar Image

(1) A Scope

It is an item holder for the A Scope display.

1) Double Buffered

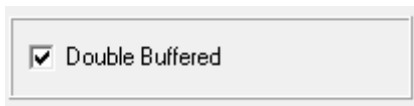

Double Buffered: In case a radar picture is updated, it carries out through a buffer. Flicker when moving the image will be reduced by this function.

(2) B Scope

It is an item holder for the B Scope display.

1) Double Buffered

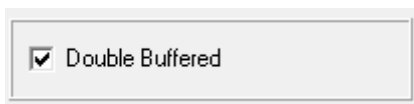

Double Buffered: In case a radar picture is updated, it carries out through a buffer. Flicker when moving the image will be reduced by this function.

(3) Ppi Scope

It is an item holder for the Ppi Scope display.

1) Double Buffered

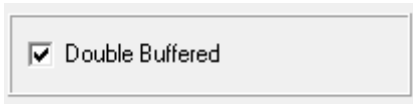

Double Buffered: In case a radar picture is updated, it carries out through a buffer. Flicker when moving the image will be reduced by this function.

2.5.5.2 On Error Reboot

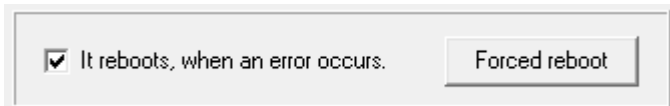

If reboots, when an error occurs: Reboots the PC at error occurrence.

Forced reboot: Reboots immediately. (Test use)

2.5.5.3 Admin Password

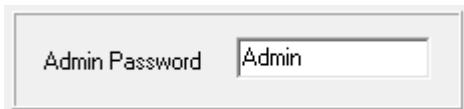

Admin Password: Set the password to enter to display the Administrator menu.

2.5.5.4 Process



Process Priority: Select the application process priority.

- 0 – Real time High priority
- 1 – High ↑
- 2 – Above Normal
- 3 – Normal
- 4 – Below Normal ↓
- 5 – Idle Low priority

Thread Priority: Select the priority of the application's main thread.

- 0 – Time Critical High priority
- 1 – Highest ↑
- 2 – Above Normal

- 3 – Normal
 - 4 – Below Normal
 - 5 – Lowest
 - 6 – Idle
- ↓
Low priority

CPU Select: (Not using)

2.5.5.5 Common Memory

It is an interface for providing other applications with a radar picture.

Common Memory	Main output	D:/画像配信/E2/Exe/(no name):VDIeBuff
	Group core	D:/画像配信/E2/Exe/(no name):CoreBuff

Main output: Output for shared memory name to the image processing module.

Group core: Shared memory name for the final output.

2.5.5.6. Debug

For debugging (No discloser)

2.6 Startup parameter

The format of the command line parameters

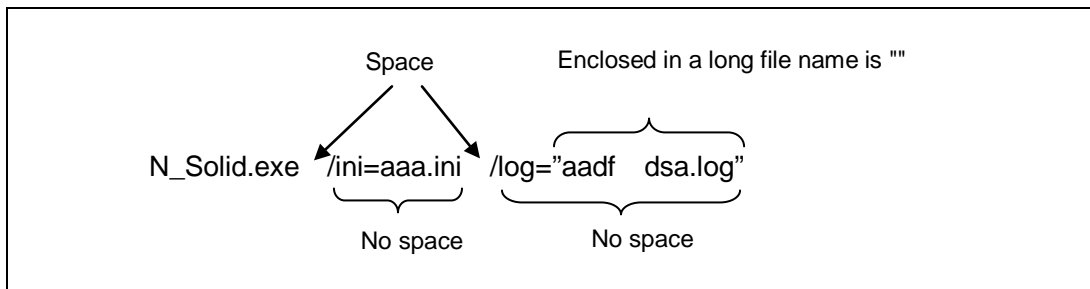

The following control is possible by the command line parameter.

Command Line Parameter	Description
/ini=(Initialization file name)	Specify the initialization file. The default is to N_Solid.ini of module directory.
/log=(Failure log file name)	Specify the failure log file name. The default is to N_Solid.log of module directory.
/name=(Instance distinguished name)	Specify the unique identification name to create multiple instances in the PC.
/mem=(Shared memory name)	Specify the name of the destination shared memory of the captured radar image.

3. Specification

Transmitting frequency	: Non-chirp pulse	9,410MHz(P0N)
	Chirp pulse	9,440 ± 15MHz(Q0N)
	Non-Chirp/Chirp pulse(P0N/Q0N)	*1
Transmitting power	: 200W +1dB, -3dB	(100W~251W)*2
Transmitter Type	: Solid State Power Amplifier(SSPA)	
Transmission pulse width	: Refer to Transmission Table(1)	
Pulse repetition frequency(PRF)	: Refer to Transmission Table(1)	

Transmission Table(1)

No.	Pulse width			PRF
	Non-chirp pulse	Chirp pulse	Non-chirp pulse /Chirp pulse	
0	0.07us	2.8us	0.07us/2.8us	2280Hz
1	0.15us	4.6us	0.15us/4.6us	2280Hz
2	0.3us	9.1us	0.3us/9.1us	2280Hz
3	0.15us	18.3us	0.15/18.3us	1280Hz
4	0.15us	28.0us	0.15us/28.0us	640Hz
5	0.3us	9.1us	0.3us/9.1us	1864Hz
6	0.6us	9.1us	0.6us/9.1us	1280Hz
7	0.07us	2.8us	0.07us/2.8us	4100Hz

Minimum Detection Signal(MDS) : -93dBm or less

A/D Sampling rate : 16bit/84MHz

Pulse compression : Provided

Video Processing function : Interference rejection, CFAR and
Coherent integration

Output signal : Radar video and Trigger

Radar control/monitoring : TCP/IP communication

Power supply : DC48V ± 10%

Power consumption : Less than 130W

Dimensions : 554mm(W) x 330mm(D) x 580mm(H)
(Including Mounting Plate)

Operation temperature range : -15 ~ +50°C, Non-condensing

Relative humidity : 93% @+40°C

Storage temperature range : -25 ~ +60°C

*1: Transmits both P0N and Q0N at simultaneously

*2: Transmitting power is fixed.

2) Radar Control/Monitoring PC display

Hardware

PC Model : HP Z230 or equivalent/ 32 or 64bit Model

CPU : Xeon 2.8GHz or more

Memory : 4Gbytes or more

Hard Disk : 500GB or more

NIC#1 : Gigabit (1000Mbps)
Jumbo Frame more than 9014bytes
NIC#2 : Ethernet (1000Mbps/100Mbps/10Mbps)
OS : Windows 7 Professional (32 or 64bit)

Software

Feature : Radar Control
Radar Condition Monitoring
Radar Echo Display
NTP Time adjustment
VNC Server

FCC Caution

Changes or modifications not expressly approved by the party responsible for compliance could void the user's authority to operate the equipment.

This equipment generates, uses and can radiate radio frequency energy and, if not installed and used in accordance with the instructions, may cause harmful interference to radio communications.

However, there is no guarantee that interference will not occur in a particular installation. If this equipment does cause harmful interference to radio or television reception, which can be determined by turning the equipment off and on, the user is encouraged to try to correct the interference by one or more of the following measures:

- 1) Reorient or relocate the receiving antenna.
- 2) Increase the separation between the equipment and receiver.
- 3) Connect the equipment into an outlet on a circuit different from that to which the receiver is connected.
- 4) Consult the dealer or an experienced radio/TV technician for help.

This device complies with Part 80 and Part 90 of the FCC rules.

Operation is subject to the following two conditions: (1) this device may not cause interference, and (2) this device must accept any interference, including interference that may cause undesired operation of the device.

IC (Industry Canada)

This device complies with Industry Canada's licence-exempt RSSs. Operation is subject to the following two conditions:

- (1) This device may not cause interference; and
- (2) This device must accept any interference, including interference that may cause undesired operation of the device.

Le présent appareil est conforme aux CNR d'Industrie Canada applicables aux appareils radio exempts de licence.

L'exploitation est autorisée aux deux conditions suivantes :

- 1) l'appareil ne doit pas produire de brouillage;
- 2) l'utilisateur de l'appareil doit accepter tout brouillage radioélectrique subi, même si le brouillage est susceptible d'en compromettre le fonctionnement.