



MET Laboratories, Inc. *Safety Certification - EMI - Telecom Environmental Simulation*
914 WEST PATAPSCO AVENUE • BALTIMORE, MARYLAND 21230-3432 • PHONE (410) 354-3300 • FAX (410) 354-3313

Japan Radio Co., Ltd.
2-1-4 Fukuoka, Kamifukuoka-shi
Saitama, 356-0011, Japan

June 15, 2005

Dear Kiyohito Kobayashi,

Enclosed is the EMC test report for compliance testing of the JRC FWA System - Type W <EL0>, tested to the requirements of Title 47 of the Code of Federal Regulations (CFR), Part 15 Subpart B, Section 15.101(a).

Based on these results, MET Laboratories, Inc. certifies that the JRC FWA System - Type W <EL0>, tested as configured, meets the requirements and interference limitations for a Class B Digital Devices under Title 47 of the CFR, Part 15 Subpart B, Section 15.107(a) and 15.109(a).

Thank you for using the services of MET Laboratories, Inc. If you have any questions regarding these results or if MET can be of further service to you, please feel free to contact me.

Sincerely yours,
MET LABORATORIES, INC.

Marie Confroy
Documentation Department

Reference: (\Tomen Electronics Corp.\EMC17223-FCC)

Certificates and reports shall not be reproduced except in full, without the written permission of MET Laboratories, Inc. While use of the National Voluntary Laboratory Accreditation Program (NVLAP) letters or the NVLAP Logo, the Standards Council of Canada Logo, A2LA, or the Nationally Recognized Testing Laboratory (NRTL) Letters in this report reflects MET Accreditation under these programs, these letters, logo, or statements do not claim product endorsement by these organizations or any Agency of the U.S. Government. This letter of transmittal is not a part of the attached report.



The Nation's First Licensed Nationally Recognized Testing Laboratory





MET Laboratories, Inc. *Safety Certification - EMI - Telecom Environmental Simulation*
914 WEST PATAPSCO AVENUE • BALTIMORE, MARYLAND 21230-3432 • PHONE (410) 354-3300 • FAX (410) 354-3313

**Electromagnetic Compatibility Criteria
Test Report**

For the

JRC FWA System - Type W <EL0>

**Title 47 of the Code of Federal Regulations (CFR),
Part 15 Subpart B
For a Class B Digital Device**

MET Report: EMC17223-FCC

June 15, 2005

Prepared for:

**Japan Radio Co., Ltd.
2-1-4 Fukuoka, Kamifukuoka-shi
Saitama, 356-0011, Japan**

**Prepared By:
MET Laboratories, Inc.
914 W. Patapsco Ave
Baltimore, MD 21230**



Electromagnetic Compatibility Criteria Test Report

For the

JRC FWA System - Type W <EL0>

**Title 47 of the Code of Federal Regulations (CFR),
Part 15 Subpart B
For a Class B Digital Device**

MET Report: EMC17223-FCC

Liming Xu
Project Engineer, Electromagnetic Compatibility Lab

Marie Confroy
Documentation Department

Engineering Statement: The measurements shown in this report were made in accordance with the procedures indicated, and the emissions from this equipment were found to be within the applicable limits. I assume full responsibility for the accuracy and completeness of these measurements, and for the qualifications of all persons taking them. It is further stated that upon the basis of the measurements made, the equipment tested is capable of operation in accordance with the requirements of Title 47 of the CFR, Part 15, Subpart B for a Class B Digital Device under normal use and maintenance.

Kevin Mehaffey
Manager, Electromagnetic Compatibility Lab



Report Status Sheet

Revision	Report Date	Reason for Revision
Ø	June 15, 2005	Initial Issue.



Table of Contents

1.0 Testing Summary	1
2.0 Equipment Configuration.....	2
2.1 Overview	2
2.2 Test Site	3
2.3 Description of Test Sample	3
2.4 Equipment Configuration.....	4
2.5 Support Equipment	4
2.6 Ports and Cabling Information	5
2.7 Mode of Operation	7
2.8 Method of Monitoring EUT Operation	7
2.9 Modifications	7
2.9.1 Modifications to EUT	7
2.9.2 Modifications to Test Standard	7
2.10 Disposition of EUT	7
3.0 Electromagnetic Compatibility Emission Criteria	8
3.1 Conducted Emission Limits	8
3.2 Radiated Emission Limits	16
4.0 Test Equipment	20
5.0 Compliance Information.....	21
5.1 Label and User’s Manual Information	23



List of Tables

Table 1. Summary of Test Results	1
Table 2. EUT Overview	2
Table 3. Equipment Configuration	4
Table 4. Ports and Cabling Information	5
Table 5. Conducted Limits for Radio Frequency Devices calculated from FCC Part 15 Section 15.107(a) (b)	8
Table 6. Conducted Emissions - Voltage, Worst Case Emissions, AC Power, Phase Line	10
Table 7. Conducted Emissions - Voltage, Worst Case Emissions, AC Power, Neutral Line	10
Table 8. Radiated Emissions Limits calculated from FCC Part 15, § 15.109 (a) (b)	16
Table 9. Radiated Emissions Limits Test Results (30MHz to 1GHz)	17
Table 10. Test Equipment	20

List of Figures

Figure 1. Block Diagram of Test Configuration.....	6
--	---

List of Photographs

Photograph 1. Conducted Emissions Test Setup	15
Photograph 2. Radiated Emission Limits Test Setup	18
Photograph 3. Radiated Emission Limits Test Setup	19



List of Terms and Abbreviations

AC	Alternating Current
ACF	Antenna Correction Factor
Cal	Calibration
d	Measurement Distance
dB	Deci Bels
dBμV	Deci-Bels above one micro Volt
dBμV/m	Deci-Bels above one micro Volt per meter
DC	Direct Current
DCF	Distance Correction Factor
E	Electric Field
DSL	Digital Subscriber Line
ESD	Electrostatic Discharge
EUT	Equipment Under Test
f	Frequency
FCC	Federal Communications Commission
GHz	Giga Hertz
Hz	Hertz
kHz	kilohertz
kPa	kilopascal
kV	kilo Volt
LISN	Line Impedance Stabilization Network
MHz	MegaHertz
μH	micro Henry
μF	micro Farad
μs	micro seconds
RF	Radio Frequency
RMS	Root-Mean-Square



1.0 Testing Summary

Title 47 of the CFR, Part 15, Subpart B, Reference and Test Description	Results	Comments
15.107 (a) Conducted Emission Limits for a Class B Digital Device	Compliant	The EUT complies with the requirements of this section.
15.109 (a) Radiated Emission Limits for a Class B Digital Device	Compliant	The EUT complies with the requirements of this section.

Table 1. Summary of Test Results



2.0 Equipment Configuration

2.1 Overview

MET Laboratories, Inc. was contracted by Japan Radio Co., Ltd. to perform testing on the JRC FWA System - Type W <EL0>, under purchase order number AT04201118.

This document describes the test setups, test methods, required test equipment, and the test limit criteria used to perform compliance testing of the JRC FWA System - Type W <EL0>.

An EMC evaluation to determine compliance of the JRC FWA System - Type W <EL0> with the requirements of §15.101(a) for Class B Digital Devices was performed. (All references are to the most current version of Title 47 of the Code of Federal Regulations in effect). In accordance with §2.1075(a)(3), the following data is presented in support of the Declaration of Conformity of the JRC FWA System - Type W <EL0>. Japan Radio Co., Ltd. should retain a copy of this document which should be kept on file for at least two years after the manufacturing of the JRC FWA System - Type W <EL0> has been permanently discontinued, as per §2.1075(c).

The results obtained relate only to the item(s) tested.

Model(s) Tested:	JRC FWA System - Type W <EL0>
Model(s) Covered:	JRC FWA System - Type W <EL0>
Primary Power:	120 Vac
Equipment Emissions Class:	B
Highest Clock Frequency:	12 GHz
Evaluated by:	Liming Xu
Report Date:	June 15, 2005

Table 2. EUT Overview



2.2 Test Site

All testing was performed at MET Laboratories, Inc., 914 West Patapsco Avenue, Baltimore, MD 21230. All equipment used in making physical determinations is accurate and bears recent traceability to the National Institute of Standards and Technology.

Radiated Emissions measurements were performed in a semi-anechoic chamber. In accordance with §2.948(a)(3), a complete site description is contained at MET Laboratories. In accordance with §2.948(d), MET Laboratories has been accredited by the National Voluntary Laboratory Accreditation Program (Lab Code: 100273-0).

2.3 Description of Test Sample

The JRC FWA System - Type W <EL0>, Equipment Under Test (EUT), is a broadband wireless point-to-multipoint (PTMP) and point-to-point (PTP) communication system operating at 24-26 GHz that provides high-speed IP access using time division duplex (TDD), and adaptive modulation.



2.4 Equipment Configuration

The EUT was set up as outlined in Figure 1. All equipment incorporated as part of the EUT is included in the following list.

Ref. ID	Name / Description	Model Number	Serial Number
1	TYPEW-AP-RFU	NTG-335-EL0	NJVW000001T
2	TYPEW-AP-IFU	NTJ-111	NJVW000001T
3	TYPEW-WT	NTG-337-EL0	NJJW000001T
4	WT-ADAPTER	NQD-2049	None Listed
5	AC-ADAPTER	NBG-317	None Listed

Table 3. Equipment Configuration

2.5 Support Equipment

There was no support equipment necessary for the operation and testing of the EUT.



2.6 Ports and Cabling Information

Ref. ID	Port Name on EUT	Cable Description	Qty.	Length (m)	Shielded (Y/N)
1	ANT	Coaxial Cable	1	3	Yes
2	ANT	Coaxial Cable	1	3	Yes
2	DC-48V	Power supply cable	1	2	No
2	ETHER	Etheernet Cable	1	10	No
3	ETHER	Etheernet Cable	1	2	No
4	ANT	Etheernet Cable	1	2	No
4	PC	Etheernet Cable	1	10	No
4	DC	Power supply cable(DC)	1	1.8	No
5	DC	Power supply cable(DC)	1	1.8	No
5	AC	Power supply cable(AC)	1	1.8	No

Table 4. Ports and Cabling Information

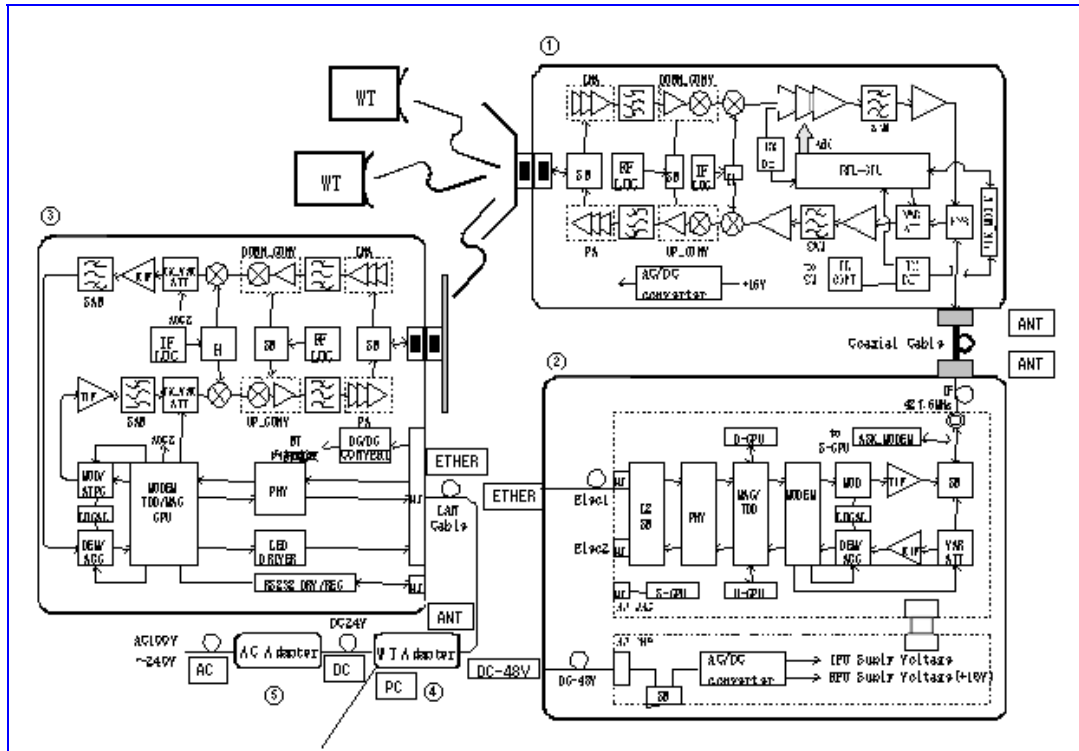

Figure 1. Block Diagram of Test Configuration



2.7 Mode of Operation

The Point-to-multipoint (PTMP) system is comprised of two sub-systems; the Access Point (AP) serves as the hub unit connects to a wide area network, and the Wireless Terminal serves as the remote unit and connects to a local network.

Modulation types are QPSK and 16QAM. The modulation rate may be fixed or adaptive.

In normal operating mode the connections to the equipment are Ethernet. Management interfaces are available for management purposes.

2.8 Method of Monitoring EUT Operation

Visual indication of link status is given by LEDs on the WT Interface Unit. A flashing green “ETHER” LED and absence of a red “ALM” LED indicate that an RF is established and traffic is passing between the WT and associated AP.

If appropriately connected to Ethernet-enabled network devices (i.e. PCs) the connection state can be determined by a number of methods including using the PING command.

Remote monitoring is available through a management application.

2.9 Modifications

2.9.1 Modifications to EUT

No modifications were made to the EUT.

2.9.2 Modifications to Test Standard

No modifications were made to the test standard.

2.10 Disposition of EUT

The test sample including all support equipment (if any), submitted to the Electro-Magnetic Compatibility Lab for testing was returned to Tomen Electronics Corp. upon completion of testing.



3.0 Electromagnetic Compatibility Emission Criteria

3.1 Conducted Emission Limits

Test Requirement(s): **15.107 (a)** “Except for Class A digital devices, for equipment that is designed to be connected to the public utility (AC) power line, the radio frequency voltage that is conducted back onto the AC power line on any frequency or frequencies within the band 150 kHz to 30 MHz shall not exceed the limits in Table 5. Compliance with this provision shall be based on the measurement of the radio frequency voltage between each power line and ground at the power terminals.”

15.107 (b) “For a Class A digital device that is designed to be connected to the public utility (AC) power line, the radio frequency voltage that is conducted back onto the AC power line on any frequency or frequencies within the band 150 kHz to 30 MHz shall not exceed the limits in Table 5. Compliance with this provision shall be based on the measurement of the radio frequency voltage between each power line and ground at the power terminals. The lower limit applies at the band edges.”

Frequency range (MHz)	15.107(b), Class A Limits (dBµV)		15.107(a), Class B Limits (dBµV)	
	Quasi-Peak	Average	Quasi-Peak	Average
* 0.15 – 0.5	79	66	66 - 56	56 - 46
0.5 - 5.0	73	60	56	46
5.0 – 30.0	73	60	60	50

Note 1 — The lower limit shall apply at the transition frequencies.
Note 2 — The limit decreases linearly with the logarithm if the frequency in the range 0.15 MHz to 0.5 MHz.
* — The FCC issued a Recommended Opinion and Order (RO&O) 989-80 in May 2002, providing transition into the emission limits and frequency ranges shown above.

Table 5. Conducted Limits for Radio Frequency Devices calculated from FCC Part 15 Section 15.107(a) (b)



Test Procedures: The EUT was placed on a 0.8 m high wooden table inside a shielded enclosure (See Photograph 1). The EUT was situated such that the back of the EUT was 0.4 m from one wall of the shielded enclosure, and the remaining sides of the EUT were no closer than 0.8 m from any other conductive surface.

The EUT was powered from a 50 Ω /50 μ H Line Impedance Stabilization Network (LISN).

The EMC receiver scanned the frequency range from 150 kHz to 30 MHz. Conducted Emissions measurements were made in accordance with ANSI C63.4-2001 "Methods and Measurements of Radio-Noise Emissions from Low-Voltage Electrical and Electronic Equipment in the Range of 9 kHz to 40 GHz". The measurements were performed over the frequency range of 150 kHz to 30 MHz using a 50 Ω /50 μ H LISN as the input transducer to an EMC field intensity meter.

Test Results: The EUT complies with the Class B requirements of this section.

Test Engineer(s): Jeffrey Hazen

Test Date(s): 03/30/05



Conducted Emissions - Voltage, Worst Case Emissions, AC Power, Phase Line (120 Vac)

Frequency (MHz)	Quasi-Peak Amplitude (dBµV)	Quasi-Peak Limit (dBµV)	Quasi-Peak Margin (dBµV)	Average Amplitude (dBµV)	Average Limit (dBµV)	Average Margin (dBµV)
2.72	47.5	56	-8.5	39.7	46	-6.3
3.173	48	56	-8	38.4	46	-7.6
3.362	47.8	56	-8.2	39.2	46	-6.8
3.4	48	56	-8	38.1	46	-7.9
3.4	47.3	56	-8.7	38.1	46	-7.9
3.589	48.1	56	-7.9	38.6	46	-7.4

Table 6. Conducted Emissions - Voltage, Worst Case Emissions, AC Power, Phase Line

Conducted Emissions - Voltage, Worst Case Emissions, AC Power, Neutral Line, (120 Vac)

Frequency (MHz)	Quasi-Peak Amplitude (dBµV)	Quasi-Peak Limit (dBµV)	Quasi-Peak Margin (dBµV)	Average Amplitude (dBµV)	Average Limit (dBµV)	Average Margin (dBµV)
2.531	44.8	56	-11.2	41.2	46	-4.8
2.91	44.3	56	-11.7	41.2	46	-4.8
2.946	44.9	56	-11.1	41.4	46	-4.6
3.172	44.8	56	-11.2	41.4	46	-4.6
3.323	44.4	56	-11.6	40.7	46	-5.3
3.362	44.6	56	-11.4	41.5	46	-4.5
3.399	44.7	56	-11.3	41.8	46	-4.2
3.549	44.6	56	-11.4	41.2	46	-4.8
3.624	44.9	56	-11.1	41	46	-5
3.814	44.7	56	-11.3	41	46	-5

Table 7. Conducted Emissions - Voltage, Worst Case Emissions, AC Power, Neutral Line



Conducted Emissions - Voltage, Worst Case Emissions, AC Power, (120 Vac)

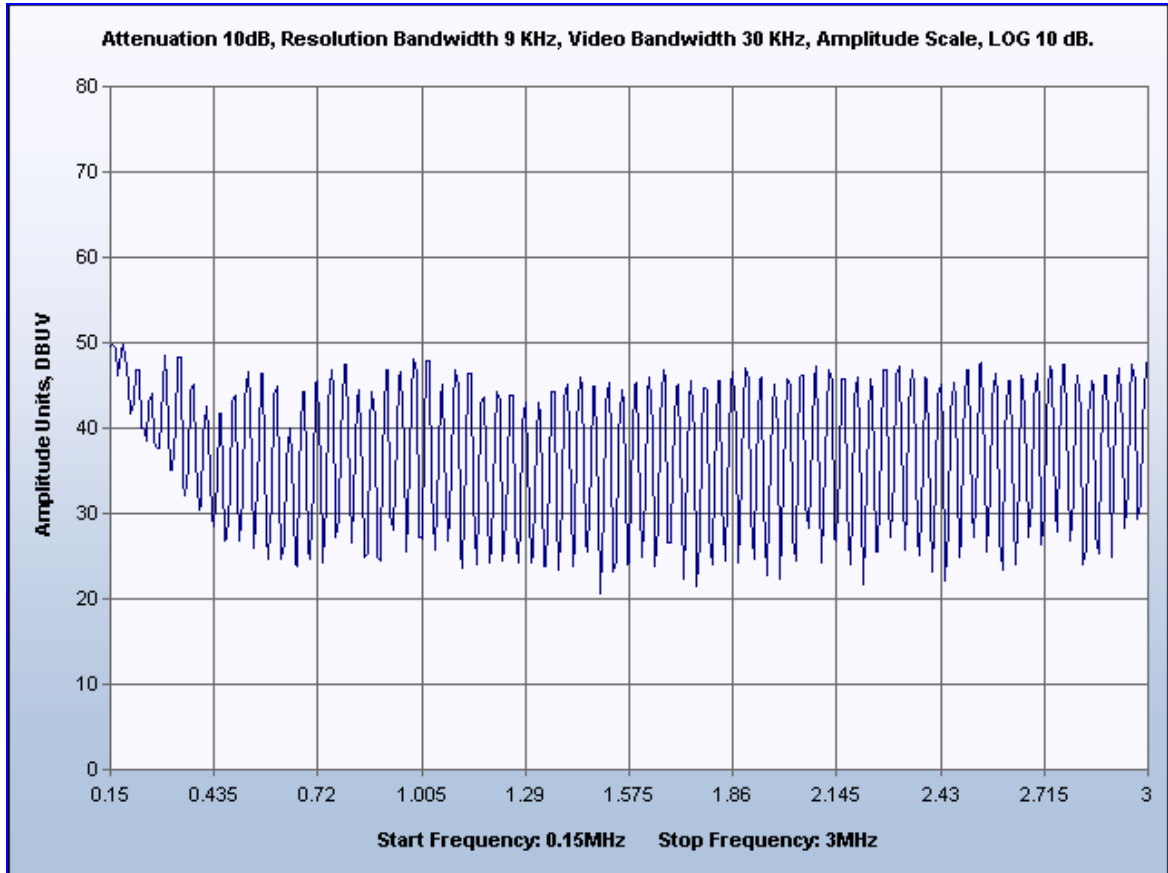

Conducted Emission, Phase Line Plots



Conducted Emissions - Voltage, Worst Case Emissions, AC Power, (120 Vac)

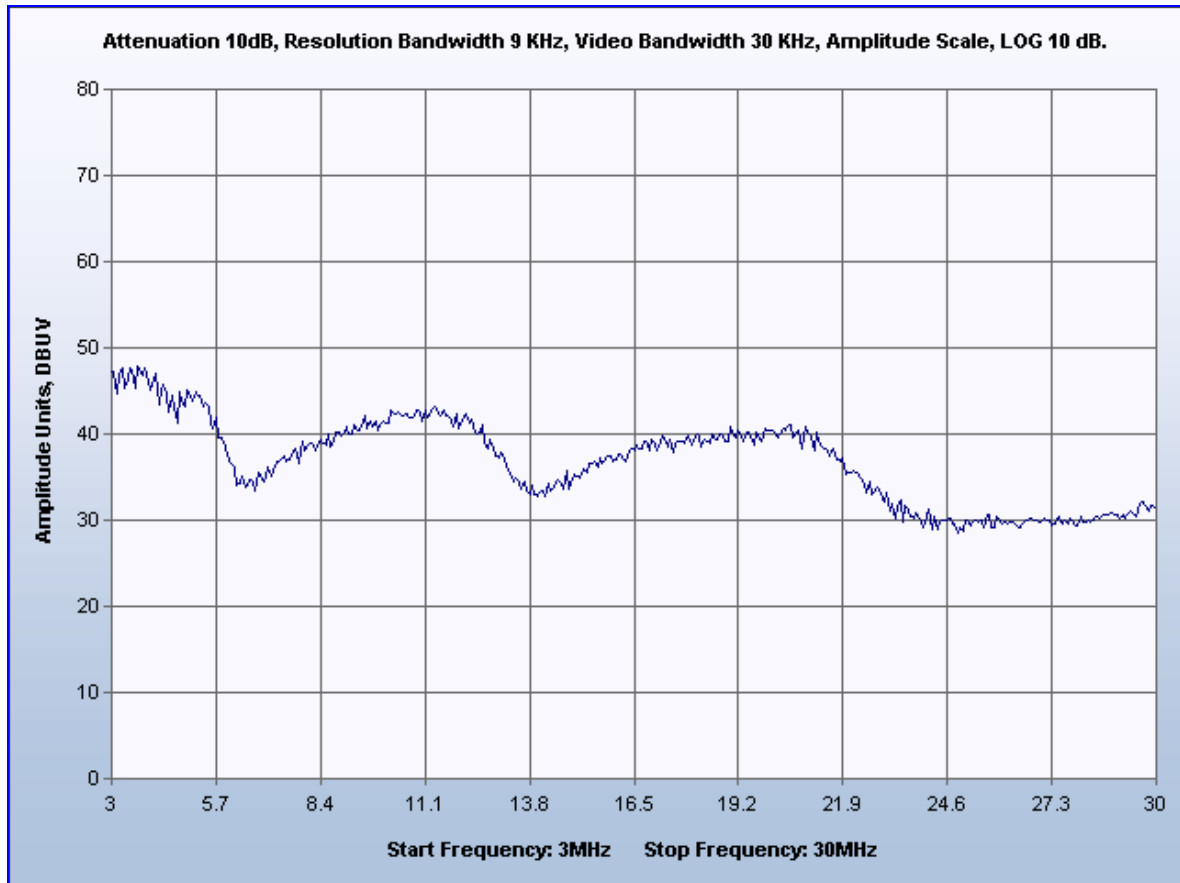

Conducted Emission, Phase Line Plots



Conducted Emissions - Voltage, Worst Case Emissions, AC Power, (120 Vac)

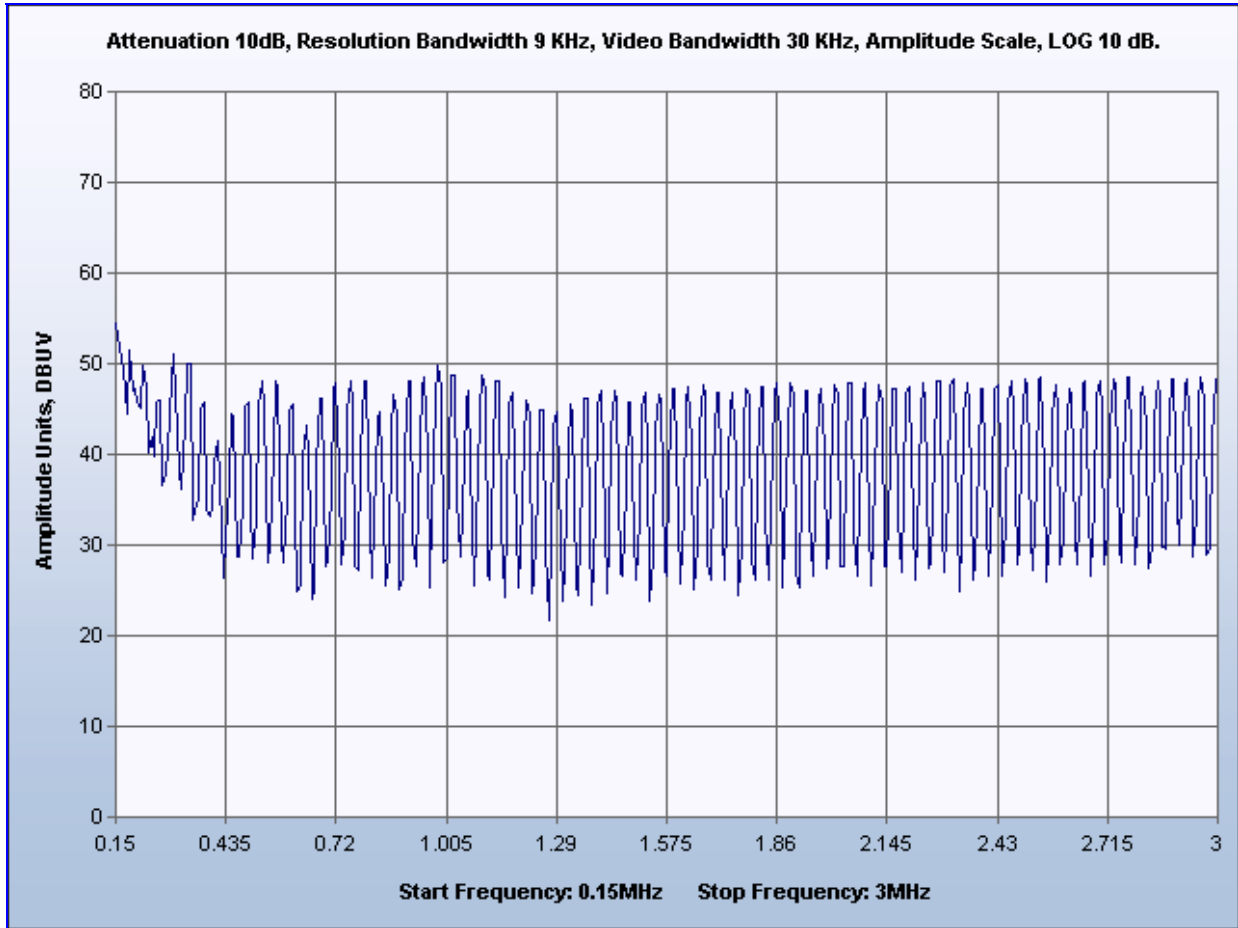

Conducted Emission, Neutral Line Plots



Conducted Emissions - Voltage, Worst Case Emissions, AC Power, (120 Vac)

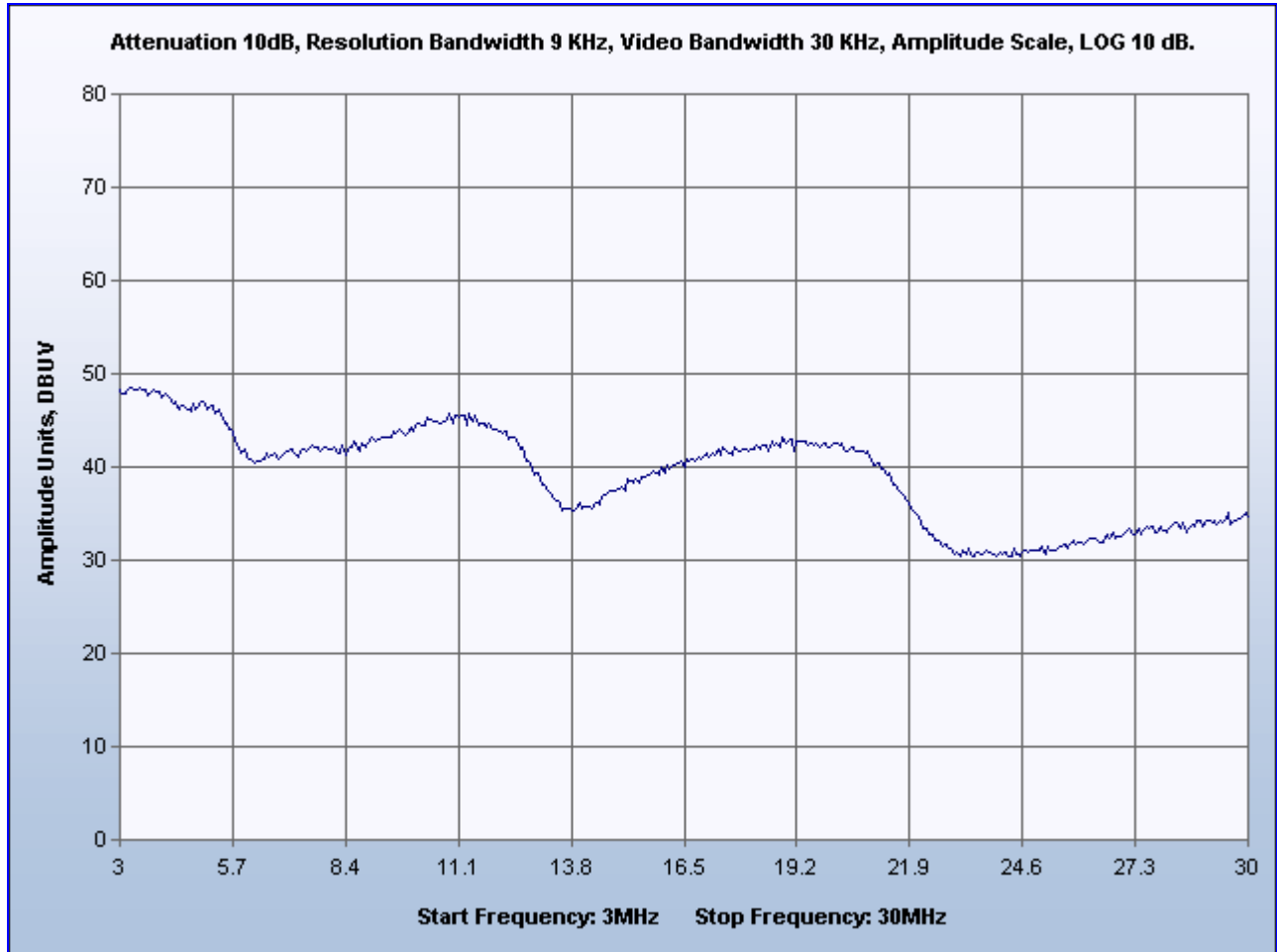

Conducted Emission, Neutral Line Plots

Conducted Emission Test Setup



Photograph 1. Conducted Emissions Test Setup



3.2 Radiated Emission Limits

Test Requirement(s): **15.109(a)** Except for Class A digital devices, the field strength of radiated emissions from unintentional radiators at a distance of 3 meters shall not exceed the Class B limits expressed in Table 8.

15.109 (b) The field strength of radiated emissions from a Class A digital device, as determined at a distance of 10 meters, shall not exceed the Class A limits expressed in Table 8.

Frequency (MHz)	Field Strength (dBµV/m)	
	§ 15.109 (b), Class A Limit (dBµV) @ 10m	§ 15.109 (a), Class B Limit (dBµV) @ 3m
30 - 88	39.00	40.00
88 - 216	43.50	43.50
216 - 960	46.40	46.00
Above 960	49.50	54.00

Table 8. Radiated Emissions Limits calculated from FCC Part 15, § 15.109 (a) (b)

Test Procedures: The EUT was placed on a 0.8 m high wooden table (See Photograph 2 and Photograph 3). Various antennas were placed near the EUT and measurements were taken of the field strengths and frequencies.

For final radiated measurements, the EUT was placed in semi-anechoic chamber, and located 3 m from an adjustable antenna mast. For pre-scanning, the spectrum analyzer scanned the frequency range from 30 MHz to 1 GHz to obtain an emission profile of the EUT.

For each point of measurement, the turntable was rotated, and the antenna height was varied between 1 m and 4 m, in order to find the maximum radiated emissions. Measurements above 30 MHz were taken using this technique with the antenna in two polarizations: horizontal and vertical.

Unless otherwise specified, measurements were made using a quasi-peak detector with a 120 kHz bandwidth for below 1 GHz. For above 1 GHz, measurements were made using an average detector with a 1 MHz Resolution bandwidth and 10 Hz Video bandwidth.

Test Results: The EUT was complies with the Class B requirements of this section.

Test Engineer(s): Liming Xu

Test Date(s): 04/22/05



Radiated Emissions Limits Test Results, Class B (30MHz to 1GHz)

Frequency (MHz)	EUT Azimuth (Degrees)	Antenna Polarity (H/V)	Antenna Height (m)	Uncorrected Amplitude (dBuv)	Antenna Correction Factor (dB) (+)	Cable Loss (dB) (+)	Distance Correction Factor (dB) (-)	Corrected Amplitude (dBuv)	Limit (dBuv)	Margin (dB)
31.600	3.4	H	70.00	11.70	6.55	1.32	0.00	19.57	40.00	-20.43
31.600	1	V	70.00	25.56	6.18	1.32	0.00	33.07	40.00	-6.93
37.480	2.8	H	70.00	7.80	8.65	1.41	0.00	17.86	40.00	-22.14
37.480	1	V	0.00	21.59	8.10	1.41	0.00	31.10	40.00	-8.90
92.600	2.3	H	0.00	10.00	7.11	2.21	0.00	19.32	43.50	-24.18
92.600	1	V	0.00	17.04	7.24	2.21	0.00	26.50	43.50	-17.00
150.000	1.9	H	0.00	16.58	8.10	2.65	0.00	27.33	43.50	-16.18
150.000	1	V	0.00	19.49	8.20	2.65	0.00	30.34	43.50	-13.17
480.000	1.4	H	0.00	13.32	17.00	4.38	0.00	34.70	46.00	-11.30
480.000	1	V	0.00	16.91	17.50	4.38	0.00	38.79	46.00	-7.21
500.000	1.5	H	0.00	13.42	17.10	4.44	0.00	34.96	46.00	-11.04
500.000	1	V	0.00	13.32	17.50	4.44	0.00	35.26	46.00	-10.74

Table 9. Radiated Emissions Limits Test Results (30MHz to 1GHz)

Note 1: The EUT was tested at 3 m.

Note 2: There are no detectable emissions between 500MHz and 260GHz.

Radiated Emission Limits Test Setup

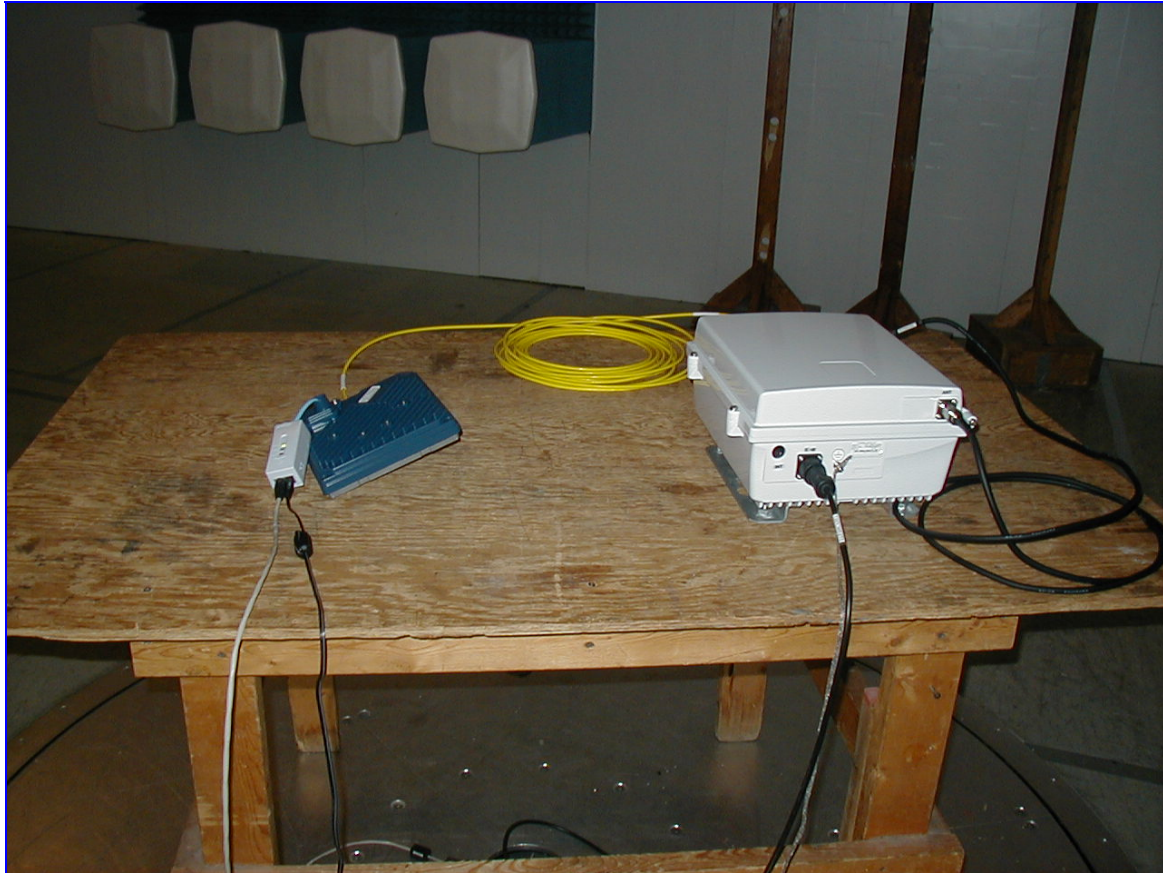

Photograph 2. Radiated Emission Limits Test Setup

Radiated Emission Limits Test Setup



Photograph 3. Radiated Emission Limits Test Setup



4.0 Test Equipment

Calibrated test equipment utilized during testing was maintained in a current state of calibration per the requirements of ANSI/NCSL Z540-1-1994 and ANSI/ISO/IEC 17025:2000.

Test Name: Conducted Emissions				Test Date(s): 03/30/05	
MET Asset #	Nomenclature	Manufacturer	Model	Last Cal Date	Cal Due Date
1T4300	Semi-anechoic Chamber # 1	EMC Test Systems	None Listed	05/03/2003	04/03/2006
1T4300	Semi-anechoic Chamber # 1 C	Due FCC Update	None listed	05/03/2003	04/03/2006
1T4300	Semi-anechoic Chamber # 1 D	Due Industry Canada	NONE	05/03/2003	04/03/2006
1T4156	Spectrum Analyzer AMC	HP	8594EM	11/29/2004	11/29/2005
1T4212	LISN; Switch	Solar Electronics Co.	9252-R-24-BNC	11/15/2004	11/15/2005
1T4462	Thermo-Hygrometer	Fisher Scientific	11-661-7D	11/08/2004	11/08/2006
Test Name: Radiated Emissions				Test Date(s): 04/22/05	
MET Asset #	Nomenclature	Manufacturer	Model	Last Cal Date	Cal Due Date
1T4300	Semi-anechoic Chamber # 1	EMC Test Systems	NONE	05/03/2003	04/03/2006
1T4303	Antenna; BILOG	Schafner – Chase EMC	CBL6140A	04/22/2004	04/22/2005
1T4409	EMI Receiver	Rhode & Schwars	ESP17	04/08/2004	04/08/2005

Table 10. Test Equipment



5.0 Compliance Information

The following text excerpts are from the Code of Federal Regulations, Title 47, Part 2 and 15.

§ 2.1073 Responsibilities

(a) The responsible party, as defined in Section 2.909 of this part, must warrant that each unit of equipment marketed under a Declaration of Conformity is identical to the unit tested and found acceptable with the standards and that the records maintained by the responsible party continue to reflect the equipment being produced under the Declaration of Conformity within the variation that can be expected due to quantity production and testing on a statistical basis.

(b) The responsible party, if different from the manufacturer, may upon receiving a written statement from the manufacturer that the equipment complies with the appropriate technical standard rely on the manufacturer or independent testing agency to determine compliance. However, the test records required in Section 2.1075 of this part shall be in the English language and shall be made available to the Commission upon a reasonable request in accordance with the provisions of Section 2.1076 of this part.

(c) In the case of transfer of control of the equipment, as in the case of sale or merger of the responsible party, the new responsible party shall bear the responsibility of continued compliance of the equipment.

(d) Equipment shall be retested to demonstrate continued compliance with the applicable technical standards if any modifications or changes that could adversely affect the emanation characteristics of the equipment are made by the responsible party. The responsible party bears responsibility for the continued compliance of subsequently produced equipment.

(e) If any modifications or changes are made by anyone other than the responsible party for the Declaration of Conformity, the party making the modifications or changes, if located within the U.S., becomes the new responsible party. The new responsible party must comply with all the provisions for the Declaration of Conformity, including having test data on file demonstrating that the product continues to comply with all of the applicable technical standards.

§ 2.1074 Identification

Devices subject only to a Declaration of Conformity shall be uniquely identified by the responsible party. This identification shall not be of a format which could be confused with the FCC Identifier required on certified, notified, type accepted, or type approved equipment. The responsible party shall maintain adequate identification records to facilitate positive identification for each device.



§ 2.1077 Compliance information

- (a) If a product must be tested and authorized under a Declaration of Conformity, A COMPLIANCE INFORMATION STATEMENT SHALL BE SUPPLIED WITH THE PRODUCT AT THE TIME OF MARKETING OR IMPORTATION, containing the following information:
 - (1) Identification of the product, e.g., name and model number;
 - (2) A statement, similar to that contained in §15.19(a)(3) of this chapter, that the product complies with part 15 of this chapter; and
 - (3) The identification, by name, address, and telephone number, of the responsible party, as defined in §2.909. The responsible party for Declaration of Conformity must be located in the United States.
- (b) If a product is assembled from modular components that, by themselves, are authorized under a Declaration of Conformity and/or a grant of certification, and the assembled product is also subject to authorization under a Declaration of Conformity but, in accordance with the applicable regulations does not require additional testing, the product shall be supplied, at the time of marketing or importation, with a compliance information statement containing the following information:
 - (1) Identification of the assembled product, e.g., name and model number.
 - (2) Identification of the modular components used in the assembly. A modular component authorized under a Declaration of Conformity shall be identified as specified in paragraph (a)(1) of this section. A modular component authorized under a grant of certification shall be identified by name and model number (if applicable) along with the FCC Identifier number.
 - (3) A statement that the product complies with part 15 of this chapter.
 - (4) The identification, by name, address, and telephone number, of the responsible party who assembled the product from modular components, as defined in § 2.909. The responsible party for a Declaration of Conformity must be located within the United States.
 - (5) Copies of the compliance information statements for each modular components used in the system that is authorized under a Declaration of Conformity.
- (c) The compliance information statement shall be included in the user's manual or as a separate sheet.

§ 15.3 Definitions

- (a) **Peripheral Device** An input/output unit of a system that feeds data into and/or receives data from the central processing unit of a digital device. Peripherals to a digital device include any device that is connected external to the digital device, any device internal to the digital device that connects the digital device to an external device by wire or cable, and any circuit board designed for interchangeable mounting, internally or externally, that increases the operating or processing speed of a digital device, e.g., "turbo" cards and "enhancement" boards. Examples of peripheral devices include terminals, printers, external floppy disk drives and other data storage devices, video monitors, keyboards, interface boards, external memory expansion cards, and other input/output devices that may or may not contain digital circuitry. This definition does not include CPU boards, as defined in paragraph (bb) of this section, even though a CPU board may connect to an external keyboard or other components.
- (b) **CPU Board** A circuit board that contains a microprocessor, or frequency determining circuitry for the microprocessor, the primary function of which is to execute user-provided programming, but not including: (1) a circuit board that contains only a microprocessor intended to operate under the primary control or instruction of a microprocessor external to such a circuit board: or (2) a circuit board that is a dedicated controller for a storage or input/output device.



5.1 Label and User's Manual Information

§ 15.19 Labeling requirements

- (a) (4) Where a device is constructed in two or more sections connected by wires and marketed together, a statement specified under paragraph (a) of this section is required to be affixed only to the main control unit.

(5) When a device is so small or for such use this is not practicable to place the statement specified under paragraph (a) of this section on it, the information required by this paragraph shall be placed in a prominent location in the instruction manual or pamphlet supplied to the user or, alternatively, shall be placed on the container in which the device is marketed. However, the FCC identifier or the unique identifier, as appropriate, must be displayed on the device.

- (b) Products subject to authorization under the Declaration of Conformity shall be labeled as follows:

- (1) The label shall be located in a conspicuous location on the device and shall contain the unique identification described in Section 2.1074 of this chapter and the following logo:
- (i) If the product is authorized based on testing of the product or system:
 - (ii) If the product is authorized based on assembly using separately authorized components and the resulting product is not separately tested:

(2) When the device is so small or for such use that it is not practicable to place the statement specified under paragraph (b)(1) of this section on it, such as for a CPU board or a plug-in circuit board peripheral device, the text associated with the logo may be placed in a prominent location in the instruction manual or pamphlet supplied to the user. However, the unique identification (trade name and model number) and the logo must be display on the device.

(3) The label shall not be a stick-on, paper label. The label shall be permanently affixed to the product and shall be readily visible to the purchaser at the time of purchase. "Permanently affixed" means that the label is etched, engraved, stamped, silk-screened, indelibly printed or otherwise permanently marked on a permanent attached part of the equipment or on a nameplate of metal, plastic, or other material fastened to the equipment by welding, riveting or a permanent adhesive. The label must be designed to last the expected lifetime of the equipment in the environment in which the equipment may be operated and must not be readily detachable. Reference new Section 15.19(b)(3).

**DECLARATION OF CONFORMITY LABELLING REQUIREMENTS
FOR PERSONAL COMPUTERS AND PERSONAL COMPUTER PERIPHERALS**

The labeling requirements below apply only to personal computers and personal computer peripherals that are self-authorized under the Declaration of Conformity procedure.

Required label formats

Label A is required if the device is authorized based on testing of the product or system. **Label B** is required if the device is authorized based on assembly using separately authorized components and the resulting device is not separately tested. Refer to new Sections 15.19(b)(1) - (b)(1)(i).

**Alternate label format for
small devices**

The FCC logo, trade name and model number must be shown on the product. The text shown in *bold-face italics* may be placed in a prominent location in the instruction manual or pamphlet supplied to the user. Refer to the new Section 15.19(b)(2).

Trade Name Model Number



**Tested to Comply
with FCC Standards**

FOR HOME OR OFFICE USE



Trade Name Model Number

*Tested To Comply
With FCC Standards
FOR HOME OR OFFICE USE*

Trade Name Model Number



**Assembled From
Tested Components
(Complete System Not Tested)**

FOR HOME OR OFFICE USE



Trade Name Model Number

*Assembled From
Tested Components
(Complete System Not Tested)
FOR HOME OR OFFICE USE*



§ 15.21 Information to user.

The users manual or instruction manual for an intentional or unintentional radiator shall caution the user that changes or modifications not expressly approved by the party responsible for compliance could void the user's authority to operate the equipment.

§ 15.32 Test Procedures for CPU boards and computer power supplies

Power supplies and CPU boards used with personal computers and for which separate authorizations are required to be obtained shall be tested as follows:

(a) CPU boards shall be tested as follows:

(1) Testing for radiated Emissions shall be performed with the CPU board installed in a typical enclosure but with the enclosure's cover removed so that the internal circuitry is exposed at the top and on at least two sides. Additional components, including a power supply, peripheral devices, and subassemblies, shall be added, as needed, to result in a complete personal computer system. If the oscillator and the microprocessor circuits are contained on separate circuit boards, both boards, typical of the combination that would normally be employed, must be used in the test. Testing shall be in accordance with the procedures specified in Section 15.31 of this part. Under these test conditions, the system under test shall not exceed the radiated emission limits specified in Section 15.109 of this part by more than 3dB.

(2) Unless the test in paragraph (a)(1) of this section demonstrates compliance with the limits in Section 15.109 of this part, a second test shall be performed using the same configuration described above but with the cover installed on the enclosure. Testing shall be in accordance with the procedures specified in Section 15.31 of this part. Under these test conditions, the system under test shall not exceed the radiated emission limits specified in Section 15.109 of this part.

(3) The test demonstrating compliance with the AC power line conducted limits specified in Section 15.107 of this part shall be performed in accordance with the procedures specified in Section 15.31 using an enclosure, peripherals, power supply, and subassemblies that are typical of the type with which the CPU board under test would normally be employed.

(b) The power supply shall be tested installed in an enclosure that is typical of the type within which it would normally be installed. Additional components, including peripheral devices, a CPU board, and subassemblies, shall be added, as needed, to result in a complete personal computer system. Testing shall be in accordance with the procedures specified in Section 15.31 and must demonstrate compliance with all of the standards contained in this part.

§ 15.105 Information to the user.

(a) For a Class A digital device or peripheral, the instructions furnished the user shall include the following or similar statement, placed in a prominent location in the text of the manual:

NOTE: This equipment has been tested and found to comply with the limits for a Class A digital device, pursuant to part 15 of the FCC Rules. These limits are designed to provide reasonable protection against harmful interference when the equipment is operated in a commercial environment. This equipment generates, uses, and can radiate radio frequency energy and, if not installed and used in



accordance with the instruction manual, may cause harmful interference to radio communications. Operation of this equipment in a residential area is likely to cause harmful interference in which case the user will be required to correct the interference at his own expense.

(b) For a Class B digital device or peripheral, the instructions furnished to the user shall include the following or similar statement, placed in a prominent location in the text of the manual:

NOTE: This equipment has been tested and found to comply with the limits for a Class B digital device, pursuant to part 15 of the FCC Rules. These limits are designed to provide reasonable protection against harmful interference in a residential installation. This equipment generates, uses and can radiate radio frequency energy and, if not installed and used in accordance with the instructions, may cause harmful interference to radio communications. However, there is no guarantee that interference will not occur in a particular installation. If this equipment does cause harmful interference to radio or television reception, which can be determined by turning the equipment off and on, the user is encouraged to try to correct the interference by one or more of the following measures:

- Reorient or relocate the receiving antenna.
- Increase the separation between the equipment and receiver.
- Connect the equipment into an outlet on a circuit different from that to which the receiver is connected.
- Consult the dealer or an experienced radio/TV technician for help.

(c) The provisions of paragraphs (a) and (b) of this section do not apply to digital devices exempted from the technical standards under the provisions of § 15.103.

(d) For systems incorporating several digital devices, the statement shown in paragraph (a) or (b) of this section needs to be contained only in the instruction manual for the main control unit.