

SECTION 4 MEASUREMENT OF RANGE AND BEARING

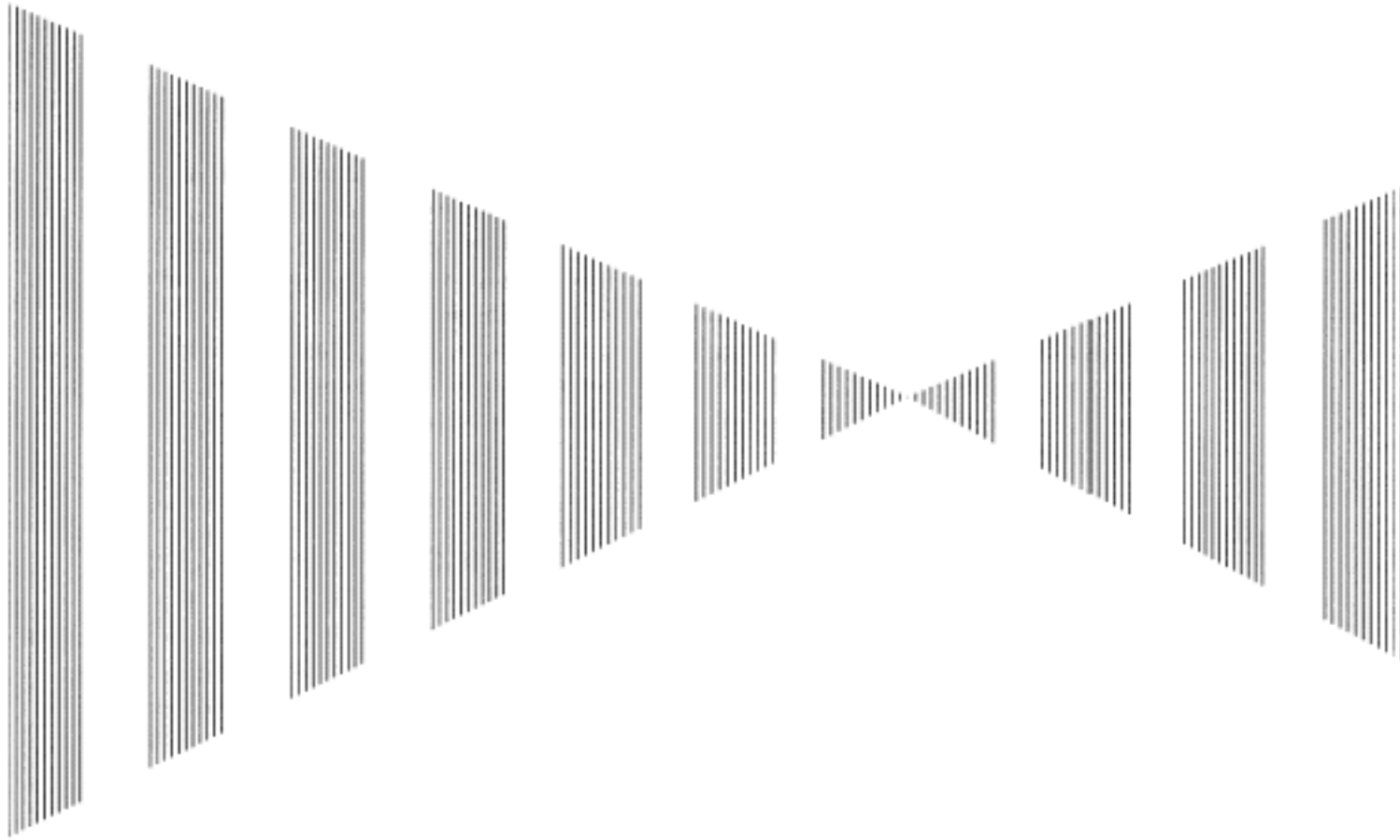

4.1	Measurement by Trackball	4-1
4.2	Measurement by Range Rings	4-2
4.3	Measurement by EBLs and VRMs	4-3
4.4	Measurement between Two Optional Points.	4-5

4.1 MEASUREMENT BY TRACKBALL

- Procedures**
- 1 Check the target echoes on the radar display.
 - 2 Move the cursor mark to a target by the trackball.

The **CURSOR** on the radar display indicates the bearing and range of the target.
The range is a distance from own ship's position.

CURSOR ()

TRUE 45.0°: True bearing of the cursor relative to own ship

5.0nm: Range between the cursor and own ship

REL 45.0°: Relative bearing of the cursor relative to own ship

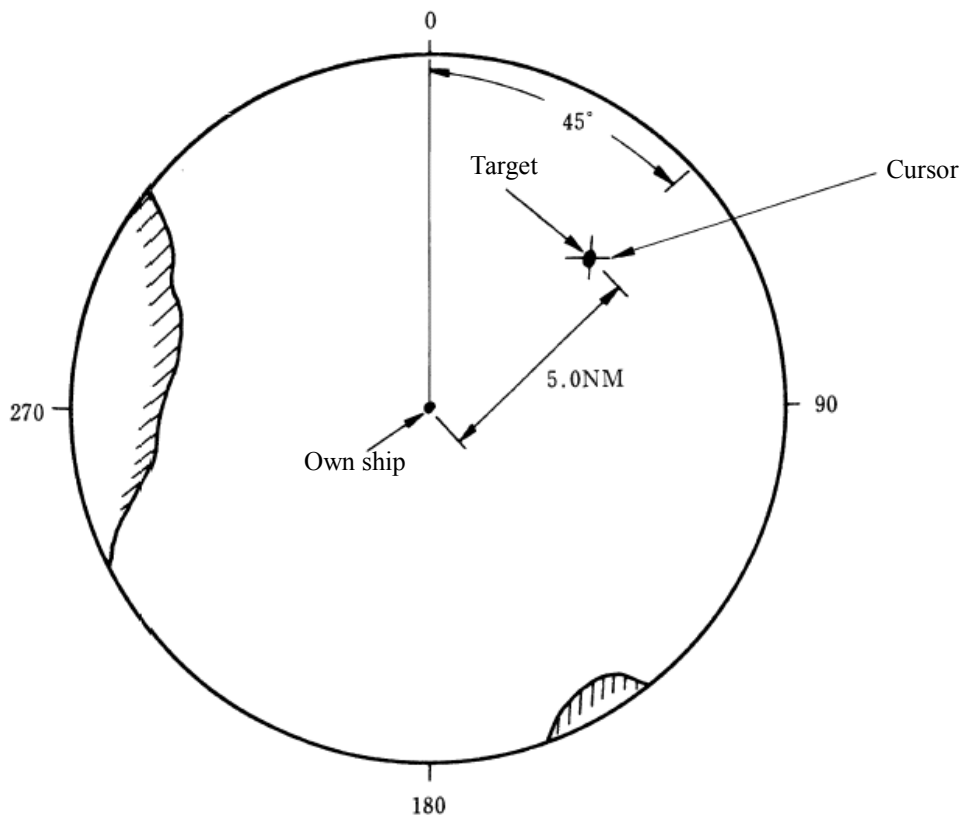

Figure 4.1

4.2

MEASUREMENT BY RANGE RINGS

Procedures

1 Press [RR/HL] key.

The Range Rings will appear on the radar display.

The range between the target and own ships can be determined by visually measuring the target's position that lies between two range rings.

(The range ring interval is fixed and indicated within the radar display ② on page 2-9.)

4.3

MEASUREMENT BY EBLs AND VRMS • •

Procedures

- 1 **Press [EBL1] key to select EBL1 display and operation.**

The EBL1 indication at the lower right of the radar display will be selected and the EBL1 will appear as a broken-line on the PPI display.

- 2 **Turn the [EBL] control to put EBL1 on a target.**

The bearing of the EBL1 will appear at the lower right of the radar display. The EBL1 bearing represents the target's bearing.

- 3 **Press [VRM1] key to select VRM1 display and operation.**

The VRM1 indication at the lower right of the radar display will be selected and the VRM1 will appear as a broken-line circle on the PPI display.

- 4 **Move the broken-line VRM1 to the target by using the [VRM] control.**

The range of the VRM1 from own ship will appear at the lower right of the radar display. The range of VRM1 signifies a distance between the target and own ship.

Refer to **Figure 4.2** in the next page.

In this **Figure 4.2**, the range and bearing are;

Range: 5.0nm

Bearing: 45.0°

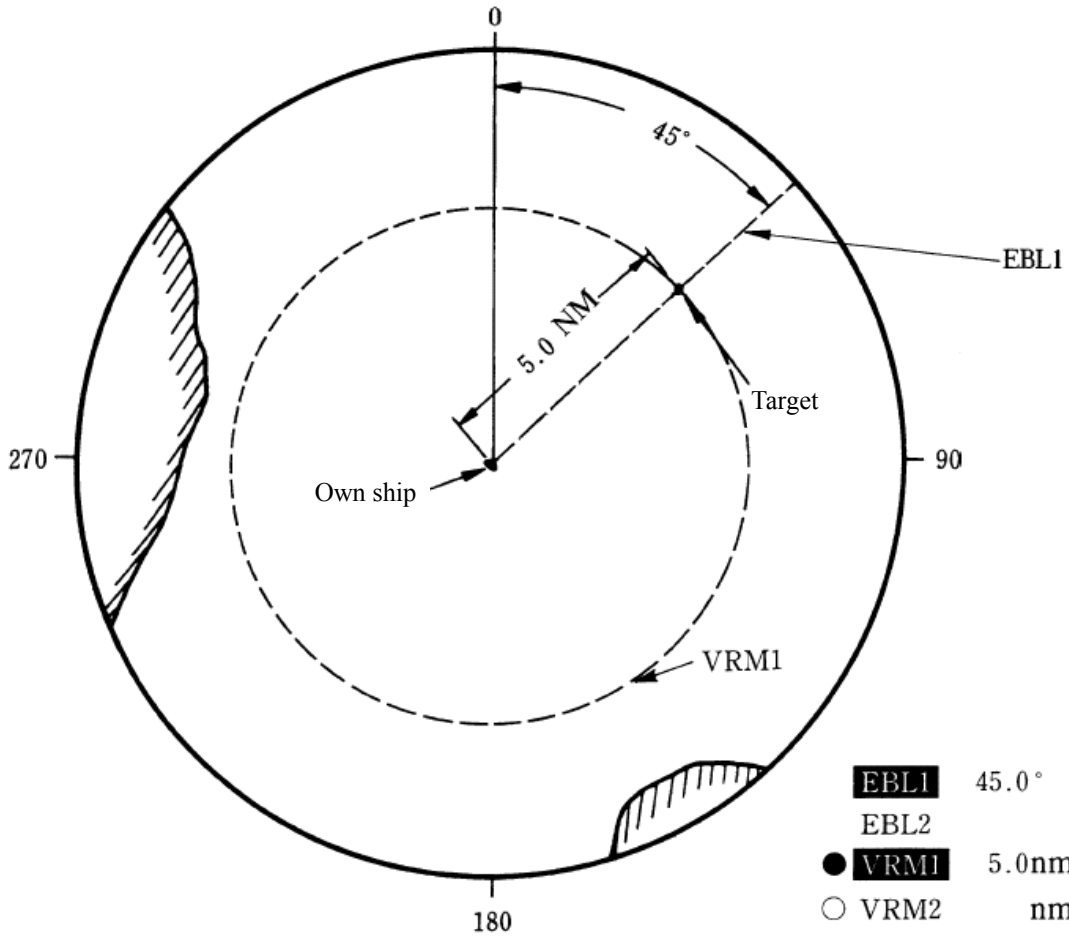

4

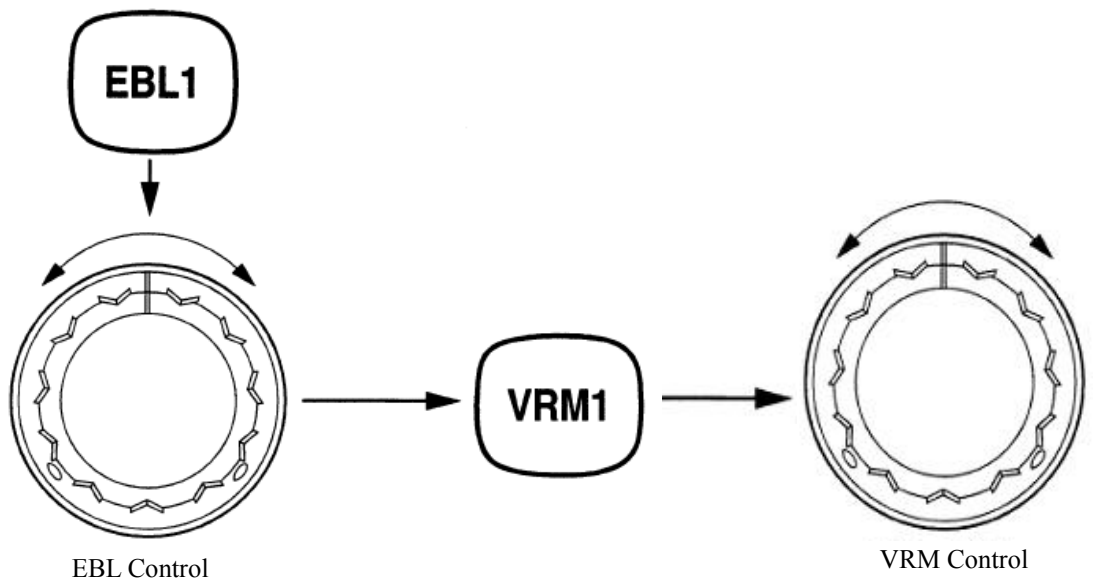

4.4

MEASUREMENT BETWEEN TWO OPTIONAL POINTS

Procedures

- 1 Press [EBL2] key to select EBL2 display and operation.

The EBL2 indication at the lower right of the radar display will be selected and the EBL2 will appear as a dotted-line on the PPI display.

- 2 Point the cursor to the C switch of EBL2 at the lower right of the radar display, and press [ENT] key. The EBL cursor mode changes each time O or L is pressed.

EBL1	T	123.4	°	C
EBL2	T	004.3	°	C



- 3 Using the trackball, move the starting point of EBL2 to one (A) of the two points and press [ENT] key.

(See Figure 4.3.)

- 4 Turn the [EBL] control to move EBL2 to the other point (B).

(See Figure 4.3.)

- 5 Press [VRM2] key to select VRM2 display and operation.

○ (VRM marker) will appear on a dotted-line of the EBL2.

- 6 Using the [VRM] control, move the VRM2 marker on a dotted-line of EBL2 to the point B.

The bearing and range between the two points will appear in the VRM2 and EBL2 area on the lower right of the radar display.

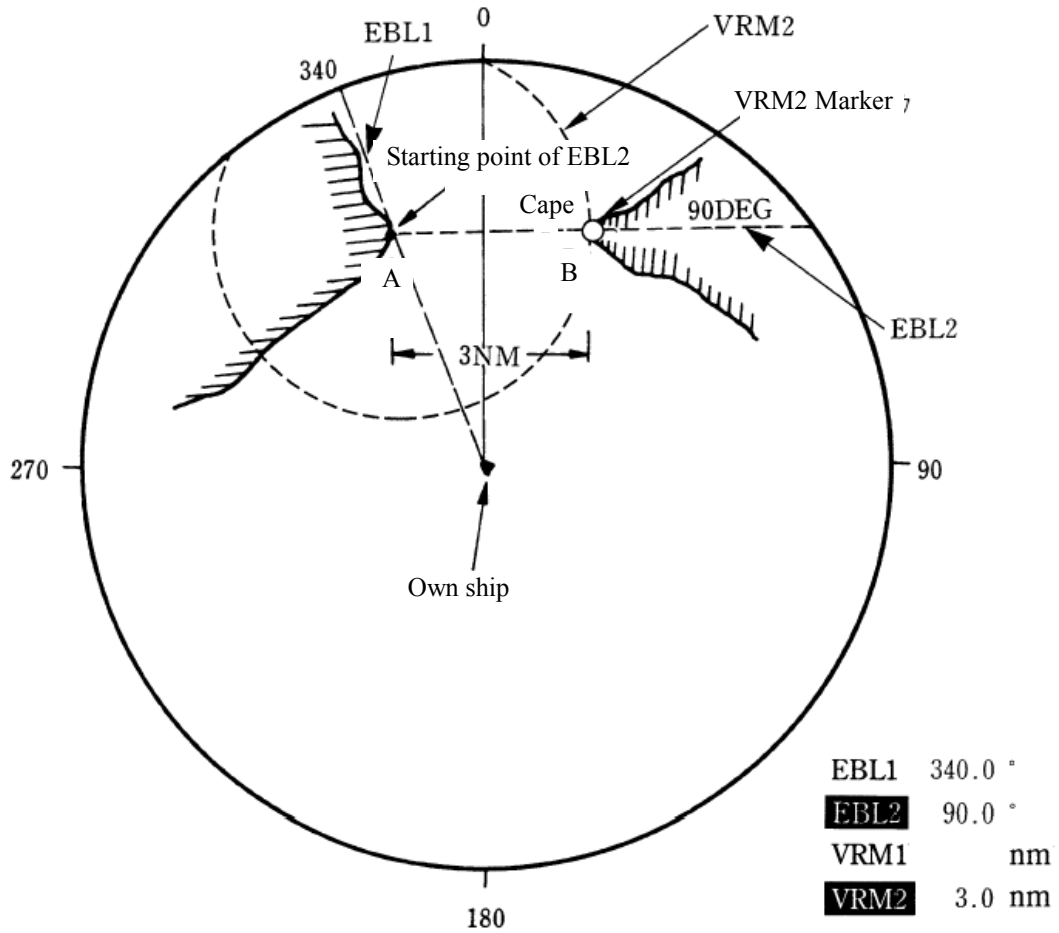

4

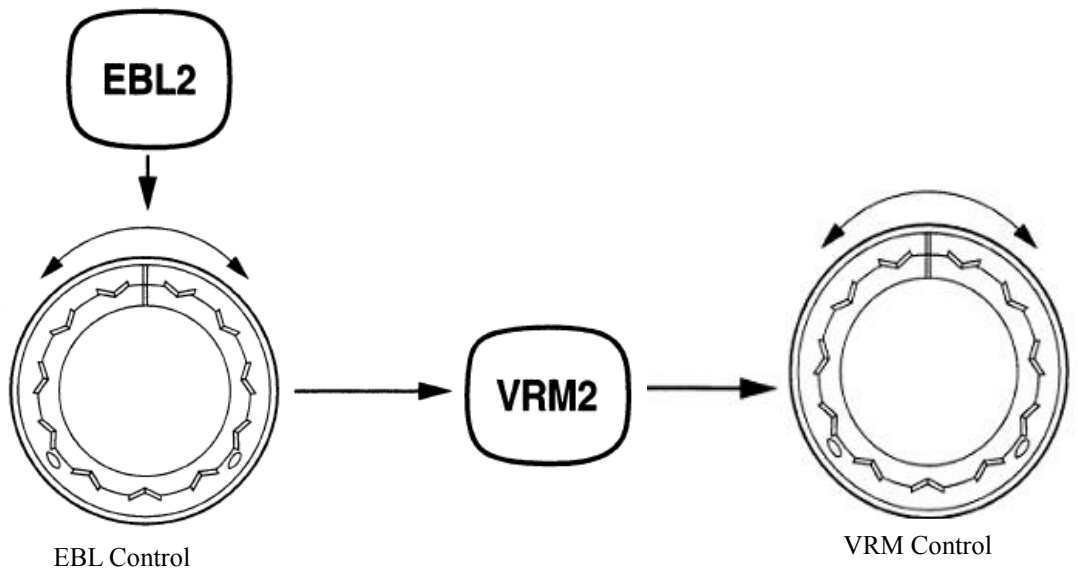
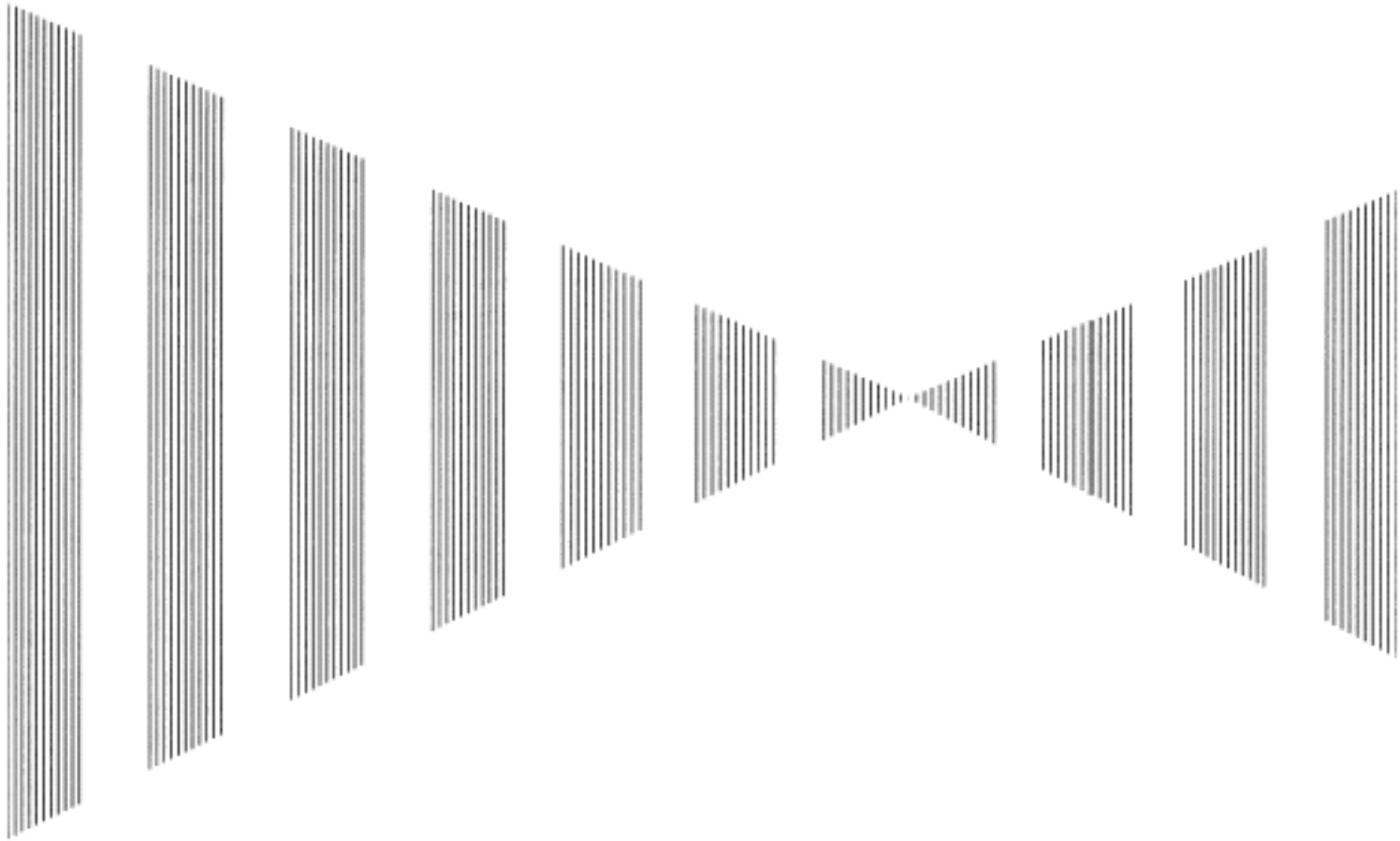

Figure 4.3

It is also possible to use EBL1 instead of EBL2 in measuring the bearing and range between two optional points.
 In this case, read EBL2 as EBL1 and VRM2 as VRM1 in the procedure above, point the cursor to **C** of EBL2 in step 2, and then press [ENT] key.

SECTION 5 OPERATION OF ARPA AND AIS



5.1 PREPARATION	5-2	5.3.6 Alarm Display	5-30
5.1.1 Collision Avoidance	5-4	5.3.7 Trial Maneuvering (Trial)	5-34
5.1.2 Definitions of Symbols	5-7	5.3.8 ATA/ARPA Simulation.....	5-38
5.1.3 Setting Collision Decision Criteria (CPA/TCPA Limit).....	5-9	5.3.9 Setting ATA/ARPA Tracks (ATA Track Setting). 5-44	
5.1.4 Setting Vectors (Vector Time).....	5-10	5.4 AIS OPERATION	5-51
5.1.5 Setting CPA Ring (CPA Ring).....	5-11	5.4.1 Initial Setting.....	5-52
5.1.6 Setting Automatic Acquisition Key Assignment (GZ Alarm Key Setting)	5-12	5.4.2 Setting AIS Display Function (AIS Function)...	5-54
5.2 EPA OPERATION	5-13	5.4.3 Activating AIS Targets	5-55
5.2.1 Plotting Targets	5-13	5.4.4 Deactivating AIS Targets	5-56
5.2.2 Modifying Plotted Target Data	5-14	5.4.5 Setting AIS Symbol Display Function (AIS Symbol Display).....	5-57
5.2.3 Canceling Plotted Target Data.....	5-14	5.4.6 Displaying Numeric Data of AIS Targets	5-58
5.2.4 Displaying Numeric Data of Plotted Targets....	5-15	5.4.7 Setting ATA/ARPA Symbol Display Function (ATA Symbol Display)	5-60
5.2.5 Setting EPA Alarm (Audible Warning).....	5-16	5.4.8 Setting AIS Filter (AIS Filter Setting)	5-61
5.3 ATA/ARPA OPERATION	5-17	5.4.9 Deciding AIS Target and ARPA Target as the Same One (Identical Distance).....	5-64
5.3.1 Acquiring Target.....	5-17	5.4.10 Conditions for Deciding AIS Target to be Lost	5-66
5.3.2 Canceling Unwanted Targets.....	5-19	5.4.11 Displaying AIS Symbols	5-67
5.3.3 Displaying Target ID No. (Target Number Display)	5-20	5.4.12 AIS Alarm Display.....	5-68
5.3.4 ATA/ARPA Data Display	5-21	5.4.13 Restrictions.....	5-69
5.3.5 Target Data Display	5-26		

USAGE OF ARPA

Attention

- There are the following limitations on use of the target acquisition and tracking functions of ARPA.

[I] Resolution between adjacent targets and swapping during automatic tracking

Depending on the particular distance and echo size, resolution between adjacent targets during automatic tracking usually ranges somewhere between 0.03 to 0.05 nm. If multiple targets approach each other, resolution will become about 0.03 nm and this may cause the system to regard them as one target and thus to swap them or lose part of them. Such swapping or loss of targets may also occur if the picture of the target being tracked is affected by rain/snow clutter returns or sea clutter returns or moves very close to land.

[II] Intensity of echoes and the tracking function

The intensity of echoes and the tracking function have a relationship, and thus the target will be lost if no echoes are detected during six scans in succession. If a lost target exists, therefore, radar gain must be increased to support detection of the target. If, however, radar gain is increased too significantly, sea clutter returns or other noise may be erroneously detected and tracked as a target, and resultingly, a false alarm may be issued.

[III] Adverse effects of error sources on automatic tracking

To execute accurate tracking, it becomes necessary first to appropriately adjust the [GAIN], [SEA] and [RAIN] controls of the radar so that the target to be acquired and tracked is clearly displayed on the radar display. Inappropriate settings of these controls reduce the reliability/accuracy of automatic tracking.

5.1 PREPARATION

This section explains the features of EPA/ATA/ARPA and AIS functions, and the initial setting for using each function.

The four plotting functions below are available with this radar equipment.
An optional device is necessary for using each of the ATA, ARPA, and AIS functions.

EPA (Electronic Plotting Aid) function

The EPA function calculates the course and speed of a target from the positions of the target that have been entered manually at specified intervals.

The EPA function is available when the ATA and ARPA options are not installed.

ATA (Automatic Tracking Aid) function

The ATA function calculates the course and speed of a target by automatically tracking the target's move.

The ATA function enables automatic acquisition of targets by using the guard zone function.

The ATA function is available when the ATA option is installed.

(This function cannot be used with the ARPA option.)

ARPA (Automatic Radar Plotting Aid) function

The ARPA function calculates the course and speed of a target by automatically tracking the target's move.

The ARPA function enables automatic acquisition of targets by using the guard zone function.

The ARPA function also enables the simulation of the maneuvering method for avoiding collision by using the trial maneuvering function.

The ARPA function is available when the ARPA option is installed.

The ARPA function provides higher-level functions than the ATA function.

(This function cannot be used with the ATA option.)

AIS (Automatic Identification System) function

The AIS function shows the target's information on the radar display, using other ships' information sent out from the AIS unit.

The AIS function is available when the optional AIS interface is installed.

Attention

- **The menu display is changed to “ATA” or “ARPA” according to option provided in this radar equipment. Where the ARPA option is provided, the ARPA Setting is displayed in the menu. Also where the ATA option is provided, the ATA Setting is displayed in the menu.
This manual basically displays using “ATA”.**

5.1.1 Collision Avoidance

Problems of Collision Avoidance in Navigation

Marine collision avoidance is one of the problems that have been recognized from of old. Now, it will be described briefly who the collision avoidance is positioned among the navigational aid problems.

The navigation pattern of all mobile craft constitutes a system with some closed loops regardless of the media through which the mobile craft travels, whether air, water, the boundary between air and water, or space. This pattern consists of two closed loops in principle, one of which is a collision with another mobile craft and the other is a loop of finding a right and safe way to reach a predeterminate destination. Fig. 5-1 shows the conceptual diagram of navigation pattern by MR. E.W. Anderson. The closed loop of collision avoidance is shown on the left side and the closed loop of finding a right course on the right side.

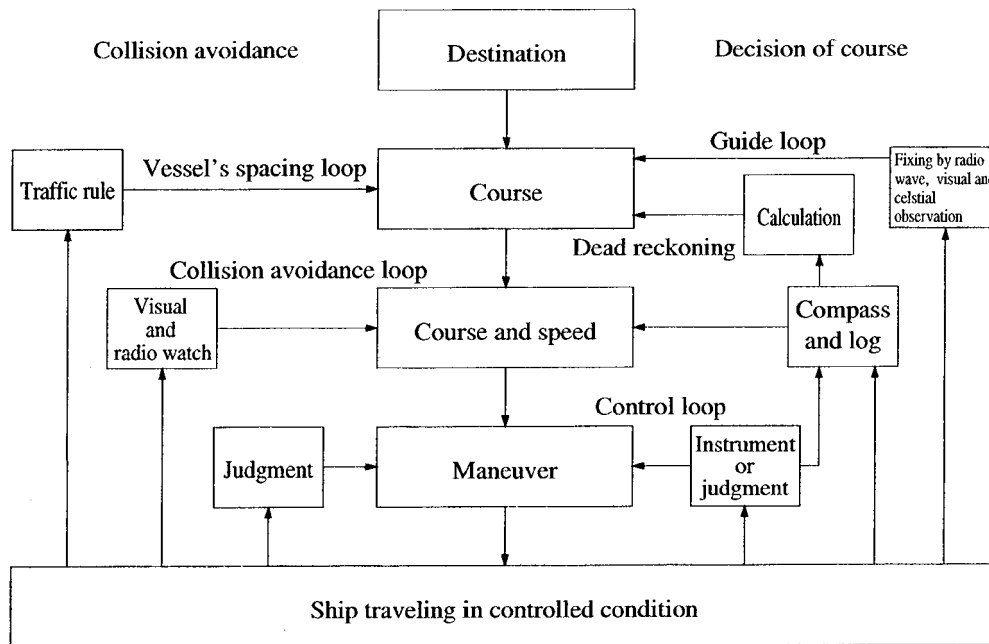

Fig. 5-1 Navigation Pattern

Marine Accidents and Collisions

Among marine accidents, collision accidents have been highlighted as the tonnages and speeds of ships become higher along with the increase in traffic at sea. If a tanker carrying dangerous articles such as crude oil collides with any other vessel, then not only the vessels involved with the accident but other vessels in the vicinity, port facilities, inhabitants in the coastal area as well as marine resources may also suffer immeasurable damages and troubles. Collision accidents have a high percentage of the marine accidents that have occurred in recent years. To cope with these problems, any effective measures are needed and some equipment to achieve collision avoidance requirements have been developed at rapid strides.

Basic Concept of Collision Avoidance

There are two aspects in collision avoidance: collision prediction and avoidance. Collision prediction is to predict that two or more vessels will happen to occupy the same point at the same time, while collision avoidance is to maneuver vessels not to occupy the same point at the same time.

In practical operation of vessels, a spot of collision has to be deemed to be a single point but a closed zone. This closed zone is conceptually defined as a CPA (Closest Point of Approach). In collision prediction, the time to be taken until a ship reaches the CPA is defined as a TCPA (Time to CPA).

Fig. 5-2 shows a diagram caked "Collision Triangle".

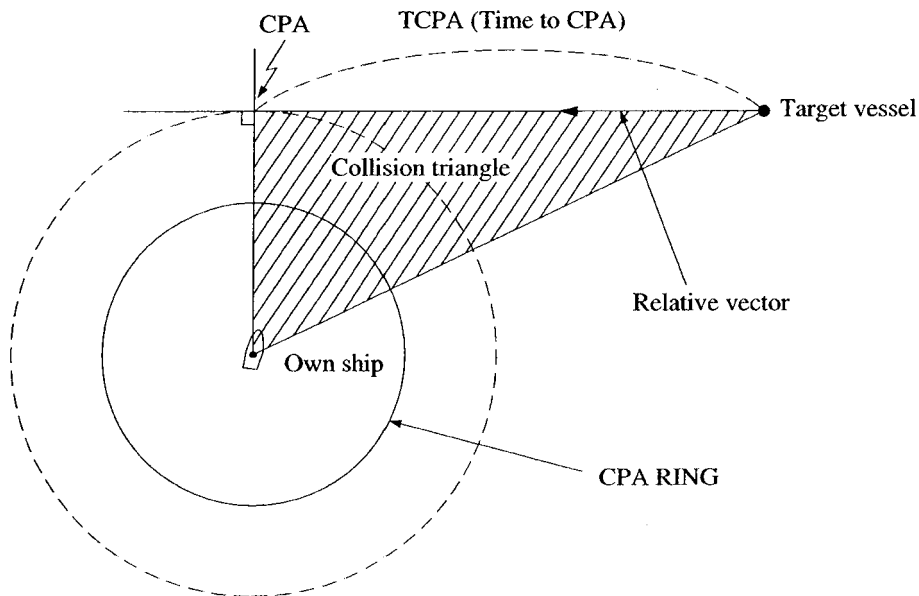

Fig. 5-2 Collision Triangle

Relative Vector and True Vector

From two points of view, collision prediction and avoidance, it is necessary to obtain the relative vector of other ship for prediction and the true vector of other ship for collision avoidance in order to grasp other ship's aspect. The relationship between the relative vector and true vector is shown in Fig. 5-3

Both rough CPA and TCPA can be obtained easily from the relative speed vector of other ship. This method has an advantage that the risks of collision with all other ships within the radar range can be seen at a glance. On the other hand, the course and speed of other ship can easily be obtained from its true speed vector, enabling other ship's aspect to be seen at a glance. Thus, the aspects of other ships (transverse, outsail, parallel run, reverse run, etc.) as described in the Act of Prevention of Collision at Sea can be readily grasped. If there is a risk of collision with other ship, the operator can determine which rule to be applied and how to operate own ship.

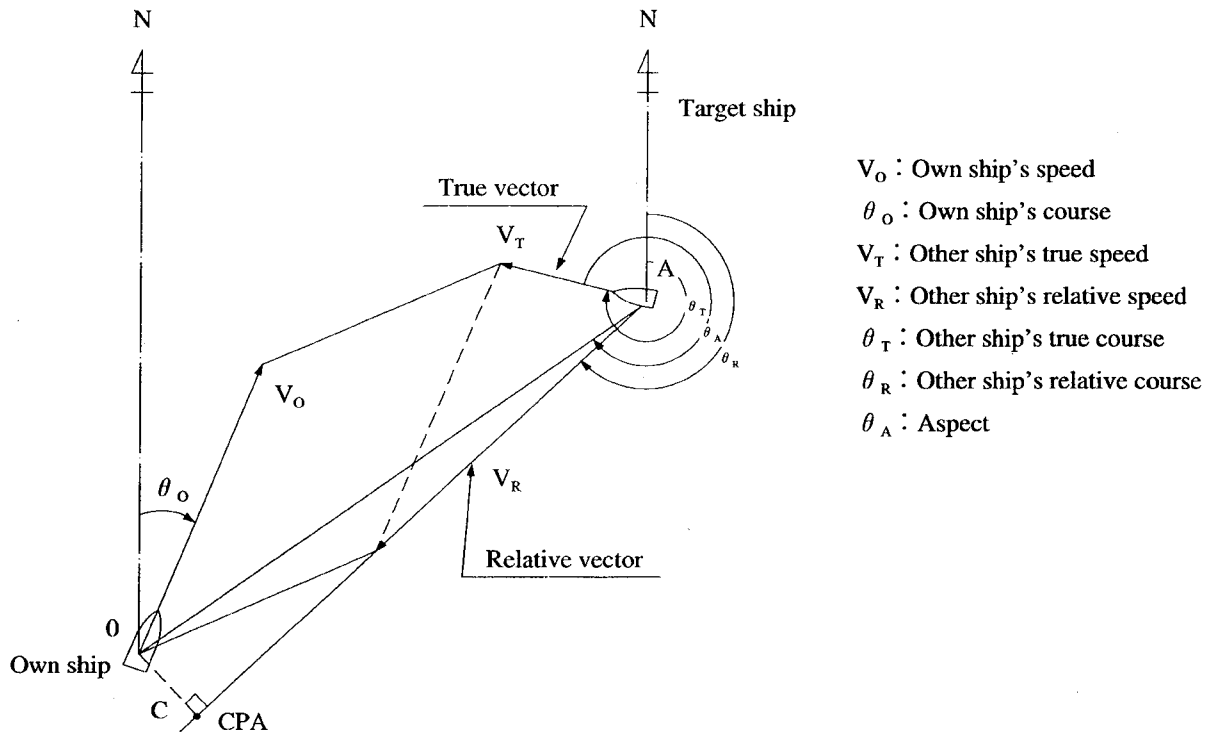

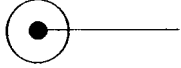
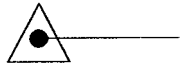
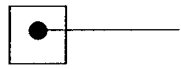



Fig. 5-3 Relative Vector and True vector

Radar and Collision Avoidance

Radar is still playing an important roll for collision prevention and positioning. A plotter is used to further enhance the radar functionality. The plotter is capable of plotting other positions of other ships in 3 to 6 minute intervals to monitor their movement. The plots of other ships represent their tracks relative to own ship, and it is shown whether there is a risk of collision, namely CPA and TCPA can be obtained. This method using a plotter is fairly effective, but the number of target ship, which are manually plotted, is limited and it takes several minutes to measure those.



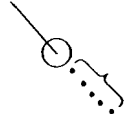

5.1.2 Definitions of Symbols

Types and Definitions of EPA, ATA, and ARPA Symbols

Vector/Symbol	Definition	Remarks
	Safe target	
	Dangerous target	Alarm characters (CPA/TCPA) appear and an alarm sounds. The vector and symbol blinks with red lamp.
	Target for which numeric data is displayed	When numeric data is displayed, the target symbol is changed into □.
	Initial acquisition mark	(EPA) This symbol is displayed when the first plotting is performed. (ATA/ARPA) This symbol is displayed until the vector is displayed after target acquisition.
	Target that has intruded into the guard zone	Alarm characters (GZ) appear and an alarm sounds. The characters blinks with red lamp.
	Lost target (a target that can not be tracked for any reason)	Alarm characters (LOST) appear and an alarm sounds. The symbol blinks. No vector is displayed.
	Trackball cross cursor mark	This mark is used to designate a target when acquiring manually and canceling it and indicating its numerical data.
	A target's past positions	The symbol and vector is displayed only when [PAST POSN] is ON. The position interval can be set to OFF/0.5min/1min/2min/4min 0.1nm/0.2nm/0.5nm/1nm
M	Plot data modification	This symbol is displayed only for (EPA). “M” is shown beside the symbol indicating that plotted target data is being modified. The previous plotting position is displayed.
U	Plot data update request	This symbol is displayed only for (EPA). This symbol is displayed when plotted target data is not updated for 10 minutes. When it is not updated, the symbol disappears after 5 minutes. A LOST alarm sounds.



Types and Definitions of AIS Symbols

Vector/Symbol	Definition	Remarks
	Sleeping target	This symbol is displayed when received data is valid. The direction of the triangle's vertex indicates the target's bow or COG.
	Activated target	The heading direction is displayed with a solid line, and the COG vector is displayed with a dotted line. The line perpendicular to the heading direction indicates the direction to which the course is to be changed. This line may not be displayed.
	Numeric-displayed target	This symbols is displayed around the target for which numeric data is displayed.
	Dangerous target	Alarm characters (CPA/TCPA) An alarm sounds. The characters are displayed in red and the symbol is blinks.
	Lost target	The dangerous target is regarded as a lost target when data cannot be received for specified time. When it is determined as a lost target, this symbol is displayed at the position calculated from the last-received data such as the course and speed.

5.1.3 Setting Collision Decision Criteria (CPA/TCPA Limit)

For details on each operation, see 3.4 BASIC OPERATION and 4 MEASUREMENT OF RANGE AND BEARING.

Attention

- **Set the optimum values of collision decision conditions, depending upon vessel type, water area, weather and oceanographic conditions. (For the relations between those conditions and alarms, refer to section 5.3.6 Alarm Display.)**

Set and check collision decision criteria before operating the ARPA system.

Procedures

1 Press [ATA MENU] key.

2 Press [1].

The ATA Setting menu will appear.

3 Press [3].

The ten-key screen will appear.

4 Select the value to be set pressing the numeric key, and press [ENT].

The selected CPA Limit value will be determined.

5 Press [4].

The ten-key screen will appear.

6. Select the value to be set pressing the numeric key, and press [ENT].

The selected TCPA Limit value will be determined.

ATA Setting	
1. Vector Time	<input type="text" value="6 min"/>
2. Past Position	<input type="text" value="OFF"/>
3. CPA Limit	<input type="text" value="10 nm"/>
4. TCPA Limit	<input type="text" value="1 min"/>
5. CPA Ring	<input type="text" value="ON"/>
6. Trial	<input type="text" value=">"/>
9. Target Number Display	<input type="text" value="ON"/>
0. EXIT	<input type="text"/>



5.1.4 Setting Vectors (Vector Time)

Vector time can be set in minutes in the range 1 to 60 min.
A true (T) vector mode or relative (R) vector mode can be selected.

Setting vector time using the menu

Procedures

- 1 Press [ATA MENU] key.
- 2 Press [1].
The ATA Setting menu will appear.
- 3 Press [1].
The ten-key screen will appear.
- 4 Select the vector time to be set pressing the numeric key, and press [ENT].
The selected vector time will be determined.

ATA Setting	
1. Vector Time	6 min
2. Past Position	OFF
3. CPA Limit	10 nm
4. TCPA Limit	1 min
5. CPA Ring	ON
6. Trial	>
9. Target Number Display	ON
0. EXIT	

Setting vector time using the multi-function control

Procedures

- 1 Press the [MULTI] control several times to activate the **VECTOR** mode.
VECTOR will appear in the **MULTI** mode field at the lower left of the radar display.
- 2 Turn the [MULTI] control to set the vector time.

Setting vector mode

Procedures

- 1 Press the [VECT] key to select the vector mode.
T or **R** will appear indicating the vector mode in the ARPA information display area at the upper right of the radar display.

5.1.5 Setting CPA Ring (CPA Ring)

Procedures

1 Press [ATA MENU] key.

2 Press [1].

The ATA Setting menu will appear.

3 Press [5].

The setting of CPA Ring will change between ON and OFF.

ON: Displays the CPA ring.
OFF: Hides the CPA ring.

While the CPA ring is displayed, is shown at the upper right of the radar display.

While the distance of the specified CPA Limit value is used as the radius, the CPA ring is displayed with a red circle of which center is the own ship's position.

Note: The CPA ring is not displayed when the true (T) vector mode is selected.

ATA Setting	
1. Vector Time	<input type="text" value="6 min"/>
2. Past Position	<input type="text" value="OFF"/>
3. CPA Limit	<input type="text" value="10 nm"/>
4. TCPA Limit	<input type="text" value="1 min"/>
5. CPA Ring	<input type="text" value="ON"/>
6. TRIAL	<input type="text" value=">"/>
9. Target Number Display	<input type="text" value="ON"/>
0. EXIT	<input type="text"/>

* The CPA ring switch to Display or Hide within the radar display ⑳ on page 2-7.



5.1.6 Setting Automatic Acquisition Key Assignment (GZ Alarm Key Setting)

This section explains how to set a guard zone that is to be assigned to the [GZ ALARM] key.

The setting enables the operator to select ON/OFF for a generally used guard zone by simply operating the [GZ ALARM] key on the control panel.

Procedures

- 1 Press [ATA MENU] key.

Press [4].

Press [3].

Press [1].

Guard Zone menu will appear.

ON: Turns on the guard zone when the [GZ ALARM] key is pressed.

OFF: Does not turn on the guard zone when the [GZ ALARM] key is pressed.

Guard Zone Alarm Key Setting

1. Guard Zone 1

2. Guard Zone 2

5

The same function also as RADAR Alarm (Sector Alarm) can be given.

Procedures

- 1 Press [ATA MENU] key.

Press [4].

Press [3].

Press [2].

* The setting method is the same as the method of a guard zone.

For the creation method of sector alarm, refer to 3-67P and Chapter 3.5.20 for the creation method of sector alarm. .

5.2 EPA OPERATION

This section explains how to use the EPA function.

The EPA function is available when the ATA and ARPA options are not installed.

The EPA function stores/displays vectors as the courses and speeds of target ships.

The data of up to 10 target ships (plot/ID numbers 0-9) can be specified.

The EPA function calculates CPA/TCPA, and issues an alarm.

The data of plotted target ships is erased from memory when the power is turned off.

The EPA function does not display any past plot data.

* The same setting procedure for ATA/ARPA applies to the following settings. See the ATA/ARPA setting procedure.

1. Vector Time
2. Past Position
3. CPA Limit
4. TCPA Limit
5. CPA Ring

5.2.1 Plotting Targets

Vectors are displayed when a target is plotted twice.

A course and speed are calculated from the two plotting positions, and the plotted target moves in the course at the speed.

The plot can be modified.

The plot number (target ID number) is not displayed while Display ID Number is set to OFF.

Procedures

- 1 Move the cross cursor mark onto the target on the radar display, and press the [ACQ] key to start the first plotting.**
- 2 Enter the plot number (target ID number), pressing the numeric key(s) [0] to [9].**
- 3 Press [ENT] to finish the first plotting.**

The acquisition symbol and plot number will be displayed at the plotting position.

- 4 When 30 seconds to 15 minutes has passed after the first acquisition, move the cross cursor mark onto the current target position, and take steps 1 to 3 to perform the second plotting.**

When finishing the second plotting, the system clears the symbol and plot number that were displayed at the end of the first plotting, and displays the symbol (vector) and plot number at the second plotting position.

The plotted target (symbol and plot/ID number) moves in a specified course at a specified speed. The course and speed are calculated from the two plotting positions. At this time, the CPA and TCPA at positions where the plotted target moves are calculated, and an alarm is issued when the plotted target goes into the guard zone.

5.2.2 Modifying Plotted Target Data

The system modifies specified plotted target data. It clears the specified data, and displays the plotted target immediately before it moves to the clear position until re-acquiring a target.

Procedures

- 1 Press the [ACQ] key.
- 2 Enter the plot number (target ID number) for modification, pressing the numeric key(s) [0] to [9].
- 3 Press the [CLR] key.

The previously updated status will be displayed. “M” is also displayed beside the mark, indicating that modification is in progress.

- 4 Move the cross cursor mark to the modification position to re-acquire a target.

At this time, specify the plot number you entered in step 2.
([ACQ], [0]-[9], [ENT])

5

5.2.3 Canceling Plotted Target Data

The system cancels the display of specified plotted target data. Once plotted target data is canceled, it cannot be restored any more.

Procedures

- 1 Press the [ACQ] key.
- 2 Enter the plot number for cancellation, pressing the numeric key(s) [0] to [9].
- 3 Press the [TGT CNCL] key.

The plotted target data of the specified plot number will be canceled.

Canceling all plotted targets

Procedures

- 1 Hold down the [TGT CNCL] key for 5 seconds or more.

The plotted targets of all the plot numbers will be canceled.

5.2.4 Displaying Numeric Data of Plotted Targets

The following data is displayed for a specified plotted target:

TGT ID	Plot number	
BRG	Bearing:	0.1° unit
RANGE	Range:	0.1 nm unit
COURSE	Target's true course:	0.1° unit
SPEED	Target's true speed:	0.1 knot unit
CPA	CPA:	0.1 nm unit
TCPA	TCPA:	0.1 min unit
TIME	Elapsed time:	0.1 min unit

Procedures

- 1 Press the [TGT DATA] key.
- 2 Enter the plot number pressing the numeric keys [0] to [9].
- 3 Press [ENT] key.

The data of the specified plot number will be displayed.

The mark of the target for which numeric data is displayed is changed into "□".

5.2.5 Setting EPA Alarm (Audible Warning)

Alarm that may sound during the use of EPA can be set to ON/OFF.

Procedures

- 1 Press [ATA MENU] key.

Press [1] key.

The EPA Setting menu will appear.

- 2 Press [6] key.

EPA alarm sound is switched ON or OFF.

ON: Sets the EPA alarm sound to ON.
OFF: Sets the EPA alarm sound to OFF.

EPA Setting	
1. Vector Time	<input type="text" value="6 min"/>
2. Past Position	<input type="text" value="OFF"/>
3. CPA Limit	<input type="text" value="10 nm"/>
4. TCPA Limit	<input type="text" value="1 min"/>
5. CPA Ring	<input type="text" value="ON"/>
6. Audible Warning	<input type="text" value="ON"/>
<input type="text" value="0. EXIT"/>	

5

Note: When this function turns off and CPA/TCPA alarm occurs, alarm does not sound. Take care for maneuvering the ship.

5.3 ATA/ARPA OPERATION

This section explains how to use the ATA and ARPA functions.

Each function is available only when the ATA or ARPA option is installed.

The functions automatically track a target, and store/display vectors as the course and speed.

They calculate CPA and TCPA, and issue an alarm.

The basic operations of ATA and ARPA are the same, but available functions are different.

The ATA function can track up to 30 ships; the ARPA function can track up to 100 ships.

Both functions set a guard zone for automatic acquisition.

The ARPA function permits the use of the trial maneuvering function (TRIAL). (The ATA does not.)

When the power is turned off or the transmit/standby mode is activated, tracking data is erased from memory.

5.3.1 Acquiring Target

Target acquisition can be performed on two modes, AUTO and MANUAL, and both modes can be used at the same time.

Automatic Acquisition [AUTO]

Attention

- **If untracked targets intrude into the guard zone in the conditions that maximum number of targets is under tracking, the targets acquired automatically will be cancelled in the order of lower levels of danger.**

Procedures

1 Press the [GZ ALARM] key.

Automatic acquisition will be started. The mark “∇” and target ID number are put to an acquired target, and they move together with the target. The vectors are displayed within one minute.

2 Press the [GZ ALARM] key again.

Automatic acquisition will be turned off, and the guard zone disappears from the radar display. However, automatically acquired ships are continuously tracked.

For the guard zone to be called by using the [GZ ALARM] key, refer to Section 5.1.6 Setting Automatic Acquisition Key Assignment.

* The guard zone can be called by using buttons ④⑨ and ⑤⑩ shown in the radar display on page 2-7.

Manual Acquisition [MANUAL]**Attention**

- **If more targets are acquired manually in the condition that the maximum number of targets are under tracking, the targets under tracking will be cancelled in the order of lower level of danger in order to track the manually acquired targets.**

Procedures

- 1 **Move the cross cursor mark onto the target to be acquired, and press the [ACQ] key.**

The target will be acquired. The initial acquisition mark and target ID number are put to the acquired target, and the vectors are displayed within one minute.

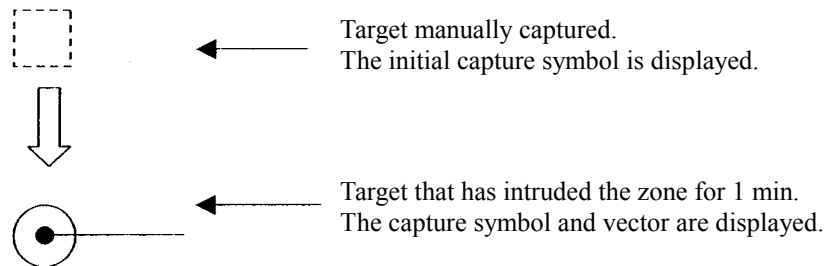
5

When using only the manual acquisition mode alone, press the [GZ ALARM] key to turn off the automatic acquisition mode.

Use of Automatic and Manual Acquisition Modes [ACQ AUTO] / [ACQ MANUAL]

Use the manual acquisition mode while the automatic acquisition mode is on.

Manually acquire the target to which particular attention should be paid, and get the other targets automatically acquired. If a new target appears exceeding the maximum number of targets, the manually acquired target is displayed even in the background until it gets out of the display. However, automatically acquired targets are canceled starting far distance from own ship.

5.3.2 Canceling Unwanted Targets

Unwanted targets can be canceled one by one in the following cases:

- Tracking is no longer necessary for targets with which vectors/symbols are displayed after being acquired and tracked.
- The number of vectors on the radar display needs to be reduced for easy observation.
When targets are to be re-acquired from the beginning, all the current vectors can also be canceled.

Canceling targets one by one

- Procedures**
- 1 Move the cross cursor mark onto the target to be canceled.
 - 2 Press the [TGT CNCL] key.

The target's vectors and symbols will disappear, and only the radar video remains.

Canceling all targets collectively

- Procedures**
- 1 Hold down the [TGT CNCL] key.

The vectors and symbols of all the targets will disappear, and only the radar videos remain.

Note: When all the targets have been canceled, the system stops tracking them. Thus, you need to re-acquire targets in manual or automatic acquisition mode. Do not cancel all the targets unless otherwise required.

5.3.3 Displaying Target ID No. (Target Number Display)

A target ID number is a value displayed beside the acquisition symbol when a target is acquired. ID numbers are assigned to targets in acquisition order. When the ATA function is used, ID numbers 1 to 30 are automatically assigned. When the ARPA function is used, ID numbers 1 to 100 are automatically assigned. Each target is identified by the assigned ID number until it is lost or its acquisition is canceled.

Procedures

1 Press [ATA MENU] key.

2 Press [1] key.

The ATA Setting menu will appear.

3 Press [9] key.

The Target Number Display is switched ON or OFF.

ON: Displays target ID numbers.

OFF: Hides target ID numbers.

ARPA TRACK: Displays target ID number with ARPA track.

If there are many tracking targets and their symbol display is confusing, set Target Number Display to OFF to view the radar display easily.

ATA Setting	
1. Vector Time	6 min
2. Past Position	OFF
3. CPA Limit	10 nm
4. TCPA Limit	1 min
5. CPA Ring	ON
6. Trial	>
9. Target Number Display	ON
0. EXIT	

Note: An ID number is always displayed for only targets with which numeric data is displayed.

5.3.4 ATA/ARPA Data Display

(Refer to Example of Display in page 2-1.)

Display of Vectors

Attention

- **When a target or own ship changes a course, or when a target is acquired, its vector may not reach a given level of accuracy until three minutes or more has passed after such course change or target acquisition.**
Even if three minutes or more has passed, the vector may include an error depending upon the tracking conditions.

A vector to represent a target's predicted position can be presented in the True vector or Relative vector mode. In each mode, a vector length can be freely changed for a time interval of 1 to 60 minutes.

The True and Relative vector can be switched by using buttons④ shown in the radar display on page 2-7.

[I] Vector Mode Selection

True Vector Mode

In the true vector mode, the direction of a target vector indicates the true course of the target and its vector length is proportional to its speed.

In this mode, own ship's vector is displayed as shown below.

In this mode, the movements of other ships around own ship can be accurately and easily monitored.

However, no CPA RING can appear in this mode.

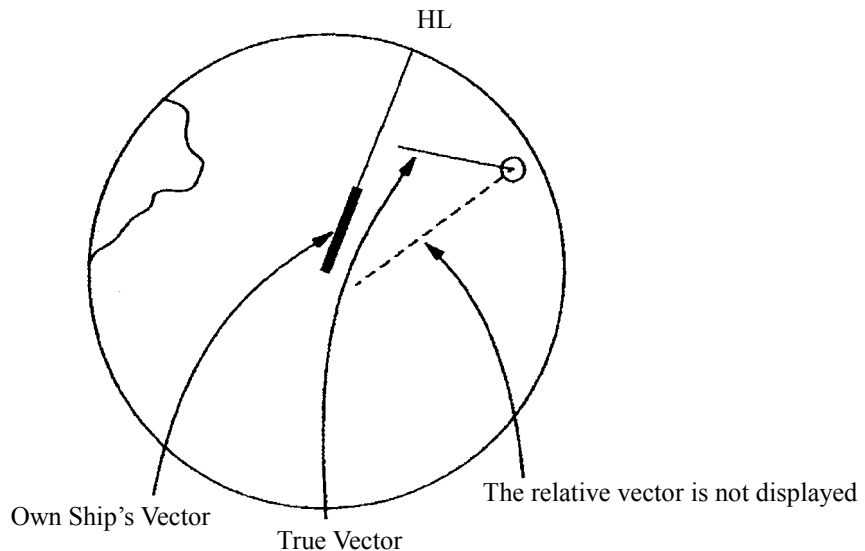

Relative Vector Mode

In displaying the relative vector of a target, press the [VECT R/T] key to select the Relative Vector mode. The relative vector does not represent the true motion of the target, but its relative relation with own ship. This means that a target with its relative vector directed to own ship (passing through the CPA LIMIT ring) will be a dangerous target. In the Relative Vector mode, it can be seen at a glance where the CPA LIMIT of the dangerous target is.

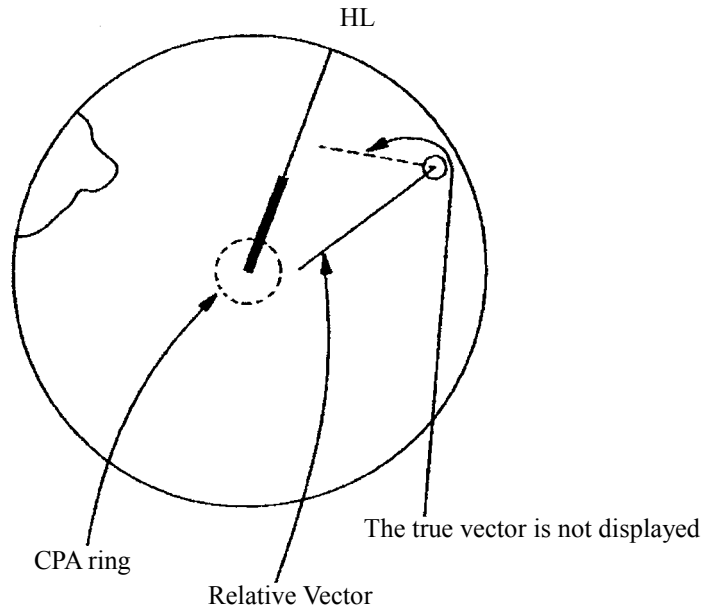

Therefore, the TRUE/REL mode shall optionally be used for the purpose of observation: the TRUE vector mode for grasping the true aspect of a target, and the REL vector mode for grasping a target's closest point of approach (CPA)

[II] Vector Length: VECTOR TIME

The vector length of a target is proportional to its speed, and the vector time can be switched in a range of 1 to 60 minutes by used for ten-key.

The diagram below illustrates a vector length of a target for six minutes, and the tip of the vector represents the target's position expected to reach six minutes later.

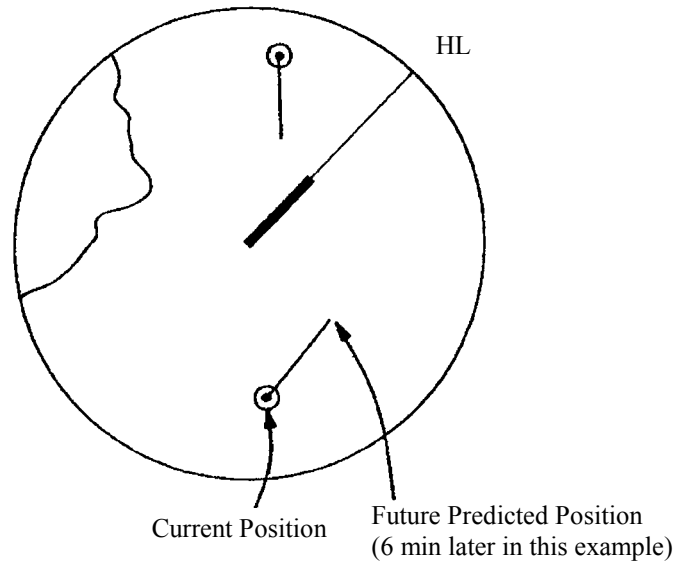

Refer to Section 5.1.4 Setting Vectors for how to change the vector time.



Display of Past Positions [PAST POSN]

Procedures

1 Press [ATA MENU] key.

2 Press [1] key.

The ATA Setting menu will appear.

3 Press [2] key.

The Past Position screen will appear.

4 Select the past position display interval to be set, pressing the numeric key.

The selected past position display interval will be set.

OFF: Hides past positions.

Time/Range: Past positions are displayed at the set intervals.

ATA Setting	
1. Vector Time	6 min
2. Past Position	OFF
3. C 1.	OFF
	2. 0.5 min
4. T 3.	1 min
	4. 2 min
5. C 5.	4 min
	6. 0.1 nm
6. T 7.	0.2 nm
	8. 0.5 nm
	9. 1 nm
9. Target Number Display	ON
0. EXIT	



The ATA/ARPA Past Position function can display up to 6 past positions of a target. The display interval can be set to specified time intervals of 0.5, 1, 2, or 4 minutes, or specified range intervals of 0.1, 0.2, 0.5, or 1 nm. The specified interval is shown on the right of PAST POSN in the ARPA information display area. When OFF is shown, Past Position is set to OFF in the menu.

Switching between the True and Relative Vector modes takes place at the same time the vector mode is switched. In relative mode, target's relative tracks displayed.

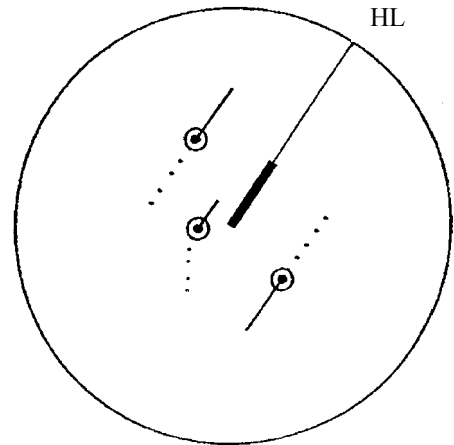

An example of display is shown in Fig. 5-4

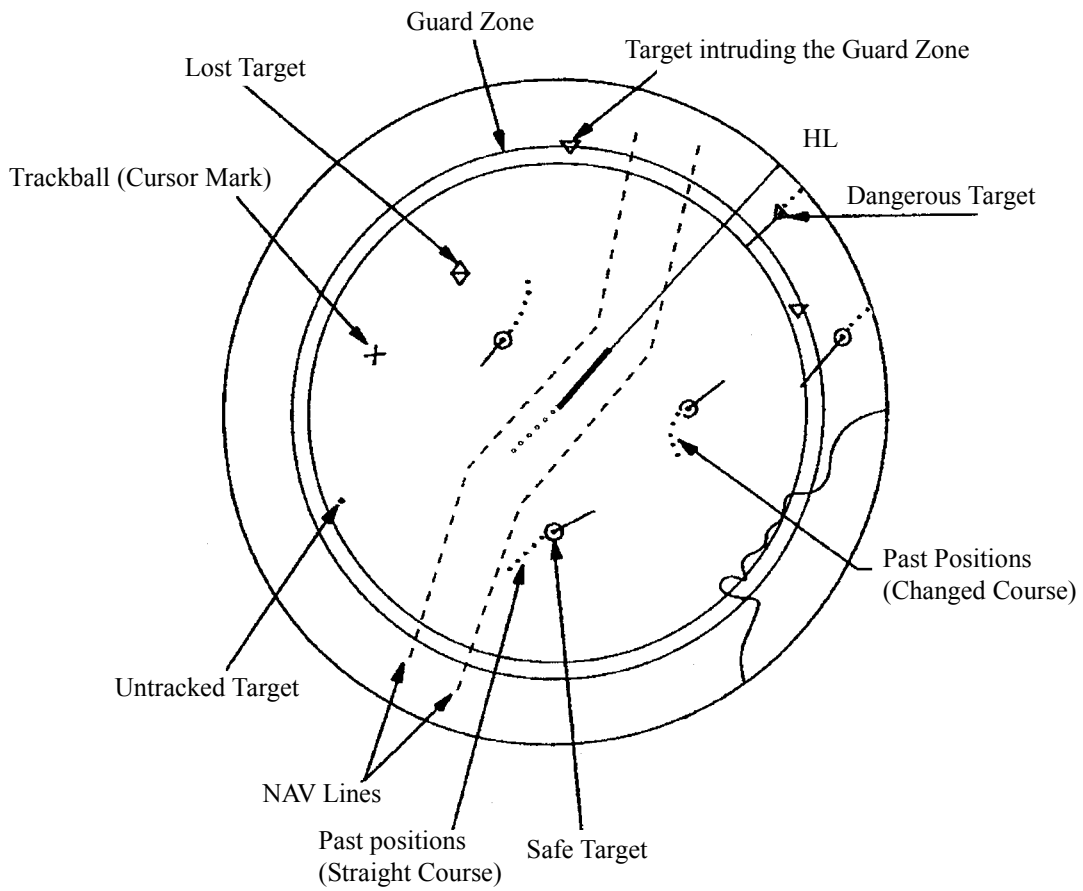

Fig. 5-4 Example of Display (in North-up and True Vector mode)

In addition to the marks and symbols shown above, fixed/variable range markers, electronic bearing lines, etc. are presented on an actual video.

5.3.5 Target Data Display

Attention

- **When a target or own ship changes its course, or when a new target is acquired, its vector may not reach a given level of accuracy until three minutes or more has passed after such course change or target acquisition. Even if three minutes or more has passed, the vector may include an error depending upon the tracking conditions.**

Type of Data Display

Target Data

Target identification (TGT ID)	ID number of the target
True bearing: BEARING	0.1° unit
Range: RANGE	0.1 NM unit
True course: COURSE	0.1° unit
True speed: SPEED	0.1 knot unit
Closest point of approach (CPA)	0.1 NM unit
Time to CPA (TCPA)	0.1 min unit
Bow crossing range (BCR)	0.1 NM unit
Bow crossing time (BCT)	0.1 min unit

The target for which its numeric data is displayed is marked with a symbol “ □ ” to distinguish from other targets.

If a target’s data is displayed, but without the symbol “ □ ”, such a target exists outside the currently displayed radar display.

[I] Method of Displaying Target Data [TGT DATA]

Procedures

- 1 **Move the cross cursor mark onto the target for which numeric data is to be displayed, and press the [TGT DATA] key.**

Then, the data of the designated target will appear, it will be marked with a symbol “ □ ”. The target data will remain on the radar display until the target is lost and its vector disappears, or until another target is designated.

If a target with the mark “ □ ” is designated, only its true bearing (BEARING) and range (RANGE) will appear until its vector appears.

* Buttons ⑤① and ⑤② on the radar display on page 2-7 are available to switch target numbers of numeric data.

[II] Input of target information (ATA Target INFO)

This radar enables name inputs and target track color changes for individual ATA/ARPA targets acquired.

* EPA is not available to make this setting.

Procedures

1 Turn OFF the cursor mode.

Button ⑰ on the radar display is available to change the cursor mode.

2 Place the cursor over the target and then press [CLR/INFO] key.

The ATA Target INFO screen opens.

*** This function is available only when the cursor mode is set to OFF.**

Item overview

Target ID: Target ID currently selected.
Name: The name of the target. It is blanked in the initial status. The user is to enter a name.
Track Color: Determines a target track color.

Target information screen

The screenshot shows a rectangular window titled "ATA Target INFO". At the top, there is a grey header bar with the text "ATA Target INFO". Below the header, there are four input fields arranged vertically. The first field is labeled "Target ID" and is a small rectangular box. The second field is labeled "1. Name" and is a larger rectangular box. The third field is labeled "2. Track Color" and is a rectangular box. At the bottom of the window, there is a rectangular box containing the text "0. EXIT".

Name entry (Name)

Procedures

- 1 While the ATA Target INFO screen is open, press [1] key.
- 2 For the entry of a new name
 → 2. INPUT
 For the selection of a name from names that have already been entered
 → 1. DATA BASE.

ATA Target INFO

Target ID

1. Name

1.	DATA BASE
2.	INPUT
3.	OFF

0. EXIT

5

For new entry

Selecting INPUT displays the screen shown below.

After making an entry, place the cursor over [ENT] key and then press it.

When the name entered with INPUT is changed to a target name, it is saved in DATA BASE.

* Up to eight characters can be entered as a name.

Name

0	1	2	3	4	5	6	7	8	9
A	B	C	D	E	F	G	H	I	J
K	L	M	N	O	P	Q	R	S	T
U	V	W	X	Y	Z	SP	<	>	

DEL

BS

ENT

EXIT

For calling a name from the names that have been entered

Selecting DATA BASE lists INPUT names that have already been entered. From the list, select a name you want to use.

* Names for 30 ships can be saved in DATA BASE.

Track Color Setting (Track Color)

Procedures

- 1 While the ATA Target INFO screen is open, press [2] key.
- 2 Pressing numeric key(s), select a color number you want to set.

Colors selectable with Track Color are colors that have been set within the ATA Track Setting. When colors are set, individual colors can be set for 10 ships. For the 11th to 20th ships, 10 ships are to be set collectively.

On this screen, selection of the 1st track is to select CYAN.

For target tracks, up to 20 ships can be displayed.

For color settings selected with Track Color, see page 5-45 in Section 5.3.9.

ATA Target INFO

Target ID

1. Name

2. Track Color

1.	OFF
2.	1-CYAN
3.	2-WHITE
4.	3-BULE
5.	4-GREEN
6.	5-YELLOW
7.	6-RED
8.	7-PINK
9.	NEXT Page

0. EXIT

5.3.6 Alarm Display

The ATA/ARPA system provides the following alarms:

- Dangerous target alarm: CPA/TCPA
- Guard zone entry alarm: GZ
- Lost target alarm: LOST
- System function alarm: ARPA (DATA)
- Gyro set alarm: SET GYRO

Dangerous Target Alarm

 **CAUTION**



Since these alarms may include some errors depending on the target tracking conditions, the navigation officer himself should make the final decision for ship operations such as collision avoidance.

Making the final navigation decision based only on the alarm may cause accidents such as collisions.





In the ARPA system, targets are categorized into two types: tracked targets and dangerous targets. The grade of danger can easily be recognized on the display at a glance. So the officer can easily decide which target he should pay attention to. The types of target and alarm are shown below.

Dangerous Target Alarm

Status	Symbol on display	Alarm characters	Alarm sound	Conditions
Tracking target	○	(OFF)	(OFF)	<ul style="list-style-type: none"> • CPA > CPA LIMIT • 0 > TCPA • TCPA > TCPA LIMIT
Dangerous target	△	TCP/TCPA	Beep sound (pee-poh) Acknowledgeable	<ul style="list-style-type: none"> • CPA ≤ CPA LIMIT, 0 ≤ TCPA ≤ TCPA LIMIT

CPA LIMIT and TCPA LIMIT: The Setting Values

Guard Zone Alarm

	CAUTION
	<p>In setting a guard zone, it is necessary to adjust the gain, sea clutter suppression and rain/snow clutter suppression to ensure that target echoes are displayed in the optimum conditions. No guard zone alarms will be issued for targets undetected by the radar, and this may cause accidents such as collisions.</p>

The guard zone functions are to set a zone at an arbitrary range and to deliver an alarm if any target intrudes within this zone.
 For the method of setting a guard zone, refer to page 3-60, section 3.5.19 Set Guard Zones.

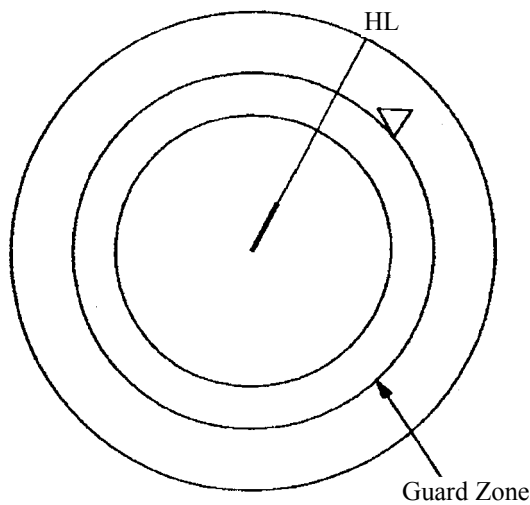

Guard Zone Alarm

Status	Symbol on display	Alarm characters	Alarm sound	Conditions
Target entering the guard zone		GZ	Beep sound (pipipi) Acknowledgeable	An alarm sound is generated while a target has entered into the range of 0.5 NM between the outer and the inner ring.

Lost Target Alarm

Attention

- **If the gain, sea clutter suppression, rain/snow clutter suppression are not adjusted adequately, the lost target alarm may be easily generated. So such adjustments should be mad carefully.**

When it is impossible to continue tracking any acquired and tracked target, the LOST target alarm will be generated. The typical causes for alarm generation are shown below, but not limited to the following:

- The target echo is very weak.
- The target is shadowed by a shore or a large ship and its echo is not received.
- The target echo is blurred by sea clutter returns.

5

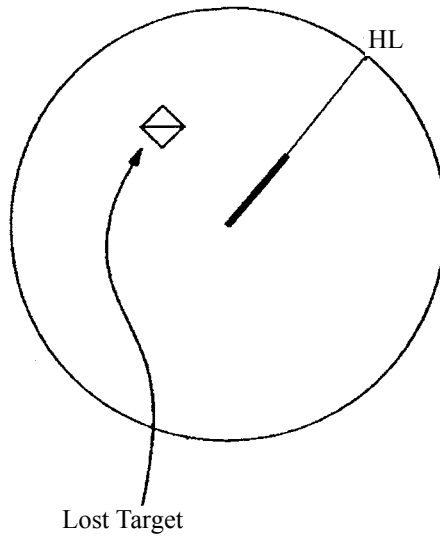

Lost Target Alarm

Status	Symbol on display	Alarm characters	Alarm sound	Conditions
Lost target	◊	LOST	Beep sound (pee) Acknowledgeable	The alarm will sound once when a lost target symbol is displayed.

System Function Alarm

When an abnormal state of an input signal or a trouble in the processing circuitry occurs, an character or alarm is generated. When an alarm occurs against any ARPA function, ARPA (DATA) will appear in the WARNING display area, but no indication is made in the ARPA information display. This status means that there is any operational trouble in the ARPA system. Please, contact the service depot or the manufactures.

System Function Alarm

Alarm characters	Alarm sound	Conditions
ARPA(DATA)	Beep sound (pipipi)	An alarm sound is generated when an ARPA circuit error occurs.

Gyro Set Alarm

The North Stabilizing Kit (NSK) in this system receives signals from a gyro. Even if the power is turned off, the system will follow up the gyro. However, the system stops the follow-up operation when the power of the master gyro is turned off or when any trouble occurs to the line. When the power of the master gyro is recovered, the SET GYRO alarm will be generated.

If this alarm occurs, set the gyro.

Gyro Set Alarm

Alarm characters	Alarm sound	Conditions
SET GYRO	Beep sound (pipipi)	The signals from the gyro are stopped, but the gyro is recovered.

5.3.7 Trial Maneuvering (Trial)

Attention

- **Trial maneuvering is to simulate own ship's course and speed in the conditions that the course and speed of a target ship are unchanged as they are. As the situation is different from any actual ship maneuvering, set values with large margins to CPA Limit and TCPA Limit.**

Attention: Trial maneuvering can be done only when the ARPA option is installed. Trial maneuvering is unavailable if the ATA option is installed.

5

The trial maneuvering is the function of simulating own ship's course and speed for collision avoidance when a dangerous target appears. When manually entering own ship's course and speed against the data of the acquired target, it is checked whether the situation is dangerous or not.

The ranges of course and speed to be entered manually:

Course: 360° (in 0.1° intervals)..... [EBL] control
 Velocity: 0 to 100 knots (in 0.1 knot steps)..... [VRM] control

Trial Maneuvering in the True Vector Mode

In the True Vector mode, calculations are performed according to the values set by Trial Speed and Trial Course, and the result is displayed as a bold-line that represents the change of own ship's vector as shown in the figure below (an example of the course changed to the right).

In this figure, the dangerous target forward right becomes safe as a result of simulation.

The target data display field indicates the current CPA LIMIT and TCPA LIMIT values regardless of the result of simulation.

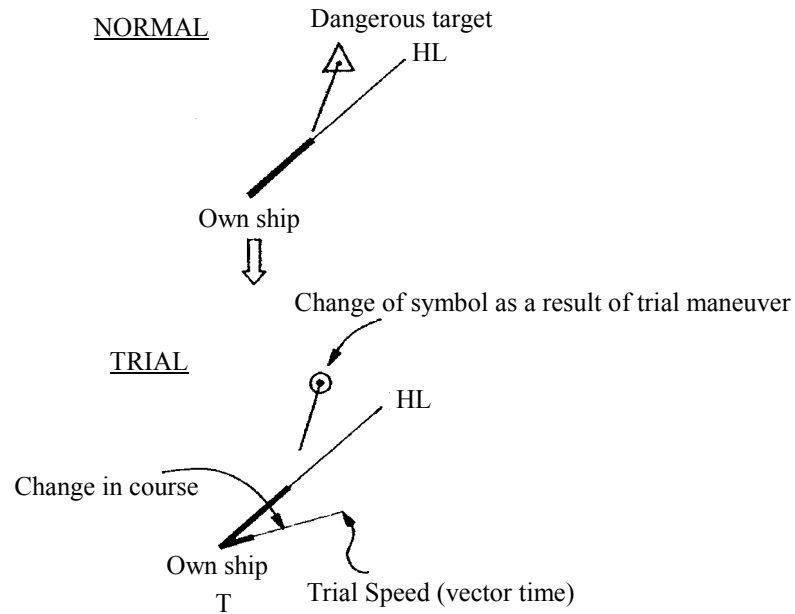

Trial Maneuvering in the Relative Vector Mode

The result of Trial maneuvering in the Relative Vector mode is shown by a change in target vector. In the figure below (in the same conditions as in the True Vector mode in the previous page), it is seen that the acquired target is a dangerous one because its vector is crossing the CPA RING.

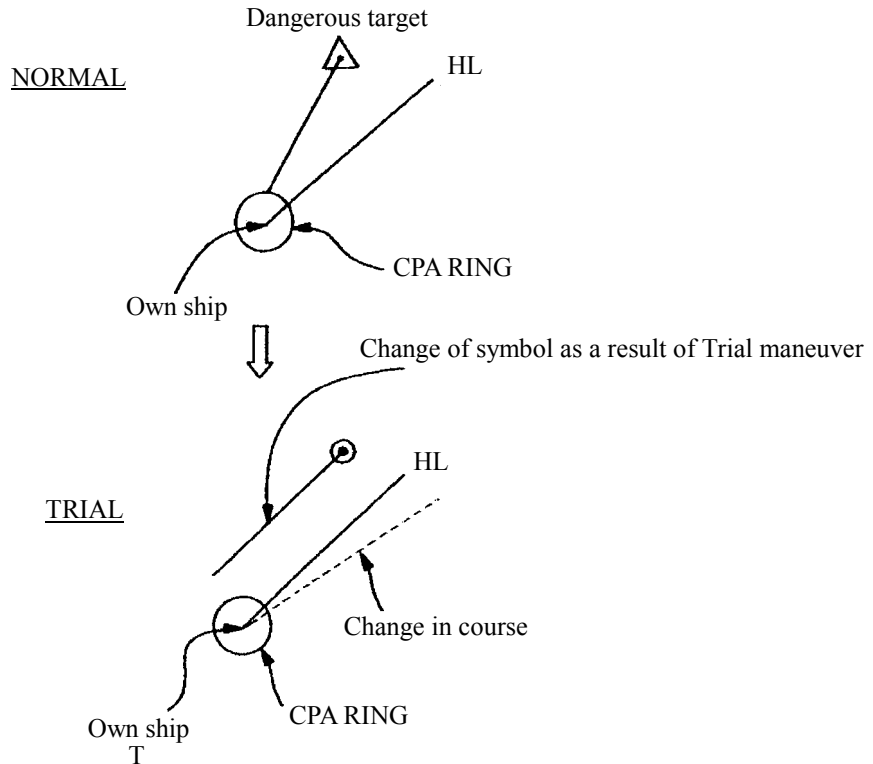

The above figure shows that the relative vector of the target has changed as shown in the figure as a result of simulation (course and speed), so that the target's symbol is changed into "O", a safe target.

The data display field indicates the current values of CPA LIMIT and TCPA LIMIT, not those as the result of simulation, same as in the True Vector mode.

The course change of own ship is displayed as a dotted-line.

Executing the TRIAL Function

Procedures

1 Press [ATA MENU] key.

2 Press [1] key.

3 Press [6] key.

The TRIAL Menu will appear.

4 Press [1] key.

“Trial” will be set to “ON” and a character “T” blinks under own ship’s mark on display to indicate the trial maneuvering mode.

5 Set a course by rotating the [EBL] control and a speed by rotating the [VRM] control.

6 As the symbol of plot data, dangerous target is marked with “△” and a safe target with “○”.

Trial	
1. Trial	<input type="text" value="OFF"/>
2. Course	<input type="text" value="000.0°"/>
3. Speed	<input type="text" value="20.0 kts"/>
<input type="text" value="0. EXIT"/>	

Exit

1 Press [1] key.

“Trial” will be set to “OFF” and the normal display will be restored.

5.3.8 ATA/ARPA Simulation



CAUTION



Simulation is a function to check whether the ATA/ARPA system is operating normally. Do not use this function except when checking the ATA/ARPA operation.

In particular, if this mode is used during navigation, pseudo targets appear on the radar display, which may be confused with the actual targets. Do not use this mode during navigation. Otherwise, this may cause accidents.

5

The following simulation to be used for ATA/ARPA can be referred to and modified:

[I]	Test Video:	Test video for use in checking the operation of the target detection circuit.
[II]	ATA Simulator:	Pseudo targets are generated on the radar display to check whether the ARPA functions are operating normally.
[III]	Status:	Displays the ATA status.
[IV]	Gate Display:	Gate size to acquire and track targets.

[1] Test Video

Attention

- **TEST VIDEO may not appear for targets that are not acquired nor tracked, or if the [GAIN] and [SEA] controls are adjusted properly**

Test Video is used to check whether the video signals under target acquisition and tracking are inputted to and processed in the target processing circuit normally. However, it is sufficient to check that VDH in TEST VIDEO is displayed. The start of the Test Video mode is available only in the Standby mode.

Procedures

- 1 Press [STBY] key.**

The equipment will enter the standby state.

- 2 Press [ATA MENU] key.**

Press [5] key.

The ATA Test Menu will appear.

- 3 Press [1] key.**

The Test Video setting screen will appear.

- 4 Press a numeric key to select a video signal you want to set.**

The selected test video will be set. The test video is displayed in the background of the radar display.

In general, VDH is sufficient for target display checks in test video mode.

ATA TEST MENU	
1. Test Video	OFF
2. A	1. OFF
	2. VDG
3. S	3. VDH
	4. VDL
4. G	5. VDIN
	OFF
0. EXIT	

If any target displayed clearly in the radar display is not displayed in the Test Video mode, the target detection circuit of the ARPA system may have a trouble.

[II] ATA Simulator

Pseudo targets can be generated in certain known positions to check whether the ARPA processing circuits are operating normally. Since the pseudo targets move depending on known parameters, the values for these pseudo targets can be compared with the known value if the pseudo targets are acquired and tracked, and displayed. Thus, it can be checked if the ARPA system is operating normally.

Procedures

- 1 Press the [STBY] key.**
The equipment will enter the standby state.
- 2 Press [ATA MENU] key.**
Press [5] key.
The ATA Test Menu will appear.
- 3 Press [2] key.**
The ATA Simulator screen will appear.
- 4 Select the simulator to be set, pressing the numeric key.**
The selected simulator will be set.
- 5 Press the [TX/PRF] key.**
The simulator will be activated and generate pseudo targets. The characters "XX" at the bottom of the radar display blinks indicating that the simulation mode is active.

ATA TEST MENU

1. TEST Video OFF

2. ATA Simulator OFF

3. S	1.	OFF
	2.	SCENARIO1
	3.	SCENARIO2
	4.	SCENARIO3
	5.	SCENARIO4
	6.	SCENARIO5
	7.	SCENARIO6

0. EXIT



ARPA simulator/scenario

SCENARIO	TARGET START POINT		TARGET END POINT		TARGET SPEED
	DISTANCE	BEARING	DISTANCE	BEARING	
1	3.2NM	10°	1NM	90°	20kts
2	6NM	0°	0NM	0°	10kts
3	6NM	every 18°	1NM	every 18°	10kts
4	6NM	45°	1NM	45°	105kts
5	6NM	45°	6NM	150°	20kts
6	6NM	45°	6NM	150°	20kts

Note: When the range between own ship and the pseudo target is 0, the target will disappear.

Exit**1 Press the [STBY] key.**

The equipment will enter the standby state.

2 Press [2] key while the ATA Test Menu is open.

The ATA Simulator screen will appear.

3 Press [1] key to select OFF.

The ATA Simulator is turned off.

[III] Status

The current ATA/ARPA status will appear.

Procedures

1 Press [ATA MENU] key.

The ATA Menu will appear

Press [5] key.

The ATA Test Menu will appear.

2 Press [3] key.

The Status screen will appear..

- *Constant: Vector response
- *Video Level TD: Threshold value used for tracking
- *Video Level HI: VD threshold value used for guard zone
- *Video Level Low: Unused
- *Gate Size: Size of gate used for tracking
- *Tracking: Number of targets currently acquired

Status	
* Constant	5
* Video Level TD	15
* Video Level HI	8
* Video Level Low	1
* Gate Size	NARROW
* Tracking	1
0. EXIT	

[IV] Gate Display

The gate displays an area monitoring a target using the ATA/ARPA function. This radar equipment allows the gate size to change automatically according to target distance and size. User can check the gate size using the following function.

Procedures

- 1 Press [ATA MENU] key.
Press [5] key.

The ATA Test Menu will appear.

- 2 Press [4] key.

The gate display mode is switched.

ON: Gate is displayed

OFF: Gate is not displayed

- 3 The gate displays data of a target you want to check using the cursor and [TGT DATA] key. (See Section 5.3.5 Target Data Display.)

The data is displayed, and the gate is displayed around the ATA/ARPA symbol in green.

Note: The ATA/ARPA function can display the gate of two targets simultaneously.

ATA TEST MENU	
1. TEST Video	<input type="checkbox"/> OFF
2. ATA Simulator	<input type="checkbox"/> OFF
3. Status	
4. Gate Display	<input type="checkbox"/> OFF
0. EXIT	

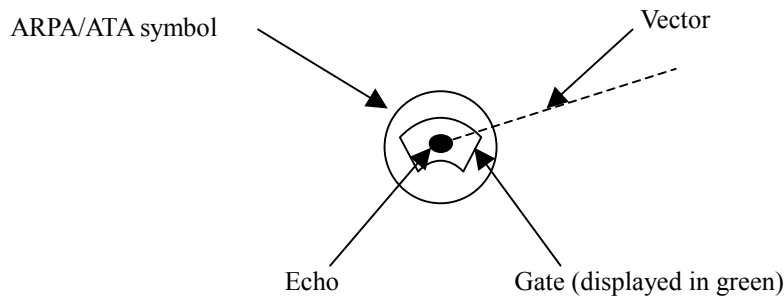

5.3.9 Setting ATA/ARPA Tracks (ATA Track Setting)

Track information on acquired ATA/ARPA targets can be set.
This radar can acquire target tracks of up to 20 ships.

[1] Turning ON/OFF the target track function (Track Function)

Procedures

1 Press [ATA MENU] key.

2 Press [3] key.

The ATA Track Setting Menu will appear.

3 Press [1] key.

The ATA/ARPA Track function is switched between ON and OFF.

ON: Sets the ATA/ARPA Track function to ON.

OFF: Sets the ATA/ARPA Track function to OFF.

ATA Track Setting	
1. Track Function	ON
2. Track Color	>
3. Track Display	>
4. Track Memory Interval	3 sec
5. Clear Track Color	WHITE
6. Clear Track Number	WHITE
7. Card2 Track Display	0000
0. EXIT	



* When this function turn off, all target track functions to OFF(Including track memory), If so, checking cannot be done later.

[II] Setting target track colors (Track Color)

The same color can be selected for all target tracks, or different colors can be set to ships whose track numbers are 1 to 10. In such cases, 10 ships, whose track numbers are 11 to 20, are to be set collectively.

Procedures **1 Press [2] key while the ATA Track Setting Menu is open.**

Track color can be set.

2 Press [1] key.

Which is to be selected, setting individual colors or setting the same color for all ships, is to be determined depending on the setting for the ALL item.

Setting individual colors: Select INDIVIDUAL
Setting the same color for all ships:
Select a color number

For setting individual colors

Selecting INDIVIDUAL makes it effective to set track numbers from ATA Track No.1 to ATA Track No.10 as well as individual settings for Other. Set a color for each target.

When pressing the item number of the target to be set displays a list of colors, select desired colors from the list. Eight colors are selectable: OFF, WHITE, CYAN, BLUE, GREEN, YELLOW, PINK and RED.

ATA Track No.1 to
ATA Track No.10: 1st ship to 10th ship
Other: 11th ship to 20th ship
Settings are made as shown above.

* Note that individual settings are effective only when INDIVIDUAL has been set.

For setting the same color for all ships

This setting is determined when you select a color displayed with ALL selected. The types of colors are the same as those to be used for setting individual colors.

Track Color	
1. All	INDIVIDUAL
2. A	1. INDIVIDUAL
	2. WHITE
3. A	3. CYAN
	4. BLUE
4. A	5. GREEN
	6. YELLOW
5. A	7. PINK
	8. RED
6. A	9. NEXT
	WHITE
7. ATA Track No.6	OFF
8. ATA Track No.7	CYAN
9. NEXT	
0. EXIT	

[III] Setting Display of Target Tracks (Track Display)

The display of target tracks can be set to ON/OFF. For the display of tracks, setting for display/nondisplay of all ships or for individual ships can be made.

Procedures

- 1 Press [3] key while the ATA Track Setting Menu is open.**

Track display can be set.

- 2 Press [1] key.**

Which is to be selected, setting individual tracks or display/nondisplay for all ships, is to be determined depending on the setting for the ALL item.

Setting individual tracks: Select INDIVIDUAL
 Setting display for all ships: Select ON
 Setting nondisplay for all ships: Select OFF

For setting individual tracks

Selecting INDIVIDUAL makes it effective to set track numbers from ATA Track No.1 to ATA Track No.10 as well as individual settings for Other. Select display/nondisplay for each target.

Each time ON/OFF window is pressed, a decision branch is switched to another.

ATA Track No.1 to
 ATA Track No.10: 1st ship to 10th ship
 Other: 11th ship to 20th ship
 Settings are made as shown above.

Track Display	
1. All	<input type="text" value="INDIVIDUAL"/>
2. A	1. <input type="text" value="INDIVIDUAL"/>
	2. <input type="text" value="ON"/>
	3. <input type="text" value="OFF"/>
3. A	<input type="text" value="ON"/>
4. ATA Track No.3	<input type="text" value="ON"/>
5. ATA Track No.4	<input type="text" value="ON"/>
6. ATA Track No.5	<input type="text" value="ON"/>
7. ATA Track No.6	<input type="text" value="ON"/>
8. ATA Track No.6	<input type="text" value="ON"/>
9. NEXT	
0. EXIT	



* Note that individual settings are effective only when INDIVIDUAL has been set.

[IV] Setting target track memory intervals (Track Memory Interval)

Target track memory intervals can be set.

* Note that this function is available only when the Target Track function is set to ON.

Procedures

- 1 Press [4] key while the ATA Track Setting Menu is open.**

The Track Memory Interval setting items are displayed.

- 2 Select a number for a memory interval you want to set.**

Settable intervals
Select from the following intervals:
OFF, 3 sec, 5 sec, 10 sec, 30 sec, 1 min, 3 min, 5 min, 10 min, 30 min, 60 min, 1 nm, 3 nm, 5 nm and 10 nm

* Setting this function to ON saves target tracks even though Target Display is set to OFF.

ATA Track Setting	
1. Track Function	
2. Track Color	>
3. Track Display >	
4. Track Memory Interval	
	3 sec
5. C	1. OFF
	2. 3 sec
6. C	3. 5 sec
	4. 10 sec
7. C	5. 30 sec
	6. 1 min
	7. 3 min
	8. 5 min
	9. NEXT
0. EXIT	

[IV] Erasing target tracks (Clear Track)

Target tracks can be erased. You can select an erasing method by color setting or an erasing method by track number setting.

Erasing tracks by color setting (Clear Track Color)

Procedures

- 1 Press [5] key while the ATA Track Setting Menu is open.
- 2 Select the number of the color you want to erase.

ATA Track Setting	
1. Track Function	
2. Track Color >	
3. Track Display >	
4. Track Memory Interval	
3 sec	
5. Clear Track Color	
WHITE	
6. C	1. ALL
	2. WHITE
7. C	3. CYAN
	4. BLUE
	5. GREEN
	6. YELLOW
	7. PINK
	8. RED
0. E	9. NEXT



Erasing tracks by track number (Clear Track Number)

Procedures

- 1 Press [6] key while the ATA Track Setting Menu is open.
- 2 Select the track number you want to erase.

ATA Track Setting	
1. Track Function	
2. Track Color	>
3. Track Display	>
4. Track Memory Interval	
	3 sec
5. Clear Track Color	
	WHITE
6. Clear Track Number	
	1
7. C	1. ALL
	2. ATA Track No.1
	3. ATA Track No.2
	4. ATA Track No.3
	5. ATA Track No.4
	6. ATA Track No.5
0. E	7. ATA Track No.6
	8. ATA Track No.7
	9. NEXT Page



[V] Reading target track saved in CARD2 (Card2 Track Display)

Saved target tracks can be read from CARD2.

Reading targets by color setting

Procedures

- 1 Press [7] key while the ATA Track Setting Menu is open.
- 2 Enter the number you want to read with the numeric key, and then press the ENT key.

* For how to save targets in CARD2, see page 3-131, section 3.12.1.

ATA Track Setting	
1. Track Function	
2. Track Color	>
3. Track Display	>
4. Track Memory Interval	3 sec
5. Clear Track Color	WHITE
6. Clear Track Number	1
7. Card2 Track Display	0000
0. EXIT	

5.4 AIS OPERATION

Attention

There are the following limitations on use of the AIS function, system, and operation:

[I] This system can display a maximum of 50 AIS targets. There are two types of filters for increasing the display priority. (Refer to Section 5.4.6 AIS FILTER SETTING.)

[II] Keep in mind that the following restrictions are placed on use of the AIS function:

- 1) The AIS function cannot be turned on in the following cases:
 - MANUAL is selected for the speed sensor.
 - LOG or 2-axis LOG is used for the speed sensor, and SET and DRIFT are selected.
- 2) LOG or 2-axis LOG cannot be selected for the speed sensor in the following case:
 - SET or DRIFT is set while the AIS function is on.
- 3) MANUAL cannot be selected for the speed sensor in the following case:
 - The AIS function is on.
- 4) SET/DRIFT (current offset) cannot be turned on in the following case:
 - The AIS function is turned on, and LOG or 2-axis LOG is selected for the speed sensor.

* Use of this function requires AIS I/F (option).

5.4.1 Initial Setting

This section explains the initial setting for using the AIS function.

Setting the GPS antenna location

Set the GPS antenna location. Set offset ranges in longitudinal direction and latitudinal direction from the own ship's reference position.

For the setting procedure, refer to Section 8.5 ADJUSTMENT.

Attention

- **If offset ranges are not set correctly, AIS symbols and radar echoes may be displayed shifted.**
- **When offset ranges are set, latitude and longitude data received from the GPS is offset, and the offset data is displayed as the latitude and longitude of own ship's position.**

5

Setting collision decision criteria (CPA Limit/TCPA Limit)

The collision decision criteria for the ATA/ARPA function are applied to the AIS function.

For the setting procedure, refer to Section 5.1.3 Setting Collision Decision Criteria.

The AIS setting menu is also available for the collision decision criteria. Note that the same collision decision criteria must apply to ATA and ARPA.

Attention

- **Set the optimum values of collision decision conditions, depending upon vessel type, water area, weather, and oceanographic conditions.**

Procedures

1 Press [ATA MENU] key.

2 Press [2] key.

The AIS Setting Menu will appear.

3 Press [4] key.

The ten-key screen will appear.

4 Using numeric keys, enter the CPA value you want to set, and then press [ENT] key.

The entered CPA Limit value is determined.

5 Press [5] key.

The ten-key screen will appear.

6 Using numeric keys, enter the TCPA value you want to set, and then press [ENT] key.

The entered TCPA Limit value is determined.

AIS Setting	
1. AIS Function	OFF
2. AIS Symbol Display	OFF
3. ATA Symbol Display	ON
4. CPA Limit	1 nm
5. TCPA Limit	1 min
6. AIS Filter Setting	>
7. Identical Distance	100 m
0. EXIT	

* The collision decision criteria set on the AIS side are also available on ATA/ARPA.



5.4.2 Setting AIS Display Function (AIS Function)

Switch the AIS symbol display function to ON/OFF.

Attention

- When the AIS display function is set to OFF, no AIS symbols are displayed.
- The AIS display function itself is turned OFF.
- Once the AIS display function is set to OFF, it is not automatically switched to ON even if a dangerous target exists.

Procedures

- 1 Press [ATA MENU] key.

Press [2] key.

The AIS Setting menu will appear.

- 2 Press [1] key.

The AIS Function is switched between ON and OFF.

ON: Enables the AIS display function.

OFF: Disables the AIS display function.

AIS Setting	
1. AIS Function	<input type="text" value="OFF"/>
2. AIS Symbol Display	<input type="text" value="OFF"/>
3. ATA Symbol Display	<input type="text" value="ON"/>
4. CPA Limit	<input type="text" value="1 nm"/>
5. TCPA Limit	<input type="text" value="1 min"/>
6. AIS Filter Setting	<input type="text" value=">"/>
7. Identical Distance	<input type="text" value="100 m"/>
<input type="text" value="0. EXIT"/>	

* Button on the radar display on page 2-7 is also available to switch the display functions.

* Note that turning OFF this function switches all AIS display functions to OFF.

5.4.3 Activating AIS Targets

Activate an AIS target, and display the target's vector and make a collision decision.

Manual activation

Activate an AIS target^{*1} in manual mode to display the vector and HL.

Procedures

- 1 Press the **CURSOR** button at the upper right of the radar display several times until **ACT AIS** appears.

The cursor mode is set to the AIS activation mode.

- 2 Move the cross cursor mark onto the inactive AIS target that is to be activated^{*1}, and press [ENT] key.

The selected AIS target will be activated^{*1}.

Automatic activation

Activate an AIS target in automatic mode to display the vector and HL.

If the guard zone function is in use, an AIS target is activated automatically when it has entered the guard zone. Dangerous targets are also activated automatically.

The guard zone is the same as for ATA/ARPA. For the setting procedure, refer to "Setting Guard Zone" in 3.4 BASIC OPERATION of the instruction manual.

Reference If an AIS target is activated but the vector is not displayed, refer to Section 5.4.5 Setting AIS Symbol Display.

^{*1} For activation of targets, refer to Section 5.1.2 Definitions of Symbols.



5.4.4 Deactivating AIS Targets

Deactivate an AIS target^{*2} and clear the display of the vector and HL.

Attention

- **The operation above is effective only for active targets.**

Procedures

- 1 Press the **CURSOR** button at the upper right of the radar display several times until **CANCEL** appears.

The cursor mode is set to the deactivation mode.

- 2 **Move the cross cursor mark onto the active AIS target that is to be deactivated^{*2}, and press [ENT] key.**

The selected AIS target will be deactivated^{*2}.

^{*2} For deactivation of targets, refer to Section 5.1.2 DEFINITIONS OF SYMBOLS.

5.4.5 Setting AIS Symbol Display Function (AIS Symbol Display)

Switch ON or OFF to set the AIS symbol display function.

Procedures

- 1 Press [ATA MENU] key.

Press [2] key.

The AIS Setting menu will appear.

- 2 Press [2] key.

The AIS Symbol Display is switched between ON and OFF.

ON: Enables the AIS symbol display function.

OFF: Disables the AIS symbol display function.

AIS Setting	
1. AIS Function	<input type="text" value="OFF"/>
2. AIS Symbol Display	<input type="text" value="OFF"/>
3. ATA Symbol Display	<input type="text" value="ON"/>
4. CPA Limit	<input type="text" value="1 nm"/>
5. TCPA Limit	<input type="text" value="1 min"/>
6. AIS Filter Setting	<input type="text" value=">"/>
7. Identical Distance	<input type="text" value="100 m"/>
<input type="text" value="0. EXIT"/>	

* Button ②⑥ on the radar display on page 2-7 is also available for switching.

5.4.6 Displaying Numeric Data of AIS Targets

Display the numeric data of active AIS targets.

Types of numeric data displayed

There are two modes (simple and detail) to display the numeric data of AIS targets. The display items are different between the two modes.

Display Item	Detail mode	Simple mode
NAME (ship name)	Up to 20 characters	
CALL SIGN	Up to 7 characters	
MMSI	Up to 9 characters	
COG (course over ground)	0.1° unit	
SOG (speed over ground)	0.1 knot unit	
CPA (closest point of approach)	0.1 nm unit	
TCPA (time to CPA)	0.1 min unit	
BRG (true bearing)	0.1° unit	Not displayed
RANGE	0.1 nm unit	
HDG (heading bearing)	0.1° unit	
ROT (course change speed)	0.1°/min	
L/L (latitude/longitude)	0.001' unit	

The detail mode displays the numeric data of only a single ship; the simple mode can display the numeric data of up to three ships.

Displaying numeric data

Procedures

- 1 Press the **CURSOR** button at the upper right of the radar display several times until **TGT DATA** appears.

The cursor mode is set to the numeric data display mode.

- 2 Move the cross cursor mark onto the active AIS target for which numeric data is to be displayed, and press [ENT] key.

The values of the selected AIS target will appear on the right side of the radar display.

The mark  is displayed around the symbol.

Reference: If the values are displayed but the mark  is not on the radar display, the target is outside the radar display.

Clearing numeric data

Procedures

- 1 Press the **CURSOR** button at the upper right of the radar display several times until **TGT DATA** appears.

The cursor mode is set to the numeric data display mode.

- 2 Move the cross cursor mark onto the active AIS target for which numeric data is to be cleared, and press **[CLR]** key.

The values of the selected AIS target will be cleared from the right side of the radar display, and the mark  displayed around the symbol will also disappear.

Selecting the detail/simple mode to display numeric data

Procedures

- 1 Move the pointer to the button **W**, **W** at the upper right of the AIS target's numeric data display area, and press **[ENT]** key.
- 2 The detail mode or the simple mode is switched each time the button is clicked.

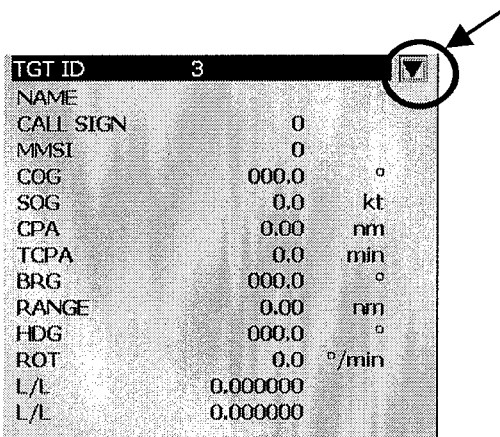

TGT ID	3
NAME	
CALL SIGN	0
MMSI	0
COG	000.0 °
SOG	0.0 kt
CPA	0.00 nm
TCPA	0.0 min
BRG	000.0 °
RANGE	0.00 nm
HDG	000.0 °
ROT	0.0 °/min
L/L	0.000000
L/L	0.000000

Display sample in detail mode

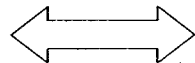

Switched each time the button is clicked

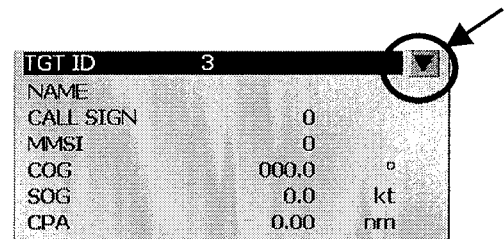

TGT ID	3
NAME	
CALL SIGN	0
MMSI	0
COG	000.0 °
SOG	0.0 kt
CPA	0.00 nm

Display sample in simple mode

5.4.7 Setting ATA/ARPA Symbol Display Function (ATA Symbol Display)

Set the ATA/ARPA symbol display function to ON/OFF.

This function is effective only when the AIS display function (option) is set to ON.

This function is unavailable when the AIS display function is set to OFF.

This function holds data even though the ATA/ARPA display is set to OFF.

For the AIS display function, see Section 5.4.2 on page 5-54.

Procedures

1 Press [ATA MENU] key.

Press [2] key.

The AIS Setting menu will appear.

2 Press [3] key.

The ATA/ARPA Symbol Display Function is switched ON or OFF.

ON Enables the ATA/ARPA symbol display function.

OFF: Disables the ATA/ARPA symbol display function.

AIS Setting	
1. AIS Function	<input type="text" value="OFF"/>
2. AIS Symbol Display	<input type="text" value="OFF"/>
3. ATA Symbol Display	<input type="text" value="ON"/>
4. CPA Limit	<input type="text" value="1 nm"/>
5. TCPA Limit	<input type="text" value="1 min"/>
6. AIS Filter Setting	<input type="text" value=">"/>
7. Identical Distance	<input type="text" value="100 m"/>
0. EXIT	

* Button  on the radar display on page 2-7 is also available to switch between ON and OFF.

5.4.8 Setting AIS Filter (AIS Filter Setting)

About an AIS filter

The setting of an AIS filter enables the priority display of AIS targets in the area. The filter is initially set in a circle having a radius of 20 [nm] from the own ship's position. If 51 or more targets exist in the filter range, they are displayed according to the priority explained in Section 5.4.11 Displaying AIS Symbols - Maximum number of targets and the display priority.

Type of AIS filters (Filter Type)

There are the following three types of AIS filters:

- 1) RANGE..... A filter is set in a circle with a set range as the radius.
- 2) SECTOR..... A filter is set in a sector formed by two bearings with the bow as reference.
- 3) ZONE..... A filter is set in a zone formed by two bearings and two ranges with the bow as reference.

Procedures

- 1 Press [ATA MENU] key.**

Press [2] key.

Press [6] key.

The ATA Filter Setting menu will appear.

- 2 Press [1] key.**

The Filter type selection screen will appear.

- 3 Select the AIS filter type to be set, pressing the numeric key.**

The selected AIS filter type will be determined.

AIS Filter Setting	
1. Filter Type	
	RANGE
2. M	1. RANGE
	2. SECTOR
3. F	3. ZONE
	ON
0. EXIT	



Making an AIS filter (Make AIS Filter)

Procedures

- 1 Press [2] key while the ATA Filter Setting menu is open.

The Make AIS Filter screen will appear.

[I] Setting a RANGE filter

- 2 Turn the [VRM] key control to set a filter range, and press [ENT] key.

The range of a RANGE filter will be set. AIS targets in the set circle are displayed by priority.

[II] Setting a SECTOR filter

- 2 Turn the [EBL] key control to set the bearing of the port side, and press [ENT] key.
- 3 Turn the [EBL] key control to set the bearing of the starboard, and press [ENT] key.

A SECTOR filter will be set. AIS targets in the area formed by the two set bearings are displayed by priority.

[III] Setting a ZONE filter

- 2 Turn the [EBL] key and [VRM] key controls to set the bearing and range of the port side, and press [ENT] key.
- 3 Turn the [EBL] key and [VRM] key controls to set the bearing and range of the starboard, and press [ENT] key.

A ZONE filter will be set. AIS targets in the area formed by the two set bearings and ranges are displayed by priority.

AIS Filter Setting

1. Filter Type RANGE

2. Make AIS Filter

3. Filter Display ON

0. EXIT

Attention

- When the guard zone function is enabled, the system automatically corrects the filter range to cover the guard zone. Thus, the guard zone is always inside the filter range.

Setting the AIS filter display function to ON/OFF (Filter Display)

Procedures

- 1 Press [3] key while the ATA Filter Setting menu is open.

The setting of AIS Filter display will be switched ON or OFF.

ON: Displays the AIS filter.
OFF: Hides the AIS filter.

AIS Filter Setting

1. Filter Type

RANGE

2. Make AIS Filter

3. Filter Display

ON

0. EXIT

5.4.9 Deciding AIS Target and ARPA Target as the Same One (Identical Distance)

Setting a range in which an AIS target and ARPA target are regarded as the same one

An AIS target and an ARPA target in the set range are regarded as the same one, and the ARPA symbol is not displayed. At this time, the AIS symbol is automatically activated.

Attention

- To display the hidden ARPA symbol, set the AIS symbol display function to OFF. (For the setting procedure, refer to Section 5.4.5)
- Set 0 not to regard an AIS target and ARPA target as the same one.

5

Procedures

- 1 Press [ATA MENU] key.

Press [2] key.

The AIS Setting menu will appear.

- 2 Press [7] key.

The ten-key will appear.

- 3 Select the distance to be set pressing the numeric key, and press [ENT] key.

The range in which an AIS target and ARPA target are regarded as the same one will be set.

AIS Setting	
1. AIS Function	<input type="text" value="OFF"/>
2. AIS Symbol Display	<input type="text" value="OFF"/>
3. ATA Symbol Display	<input type="text" value="ON"/>
4. CPA Limit	<input type="text" value="1 nm"/>
5. TCPA Limit	<input type="text" value="1 min"/>
6. AIS Filter Setting	<input type="text" value=">"/>
7. Identical Distance	
0. EXIT	



CAUTION



When setting large values in determining the distance to the same target, the ARPA target near the AIS target may be not displayed.

For example, when a pilot ship with AIS function, which is a small target, not ARPA target, approaches to a cargo ship without ARPA function, which is an ARPA target, the cargo ship's ARPA symbol may not be displayed.

5.4.10 Conditions for Deciding AIS Target to be Lost

About a lost target

When the data of an AIS target cannot be received for a specified time, the target is decided to be lost and the target data is deleted. As shown in the table below, the time until target data is deleted varies depending on the class of receive data and the target status.

[SOLAS ship] (Class A)

Target Status	Time until data deletion
Vessel below 3 knots and it is now at anchor or on the berth	18 min
Vessel of 3 knots or more and it is now at anchor or on the berth	60 sec
Vessel of 0 to 14 knots	60 sec
Vessel of 0 to 14 knots and it is now changing the course	60 sec
Vessel of 14 to 23 knots	36 sec
Vessel of 14 to 23 knots and it is now changing the course	36 sec
Vessel of 23 knots or more	12 sec
Vessel of 23 knots or more and it is now changing the course	12 sec

[Non-SOLAS ship] (Class B)

Target Status	Time until data deletion
Vessel below 2 knots	18 min
Vessel of 2 to 14 knots	180 sec
Vessel of 14 to 23 knots	90 sec
Vessel of 23 knots or more	30 sec

Reference:

- When a dangerous target ship is lost, a lost alarm is issued and the symbol changes to a lost symbol. The system calculates the current position from the last-received data and continues displaying the symbol for a maximum of one minute. If the system cannot receive any data within one minute or the ALARM ACK switch is pressed, the symbol is cleared.
- When a safe target ship is lost, the system does not issue a lost alarm, display a lost symbol, or calculate the current position.

5.4.11 Displaying AIS Symbols

Maximum number of targets and the display priority

Attention

- **When the system receives the data of the 51-th target ship, it displays AIS MAX TARGET at the right lower of the radar display, and issues audible alarm (beep sound of pipi).**

A radar of the JMA-5300 series displays AIS symbols for a maximum of 50 targets. When 51 AIS targets or more exist, they are displayed according to the following priority:

1. Target for which numeric data is displayed
2. Target displayed by the AIS target search function
3. Target in the AIS filter
(Targets closer to the own ship in the filter have higher priority.)
4. Target whose CPA/TCPA is the set value or less.
(Target for which a dangerous ship alarm has been issued)
5. Targets other than the above, which are outside the AIS filter
(Targets closer to the own ship in the filter have higher priority.)

Displaying the vectors of AIS symbols

Attention

- **If a vector is not displayed even when the AIS symbol is activated, probable causes are as follows:**
 1. **COG/SOG from the GPS has not been entered.**
 2. **The selected speed sensor is malfunctioning.**

The vector of an AIS symbol is to be displayed as a vector over water or over ground, depending on the speed sensor setting and current offset setting. The type of the currently displayed vector is confirmed in the own ship's information display area at the upper right of the radar display.

When "GND" is displayed to the right of OS STAB: Vector over ground

When "SEA" is displayed to the right of OS STAB: Vector over water

When the vector of an AIS symbol is displayed as a vector over water, the system has converted the AIS symbol's vector over ground to the vector over water according to the data received from the AIS and the own ship's information.

5.4.12 AIS Alarm Display

Alarm messages for the AIS system:

Error Message	Description
COA/TCPA	There is a dangerous target.
LOST	There is a lost target.
AIS MAX TARGET	The system received data (of the 51-th ship) over the specified maximum number of AIS symbols.
AIS (DATA)	The AIS is not connected correctly, or the power is off.
AIS I/F (DATA)	The AIS interface is not connected to the radar correctly, or it is faulty.
AIS ALARM ***	Alarm information issued with the ALR sentence by the AIS *** is a 3-digit number which is Local Alarm No in the ALR sentence. For AIS alarms, refer to the table below.

Numbers and definitions of AIS alarms which might appear on the radar display

Alarm No.	Definition
001	Transmission alarm
002	VSWR calculation result alarm
003	Receive channel 1 alarm
004	Receive channel 2 alarm
005	Receive channel 70 alarm
006	General error
008	Connection alarm between the transponder and controller
025	External EPFS connection alarm
026	The internal GPS is disabled, and latitude/longitude data has not been received from the external sensor or the data is invalid.
029	The internal GPS is disabled, and SOG data has not been received from the external sensor or the data is invalid
030	The internal GPS is disabled, and the COG command below has not been received from the external sensor or the data is invalid.
032	Course data has not been received from the external sensor, or the data is invalid.
035	ROT data has not been received from the external sensor, or the data is invalid.

Reference: An error message is displayed at the lower right of the radar display.

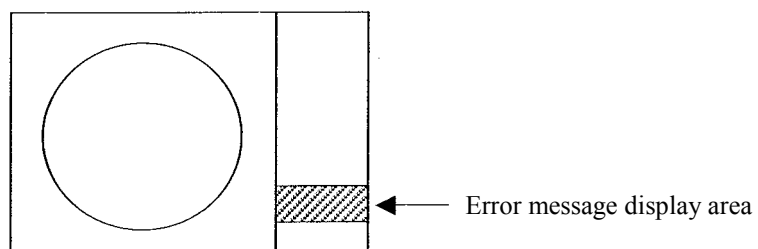

5.4.13 Restrictions

The following restrictions are placed on use of the AIS function:

The AIS function is unavailable in the following cases:

- “MANUAL” is selected for the speed sensor.
- SET or DRIFT is set while LOG or 2AXW is selected for the speed sensor.

LOG or 2AXW cannot be selected for the speed sensor in the following case:

- SET or DRIFT is set while the AIS function is on.

MANUAL cannot be selected for the speed sensor in the following case:

- The AIS function is on.

Current offset (SET/DRIFT) cannot be turned on in the following case:

- LOG or 2AXW is selected for the speed sensor while the AIS function is on.

SECTION 6 TRUE AND FALSE ECHOES ON DISPLAY

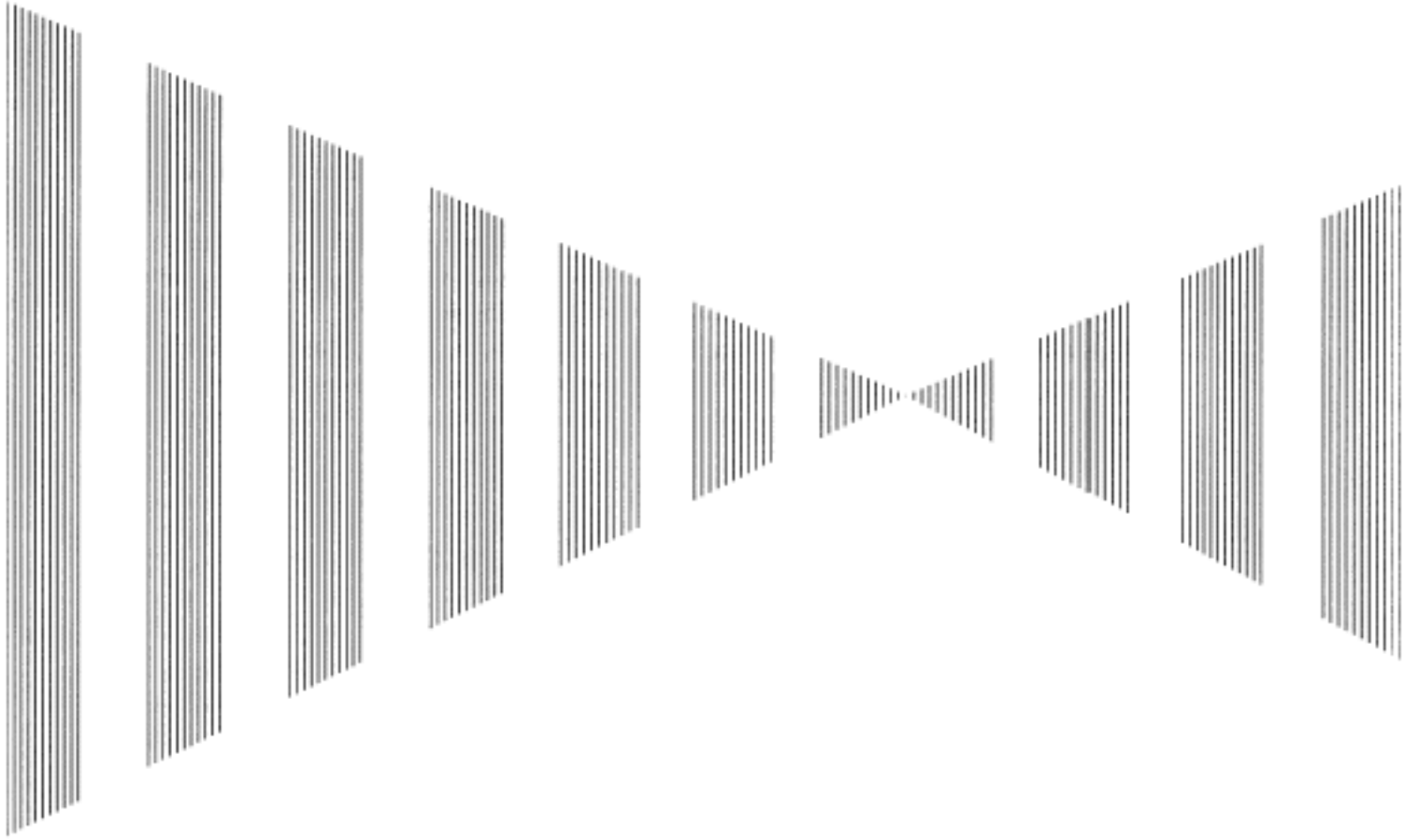

6.1	Radar Wave with the Horizon.....	6-2
6.2	Strength of Reflection from the Targets ..	6-4
6.3	Sea Clutters	6-5
6.4	False Echoes	6-6
6.5	Display of Radar Transponder (SART).....	6-9

The radar operator has a role of interpreting the radar displays to provide his best aid in maneuvering the ship. For this purpose, the operator has to observe the radar displays after fully understanding the advantages and disadvantages that the radar has. For better interpretation of radar display, it is important to gain more experiences by operating the radar equipment in fair weathers and comparing the target ships watched with the naked eyes and their echoes on the radar display.

The radar is mainly used to monitor the courses of own ship and other ships in open seas, to check buoys and other nautical marks when entering a port, to measure own ship's position in the coastal waters relative to the bearings and ranges of the shore or islands using a chart, and to monitor the position and movement of a heavy rain if it appears on the radar display.

Various types of radar display will be explained below.

6.1 RADAR WAVE WITH THE HORIZON

Radar beam radiation has the nature of propagating nearly along the curved surface of the earth. The propagation varies with the property of the air layer through which the radar beam propagates. In the normal propagation, the distance (D) of the radar wave to the horizon is approximately 10% longer than the distance to the optical horizon. The distance (D) is given by the following formula:

$$D=2.23(\sqrt{h_1} + \sqrt{h_2})(nm)$$

h1: Height (m) of radar scanner above sea level

h2: Height (m) of a target above sea level

Figure 6.1 is a diagram for determining the maximum detection range of a target that is limited by the curve of the earth surface in the normal propagation.

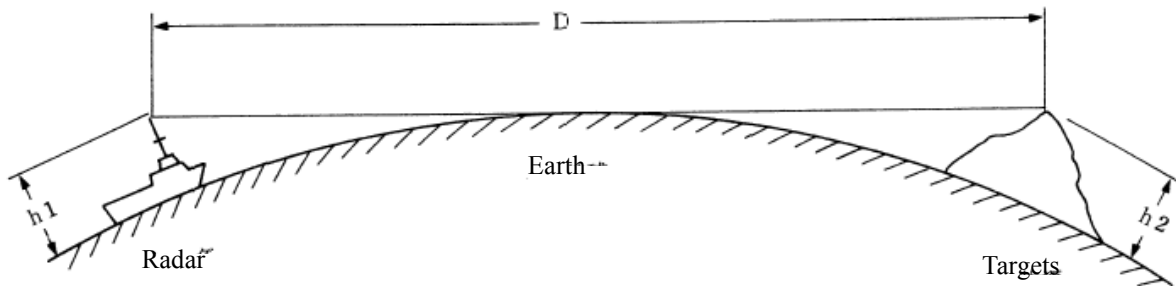

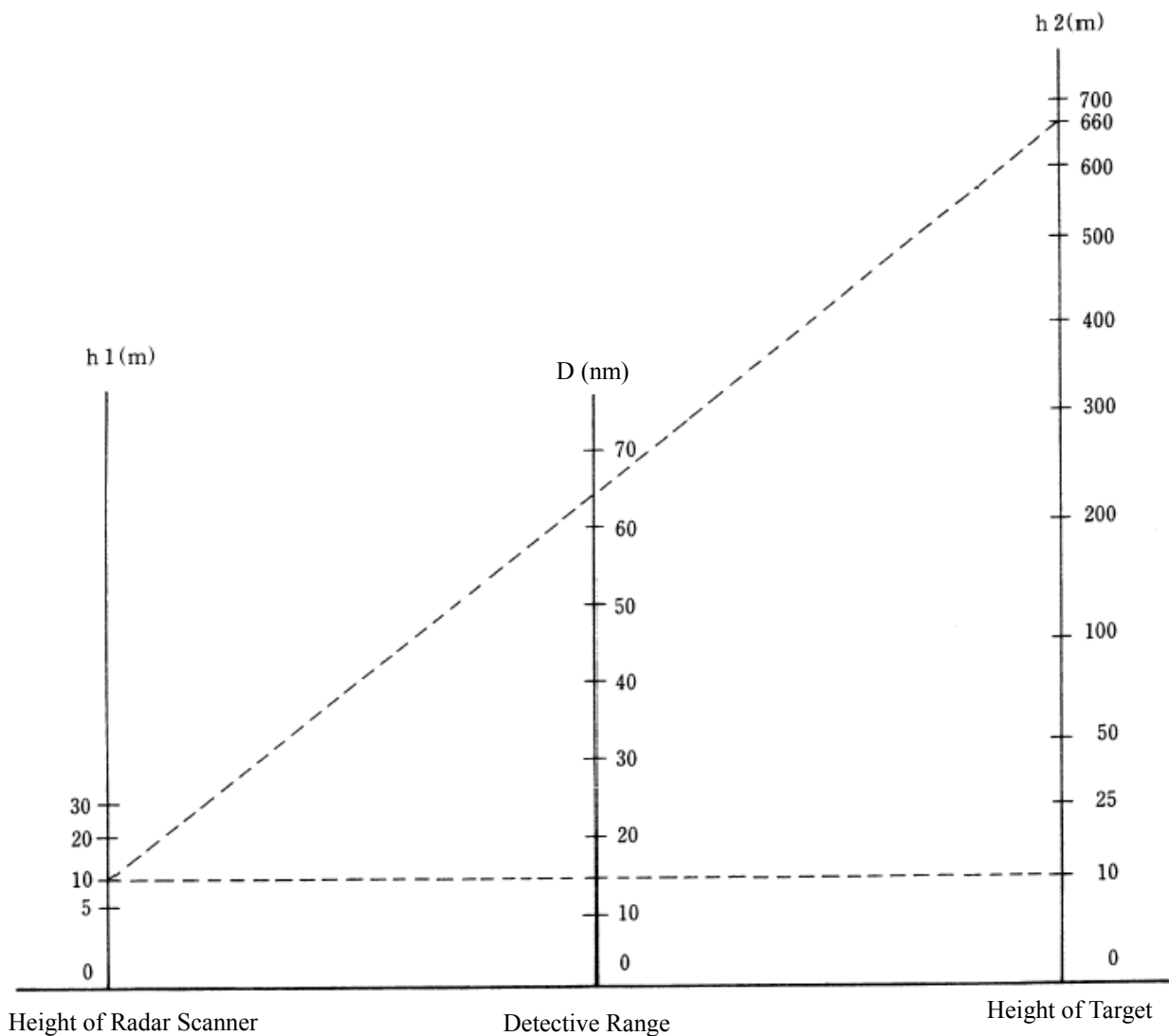

Figure 6.1

When the height of own ship's scanner is 10 m for instance,

- (a) A target that can be detected at the radar range of 64 nm on the radar display is required to have a height of 660 m or more.
- (b) If the height of a target is 10 m, the radar range has to be approx. 15 nm. However, the maximum radar range at which a target can be detected on the radar display depends upon the size of the target and the weather conditions, that is, the radar range may increase or decrease depending upon those conditions.

6.2 STRENGTH OF REFLECTION FROM THE TARGET

The signal intensity reflected from a target depends not only on the height and size of the target but also on its material and shape. The echo intensity from a higher and larger target is not always higher in general. In particular, the echo from a coast line is affected by the geographic conditions of the coast. If the coast has a very gentle slope, the echo from a mountain of the inland appears on the radar display. Therefore, the distance to the coast line should be measured carefully.

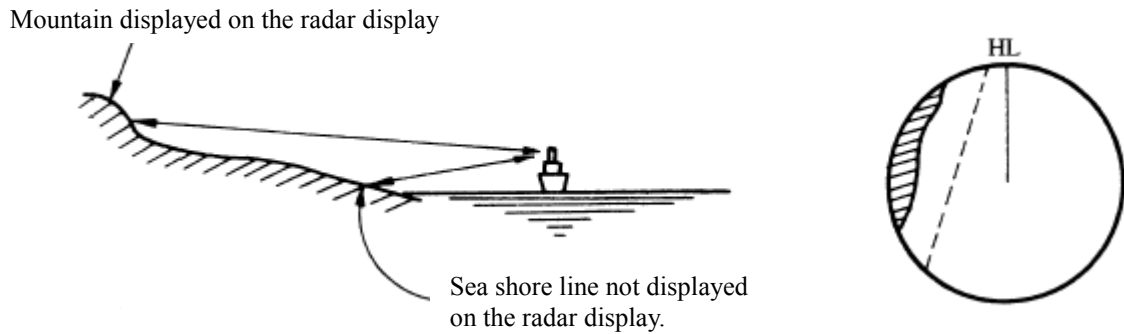

Figure 6.2

6.3 SEA CLUTTERS

When the sea surface ruffles, bright echo returns spread around the center of the radar display. The higher the waves are, the echo returns are larger. Swirling currents may appear as a smooth line like a coastal line.

6.4 FALSE ECHOES

The radar observer may be embarrassed with some echoes that do not exist actually. These false echoes appear by the following causes that are well known:

[I] Shadow

When the radar scanner is installed near a funnel or mast, the echo of a target that exists in the direction of the funnel or mast cannot appear on the radar display because the radar beam is reflected on the funnel or mast. Whether there are some false echoes due to shadows can be checked monitoring the sea clutter returns, in which there may be a part of weak or no returns.

Such shadows appear always in the same directions, which the operator should have in mind in radar operation.

[II] Side Lobe Effect

A broken-line circular arc may appear at the same range as the main lobe of the radar beam on the radar display. This type of false echo can easily be discriminated when a target echo appears isolated. (See Figure 6.3)



Figure 6.3

[III] False Echo by Secondary Reflection

When a target exists near own ship, two echoes from the single target may appear on the radar display. One of those echoes is the direct echo return from the target and the other is the secondary reflection return from a mast or funnel that stands in the same direction as shown in Figure 6.4.

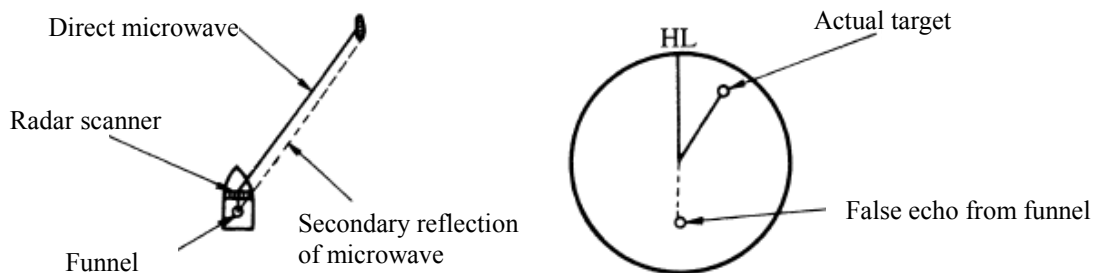

Figure 6.4

[IV] False Echo by Multiple Reflection

When there is a large structure or ship with a high vertical surface near own ship as shown in Figure 6.5, multiple reflection returns may appear on the radar display. These echoes appear in the same intervals, of which the nearest echo is the true echo of the target.

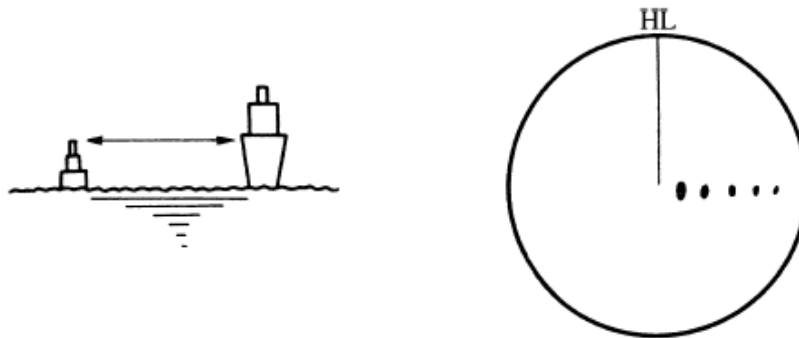

Figure 6.5

[V] Abnormal Propagation

The maximum radar detection range depends upon the height of the scanner and the height of a target as described in the section of “The Horizon for Radar Beam Radiation”. If a so-called “duct” occurs on the sea surface due to a certain weather condition, however, the radar beam may propagate to an abnormally long distance, at which a target may be detected by the radar.

For instance, assuming that the radar range is 6 NM (on the repetition frequency of 1100 Hz), the first pulse is reflected from a target at about 76 NM or more and received during the next pulse repetition time. In this case, a false echo appears at a position that is about 76 NM shorter than the actual distance.

If the false echo appears at 5 NM on the radar display, the true distance of the target is $5+76=81$ NM. On the radar range scale of 1.5 NM (on the repetition frequency of 1900 Hz), a false echo may appear at a position that is about 43 NM shorter than the actual distance.

This type of false echo can be discriminated by changing over the range scale (the repetition frequency), because the distance of the target changes accordingly.



[VI] Radar Interference

When another radar equipment using the same frequency band as that on own ship is near own ship, a radar interference pattern may appear on the radar display. This interference pattern consists of a number of spots which appear in various forms. In many cases, these spots do not always appear at the same places, so that they can be discriminated from the target echoes. (See Figure 6.6)

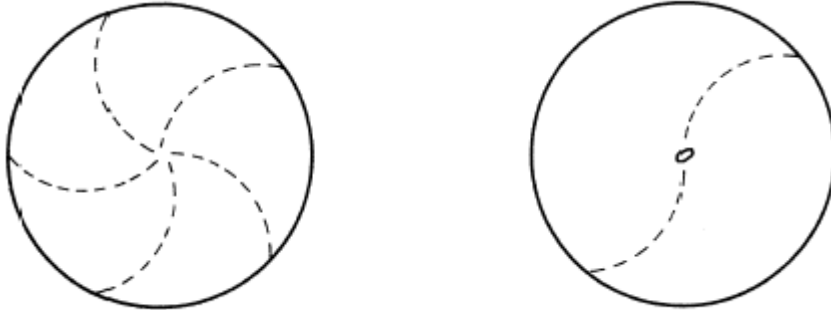

Figure 6.6

If radar equipment causing an interference pattern and this radar are of the same model, their transmitting repetition frequency is nearly the same. As a result, interference patterns may be displayed concentrically.

In this case, the interference patterns cannot be eliminated by using only the interference reflector function, so press **[TX/PRF]** several times to fine-tune the transmitting repetition frequency.

An interference suppressing effect can be heightened by applying a different transmitting repetition frequency to the interference pattern source radar and this radar.

6.5

DISPLAY OF RADAR TRANSPONDER (SART)

The SART (Search and rescue Radar Transponder) is a survival device authorized by the GMDSS (Global Maritime Distress and Safety System), which is used for locating survivors in case that a distress accident occurs at sea. The SART is designed to operate in the 9 GHz frequency band.

When receiving the 9 GHz radar signal (interrogating signal) transmitted from the radar equipment on a rescue ship or search aircraft, the SART transmit a series of response signals to inform the distress position to the rescue and search party.

* This radar provides a shortcut item to make settings for SART signal reception. Execution of this item automatically switches to the setting for SART reception.

Procedures

1 Press [RANGE +] or [RANGE -] to set the radar range to 6 NM or 12 NM.

2 Press [RADAR MENU].

The Main Menu will appear.

3 Press [5].

Each time the key is pressed, switching between ON and OFF takes place.

MAIN MENU	
1. IR	<input type="button" value="IR OFF"/>
2. Process	<input type="button" value="PROC OFF"/>
3. Target Enhance	<input type="button" value="OFF"/>
4. Zoom	<input type="button" value="OFF"/>
5. SART	<input type="button" value="ON"/>
6. NAV Information	>
8. Graphic Display	<input type="button" value="ON"/>
9. RADAR MENU(→ Plot)	
0. EXIT	



With the SART display mode set to ON, settings as shown below are made automatically.

- | | |
|------------------------------------------------------|--------------------------------------|
| (1) Sea clutter control: | Minimum (Most counterclockwise) |
| (2) AUTO SEA function: | OFF |
| (3) Rain and Snow Clutter Control (RAIN): | minimum |
| (4) Auto Rain and Snow Clutter function (AUTO RAIN): | OFF |
| (5) TUNE control: | No tuning (to weaken clutter echoes) |
| (6) Interference rejector (IR): | OFF |
| (7) PROCESS: | OFF |

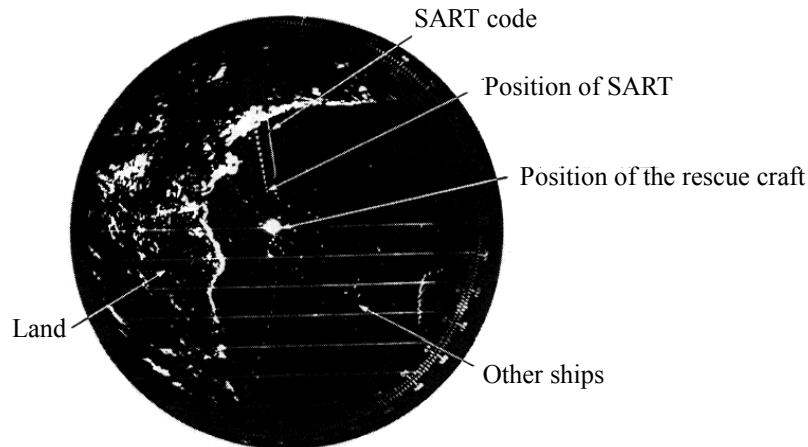

[Example of Display]

Attention

- When the SART function is set to ON to detect the SART signal, small targets around own ship will disappear from the radar display. So it is necessary to exercise full surveillance over the conditions around own ship by visual watch in order to avoid any collision or stranding. If two or more sets of radar equipment are installed on own ship, use one set of 9 GHz band radar for detection of the SART signal and operate others as normal radars for avoiding collision, monitoring targets around own ship, and checking on own ship's position and avoidance of stranding.

After end of detecting the SART signal, turn the SART display off. Then the radar returns normally to the nautical mode.

SECTION 7 MAINTENANCE

7.1	Routine Maintenance	7-1
7.2	Maintenance on Each Unit	7-2
	Scanner Unit NKE-2102/2252/1075A.....	7-2
	Display Unit NCD-4510	7-8

7.1 ROUTINE MAINTENANCE



WARNING



Never carry out internal inspection or repair work of the equipment by users.

Inspection or repair work by unauthorized personnel may result in fire hazard or electric shock.

Ask the nearest branch, business office or a dealer for inspection and repair.



Turn off the main power before maintenance work. Otherwise, an electric shock may result.



Turn off the main power before cleaning the equipment. Especially, make sure to turn off the indicator if a rectifier is used. Otherwise, equipment failure, or death or serious injury due to electric shock may result, because voltage is outputted from the rectifier even when the radar is not operating.

For operating the radar equipment in the good conditions, it is necessary to make the maintenance work as described below. If maintenance is made properly, troubles will reduce. It is recommended to make regular maintenance work.

Common points of maintenance for each unit are as follow:

Clean the equipment.

Remove the dust, dirt, and sea water rest on the equipment cabinet with a piece of dry cloth. Especially, clean the air vents with a brush for good ventilation.

7.2 MAINTENANCE ON EACH UNIT

Scanner Unit NKE-2102/2252/1075A



WARNING



Turn off the main power source before starting maintenance.

Otherwise, an electric shock or injury may be caused.



Turn off the main power if you need to be near the scanner unit for maintenance or inspection purposes. Direct exposure to electromagnetic waves at close range in death or serious injury.



Set the safety switch for stopping the scanner unit to the OFF position.

Otherwise, an accidental contact with the rotating scanner unit may cause injury.



CAUTION



Do not put watches, clocks, or magnetic cards close to the modulator unit since this unit holds magnetrons having strong magnetic force. Failure or data destruction of the above devices may result.

After finishing the maintenance work, reset the safety switch to the ON position.

Precautions in Mounting the Cover

When the cover is removed for regular checkup and replacement of parts and refitted after such work, the procedures of fastening bolts shall be taken with the following precautions:

- (a) The proper fastening torque of the fitting bolts (M8) is 1176 to 1470 N•cm (120 to 150kgf•cm) (which makes the inside water-tight and protects the packings against permanent compressive strain).
The packings start producing from the cover at a torque of approximately 1470N•cm (150kgf•cm).
Do not fasten the bolts with a torque exceeding the specified value. Otherwise, the screws may be broken.
- (b) Use an offset wrench of 11 mm × 13 mm or a double-ended wrench of 13 mm × 17 mm (not longer than 200 mm).
- (c) Screw all the bolts by hand first to prevent them playing, then fasten them evenly in order not to cause one-sided fastening. (Fasten the bolts with 25% of the required torque at the first step.)

*: Fasten the bolts in the diagonal order.

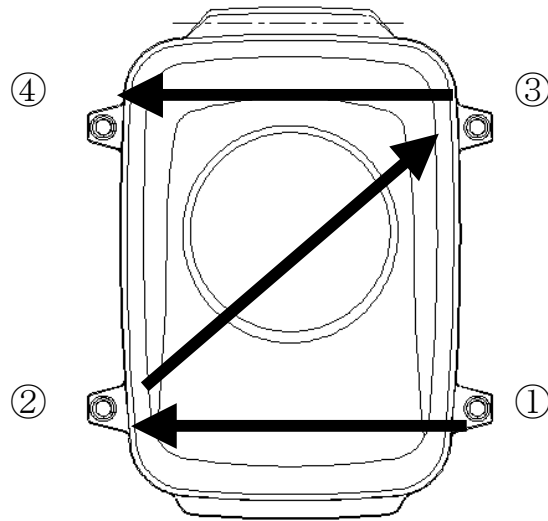

**Top View of NKE-2102
Bolt Tightening Procedure of NKE-2102 Cover**

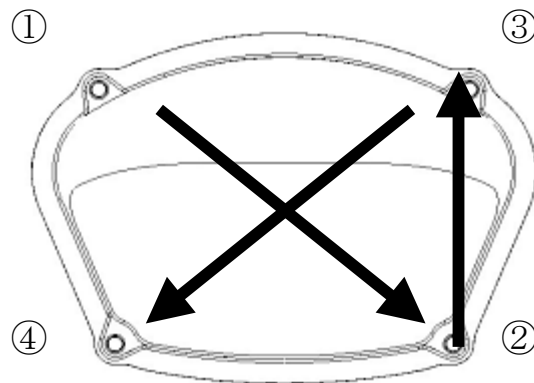

**Side View of NKE-2252
Bolt Tightening Procedure of NKE-2252 Cover**

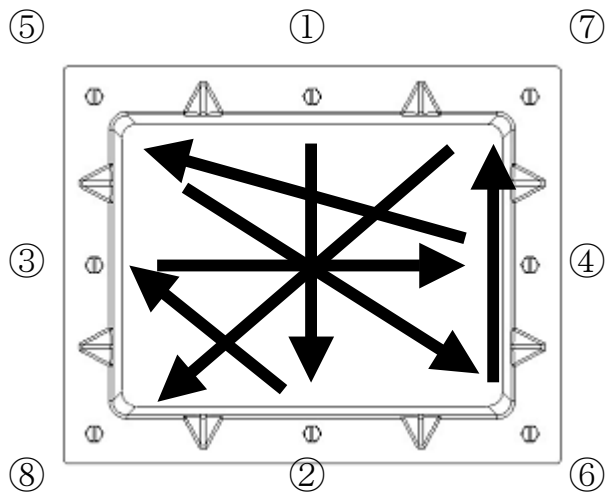

**Side View of NKE-1075A
Bolt Tightening Procedure of NKE-1075A Cover**

(1) Radiator

Attention

- **If the radiator front face (radiation plane) is soiled with smoke, salt, dust, paint or birds' droppings, wipe it with a piece of soft cloth wetted with alcohol or water and try to keep it clean at all times. Otherwise, radar beam radiation may attenuate or reflect on it, resulting in deterioration of radar performance.**
- **Never use solvents of gasoline, benzine, trichloroethylene and ketone for cleaning. Otherwise, the radiation plane may deteriorate.**

Check up and clean the radiator.

(2) Rotating section

(a) Supply Oil Seal

When there is not a grease nipple, the replenishment of grease oil is unnecessary.

Remove the cap on the grease nipple located on the side of the X band radar or on the front of S band radar at which the radiator is supported, and grease with a grease gun.

Make the oiling every six months. The oil quantity shall be approximately 100 g, which is as much as the grease comes out of the oil seal. Use the grease of Mobilux 2 of Mobil Oil.

(b) Oiling gears

Apply grease evenly to the tooth surfaces of the main shaft drive gear and the encoder drive gear with a spreader or brush. Oiling in short intervals is more effective to prevent the gears from wear and tear and extend their service life, but oil at least every six months.

Use Mobilux2 of Mobile Oil.

(c) Mounting legs

Check the mounting legs and mounting bolts of the scanner unit case for corrosion at intervals and maintain them to prevent danger. Apply paint to them once a half year because painting is the best measure against corrosion.

Display Unit NCD-4510**WARNING**

When cleaning the screen, do not wipe it too strongly with a dry cloth. Also, do not use gasoline or thinner to clean the screen. Otherwise the screen surface may be damaged.

Dust accumulated on the screen will reduce clarity and darken the video. For cleaning it, wipe it with a piece of soft cloth (flannel or cotton). Do not wipe it strongly with a piece of dry cloth nor use gasoline or thinner.

SECTION 8 TROUBLE SHOOTING AND ADJUSTMENT

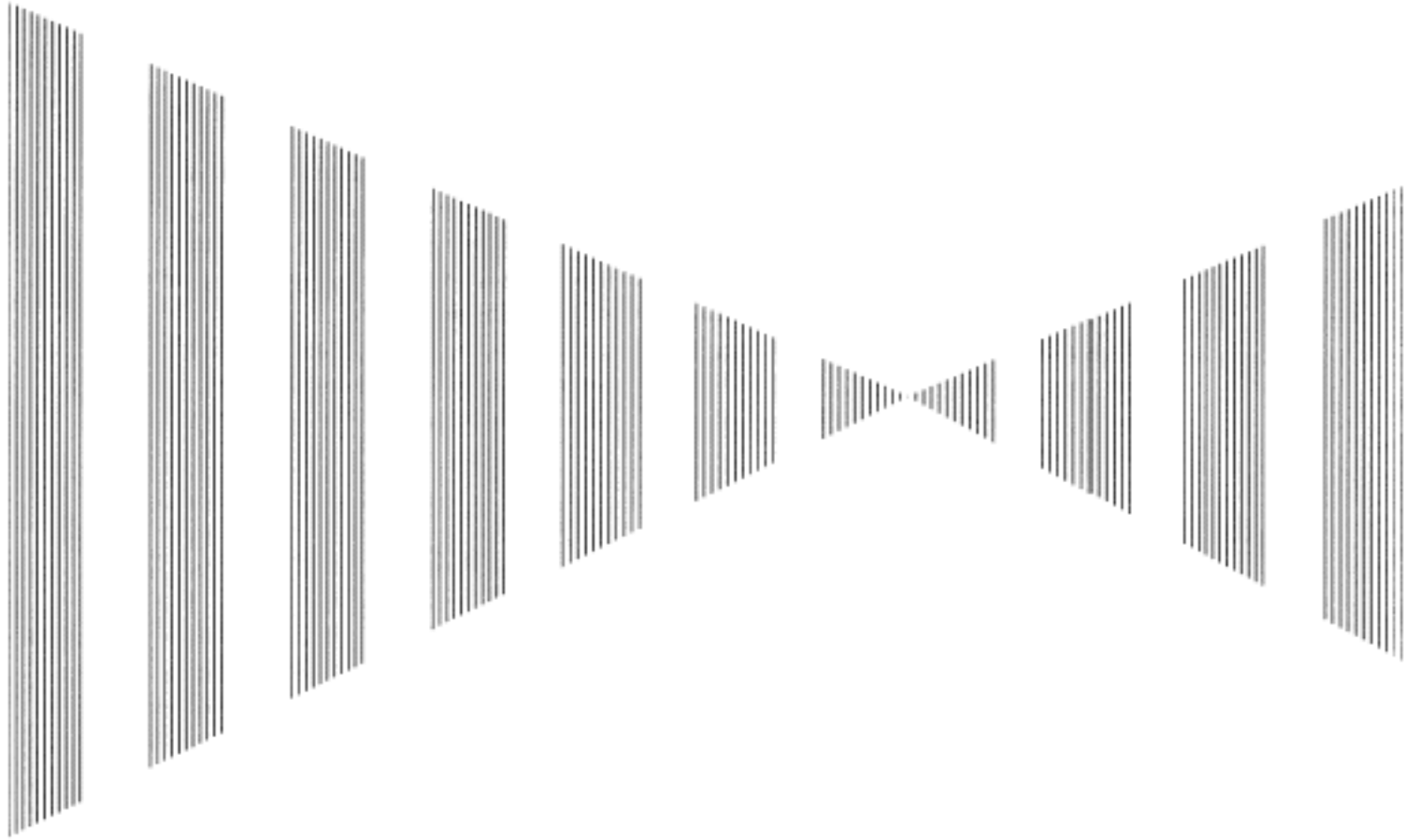

8.1	Performance Check.....	8-1
8.2	Fault Finding.....	8-21
8.3	Trouble Shooting.....	8-22
8.4	Replacement of Major Parts	8-27
8.5	Adjustments.....	8-30
8.6	Setting	8-62

8.1 PERFORMANCE CHECK

Make operational check on the radar equipment regularly and if any problem is found, investigate it immediately. Pay special attention to the high voltage sections in checking and take full care that no trouble is caused by any error or carelessness in measurement. Take note of the results of checking, which can be used effectively in the next check work.

Operational check shall be made in accordance with Table 8-1 Function Check List in the order as specified in it.

Table 8-1 Check List

Equipment	Item to be checked	Criteria	Remarks
Transmitter-receiver Unit	Tuning LED of Receiver	The LED is lighting during operation	48NM range
Display Unit	Video and echoes on the screen Sensitivity LCD brilliance can be controlled correctly Various markers Various numerical indications Lighting	Can be correctly controlled	
	Safety Switch Various Currents and Voltages	See 8-5.	
	Communications Lines	See 8-6.	
	Memory	See 8-4.	
	Panel	See 8-8, -9, -10, -11.	
	Monitor	See 8-7.	
	ARPA	See 8-42.	
	Magnetron current	See 8-18.	
	Performance Monitor	See 8-12.	
	Error Logging Display	See 8-13.	
System Information Display	See 8-17.		

Check Performance on Test Menu

The performance status of this radar equipment can be checked on the TEST Menu.

Self Test	[I] Self-diagnostic function
Monitor Test	[II] Monitor check
Keyboard Test	[III] Operation panel check
PM Display	[IV] Performance monitor
Error Logging	[V] Error log display
System INFO	[VI] System information display
MAGI	[VII] Indication of magnetron current

* Execution of PM Display requires a PM unit.

Procedures

- 1 Press [RADAR MENU] key twice.

Press [8] key.

Press [9] key.

The TEST Menu will appear.

* Button  on the radar display on page 2-7 is also available.

- 2 Select the check item you want to check, pressing the numeric keys [1] to [6] on Test Menu.

The list of check items will appear.

Exit

- 1 Press [RADAR MENU] key.

The TEST Menu will be closed.

Test Menu

1. Self Test

2. Monitor Test

3. Keyboard Test

4. PM Display ON

5. Error Logging

6. System INFO

MAGI

0. EXIT

[I] **Self-diagnosis function**

Check of Memory, Scanner Unit, and Communications Lines

Memory Test	1) Memory check
Sensor Test	2) Antenna check
Line Test	3) Communication line check

Procedures 1 **Press [1] key while the Test Menu is open.**

The SELF TEST Menu will appear.

2 **Select the item you want to check, pressing numeric keys [1] to [3] .**

The SELF CHECK Menu will appear.

Exit 1 **Press [RADAR MENU] key.**

The Self Test Menu will be closed.

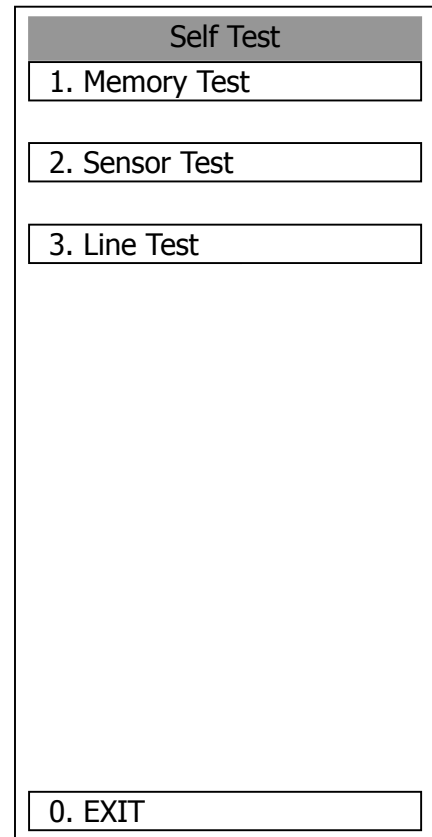

1) Memory Test

Checks for the performance of built-in memory.

SDRAM	SDRAM check
SRAM	SRAM check
FLASH ROM	Flash ROM check
GRAPHIC	Graphic check

Procedures

- 1 Press [1] key while the Self Test menu is open.**

The Memory Test Menu will appear.

- 2 Select the item you want to check, pressing numeric keys [1] to [4].**

When no abnormality is found, OK is displayed.

When an abnormality is found, NG is displayed.

Exit

- 1 Press [RADAR MENU] key.**

The menu will be closed.

Memory Test	
1. SDRAM	OK
2. SRAM	OK
3. FLASH ROM	OK
4. GRAPHIC	OK
0. EXIT	

2) Sensor Test

Checks for signals from the antenna.

Safety Switch	Antenna's safety switch check
AZI Pulse	Antenna rotation signal check
HL Pulse	Heading line signal check
MH Current	Check on the load current of high voltage in the modulator
Trigger	Radar trigger signal check
Video	Radar video check

Procedures

- 1 Press [2] key while the Self Test menu is open.

The Sensor Test menu will appear.
 When no abnormality is found, OK is displayed.
 When an abnormality is found, NG is displayed.
 In standby, ** will appear.

Exit

- 1 Press [RADAR MENU] key.

The menu will be closed.

Sensor Test	
※ Safety Switch	OK
※ AZI Pulse	OK
※ HL Pulse	OK
※ MH Current	OK
※ Trigger	OK
※ Video	OK
0. EXIT	

3) Check of Communication Lines

Check the status of communications with options.

MTR	Check on connection with the transmitter-receiver
SIG.PROC	Check on connection with the signal processing circuit
ATA	Check on connection with the ARPA processing circuit
NSK	Check on connection with the NSK unit
GPS Compass	Check on connection with the GPS compass
ISW	Check on connection with the interswitch
COM1	Check on connection with COM1
COM2	Check on connection with COM2
COM3	Check on connection with COM3
COM4	Check on connection with COM4

Procedures

- 1 Press [3] key with the Self Test menu open.

The Line Test menu will appear.
 When no abnormality is found, OK is displayed.
 When an abnormality is found, NG is displayed.

The status display field of equipment not connected is left blank.

Exit

- 1 Press [RADAR MENU] key.

The menu will be closed.

Line Test

※ MTR	OK
※ SIG.PROC	OK
※ ATA	OK
※ NSK	OK
※ GPS Compass	OK
※ ISW	OK
※ COM1	OK
※ COM2	OK
※ COM3	OK
※ COM4	OK
0. EXIT	

[II] **Monitor Test**

Checks for the monitor.

Procedures

- 1 Press [2] key while the Test Menu is open.**

The Monitor Test Menu will appear.

- 2 Select the item number you want to display, pressing numeric keys [1] to [5] of the test pattern.**

The selected test pattern will be displayed.

Pattern 1: All colors are filled with white.

Pattern 2: A white box is displayed on the black background of 1280 × 1024 dots.

Pattern 3: Displays rectangle × 2, circle × 2, and cross-shape × 13 (white lines on the black background).

Pattern 4: Displays “H” of 9 dots × 9 dots on the entire screen (white character on the black background).

Pattern 5: Gray scale display (16 levels)

Pattern 6: Displays a color bar.

- 3 To return to the original display, press any key.**

If errors occur in the monitor, no test pattern will appear.

Monitor Test
1. Pattern 1
2. Pattern 2
3. Pattern 3
4. Pattern 4
5. Pattern 5
0. EXIT

Exit

- 1 Press [RADAR MENU] key.**

The menu will be closed.

[III] Operation Panel Test

Checks for the controls and switches of the operation panel.

Key Test	1) Key check
Buzzer Test	2) Buzzer check
Light	3) Keyboard light check

Procedures

- 1 Press [3] key while the Test Menu is open.**

The Keyboard Test Menu will appear.

- 2 Select the item number you want to check, pressing numeric keys [1] to [3] of the item.**

The check contents will be displayed.

Exit

- 1 Press [RADAR MENU] key.**

The menu will be closed.

Keyboard Test

1. Key Test

2. Buzzer Test

3. Light

0. EXIT

2) Buzzer Test

Checks for the operation panel buzzer.

Procedures

- 1 **Press [2] key while the Keyboard Test menu is open.**

The buzzer will sound.

- 2 **The buzzer will sound for a given length of time.**

Exit

- 1 **Press [RADAR MENU] key.**

The menu will be closed.

Keyboard Test
1. Key Test
2. Buzzer Test
3. Light
0. EXIT

3) Light

Checks for the operation panel light.

Procedures

- 1 Press [3] key while the Keyboard Test menu is open.

The brightness of the operation panel is gradually intensified at four levels.

Exit

- 1 Press [RADAR MENU] key.

The menu will be closed.

Keyboard Test
1. Key Test
2. Buzzer Test
3. Light
0. EXIT

[IV] PM Display

Displays the bar indicating the performance monitor status.
 * Execution of this item needs a PM unit.

Procedures

- 1 Press [4] key while the Test Menu is open, and set PM Display to ON.

The PM bar will appear under the MAGI bar.

The setting of PM Display is switched back and forth between ON and OFF each time [4] is pressed.

Exit

- 1 Press [RADAR MENU] key.

The menu will be closed.

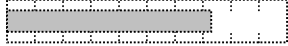
Test Menu	
1. Self Test	
2. Monitor Test	
3. Keyboard Test	
4. PM Display	ON
5. Error Logging	
6. System INFO	
MAGI	
PM	
0. EXIT	

[V] Error Logging

When a system error occurs, this function shows the error communication line in reverse video. Errors that have been reset are also displayed in time series.

Procedures

- 1 Press [5] key while the Test Menu is open.

The Error Logging Menu will appear.

- 2 Error logs will be displayed in the dotted area in the figure at right.

For the display contents, refer to Table 8-2.

Press [1] key to clear all the error logs.

Exit

- 1 Press [RADAR MENU] key.

The menu will be closed.

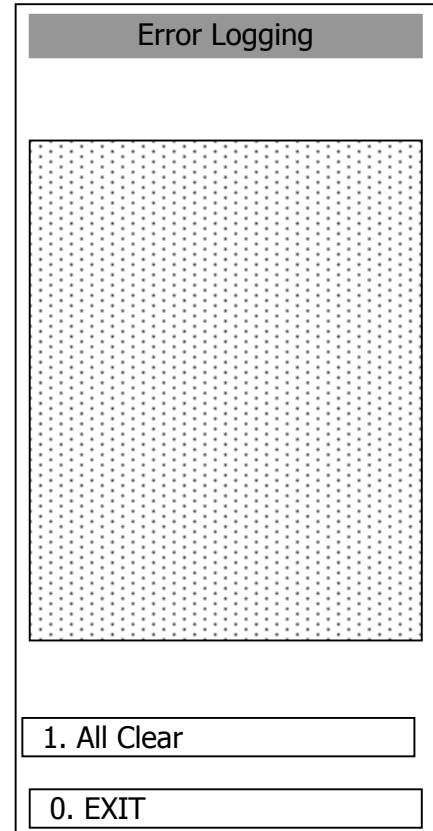

Table 8-2 List of System Error Message (1)

TRX(SSW OFF)	Scanner: Safety switch OFF
TRX(AZI)	Scanner: BP error
TRX(HL)	Scanner: HL error
TRX(MHV)	Scanner: Modulator's high voltage alarm
TRX	Scanner: No communication
TRX(DATA)	Scanner: Communication software version mismatched, checksum error, or collision
TRX(HEATER)	Scanner: Magnetron heater voltage alarm
TRX(REVERSE)	Scanner: Reverse rotation
TRX(VIDEO)	Scanner: VIDEO error
TRX(TRIGGER)	Scanner: TRIGGER error
TRX(FAN 1)	Scanner: FAN 1 alarm
TRX(FAN 2)	Scanner: FAN 2 alarm
TRX(STAB0)	Stabilizer error
TRX(STAB1)	Stabilizer error
TRX(STAB2)	Stabilizer error
TRX(STAB3)	Stabilizer error
TRX(STAB4)	Stabilizer error
TRX(STAB5)	Stabilizer error
TRX(STAB6)	Stabilizer error
TRX(STAB7)	Stabilizer error
TRX(STAB8)	Stabilizer error
TRX(STAB9)	Stabilizer error
TRX(STAB10)	Stabilizer error
TRX(STAB11)	Stabilizer error
TRX(STAB12)	Stabilizer error
TRX(STAB13)	Stabilizer error
TRX(STAB14)	Stabilizer error
TRX(STAB15)	Stabilizer error
TRX(HEATER SUB)	Scanner: Magnetron heater voltage alarm (non-selected side of 2 frequencies)
TRX(MHV SUB)	Scanner: Modulator's high voltage alarm (non-selected side of 2 frequencies)
TRX(MOTOR)	Scanner: Motor current alarm
PANEL	Operation PANEL: Communication error
PANEL(DATA)	Operation PANEL: Checksum error
PANEL2	Operation PANEL2: Communication error
PANEL2(DATA)	Operation PANEL2: Checksum error
NSK	NSK: No communication
NSK(GYRO)	NSK: GYRO error (error bit detected)
NSK(DATA)	NSK: Checksum error (when receiving data from LOCAL CPU)
LOG	NSK: Logging error (error bit detected)
ISW	ISW: No communication
ISW(DATA)	ISW: Data inconsistency, or checksum error

Table 8-3 List of System Error Message (2)

DLOG	2-axis log: No communication
DLOG(DATA)	2-axis log: Data error
GPS	GPS: No communication
GPS(DATA)	GPS: Data error
GPS(STATUS)	GPS: Status error
PROC(BOOT)	Signal processing unit: Boot error
PROC(INT)	Signal processing unit: Interrupt error
PROC(AZI)	Signal processing unit: BP error
PROC(HL)	Signal processing unit: HL error
ATA(BOOT)	ARPA: Boot error
ASIC(INT)	Error during interrupt to ASIC1
ASIC1 to RADAR	Error during interrupt from ASIC1 to RADAR DSP
RADAR to ASIC2	Error during interrupt from RADAR DSP to ASIC2
ASIC1 to ARPA	Error during interrupt from ASIC1 to ARPA DSP
ARPA to ASIC2	Error during interrupt from ARPA DSP to ASIC2
ASIC to LOCAL CPU	Error during interrupt from ASIC1 to LOCAL CPU
PROC(VIDEO)	VIDEO error
PROC(TRIGGER)	Trigger error
AIS	AIS: No communication
AIS(DATA)	AIS: Communication error
AIS I/F	AIS I/F: No communication
AIS I/F(DATA)	AIS I/F: Communication error
AIS ALARM ***	AIS alarm (Up to 10 alarm messages can be displayed.)
COM1	COM1 port alarm
COM2	COM2 port alarm
COM3	COM3 port alarm

Table 8-4 List of System Error Message (3)

COM4	COM4 port alarm
HEADING	Heading data: No communication
HEADING(DATA)	Heading data: Data error
DEPTH	Water depth: No communication
DEPTH(DATA)	Water depth: Data error
TEMP	Water temperature: No communication
TEMP(DATA)	Water temperature: Data error
WIND	Wind direction/velocity: No communication
WIND(DATA)	Wind direction/velocity: Data error
CURRENT	Tidal current: No communication
CURRENT(DATA)	Tidal current: Data error

Reference: An error message and a warning will appear at the lower right of the radar display.

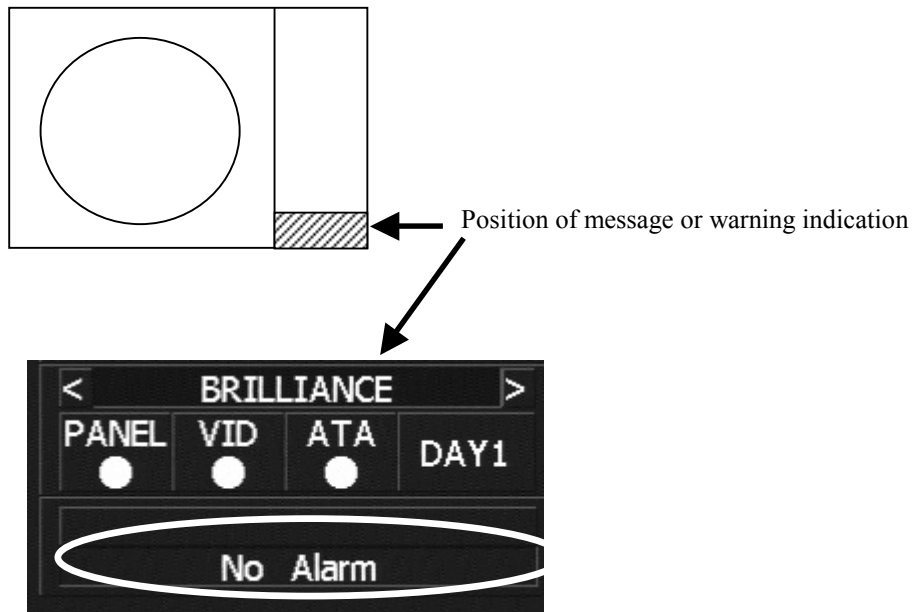

[VI] System INFO

Displays the current system information.

Indicator	Processor software version information
MTR	Scanner software version information
System No.	System number
TX Time	Total transmitting time (Total time during which radar was transmitted)
Total Time	Total operating time (Total power-on time)

Procedures 1 Press [6] key while the Test Menu is open.

The System INFO Menu will appear.

Exit 1 Press [RADAR MENU] key.

The menu will be closed.

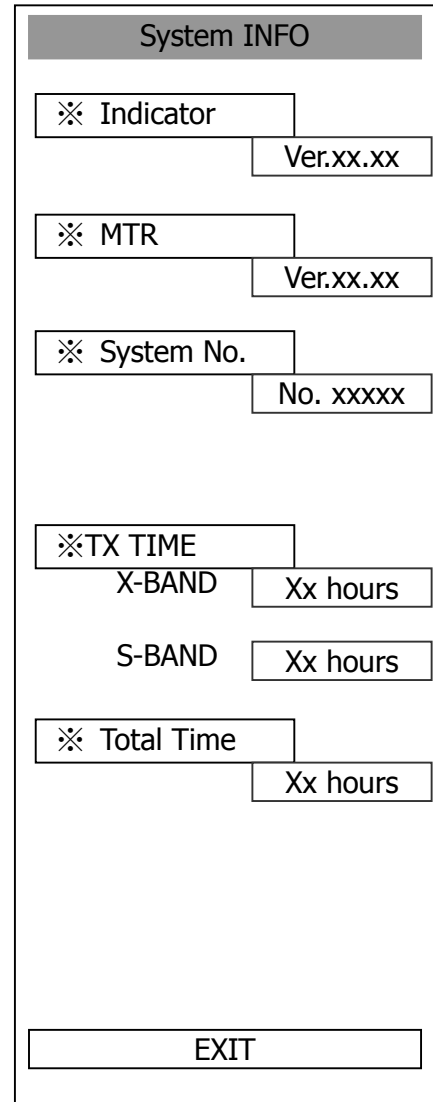

[VII] MAGI

Displays the MAGI bar indicating the magnetron current to check.

Procedures

- 1 Check if the MAGI bar in the Test Menu reads the value below in a range of 24 NM.

10 kW: 4 to 5 scale marks
25 kW: 5 to 8 scale marks

Exit

- 1 Press [RADAR MENU] key.

The menu will be closed.

Test Menu	
1. Self Test	
2. Monitor Test	
3. Keyboard Test	
4. PM Display	<input type="checkbox"/> ON
5. Error Logging	
6. System INFO	
MAGI	
0. EXIT	

List of Alarms and other Indications

Table 8-5 List of Gyro Alarms

Message	Description
SET GYRO	Requires setting of true bearing.
TM RESET	Use care of resetting TM.
POSN RESET	Change the latitude and longitude sentence.

Table 8-6 List of ARPA Alarms

Message	Description
CPA/TCPA	Closest approach point/Time for reaching the closest approach point (ARPA)
GZ	A target exists in a guard zone.
LOST	A target under acquisition cannot be tracked.

Table 8-7 List of Operational Error Messages and Warnings

Message	Description
NO HEADING DATA	ARPA operation or TM selection when bearing data is invalid
NO POSITION DATA	Mark or line input when the latitude and longitude is invalid.
OUT OF RANGE	ARPA out of acquisition range
CHANGE RANGE	TM selection due to TM-disabled range (96 or 120 nm) Zooming in a ZOOM-disabled range (0.125 nm)
MAX POINT	Tried to enter navigation information beyond the specified.
CAN'T TRANSMIT	Tried to transmit within 1 second after standby or when the transmitter-receiver has any trouble.
INVALID DATA	Tried to enter any data beyond its range.
MAX TARGET	The maximum number of targets of ARPA is under acquisition.
SELECT STRAIGHT	The operator set PM to ON without selecting straight.
NO CARD	Card not detected yet
CARD FULL	Card capacity insufficient
FORMAT CARD	Unformatted card
INVALID CARD	Invalid card
READ FAILED	Read failure
WRITE FAILED	Write failure
DELETE FAILED	Deletion failure
FORMAT FAILED	Format failure
COPY FAILED	Copy failure
NOT ALLOWED	General operation error

Table 8-8 List of Interswitch Alarms and Messages

Message	Description
MASTER RANGE CHG	The range of the own display unit has changed due to change in the range of the master display unit.
ALREADY SLECTED	Selected the already selected pattern.
ISW END!	The switchover of the Interswitch ended normally.
ISW BUSY!	Access to the ISW menu was made during interswitching.
TRX ST-BY!	The scanner unit is in the standby mode.
ISW STRAIGHT	Failed in straight connection when the Interswitch system stops operating.
ISW STAND-BY!	The Interswitch recovered normally.
ISW TIME OUT	Failed in switching.
ISW ERROR!	The interswitch is disabled.

Message set off in a failure of the monitor fan

When a failure has occurred in the monitor fan, the monitor displays LCD FAN FAILURE at the center. This display will disappear by pressing the BRIGHTNESS knob on the monitor. In order to replace the monitor fan, contact our service department, or the distributor.

8.2 FAULT FINDING

In case of semiconductor circuits, it is deemed that there are few cases in which the used semiconductor devices have inferior quality or performance deterioration except due to insufficient design or inspection or by other external and artificial causes. In general, the relatively many causes are disconnection in a high-value resistor due to moisture, a defective variable resistor and poor contact of a switch or relay.

Some troubles are caused by defective parts, imperfect adjustment (such as tuning adjustment) or insufficient service (such as poor cable contact). It will also be effective to check and readjust these points.

Melted fuses are caused by any clear cause. When a fuse is replaced, it is necessary to check the related circuits even if there is no trouble. In checking, note that there is some dispersion in the fusing characteristics. Table 8-12 shows a list of fuses used in the equipment.

Table 8-12 Fuse List

Location	Parts No.	Current Rating	Protection Circuit	Type
Transmitter-receiver Unit	F1	1A	Rectifier circuit PC1001	MF51NN-1A
Display Unit	F2 to F3	10A	I/O circuit PC410	MF60NR-10A
LOG.NSK circuit	F1 to F4	0.5A	LOG.NSK circuit PC4201	MF60NR-0.5A

8.3 TROUBLE SHOOTING

As this radar equipment includes complicated circuits, it is necessary to request a specialist engineer for repair or instructions for remedy if any circuit is defective.

There are also troubles by the following causes, which should be referred to in checking or repair work.

1 Poor Contact in Terminal Board of Inter-Unit Cables

- a) Poor contact in terminal board
- b) The cable end is not fully connected, that it, contacted with earthed another terminal.
- c) Disconnected cable wire

2 Poor Contact of Connector within Unit

Reference: This radar equipment is provided with 8-13 standard spares.

Table 8-13 Spares (7ZXRD0014, JMA-5310-6, 7ZXRD0015, JMA-5320-7/9/6HS, JMA-5330-12)

7ZXRD0014

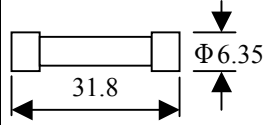
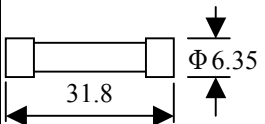
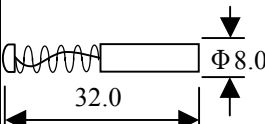
Name	Type/Code	Shape (mm)	In use	Spare	Parts No.	Location
Fuse	ST4-5AN1 (5ZFCA00050)		1	3	F2	Inside processing unit
Fuse	ST6-8AN1 (5ZFCA00052)		1	3	F3	Inside processing unit
Motor brush	54583-01 (BRSW00101)		1	2	—	Scanner monitor



7ZXRD0015

Name	Type/Code	Shape (mm)	In use	Spare	Parts No.	Location
Fuse	ST6-10AN1 (5ZFCA00053)		1	3	F2	Inside processing unit
Fuse	ST6-10AN1 (5ZFCA00053)		1	3	F3	Inside processing unit

Table 8-14 Special Parts

[I] JMA-5310-6

Parts No.	Name	Type	Manufacturer	Location	Code
V101	Magnetron	MSF1425B	NJRC	Scanner	5VMAA00051
A101	Circulator	FCX68	Toshiba	Scanner	6AJRD00001
A102	Diode Limiter	NJS6930	NJRC	Scanner	5EZAA00024

[II] JMA-5320-7/9/6HS

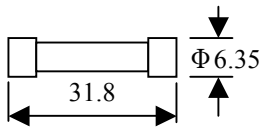
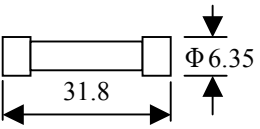
Parts No.	Name	Type	Manufacturer	Location	Code
V1	Magnetron	M1568B(J)	NJRC	Scanner	5VMAA00082
A101/A102	Circulator	FCX68	Toshiba	Scanner	6AJRD00001
A303	Diode Limiter	NJS6930	NJRC	Scanner	5EZAA00024

[III] JMA-5330-12

Parts No.	Name	Type	Manufacturer	Location	Code
V1	Magnetron	M1302	NJRC	Scanner	5VMAA00032
A101	Circulator	NJC3320	NJRC	Scanner	5AJBV00004
A303	TRHPL	TL378A	NJRC	Scanner	5VLAA00032

Table 8-15 Circuit Block to be Repaired (JMA-5310-6)

Location	Circuit Block	Type	Remarks
Scanner	Motor with gear	CBP-139	DC brush motor (ordinary)
Scanner	Modulator	CPA-248	Excluding Magnetron
Scanner	Receiver	NRG-226	Including CAE-475-1
Scanner	Power supply circuit	CBD-1645	
Processor	Radar processing circuit	CDC-1198	PC440
Processor	DSP circuit (ARPA)	CDC-1186A	PCI (Option)
Processor	DSP circuit (MARPA)	CDC-1186B	PCI (Option)
Processor	NSK/LOG I/F circuit	CMJ-304C	PC4201 (Option)
Processor	Terminal board circuit	CQD-1937	PC430
Processor	I/O circuit	CQC-1075	PC410
Processor	Power circuit	CBD-1655	PC510
Operation panel unit	Operation panel unit	CCK-905	PC600
Operation panel unit	PS2 connector circuit	CQC-1095	PC610
Multi-function control	Operation circuit	CCK-914	PC601 (Option)
Multi-function control	PS2 connector circuit	CQC-1109	PC610 (Option)
Junction Box	Interface circuit	CMH-1994	PCI (Option)
Display	Monitor fan	109R0812H4D01	

Table 8-16 Circuit Block to be Repaired (JMA-5320-7/9/6HS)

Location	Circuit Block	Type	Remarks
Scanner	Motor with gear	H-7BDR0044	DC brushless motor (ordinary speed)
Scanner	Motor with gear	H-7BDRD0045	DC brushless motor (high speed)
Scanner	Modulator	NMA-499-1	Including CPA-209-1 Including CFR-161 Excluding Magnetron
Scanner	Receiver	NRG-154	Including CAE-344
Scanner	Power supply circuit	CBD-1682	
Scanner	T/R control circuit	CMC-1205	
Scanner	Motor power supply circuit	CBH-3	
Scanner	Motor power supply circuit	CSA-283	
Processor	Radar processing circuit	CDC-1198	PC440
Processor	DSP circuit (ARPA)	CDC-1186A	PCI (Option)
Processor	DSP circuit (MARPA)	CDC-1186B	PCI (Option)
Processor	NSK/LOG I/F circuit	CMJ-304C	PC4201 (Option)
Processor	Terminal board circuit	CQD-1937	PC430
Processor	I/O circuit	CQC-1075	PC410
Processor	Power circuit	CBD-1655	PC510
Operation panel unit	Operation panel unit	CCK-905	PC600
Operation panel unit	PS2 connector circuit	CQC-1095	PC610
Multi-function control	Operation circuit	CCK-914	PC601 (Option)
Multi-function control	PS2 connector circuit	CQC-1109	PC610 (Option)
Display	Monitor fan	109R0812H4D01	





Table 8-17 Circuit Block to be Repaired (JMA-5330-12)

Location	Circuit Block	Type	Remarks
Scanner	Motor with gear	MPEM30030	220VAC 3-phase
Scanner	Motor with gear	MPEM30110	220VAC 3-phase
Scanner	Motor with gear	MPEM30092	110VAC 1-phase
Scanner	Modulator	NMA-534-1	Including CPA-209 Including CFR-161 Excluding Magnetron
Scanner	Receiver	NRG-222	Including CAE-344-4 Including CAF-424 Including CGH-205 Including CBD-1274
Scanner	T/R control circuit	CMC-1205	PC1101
Scanner	Power supply circuit	CHD-1682	
Processor	Signal processing circuit	CDC-1198	PC440
Processor	DSP circuit (ARPA)	CDC-1186A	PCI (Option)
Processor	DSP circuit (MARPA)	CDC-1186B	PCI (Option)
Processor	NSK/LOG I/F circuit	CMJ-304C	PC4201 (Option)
Processor	Terminal board circuit	CQD-1937	PC430
Processor	I/O circuit	CQC-1075	PC410
Processor	Power circuit	CBD-1655	PC510
Operation panel unit	Operation panel unit	CCK-905	PC600
Operation panel unit	PS2 connector circuit	CQC-1095	PC610
Multi-function control	Operation circuit	CCK-914	PC601 (Option)
Multi-function control	PS2 connector circuit	CQC-1109	PC610 (Option)
Display	Monitor fan	109R0812H4D01	

8.4 REPLACEMENT OF MAJOR PARTS



CAUTION

-  Turn off the main power source before replacing parts. Otherwise, an electric shock or trouble may be caused.
-  Before replacing the magnetron, turn off the main power source and wait for 5 minutes or more until the high voltage circuits are discharged. Otherwise, an electric shock may be caused.
-  Take off your wrist watch when bringing your hands close to the magnetron. Otherwise, your watch may be damaged because the magnetron is a strong magnet.
-  Two or more persons shall replace the liquid crystal monitor.
If only one person does this work, he may drop the LCD, resulting in injury.
-  Even after the main power source is turned off, some high voltages remain for a while.
Do not contact the inverter circuit in the LCD with bare hands. Otherwise, an electric shock may be caused.



Parts Required for Periodic Replacement

Here are parts required for periodic replacement

Part name	Interval
1. Magnetron	4000 hours
2. Motor	10000 hours
3. LCD backlight	50000 hours
4. Fan motor	20000 hours
5. Backup battery	3 years

Replacement of magnetron (V1/V201)

Remove the shield cover of the modulator and check that no charge remains in the high-voltage modulator circuit. Then, remove the socket of the magnetron. The magnetron can be demounted by removing the screws fixing it. When mounting a new magnetron, do not touch the magnet with a screwdriver or put it on an iron plate. After replacement, connect the lead wire correctly.

Handling of Magnetron under Long-Time Storage

The magnetron that has been kept in storage for a long time may cause sparks and operate unstably when its operation is started. Perform the aging in the following procedures:

- (1) Warm up the cathode for a longer time than usually. (20 to 30 minutes in the STBY state.)
- (2) Start the operation from the short pulse range and shift it gradually to the longer pulse ranges. If the operation becomes unstable during this process, return it to the standby mode immediately. Keep the state for 5 to 10 minutes until the operation is restarted.

Replacement of TRHPL (A303)(JMA-5330-12)

Remove the 4 screws fixing the TRHPL with receiver and remove the TRHPL. When mounting the TRHPL, take care of the mounting direction and mount it in the arrow direction facing it the receiver front end.

Replacement of Diode Limiter (A303)(JMA-5310-6, JMA-5320-7/9/6HS)

Remove the 4 screws fixing the receiver. Remove the 4 screws fixing the diode and the limiter, and remove diode limiter. When mounting the diode limiter, take care of the mounting direction and mount it in the arrow direction facing it the receiver front end.

Connect the wiring in the same way as before the replacement.

Replacement of LCD Monitor

Attention

- **When replacing the LCD monitor, which is easily broken by a little impact, handle it carefully and do not hit any article against it or put it on a hard article.**

1 JMA-5310-6, JMA-5320-7/9/6HS, JMA-5330-12 (Display Unit: NCD-4510)

- (1) Disconnect the cables from the connectors “VIDEO” and “VIDEO DC OUT” on the rear of the processor.
- (2) Softly place the LCD monitor on a desk covered with a soft cloth.
- (3) Attach a new LCD monitor in the reverse sequence as described above.

8.5 ADJUSTMENTS

This section describes the electrical adjustments of the equipment as the adjustment procedures to be carried out by service persons at the time of installation.

 **CAUTION**

-  **Do not carry out the adjustments of the equipment except authorized service persons. If wrong setting is carried out, this may cause unstable operation.**

-  **Do not carry out the adjustments during navigation. Otherwise, the radar performance may be affected, resulting in an accident or trouble.**

Tuning, bearing and range adjustments can be made from the operation panel. Start the adjustment mode in the following procedures.

How to open the Adjust Menu

Procedures

- 1 **Continue to press [RADAR MENU] key.**

The Code Input Menu will appear.

- 2 **Press [0] key.**
- 3 **Move the cursor onto the “ENT” button in the Code Input menu, and press [ENT] key.**

The Adjust Menu will appear.

Code Input
Press “0” and “ENT”
to Adjust Menu

1	2	3
4	5	6
7	8	9
+	0	-
CLR	ENT	

4 Press [1] key.

The Equipment Setup Menu will appear.

Adjust Menu
1. Equipment Setup
2. Maintenance Menu
9. SP/ATA INIT Setup
0. EXIT

Equipment Setup	
1. Bearing Adjustment	0.0°
2. Range Adjustment	0
3. Tune Adjustment	0
4. TRX Setting	
5. COM Port Setting	
6. NAV Setting	
7. Sector Blank	
9. Language	ENGLISH
0. EXIT	

Exit

1 Press [RADAR MENU] key.

The Main Menu will reappear.

Tuning Adjustment

Procedures

- 1 Open the Equipment Setup Menu.

- 2 Press [3] key.

The Code Input Menu will appear.

- 3 Using numeric pad, enter the value and then press “ENT” button, and press “EXIT” button to determine the value.

The multi-function control can also be used to enter the value.

- 4 Repeat Step 3, and adjust the bar-graph of the tuning indicator on the upper left of the display so that it becomes the longest.

Exit

- 1 Press [RADAR MENU] key.

The Main Menu will reappear.

Equipment Setup	
1. Bearing Adjustment	<input type="text" value="0.0°"/>
2. Range Adjustment	<input type="text" value="0"/>
3. Tune Adjustment	<input type="text" value="0"/>
4. TRX Setting	<input type="text"/>
5. COM Port Setting	<input type="text"/>
6. NAV Setting	<input type="text"/>
7. Sector Blank	<input type="text"/>
9. Language	<input type="text" value="ENGLISH"/>
0. EXIT	<input type="text"/>

Bearing Adjustment

Adjust the bearing so that bearing of the target measured with the ship's compass matches that of the target echo on the radar display.

Procedures

- 1 Press **AZI MODE** to select the relative bearing presentation [H UP] mode. Set **Image Processing to OFF**.

[AZI MODE] → Button ⑤ on the Radar Menu
Image Processing → Button ⑫ in the Radar Menu

- 2 Measure the bearing of an adequate target (for example, a ship at anchor, a breakwater or a buoy) relative to own ship's heading.

- 3 Open the **Equipment Setup Menu**.

- 4 Press **[1]** key.

The Code Input Menu will appear.

- 5 Using numeric key, enter the value and then press “ENT” button, and press “EXIT” button to determine the value.

The multi-function control can also be used to enter the value.

- 6 Repeat Step 5 above, and adjust to display the target measured in Step 2 to the measured bearing.

Equipment Setup	
1. Bearing Adjustment	<input type="text" value="0.0°"/>
2. Range Adjustment	<input type="text" value="0"/>
3. Tune Adjustment	<input type="text" value="0"/>
4. TRX Setting	<input type="text"/>
5. COM Port Setting	<input type="text"/>
6. NAV Setting	<input type="text"/>
7. Sector Blank	<input type="text"/>
9. Language	<input type="text" value="ENGLISH"/>
0. EXIT	<input type="text"/>

Exit

- 1 Press **[RADAR MENU]** key.

The Main Menu will reappear.

Range Adjustment

Adjust the range so that the range of the target on the radar video is indicated correctly.

Procedures

1 Search the radar display for a target of which range is already known.

2 Open the Equipment Setup Menu.

3 Press [2] key.

The Code Input Menu will appear.

4 Using numeric pad, enter the value and then press “ENT” button, and press “EXIT” button to determine the value.

The multi-function control can also be used to enter the value.

5 Repeat step 4, and adjust until the target range measured in step 1 and the range on the radar display become identical.

Exit

1 Press [RADAR MENU] key.

The Main Menu will reappear.

Equipment Setup	
1. Bearing Adjustment	<input type="text" value="0.0°"/>
2. Range Adjustment	<input type="text" value="0"/>
3. Tune Adjustment	<input type="text" value="0"/>
4. TRX Setting	
5. COM Port Setting	
6. NAV Setting	
7. Sector Blank	
9. Language	<input type="text" value="ENGLISH"/>
0. EXIT	

Antenna Height Adjustment

Set the antenna height above the sea level, but change this setting carelessly.

Procedures

1 Measure the height from the sea level to the antenna in advance.

2 Open the Equipment Setup Menu.

3 Press [4] key.

The TRX Setting Menu will appear.

4 Press [1] key.

The Antenna Height Set Value window will appear.

5 Select the antenna height measured in step 1 from the pull-down menu by pressing the numeric key [1] to [4].

The antenna height will be determined.

Exit

1 Press [RADAR MENU] key.

The Main Menu will reappear.

TRX Setting	
1. Antenna Height	<input type="text" value="5-10m"/>
4. PM Adjustment	<input type="text" value="0"/>
7. Output Pulse	<input type="text" value="2048"/>
8. Antenna Location	<input type="text" value="0m"/> <input type="text" value="0m"/>
<input type="text" value="0. EXIT"/>	

Bearing Pulse Output Adjustment (Output Pulse)

Set the output value of bearing pulse. This radar can set the output value to 2048 pulses and 4096 pulses. This setting is allowed only when a 25 kw antenna is used.

Procedures

- 1 **Open the Equipment Setup Menu.**
- 2 **Press [4] key.**
The TRX Setting Menu will appear.
- 3 **Press [7] key.**
- 4 **Select a set value to be used.**

Exit

- 1 **Press [RADAR MENU] key.**
The Main Menu will reappear.

TRX Setting

1. Antenna Height 5-10m

4. PM Adjustment 0

7. Output Pulse 2048

8. Antenna Location 0m 0m

0. EXIT

Scanner Antenna Location Adjustment (Antenna Location)

Set the position at which the scanner is installed.

Procedures

1 Open the Equipment Setup Menu.

3 Press [4] key.

The TRX Setting Menu will appear.

4 Press [8] key.

The Antenna Location Menu will appear.

TRX Setting	
1. Antenna Height	<input type="text" value="5-10m"/>
4. PM Adjustment	<input type="text" value="0"/>
7. Output Pulse	<input type="text" value="2048"/>
8. Antenna Location	<input type="text" value="0m"/> <input type="text" value="0m"/>
<input type="text" value="0. EXIT"/>	

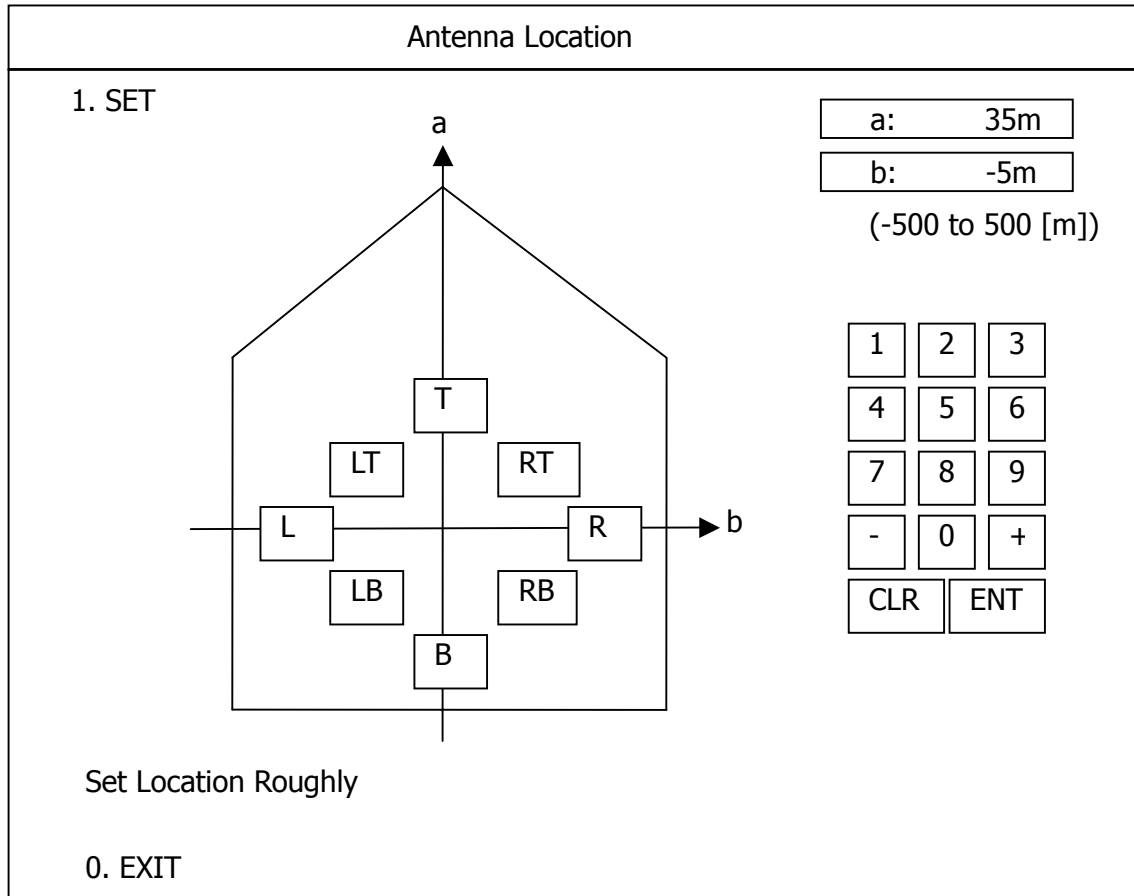
**5 Enter two values, a and b.**

With $a > 0$, the antenna is installed in the ship's heading direction.

With $a < 0$, the antenna is installed in the ship's stem direction.

With $b > 0$, the antenna is installed in the ship's starboard side direction.

With $b < 0$, the antenna is to be installed in the ship's port side direction.

Pressing **T**, **LT**, **L**, **LB**, **B**, **RB**, **R**, or **RT** in the own ship gives \pm sign, appropriate to the place, to values a and b.

Press CLR for cancellation. Press ENT to determine the value.

6 Press [0] key.

Entry will end.

Exit**1 Press [RADAR MENU] key.**

The Main Menu will reappear.

COM Port Setting

External sensor signals are to be entered to this radar via a COM port. This radar has five COM ports. Input of signals from sensors or output of signals to sensors needs to adjust the COM port in accordance with the sensors.

[I] Baud Rate Setting

Set the baud rate of the signal to be entered into the COM port.

Procedures

1 Open the Equipment Setup Menu.

2 Press [5] key.

The COM Port Setting Menu will appear.

3 Press [1] key.

The Baud Rate Setting Menu will appear.

4 Select the port number you want to set, pressing the numeric keys [1] to [5].

The Baud Rate Selection menu will appear.

5 In the selection menu, select the baud rate you want to set, pressing the numeric key.

Selection value

- | | |
|--------------------|--------------------------------|
| 1. COM1 (GPS): | 1200/4800/*38400 bps |
| 2. COM2 (PC): | 1200/4800/
38400/115200 bps |
| 3. COM3 (NAV1): | 1200/4800/38400 bps |
| 4. COM4 (NAV2): | 1200/4800/*38400 bps |
| 5. COM5 (COMPASS): | 4800/38400 bps |

* If COM1/COM4 is set to 38400 bps, signals can only be transmitted. The baud rate for reception can be set to up to 4800 bps.

COM5 can be used for receive port only. It is dedicated for COMPASS signal. This means that the port is unavailable for other signals.

The GPS, PC, NAV1, NAV2, COMPASS in the parentheses are the standard ports connecting to the external sensors.

Baud Rate	
1. COM1 (GPS)	4800bps
2. COM2 (PC)	1. 1200bps
	2. 4800bps
	3. 38400bps
3. COM3 (NAV1)	384000bp
4. COM4 (NAV2)	4800bps
5. COM5 (COMPASS)	4800bps
0. EXIT	

Exit

1 Press [RADAR MENU] key.

The Main Menu will reappear.

[II] Reception Sentence Setting (RX Sentence)

Set signal sentences to be received from sensors.

Procedures

1 Open the Equipment Setup Menu.

2 Press [5] key.

The COM Port Setting Menu will appear.

3 Press [2] key.

The RX Sentence Menu will appear.

4 Select the signal you want to set, pressing the numeric keys [1] to [3].

The Setting Menu for each signal will appear.

Settable signal

- 1. GPS (LL/COG/SOG)
- 2. GPS (WPT/Time)
- 3. Depth
- 4. Wind
- 5. Current

5 Select whether or not you want to use sentence for the signal.

Types of sentences to be used

GPS (LL/COG/SOG): GGA/RMC/RMA/GNS/
GLL/VTG

GPS (WPT/Time): GGA/RMC/RMB/
BWC/BWR/ZDA

Depth: DPT/DBK/DBT/DBS

Wind: MWV/MWD

Current: CUR

After having selected a signal, choose the number of the sentence for which you want to set whether or not it is used, pressing the numeric key.

As concerns current, set data set number and layer number of CUR sentence.

Exit

1 Press [RADAR MENU] key.

The Main Menu will reappear.

RX Sentence

1. GPS (LL/COG/SOG) >

2. GPS (WPT/Time) >

3. Depth >

4. Wind >

5. Current >

0. EXIT



GPS (LL/COG/SOG)

1. GGA ↓ USE

2. RMC USE

3. RMA USE

4. GNS USE

5. GLL USE

6. VTG USE

0. EXIT



[III] Transmission Port Setting (TX Port)

Set the number of the port via which signals are transmitted to sensors.

Procedures

1 Open the Equipment Setup Menu.

2 Press [5] key.

The COM Port Setting Menu will appear.

3 Press [3] key.

The TX Port Menu will appear.

4 Select the signal you want to set, pressing the numeric keys [1] to [8].

The Output Port Setting Menu for each signal will appear.

Settable signals

- 1. TTM (ATA Target)
- 2. TLL (ATA Target)
- 3. OSD
- 4. RSD
- 5. ALR
- 6. AIS
- 7. TTM (AIS Target)
- 8. TLL (AIS Target)

5 Select which port you want to use for output.

Types of ports to be used

- 1. OFF
- 2. COM1 (GPS)
- 3. COM2 (PC)
- 4. COM3 (NAV1)
- 5. COM4 (NAV2)

Select the number of the port to be used, pressing the numeric key.

TX Port	
1. TTM (ATA Target)	OFF
2. TLL (ATA Target)	1. OFF
	2. COM1 (GPS)
3. OSD	3. COM2 (PC)
	4. COM3 (NAV1)
	5. COM4 (NAV2)
4. RSD	OFF
5. ALR	OFF
6. AIS	AUTO
7. TTM (AIS Target)	OFF
8. TLL (AIS Target)	OFF
0. EXIT	

Exit

1 Press [RADAR MENU] key.

The Main Menu will reappear.

* Note that, if you set COM1 and COM4 for transmission, they cannot be used as reception ports.

[IV] Reception Port Setting (RX Port)

Set the number of the port via which signals are received from sensors.

Procedures**1 Open the Equipment Setup Menu.****2 Press [5] key.**

The COM Port Setting Menu will appear.

3 Press [4] key.

The RX Port Menu will appear.

4 Select the signal you want to set, pressing the numeric keys [1] to [6].

The Reception Port Setting Menu for each signal will appear.

Settable signals

1. GPS
2. DLOG
3. Depth
4. Temperature
5. Wind
6. Current

5 Select which port you want to use for output.**Types of ports to be used**

1. AUTO
2. COM1 (GPS)
3. COM2 (PC)
4. COM3 (NAV1)
5. COM4 (NAV2)

RX Port	
1. GPS	AUTO
2. DLOG	1. AUTO
	2. COM1 (GPS)
3. Depth	3. COM2 (PC)
	4. COM3 (NAV1)
	5. COM4 (NAV2)
4. Temperature	AUTO
5. Wind	AUTO
6. Current	AUTO
0. EXIT	

* For AUTO, the initial value will be selected.

Select the number of the port to be used, pressing the numeric key.

Exit**1 Press [RADAR MENU] key.**

The Main Menu will reappear.

Navigator Setting (NAV Setting)

JRC's GPS adopts connector connections on the backside of the processing unit. However, a GPS produced by other manufacturers uses terminal strip inputs in the processing unit. To do so, input area settings are needed. In addition, GPS antenna installation position can be set.

[1] Navigator Setting (Sel NAL Equipment)

Set whether the navigator to be connected is to be installed inside (JRC's GPS) or outside (other manufacturer's GPS).

Procedures

1 Open the Equipment Setup Menu.

2 Press [6] key.

The NAV Setting Menu will appear.

3 Press [1] key.

Switching between inside and outside is done each time the key is pressed.

INT GPS: JRC's GPS (connection on the backside of the processing unit)

EXT: Other manufacturer's GPS (Terminal strip connection inside the processing unit)

Exit

1 Press [RADAR MENU] key.

The Main Menu will reappear.

NAV Setting	
1. Sel NAV Equipment	
INT GPS	
2. GPS ANT. Location	
0m	0m
0. EXIT	

[II] GPS Antenna Location Setting (GPS ANT. Location)

Set the GPS antenna installation position.

Procedures

1 Open the Equipment Setup Menu.

2 Press [6] key.

The NAV Setting Menu will appear.

3 Press [2] key.

The GPS Antenna Location Menu will appear.

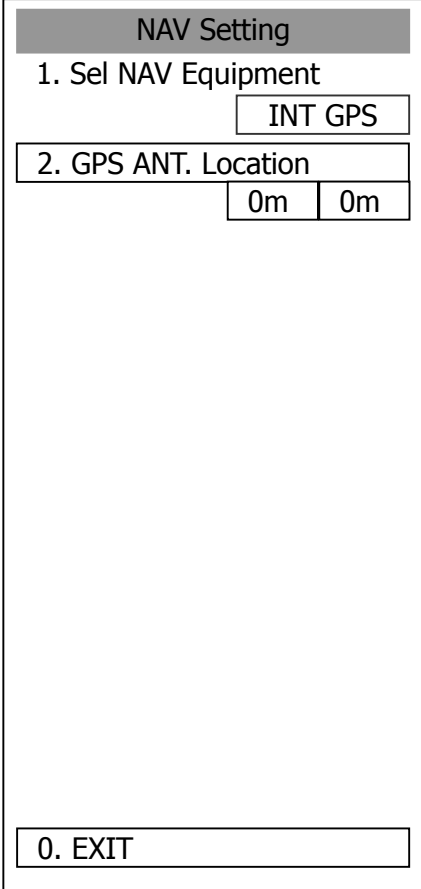

The screenshot shows a vertical menu titled "NAV Setting". The first option is "1. Sel NAV Equipment" with a sub-option "INT GPS" in a box. The second option is "2. GPS ANT. Location" with two input fields, each containing "0m". At the bottom, there is an option "0. EXIT" in a box.

Antenna Location

1. SET

Set Location Roughly

0. EXIT

a:	35m
b:	-5m

(-500 to 500 [m])

1	2	3
4	5	6
7	8	9
-	0	+
CLR	ENT	

5 Enter two values, a and b.

With $a > 0$, GPS antenna is installed in the ship's heading direction.
 With $a < 0$, GPS antenna is installed in the ship's stem direction.
 With $b > 0$, GPS antenna is installed in the ship's starboard side direction.
 With $b < 0$, GPS antenna is to be installed in the ship's port side direction.

Pressing **T**, **LT**, **L**, **LB**, **B**, **RB**, **R**, or **RT** in the own ship gives \pm sign, appropriate to the place, to values a and b.

Press CLR for cancellation. Press ENT to determine the value.

6 Press [0] key.

Entry will end.

Exit

1 Press [RADAR MENU] key.

The Main Menu will reappear.

Sector Blank Function (Sector Blank)

Set a sector range, preventing displaying the radar echo only within the area. Three types of sector can be created.

[I] Turning ON/OFF the Sector function (Sector 1, 2 and 3)

Procedures

1 Open the Equipment Setup Menu.

2 Press [7] key.

The Sector Blank Menu will appear.

3 Select the number you want executed sector blank, Pressing the numeric keys [1] to [3].

Switching between ON and OFF is done each time the key is pressed.

ON: Execution of sector blank

OFF: Cancel

Exit

1 Press [RADAR MENU] key.

The Main Menu will reappear.

Note: This function can be performed only when the scanner is connected to NKE-2252 and 1075A.

Sector Blank	
1. Sector 1	<input type="button" value="ON"/>
2. Sector2	<input type="button" value="ON"/>
3. Sector3	<input type="button" value="ON"/>
4. Make Sector 1	
5. Make Sector 2	
6. Make Sector 3	
7. ENT	
0. EXIT	

[II] Making Sector Function (Make Sector 1, 2, 3)

Procedures

1 Open the Equipment Setup Menu.

2 Press [7] key.

The Sector Blank Menu will appear.

3 Slect the number you want to make sector blank, pressing the numeric keys [4] to [6].

The sector blank for the numeric key pressed will be made.

4 Set the start point of the sector blank by operating the [EBL] dial, and then press ENT.

The start angle of the sector blank will be set.

5 Set the end point of the sector blank by operating the [EBL] dial, and then press ENT.

The end angle of the sector blank will be set.

Exit

1 Press [RADAR MENU] key.

The Main Menu will reappear.

Sector Blank	
1. Sector 1	<input type="checkbox"/> ON
2. Sector2	<input type="checkbox"/> ON
3. Sector3	<input type="checkbox"/> ON
4. Make Sector 1	
5. Make Sector 2	
6. Make Sector 3	
7. ENT	
0. EXIT	

Language Setting (Language)

You can switch between Japanese and English.

Procedures

1 Open the Equipment Setup Menu.

2 Press [9].

The Language Selection window will appear.

3 Select the language you want to display, pressing the numeric keys [1] to [3].

1. English
2. Japanese
3. Other

“Other” in 3. is a language corresponding to characters created in overseas agents.

To confirm whether or not your language is supported, contact overseas agents or our sales department.

To make the set language effective, turn off the power supply and then restart.

Exit

1 Press [RADAR MENU] key.

The Main Menu will reappear.

Baud Rate							
1. Bearing Adjustment	0.0°						
2. Range Adjustment	503						
3. Tune Adjustment	32						
4. TRX Setting	>						
5. COM Port Setting	>						
6. Nav Setting	>						
7. Sector Blank	>						
9. Language Selection	<table border="1"> <tbody> <tr> <td>1.</td> <td>ENGLISH</td> </tr> <tr> <td>2.</td> <td>JAPANESE</td> </tr> <tr> <td>3.</td> <td>OTHER</td> </tr> </tbody> </table>	1.	ENGLISH	2.	JAPANESE	3.	OTHER
1.	ENGLISH						
2.	JAPANESE						
3.	OTHER						
	ENGLISH						
0. EXIT							

Maintenance Menu

This item is provided for equipment maintenance, including settings of antenna safety switch, master reset, etc.

 **CAUTION**

-  **Only our service engineers are to make the adjustment. Neglecting this caution may cause accidents and failures.**

-  **Do not make the adjustments during navigation. Otherwise, adjustments may affect the radar functions, causing accidents and failures.**

[1] Scanner Safety Switch Setting (Safety Switch)

Procedures

- 1 Open the Adjust Menu.**
- 2 Press [2] key.**
The Maintenance Menu will appear.
- 3 Press [1] key.**
Setting items for the scanner safety switch will appear.
- 4 Select the item you want to set, pressing the numeric key [1] to [4].**
 1. TX OFF: Stops transmission. (The screen remains in the transmission status.)
 2. STANDBY: Stops transmission. (The screen switches to the standby status)
 3. TX-ON: Continues transmission without changes. (However, errors in bearing signals etc. are to occur due to safety switch-off.)
 4. IGNORE ERROR: Continues transmission without changes.(Errors in bearing signals etc. due to safety switch-off are also ignored.)

Exit

- 1 Press [RADAR MENU] key.**
The Main Menu will reappear.

Maintenance Menu

1. Safety Switch

STANDBY

2. Partial Master Reset

3. All Master Reset

4. Internal To Card2

5. Card2 To Internal

0. EXIT

[II] Partial Master Reset**Procedures**

1 Open the Maintenance Menu.

2 Press [2] key.

The Partial Master Reset Execution Check window will appear.

- 1 YES: Execution of Partial Master Reset
- 2 NO: Cancellation

Partial Master Reset resets items except for those set in the initialization menu.

Exit

1 Press [RADAR MENU] key.

The Main Menu will reappear.

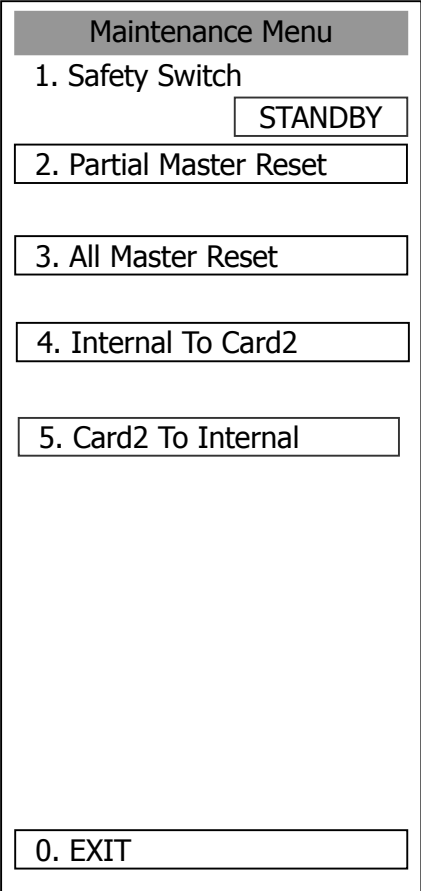

Maintenance Menu

1. Safety Switch STANDBY

2. Partial Master Reset

3. All Master Reset

4. Internal To Card2

5. Card2 To Internal

0. EXIT

[III] All Master Reset (All Master Reset)

- Procedures**
- 1 Open the Maintenance Menu.**
 - 2 Press [3] key.**

The All Master Reset Execution Check window will appear.

- 1 YES: Execution of All Master Reset
- 2 NO: Cancellation

All Master Reset resets all items.

- Exit**
- 1 Press [RADAR MENU] key.**

The Main Menu will reappear.

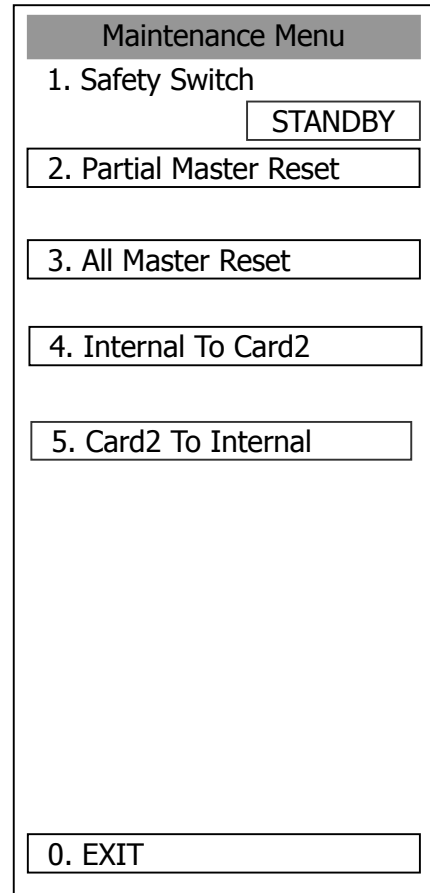

[IV] Copy Internal Settings to Card2 (Internal To Card2)

Execution of this item requires a memory flash card (option).

Procedures

- 1 Insert a flash memory card into the CARD slot 2.**
- 2 Open the Maintenance Menu.**
- 3 Press [4] key.**

The execution check window will open to check whether or not you want to copy the internal settings to Card2.

- 1 YES: Execution of copy
- 2 NO: Cancellation

Exit

- 1 Press [RADAR MENU] key.**

The Main Menu will reappear.

Maintenance Menu	
1. Safety Switch	STANDBY
2. Partial Master Reset	
3. All Master Reset	
4. Internal To Card2	
5. Card2 To Internal	
0. EXIT	

[V] Read internal settings from Card2.

Execution of this item requires a memory flash card (option).

Procedures

- 1 Insert the memory flash card, in which internal settings have been saved, into Card slot 2.**
- 2 Open the Maintenance Menu.**
- 3 Press [5] key.**

The execution check window will open to check whether or not you want to read the internal settings from Card2.

- 1 YES: Read
- 2 NO: Cancellation

Exit

- 1 Press [RADAR MENU] key.**

The Main Menu will reappear.

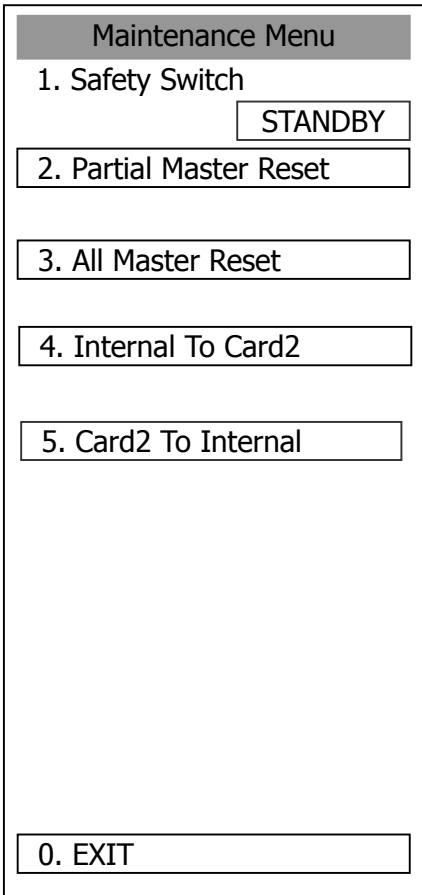

Noise Level Setting (Noise Level)

[1] Setting the noise level for signal processing (Main)

Procedures

- 1 **When the Adjust Menu appears, press [9] key.**

The SP/ATA INIT Setup Menu will appear.

- 2 **Press [1] key.**

The Noise Level Menu will appear.

- 3 **Press [1] key.**

The Code Input Menu will open to change the noise level value.

- 4 **Change the value to display echo correctly.**

In addition to the entry on the Code Input menu, the Multi-functional Dial Control is available to change the value.

Exit

- 1 **Press [RADAR MENU] key.**

The Main Menu will reappear.

Noise Level	
1. Main	<input type="text" value="140"/>
2. Setting Mode	<input type="text" value="OFF"/>
<input type="text" value="0. EXIT"/>	

[II] Noise Level Adjustment Mode (Setting Mode)

Procedures

- 1 When the Adjust Menu appears, press [9] key.**

The SP/ATA INIT Setup Menu will appear.

- 2 Press [1] key.**

Options for Setting Mode will appear.

- 3 Press [3] key.**

Switching between Setting Mode ON and OFF is done each time the key is pressed.

Exit

- 1 Press [RADAR MENU] key.**

The Main Menu will reappear.

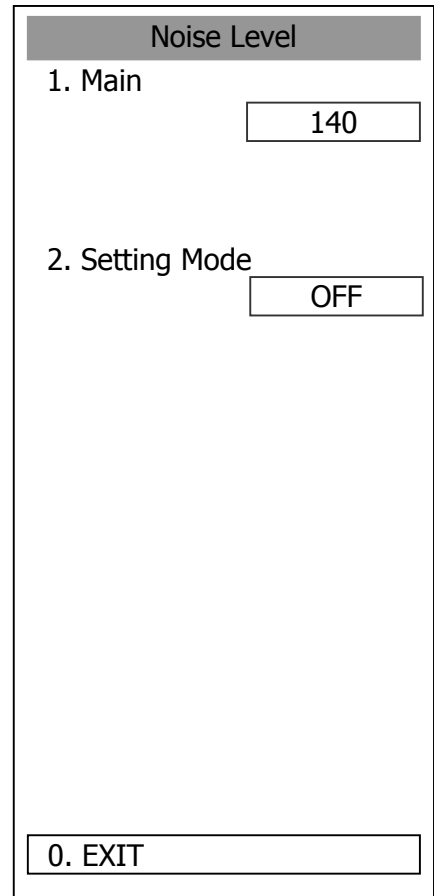

Vector Constant

Attention

- **Do not change the set value carelessly.**
The vector constant shall be set to 5 normally. If the vector constant value is higher, a target's vector will be better followed up when the target and own ship change their course or speed, but the vector accuracy will be lower on the contrary.

Procedures

- 1 Press [9] key while the Adjust Menu is open.

The SP/ATA INIT Setup Menu will appear.

- 2 Press [2] key.

The ATA Menu will appear.

- 3 Press [1] key.

The window for setting vector constants will appear.

- 4 Select the value you want to set, pressing the numeric keys [1] to [8].



Exit

- 1 Press [RADAR MENU] key.

The Main Menu will reappear.

ATA	
1. Vector Const	<input type="text" value="5"/>
2. Video TD Level	<input type="text" value="15"/>
3. Video High Level	<input type="text" value="8"/>
4. Video Low Level	<input type="text" value="1"/>
5. Gate Size	<input type="text" value="NARROW"/>
6. Limit Ring	<input type="text" value="OFF"/>
<input type="text" value="0. EXIT"/>	

Video TD Level

 CAUTION	
	Do not change the set quantization level carelessly. If the level deviates from the proper value, the ARPA acquisition and tracking functions will deteriorate. Otherwise, this may cause accidents.

The quantization level determines the minimum signal level of the input video to the ARPA target detection circuit. In this test, the value of the quantization level can be set in a range of 1 to 63. If the value is set to a lower level, weak target echoes will be inputted to the ARPA target detection circuit, but much radar noise will also be inputted to the circuit together, and target acquisition and tracking may be disabled. Therefore, it is important to set a value that is 4 or 5 higher than the detected noise level.

Procedures

- 1 Press [9] key while the Adjust Menu is open.**

The SP/ATA INIT Setup Menu will appear.

- 2 Press [2] key.**

The ATA Menu will appear.

- 3 Press [2] key.**

The Code Input Menu will appear.

- 4 Enter the Video TD Level value.**

The multi-function control can also be used to enter the value.

After having entered the value, press ENT.

Exit

- 1 Press [RADAR MENU] key.**

The Main Menu will reappear.

ATA	
1. Vector Const	<input type="text" value="5"/>
2. Video TD Level	<input type="text" value="15"/>
3. Video High Level	<input type="text" value="8"/>
4. Video Low Level	<input type="text" value="1"/>
5. Gate Size	<input type="text" value="NARROW"/>
6. Limit Ring	<input type="text" value="OFF"/>
<input type="text" value="0. EXIT"/>	

Main Bang Suppression Level Adjustment (MBS Level)

Main Bang Suppression is adjusted to suppress main bang, a reflection signal from 3D circuit including wave guide tube, that generally appears as a circular image focusing on the center of the radar display. Optimum adjustment allows main bang image to remain lightly on the display.

 CAUTION
<p>! Do not change this adjusted level carelessly. Incorrect adjustment may erase targets in point-blank range and cause collision, resulting in death or serious injury.</p>

This adjustment is made for settings in the processing circuit of the display unit.

Procedures

1 Perform the following operation before setting.

- Set the range to 0.125 nm.
- Set the radar video enhance function.
- Set the correlation processing function to OFF.
- Rotate the [AUTO-SEA] control to achieve the strength with which main bang can be judged.
- Rotate [AUTO-RAIN] control to the minimum position (counterclockwise fully).
- Rotate [GAIN/PL] control to the maximum position (clockwise fully).

2 Display the SP/ATA INIT Setup Menu.

3 Press [3] key.

The MBS Menu will appear.

4 Press [1] key.

The Code Input Menu will appear.

5 Enter the Main Bung Suppression Level value.

Adjust the value to erase the main bang.

MBS	
1. MBS Level	<input style="width: 100px;" type="text" value="0"/>
2. MBS Area	<input style="width: 100px;" type="text" value="0"/>
<div style="border: 1px solid black; width: 100%; height: 20px; margin-top: 10px; text-align: center;">0. EXIT</div>	



Exit

1 Press [RADAR MENU] key.

The Main Menu will reappear.

Main Bang Suppression Area Adjustment (MBS Area)

Adjust the main bang suppression area.

 CAUTION
 Do not change this adjusted level carelessly. Incorrect adjustment may erase targets in point-blank range and cause collision, resulting in death or serious injury.

Procedures

1 Perform the following operation before setting.

- Set the range to 0.125 nm.
- Set the radar video enhance function.
- Set the correlation processing function to OFF.
- Rotate the [AUTO-SEA] control to achieve the strength with which main bang can be judged.
- Rotate [AUTO-RAIN] control to the minimum position (counterclockwise fully).
- Rotate [GAIN/PL] control to the maximum position (clockwise fully).

2 Display the SP/ATA INIT Setup Menu.

3 Press [3] key.

The MBS Menu will appear.

4 Press [1] key.

The Code Input Menu will appear.

5 Enter the Main Bang Suppression Level value.

Adjust the value to erase the main bang.

MBS	
1. MBS Level	<input type="text" value="0"/>
2. MBS Area	<input type="text" value="0"/>
<input type="text" value="0. EXIT"/>	

Exit

1 Press [RADAR MENU] key.

The Main Menu will reappear.

Adjustment of NSK Unit to GYRO Compass and Log

The NSK Unit of the radar equipment is designed to be compatible with almost all types of gyro compass by switch operation (For the step motor type, 24 VDC to 100 VDC, and for the synchro-motor type, the primary excitation voltage is 50 VAC to 115 VAC).

Before power-on operation, the switches S1, S2, S5 and jumper JP1 on the NSK Unit (PC4201) shall be set to the type of gyro compass in use in accordance with the procedures as described below. The gyro select switch on the NSK Unit is set to the gyration ratio of 360X and to be compatible with the synchro type before delivery from factory.

Check the type of the gyro compass used in own ship and make settings in the procedures below.

(1) Set the switches of the NSK Unit (PC4201) before turning on the radar equipment.

- S1: Set it to [OFF].
- S2: There are two types of gyro compasses: a compass of one type outputs a step signal, and the other outputs a synchro signal. Make sure of the type of gyro compass used with the own ship before setting S2.

[SYNC] Synchro signal
 [STEP]..... Step signal

- S5: Set S5 depending on the type of the gyro compass currently in use, according to the S5 setting table.

S5-1:Set this switch assembly according to the particular type of gyro.

[OFF]..... Synchro signal
 [ON] Step signal

S5-2, -3..... Gyration ratio

	360X	180X	90X	36X
S5-2	OFF	OFF	ON	ON
S5-3	OFF	ON	OFF	ON

S5-4..... Gyration direction

[OFF]..... Normal (clockwise)
 [ON] Reverse (counterclockwise)

S5-5..... Log type-1

[OFF]..... Pulse signal
 [ON] Synchro signal

S5-6..... Not used



S5-7, -8..... Log ratio

	Pulse/NM (pulse signal)			
	800	400	200	100
	Gyration/NM (synchro signal)			
	360X	180X	90X	36X
S5-7	OFF	OFF	ON	ON
S5-8	OFF	ON	OFF	ON

- S6:Log test. Set it to [NORMAL].
- S7: Normal or BSH(IMO) specifications selection. Set it to [NORMAL].
- Set JP1 according to the particular gyro.

[SYNC]..... Synchro signal
 [STEP] Step signal

- (2) Connect the gyro signal and the log signal cables to the NSK Circuit. (PC4201)
- (3) Set S1 to [ON].

* After power-on operation, the switch S5-4 shall be set to [ON] if the radar video and the indicated value of COURSE (own ship's true bearing) is reversed.

Table 8-17 Gyro and Log Select Switches (S5 Dip Switch)

S5 Setting Table

		1	2	3	4	5	6	7	8	
GYRO SIG.	SYNC	0								
	STEP	1								
	360X		0	0						
	180X		0	1						
	90X		1	0						
	36X		1	1						
	DIRECTION	Normal (NOR)		0						
	Reverse (REV)		1							
LOG SIG.	TYPE	PULSE				0				
		SYNCHRO				1				
	PULSE/NM							0		
		800P/360X						0		0
		400P/180X						0		1
		200P/90X						1		0
100P/30X						1		1		

8.6 SETTING

True Bearing Setting (Set GYRO)

Adjust the bearing that the bearing angle of the radar is the same as that of the gyro.

Procedures

- 1 Press [RADAR MENU] key twice.

The Main Menu will appear.

- 2 Press [7] key.

The NAV Equipment Setting Menu will appear.

- 3 Press [1] key.

The Code Input Menu will appear.

- 4 Adjust true bearing value.

Adjust the bearing that the bearing angle of the radar is the same as that of the gyro.

The multi-function control can also be used to enter the value.

After having entered the value, press ENT.

Exit

- 1 Press [RADAR MENU] key.

The menu will be closed.

NAV Equipment Setting	
1. Set GYRO	<input type="text" value="0.0°"/>
2. Heading Equipment	<input type="text" value="GYRO"/>
3. Speed Equipment	<input type="text" value="MAN"/>
4. Manual Speed	<input type="text" value="0.0kts"/>
5. MAG Compass Setting	
6. Set/Drift Setting	
7. GPS Setting	
0. EXIT	

Ship Speed Equipment Setting (Speed Equipment)

Procedures

- 1 Press [RADAR MENU] key twice.

The RADAR Menu will appear.

- 2 Press [7] key.

The NAV Equipment Setting Menu will appear.

- 3 Press [3] key.

- 4 Select a ship speed sensor from the pull-down menu.

Types of selectable speed sensors:

- 1: Manual
- 2: Log
- 3: 2-axis log (NMEA signal: Speed over water)
- 4: 2-axis log (NMEA signal: Speed over ground)

Exit

- 1 Press [RADAR MENU] key.

The menu will be closed.

NAV Equipment Setting	
1. Set GYRO	<input type="text" value="0.0°"/>
2. Heading Equipment	<input type="text" value="GYRO"/>
3. Speed Equipment	<input type="text" value="MAN"/>
4. Manual Speed	<input type="text" value="0.0kts"/>
<input type="text" value="5. MAG Compass Setting"/>	
<input type="text" value="6. Set/Drift Setting"/>	
<input type="text" value="7. GPS Setting"/>	
<input type="text" value="0. EXIT"/>	

Attention

- The manually entered speed is effective only when “MANUAL” is set.
- 2-axis log cannot be effective when the sentence VBW of NMEA0183 is not entered.

Manual Speed Setting (Manual Speed)

Procedures

1 Press [RADAR MENU] key twice.

2 Press [7] key.

NAV Equipment Setting Menu will appear.

3 Press [4] key.

The Code Input menu will appear.

4 Pressing a numeric key, enter the value and select "ENT."

The multi-function control is also available for the entry.

Note: The manually entered speed is effective only when "MANUAL" is set.

NAV Equipment Setting	
1. Set GYRO	<input type="text" value="0.0°"/>
2. Heading Equipment	<input type="text" value="GYRO"/>
3. Speed Equipment	<input type="text" value="MAN"/>
4. Manual Speed	<input type="text" value="0.0kts"/>
<input type="text" value="5. MAG Compass Setting"/>	
<input type="text" value="6. Set/Drift Setting"/>	
<input type="text" value="7. GPS Setting"/>	
<input type="text" value="0. EXIT"/>	

MAG Compass Setting

Set the MAG compass.

Procedures

- 1 Press [RADAR MENU] key twice.

The Radar Menu will appear.

- 2 Press [7] key.

NAV Equipment Setting Menu will appear.

- 3 Press [5] key.

MAG Compass Setting Menu will appear.

- 4 Press [1] key.

This item is set as to whether or not the heading bearing is to be corrected. Switching between ON and OFF is done each time you press [1] key.

- 5 Press [2] key.

The Code Input Menu will appear.

- 6 Pressing a numeric key, enter the value. Select "ENT" and then determine the value.

The correction direction and angle will be set. On the screen, press "+" to make correction in the eastern direction, and press "-" to make correction in the western direction. Also enter a correction angle, pressing the numeric key. The multi-function control is also available for the entry. To do so, enter the correction direction, press the multi-function control, enter the correction angle, and then set ENT in order.

MAG Compass Setting

1. Heading Correction

OFF

2. Correct Value

0.0° E

0. EXIT

Exit

- 1 Press [RADAR MENU] key.

The menu will be closed.

Current Correction (SET/DRIFT) Setting

The current set and drift will be set.

Attention

- **The manually entered speed is effective only when 1. MANUAL or 2. 1AXIS is set in 2. SELECT SPEED of SETTING1 Menu.**

Procedures

- 1 Press [RADAR MENU] key twice.**

The RADAR Menu will appear.

- 2 Press [7] key.**

The NAV Equipment Setting Menu will appear.

- 3 Press [6] key.**

The Set/Drift Setting Menu will appear.

- 4 Press [1] key to enable Correction.**

The setting of Correction is switched back and forth between ON and OFF each time [1] key is pressed.

- 5 Press [2] key.**

The Code Input Menu will appear.

- 6 Enter the direction of tendency.**

The direction of tendency will be set. The multi-function control is also available for the entry.
After having entered the direction, press ENT.

Set/Drift Setting	
1. Correction	<input type="text" value="OFF"/>
2. Set	<input type="text" value="0.0°"/>
3. Drift	<input type="text" value="0.0kts"/>
<input type="text" value="0. EXIT"/>	

7 Press [3] key.

The Code Input Menu will appear.

8 Enter the speed of tendency.

The speed of tendency will be set. The multi-function control is also available for the entry.
After having enter the value, press ENT.

Exit

1 Press [RADAR MENU] key.

The menu will be closed.

Setting in GPS Receiver (GPS Process Setting)

Set an initial value in the GPS receiver (our GPS receiver).

[I] Own ship position setting

Procedures

- 1 Press [RADAR MENU] key twice.

The Radar Menu will appear.

- 2 Press [7] key.

NAV Equipment Setting Menu will appear.

- 3 Press [7] key.

GPS Setting Menu will appear.

- 4 Press [1] key.

GPS Process Setting Menu will appear.

- 5 Press [1] key.

The Code Input menu will appear.
Enter the latitude, press ENT, enter the longitude, and then press ENT in order.
The multi-function control is also available to enter the values.

- 6 After having entered the values, press [9] key, and transmit the setting contents to the GPS receiver.

Exit

- 1 Press [RADAR MENU] key.

The Main Menu will reappear.

GPS Process Setting	
1. Position	
N	00'00.000
E	000'00.000
2. Exclusion	
00 00 00 00 00 00	
3. Geodetic	
00	WGS-84
4. Antenna Height	
	0m
5. Fix Mode	
	2D
6. DOP Level	
	Up to 5
7. Position Average	
	LONG
8. Master Reset	
	OFF
9. Send Data	
0. EXIT	

[II] Setting of Banned Satellite (Excltion)

- Procedures**
- 1 Press [RADAR MENU] key twice.**
The Radar Menu will appear.
 - 2 Press [7] key.**
NAV Equipment Setting Menu will appear.
 - 3 Press [7] key.**
GPS Setting Menu will appear.
 - 4 Press [1] key.**
GPS Process Setting Menu will appear.
 - 5 Press [2] key.**
The Code Input menu will appear.
Enter the number of the banned satellite.
The multi-function control is also available to enter the values.
 - 6 After having entered the value, press [9] key, and transmit the setting contents to the GPS receiver.**

- Exit**
- 1 Press [RADAR MENU] key.**
The Main Menu will reappear.

GPS Process Setting	
1. Position	
N	00'00.000
E	000'00.000
2. Exclution	
00 00 00 00 00 00	
3. Geodetic	
00	WGS-84
4. Antenna Height	
0m	
5. Fix Mode	
2D	
6. DOP Level	
Up to 5	
7. Position Average	
LONG	
8. Master Reset	
OFF	
9. Send Data	
0. EXIT	

[III] Geodetic System Setting (Geodetic)

Set the geodetic system in which the own ship is currently existent.

Procedures**1 Press [RADAR MENU] key twice.**

The Radar Menu will appear.

2 Press [7] key.

NAV Equipment Setting Menu will appear.

3 Press [7] key.

GPS Setting Menu will appear.

4 Press [1] key.

GPS Process Setting Menu will appear.

5 Press [3] key.

The Code Input menu will appear.
Enter the geodetic system in accordance with the table on the following page.
The multi-function control is also available to enter the values.

6 After having entered the values, press [9] key to transmit the setting contents to the GPS receiver.**Exit****1 Press [RADAR MENU] key.**

The Main Menu will reappear.

GPS Process Setting	
1. Position	
N	<input type="text" value="00'00.000"/>
E	<input type="text" value="000'00.000"/>
2. Exclusion	
<input type="text" value="00 00 00 00 00 00"/>	
3. Geodetic	
<input type="text" value="00"/>	<input type="text" value="WGS-84"/>
4. Antenna Height	
<input type="text" value="0m"/>	
5. Fix Mode	
<input type="text" value="2D"/>	
6. DOP Level	
<input type="text" value="Up to 5"/>	
7. Position Average	
<input type="text" value="LONG"/>	
8. Master Reset	
<input type="text" value="OFF"/>	
9. Send Data	
0. EXIT	

List of Geodetic Systems

No.	Name
0	WGS-84
1	WGS-72
2	Japan
3	North American 1927(U.S)
4	North American 1927(Canada & Alaska)
5	European 1950 (Europe)
6	Australian geodetic 1966 (Australia)
7	Ordance Survery of Great Britain (England)
8	NAD-83
9	- (No Use)
10	- (No Use)
11	ADINDAN (Etiopia & Sudan)
12	ARC 1950 (Botswana)
13	AUSTRALIAN GEODETIC 1984 (Australia)
14	BERMUDA 1957 (the Bermudas)
15	BOGOTA OBSERVATORY (Columbia)
16	CAMPO INCHAUSPE
17	CHATHAM 1971
18	CHUAASTRO (Paraguay)
19	CORREGO ALEGRE (Brazil)
20	DJAKARTA (VATAVIA) (Sumata)
21	EUROPEAN 1979 (Europe)
22	GEODETIC DATUM 1949 (New Zeland)
23	GUAM 1963 (Guam)
24	HAYFORD 1910 (Finland)
25	HJORSEY 1955 (Ice land)
26	INDIAN (India & Nepal)
27	IRELAND1965 (Ireland)
28	KERTAU 1948 (West Malaysia)
29	L.C.5 ASTRO (Cayman Black Island)
30	LIBERIA 1964 (Liberia)
31	LUZON (Philippines)
32	MERCHICH (Morocco)
33	MINNA (Cameroon)
34	NAHRWAN (Oman)
35	NAPARIMA, BWI (Trinidad & Tobago)
36	OLD EGYPTIAN (Egypt)
37	OLD HAWAIIAN (Hawaii)
38	PCO DE LAS NIEVES (Canary)
39	PROVISIONAL SOUTH AMERICAN 1956 (South America)
40	PROVISIONAL SOUTH CHILEAN 1963 (South Chile)
41	PUERTO RICO (Puerto Rico & Virgin Islands)
42	QORNOQ (South Greenland)
43	RT90 (Sweden)
44	SANTA BRAZ (San Miguel island & Saint Mary islands)
45	SOUTH AMERICAN 1969 (South America)
46	SOUTHWEST BASE (Faial & Sao Jorge & Pico & Graciosa & Terceira island)
47	TIMBALAI 1948 (Brunei & East Malaysia)
49	- (No Use)

[IV] Antenna Height Setting (Antenna Height)**Procedures**

- 1 Press [RADAR MENU] key twice.

The Radar Menu will appear.

- 3 Press [7] key.

NAV Equipment Setting Menu will appear.

- 4 Press [7] key.

GPS Setting Menu will appear.

- 5 Press [1] key.

GPS Process Setting Menu will appear.

- 6 Press [4] key.

The Code Input menu will appear.
Enter the antenna height of the own ship.
The multi-function control is also available to enter the values.

- 7 After having entered the value, press [9] key, and transmit the contents of the settings to the GPS receiver.

Exit

- 1 Press [RADAR MENU] key.

The Main Menu will reappear.

GPS Process Setting	
1. Position	
N	00'00.000
E	000'00.000
2. Exclusion	
00 00 00 00 00 00	
3. Geodetic	
00	WGS-84
4. Antenna Height	
	0m
5. Fix Mode	
	2D
6. DOP Level	
	Up to 5
7. Position Average	
	LONG
8. Master Reset	
	OFF
9. Send Data	
0. EXIT	

[V] Fix Mode Setting (Fix Mode)

Set the GPS fix mode.

Procedures

- 1 Press [RADAR MENU] key twice.**

The Radar Menu will appear.

- 2 Press [7] key.**

NAV Equipment Setting Menu will appear.

- 3 Press [7] key.**

GPS Setting Menu will appear.

- 4 Press [1] key.**

GPS Process Setting Menu will appear.

- 5 Press [5] key.**

From the pull-down menu, you can select the following modes.

2D: 2D positioning only. Height cannot be acquired.

3D: 3D positioning can be done with height acquired.

AUTO: 2D positioning and 3D positioning can automatically be selected with optimum.

- 7 After having entered the values, press [9] key to transmit the setting contents to the GPS receiver.**

Exit

- 1 Press [RADAR MENU] key.**

The Main Menu will reappear.

GPS Process Setting	
1. Position	
N	00'00.000
E	000'00.000
2. Exclusion	
00 00 00 00 00 00	
3. Geodetic	
00	WGS-84
4. Antenna Height	
0m	
5. Fix Mode	2D
6. DOP Level	
Up to 5	
7. Position Average	
LONG	
8. Master Reset	
OFF	
9. Send Data	
0. EXIT	

[VI] HDOP Level Setting (DOP Level)

Set the HDOP level of the GPS receiver.

Procedures**1 Press [RADAR MENU] key twice.**

The Radar Menu will appear.

2 Press [7] key.

NAV Equipment Setting Menu will appear.

3 Press [7] key.

GPS Setting Menu will appear.

4 Press [1] key.

GPS Process Setting Menu will appear.

5 Press [6] key.

From the pull-down menu, you can select a desired level. As the value is smaller, the precision becomes higher, but positioning grows more difficult.

6 After having entered the values, press [9] key to transmit the setting contents to the GPS receiver.**Exit****1 Press [RADAR MENU] key.**

The Main Menu will reappear.

GPS Process Setting	
1. Position	
N	<input type="text" value="00'00.000"/>
E	<input type="text" value="000'00.000"/>
2. Exclusion	
	<input type="text" value="00 00 00 00 00 00"/>
3. Geodetic	
<input type="text" value="00"/>	<input type="text" value="WGS-84"/>
4. Antenna Height	<input type="text" value="0m"/>
5. Fix Mode	<input type="text" value="2D"/>
6. DOP Level	<input type="text" value="Up to 5"/>
7. Position Average	<input type="text" value="LONG"/>
8. Master Reset	<input type="text" value="OFF"/>
9. Send Data	
0. EXIT	

[VII] Average Level Setting (Position Average)

Set the time to average position information etc. output from the GPS receiver.

Procedures

- 1 Press [RADAR MENU] key twice.**

The Radar Menu will appear.

- 2 Press [7] key.**

NAV Equipment Setting Menu will appear.

- 3 Press [7] key.**

GPS Setting Menu will appear.

- 4 Press [1] key.**

GPS Process Setting Menu will appear.

- 5 Press [7] key.**

From the pull-down menu, select the following:
LONG,
STANDARD, and
NONE.

The degree of average becomes small in order of LONG, STANDARD and NONE. As the degree of average is smaller, the update speed of position information is higher but dispersion is larger.

- 6 After having entered the values, press [9] key to transmit the setting contents to the GPS receiver.**

Exit

- 1 Press [RADAR MENU] key.**

The Main Menu will reappear.

GPS Process Setting	
1. Position	
N	00'00.000
E	000'00.000
2. Exclusion	
00 00 00 00 00 00	
3. Geodetic	
00	WGS-84
4. Antenna Height	
0m	
5. Fix Mode	
2D	
6. DOP Level	
Up to 5	
7. Position Average	
LONG	
8. Master Reset	
OFF	
9. Send Data	
0. EXIT	

[VII] Master Reset (Master Reset)

Transmit the master reset to the GPS receiver to initialize the GPS receiver.

Procedures**1 Press [RADAR MENU] key twice.**

The Radar Menu will appear.

2 Press [7] key.

NAV Equipment Setting Menu will appear.

3 Press [7] key.

GPS Setting Menu will appear.

4 Press [1] key.

GPS Process Setting Menu will appear.

5 Press [8] key.

Switching between ON and OFF is done each time you press [8] key Select ON to transmit the reset.

6 After having entered the values, press [9] key to transmit the setting contents to the GPS receiver.**Exit****1 Press [RADAR MENU] key.**

The Main Menu will reappear.

GPS Process Setting	
1. Position	
N	<input type="text" value="00'00.000"/>
E	<input type="text" value="000'00.000"/>
2. Exclusion	
<input type="text" value="00 00 00 00 00 00"/>	
3. Geodetic	
<input type="text" value="00"/>	<input type="text" value="WGS-84"/>
4. Antenna Height	
<input type="text" value="0m"/>	
5. Fix Mode	
<input type="text" value="2D"/>	
6. DOP Level	
<input type="text" value="Up to 5"/>	
7. Position Average	
<input type="text" value="LONG"/>	
8. Master Reset	
<input type="text" value="OFF"/>	
9. Send Data	
<input type="text" value=""/>	
0. EXIT	

Setting in DGPS Receiver (DGPS Setting)

Set an initial value in the DGPS receiver (our DGPS receiver).

[I] DGPS Mode Setting (Mode)

Procedures

- 1 Press [RADAR MENU] key twice.

The Radar Menu will appear.

- 2 Press [7] key.

NAV Equipment Setting Menu will appear.

- 3 Press [7] key.

GPS Setting Menu will appear.

- 4 Press [2] key.

DGPS Setting Menu will appear.

- 5 Press [1] key.

Each time [1] key is pressed, AUTO/MANUAL is toggled.

Auto: Automatically sets the working frequency of Beacon station.

Manual: Manually sets the working frequency.
(From the next page)

- 6 After having entered the value, press [5] key to transmit the setting contents to the DGPS receiver.

Exit

- 1 Press [RADAR MENU] key.

The Main Menu will reappear.

DGPS Setting	
1. Mode	<input type="text" value="AUTO"/>
2. Frequency	<input type="text" value="275.0KHz"/>
3. Baud Rate (BPS)	<input type="text" value="50"/>
4. DGPS Mode	<input type="text" value="ON"/>
<input type="text" value="5. Send Data"/>	
Status	
No Beacon RCV connection	
<input type="text" value="Frequency"/>	<input type="text" value="--- KHz"/>
<input type="text" value="Baud Rate"/>	<input type="text" value="--- Baud"/>
<input type="text" value="RSSI"/>	<input type="text" value="---"/>
<input type="text" value="0. EXIT"/>	

[II] Setting of Working Frequency of Beacon Station (Frequency)

This setting can be made only when Manual is selected in 1. Mode.

Procedures**1 Press [RADAR MENU] key twice.**

The Radar Menu will appear.

2 Press [7] key.

NAV Equipment Setting Menu will appear.

3 Press [7] key.

GPS Setting Menu will appear.

4 Press [2] key.

DGPS Setting Menu will appear.

5 Press [2] key.

The Code Input menu will appear.

Enter the working frequency of the Beacon station.

The multi-function control is also available for the entry.

6 After having entered the value, press [5] key to transmit the setting contents to the DGPS receiver.**Exit****1 Press [RADAR MENU] key.**

The Main Menu will reappear.

DGPS Setting	
1. Mode	<input type="text" value="AUTO"/>
2. Frequency	<input type="text" value="275.0KHz"/>
3. Baud Rate (BPS)	<input type="text" value="50"/>
4. DGPS Mode	<input type="text" value="ON"/>
<input type="text" value="5. Send Data"/>	
Status	
No Beacon RCV connection	
<input type="text" value="Frequency"/>	<input type="text" value="--- KHz"/>
<input type="text" value="Baud Rate"/>	<input type="text" value="--- Baud"/>
<input type="text" value="RSSI"/>	<input type="text" value="---"/>
<input type="text" value="0. EXIT"/>	

[III] Setting of Communication Baud Rate with Beacon Station (BPS)

This setting can be made only when Manual is selected in 1. Mode.

Procedures

- 1 Press [RADAR MENU] key twice.**
The Radar Menu will appear.
- 3 Press [7] key.**
NAV Equipment Setting Menu will appear.
- 4 Press [7] key.**
GPS Setting Menu will appear.
- 5 Press [2] key.**
DGPS Setting Menu will appear.
- 6 Press [3] key.**
From the pull-down menu, you can select the following transmission speeds.

50bps
100bps
200bps

Set the desired communication speed.
- 7 After having entered the value, press [5] key to transmit the setting contents to the DGPS receiver.**

Exit

- 1 Press [RADAR MENU] key.**
The Main Menu will reappear.

DGPS Setting	
1. Mode	AUTO
2. Frequency	275.0KHz
3. Baud Rate (BPS)	50
4. DGPS Mode	ON
5. Send Data	
Status	
No Beacon RCV connection	
Frequency	--- KHz
Baud Rate	--- Baud
RSSI	---
0. EXIT	

[IV] DGPS Mode Setting (DGPS Mode)

Set the DGPS mode to ON/OFF. Setting the mode to ON allows you to acquire highly precise position information by using information from the Beacon station. Setting the mode to OFF allows you to acquire position information with the same precision as that of GPS.

Procedures**1 Press [RADAR MENU] key twice.**

The Radar Menu will appear.

2 Press [7] key.

NAV Equipment Setting Menu will appear.

3 Press [7] key.

GPS Setting Menu will appear.

4 Press [2] key.

DGPS Setting Menu will appear.

5 Press [4] key.

Switching between ON and OFF is done each time you press [4] key.

6 After having entered the value, press [5] key to transmit the setting contents to the DGPS receiver.**Exit****1 Press [RADAR MENU] key.**

The Main Menu will reappear.

DGPS Setting	
1. Mode	AUTO
2. Frequency	275.0KHz
3. Baud Rate (BPS)	50
4. DGPS Mode	ON
5. Send Data	
Status	
No Beacon RCV connection	
Frequency	--- KHz
Baud Rate	--- Baud
RSSI	---
0. EXIT	

Setting in WAAS Receiver (WAAS Setting)

Make settings in the WAAS receiver (our WAAS receiver).

Because the information the WAAS receiver receives from the satellite also includes the same information as that from DGPS Beacon station, it can perform positioning with higher precision than GPS.

[I] WAAS Mode Setting (Mode)

Set whether or not differential information of the WAAS receiver is acquired from the Beacon or satellite.

Procedures

1 Press [RADAR MENU] key twice.

The Radar Menu will appear.

2 Press [7] key.

NAV Equipment Setting Menu will appear.

3 Press [7] key.

GPS Setting Menu will appear.

4 Press [3] key.

WAAS Setting Menu will appear.

5 Press [1] key.

From the pull-down menu, select the following:
BEACON,
WAAS, or
AUTO.

6 After having made entry, press [6] key to transmit the setting contents to the WAAS receiver.

Exit

1 Press [RADAR MENU] key.

The Main Menu will reappear.

WAAS Setting	
1. Mode	<input type="text" value="AUTO"/>
2. Ranging	<input type="text" value="ON"/>
3. NG WAAS	<input type="text" value="NOT USE"/>
4. WAAS Select Mode	<input type="text" value="AUTO"/>
5. WAAS No.	<input type="text" value="120"/>
<input type="text" value="6. Send Data"/>	
<input type="text" value="0. EXIT"/>	

[II] Positioning Satellite Selection/Setting (Ranging)

Set whether or not the WAAS satellite is to be used as a positioning satellite.

Procedures**1 Press [RADAR MENU] key twice.**

The Radar Menu will appear.

2 Press [7] key.

NAV Equipment Setting Menu will appear.

3 Press [7] key.

GPS Setting Menu will appear.

4 Press [3] key.

WAAS Setting Menu will appear.

5 Press [2] key.

Switching between ON (use) and OFF (not use) is done each time you press [2] key.

6 After having made entry, press [6] key to transmit the setting contents to the WAAS receiver.**Exit****1 Press [RADAR MENU] key.**

The Main Menu will reappear.

WAAS Setting	
1. Mode	AUTO
2. Ranging	ON
3. NG WAAS	NOT USE
4. WAAS Select Mode	AUTO
5. WAAS No.	120
6. Send Data	
0. EXIT	

[IV] Satellite Number Setting (WAAS Select Mode)

Set the number of the WAAS satellite to be used.

Procedures

- 1 Press [RADAR MENU] key twice.**
The Radar Menu will appear.
- 2 Press [7] key.**
NAV Equipment Setting Menu will appear.
- 3 Press [7] key.**
GPS Setting Menu will appear.
- 4 Press [3] key.**
WAAS Setting Menu will appear.
- 5 Press [4] key.**
Switching between Auto and Manual is done each time you press [4] key.
- 6 After having made entry, press [6] key to transmit the setting contents to the WAAS receiver.**

Exit

- 1 Press [RADAR MENU] key.**
The Main Menu will reappear.

WAAS Setting	
1. Mode	<input type="text" value="AUTO"/>
2. Ranging	<input type="text" value="ON"/>
3. NG WAAS	<input type="text" value="NOT USE"/>
4. WAAS Select Mode	<input type="text" value="AUTO"/>
5. WAAS No.	<input type="text" value="120"/>
<input type="text" value="6. Send Data"/>	
<input type="text" value="0. EXIT"/>	

[V] Satellite Number Setting (WAAS Select Mode)

Set the number of the WAAS satellite to be used.

Procedures

- 1 Press [RADAR MENU] key twice.**

The Radar Menu will appear.

- 2 Press [7] key.**

NAV Equipment Setting Menu will appear.

- 3 Press [7] key.**

GPS Setting Menu will appear.

- 4 Press [3] key.**

WAAS Setting Menu will appear.

- 5 Press [5] key.**

The Code Input menu will appear.
Enter numeric values between Nos.120 and 138.

The multi-function control is also available to enter the values.

- 6 After having made entry, press [6] key to transmit the setting contents to the WAAS receiver.**

Exit

- 1 Press [RADAR MENU] key.**

The Main Menu will reappear.

The screenshot shows a menu titled "WAAS Setting" with the following items and their corresponding input fields:

- 1. Mode:
- 2. Ranging:
- 3. NG WAAS:
- 4. WAAS Select Mode:
- 5. WAAS No.:
- 6. Send Data:
- 0. EXIT:

GPS Reception Status Display (GPS Status)

Display the reception status of the GPS receiver (GPS, DGPS and WAAS receivers) currently connected.
Seize the status of satellites that are currently performing positioning.

Procedures

- 1 Press [RADAR MENU] key twice.

The Radar Menu will appear.

- 2 Press [7] key.

NAV Equipment Setting Menu will appear.

- 3 Press [7] key.

GPS Setting Menu will appear.

- 4 Press [4] key.

GPS Status Menu will appear.

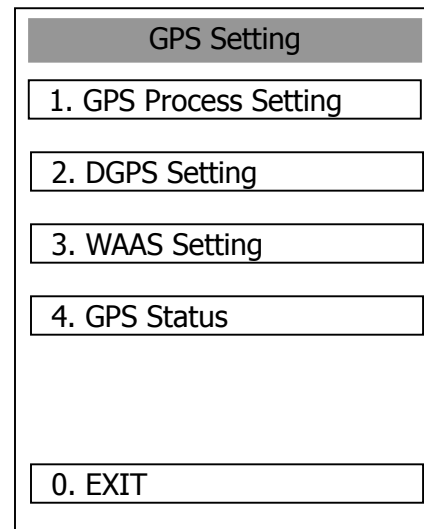

Exit

- 1 Press [0] key.

The Status Menu will be closed.

- 2 Press [RADAR MENU] key.

The menu will be closed.



GPS STATUS						
DATE /TIME (UTC)	---	---	---	---	---	---
L/L	---	---	---	---	---	---
FIX MODE	---	---	---	---	---	---
ALT	---	---	---	---	---	---
DOP LEVEL	---	---	---	---	---	---
SATELLITE No.	---	---	---	---	---	---
FIX	---	---	---	---	---	---
AZIMUTH	---	---	---	---	---	---
ELEVATE	---	---	---	---	---	---
LEVEL	---	---	---	---	---	---
STATUS	---	---	---	---	---	---
SATELLITE No.	---	---	---	---	---	---
FIX	---	---	---	---	---	---
AZIMUTH	---	---	---	---	---	---
ELEVATE	---	---	---	---	---	---
LEVEL	---	---	---	---	---	---
STATUS	---	---	---	---	---	---
RSSI	---	---	---	---	---	---
0. EXIT						

GPS Status Display

The following items are to appear on the Status display.

DATE/TIME	:	Local date and time
(UTC)	:	Greenwich Mean Time
L/L	:	Current latitude and longitude
FIX MODE	:	Fix Mode (2D positioning/3D positioning)
ALT	:	Altitude of own ship. Setting the Fix Mode to 2D displays the antenna height initially set.
DOP LEVEL	:	Precision of positioning results. As the value is smaller, the indicated precision is higher.
SATELLITE No.	:	Satellite No.
FIX	:	Is positioning data used?
AZIMUTH	:	Azimuthal angle of satellite
ELEVATE	:	Elevation angle of satellite
LEVEL	:	Reception signal level
STATUS	:	Current status of satellite
RSSI	:	Reception intensity of Beacon station

Date/Time Display Setting (Date/Time Setting)

In displaying the time, it is necessary to set the LOCAL TIME, LOCAL DATE and GMT+/-.

Procedures

1 Press [RADAR MENU] key twice.

The RADAR Menu will appear.

2 Press [8] key.

The RADAR SUB Menu will appear.

3 Press [4] key.

The Date/Time Setting Menu will appear.

4 Press [1] key.

will be selected.

The setting is switched back and forth between UTC (Coordinate Universal Time) and LOCAL (local time) each time [1] key is pressed.

5 Press [2] key.

The Code Input Menu will appear.

6 Enter the date.

The date will be set. The multi-function control is also available for the entry.

After having enter the date, press ENT.

7 Press [3] key.

The Code Input Menu will appear.

Date/Time Setting	
1. UTC/LOCAL	<input type="text" value="OFF"/>
2. Local Date	<input type="text" value="1971/01/01"/>
3. Local Time	<input type="text" value="00:00"/>
4. Time Zone	<input type="text" value="+00:00"/>
<input type="text" value="0. EXIT"/>	

8 Enter the time.

The time will be set. The multi-function control is also available for the entry.

After having enter the time, press ENT.

9 Press [4] key.

The Code Input Menu will appear.

10 Enter the time difference.

The time difference will be set. The multi-function control is also available for the entry.

After having enter the value, press ENT.

Exit**1 Press [RADAR MENU] key.**

The menu will be closed.

Attention

- **Time correction is not available when the “ZDA” sentence of NMEA0183 is not received.**

Adjustment of Performance Monitor (NJU-63/64)

* Execution of this item needs a PM unit (option).

Procedures

- 1 Set the radar to Master Radar when the Interswitch is installed.
- 2 Press VRM1 key to display VRM1 and set the range of VRM1 to 10-18* NM.
- 3 The Equipment Setup Menu will appear in accordance with the instructions of section 8.5.

- 4 Press [4] key.

The TRX Setting Menu will appear.

- 5 Press [4] key.

The Code Input Menu will appear.

- 6 Enter a set value.

Adjust the PM pattern so that its outer edge is within 10 to 18 NM. The multi-function control is also available for the entry. After having enter the value, press ENT.

- 7 Attach the INFORMATION LABEL provided with the performance monitor to an appropriate position on the display unit.

TRX Setting

1. Antenna Height

4. PM Adjustment

7. Output Pulse

8. Antenna Location

0. EXIT

8 Press [RADAR MENU] key twice.

The RADAR Menu will appear.

9 Press [8] key.

The RADAR Sub Menu will appear.

10 Press [9] key.

The Test Menu will appear.

11 Press [4] key, and set PM Display to ON.

The PM bar will appear.

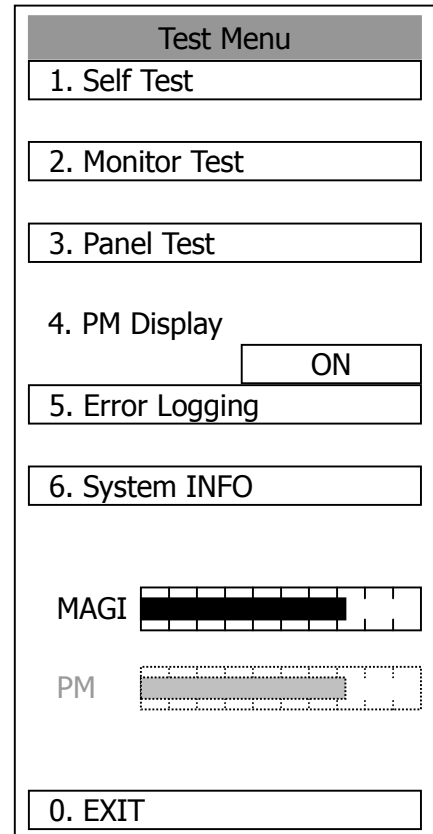
12 Write the value indicated by the PM bar and the check date to the INFORMATION LABEL you have attached to the display unit in step 7.

Test Menu

1. Self Test

2. Monitor Test

3. Panel Test

4. PM Display

ON

5. Error Logging

6. System INFO

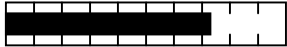
MAGI 

PM 

0. EXIT

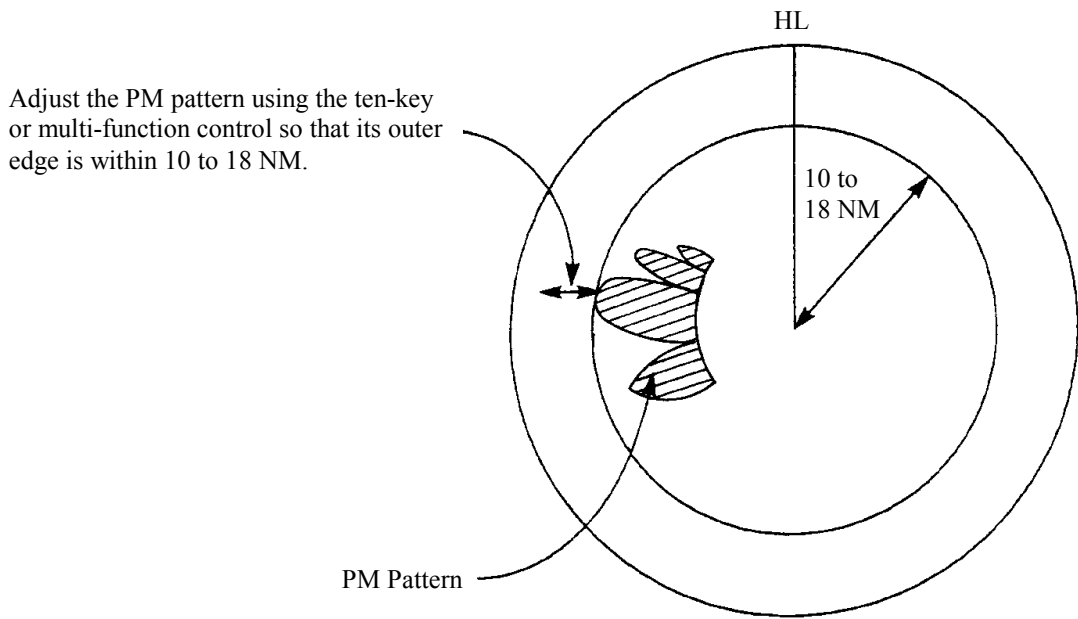

Exit

1 Press [RADAR MENU] key.

The menu will be closed.

- Note:**
- All target acquisitions by ARPA functions will be cancelled when PM is ON. The target acquisition cancelled will not be recovered.
 - The radar image is suppressed to make the PM image easier to see. Therefore, the PM Display should be turned OFF after PM check is completed.