

FCC REPORT

Applicant: Japan Radio Co., Ltd.

Address of Applicant: 3000 Scott Blvd, Suite 212, Santa Clara, CA95054

Equipment Under Test (EUT)

Product Name: Outdoor LTE TDD Base Station

Model No.: JRL-113BT48

Trade mark: JRC

FCC ID: CKEJRL-113BT48

Applicable standards: FCC CFR Title 47 Part 2
FCC CFR Title 47 Part 96

Date of sample receipt: 11 May, 2021

Date of Test: 12 May, 2021 to 26 May, 2021

Date of report issued: 23 Jun., 2021

Test Result: PASS*

* In the configuration tested, the EUT complied with the standards specified above.

Authorized Signature:



Bruce Zhang
Laboratory Manager

This report details the results of the testing carried out on one sample. The results contained in this test report do not relate to other samples of the same product and does not permit the use of the JYT product certification mark. The manufacturer should ensure that all products in series production are in conformity with the product sample detailed in this report.

This report may only be reproduced and distributed in full. If the product in this report is used in any configuration other than that detailed in the report, the manufacturer must ensure the new system complies with all relevant standards.

This document cannot be reproduced except in full, without prior written approval of the Company. Any unauthorized alteration, forgery or falsification of the content or appearance of this document is unlawful and offenders may be prosecuted to the fullest extent of the law. Unless otherwise stated the results shown in this test report refer only to the sample(s) tested and such sample(s) are retained for 90 days only.

2. Version

Version No.	Date	Description
00	26 May, 2021	Original
01	23 Jun., 2021	Update page 4, 9, 10, 23

Tested by:*Mike.ou***Date:***23 Jun., 2021*

Test Engineer**Reviewed by:***Winner Zhang***Date:***23 Jun., 2021*

Project Engineer

3. Contents

	Page
1. COVER PAGE	1
2. VERSION	2
3. CONTENTS	3
4. TEST SUMMARY	4
5. GENERAL INFORMATION	5
5.1 CLIENT INFORMATION.....	5
5.2 GENERAL DESCRIPTION OF E.U.T.....	5
5.3 TEST MODES AND TEST SAMPLES PLANS	6
5.4 MEASUREMENT UNCERTAINTY.....	6
5.5 DESCRIPTION OF SUPPORT UNITS.....	6
5.6 RELATED SUBMITTAL(S) / GRANT (S).....	6
5.7 DESCRIPTION OF CABLE USED	6
5.8 LABORATORY FACILITY.....	6
5.9 LABORATORY LOCATION	6
5.10 TEST INSTRUMENTS LIST.....	7
6. TEST RESULTS	8
6.1 EFFECTIVE ISOTROPIC RADIATED (EIRP) AND POWER SPECTRAL DENSITY (PSD)	8
6.2 PEAK-TO-AVERAGE POWER RATIO (PAPR)	32
6.3 OCCUPY BANDWIDTH	35
6.4 EMISSION MASK	45
6.5 OUT OF BAND EMISSION AT ANTENNA TERMINALS	54
6.6 FIELD STRENGTH OF SPURIOUS RADIATION MEASUREMENT.....	71
6.7 FREQUENCY STABILITY V.S. TEMPERATURE MEASUREMENT.....	75
6.8 FREQUENCY STABILITY V.S. VOLTAGE MEASUREMENT	78
7 TEST SETUP PHOTO	80
8 EUT CONSTRUCTIONAL DETAILS	81

4. Test Summary

Test Item	Section in CFR 47	Result
	FCC	
Effective Isotropic Radiated Power (EIRP) Power Spectral Density (PSD)	Part 2.1046 Part 96.41(b)	Pass
Peak-to-average power ratio (PAPR)	Part 96.41(g)	Pass
Modulation Characteristics	Part 2.1047 Part 96.41(a)	Pass
99% Occupied Bandwidth -26 dB Occupied Bandwidth	Part 2.1049 Part 96.41(e)(3)	Pass
Spurious Emissions at Antenna Terminal	Part 2.1051 Part 96.41(e)(1)(2)	Pass
Field Strength of Spurious Radiation	Part 2.1053 Part 96.41(e)(1)(2)	Pass
Frequency stability vs. temperature	Part 2.1055(a)(b)	Pass
Frequency stability vs. voltage	Part 2.1055(d)	Pass
<p>Test Method:</p> <ul style="list-style-type: none"> ● ANSI C63.26-2015 ● ANSI/TIA-603-E-2016 ● ANSI C63.4-2014 ● KDB 971168 D01 Power Meas License Digital Systems v03r01 ● KDB 940660 D01 Part 96 CBRS Eqpt v03 ● KDB 662911 D01 Multiple Transmitter Output v02r01 <p>Note:</p> <ul style="list-style-type: none"> ● The duty cycle correction=$10 \log(10/6.85) = 1.64(\text{dB})$ ● Offset Ext Gain = ATT loss + Cable loss + Duty cycle correction=$10+1+1.64=12.64(\text{dB})$ <p><i>Pass: The EUT complies with the essential requirements in the standard.</i></p>		

5. General Information

5.1 Client Information

Applicant:	Japan Radio Co., Ltd.
Address:	3000 Scott Blvd, Suite 212, Santa Clara, CA95054
Manufacturer	Japan Radio Co., Ltd.
Address:	3000 Scott Blvd, Suite 212, Santa Clara, CA95054

5.2 General Description of E.U.T.

Product Name:	Outdoor LTE TDD Base Station
Model No.:	JRL-113BT48
Operation Frequency range:	Band48: 3550MHz~3700MHz
Modulation type:	QPSK, 16QAM, 64QAM
Antenna type:	External antenna ("N" type)
Antenna gain:	LTE Band 48: 14.0dBi
Category device:	Category B device
AC adapter:	Model No: HEP-185-54 Input : 100-240VAC, 2.1A, 50/60Hz Output:54vdc, 3.45A
Test Sample Condition:	The test samples were provided in good working order with no visible defects.

Test Channel:

10MHz		20MHz	
Channel:	Frequency (MHz)	Channel:	Frequency (MHz)
Lowest	3555.0	Lowest	3560.0
Middle	3625.0	Middle	3625.0
Highest	3695.0	Highest	3690.0

5.3 Test modes and test samples plans

Test mode:	
Data mode (QPSK)	Keep the EUT in data communicating mode (QPSK). (10MHz, 20MHz)
Data mode (64QAM)	Keep the EUT in data communicating mode (64QAM). (10MHz, 20MHz)

5.4 Measurement Uncertainty

Parameters	Expanded Uncertainty
Radiated Emission (30MHz ~ 1000MHz)	±4.45 dB (k=2)
Radiated Emission (1GHz ~ 18GHz)	±4.25 dB (k=2)
Radiated Emission (18GHz ~ 40GHz)	±3.38 dB (k=2)

5.5 Description of Support Units

Manufacturer	Description	Model	Serial Number	FCC ID/DoC
LENOVO	Laptop	SL510	2847A65	DoC

5.6 Related Submittal(s) / Grant (s)

FCC: This submittal(s) (test report) is filing to comply with Section Part 96 of the FCC CFR 47 Rules.
--

5.7 Description of Cable Used

N/A

5.8 Laboratory Facility

<p>The test facility is recognized, certified, or accredited by the following organizations:</p> <ul style="list-style-type: none"> ● FCC - Designation No.: CN1211 JianYan Testing Group Shenzhen Co., Ltd. has been accredited as a testing laboratory by FCC(Federal Communications Commission). The test firm Registration No. is 727551. ● ISED – CAB identifier.: CN0021 The 3m Semi-anechoic chamber of JianYan Testing Group Shenzhen Co., Ltd. has been Registered by Certification and Engineering Bureau of Industry Canada for radio equipment testing with Registration No.: 10106A-1. ● A2LA - Registration No.: 4346.01 This laboratory is accredited in accordance with the recognized International Standard ISO/IEC 17025:2005 General requirements for the competence of testing and calibration laboratories. The test scope can be found as below link: https://portal.a2la.org/scopepdf/4346-01.pdf
--

5.9 Laboratory Location

<p>JianYan Testing Group Shenzhen Co., Ltd. Address: No.101, Building 8, Innovation Wisdom Port, No.155 Hongtian Road, Huangpu Community, Xinqiao Street, Bao'an District, Shenzhen, Guangdong, People's Republic of China. Tel: +86-755-23118282, Fax: +86-755-23116366 Email: info@ccis-cb.com, Website: http://www.ccis-cb.com</p>

5.10 Test Instruments list

Test Equipment	Manufacturer	Model No.	Serial No.	Cal. Date (mm-dd-yy)	Cal. Due date (mm-dd-yy)
3m SAC	ETS	9m*6m*6m	Q1984	01-19-2021	01-18-2024
BiConiLog Antenna	SCHWARZBECK	VULB9163	497	03-03-2021	03-02-2022
Biconical Antenna	SCHWARZBECK	VUBA9117	359	06-18-2020	06-17-2021
Horn Antenna	SCHWARZBECK	BBHA9120D	916	03-03-2021	03-02-2022
Horn Antenna	SCHWARZBECK	BBHA9120D	1805	06-18-2020	06-17-2021
Horn Antenna	SCHWARZBECK	BBHA 9170	BBHA9170582	11-18-2020	11-17-2021
Test Software	Tonscend	TS+	Version: 3.0.0.1		
Pre-amplifier	HP	8447D	2944A09358	03-03-2021	03-02-2022
Pre-amplifier	CD	PAP-1G18	11804	03-03-2021	03-02-2022
Spectrum analyzer	Rohde & Schwarz	FSP30	101454	03-03-2021	03-02-2022
Spectrum analyzer	Rohde & Schwarz	FSP40	100363	11-18-2020	11-17-2021
EMI Test Receiver	Rohde & Schwarz	ESRP7	101070	03-03-2021	03-02-2022
Spectrum Analyzer	Agilent	N9020A	MY50510123	11-18-2020	11-17-2021
Signal Generator	Rohde & Schwarz	SMX	835454/016	03-03-2021	03-02-2022
Signal Generator	R&S	SMR20	1008100050	03-03-2021	03-02-2022
Cable	ZDECL	Z108-NJ-NJ-81	1608458	03-03-2021	03-02-2022
Cable	MICRO-COAX	MFR64639	K10742-5	03-03-2021	03-02-2022
Cable	SUHNER	SUCOFLEX100	58193/4PE	03-03-2021	03-02-2022
DC Power Supply	Keysight	E3642A	MY60266189	11-27-2020	11-26-2021
Temperature Humidity Chamber	HONG ZHI	CZ-A-80D	ZH210165	03-19-2021	03-18-2022
Simulated Station	Rohde & Schwarz	CMW500	140493	07-22-2020	07-21-2021

6. Test results

6.1 Effective Isotropic Radiated (EIRP) and Power Spectral Density (PSD)

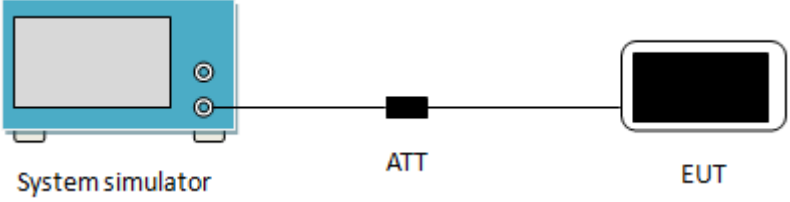
Test Requirement:	FCC part 96.41(b), FCC part2.1046												
Limit:	<table border="1"> <thead> <tr> <th>Device</th> <th>Maximum EIRP (dBm/10 megahertz)</th> <th>Maximum PSD (dBm/MHz)</th> </tr> </thead> <tbody> <tr> <td>End User Device</td> <td>23</td> <td>n/a</td> </tr> <tr> <td>Category A CBSD</td> <td>30</td> <td>20</td> </tr> <tr> <td>Category B CBSD¹</td> <td>47</td> <td>37</td> </tr> </tbody> </table>	Device	Maximum EIRP (dBm/10 megahertz)	Maximum PSD (dBm/MHz)	End User Device	23	n/a	Category A CBSD	30	20	Category B CBSD ¹	47	37
Device	Maximum EIRP (dBm/10 megahertz)	Maximum PSD (dBm/MHz)											
End User Device	23	n/a											
Category A CBSD	30	20											
Category B CBSD ¹	47	37											
Test setup	 <p style="text-align: center;">System simulator ATT EUT</p>												
Test Procedure:	<p>For Maximum EIRP</p> <ol style="list-style-type: none"> 1. Connect the transmitter to the spectrum analyzer via coaxial cable while ensuring proper impedance matching. 2. Set span to 2 × to 3 × the OBW. 3. Set RBW = 1% to 5% of the OBW. 4. Set VBW ≥ 3 × RBW. 5. Set number of measurement points in sweep ≥ 2 × span / RBW. 6. Sweep time: <ol style="list-style-type: none"> 1) Set = auto-couple, or 2) Set ≥ [10 × (number of points in sweep) × (transmission symbol period)] for single sweep (automation-compatible) measurement. 7. Detector = power averaging (rms). 8. Set sweep trigger to “free run.” 9. Trace average at least 100 traces in power averaging (rms) mode if sweep is set to auto-couple. To accurately determine the average power over the on and off time of the transmitter, it can be necessary to increase the number of traces to be averaged above 100, or if using a manually configured sweep time, increase the sweep time. 10. Compute power by integrating the spectrum across the OBW(10MHz) of the signal using the instrument’s band or channel power measurement function with band/channel limits set equal to the OBW(10MHz) band edges. 11. Add 10 log (1/duty cycle) to the measured power level to compute the average power during continuous transmission. 12. EIRP = P_{Meas} + G_T. <p>P_{Meas} measured transmitter output power or PSD. G_T gain of the transmitting antenna.</p> <p>For Maximum PSD</p> <p>The PSD is measured following the same procedures described for measuring the maximum EIRP but with the RBW set to the reference bandwidth specified(eg.1MHz) by the applicable regulatory requirement, and by using the marker function to identify the maximum PSD instead of summing the power across the OBW.</p>												
Test Instruments:	Refer to section 5.10 for details												
Test mode:	Refer to section 5.3 for details												
Test results:	Passed												

Measurement Data (EIRP):

Modulation	Frequency (MHz)	ANT. Port	Output Power (dBm/10MHz)	Total Power (dBm/10MHz)	Directional gain (dBi)	EIRP (dBm)	Limit (dBm)
QPSK (10MHz)	3555.00	ANT 0	29.79	32.66	14	46.66	47.00
		ANT 1	29.51				
		ANT 2	29.85	32.61		46.61	
		ANT 3	29.33				
	3625.00	ANT 0	28.88	31.74		45.74	
		ANT 1	28.57				
		ANT 2	28.28	30.88		44.88	
		ANT 3	27.42				
	3695.00	ANT 0	29.88	32.54		46.54	
		ANT 1	29.15				
		ANT 2	29.03	31.75		45.75	
		ANT 3	28.43				
64QAM (10MHz)	3555.00	ANT 0	29.71	32.53	14	46.53	47.00
		ANT 1	29.32				
		ANT 2	29.77	32.62		46.62	
		ANT 3	29.45				
	3625.00	ANT 0	28.65	31.58		45.58	
		ANT 1	28.49				
		ANT 2	28.24	30.85		44.85	
		ANT 3	27.39				
	3695.00	ANT 0	29.75	32.50		46.50	
		ANT 1	29.22				
		ANT 2	29.02	31.78		45.78	
		ANT 3	28.51				
QPSK (20MHz)	3560.00	ANT 0	26.97	29.71	14	43.71	47.00
		ANT 1	26.42				
		ANT 2	27.50	30.14		44.14	
		ANT 3	26.73				
	3625.00	ANT 0	26.29	29.17		43.17	
		ANT 1	26.02				
		ANT 2	25.89	28.50		42.50	
		ANT 3	25.05				
	3690.00	ANT 0	26.66	29.66		43.66	
		ANT 1	26.64				
		ANT 2	26.53	29.25		43.25	
		ANT 3	25.92				
64QAM (20MHz)	3560.00	ANT 0	26.91	29.67	14	43.67	47.00
		ANT 1	26.40				
		ANT 2	27.46	30.07		44.07	
		ANT 3	26.61				
	3625.00	ANT 0	26.19	29.09		43.09	
		ANT 1	25.97				
		ANT 2	25.86	28.31		42.31	
		ANT 3	24.66				
	3690.00	ANT 0	26.55	29.51		43.51	
		ANT 1	26.45				
		ANT 2	26.59	29.13		43.13	
		ANT 3	25.59				
Remark:	1. ANT 0 and ANT 1 is 2*2MIMO, ANT 2 and ANT 3 is 2*2MIMO 2. Note: All transmit signals are completely uncorrelated with each other, Directional gain = G_{ANT} =14dBi						

Full Transmit Output Power							
Modulation	Frequency (MHz)	ANT. Port	Output Power (dBm/20MHz)	Total Power (dBm/20MHz)	Directional gain (dBi)	EIRP (dBm)	Limit (dBm/20MHz)
QPSK (20MHz)	3560.00	ANT 0	29.63	32.52	14	46.52	/
		ANT 1	29.39				
		ANT 2	29.84	32.58			
		ANT 3	29.28				
	3625.00	ANT 0	28.66	31.64		45.64	
		ANT 1	28.60				
		ANT 2	28.32	30.97			
		ANT 3	27.56				
	3690.00	ANT 0	29.28	32.22		46.22	
		ANT 1	29.14				
		ANT 2	29.14	31.84			
		ANT 3	28.50				
64QAM (20MHz)	3560.00	ANT 0	29.72	32.53	14	46.53	/
		ANT 1	29.32				
		ANT 2	29.91	32.55			
		ANT 3	29.13				
	3625.00	ANT 0	28.55	31.54		45.54	
		ANT 1	28.51				
		ANT 2	28.26	30.76			
		ANT 3	27.17				
	3690.00	ANT 0	29.17	32.19		46.19	
		ANT 1	29.18				
		ANT 2	29.02	31.54			
		ANT 3	27.97				
Remark:	1. ANT 0 and ANT 1 is 2*2MIMO, ANT 2 and ANT 3 is 2*2MIMO 2. Note: All transmit signals are completely uncorrelated with each other, Directional gain = G_{ANT} =14dBi						

Test plot as below:

Bandwidth=10MHz – QPSK

ANT 0

ANT 1

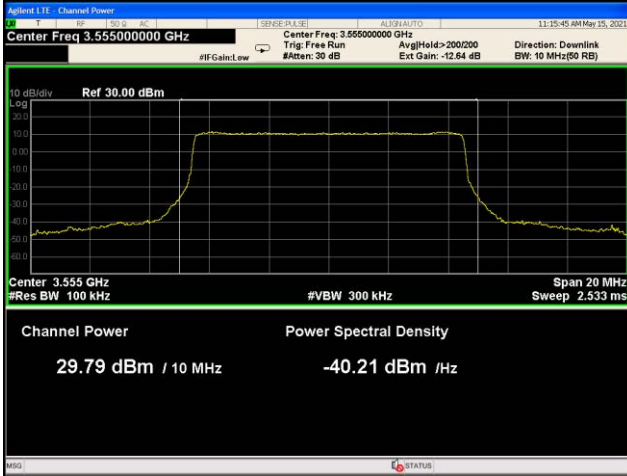

Lowest channel

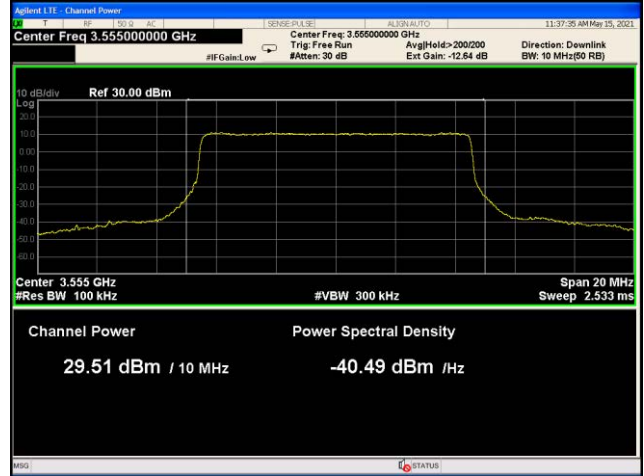

Lowest channel

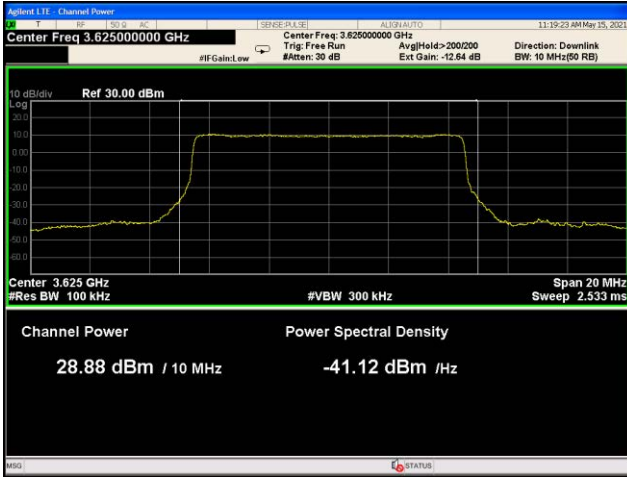

Middle channel

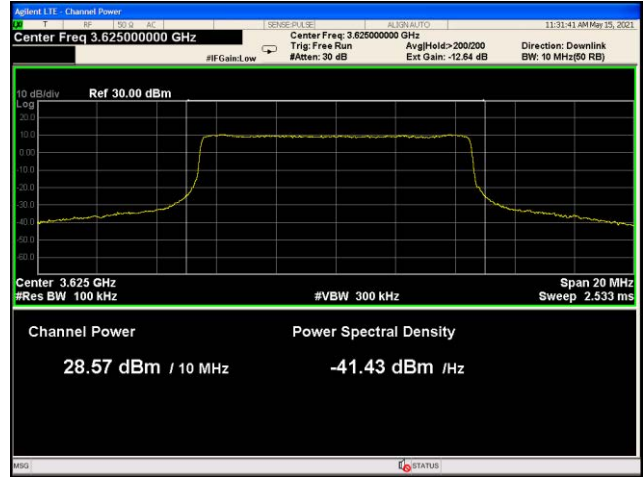

Middle channel

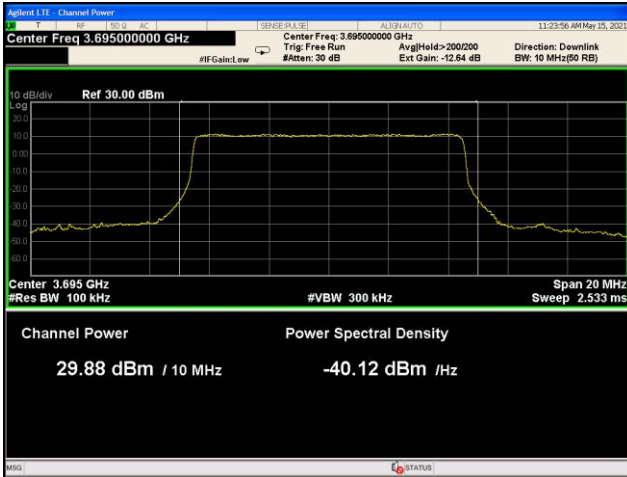

Highest channel

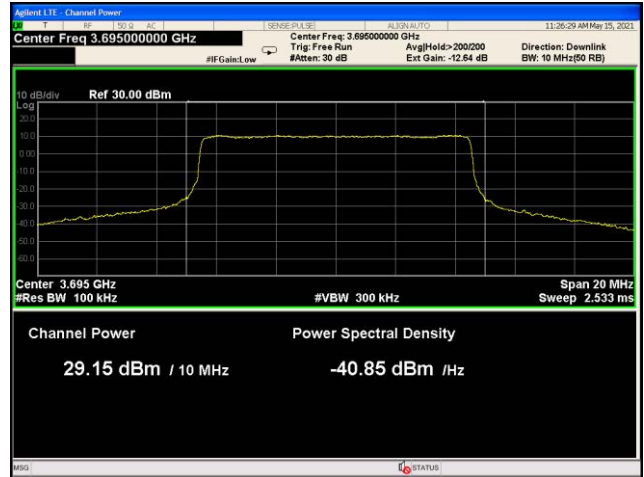

Highest channel

Bandwidth=10MHz – QPSK

ANT 2

ANT 3

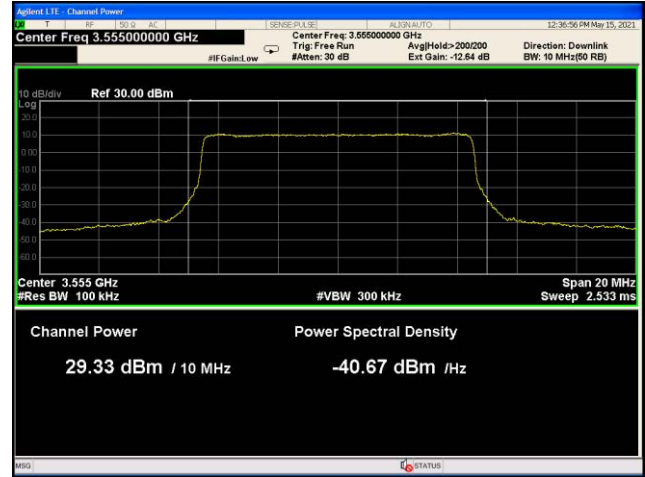
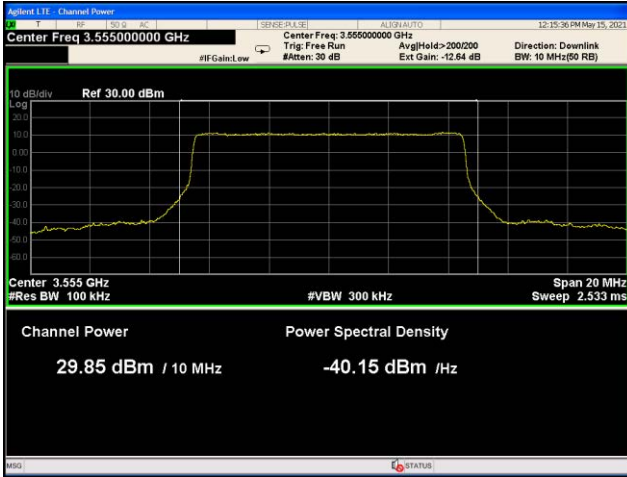

Lowest channel

Lowest channel

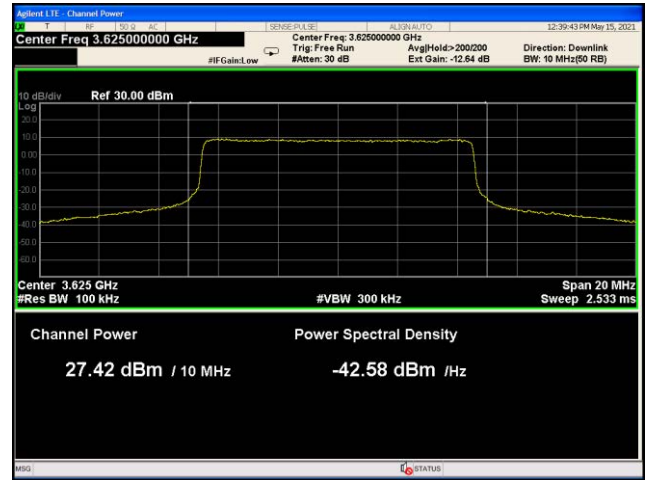
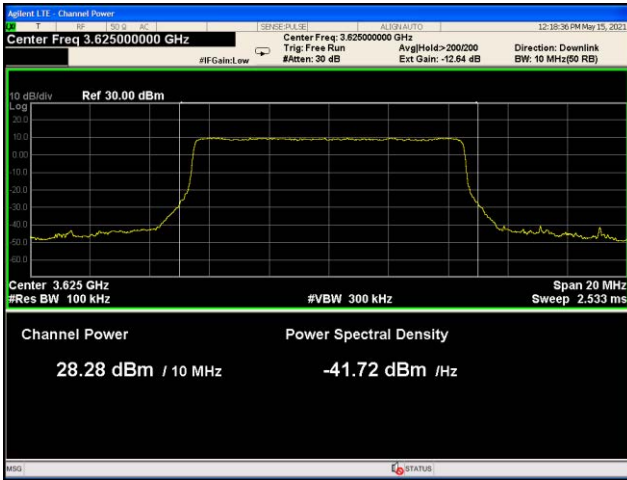

Middle channel

Middle channel

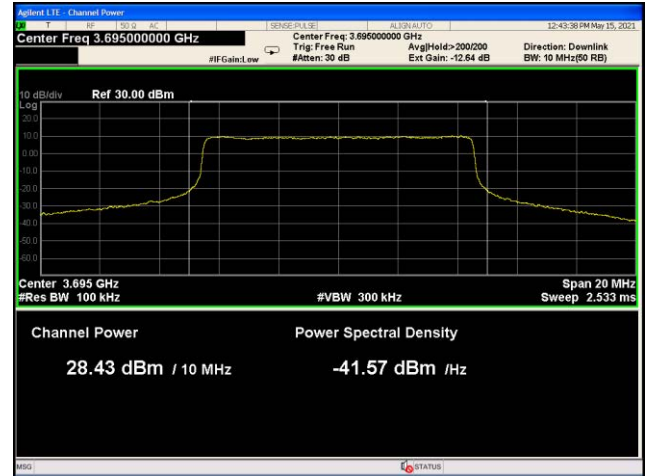
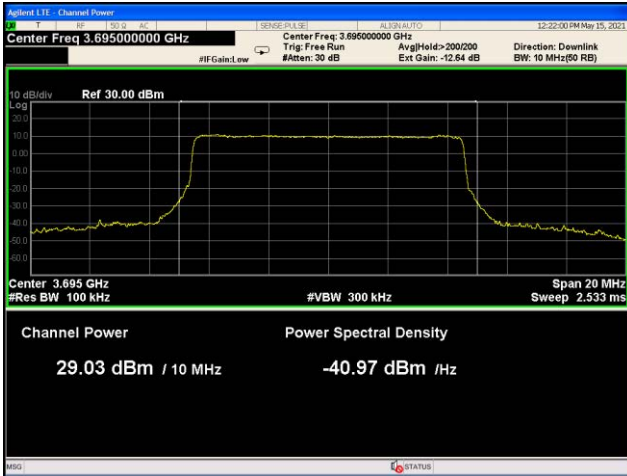

Highest channel

Highest channel

Bandwidth=10MHz – 64QAM

ANT 0

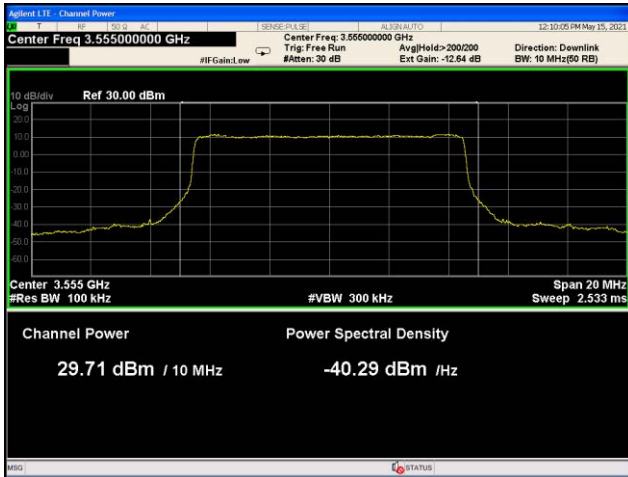

Lowest channel

ANT 1

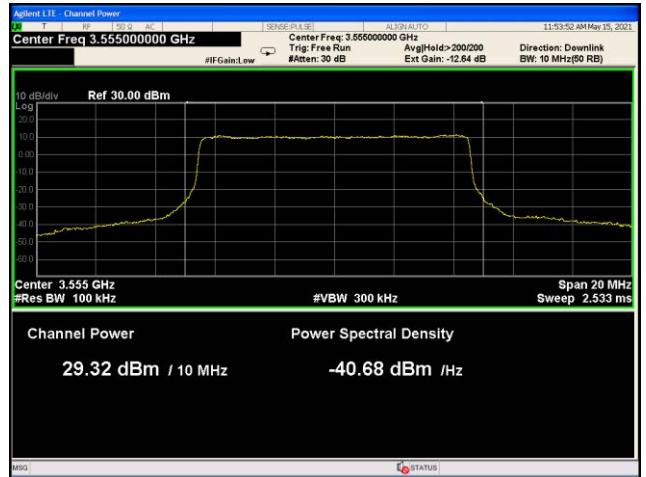

Lowest channel

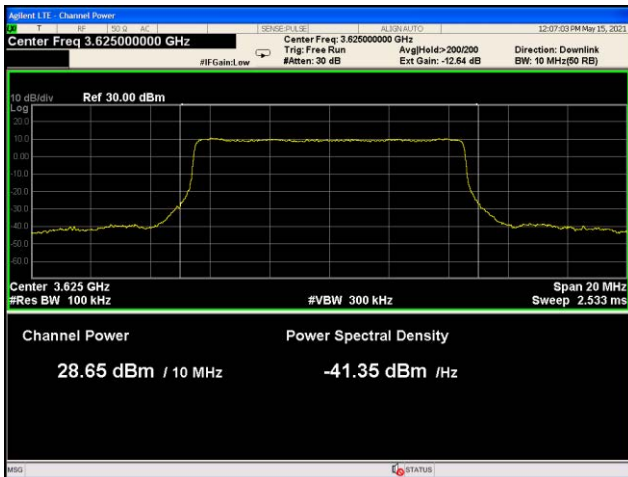

Middle channel

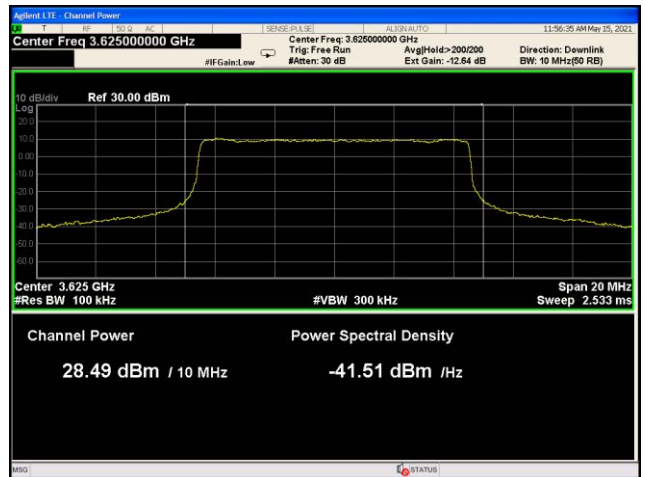

Middle channel

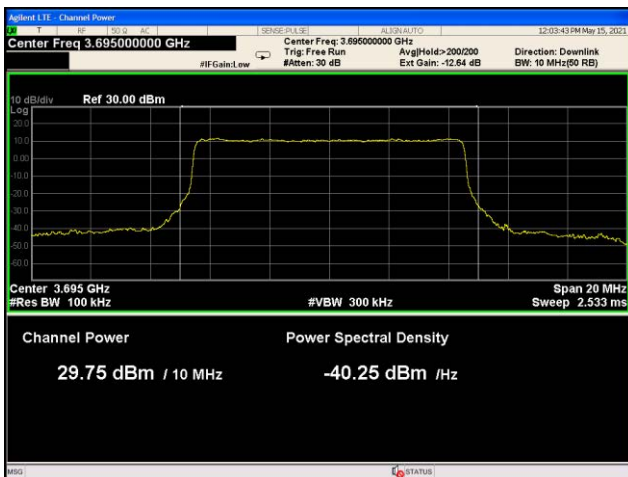

Highest channel

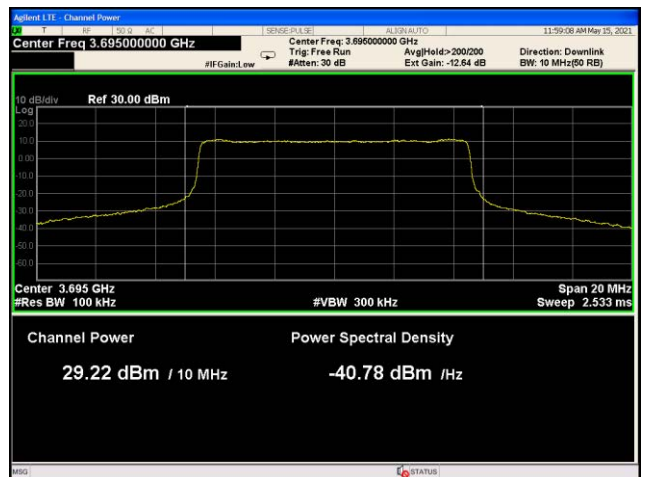

Highest channel

Bandwidth=10MHz – 64QAM

ANT 2

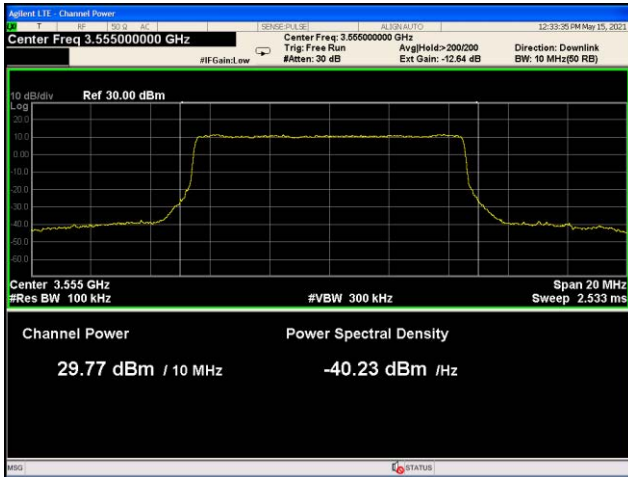

Lowest channel

ANT 3

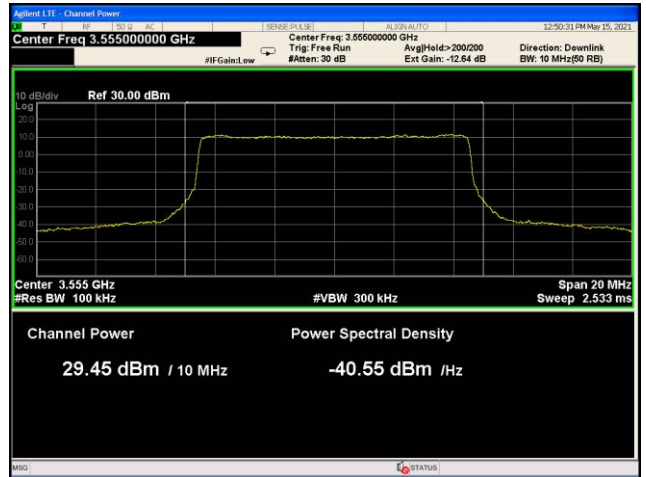

Lowest channel

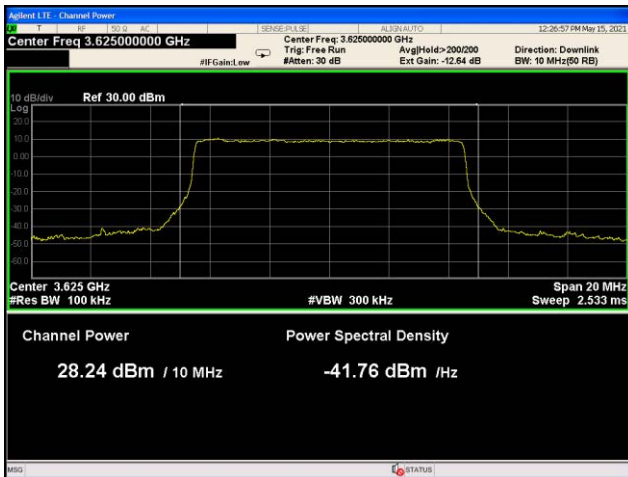

Middle channel

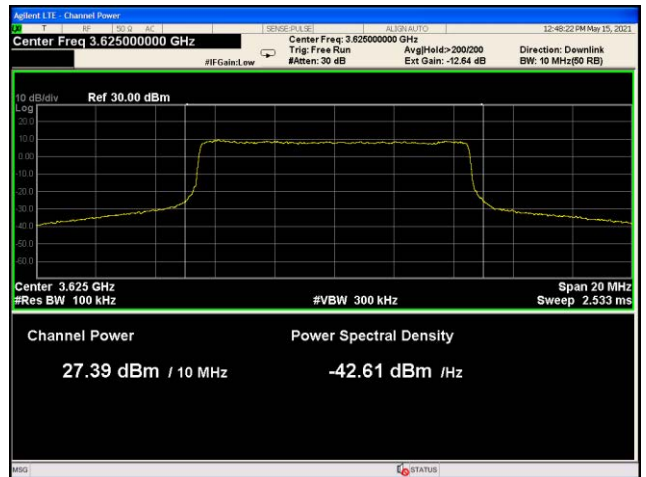

Middle channel

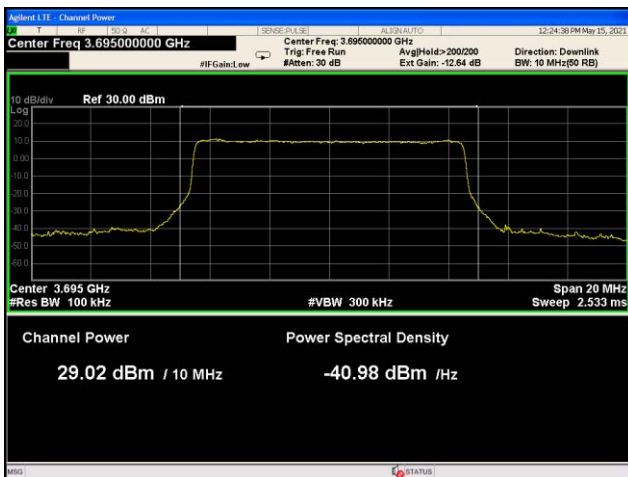

Highest channel

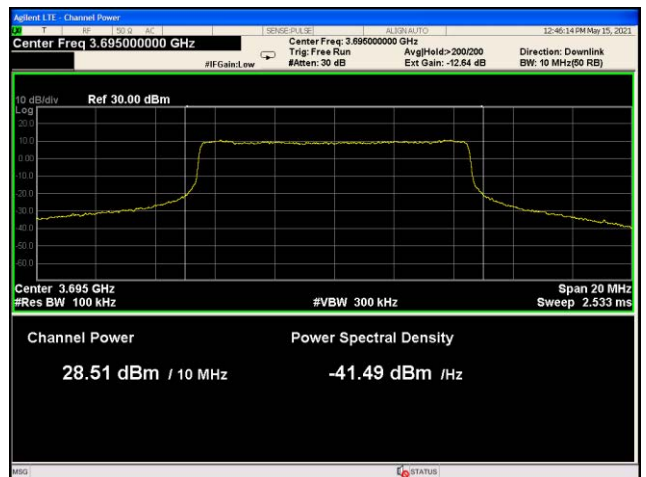

Highest channel

Bandwidth=20MHz – QPSK

ANT 0

ANT 1

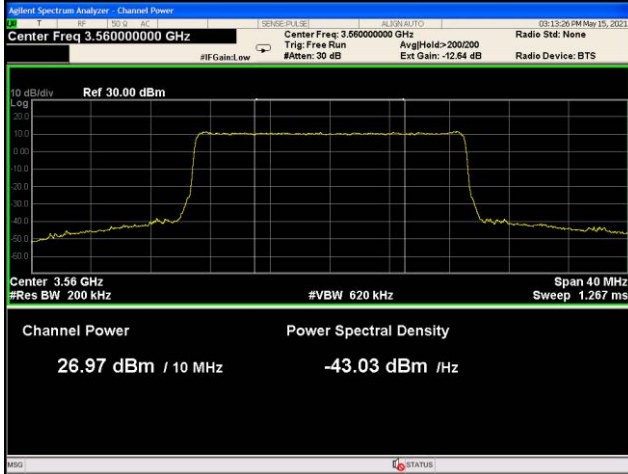

Lowest channel

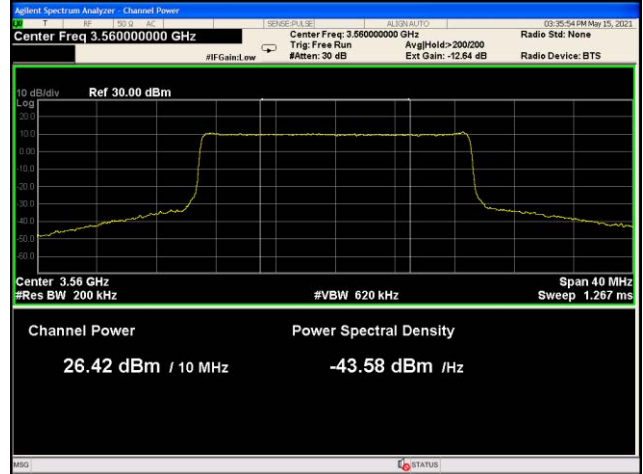

Lowest channel

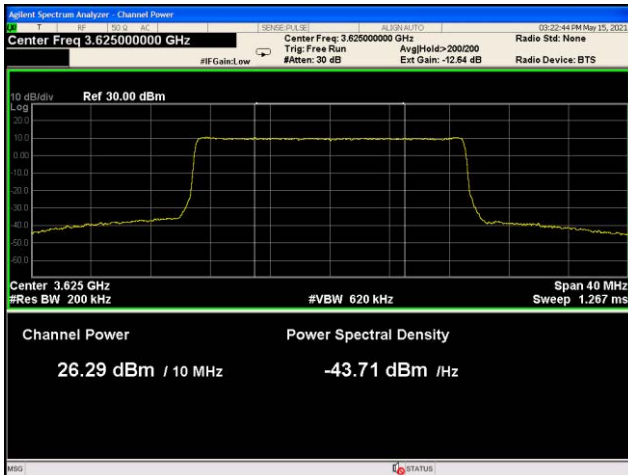

Middle channel

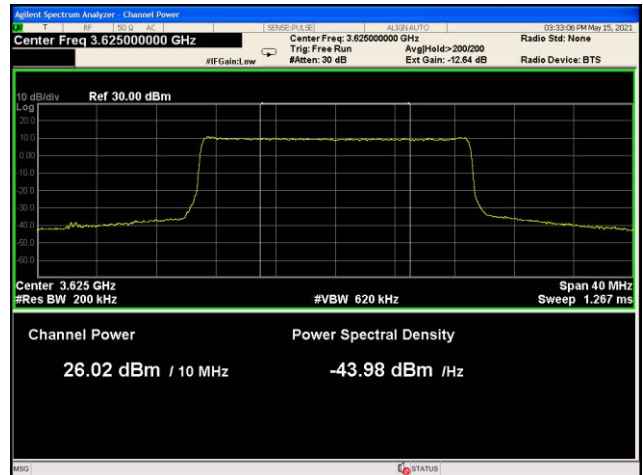

Middle channel

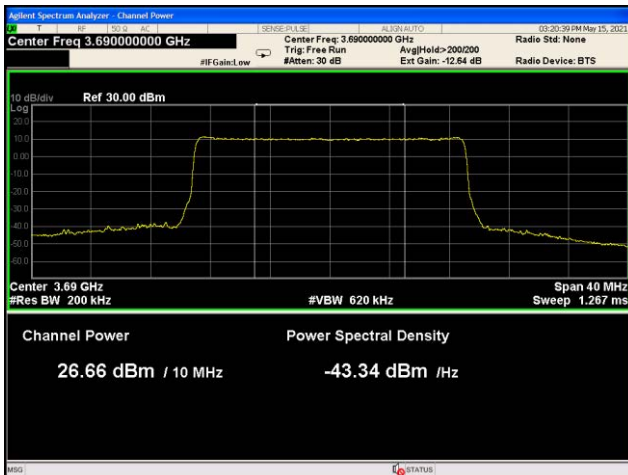

Highest channel

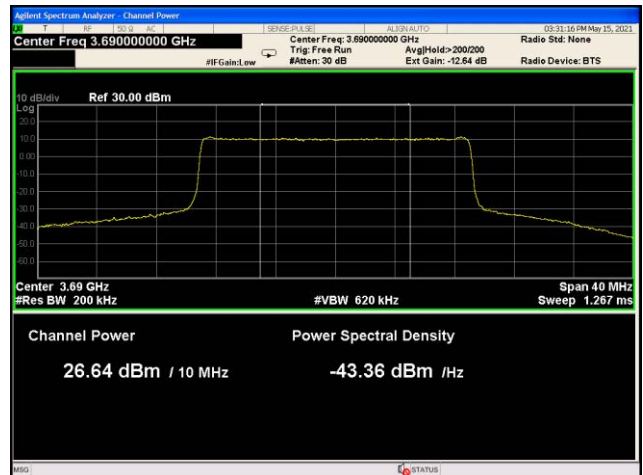

Highest channel

Bandwidth=20MHz – QPSK

ANT 2

ANT 3

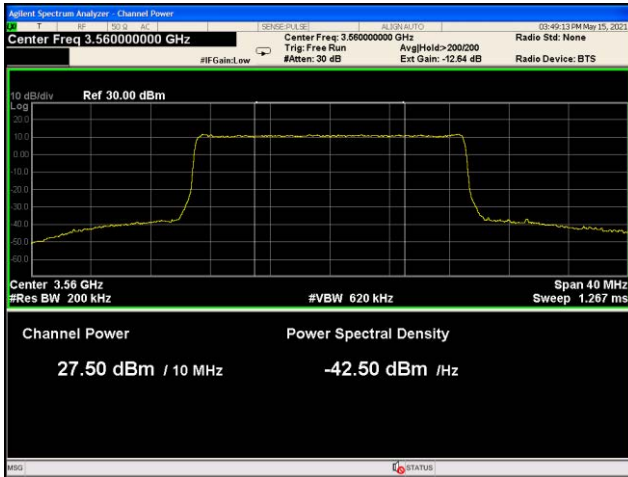

Lowest channel

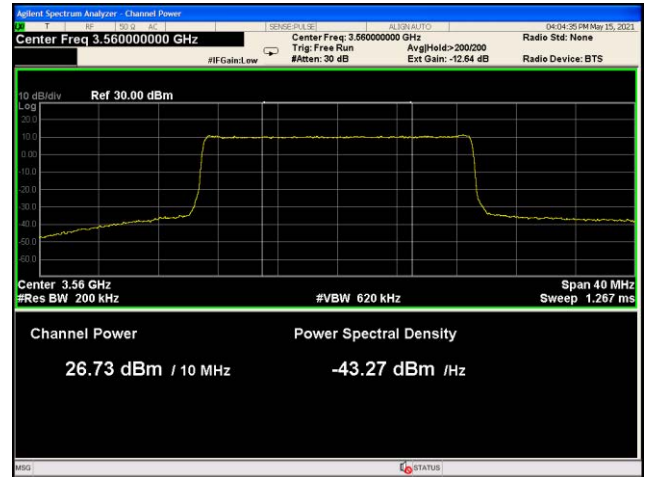

Lowest channel

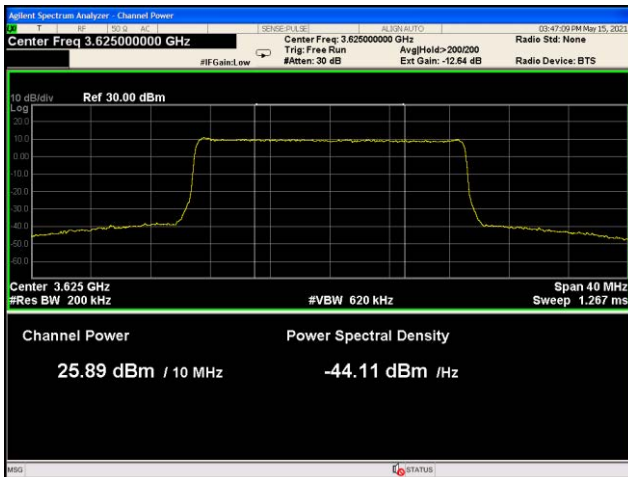

Middle channel

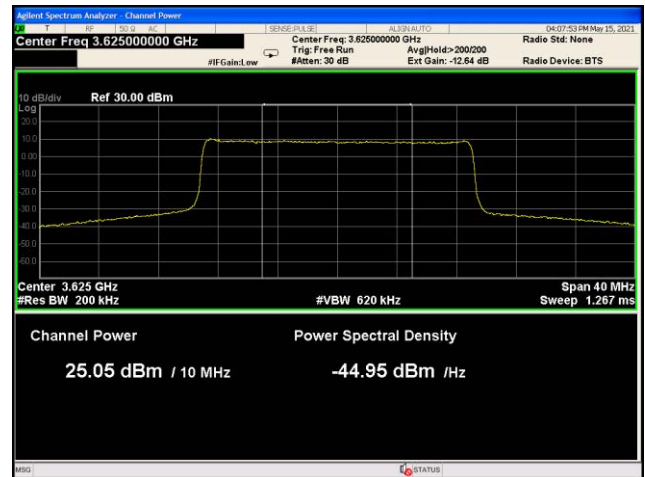

Middle channel

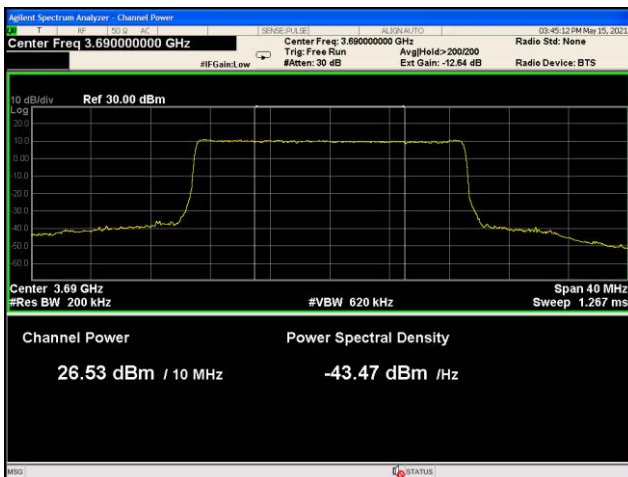

Highest channel

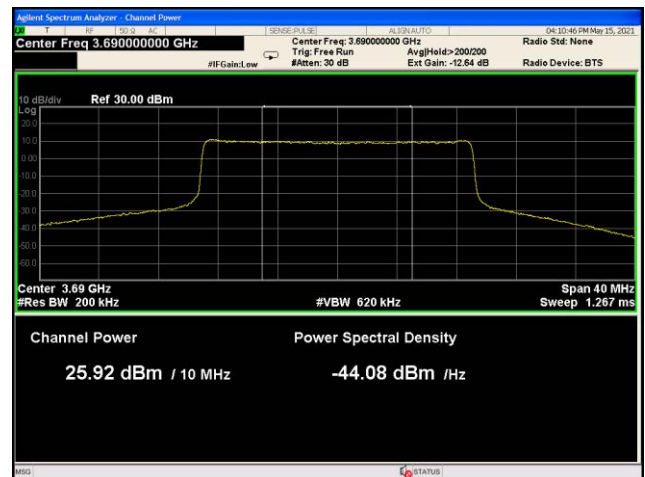

Highest channel

Bandwidth=20MHz – 64QAM

ANT 0

ANT 1

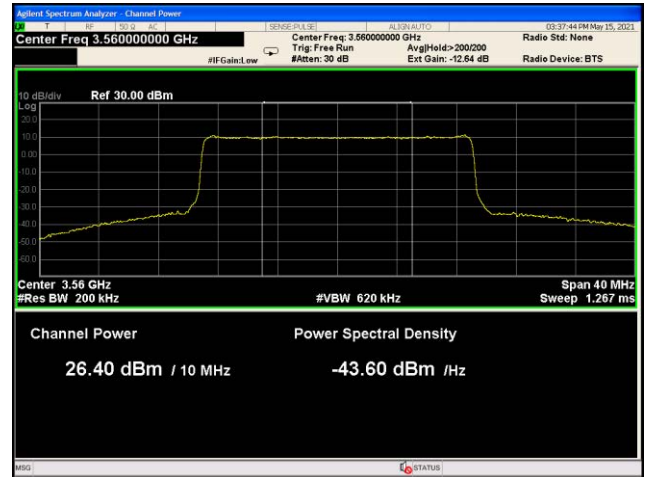
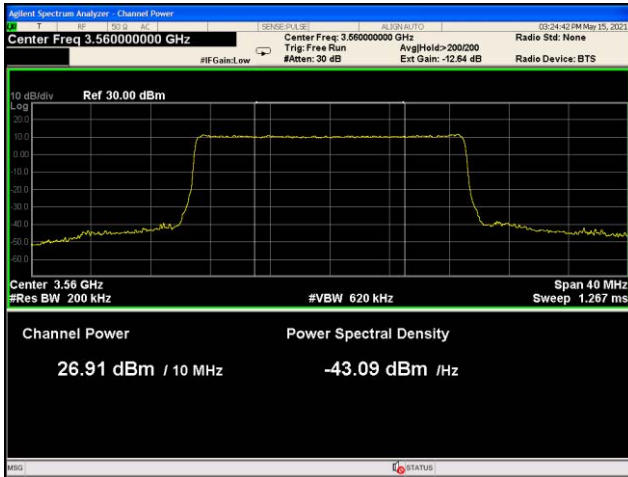

Lowest channel

Lowest channel

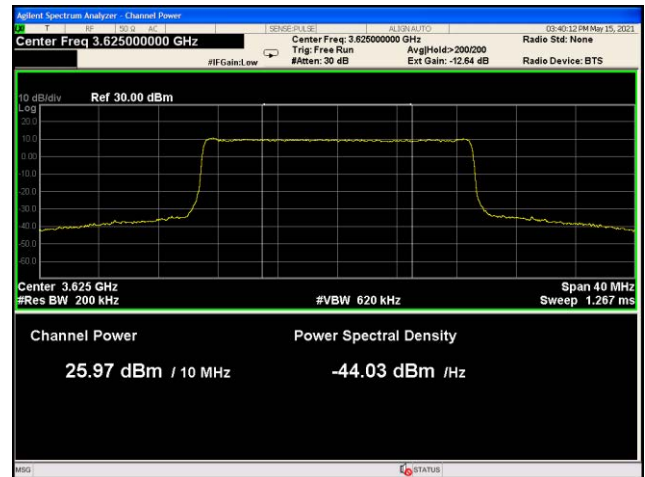
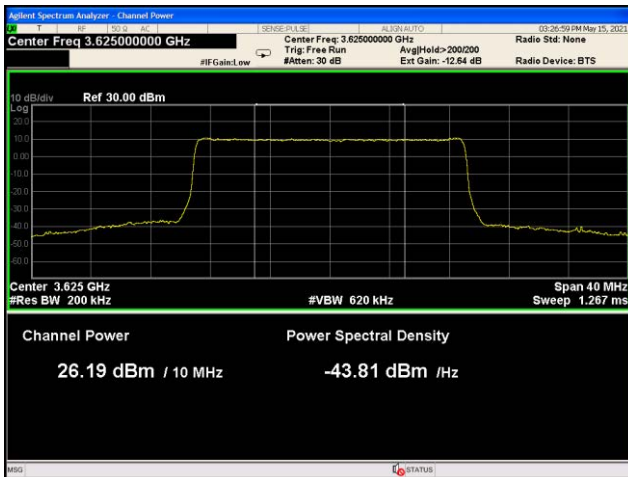

Middle channel

Middle channel

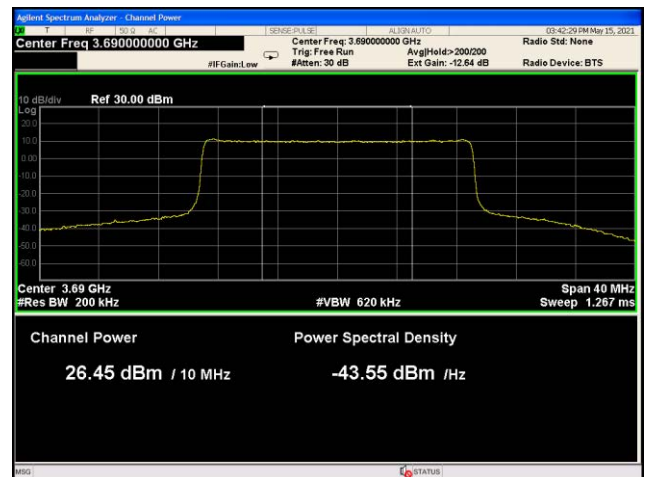
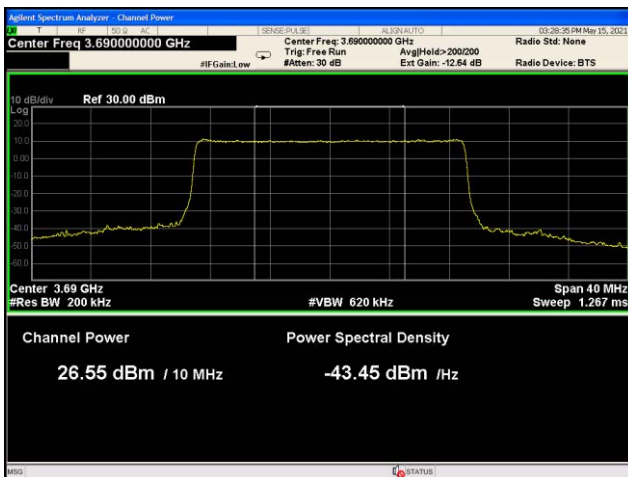

Highest channel

Highest channel

Bandwidth=20MHz – 64QAM

ANT 2

ANT 3

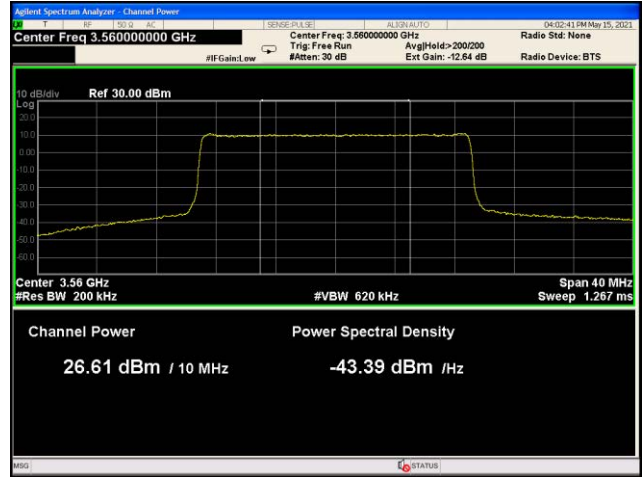
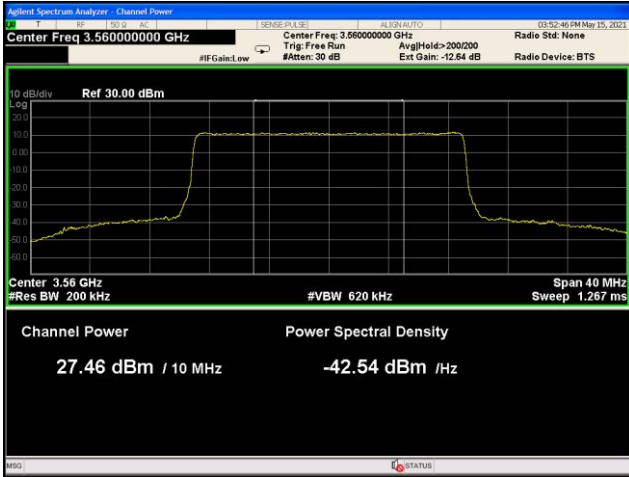

Lowest channel

Lowest channel

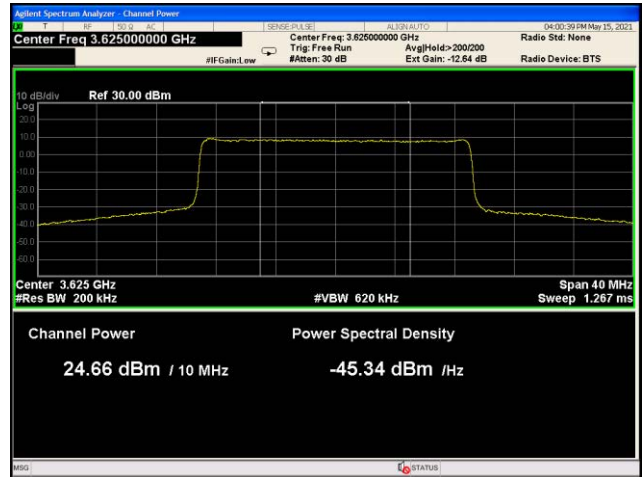
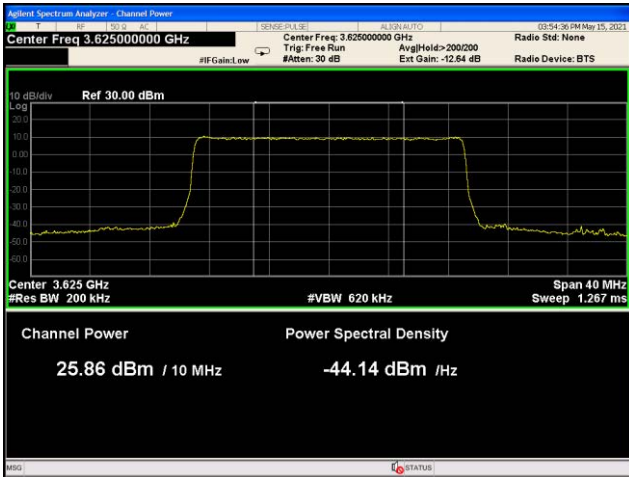

Middle channel

Middle channel

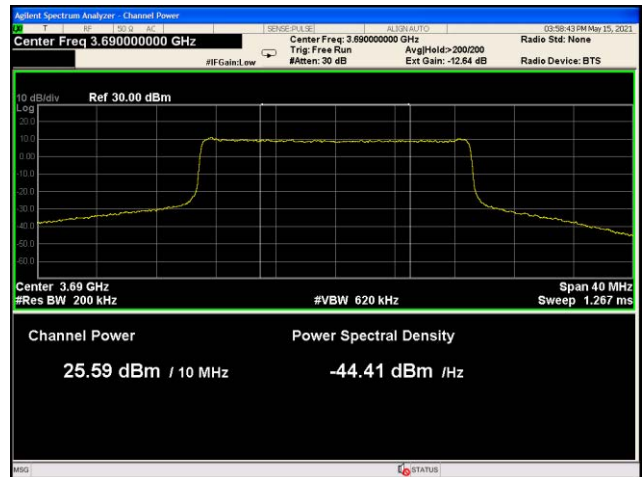
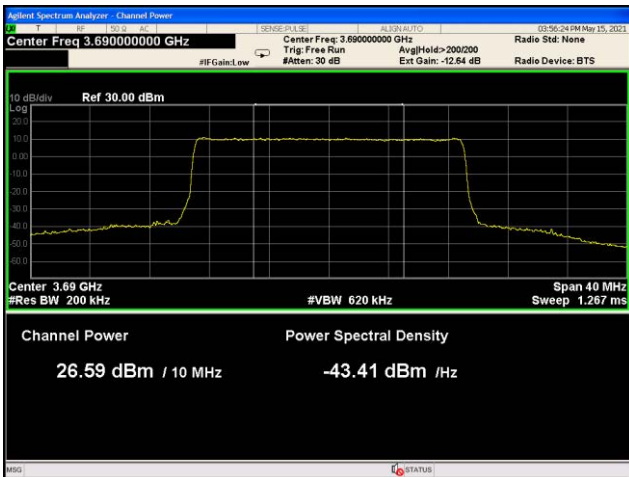

Highest channel

Highest channel

Full Transmit Output Power:

Bandwidth=20MHz – QPSK

ANT 0

ANT 1

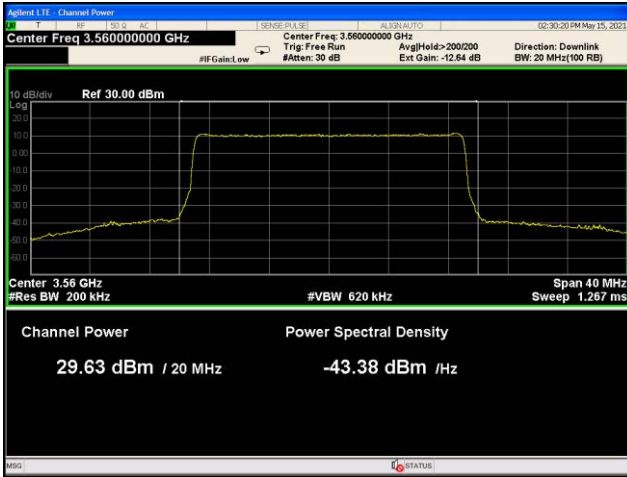

Lowest channel

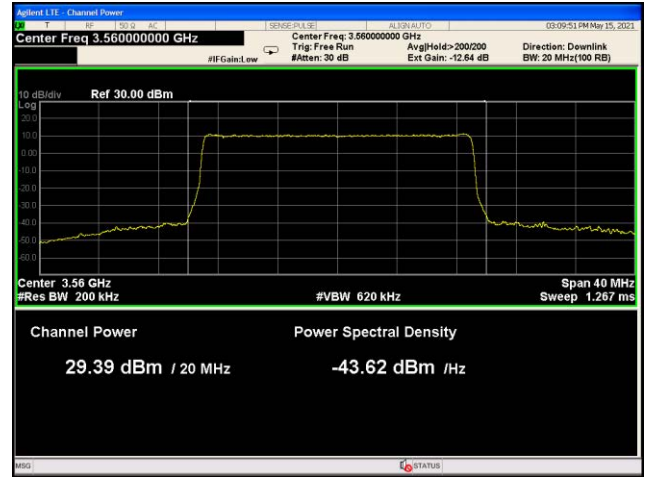

Lowest channel

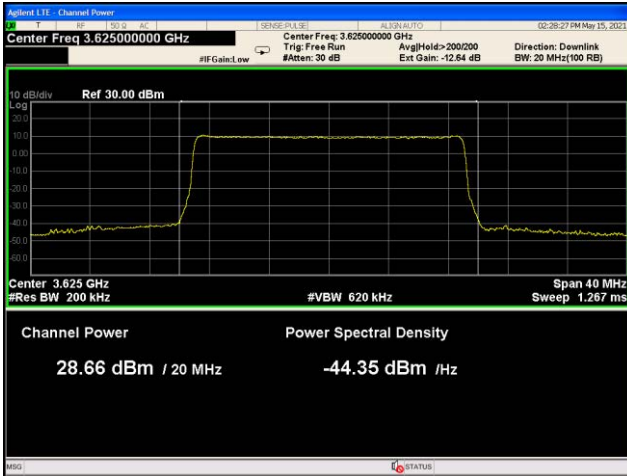

Middle channel

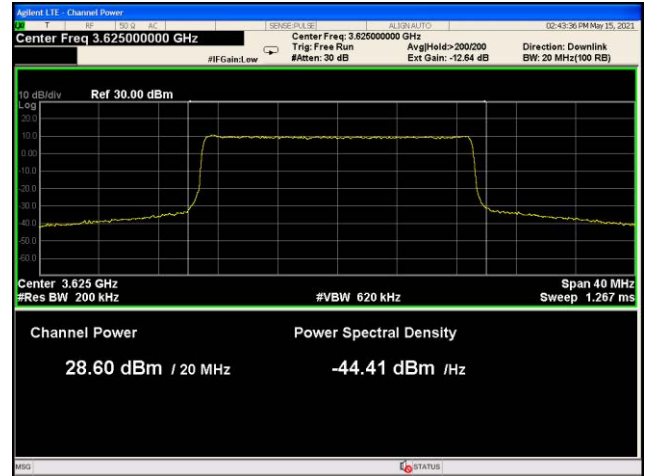

Middle channel

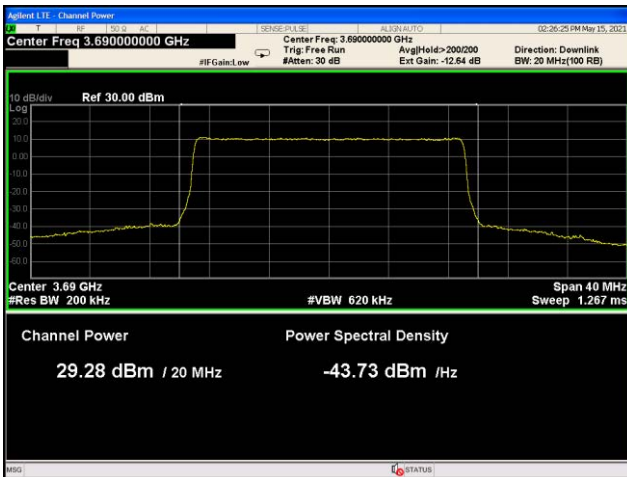

Highest channel

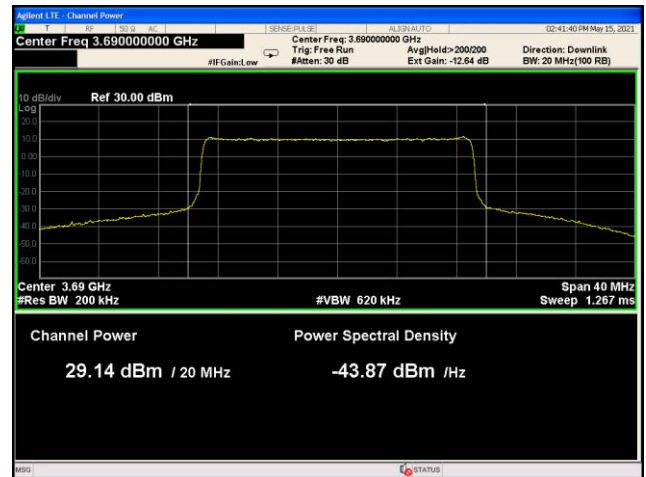

Highest channel

Bandwidth=20MHz – QPSK

ANT 2

ANT 3

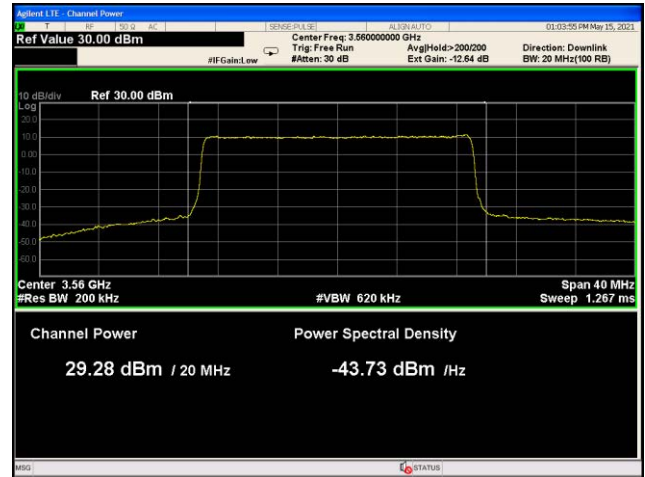
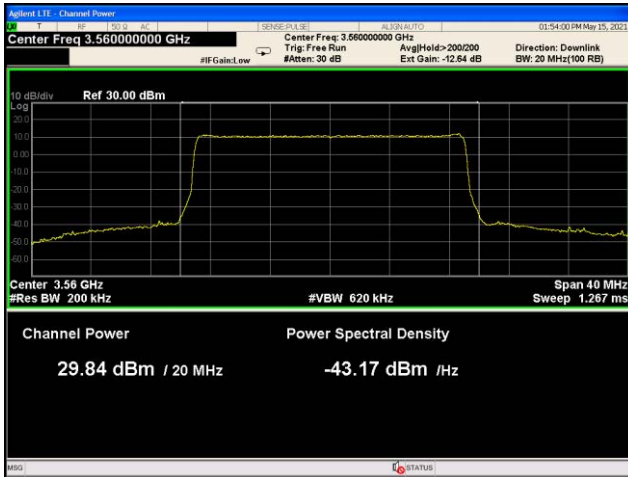

Lowest channel

Lowest channel

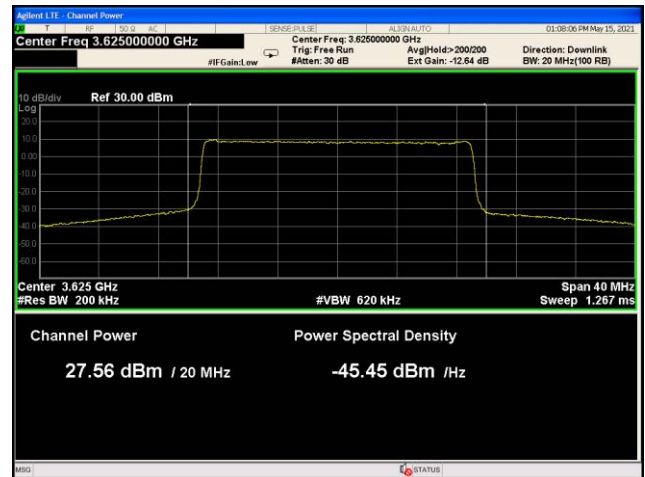
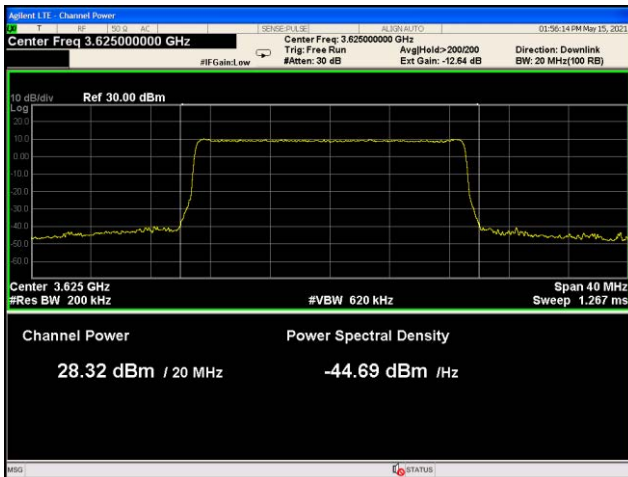

Middle channel

Middle channel

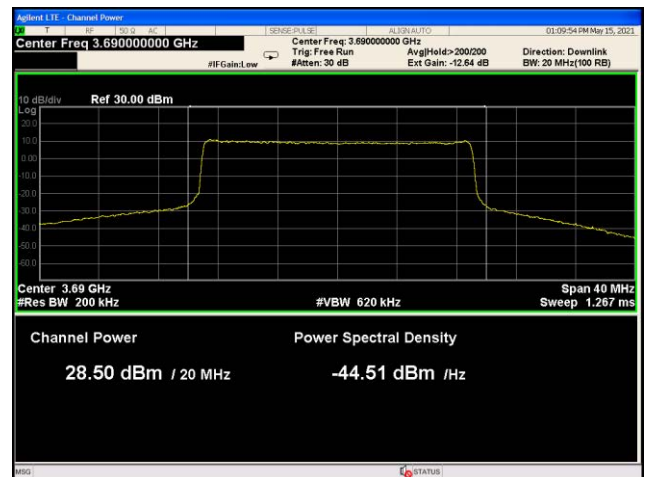
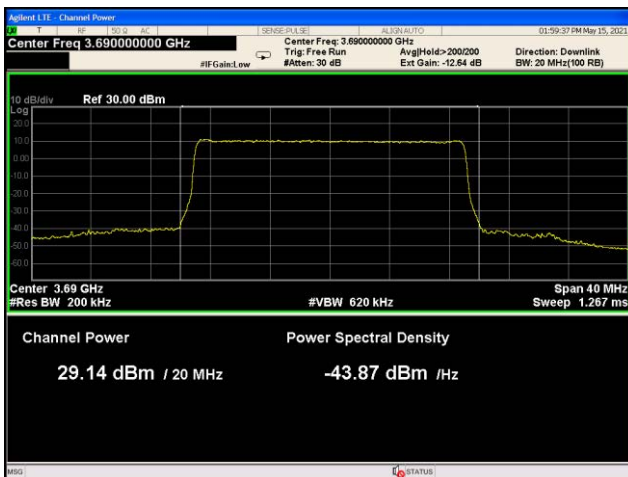

Highest channel

Highest channel

Bandwidth=20MHz – 64QAM

ANT 0

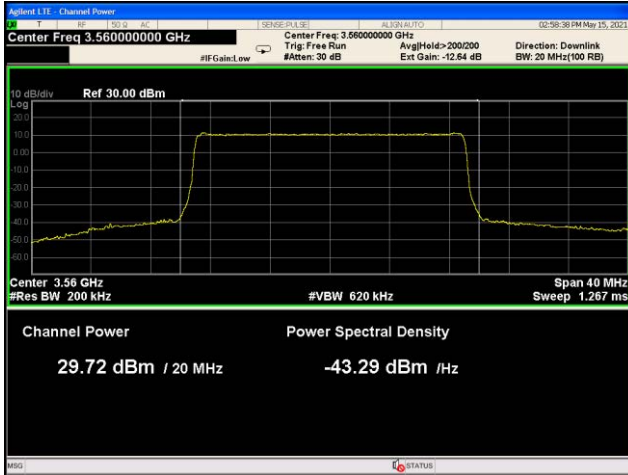

Lowest channel

ANT 1

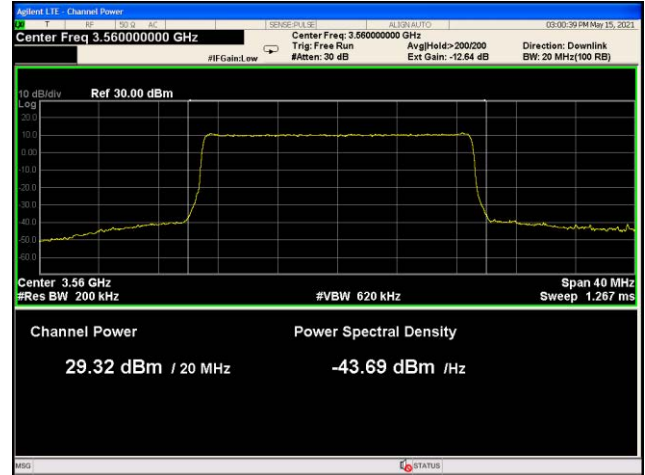

Lowest channel

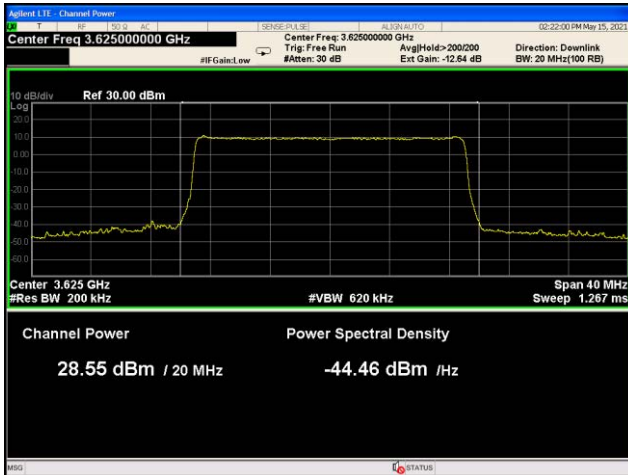

Middle channel

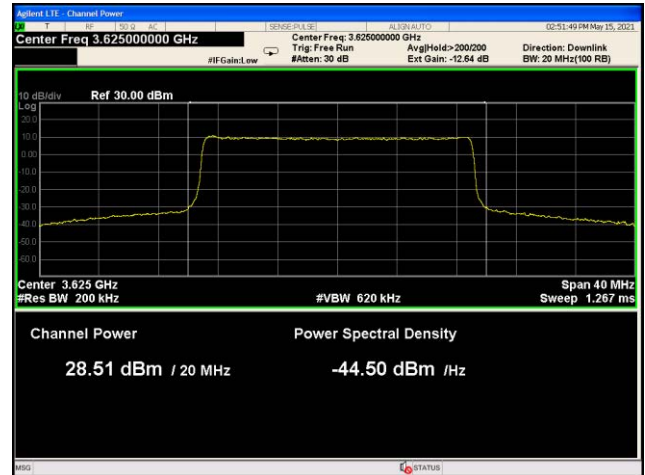

Middle channel

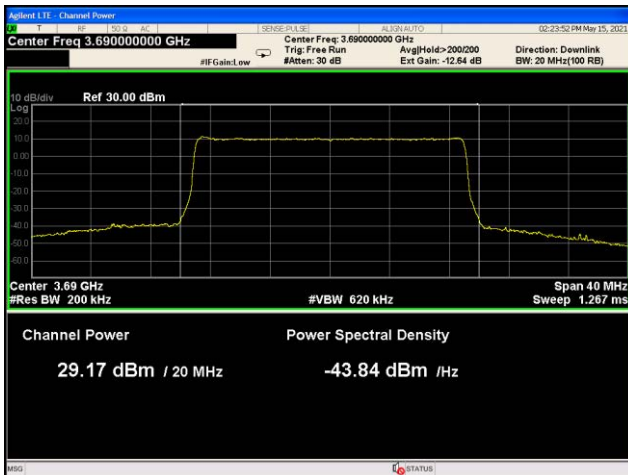

Highest channel

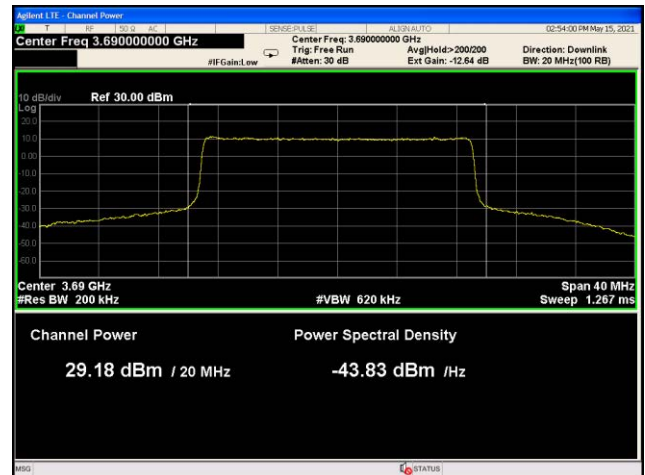

Highest channel

Bandwidth=20MHz – 64QAM

ANT 2

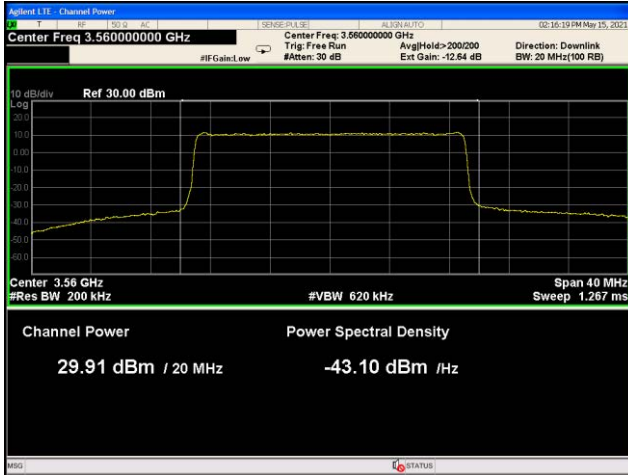

Lowest channel

ANT 3

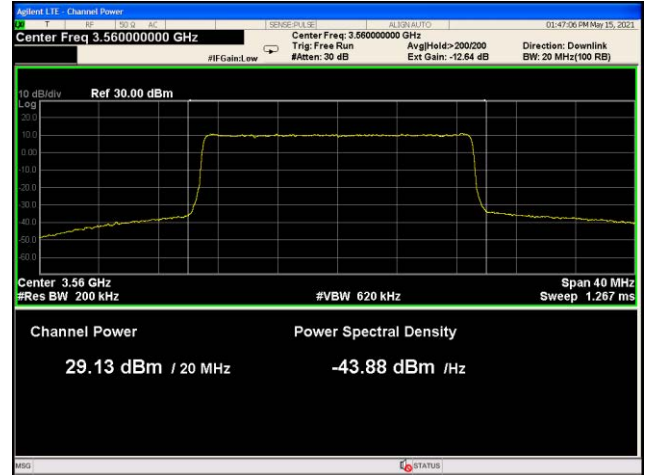

Lowest channel

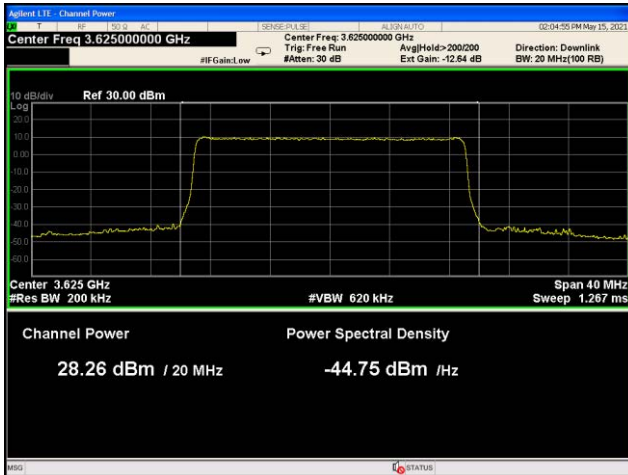

Middle channel

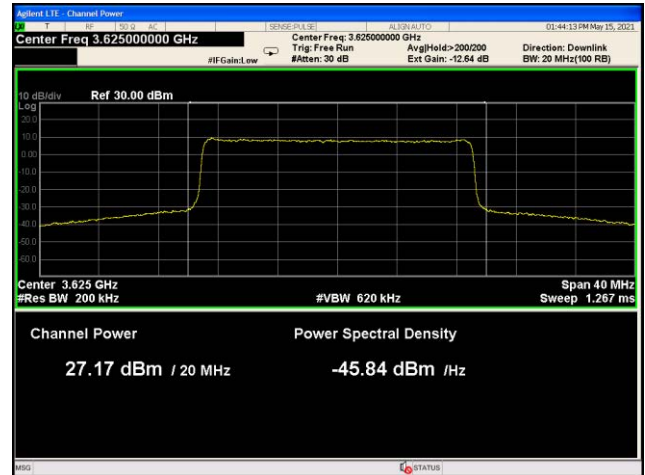

Middle channel

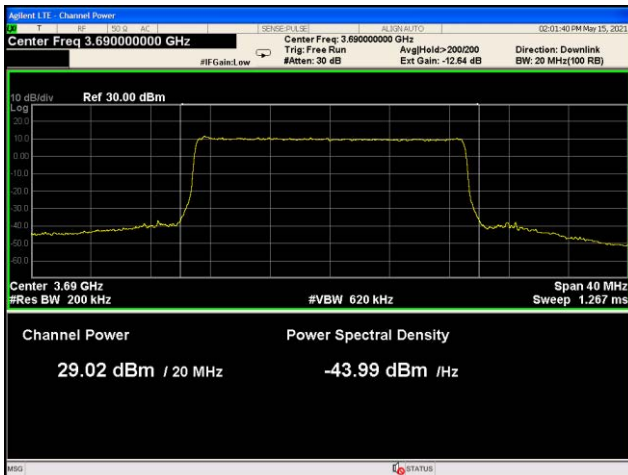

Highest channel

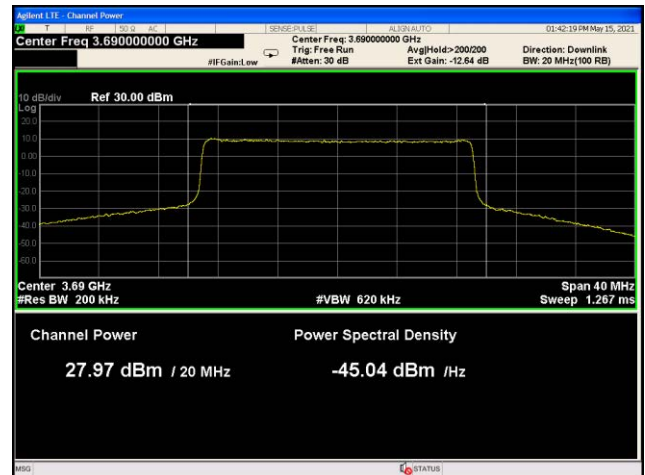

Highest channel

Measurement Data (PSD):

Modulation	Frequency (MHz)	ANT. Port	PSD (dBm/MHz)	Total PSD (dBm/MHz)	Directional Gain (dBi)	EIRP PSD (dBm)	Limit (dBm)
QPSK (10MHz)	3555.00	ANT 0	19.621	22.31	14	36.31	37.00
		ANT 1	18.962				
		ANT 2	19.970	22.59		36.59	
		ANT 3	19.151				
	3625.00	ANT 0	19.361	22.42		36.42	
		ANT 1	19.456				
		ANT 2	19.151	21.77		35.77	
		ANT 3	18.327				
	3695.00	ANT 0	18.946	22.29		36.29	
		ANT 1	19.589				
		ANT 2	19.671	22.38		36.38	
		ANT 3	19.044				
64QAM (10MHz)	3555.00	ANT 0	19.555	22.36	14	36.36	37.00
		ANT 1	19.126				
		ANT 2	19.895	22.60		36.60	
		ANT 3	19.255				
	3625.00	ANT 0	19.700	22.55		36.55	
		ANT 1	19.367				
		ANT 2	19.390	21.81		35.81	
		ANT 3	18.126				
	3695.00	ANT 0	19.900	22.68		36.68	
		ANT 1	19.424				
		ANT 2	19.767	22.49		36.49	
		ANT 3	19.168				
QPSK (20MHz)	3560.00	ANT 0	16.639	19.21	14	33.21	37.00
		ANT 1	15.706				
		ANT 2	17.109	19.82		33.82	
		ANT 3	16.497				
	3625.00	ANT 0	16.520	19.69		33.69	
		ANT 1	16.835				
		ANT 2	16.492	18.95		32.95	
		ANT 3	15.302				
	3690.00	ANT 0	16.787	19.65		33.65	
		ANT 1	16.494				
		ANT 2	16.749	19.61		33.61	
		ANT 3	16.452				
64QAM (20MHz)	3560.00	ANT 0	16.349	19.22	14	33.22	37.00
		ANT 1	16.065				
		ANT 2	16.946	19.72		33.72	
		ANT 3	16.450				
	3625.00	ANT 0	16.775	19.71		33.71	
		ANT 1	16.626				
		ANT 2	16.535	18.99		32.99	
		ANT 3	15.354				
	3690.00	ANT 0	16.881	19.71		33.71	
		ANT 1	16.512				
		ANT 2	16.839	19.62		33.62	
		ANT 3	16.378				
Remark:	1. ANT 0 and ANT 1 is 2*2MIMO, ANT 2 and ANT 3 is 2*2MIMO 2. Note: All transmit signals are completely uncorrelated with each other, Directional gain = G_{ANT} =14dBi						

Test plot as below:

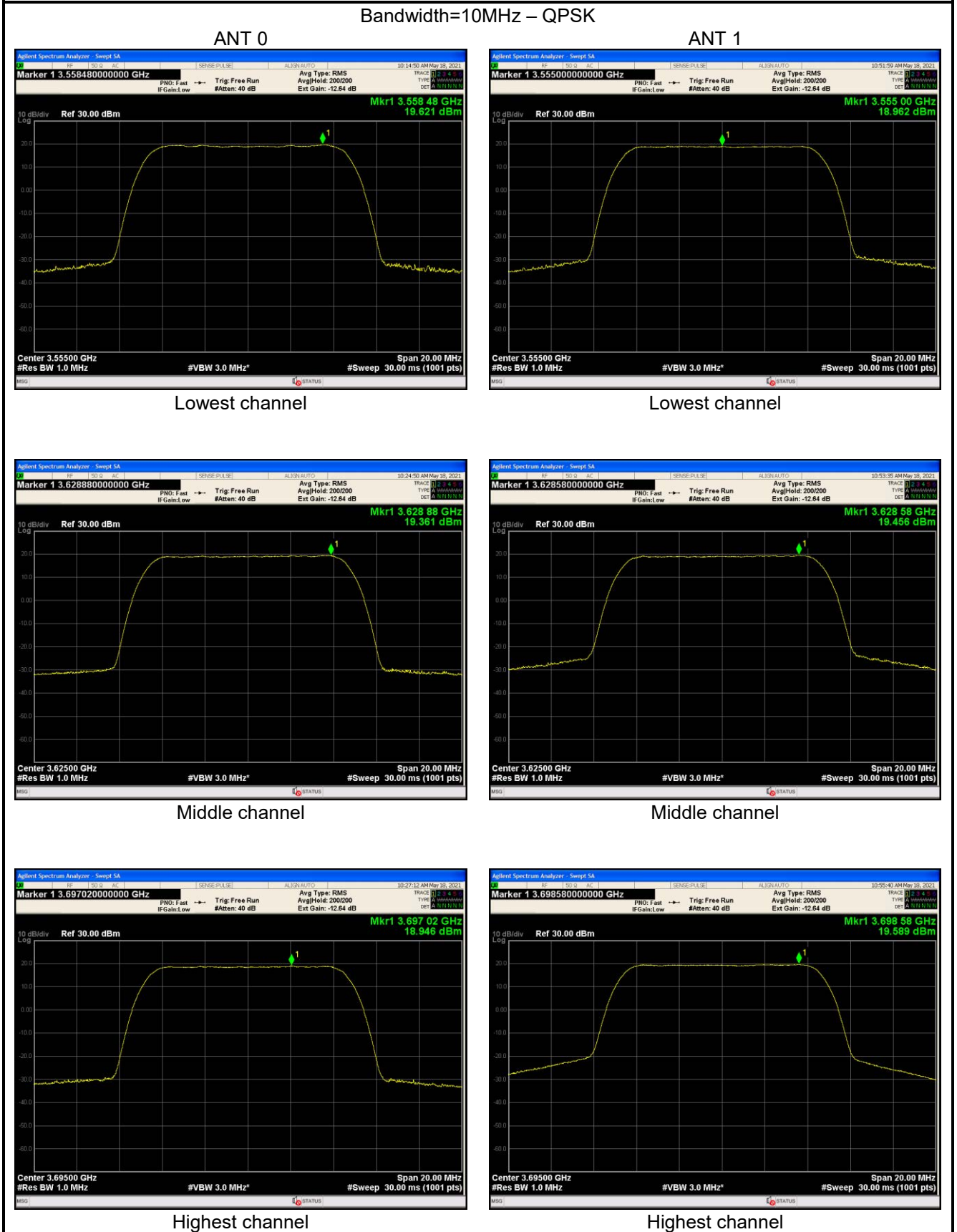

Bandwidth=10MHz – QPSK

ANT 2

ANT 3

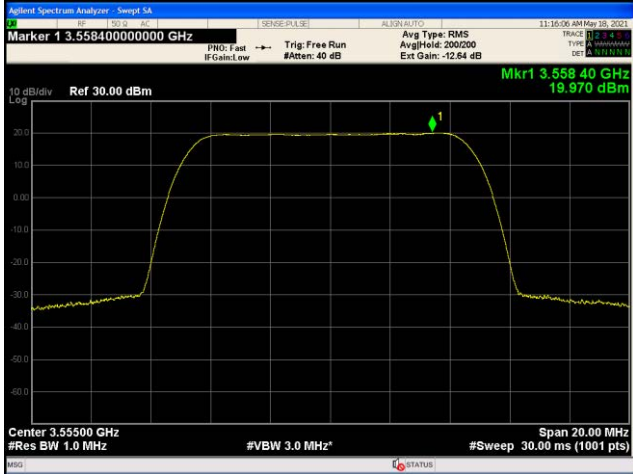

Lowest channel

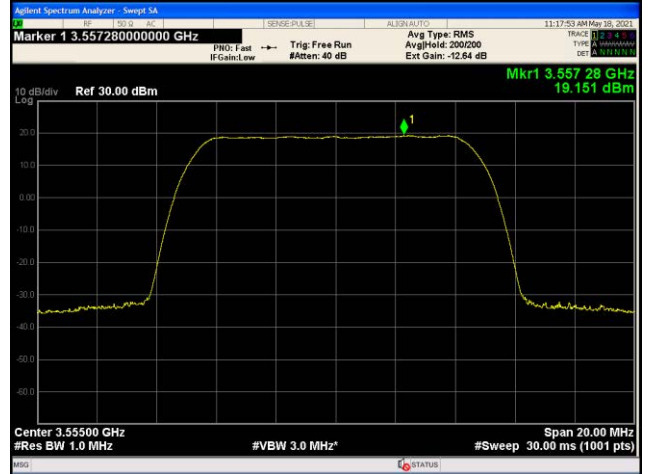

Lowest channel



Middle channel

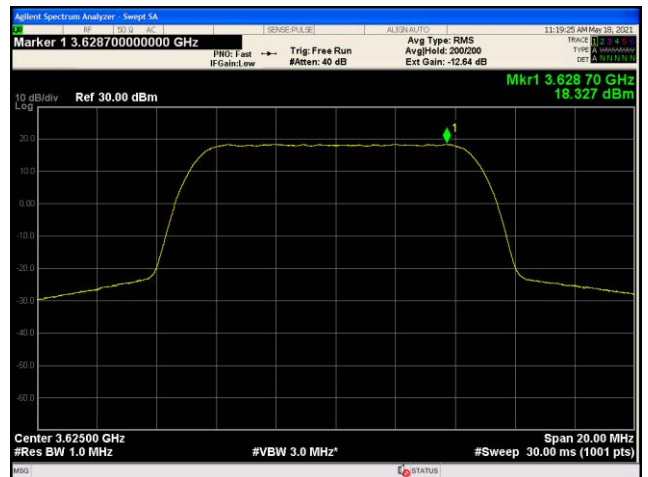

Middle channel



Highest channel

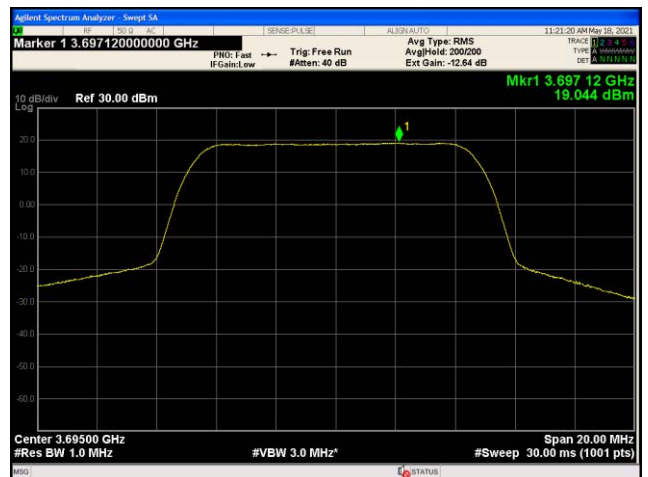

Highest channel

Bandwidth=10MHz – 64QAM

ANT 0

ANT 1

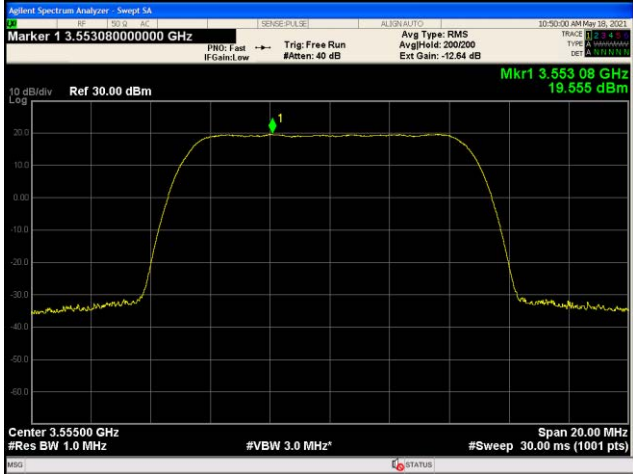

Lowest channel

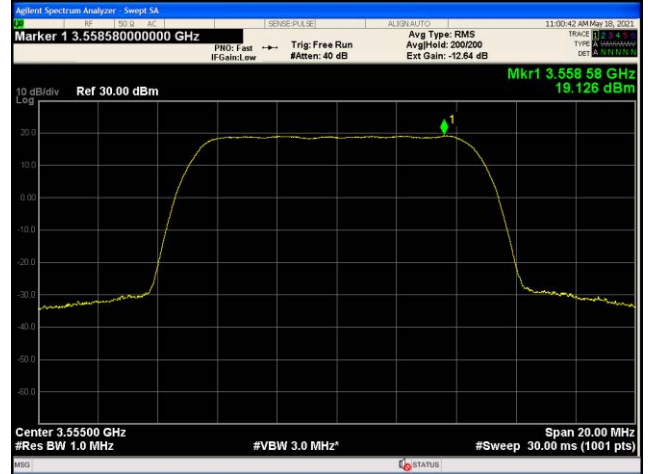

Lowest channel

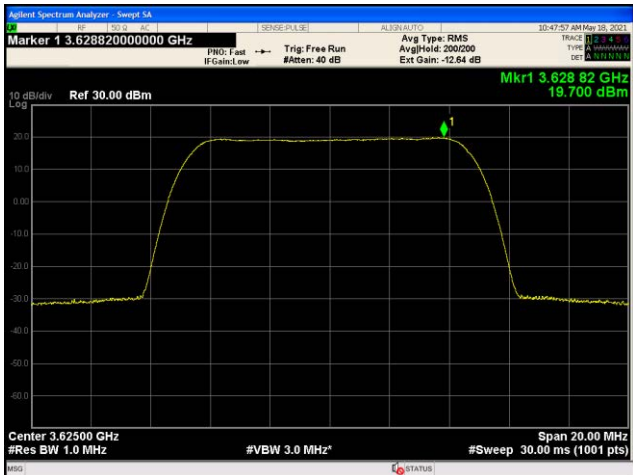

Middle channel

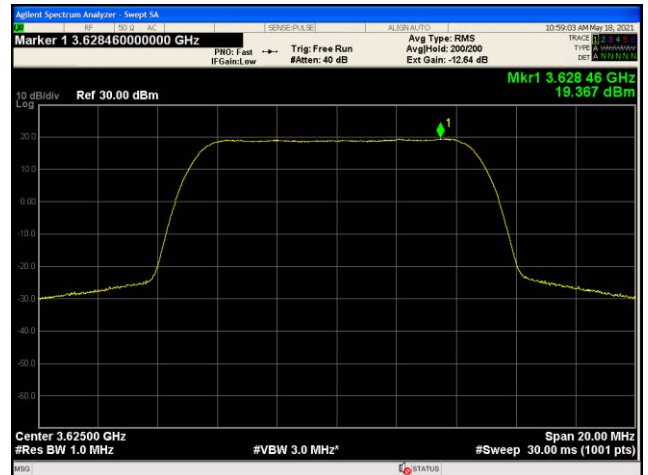

Middle channel

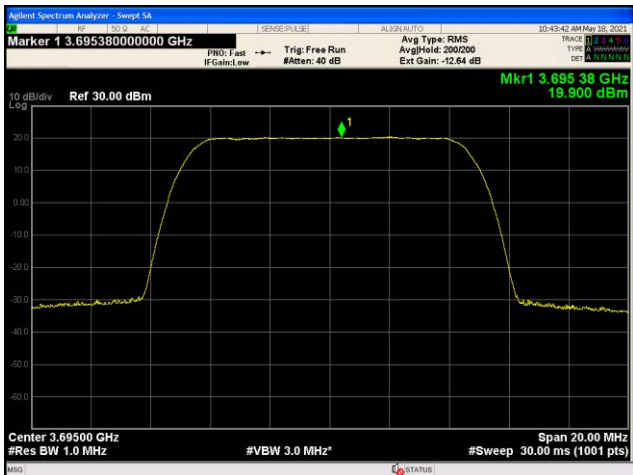

Highest channel

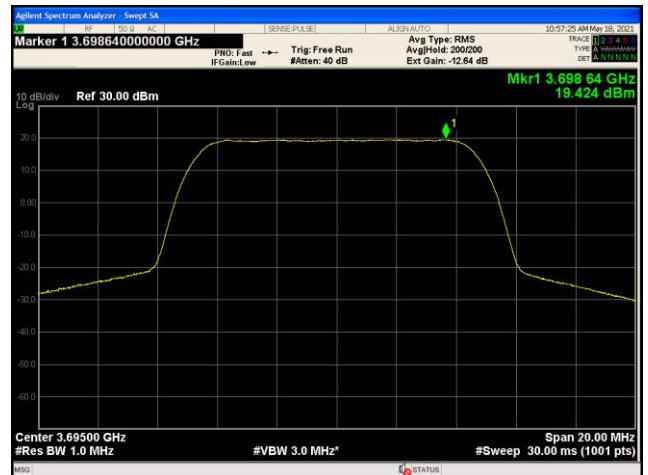

Highest channel

Bandwidth=10MHz – 64QAM

ANT 2

ANT 3

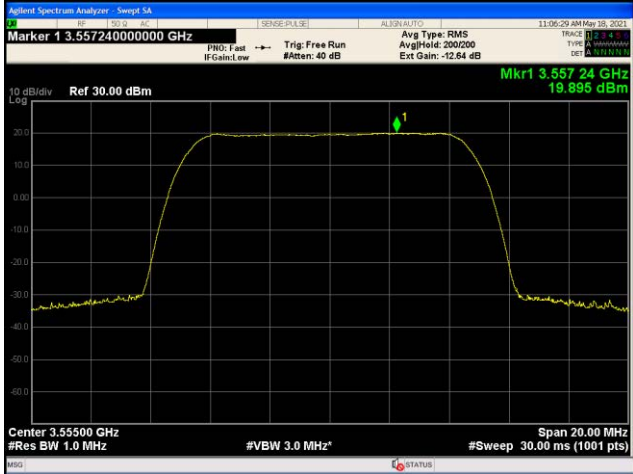

Lowest channel

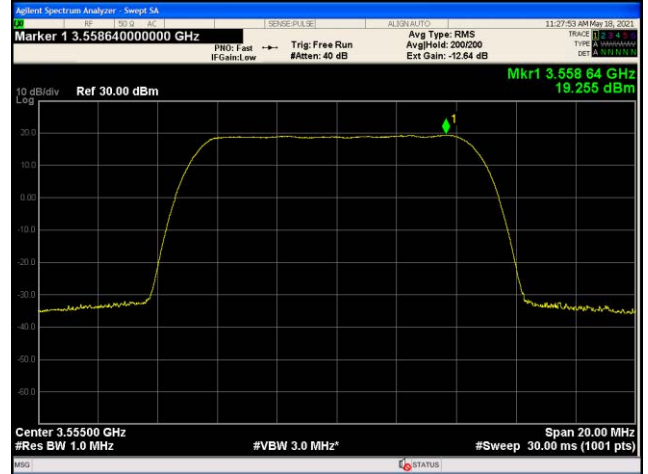

Lowest channel

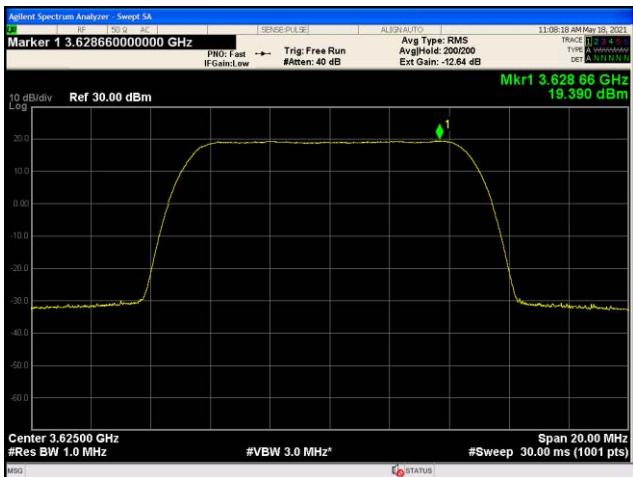

Middle channel



Middle channel

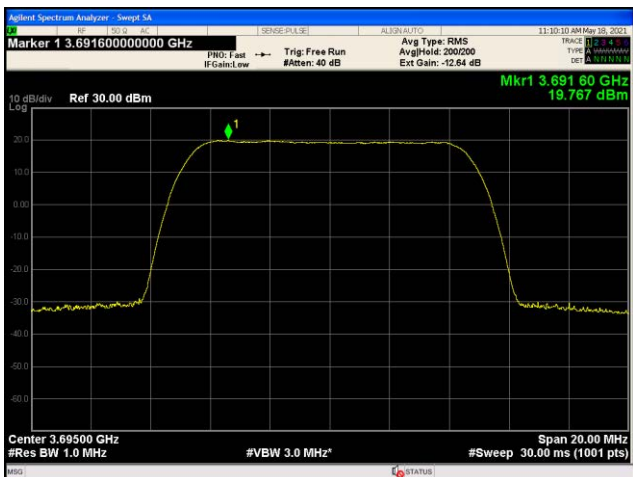

Highest channel



Highest channel

Bandwidth=20MHz – QPSK

ANT 0

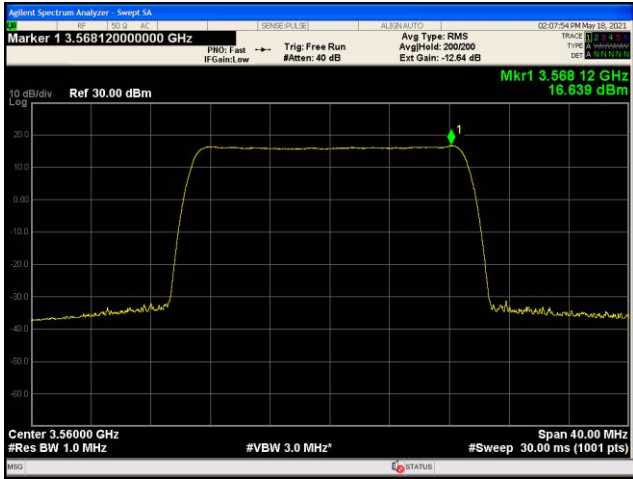

Lowest channel

ANT 1

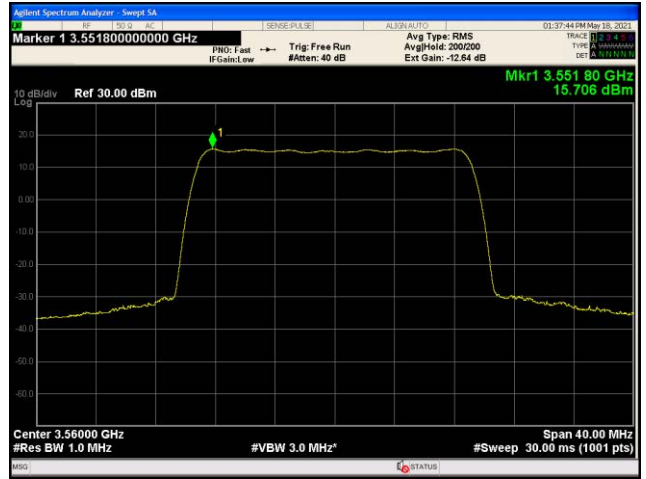

Lowest channel

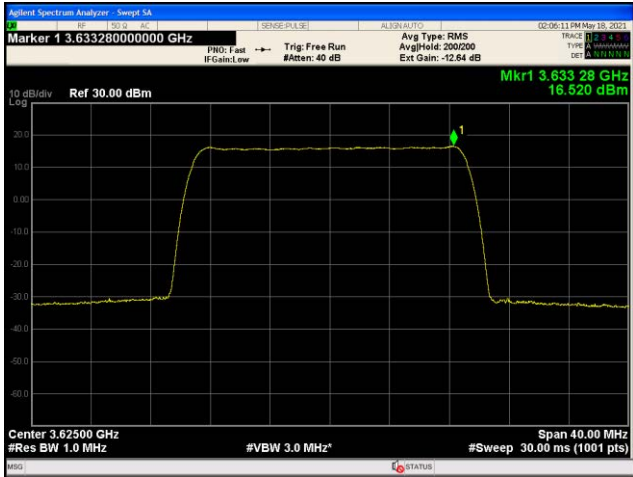

Middle channel

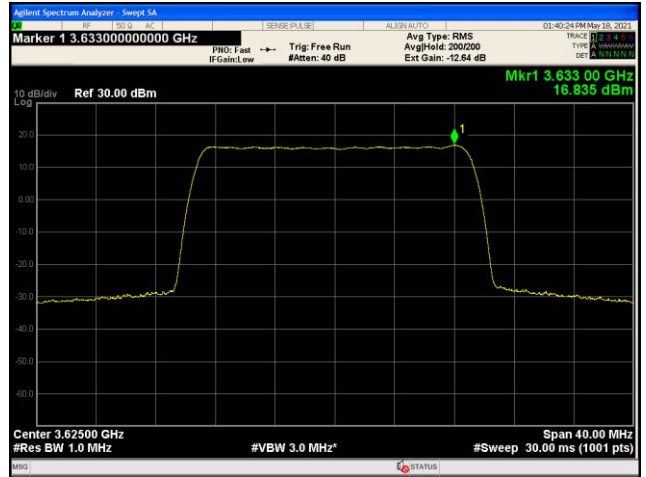

Middle channel

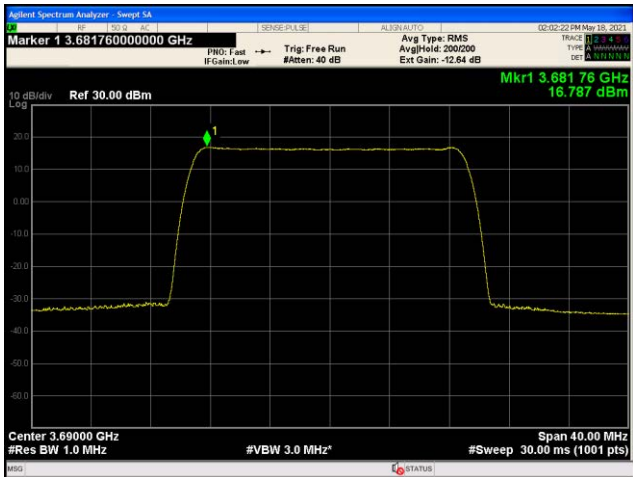

Highest channel

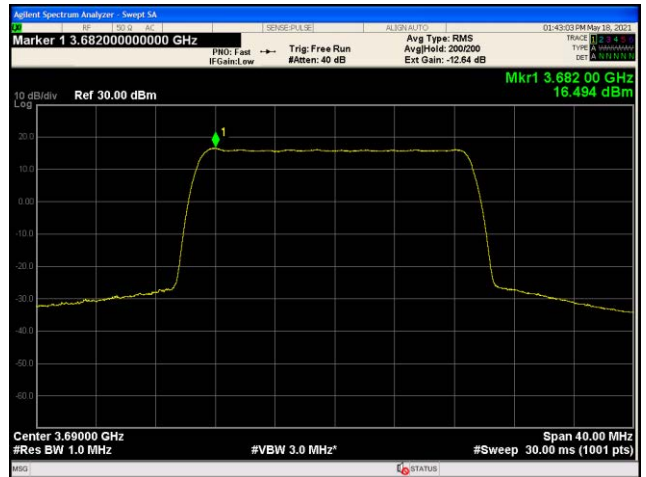

Highest channel

Bandwidth=20MHz – QPSK

ANT 2

ANT 3

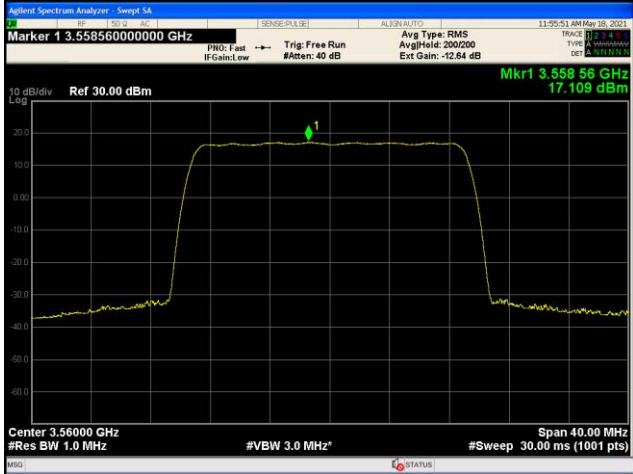

Lowest channel

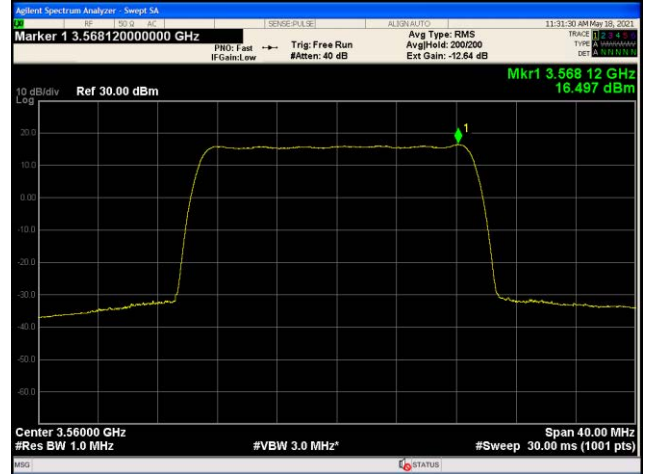

Lowest channel

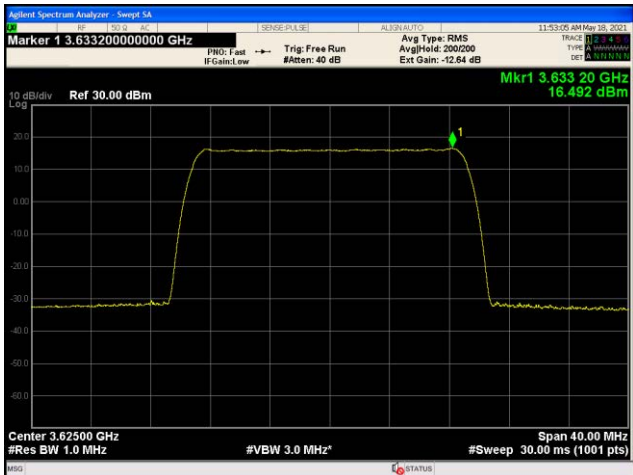

Middle channel

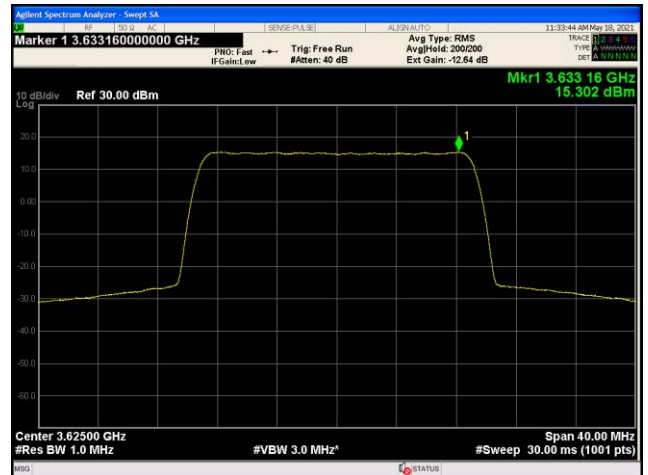

Middle channel

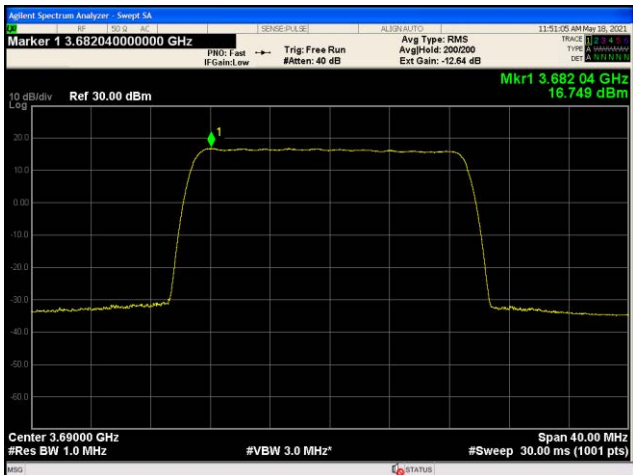

Highest channel

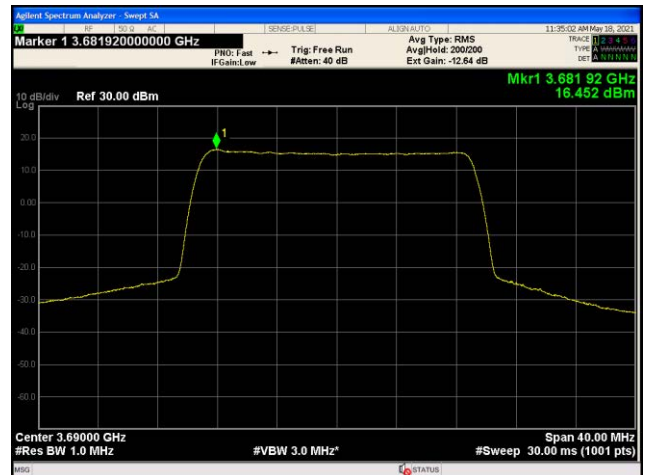

Highest channel

Bandwidth=20MHz – 64QAM

ANT 0

ANT 1

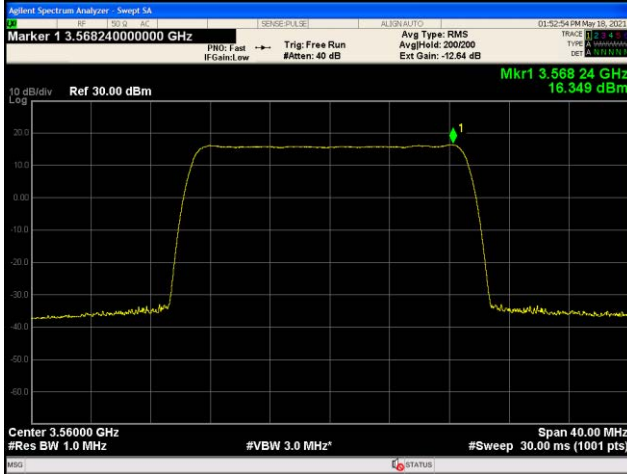

Lowest channel

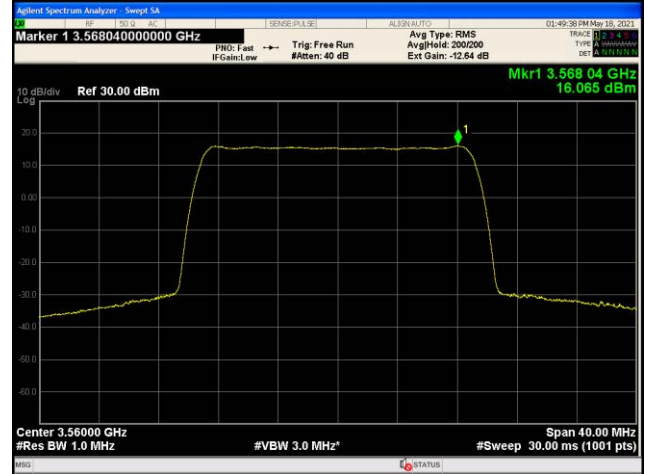

Lowest channel

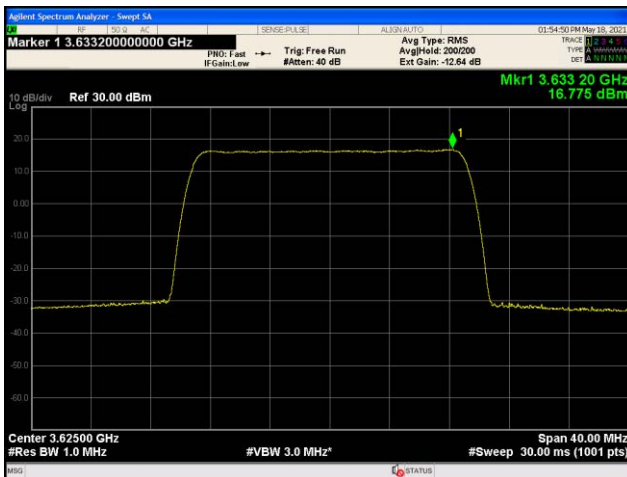

Middle channel

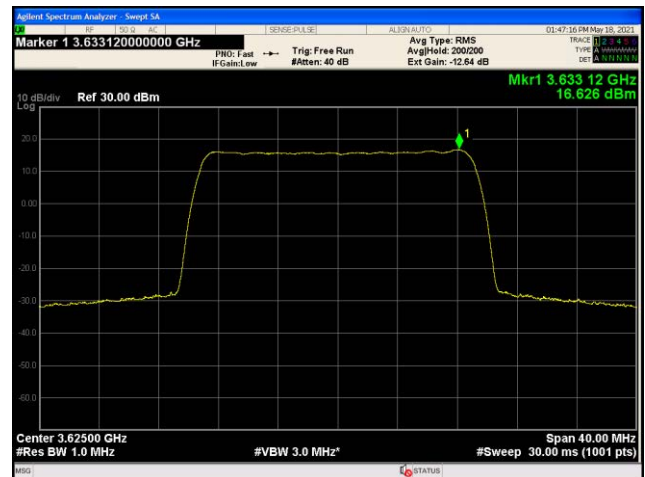

Middle channel

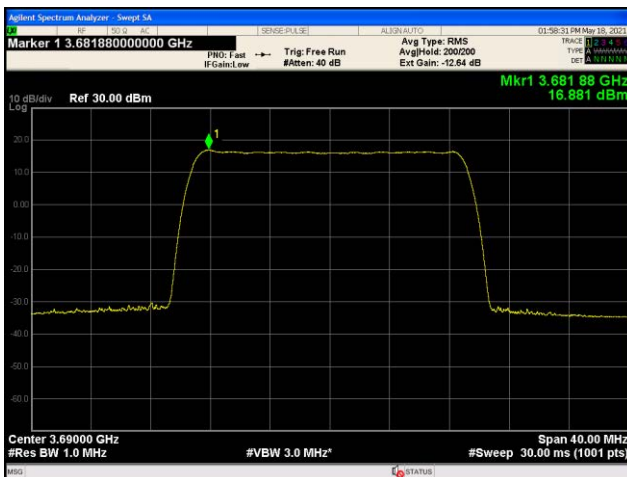

Highest channel

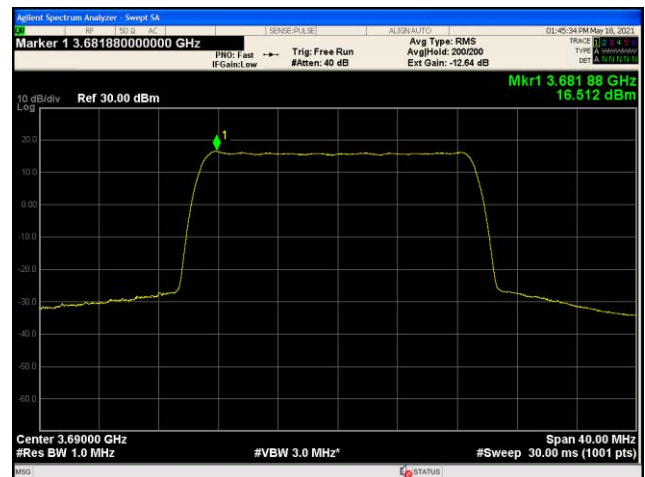

Highest channel

Bandwidth=20MHz – 64QAM

ANT 2

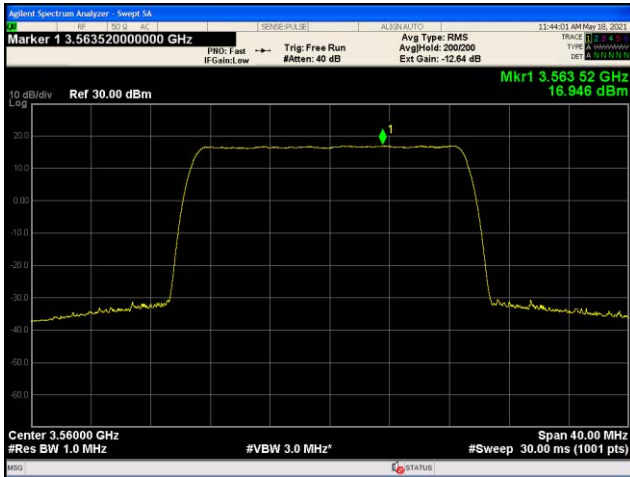

Lowest channel

ANT 3

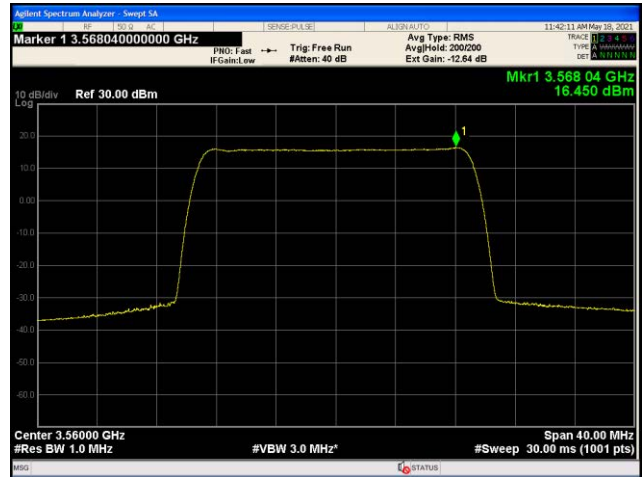

Lowest channel

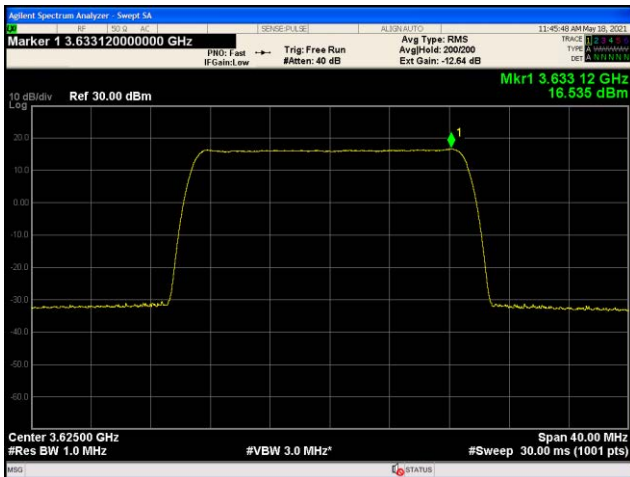

Middle channel

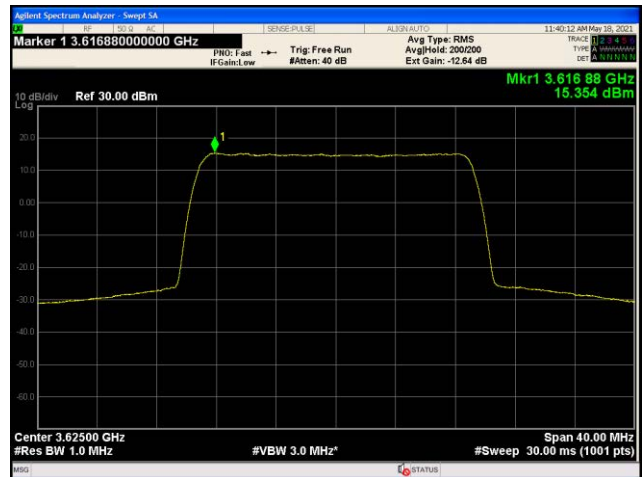

Middle channel

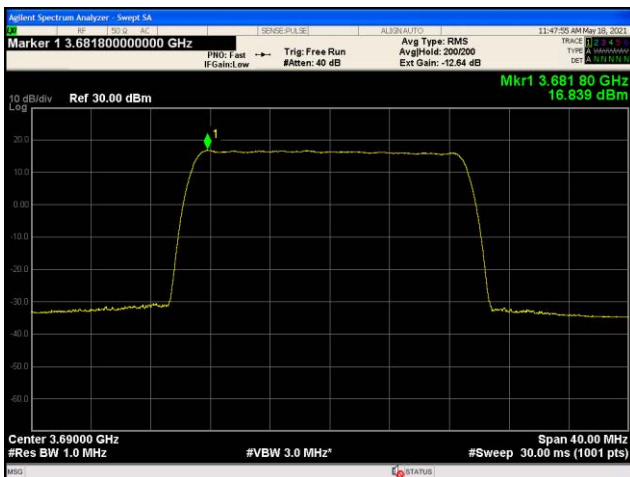

Highest channel



Highest channel

6.2 Peak-to-Average Power Ratio (PAPR)

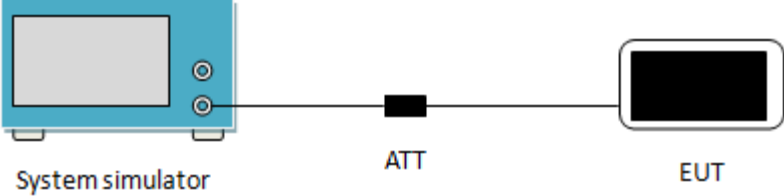
Test Requirement:	FCC part 96.41(g)
Limit:	The peak-to-average ratio (PAR) of the transmission may not exceed 13 dB.
Test setup:	 <p style="text-align: center;">System simulator ATT EUT</p>
Test Procedure:	<ol style="list-style-type: none"> 1 The RF output of the transceiver was connected to a spectrum analyzer through appropriate attenuation. 2 Set the CCDF option in spectrum analyzer, RBW= OBW, 3 Set the EUT working in highest power level, measured and recorded the 0.1% as PAPR level. 4 Repeat step 1~3 at other frequency and modulations.
Test Instruments:	Refer to section 5.8 for details
Test mode:	Refer to section 5.3 for details
Test results:	Passed (Pre-scan all modulation type (QPSK, 16-QAM, 64-QAM), and found the QPKS was the worst case. so only the worst case test data.)

Measurement Data:

Modulation	Frequency (MHz)	ANT. Port	PAPR(dB)	Limit(dB)	Result
10MHz – QPSK	3625.00	ANT 0	8.82	13.00	PASS
	3625.00	ANT 1	8.88		PASS
	3625.00	ANT 2	9.06		PASS
	3625.00	ANT 3	9.17		PASS
20MHz – QPSK	3625.00	ANT 0	8.96		PASS
	3625.00	ANT 1	8.84		PASS
	3625.00	ANT 2	8.84		PASS
	3625.00	ANT 3	8.89		PASS

Bandwidth=10MHz – QPSK

ANT 0



ANT 1



ANT 2



ANT 3

