

CIRCUIT DIAGRAMS

INDEX

1. NTE-182 AIS TRANSPONDER
 - 1.1 NTE-182 CHASSIS
 - 1.2 CAG-2180 LNA UNIT
 - 1.3 CMN-2182 TRX UNIT
 - 1.4 CBD-2182 PS UNIT
 - 1.5 CDJ-2282 CONTROL UNIT

2. NQE-3182 CONNECTION BOX
 - 2.1 NQE-3182 CHASSIS
 - 2.2 CDJ-3182 I/O CONTROL UNIT
 - 2.3 CQD-3182 TERMINAL UNIT
 - 2.4 CQD-5182 JUNCTION UNIT
 - 2.5 CMJ-3182 NSK UNIT (Option)

3. NCM-779 AIS CONTROLLER
 - 3.1 NCM-779 CHASSIS
 - 3.2 CCK-2779 PANEL UNIT
 - 3.3 CDJ-2779 CONTROL UNIT

4. NQD-4382 JUNCTION BOX (Option)
 - 4.1 CMH-4182 DATA CONVERTER UNIT

5. NBD-577B POWER SUPPLY UNIT (Option)
 - 5.1 NBD-577B POWER SUPPLY UNIT

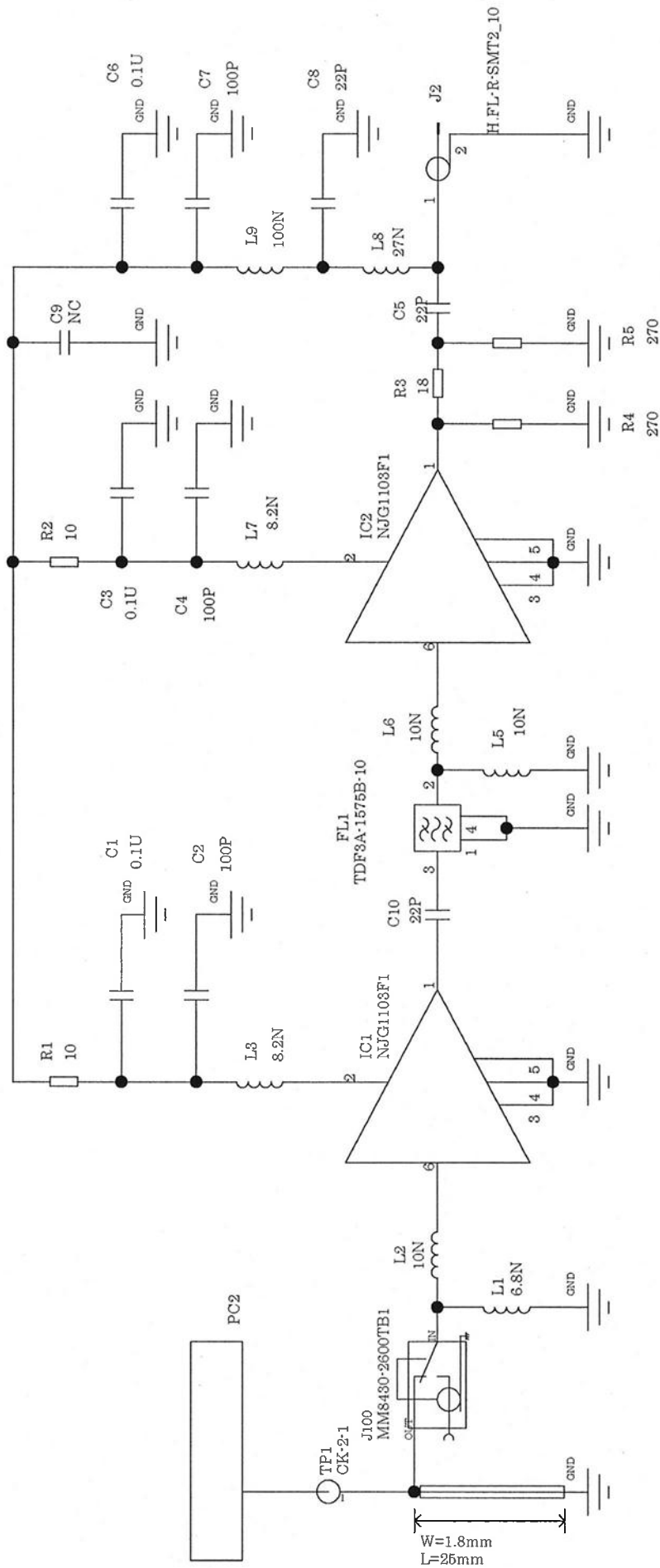

PC1:H-7PCJD0089A
 PD1:H-7PDJD0017A
 PC2:H-7PCJD0097A
 (GPS ANT)

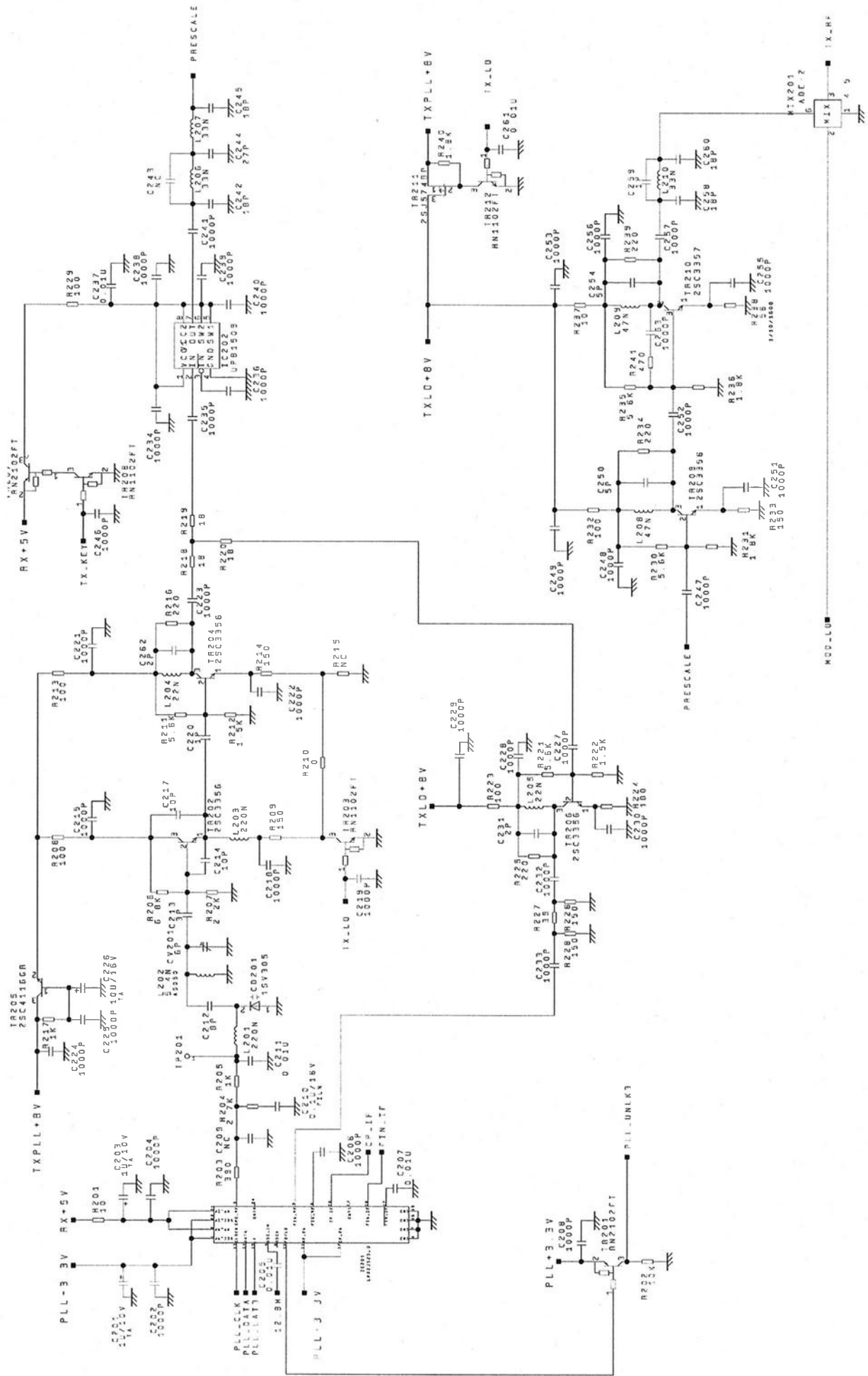

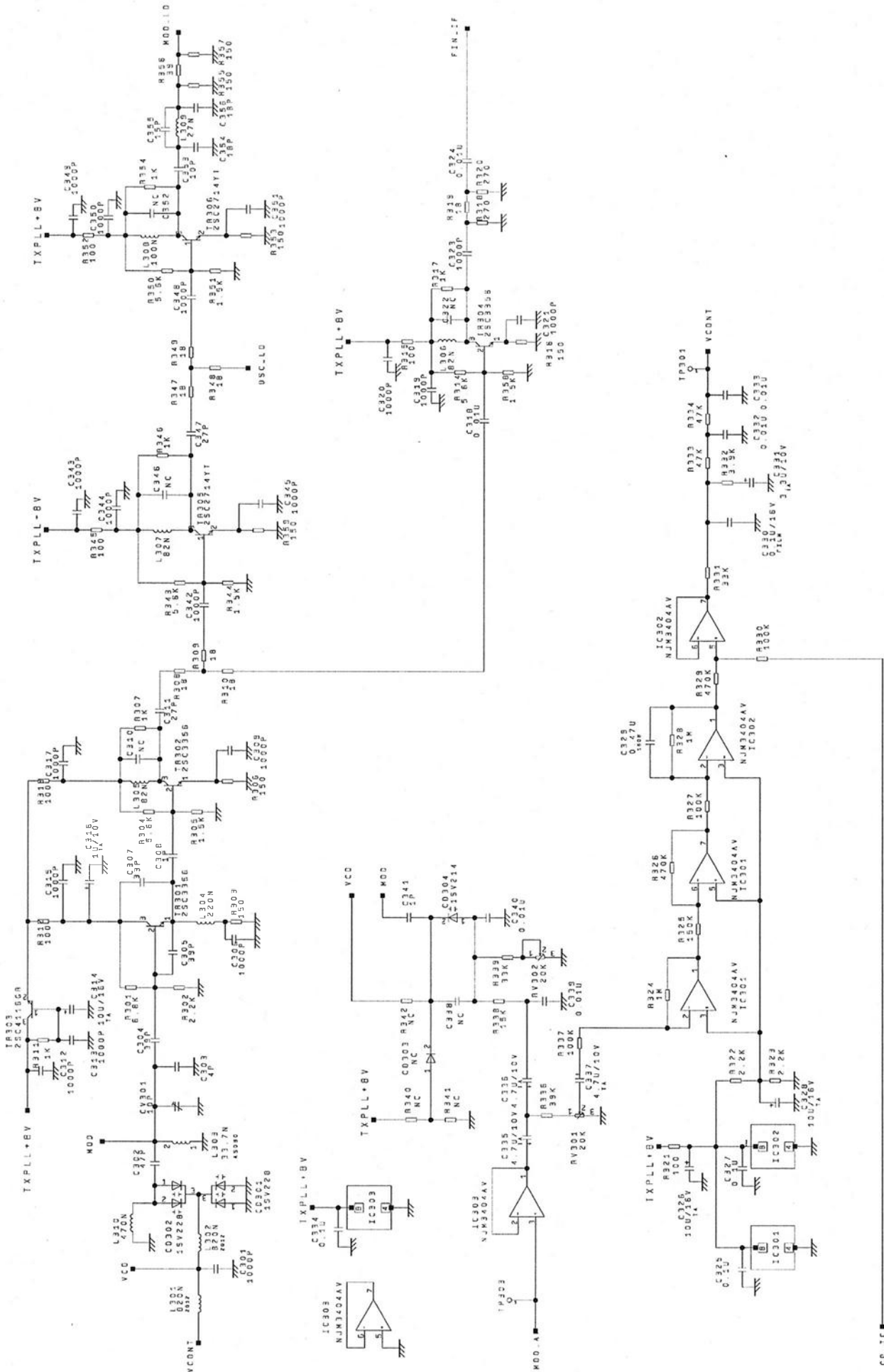

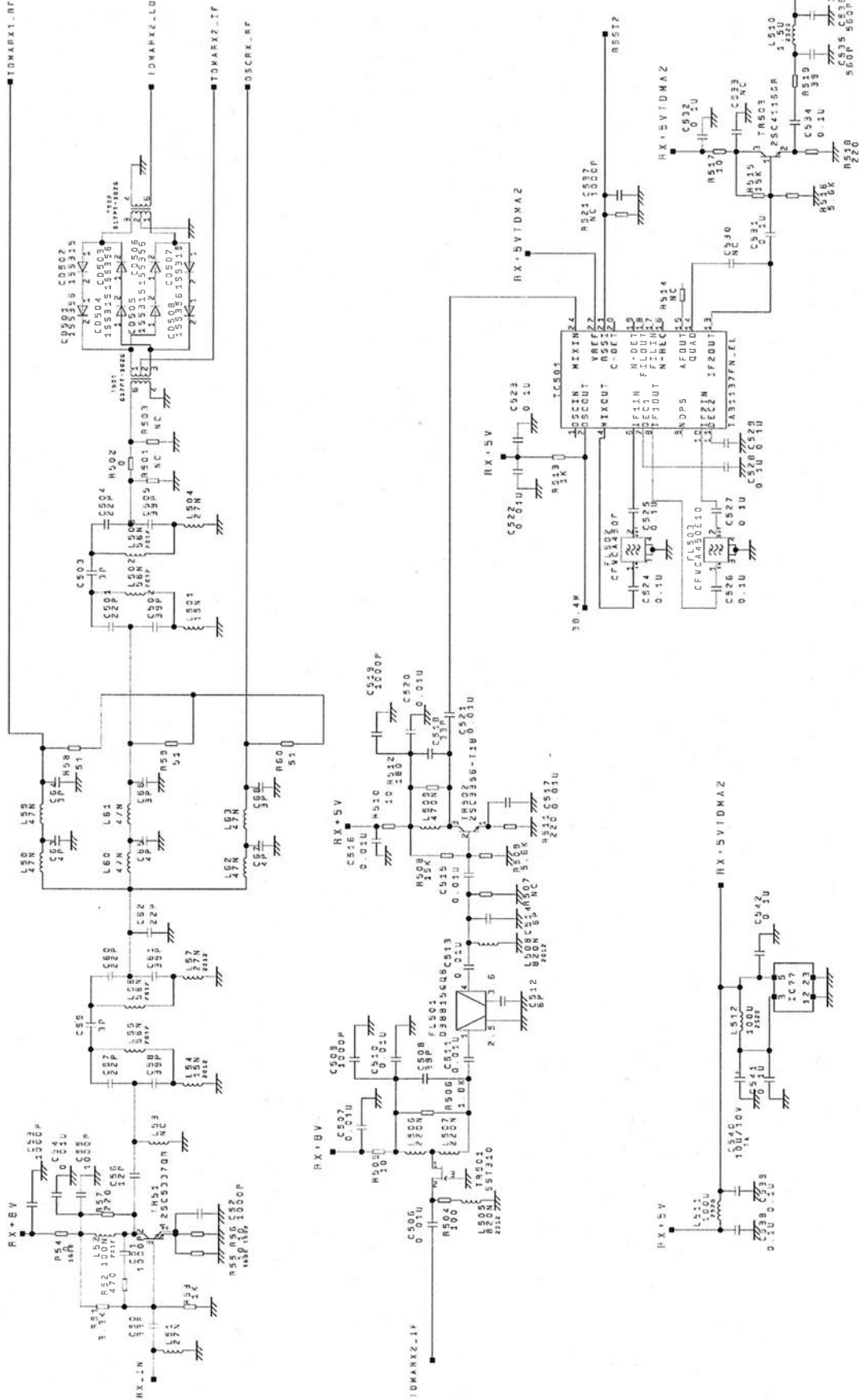

注: 部品名は必ずしも実装部品名と一致しない場合があります。
 Note: Component names may not always match the actual installed component names.
 Unless otherwise specified, all dimensions are in mm.
 Dimensions in parentheses are in inches.
 NC: None Connection

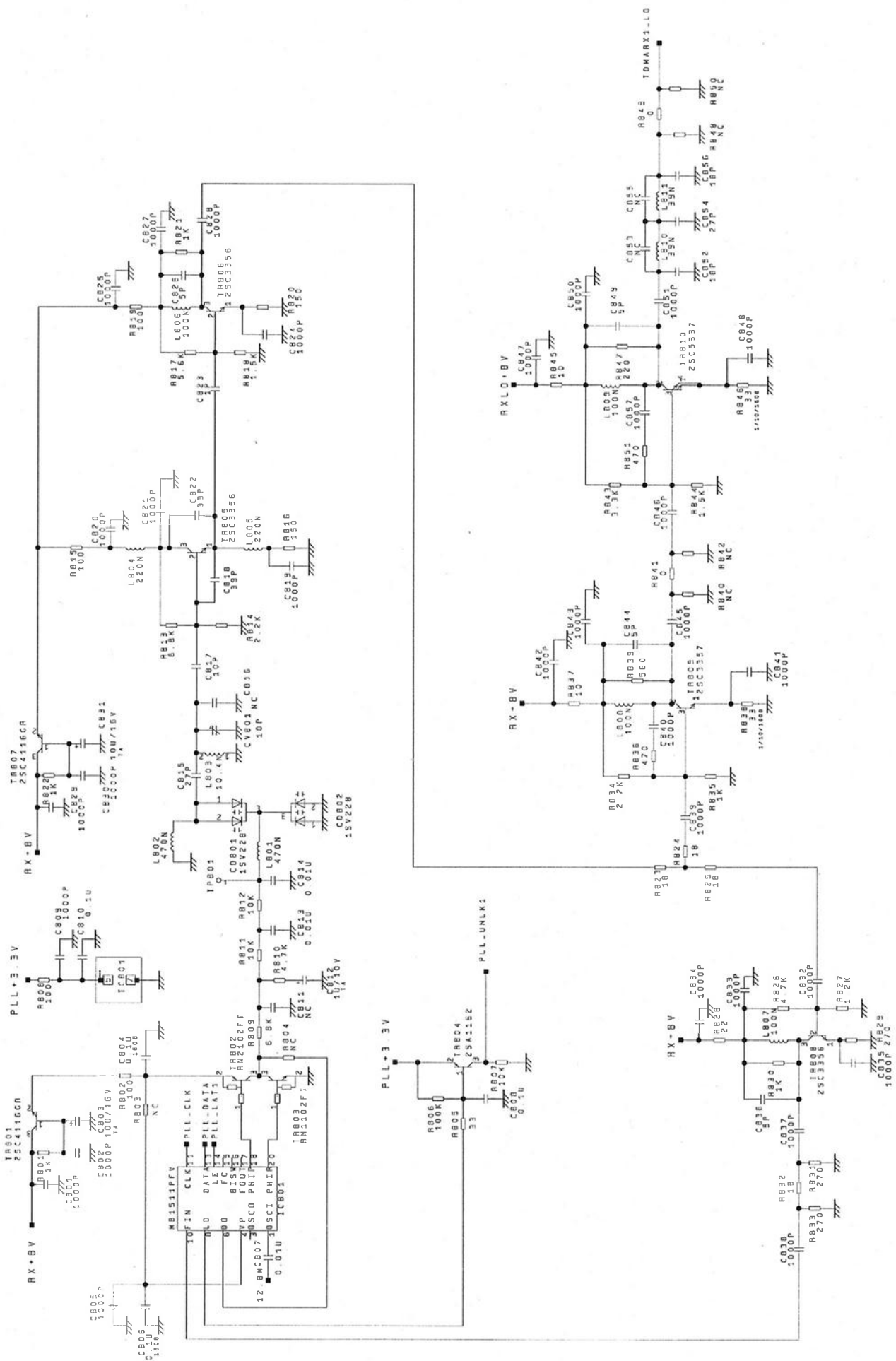

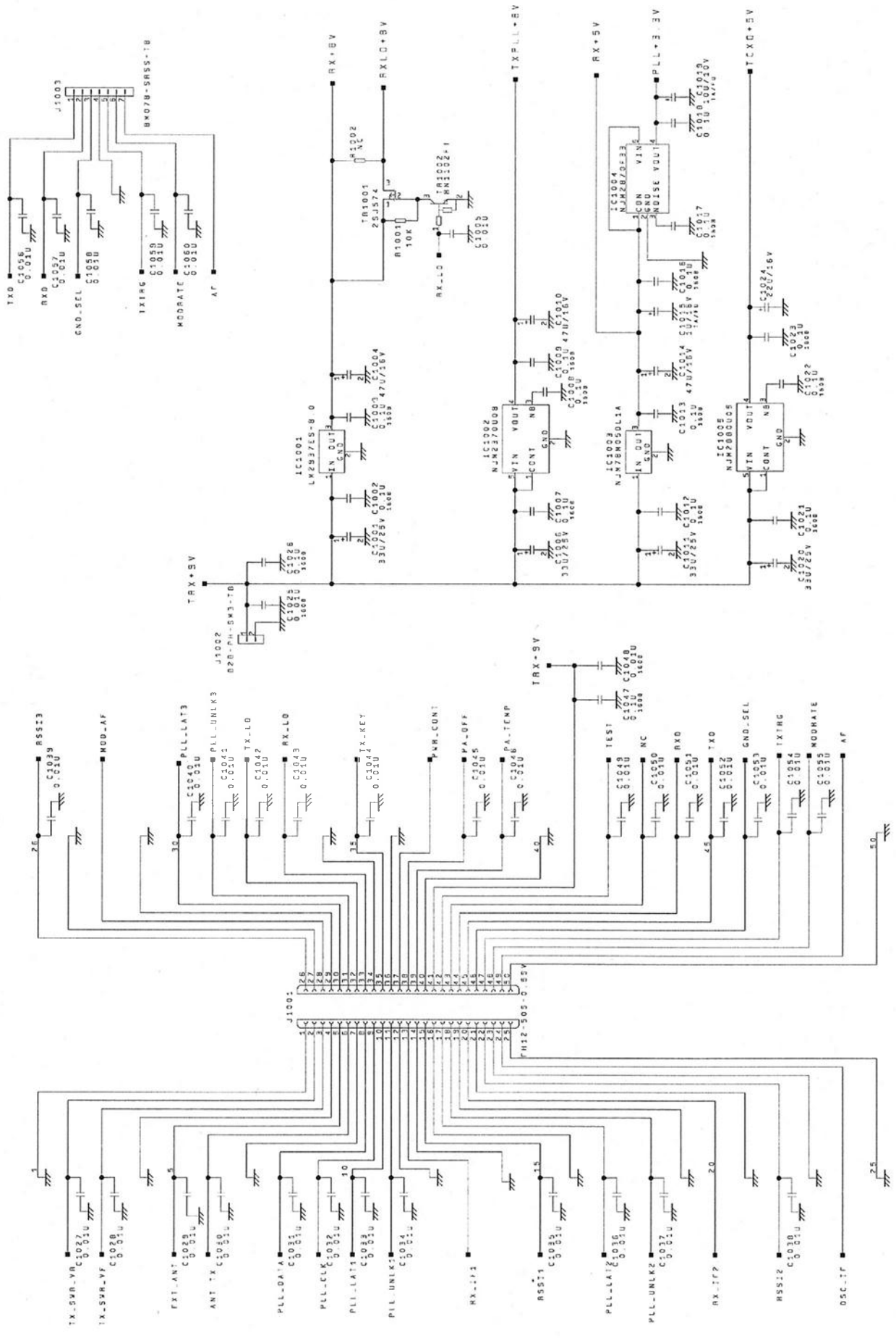

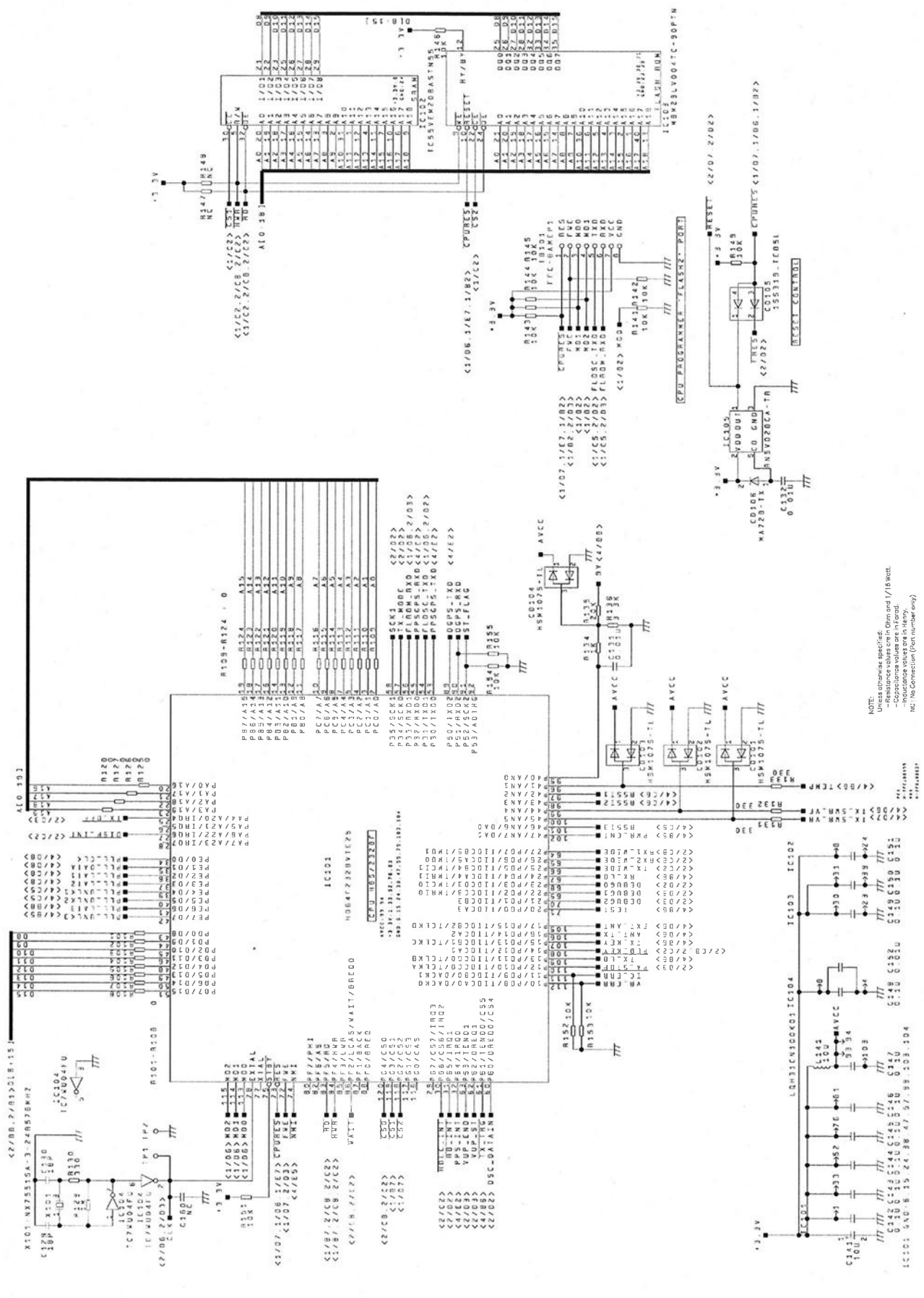

NOTE:
 -Resistor values are in Ohm and V/16 Watt.
 -Capacitor values are in pF and uF.
 -Inductor values are in mH.
 -IC connection (Part number only)

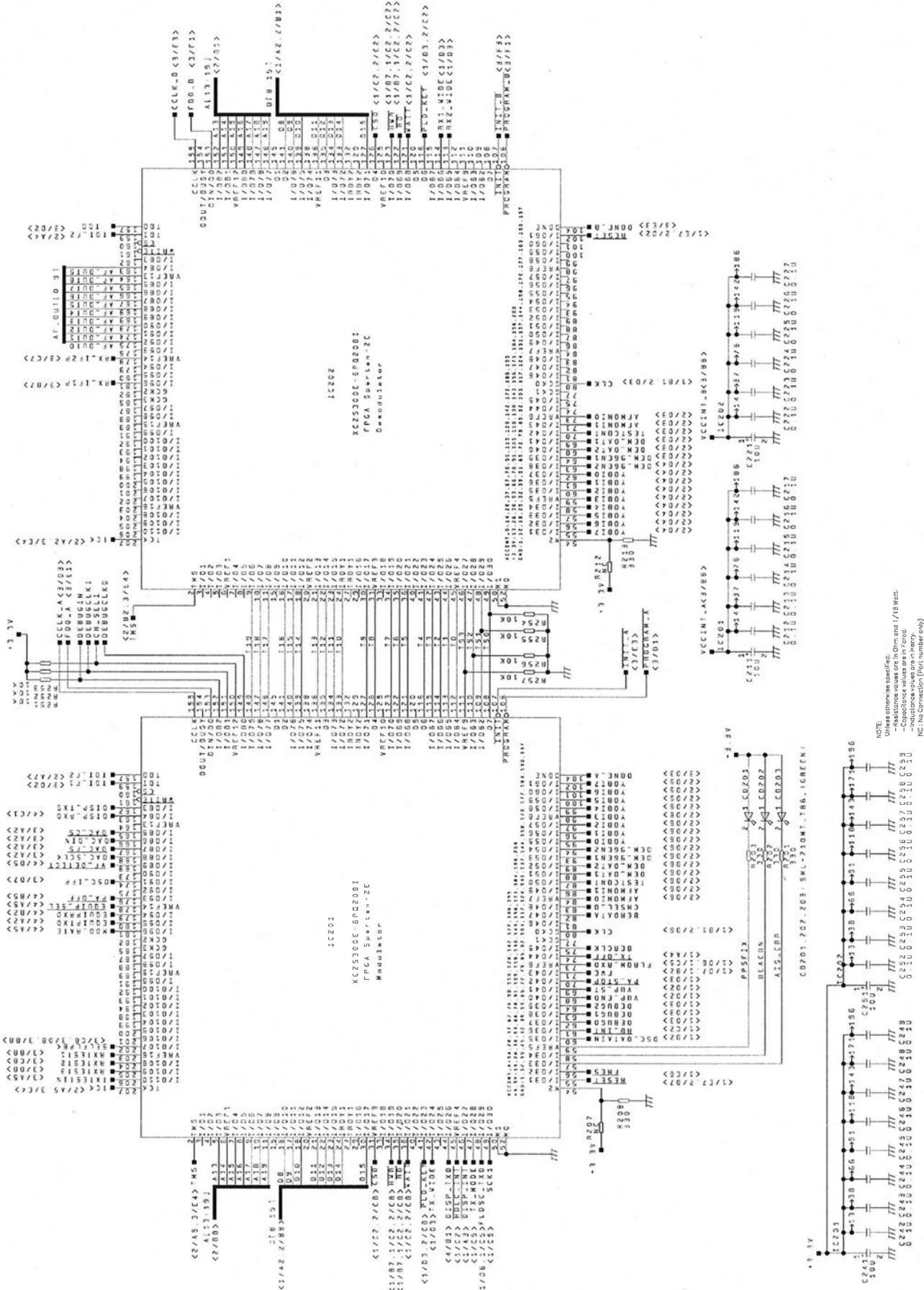

CDJ-2282 CONTROL UNIT (2/4)

NOTE:
 Utilize observations specified:
 -Resistance values are in Ohm and 1/8 Watt.
 -Capacitance values are in Farad.
 NC: No Connection (Part number only)

