

---

# VHF Airband Transceiver

## JHP-500/520

---

Operation Manual

 *Japan Radio Co., Ltd.*

FCC ID: CKEJHP-500  
2.1033(c)(3) MANUAL

### <Introduction>





- Before using this product, be sure to thoroughly read this instruction manual to ensure correct use.
- After reading this instruction manual store in a safe place so that it can be referred to whenever necessary. This instruction manual will come in useful if you are unsure of an operation during use or if some trouble occurs.
- JHP-500/520 can receive and display VOR signals of equisignal localizers. Using this operating mode, however, does not make the device an air navigation system according to flight safety regulations.

### <Before Use>

Carefully read the Precautions Upon Use before using the equipment to ensure proper use. The cautions show here describe how to avoid injuring yourself or others while using the equipment, and how to avoid damaging the equipment. Be sure to follow these instructions. The follow warning and caution labels indicate the degree of equipment damage or personal injury that can occur if you do not follow the safety instructions and use the equipment improperly.







<b>⚠ WARNING</b>	This label indicate there is a possibility of death or serious injury if the proper procedures are not followed.
<b>⚠ CAUTION</b>	This label indicate there is a possibility of injury or damage to the equipment if the proper procedures are not followed.

### Examples of Icons



- |  |  |
|--|--|
| <br>CAUTION<br>ELECTRIC SHOCK | △ icons tell you that caution (including DANGER and WARNING) is urged. The actual details of the caution are pictured inside the icon. (The icon on the left indicates that caution is urged to prevent electric shock.) |
| <br>FORBIDDEN                 | ⊘ icons tell you that a certain action is forbidden. The actual details of the forbidden action are pictured either inside or near to the icon. (The icon in the left indicates that dismantling is forbidden.)          |
| <br>INSTRUCTION               | ● icons tell you that a certain action is compulsory. The actual details of the compulsory action are pictured inside the icon. (The icon in the left indicates that the power plug must be removed from its outlet.)    |
| <br>REMOVE PLUG              |  |

<Precautions Upon Use>

**⚠ WARNING**

-  Do not use any cable other than the supplied Battery charger or option's Desktop charger. Doing so can result in fire or electric shock.
-  Do not scratch, tear, modify, excessively bend, yank, or twist the charger cord, or allow it to become excessively hot. Doing so can damage and tear the cord, resulting in igniting, electric shock, or equipment failures.
-  Do not set anything heavy on the charger cord or connector cords, or sandwich them between objects. Doing so can damage and tear the cords, resulting in igniting, electric shock, or equipment failures.
-  Do not use the charger cord if the cord or plug is damaged, or if it fits loosely in the outlet. Doing so can result in a short circuit and start fire.
-  Only use the specified supply voltage. Using a different supply voltage can cause the equipment to ignite or burst into flames.
-  Do not exceed a charging time of 15 hours. Doing so can cause the equipment to ignite or burst into flames.

**⚠ WARNING**

-  You are forbidden to subject the cell to any of the following when handling the Battery
  - Uses other than specified
  - Burning of Battery
  - Heating above 70°C
  - Short-circuiting
  - Disassembly, damage and deformation by applied pressure
  - Exposure (e.g. leaving the cell outside or in a hot, humid environment)
  - Water leakageFailure to observe the above handling precautions may cause the battery to explode, ignite or emit gases that are harmful to the human body. If the battery emits gases, avoid inhaling the gas, and immediately ventilate the surrounding area.
-  Do not disassemble nor remodel this product. Illegal remodeling not only results in a fire according to the Regulations, but also can result in fire, electrocution or malfunction.

## ⚠ WARNING

When connecting the DC power cord, be sure the positive (+) and negative (-) polarities are correct. Connecting the cord with the polarities set backwards can result in igniting, electric shock, or equipment failures.

The equipment will become very hot if it is used for an extended period of time. Be careful not to allow children or other adults in the area to touch the equipment. Touching the equipment can burn the skin. The equipment should be installed in an area with good ventilation.

Using the product while it is emitting smoke, emitting a strange odor, or otherwise functioning abnormally can result in fire or electric shock. In the event of such problems, immediately turn the power OFF and be sure to remove the power plug from the electric outlet. Next, contact your dealer. Do not ever attempt to fix the product yourself.

If you hear thunder, turn the power switch OFF and remove the charger plug from the AC outlet as a safety precaution. Doing so can result in electric shock.

Never touch the equipment or its Charger plug with wet hands. Doing so can result in electric shock.



## ⚠ CAUTION

Do not install the product in locations such as those listed below. Doing so can result in fire or electric shock, or cause the product to fail.

- Locations which are exposed to direct sunlight, in the path of heaters, or otherwise exposed to hot air
- Locations with poor ventilation
- Locations which are subject to large amounts of moisture or dust
- Locations in the vicinity of objects which could change in shape or ignite if heated
- Locations in the vicinity of flower vases or other objects containing water
- Unstable locations

Do not open the product case. Opening the case can result in injury or electric shock, or damage the equipment. Also, may invalidate the equipment guarantee.

Do not sit on the product or place anything on top of it. Doing so may cause the product to fall or be knocked over, resulting in injury or damaging the equipment.

Do not drop or bang the product. Doing so can result in injury or damage the equipment.

Do not touch areas of the equipment which are not described in this manual. In particular, do not touch the interior of the equipment. Doing so can cause the equipment to fail.

Do not use headphones when using the product for a long time. Doing so can impair hearing.



## ⚠ CAUTION

⚠ Do not install the product near televisions, radios, or computers. Doing so can cause radio frequency interference in the product or nearby electronic devices.

⚠ As a safety precaution, turn the power OFF and remove the charger plug from its outlet before cleaning the exterior of the product. Wipe off dust, etc. with a dry towel. If the exterior is extremely dirty, use a neutral detergent soaked in water. Never use paint thinner, benzene, or alcohol. Doing so can cause the equipment to fail.

⚠ Be sure to hold the power cord or connector cable by its plug when inserting or removing it. Failure to do so can result in electric shock, or cause a short circuit and start a fire.

⚠ Ground terminals should be as thick as possible and installed securely. Wire runs should be as short as possible. Never connect a ground terminal to a gas pipe, wire conduit, etc. Doing so can result in explosion or electric shock in the event of a failure or electric leak.



## Table of contents

1. Introduction .....	1	6.2.3 Frequency selection.....	10
2. Features.....	1	6.2.4 Communication .....	11
3. Standard Composition/Accessories.....	1	6.3 Operation Guide.....	12
3.1 Standard Composition.....	1		
3.2 Options .....	1		
4. Specifications .....	1		
4.1 Specifications .....	1		
4.1.1 General.....	1		
4.1.2 Transmitter .....	2		
4.1.3 Receiver .....	2		
4.2 Abbreviations.....	2		
5. Installation.....	3		
5.1 Installing the Accessories.....	3		
5.2 Battery Charging .....	4		
5.3 Cigarette DC Adapter(CFQ-6132) .....	5		
6. OPERATION.....	6		
6.1 PANEL LAYOUT .....	6		
6.2 Operating the JHP-500/520 .....	8		
6.2.1 POWER ON/OFF and Audio LEVEL control .....	8		
6.2.2 Squelch (SQL) LEVEL control .....	9		

- 1. Introduction**  
 JHP-500 is a VHF Air Band Transceiver with Weather Channel reception.  
 JHP-520 is a VHF Air Band Transceiver with Weather Channel reception, VOR reception and VOR display.
- 2. Features**
- The frequency can be quick selected using the keypad or the channel selector.
  - 100 channels memory location with the frequency and the character.
  - VOR mode allows the angle of approach of the aircraft to be displayed on the LCD.

**3. Standard Composition / Accessories**

3.1 Standard Composition

Items	Model No.	Qty	Remarks
Transceiver	JHP-500/520	1	
Antenna	NAV-151	1	
Wall charger	NBB-484	1	700mAh
NI-Cd battery	NBB-487	1	
Belt clip		1	
Hand strap		1	
Protective case		1	
Headset adapter		1	
Instruction Manual		1	English

3.2 Options

Items	Model No.	Remarks
Cigarette DC Adapter	CFO-6132	12VDC Input
NI-Cd battery	NBB-487	700mAh
NI-MH battery	NBB-479	1,200mAh
Desktop charger (Rapid)	NBB-486	
Alkaline battery pack		
Speaker Mic	NVT-145	9pcs

**4. Specifications**

4.1 Specifications

4.1.1 General

Frequency range

- NAV band 108.000~117.975MHz
- COM band 118.000~136.975MHz
- Weather Channel (10CH)
- WX01 162.550MHz, WX02 162.400MHz
- WX03 162.475MHz, WX04 161.650MHz
- WX05 162.425MHz, WX06 162.450MHz
- WX07 162.500MHz, WX08 161.525MHz
- WX09 161.775MHz, WX10 163.275MHz
- 12V±10%

Operating Voltage

- Input Current
- Transmitting: approx. 1A
- Receiving: approx. 250mA
- Standby: approx. 60mA

Antenna impedance

- Frequency stability
- Tuning step
- Memory channels
- Mode

- typ. 50Ω
- ±10ppm
- 25kHz
- 100
- AM (6K00A3E), FM (11K0F3E)

Operating temperature -10°C to +55°C  
Dimensions 65 (width) x 155 (height) x 38 (depth) mm  
(Include Ni-cd battery)  
Weight approx. 450g (Include Ni-cd battery)

FROM

FROM\* is displayed if the aircraft is on a course away from the VOR Station (in VOR or CDI operation).

4.1.2 Transmitter  
Output power 5W (PEP)

4.1.3 Receiver  
Sensitivity 2.0µ V for 20dB  
Selectivity 6dB: 12kHz or more  
70dB: 25kHz or less

Intermediate Frequencies  
First IF : 21.7MHz  
Second IF: 450kHz  
AF output power 0.5W/8Ω

4.2 Abbreviations

VOR VHF Omni Range :  
The standard short-range navigation support system.  
This system allows for determining the bearing of the VOR station in flight of the aircraft.

CDI Code Deviation Indicator.  
By selecting CDI mode, you can display the deviation between the station and the aircraft.

VOR TO TO\* is displayed if the aircraft is on a course towards the VOR Station (in VOR or CDI operation).



## 5. Installation

### 5.1 Installing the Accessories

- Antenna (NAV-151)

Rotate the antenna clockwise until it stops.

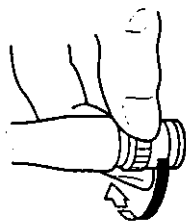
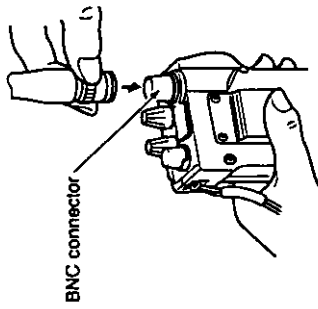

- Battery (NBB-487)

Hold up the battery release lever and attach the battery pack.

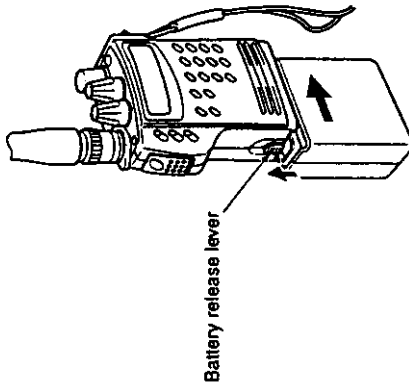



### 5.2 Battery Charging

• General notes for charging the battery:

1. Do not charge at ambient temperature below 0°C or above +40°C.
2. Do not operate JHP-500/520 while charging the battery.

• Charging use the battery charger NBB-484.

Connect the NBB-484 to JHP-500/520's charger plug.

Charging time : approx. 10 hours.

(Note : Do not exceed a charging time of 15 hours.)

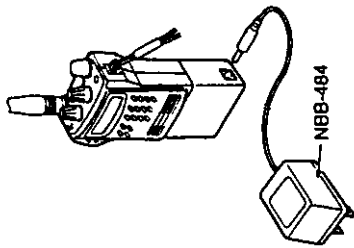

• Charging use the Desktop charger NBB-486.  
Insert JHP-500/520 to NBB-486's charger holder.  
Charging time : approx. 2 hours.

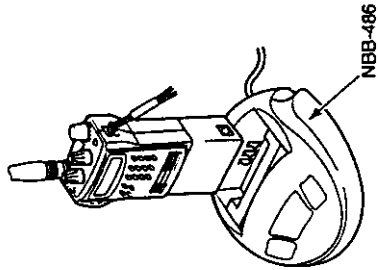

5.3 Cigarette DC Adapter (CFO-6132)

1. Change to the CFO-6132A from the NBB-487.

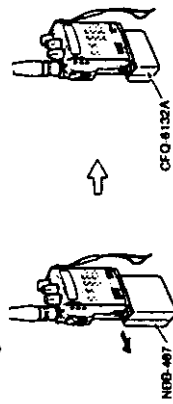

2. Connect the DC CABLE (CFO-6132B) to the CFO-6132A' DC jack and cigarette jack.  
attention: Only 12VDC input.

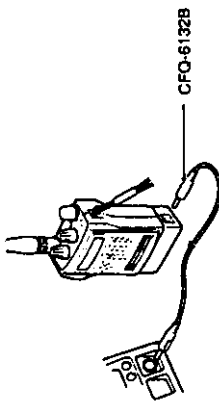

3. DC jack.

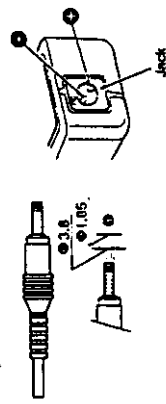

**6. OPERATION**  
**6.1 PANEL LAYOUT**  
**JHP-500**

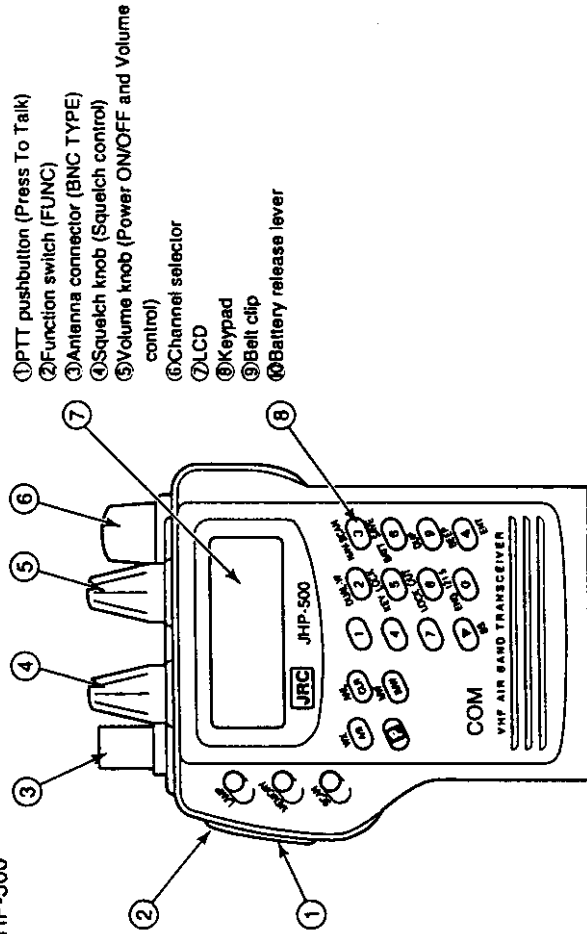

- ① PTT pushbutton (Press To Talk)
- ② Function switch (FUNC)
- ③ Antenna connector (BNC TYPE)
- ④ Squelch knob (Squelch control)
- ⑤ Volume knob (Power ON/OFF and Volume control)
- ⑥ Channel selector
- ⑦ LCD
- ⑧ Keypad
- ⑨ Belt clip
- ⑩ Battery release lever

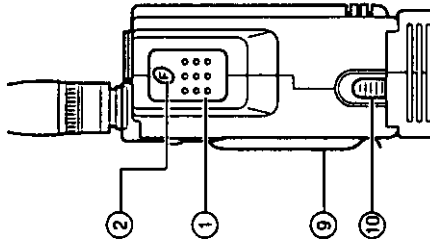



JHP-520

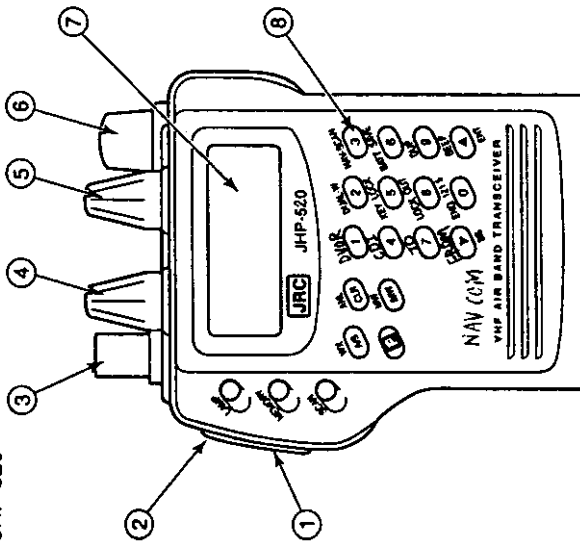

- ① PTT pushbutton (Press To Talk)
- ② Function switch (FUNC)
- ③ Antenna connector (BNC TYPE)
- ④ Squelch knob (Squelch control)
- ⑤ Volume knob (Power ON/OFF and Volume control)
- ⑥ Channel selector
- ⑦ LCD
- ⑧ Keypad
- ⑨ Belt clip
- ⑩ Battery release lever

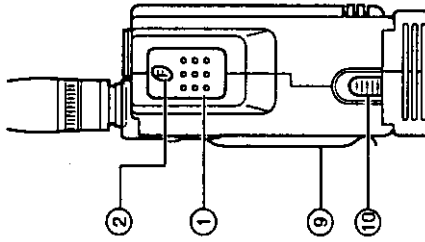

6.2 Operating the JHP-500/520  
6.2.1 POWER ON/OFF and Audio LEVEL control

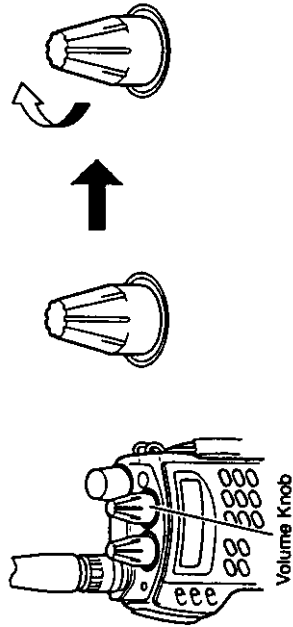

- Power ON  
Turn the volume knob clockwise.
- Power OFF  
Turn the volume knob counterclockwise.
- Audio level control  
Turn the volume knob clockwise or counterclockwise.  
Clockwise: Increase audio level.  
Counterclockwise: Decrease audio level.

### 6.2.2 Squelch (SQL) LEVEL control

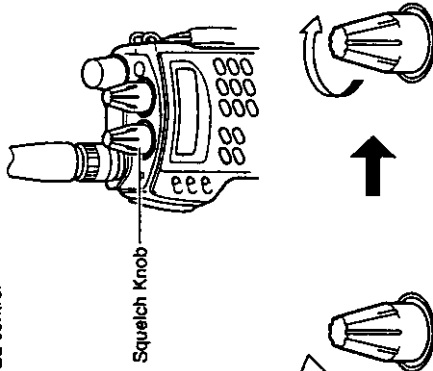

Control the squelch knob to eliminate noise in no-signal state. The further this squelch knob is turned to the right, the deeper squelch level becomes.



### 6.2.3 Frequency selection

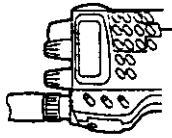

10Keys

1.Setting the frequency by the 10 keys.



Channel Selector

2.Setting the frequency by the channel selector.

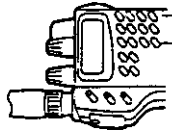

UP/DOWN Keys

3.Setting the frequency by the UP/DOWN keys.



## 6.2.4 Communication

### 1. Receive

- Set the frequency.
- The noise can be heard from speaker when the squelch is opened.
- Release the PTT switch.

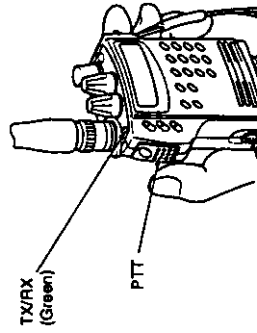

### 2. Transmit

- Set the COM band frequency, then press the PTT switch to transmit.
- The PTT switch is inoperative at frequency outside the COM band. (~118.000 ~136.975MHz)

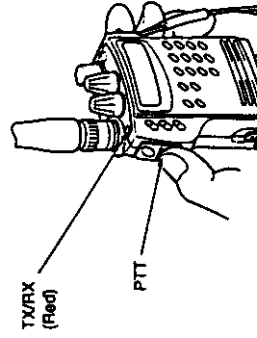



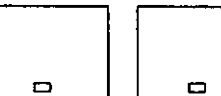

### 6.3 Operation Guide

1. Power on.
2. Basic functions.
3. First & Second key Functions.
4. Memory Functions.
5. Duplex operation.
6. Scanning function.
7. DVOR indicator (This function have only the JHP-520).

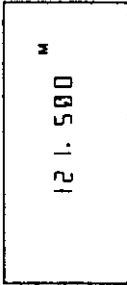
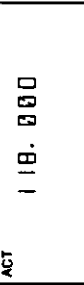
Item	Operation	LCD	Notes:
1. Power on. 1.1 Power on.	Turn the volume knob clockwise.		All indicators on the display turn on for about 2 seconds.  Then the last set data is displayed.
1.2 Power off.	Turn the volume knob counter clockwise.		No indicator on the display and power off.

Item	Operation	LCD	Notes:
2. Basic functions. 2.1 Emergency frequency. 2.1.1 Setting.	Press <b>[E]</b> <b>[0]</b> .		The emergency frequency is displayed. If the emergency frequency is selected, the keylock function is cancelled.
2.1.2 Clearing.	Press <b>[CLR]</b> .		The previously set frequency is displayed.
2.2 Frequency selection by ten keys. 2.2.1 Setting the active frequency.	Press <b>[0]</b> to <b>[9]</b> to set a frequency. Example) To set 118.275MHz : (1) Press <b>[1]</b> .		"1" is displayed. If an invalid frequency is set, the error tone sounds and the previously set frequency is displayed.

Item	Operation	LCD	Notes:
	② Press [1], [8], [2] subsequently.	ACT 118.2	The LCD displays the pressed keys.
	③ Press [7]. The last digit is automatically set.	ACT 118.275	The decimal point is displayed when the frequency setting is complete.
		ACT 118.000	If the digit before last is invalid, the error tone sounds and the previously set frequency is redisplayed. If you attempt to set an invalid frequency, the error tone sounds and the previously set frequency is redisplayed.
	If you enter two or more digits and then press [ENT]. Example) Press [1], [2], [ENT]. * You can set a frequency in the range 108.000 to 136.975MHz.	ACT 120.000	If invalid, the error tone sounds and the previously set frequency is redisplayed.













Item	Operation	LCD	Notes:
2.2.2 Clearing the active frequency setting.	Press <b>[CLR]</b>	<div style="border: 1px solid black; padding: 5px; text-align: center;">           ACT             </div>	
2.2.3 Correcting a digit when entering a frequency.	Press <b>[BS]</b> while entering a frequency.	<div style="border: 1px solid black; padding: 5px; text-align: center;">           ACT   18. 000         </div>	The previously set frequency is displayed.
		<div style="border: 1px solid black; padding: 5px; text-align: center;">           ACT   18 8         </div>	The last entered digit is cleared and a new value can be entered. Pressing <b>[BS]</b> after entering only one digit has the same effect as pressing <b>[CLR]</b> .
		<div style="border: 1px solid black; padding: 5px; text-align: center;">           ACT   18         </div>	

Item	Operation	LCD	Notes:
2.2.4 Setting a frequency using the UP/DOWN keys.	Starting from the last frequency setting press  or .	<div style="border: 1px solid black; padding: 5px; text-align: center;">           ACT            118.025         </div>	Pressing  increases the frequency by one step. Pressing  reduces the frequency by one step. The frequency steps can be set independently for COM and NAV bands.
	Press and hold  or .	<div style="border: 1px solid black; padding: 5px; text-align: center;">           ACT            118.050         </div>	Press and hold  or  for approx. 1 second for fast scanning.
	Press and hold  or .	<div style="border: 1px solid black; padding: 5px; text-align: center;">           ACT            127.275         </div>	Press and hold  or  for approx. 2 seconds for fast scanning at the frequency step x 4.

Item	Operation	LCD	Notes:
2.2.5 Setting active frequency using the channel selector.	Turn the channel selector clockwise to increase frequency. Turn the channel selector counter-clockwise to reduce frequency.	<div style="border: 1px solid black; padding: 5px; width: fit-content; margin: auto;">           ACT            118.000         </div>	Operating the keys alternates between active and standby frequency and displays the newly set active frequency. The error tone sounds and Active/Standby frequency is not switched under memory mode.
2.2.6 Active or standby frequency selection.	Press <b>[ACT]</b> . Example) Changing between an active frequency of 118.000 MHz and a standby frequency of 127.275 MHz.	<div style="border: 1px solid black; padding: 5px; width: fit-content; margin: auto;">           ACT            127.275         </div>	Standby frequency is last active frequency (COM/NAV/WX).
2.3 Setting the weather channel.	Press <b>[F]</b> , <b>[WS]</b> .	<div style="border: 1px solid black; padding: 5px; width: fit-content; margin: auto;">           WX-02         </div>	The previously set weather channel is displayed and "ANL" turns off.
2.3.1 Setting the weather channel using the 10 keys.			





Item	Operation	LCD	Notes:
	Press <b>[0]</b> to <b>[9]</b> to set the weather channel.	WX - <b>[0]</b>	If you enter 0 or 1 on first digit, data indicator starts blinking.
	Press <b>[ENT]</b> after entering first digit.	WX - 10	If you enter 2 to 9 on first digit, weather channel is selected.
2.3.2 Clearing the weather channel setting.	Press <b>[CLR]</b> or <b>[BS]</b> .	WX - <b>[0]</b> 1	The weather channel is set.
		WX - <b>[0]</b> 2	The previously set weather channel is displayed.

Item	Operation	LCD	Notes:
<p>2.3.3 Setting a weather channel using the UP/DOWN keys.</p>	<p>Starting from the last channel setting press  or .</p> <p>Press and hold  or .</p> <ul style="list-style-type: none"> <li>• If you press  at the highest channel, the lowest channel is selected.</li> <li>• If you press  at the lowest channel, the highest channel is selected.</li> </ul>	<div style="border: 1px solid black; padding: 5px; text-align: center;">WX - 0 1</div> <div style="border: 1px solid black; padding: 5px; text-align: center;">WX - 0 1</div>	<p>Pressing  increases the channel by one step. Pressing  reduces the channel by one step.</p> <p>Press and hold  or  for approx. 1 second for fast scanning.</p>
<p>2.3.4 Setting a weather channel using the channel selector.</p>	<p>Turn the channel selector clockwise or counterclockwise.</p>		
<p>2.3.5 Clearing the weather channel setting.</p>	<p>Press  or .</p>	<div style="border: 1px solid black; padding: 5px; text-align: center;">ACT 118.000</div>	<p>The previous set channel is displayed.</p>

Item	Operation	LCD	Notes:
2.3.6 Setting/ Clearing LOCK OUT of weather channel.	Press [F], [B]	<div style="border: 1px solid black; padding: 5px; text-align: center;">           LOCKOUT            WX - 01         </div>	"LOCKOUT" displays. Press [F], [B] again. "LOCKOUT" turns off.
2.3.6 Weather channel display.	Enter weather channel in case frequency is displayed under memory mode.	<div style="border: 1px solid black; padding: 5px; text-align: center;">           WX - 01         </div>	"WX-01" is displayed.
	Set weather channel in case character is displayed under memory mode.	<div style="border: 1px solid black; padding: 5px; text-align: center;">           162.550 01         </div>	Frequency and channel number are displayed.
2.4 Receive.	Turn the squelch knob clockwise to set the frequency.	<div style="border: 1px solid black; padding: 5px; text-align: center;">           ACT            118.025         </div>	The noise can be heard from speaker.

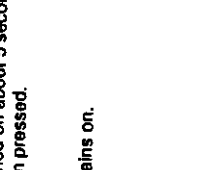
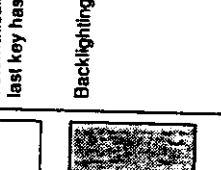
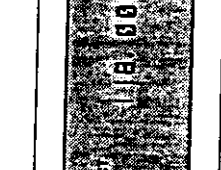
Item	Operation	LCD	Notes:
2.5 Transmit.	Adjust squelch knob.	ACT 118.025	The noise can not be heard from speaker.
	Set a frequency in the COM band, then press the PTT switch to transmit.	ACT 118.025	LED is lighted red.
	Release the PTT switch to return to reception mode.	ACT 118.025	Return to receive. <i>rn</i>
	The PTT switch is inoperative when a frequency outside the COM band is selected (e.g.: 162.550 MHz).	ACT 162.550 01	Transmit operation is not possible.

Item	Operation	LCD	Notes:
2.6 Backlighting ON /OFF.	<p>Press the <b>[LAMP]</b> to turn backlighting on momentarily.</p> <p>Press <b>[F]</b>, <b>[LAMP]</b> to turn backlighting on continuously.</p> <p>Press <b>[LAMP]</b> and <b>[F]</b>, <b>[LAMP]</b> to turn backlighting off.</p>	   	<p>The LCD backlighting turns on.</p> <p>The backlighting automatically turns off after about 5 seconds if no key is pressed. If keys are operated, the backlighting is automatically turned off about 5 seconds after the last key has been pressed.</p> <p>Backlighting remains on.</p> <p>Backlighting turns off.</p>

Item	Operation	LCD	Notes:
3. First & Second Key Functions. 3.1 First Function overview.	Press <b>[F]</b> and the following keys to select the first function : JHP-500 2 :Selects Dual Watch mode 3 :Starts NAV band scanning 5 :Selects KEYLOCK on/off 6 :Selects Battery save mode 8 :Selects LOCKOUT on/off 9 :Duplex operation on/off 0 :Sets the emergency frequency. ▲ :Turns the key tone on/off. A/S :Receives weather band CLR :Turns the noise limiter on/off IMW :Writes data to memory LAMP :Becklighting turns on continuously	<div style="border: 1px solid black; padding: 5px; width: fit-content; margin: auto;"> <p>F</p> <p>ACT</p> <p>    B . 0 0 0</p> </div>	Pressing <b>[F]</b> displays the indicator "F" on the LCD and selects the first function. Pressing <b>[F]</b> again cancels the first function. The first function is also cancelled if no other keys are operated within 3 seconds.

Item	Operation	LCD	Notes:
3.1.3 Starting NAV band scanning.	See (Item 6.7) NAV scan function.		The keylock symbol is displayed. All keys expect the function switch, the light switch and the PTT switch become inoperative.
3.1.4 CDI mode selection. (JHP-520 only)	See (Item 7.2) CDI function.		The keylock symbol extinguishes and the keylock function is cancelled. You can also press [F] and [CLR] to cancel the keylock.
3.1.5 KEYLOCK ON/OFF.	Press [F] and [S] subsequently.		The "SAVE" indicator turns on and the battery save mode turns on.
3.1.6 Battery save mode.	Press [F] and [G].		

Item	Operation	LCD	Notes:
3.1.7 To mode. (JHP-520 only)	Press <b>F</b> and <b>G</b> again.	ACT 1 18. 0 0 0	The "SAVE" indicator turns off and the battery save mode turns off.
3.1.8 LOCKOUT ON/OFF.	See (Item7.1) DVOR function.		
3.1.9 Duplex operation mode.	See (Item4.5.3) memory function and (Item2.3.6) setting the weather channel.		
3.1.10 Setting the emergency frequency.	See (Item5) duplex operation.		
3.1.11 Receives weather band.	See (Item2.1) setting the emergency frequency.		
	See (Item2.3) setting the weather channel.		



Item	Operation	LCD	Notes:
3.1.12 Key tone ON/OFF.	Press [F] and [▲].	ACT 1 18. 000	On : Press [F], then [▲] Off : Press [F] and [▲] once again.
3.1.13 FROM mode. (JHP-520 only)	See (Item 7.1) DVOR function.		
3.1.14 Continuous backlighting ON.	See (Item 2.6) backlight function.		
3.1.15 Noise limiter ON/OFF.	Press [F], then [CLR].	ACT ANL 1 18. 025	The "ANL" indicator turns on and the automatic noise limiter turns on.
	Press [F], then [CLR] again.	ACT 1 18. 025	The "ANL" indicator turns off and the automatic noise limiter turns off.

Item	Operation	LCD	Notes:
3.1.16 Storing data in memory.	See (Item4) the memory function "Storing Data in Memory".		
3.2 Second function overview.	Press and hold [F] for at least 2 seconds, then press the following keys to select their second functions : <ul style="list-style-type: none"> <li>1 :Selects battery</li> <li>2 :Sets COM frequency steps</li> <li>3 :Sets NAV frequency steps</li> <li>4 :Selects memory scanning</li> <li>5 :Selects TX power</li> </ul> SCAN :PAUSE in Scan operation ON/OFF	<p>The LCD display shows the letter 'F' followed by 'ACT' on the top line, and '1 18. 0 0 0' on the bottom line.</p>	"F" blinks on the display. The second function is set. Pressing [F] again deactivates the second key operation. The second function is also cancelled if no other keys are pressed within 3 seconds.

Item	Operation	LCD	Notes:
3.2.1 Selects battery.	Press and hold [E] for at least 2 seconds, then press [1].	<div style="border: 1px solid black; padding: 5px; margin-bottom: 10px;">           Primary battery                        </div> <div style="border: 1px solid black; padding: 5px; margin-bottom: 10px;">           Secondary battery              2         </div> <div style="border: 1px solid black; padding: 5px; margin-bottom: 10px;">                       </div> <div style="border: 1px solid black; padding: 5px;">           ACT   1 B. 0 0 0         </div>	<p>The currently selected battery is displayed. If no key is pressed, the previously set frequency is displayed after about 5 seconds</p> <p>Press [▼] to select the battery type Press [ENT] to set.</p> <p>If no key is operated within about 5 seconds or if [CLR] is pressed, the previous display is restored.</p>

Item	Operation	LCD	Notes:
3.2.2 Setting the COM band frequency step.	Press and hold <b>[E]</b> for at least 2 seconds, then press <b>[2]</b> .  Selects step use <b>[▼]</b> or channel selector.  Press <b>[ENT]</b> .	<div style="border: 1px solid black; padding: 5px; text-align: center;">2 25</div> <div style="border: 1px solid black; padding: 5px; text-align: center;">2 50</div> <div style="border: 1px solid black; padding: 5px; text-align: center;">2 25</div> <div style="border: 1px solid black; padding: 5px; text-align: center;">ACT 118.000</div>	The currently selected data is displayed. If no key is pressed within 5 seconds, the previous display is restored.  To change the frequency step each time, <b>[▼]</b> is pressed or turn channel selector. Available steps are 10, 20, 25, 50 and 100kHz. Channel selector : Clockwise : 10→20→25→50→100 Counterclockwise : 10←20←25←50←100 Pressing <b>[ENT]</b> stores the selected step. The previous display is restored.  If <b>[CLR]</b> is pressed or no key is operated within 5 seconds, the previous display is restored.



Item	Operation	LCD	Notes:
3.2.3 Setting the NAV band frequency step.	<p>Press and hold <b>[F]</b> for at least 2 seconds, then press <b>[3]</b>.</p> <p>Selects step use <b>[▼]</b> or channel selector.</p> <p>Press <b>[ENT]</b>.</p>	<div style="border: 1px solid black; padding: 5px; text-align: center;">3 25</div> <div style="border: 1px solid black; padding: 5px; text-align: center;">3 50</div> <div style="border: 1px solid black; padding: 5px; text-align: center;">3 100</div> <div style="border: 1px solid black; padding: 5px; text-align: center;">ACT 118.000</div>	<p>The currently selected data is displayed. If no other keys are operated within 5 seconds, the previous display is restored.</p> <p>To change the frequency step each time, <b>[▼]</b> is pressed or turn channel selector. Available steps are 10, 20, 25, 50 and 100kHz. Channel selector : Clockwise : 10→20→25→50→100 Counterclockwise : 10→20←25←50←100</p> <p>Pressing <b>[ENT]</b> stores the selected step. The previous display is restored.</p> <p>If <b>[CLR]</b> is pressed or no key is operated within 5 seconds, the previous display is restored.</p>

<p>Item</p> <p>3.2.4 Memory scanning selection.</p>	<p>Operation</p> <p>Press and hold <b>[F]</b> for at least 2 seconds then press <b>[4]</b>.</p> <p>Use <b>[▼]</b> or channel selector to select the scanning method. Press <b>[ENT]</b> to store the selected method.</p>	<p>LCD</p> <div style="border: 1px solid black; padding: 5px; margin-bottom: 5px; text-align: center;">4 RLL</div> <div style="border: 1px solid black; padding: 5px; margin-bottom: 5px; text-align: center;">4 GRP</div> <div style="border: 1px solid black; padding: 5px; margin-bottom: 5px; text-align: center;">4 RLL</div> <div style="border: 1px solid black; padding: 5px; margin-bottom: 5px; text-align: center;">ACT 118.000</div>	<p>Notes:</p> <p>Operating the keys displays the currently selected status.</p> <p>ALL means : Scanning of all memory locations. Group means : Scanning within a group of ten. Example : Memory location No. 23 is selected. The memory locations No. 20 to 29 are scanned. If no key is pressed within 5 seconds, the previous display is restored.</p> <p>Press <b>[▼]</b> or turn channel selector to select the scanning methods : scanning of all memory locations (ALL) or of individual memory groups. Pressing <b>[ENT]</b> stores the selected step. The previous display is restored.</p> <p>If no key is pressed within 5 seconds or <b>[CLR]</b> is pressed, the previous display is restored.</p>
---	---	--	--

Item	Operation	LCD	Notes:
3.2.5 Selects TX power.	Press and hold <b>[F]</b> for at least 2 seconds then press <b>[5]</b> .	<div style="border: 1px solid black; padding: 5px;">           ACT            1 18. 000         </div>	"LOW" is displayed and select low power.
3.2.6 PAUSE in scans operation ON/OFF.	Press and hold <b>[F]</b> for at least 2 seconds then press <b>[5]</b> again.	<div style="border: 1px solid black; padding: 5px;">           ACT            1 18. 000         </div>	"LOW" is bunched and select high power.
	Press and hold <b>[F]</b> for at least 2 seconds then press <b>[SCAN]</b> .	<div style="border: 1px solid black; padding: 5px;">           P    0 N         </div>	Operating the key displays the currently selected status. If no other keys are operated within 5 seconds, the previous display is restored.

Item	Operation	LCD	Notes:
	Use <input type="button" value="▼"/> or channel selector to set ON/OFF. Press <input type="button" value="ENT"/> to store the selected method.	<div style="border: 1px solid black; padding: 5px; text-align: center;">P D F F</div> <div style="border: 1px solid black; padding: 5px; margin-top: 10px;">ACT 1 18. 0 0 0</div>	Use <input type="button" value="▼"/> or channel selector to set ON/OFF. Press <input type="button" value="ENT"/> to store the selected method.  If no key is pressed within 5 seconds or <input type="button" value="CLR"/> is pressed, the previous display is restored.

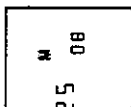





Item	Operation	LCD	Notes:
4. Memory function. 4.1 Instant memory write.	Press <b>[IMW]</b> .		"M" blinks on the display. The smallest unregistered memory number is displayed and registered. "WX-01" is displayed under Weather channel mode.
4.2 Storing data in memory.	Press <b>[F]</b> and <b>[IMW]</b> .		Previous status is returned after the display is held for 0.5 seconds after pressing <b>[IMW]</b> . Weather channel frequency and number are displayed under weather channel mode.
4.2.1 Entering the channel number using the 10 keys.	Press <b>[0]</b> to <b>[9]</b> to enter the number of the memory location. Example) Storing data in channel No.12 ① Press <b>[1]</b> ② Press <b>[2]</b>		"M" blinks on the display. The previous set memory number and frequency are displayed.
			The entered data is displayed. Entering a second digit displays the memory number and the currently set frequency.

Item	Operation	LCD	Notes:
4.2.2 Changing the Memory Numbers.	Enter one digit, then press [BS] and [CLR].	<div style="border: 1px solid black; padding: 5px; text-align: center;">           M            118.025 09         </div>	Operating the key restores the display. Then the memory channel number can be entered. The previously stored data is displayed.
4.2.3 Using	Press <input type="button" value="▼"/> or turn channel selector to select memory channel number.	<div style="border: 1px solid black; padding: 5px; text-align: center;">           M            118.075 10         </div>	Pressing <input type="button" value="▼"/> or turning channel selector clockwise the memory number by one.
	Press and hold <input type="button" value="▼"/> .	<div style="border: 1px solid black; padding: 5px; text-align: center;">           M            118.175 11         </div>	Pressing <input type="button" value="▼"/> scans rapidly through the memory numbers. (The memory No. is increased by "1" each 100ms).
4.2.4 Store frequency.	Press <input type="button" value="ENT"/> .	<div style="border: 1px solid black; padding: 5px; text-align: center;">           M            118.000 53         </div>	Pressing <input type="button" value="ENT"/> stores the frequency in the displayed memory channel. "WX-01" is displayed under weather channel mode.

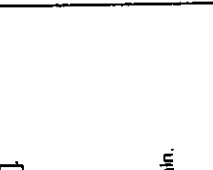
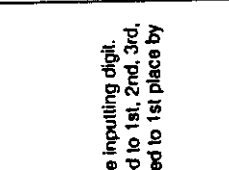
Item	Operation	LCD	Notes:
4.2.5 Input character.	Press ten keys to input character. The maximum four characters are available. Example) Input "AFKP". ① Press <b>[1]</b>		After pressing <b>[ENT]</b> , the data is displayed for about 0.5 seconds and inputting character is available. (First digit blinks on the display.)
4.2.6 Correct one (1) character.	② Then, Press <b>[2]</b> <b>[3]</b> <b>[4]</b>		"A" blinks on the display.
			"AFKP" is displayed.

Item	Operation	Notes:
<p>4.2.7 Characters and keys.</p>	<p>Press <b>[BS]</b> while input character.</p> <p>You can input following characters, total 48 kinds.            Characters and keys are as follows.</p> <p>1: A, B, C, D, E            2: F, G, H, I, J            3: K, L, M, N, O            4: P, Q, R, S, T            5: U, V, W, X, Y            6: Z, -, /, ., ' (space)            7: 0, 1, 2, 3, 4            8: 5, 6, 7, 8, 9            9: (, ), ., !, =, d            0: P, I, l</p>	<p>The character on the cursor is deleted and you can input the correct one.</p>
	<p>LCD</p> <div style="border: 1px solid black; padding: 5px; width: fit-content; margin: 0 auto;"> <p>R M</p> <p>5 3</p> </div>	

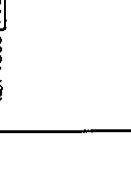
Item	Operation	LCD	Notes:
	<p>Example) Press <b>[1]</b></p>		<p>"A" blinks on the display</p>
4.2.8 Movement of inputting digit.	<p>Then, press <b>[1]</b> again.</p> <p>Press <b>[AS]</b> to move inputting digit. The cursor is moved to 1st, 2nd, 3rd, 4th digit and returned to 1st place by pressing <b>[AS]</b>.</p> <p>Example) Input 1st Place "A" 2nd Place "B" ( ) Press <b>[1]</b></p>		<p>"B" blinks on the display. "C", "D", "E" is changed pressing <b>[1]</b>, and returned to "A".</p>
			<p>"A" blinks on the display.</p>

Item	Operation	LCD	Notes:
4.2.9 Input character turning channel selector.	<p>① Press <b>[M/S]</b></p> <p>② Press <b>[1]</b> twice.</p> <p>Turn "channel selector" clockwise.</p>	<div style="border: 1px solid black; padding: 5px; margin-bottom: 5px;">  </div> <div style="border: 1px solid black; padding: 5px; margin-bottom: 5px;">  </div> <div style="border: 1px solid black; padding: 5px; margin-bottom: 5px;">  </div> <div style="border: 1px solid black; padding: 5px;">  </div>	<p>The cursor is moved to 2nd digit . 2nd digit blinks.</p> <p>"B" is displayed.</p> <p>"A" blinks on the display. In case channel selector is turned counter clockwise, "B" blinks. In case channel selector is counterclockwise again, "A" blinks. Namely, in case channel selector is turned clockwise, next character indicates.</p>

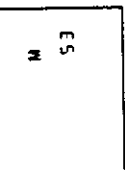
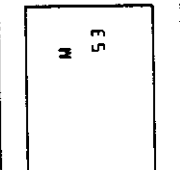
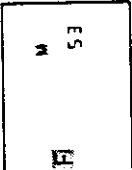
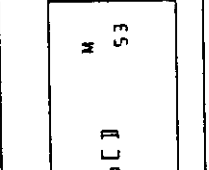
Item	Operation	LCD	Notes:
	Press <b>[1]</b>		"A" blinks on the display
	Turn "channel selector" clockwise.		"B" blinks on the display.
	Press <b>[2]</b>		"F" blinks at 2nd digit.
4.2.10 Storing character.	Press <b>[ENT]</b>		Pressing <b>[ENT]</b> stores the character in the displayed memory number.

Item	Operation	LCD	Notes:
<p>4.2.11 Cancelling writing data into memory.</p>	<p>Press <b>[F]</b>, <b>[INW]</b> or press <b>[CLR]</b>.</p>	<p>ACT 118.000</p>	<p>After pressing <b>[ENT]</b>, the data is displayed for about 0.5 seconds. The previously set memory number is displayed.</p>
<p>4.3 Memory operation.</p>	<ul style="list-style-type: none"> <li>• Max 100 memories are available.</li> <li>• The frequency of COMNAV and weather channel No. are available.</li> <li>• At duplex mode, both active and standby frequency can be registered.</li> </ul> <p>Press <b>[MEMORY]</b>.</p>	<p>ACT 118.000</p>	<p>The previously set frequency is displayed.</p>
		<p>ACT 118.025 M 00</p>	<p>"M" blinks and the last set memory number or instant memory number is displayed.</p>



Item	Operation	LCD	Notes:
4.3.1 Selecting a memory channel using the 10 key.	<p>Press <b>[0]</b> to <b>[9]</b> to enter the memory channel number.</p> <p>Example) Retrieving the contents of memory channel no. 12.</p> <p>① Press <b>[1]</b></p> <p>② Press <b>[2]</b></p>	<p>ACT 1 1 8 . 0 2 5 M 雜</p>	<p>After you entered the first digit, the memory number indicator starts blinking.</p>
4.3.2 Changing the selected memory number.	<p>Enter one digit, then press <b>[CLR]</b> or <b>[BS]</b></p>	<p>ACT 1 1 8 . 9 7 5 M 12</p>	<p>After you entered the second digit, the selected memory is completely displayed.</p> <p>If you enter the unmemorized number, . . . . . is displayed on the LCD.</p>
4.3.3 Selecting a memory channel using <b>[▲]</b> and <b>[▼]</b>	<p>Press <b>[▲]</b> or <b>[▼]</b> or turn channel selector to select a memory channel.</p>	<p>ACT 1 1 8 . 0 2 5 M 00</p>	<p>Operating the keys restores the status prior to entering the memory number.</p> <p>The memory number can then be entered once again. The selected memory is displayed.</p>
		<p>ACT 1 1 8 . 2 2 5 M 09</p>	<p>Operating the keys displays the data of the next channel.</p>

Item	Operation	LCD	Notes:
	Press and hold <b>▲</b> or <b>▼</b>	<div style="border: 1px solid black; padding: 5px;">           ACT 118.500 M 10         </div>	Pressing and holding the keys for more than 1 second scans the channels rapidly (100ms per channel). During last scanning the contents of the scanned channels are displayed on the LCD. Free memory locations are skipped.
4.3.4 Switching indicator.	Press <b>IMW</b>	<div style="border: 1px solid black; padding: 5px;">           ACT NR T M 10         </div>	Frequency / Character on the display is switched.
	Press <b>IMW</b> again.	<div style="border: 1px solid black; padding: 5px;">           ACT 118.500 M 10         </div>	
4.3.5 Quitting memory operation.	Press <b>CLR</b> or <b>MEMORY</b> to quit.	<div style="border: 1px solid black; padding: 5px;">           ACT 119.000         </div>	The previously set frequency is displayed.

Item	Operation	LCD	Notes:
4.4 Deleting a memory channel.	Select the memory channel to be deleted.	ACT 118.500 M ID	Operating the keys displays the frequency as . . . . .
4.5 Correct character in memory.	Press and hold <b>[F]</b> for at least 2 seconds, and then, press and hold <b>[CLR]</b> for 1 second.	ACT - - - - - M ID	
4.5.1 Correcting character.	Set memory number which you would like to correct character.	ACT N R T M ID	
	Press and hold <b>[F]</b> for at least 2 seconds, and press <b>[INV]</b> .	ACT N R T M ID	The first digit blinks. Key operation is the same as memory operation.

Item	Operation	LCD	Notes:
4.5.2 Clearing to correct character.	Press <b>[CLR]</b> .	<div style="border: 1px solid black; padding: 5px; width: fit-content;">           ACT    M                  NR T    10         </div>	The previously set character is displayed.
4.6 Setting / Clearing LOCK OUT in Memory Operation.	Press <b>[F]</b> and <b>[B]</b> . * The channel which sets LOCK OUT can not be scanned.	<div style="border: 1px solid black; padding: 5px; width: fit-content;">           LOCKOUT            ACT    M                  1 18. 500 10         </div>	"LOCK OUT" is displayed. Press <b>[F]</b> and <b>[B]</b> again to clear LOCK OUT.
4.7 Memory duplex.	Press memory number which stored duplex.	<div style="border: 1px solid black; padding: 5px; width: fit-content;">           ACT    M            DUP    1 18. 000 20         </div>	
4.7.1 Confirming standby frequency.	Press <b>[AVS]</b> .	<div style="border: 1px solid black; padding: 5px; width: fit-content;">           STBY    M            DUP    1 19. 500 20         </div>	"STBY" blinks and the standby frequency is displayed on the LCD.



Item	Operation	LCD	Notes:
4.7.1 Clear confirming standby frequency.	Press <b>[CLR]</b>	<div style="border: 1px solid black; padding: 5px; display: inline-block;"> <p>ACT 118.000 M DUP 20</p> </div> <div style="border: 1px solid black; padding: 5px; display: inline-block;"> <p>ACT 118.000 M DUP 20</p> </div>	<p>The current status is displayed. If no key is pressed within 3 seconds, the previous settings are displayed.</p> <p>The previous settings are displayed.</p>

Item	Operation	LCD	Notes:
5. Duplex operation 5.1 Duplex operation on.	Press [F], then [9].	<div style="border: 1px solid black; padding: 5px; text-align: center;">             ACT              127.275              DUP           </div>	"DUP" is displayed. In duplex operation the standby frequency to the COM band.
	Press and hold the PTT switch.	<div style="border: 1px solid black; padding: 5px; text-align: center;">             STBY              118.275              DUP           </div>	Standby frequency is displayed. In case active frequency is NAV band, "DVOR" is turned off. (JHP-520 only)
	Release the PTT switch.	<div style="border: 1px solid black; padding: 5px; text-align: center;">             ACT              127.275              DUP           </div>	Active frequency is displayed. In case active frequency is NAV band, "DVOR" is displayed. (JHP-520 only)
5.2 Frequency setting.	Active frequency can be set in duplex operation.		

Item	Operation	LCD	Notes:
5.3 Duplex operation OFF.	Press <b>[F]</b> , then <b>[9]</b> .	<div style="border: 1px solid black; padding: 5px; text-align: center;">           ACT 127.275         </div>	The "DUP" indicator turns off.
5.4 Confirming standby frequency.	Press <b>[MS]</b> .	<div style="border: 1px solid black; padding: 5px; text-align: center;">           STBY DUP 118.275         </div>	"STBY" blinks and the standby frequency is displayed on the LCD.
5.5 Clear confirming standby frequency.	Press <b>[CLR]</b> .	<div style="border: 1px solid black; padding: 5px; text-align: center;">           ACT DUP 118.000         </div>	The current status is displayed. If no key is pressed within 3 seconds, the previous settings are displayed.
	Press <b>[CLR]</b> .	<div style="border: 1px solid black; padding: 5px; text-align: center;">           ACT DUP 118.000         </div>	The previous settings are displayed.

Item	Operation	LCD	Notes:
<p>6. Scanning function. 6.1 Starting scanning.</p>	<p>Press <b>[SCAN]</b> or <b>[F]</b>, then <b>[2]</b> or <b>[3]</b>.</p>	<p>ACT   18. 000 SCAN</p>	<p>The scan indicator is displayed and scanning is started. Press <b>[SCAN]</b> to scan COM / NAV / MEMORY / WX. Press <b>[F]</b>, then <b>[2]</b> to scan at Dual watch mode. Press <b>[F]</b>, then <b>[3]</b> to scan NAV band. When a signal is detected, signal and frequency is displayed.</p>
	<p>While scanning, turn channel selector. Turning clockwise is the same as pressing <b>[▲]</b>. Turning counterclockwise is the same as pressing <b>[▼]</b>.</p>	<p>ACT   18. 000 SCAN</p>	<p>Pressing <b>[▲]</b> changes the scanning direction from low to high. Pressing <b>[▼]</b> changes the scanning direction from high to low.</p>
	<p>Press <b>[CLR]</b> or <b>[PTT]</b>.</p>	<p>ACT   18. 000</p>	<p>Pressing <b>[CLR]</b> turns off the "SCAN" and stops scanning. The active frequency is the frequency of the channel selected when scanning stops. Press <b>[PTT]</b> to transmit at the frequency when scanning stops if it is COM band.</p>

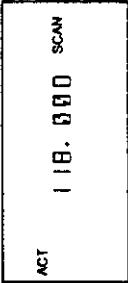

Item	Operation	LCD	Notes:
6.2 Scanning methods. 6.2.1 Busy scan.			"SCAN" is displayed. When a signal is detected, scanning stops, but resumes within approx. 3 seconds after a signal is not detected.
6.2.2 Pause scan.			"SCAN" blinks. When a signal is detected, scanning stops, but resumes after approx. 5 seconds even if the signal continues to be received.
6.2.3 Selecting scanning.	See 2nd function. (Item 3.2.4)		
6.2.4 Starting scanning channel.	In case COM / Memory / WX / NAV		Start scanning from the next channel or frequency. Start → Channel 5 → Channel 6 → Channel 7 → Channel 8
	In case Dual watch mode		In case 5th channel set, the scan starts from 6th channel.  Standby frequency and active frequency are scanned by turns.

Item	Operation	LCD	Notes:
6.3 Scanning the COM band.	Select the COM band, then start scanning.	<div style="border: 1px solid black; padding: 5px;">           ACT            118.275 SCAN         </div>	Pressing <b>[F]</b> and <b>[▲]</b> starts scanning upward from the frequency one step higher than the active frequency. The same applies to the downward direction. Scanning is performed between 118.000 MHz and 136.990 MHz.
6.4 Scanning the memory. 6.4.1 All channels.	Select memory operation, then start scanning.	<div style="border: 1px solid black; padding: 5px;">           ACT            118.000 SCAN            05         </div>	The channels 01 to 99 are scanned. The memory number except LOCKOUT is set, is scanned upward from the memory number. In case the character is not stored, the frequency is displayed.
6.4.2 Channel groups.	Select memory operation, select the group to be scanned (select one channel number from the desired group of ten), then start scanning.	<div style="border: 1px solid black; padding: 5px;">           ACT            118.000 SCAN            23         </div>	The corresponding memory channels are scanned. The memory number except LOCKOUT is set, is scanned upward from the memory number. In case the character is not stored, the frequency is displayed.
6.5 Scanning the weather channel.	Select weather channel, then start scanning.	<div style="border: 1px solid black; padding: 5px;">           WX - 02 SCAN         </div>	The channels 01 to 10 are scanned. The memory number except LOCKOUT is set, is scanned upward from the memory number.

Item	Operation	LCD	Notes:
6.6 Dual watch. (DW)		<div style="border: 1px solid black; padding: 5px; width: fit-content;">           STBY            118.000            SCAN         </div>	<p>The standby frequency and the active frequency are scanned by turns. (500ms)</p> <p>While scanning active frequency, "ACT" is displayed.</p> <p>While scanning standby frequency, "STBY" is displayed.</p> <ul style="list-style-type: none"> <li>In case set the dualwatch, the memory operation is cancelled.</li> <li>After the scanning is finished, the active frequency is displayed.</li> </ul>
6.7 Scanning the NAV band.	Select the NAV band, then start scanning.	<div style="border: 1px solid black; padding: 5px; width: fit-content;">           ACT            108.000            DVOR            SCAN         </div> <p>(Above display for JHP-520)</p>	<p>Pressing [F] and [▲] starts scanning upward from the frequency one step higher than the active frequency. The same applies to the downward direction.</p> <p>Scanning is performed between 108.000 MHz and 117.990 MHz.</p>

Item	Operation	LCD	Notes:
7. DVOR indicator. (JHP-520 only) 7.1 DVOR function. 7.1.1 Bearing display.	Enter the frequency of the VOR station. (NAV band)		The DVOR indicator and the angle relative to 0° North are displayed. "FROM" is displayed the VOR station bearing in relation to the aircraft is not within ±90° of the target course. "TO" is displayed the VOR station bearing in relation to the aircraft is not within ±90° of the target course.
	Press [F] and [7] or [E] and [▼] while bearing display.		If the distance to the VOR station is too large or if the frequency is not correct, " --- " is displayed. (Neither "TO" nor "FROM" is indicated)
			Switching to "TO" using [F] and [7] Switching to "FROM" using [E] and [▼]

Item	Operation	LCD	Notes:
7.2 CDI function. 7.2.1 Course display.	Enter the frequency of the target VOR station (NAV band).	<div style="border: 1px solid black; padding: 5px;"> <p>ACT 108.000 DVOR TO 050'</p> </div>	Operating the keys displays the CDI indicator instead of VOR.
	Press <b>[F]</b> , then <b>[4]</b> .	<div style="border: 1px solid black; padding: 5px;"> <p>ACT 108.000 CDI TO 050'</p> </div>	Operating the keys displays the CDI indicator instead of VOR. The DVOR bearing is displayed. To change the frequency quit CDI mode using <b>[F]</b> and <b>[1]</b> .
		<div style="border: 1px solid black; padding: 5px;"> <p>ACT 108.000 CDI OFF</p> </div>	If the distance to the VOR station is too large or if the set frequency is not correct, "OFF" is displayed. (Neither "To" nor "FROM" is displayed)

Item	Operation	LCD	Notes:
7.2.2 Entering the target course. (1) Numerical entry of three digits.	Press the corresponding keys <b>0</b> to <b>9</b> to enter the target course. Example) Setting 123° ① Press <b>1</b> ② Press <b>2</b> , then <b>3</b>	<div style="border: 1px solid black; padding: 5px; margin-bottom: 5px;">             ACT 100.000              CDX TO                          </div> <div style="border: 1px solid black; padding: 5px; margin-bottom: 5px;">             ACT 100.000              CDX TO              123°           </div> <div style="border: 1px solid black; padding: 5px;">             ACT 100.000              CDX TO              050°           </div>	The entered data is displayed.  The target bearing is completely entered. "TO" or "FROM" and the course deviation indicator are turned on.  If you enter an angle outside the range from 0° to 359° the error tone sounds and the previously set course is displayed.

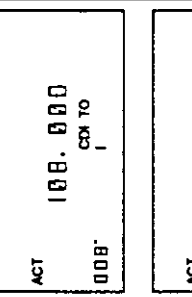
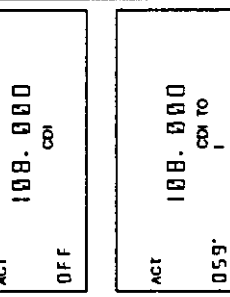
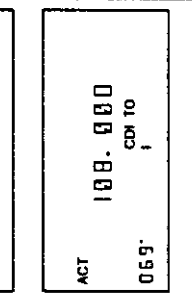
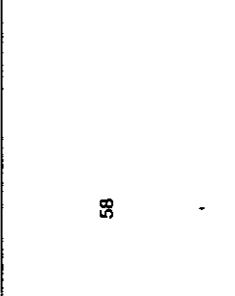
Item	Operation	LCD	Notes:
	Enter one or two digits, then press <b>ENT</b> .		The course is displayed with a "0" at the beginning.
	Set the course using <b>▲</b> or <b>▼</b> .		In case "OFF" is displayed on the angle bearing, "OFF" is displayed if the desired course or the previously set course is displayed for 0.5 second.
(2) Setting the course using <b>▲</b> and <b>▼</b> .	Set the course using <b>▲</b> or <b>▼</b> .		Press <b>▲</b> to change the angle by 1° (up). Press <b>▼</b> to change the angle by 1° (down). "To" or "FROM" and the course deviation indicator are turned on.
	Press and hold <b>▲</b> or <b>▼</b> for more than 1 second.		For fast counting press and hold the keys for some seconds; quick change of the angle displays.

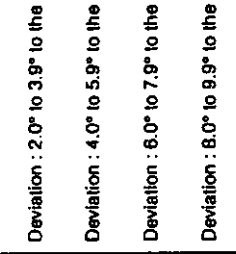
Item	Operation	LCD	Notes:
7.2.3 Course Deviation Indicator.	Select CDI mode.		In CDI mode, the deviation (between target and actual course) is displayed in the bottom part of the LCD. If "OFF" is displayed, no deviation is displayed.
		0.50°	Deviation : up to 1.9° to the left or to the right.
		0.50°	Deviation : 2.0° to 3.9° to the right.
		0.50°	Deviation : 4.0° to 5.9° to the right.
		0.50°	Deviation : 6.0° to 7.9° to the right.
		0.50°	Deviation : 8.0° to 9.9° to the right.
		0.50°	Deviation : 10.0° to 11.9° to the right.
		0.50°	Deviation : more than 12° to the right.
		0.50°	Deviation : 2.0° to 3.9° to the left.
		0.50°	Deviation : 4.0° to 5.9° to the left.



Item	Operation	LCD	Notes:
		050° AII	Deviation : 6.0° to 7.9° to the left.
		050° AIII	Deviation : 10.0° to 11.9° to the left.
		050° AIIII	Deviation : 8.0° to 9.9° to the left.
		050° AIIIIII	Deviation : more than 12° to the left.

<p>Item</p> <p>7.2.4 "TO" and "FROM" Indication.</p>	<p>Operation</p> <p>Select CDI mode.</p>	<p>LCD</p> <div data-bbox="698 661 909 829" style="border: 1px solid black; padding: 5px;"> <p>ACT 100.000 CDI TO ▲ 050°</p> </div> <div data-bbox="698 861 909 1029" style="border: 1px solid black; padding: 5px;"> <p>ACT 100.000 CDI ▲ FROM 050°</p> </div>	<p>Notes:</p> <p>"To" is displayed if the VOR station bearing in relation to the aircraft is within <math>\pm 90^\circ</math> of the target course.</p> <p>"FROM" if the VOR station bearing in relation to the aircraft is not within <math>\pm 90^\circ</math> of the target course.</p> <p>Example) Entered course = 058°</p> <div data-bbox="925 945 1096 1228"> </div> <div data-bbox="925 1260 1096 1533"> </div>
--	--	---	---

Item	Operation	LCD	Notes:
7.2.5 Automatic Bearing Setting System function.	Select CDI mode.  If "To" is displayed, press <b>[F]</b> , then <b>[7]</b> . If "FROM" is displayed, press <b>[F]</b> , then <b>[v]</b> .	<div style="border: 1px solid black; padding: 5px; margin-bottom: 5px;">             ACT      100.000                        CDI TO                        ▲           </div> <div style="border: 1px solid black; padding: 5px;">             ACT      050°                        CDI TO                        ▲           </div>	Operating the keys sets a new target course considering the current course and the deviation. New target course = current course ± deviation.