



**FCC CFR47 PART 15 SUBPART E
CERTIFICATION**

TEST REPORT

FOR

802.11a/b/g COMBO MINI PCI MODULE

MODEL NUMBER: PA3297U-1MPC

BRAND NAME: TOSHIBA

FCC ID: CJ6UPA3297WL

REPORT NUMBER: 03U1876-1

ISSUE DATE: JUNE 05, 2003

Prepared for

**TOSHIBA CORPORATION DIGITAL MEDIA NETWORK COMPANY
2-9 SUEHIRO-CHO, OME
TOKYO, 198-8710
JAPAN**

Prepared by

**COMPLIANCE CERTIFICATION SERVICES
561F MONTEREY ROAD,
MORGAN HILL, CA 95037, USA
TEL: (408) 463-0885
FAX: (408) 463-0888**

TABLE OF CONTENTS

1. TEST RESULT CERTIFICATION	3
2. EUT DESCRIPTION	4
3. TEST METHODOLOGY	5
4. FACILITIES AND ACCREDITATION	5
4.1. <i>FACILITIES AND EQUIPMENT</i>	<i>5</i>
4.2. <i>TABLE OF ACCREDITATIONS AND LISTINGS</i>	<i>6</i>
5. CALIBRATION AND UNCERTAINTY	7
5.1. <i>MEASURING INSTRUMENT CALIBRATION</i>	<i>7</i>
5.2. <i>MEASUREMENT UNCERTAINTY</i>	<i>7</i>
5.3. <i>TEST AND MEASUREMENT EQUIPMENT</i>	<i>8</i>
6. SETUP OF EQUIPMENT UNDER TEST	9
7. APPLICABLE LIMITS AND TEST RESULTS	11
7.1. <i>EMISSION BANDWIDTH</i>	<i>11</i>
7.2. <i>PEAK POWER</i>	<i>18</i>
7.3. <i>MAXIMUM PERMISSIBLE EXPOSURE</i>	<i>26</i>
7.4. <i>AVERAGE POWER</i>	<i>28</i>
7.5. <i>PEAK POWER SPECTRAL DENSITY</i>	<i>29</i>
7.6. <i>PEAK EXCURSION</i>	<i>37</i>
7.7. <i>TRANSMISSION IN THE ABSENCE OF DATA</i>	<i>44</i>
7.8. <i>TYPE OF ANTENNA</i>	<i>44</i>
7.9. <i>FREQUENCY STABILITY</i>	<i>44</i>
7.10. <i>CONDUCTED UNDESIRABLE EMISSIONS</i>	<i>45</i>
7.11. <i>RADIATED EMISSION</i>	<i>52</i>
7.12. <i>CO-LOCATED RADIATED EMISSIONS</i>	<i>66</i>
7.13. <i>POWERLINE CONDUCTED EMISSIONS</i>	<i>80</i>
8. SETUP PHOTOS	84

1. TEST RESULT CERTIFICATION

COMPANY NAME: TOSHIBA CORPORATION DIGITAL MEDIA NETWORK COMPANY
2-9 SUEHIRO-CHO, OME
TOKYO, 198-8710
JAPAN

EUT DESCRIPTION: 802.11a/b/g COMBO MINI PCI MODULE

MODEL: PA3297U-1MPC

DATE TESTED: APRIL 30 – MAY 23, 2003

APPLICABLE STANDARDS	
STANDARD	TEST RESULTS
FCC PART 15 SUBPART E	NO NON-COMPLIANCE NOTED

Compliance Certification Services, Inc. tested the above equipment in accordance with the requirements set forth in the above standards. The test results show that the equipment tested is capable of demonstrating compliance with the requirements as documented in this report.

Note: This document reports conditions under which testing was conducted and results of tests performed. This document may not be altered or revised in any way unless done so by Compliance Certification Services and all revisions are duly noted in the revisions section. Any alteration of this document not carried out by Compliance Certification Services will constitute fraud and shall nullify the document.

Note: The 5.2 GHz band is applicable to this report. Other bands of operation (2.4 and 5.8GHz) are documented in a separate report.

Approved & Released For CCS By:

Tested By:

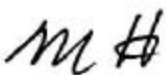

MIKE HECKROTTE
CHIEF ENGINEER
COMPLIANCE CERTIFICATION SERVICES

VIEN TRAN
EMC ENGINEER
COMPLIANCE CERTIFICATION SERVICES

2. EUT DESCRIPTION

The EUT is an 802.11 a/b/g transceiver module. The EUT has a output power of 22.63 dBm (183mW) and highest antenna gain of 4.8 dBi in the 2400 - 2483.5 MHz band.

The EUT has an output power of 21.2 dBm (132 mW) and highest antenna gain of 4.8 dBi in the 5725 - 5850 MHz band.

Optionally the WLAN may be collocated with a Bluetooth transceiver, FCC ID: CJ6UPA3232BT.

Antennas filed under this report:

Hitachi Cable, Dual Band Film antenna, model: HTL008, antenna gain 4.8dBi;

Hitachi Cable, Wide band film antenna, model: HTL008, antenna gain 4.1 dBi;

Tyco Electronics AMP, Dual band film antenna, TIAN01, antenna gain 1.0dBi.

3. TEST METHODOLOGY

The tests documented in this report were performed in accordance with ANSI C63.4:1992, FCC CFR 47 Part 2 and FCC CFR 47 Part 15.







4. FACILITIES AND ACCREDITATION

4.1. FACILITIES AND EQUIPMENT

The open area test sites and conducted measurement facilities used to collect the radiated data are located at 561F Monterey Road, Morgan Hill, California, USA. The sites are constructed in conformance with the requirements of ANSI C63.7, ANSI C63.4 and CISPR Publication 22.

All receiving equipment conforms to CISPR Publication 16-1, "Radio Interference Measuring Apparatus and Measurement Methods."

4.2. TABLE OF ACCREDITATIONS AND LISTINGS

Country	Agency	Scope of Accreditation	Logo
USA	FCC	3/10 meter Open Area Test Sites to perform FCC Part 15/18 measurements	 1300
Japan	VCCI	CISPR 22 Two OATS and one conducted Site	 R-1014, R-619, C-640
Norway	NEMKO	EN50081-1, EN50081-2, EN50082-1, EN50082-2, IEC61000-6-1, IEC61000-6-2, EN50083-2, EN50091-2, EN50130-4, EN55011, EN55013, EN55014-1, EN55104, EN55015, EN61547, EN55022, EN55024, EN61000-3-2, EN61000-3-3, EN60945, EN61326-1	 ELA 117
Norway	NEMKO	EN60601-1-2 and IEC 60601-1-2, the Collateral Standards for Electro-Medical Products. MDD, 93/42/EEC, AIMD 90/385/EEC	 ELA-171
Taiwan	BSMI	CNS 13438	 SL2-IN-E-1012
Canada	Industry Canada	RSS210 Low Power Transmitter and Receiver	 IC2324 A,B,C, and F

5. CALIBRATION AND UNCERTAINTY

5.1. MEASURING INSTRUMENT CALIBRATION

The measurement instruments utilized to perform the tests documented in this report have been calibrated in accordance with the manufacturer's recommendations, and are traceable to national standards.

5.2. MEASUREMENT UNCERTAINTY

Where relevant, the following measurement uncertainty levels have been estimated for tests performed on the apparatus:

Radiated Emission, 30 to 200 MHz	+/- 3.3 dB
Radiated Emission, 200 to 1000 MHz	+4.5 / -2.9 dB
Radiated Emission, 1000 to 2000 MHz	+4.5 / -2.9 dB
Power Line Conducted Emission	+/- 2.9 dB

Uncertainty figures are valid to a confidence level of 95%.

5.3. TEST AND MEASUREMENT EQUIPMENT

The following test and measurement equipment was utilized for the tests documented in this report:

TEST EQUIPMENT LIST				
Name of Equipment	Manufacturer	Model No.	Serial No.	Due Date
SA RF Section, 22 GHz	HP	85660B	2140A01296	5/23/2003
Quasi-Peak Adaptor	HP	85650A	2811A01335	5/23/2003
SA Display Section 1	HP	85662A	3026A19146	5/23/2003
LISN, 10 kHz ~ 30 MHz	FCC	50/250-25-2	114	9/6/2003
Line Filter	Lindgren	LMF-3489	497	CNR
LISN, 10 kHz ~ 30 MHz	Solar	8012-50-R-24-BNC	837990	9/6/2003
EMI Test Receiver	R & S	ESHS 20	827129/006	4/17/2004
Preamplifier, 1 ~ 26.5 GHz	HP	8449B	3008A00369	6/30/2003
Antenna, Horn 1 ~ 18 GHz	EMCO	3115	2238	2/4/2004
PSA Spectrum Analyzer	Agilent	E4446A	424446A	1/13/2004
EMI Receiver, 9 kHz ~ 2.9 GHz	HP	8542E	3942A00286	11/20/2003
RF Filter Section	HP	85420E	3705A00256	11/20/2003
BILOG ANTENNA	A.R.A	LPB-2520/A	1185	6/24/2003
Antenna, Horn 1 ~ 18 GHz	A.R.A	MWH-1826	1049	11/7/2003
Power Meter	HP	E4416A	GB4129116	C.N.R

6. SETUP OF EQUIPMENT UNDER TEST

SETUP INFORMATION FOR TESTS

SUPPORT EQUIPMENT

PERIPHERAL SUPPORT EQUIPMENT LIST				
Device Type	Manufacturer	Model	Serial Number	FCC ID
Laptop	Toshiba	PP2002-00002	321029675	CJ6PA3171WL
AC Adapter	Toshiba	PA3241U-1ACA	0211A00164506	N/A

I/O CABLES

Cable No.	Port	# of Identical Ports	Connector Type	Cable Type	Cable Length	Remarks
1	DC	1	DC PWR	Unshielded	1.86 m	N/A
2	AC	1	AC PWR	Unshielded	1.86 m	N/A

TEST SETUP

The EUT is installed on extender card of laptop

SETUP DIAGRAM FOR TESTS

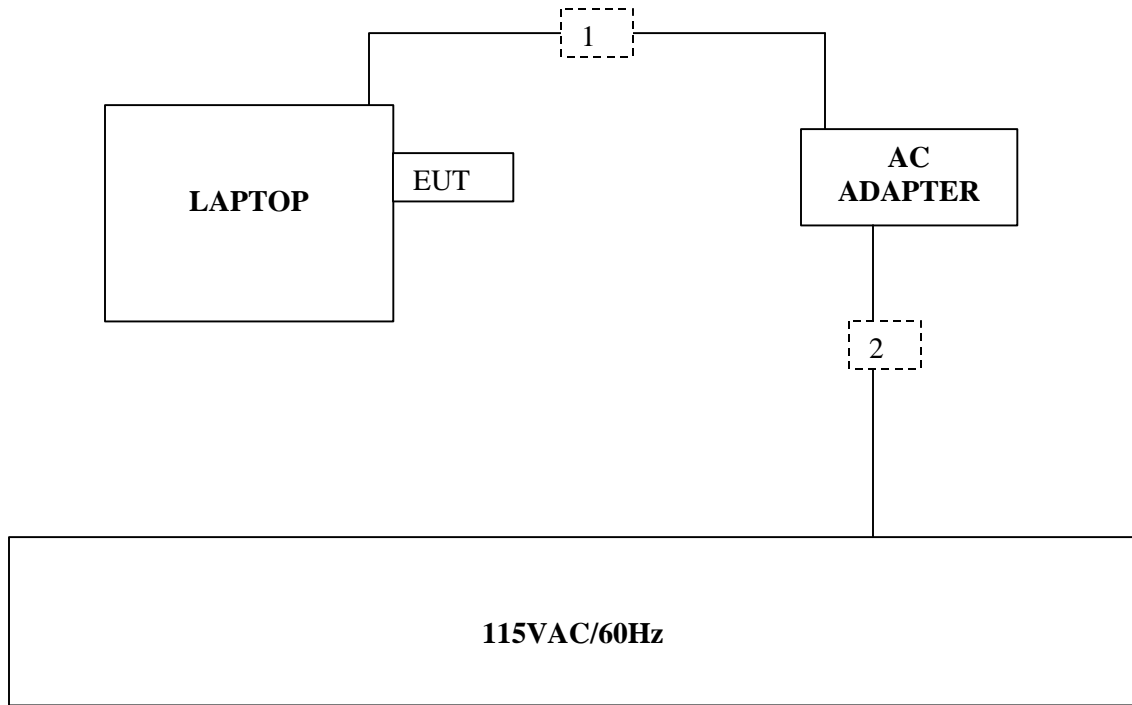

7. APPLICABLE LIMITS AND TEST RESULTS

7.1. EMISSION BANDWIDTH

LIMIT

§15.403 (c) Emission bandwidth. For purposes of this subpart the emission bandwidth shall be determined by measuring the width of the signal between two points, one below the carrier center frequency and one above the carrier center frequency, that are 26 dB down relative to the maximum level of the modulated carrier. Determination of the emissions bandwidth is based on the use of measurement instrumentation employing a peak detector function with an instrument resolutions bandwidth approximately equal to 1.0 percent of the emission bandwidth of the device under measurement.

TEST PROCEDURE

The transmitter output is connected to a spectrum analyzer. The RBW is set to 1% to 3% of the 26 dB bandwidth. The VBW is set to 3 times the RBW. The sweep time is coupled.

RESULTS

No non-compliance noted:

802.11a Normal Mode

Channel	Frequency (MHz)	B (MHz)	10 Log B (dB)
Low	5180	25.591	14.08087257
Middle	5260	26.647	14.25648322
High	5320	23.933	13.78997141

802.11a Turbo Mode

Channel	Frequency (MHz)	B (MHz)	10 Log B (dB)
Low	5210	52.246	17.18053046
Mid	5250	55.288	17.4263088
High	5290	47.172	16.7368429

EMISSION BANDWIDTH (BASE MODE)

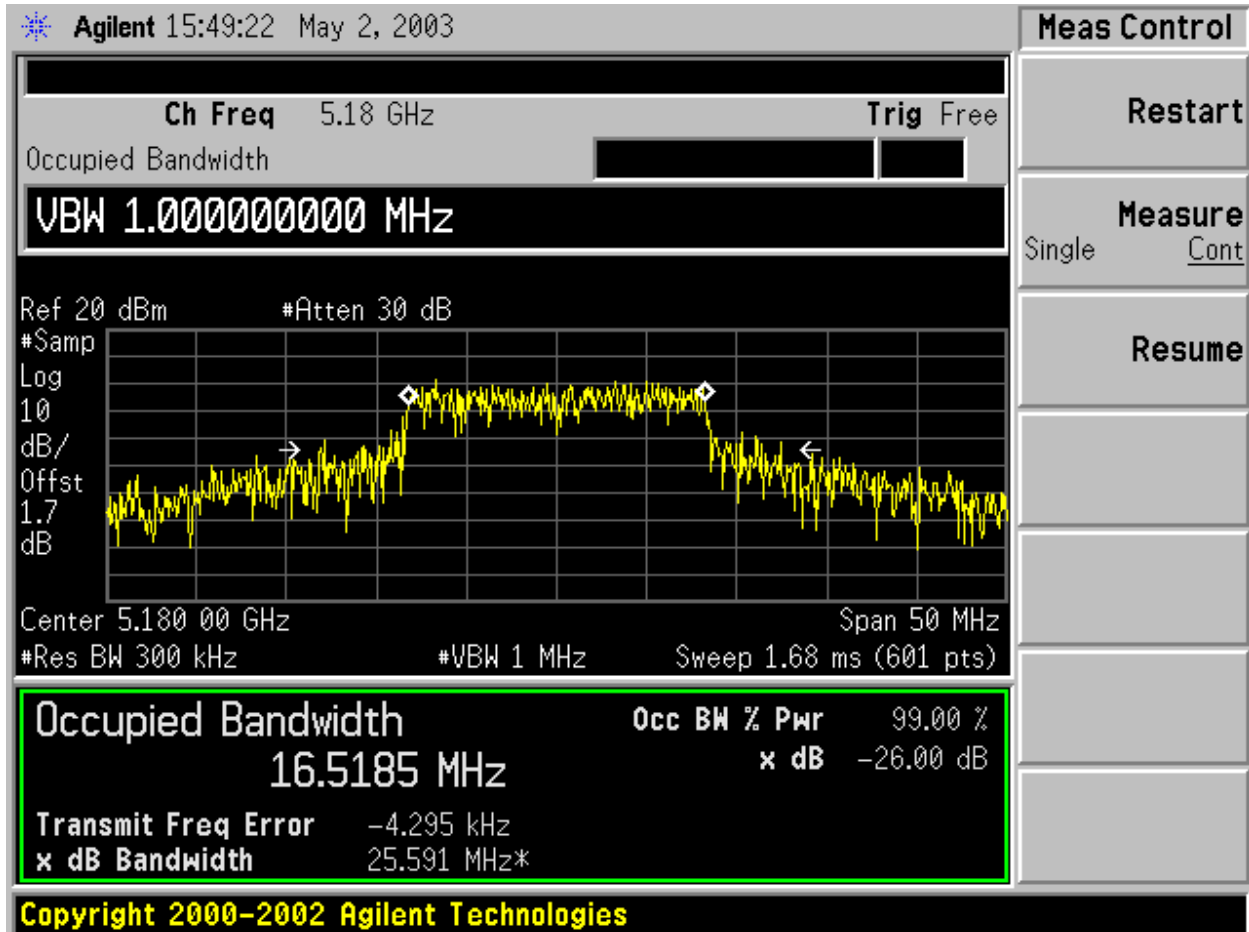

LOW CHANNEL NORMAL

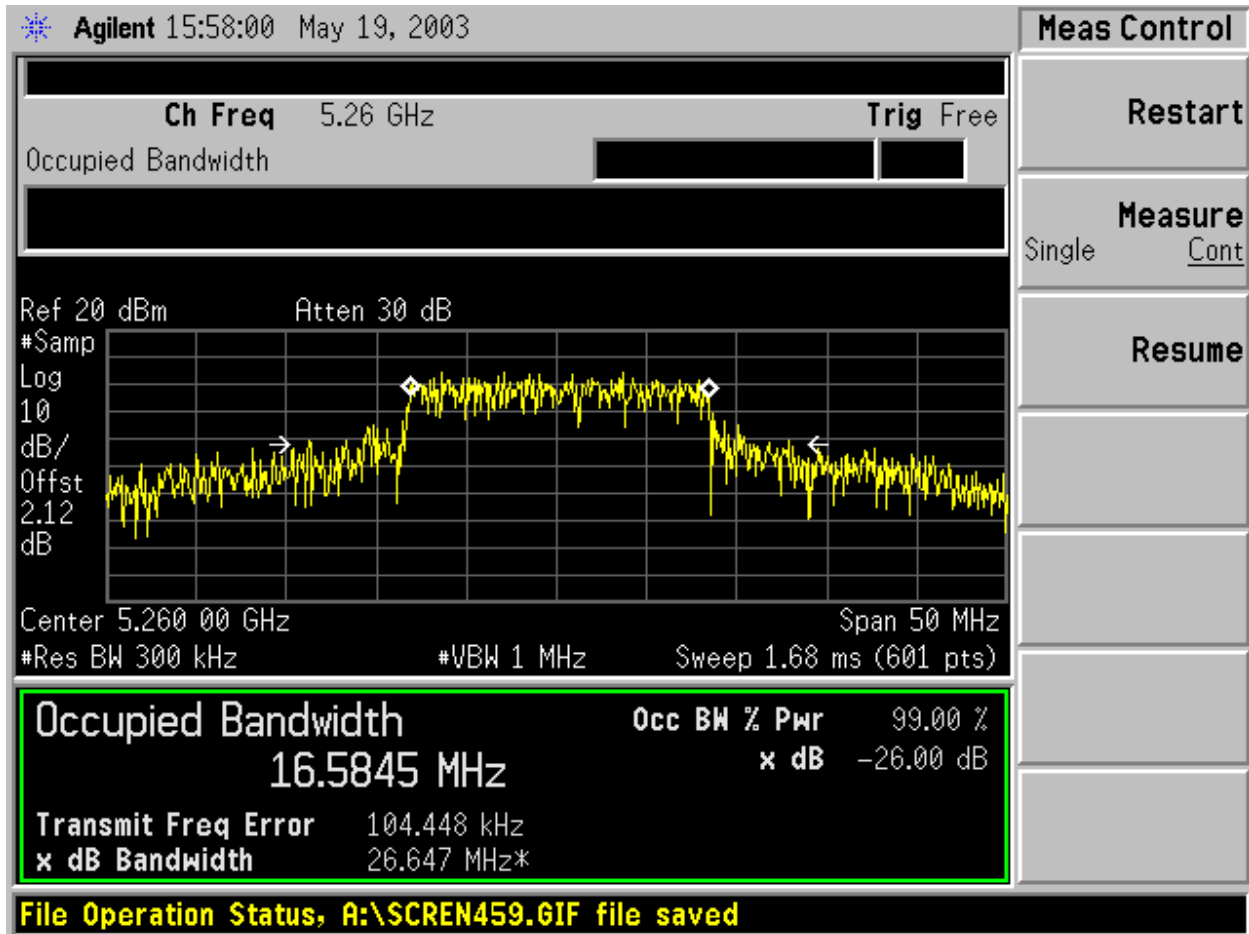

MID CHANNEL NORMAL

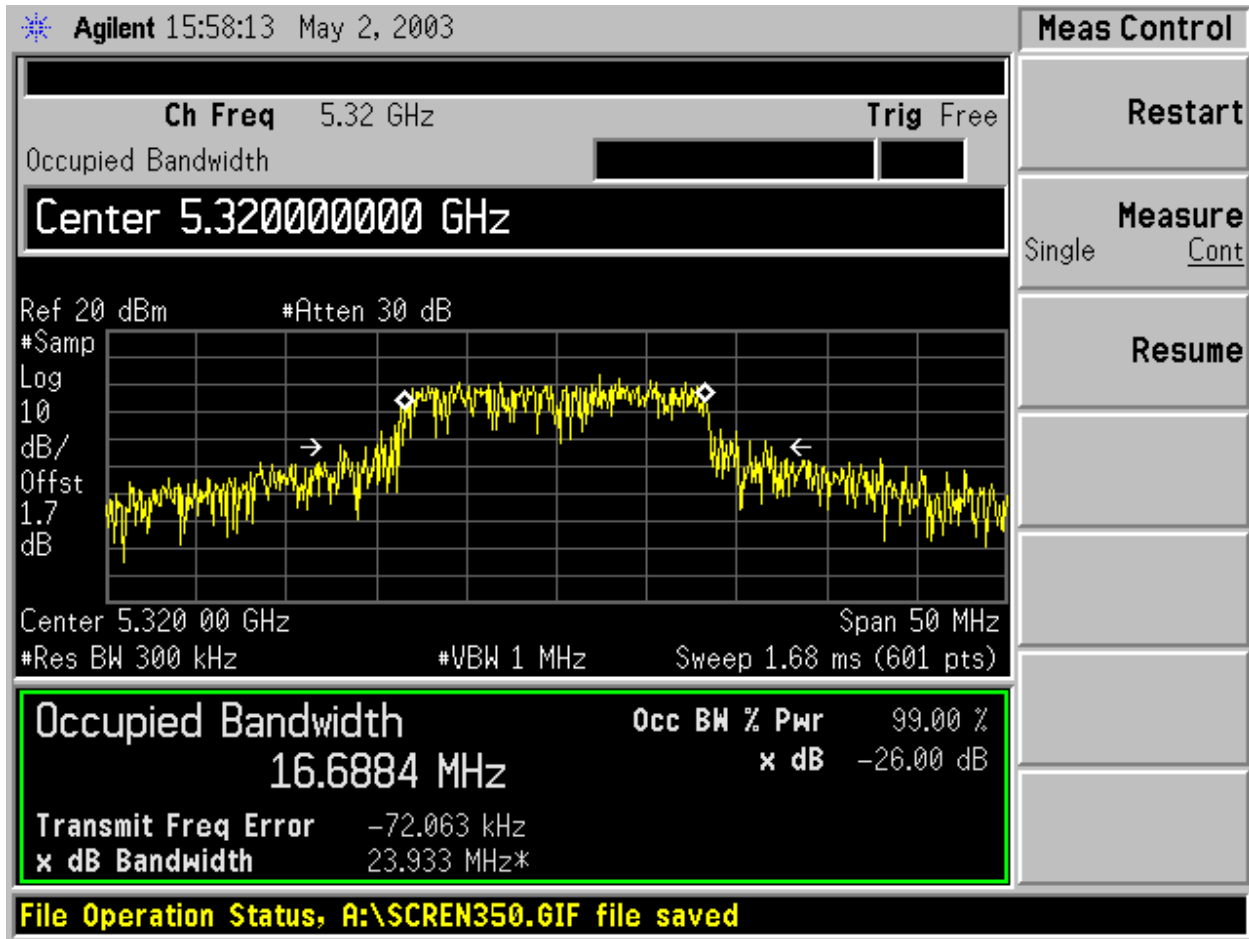

HIGH CHANNEL NORMAL

EMISSION BANDWIDTH (TURBO MODE)

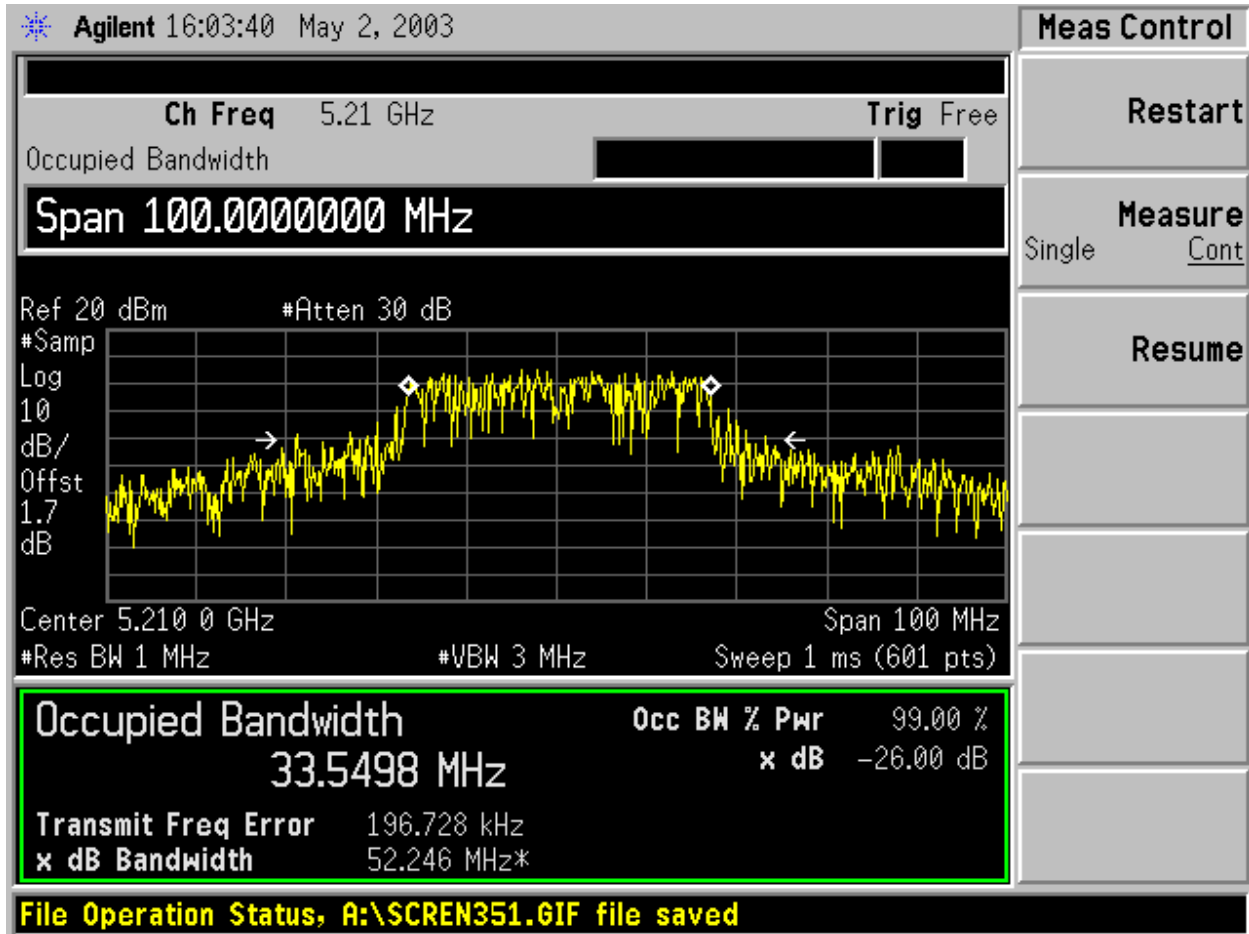

LOW CHANNEL TURBO

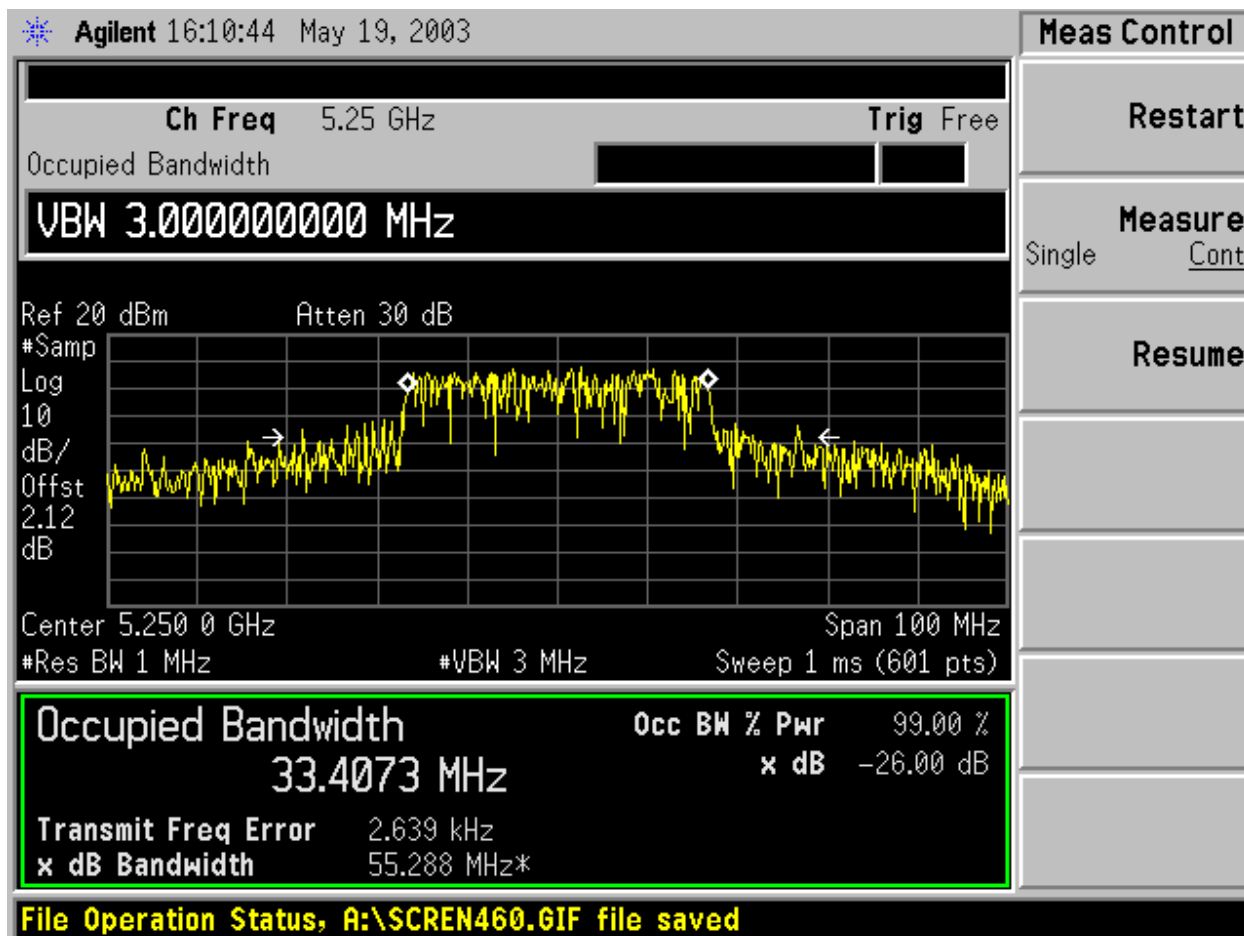

MID CHANNEL TURBO

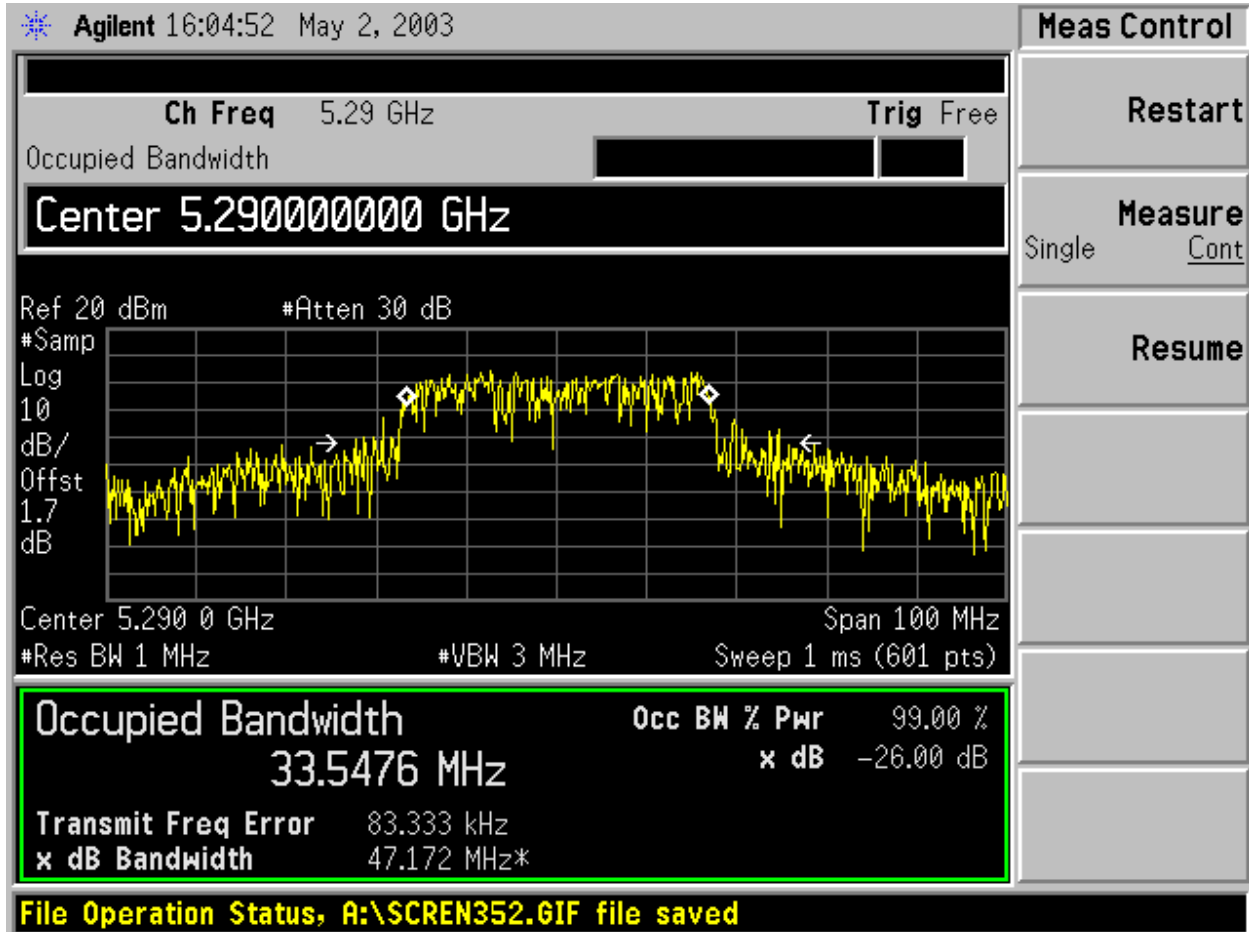

HI CHANNEL TURBO

7.2. PEAK POWER

LIMIT

§15.407 (a) (1) For the band 5.15-5.25 GHz, the peak transmit power over the frequency band of operation shall not exceed the lesser of 50 mW (17 dBm) or $4 \text{ dBm} + 10 \log B$, where B is the 26-dB emission bandwidth in MHz. In addition, the peak power spectral density shall not exceed 4 dBm in any 1-MHz band. If transmitting antennas of directional gain greater than 6 dBi are used, both the peak transmit power and the peak power spectral density shall be reduced by the amount in dB that the directional gain of the antenna exceeds 6 dBi.

§15.407 (a) (1) For the band 5.25-5.35 GHz, the peak transmit power over the frequency band of operation shall not exceed the lesser of 250 mW (24 dBm) or $11 \text{ dBm} + 10 \log B$, where B is the 26-dB emission bandwidth in MHz. In addition, the peak power spectral density shall not exceed 11 dBm in any 1-MHz band. If transmitting antennas of directional gain greater than 6 dBi are used, both the peak transmit power and the peak power spectral density shall be reduced by the amount in dB that the directional gain of the antenna exceeds 6 dBi.

Limit in 5150 to 5250 MHz Band

Mode	Frequency (MHz)	Fixed Limit (dBm)	B (MHz)	$4 + 10 \log B$ Limit (dBm)	Excess Antenna Gain (dB)	Limit (dBm)
Normal	5180	17	25.591	18.08087257	0	17
Turbo	5210	17	52.246	21.18053046	0	17
Turbo	5250	17	55.288	21.4263088	0	17

Limit in 5250 to 5350 MHz Band

Mode	Frequency (MHz)	Fixed Limit (dBm)	B (MHz)	$11 + 10 \log B$ Limit (dBm)	Excess Antenna Gain (dB)	Limit (dBm)
Normal	5260	24	26.647	25.25648322	0	24
Normal	5320	24	23.933	24.78997141	0	24
Turbo	5290	24	47.172	27.7368429	0	24

TEST PROCEDURE

The test is performed in accordance with FCC Public Notice: APPENDIX A Guidelines for Assessing Unlicensed National Information Infrastructure (U-NII) Devices – Part 15, Subpart E, August 2002.

The transmitter output operates continuously therefore Method # 1 is used.

RESULTS

No non-compliance noted:

802.11a Normal Mode

Mode	Frequency (MHz)	Power (dBm)	Limit (dBm)	Margin (dB)
Low	5180	14.29	17.00	-2.71
Middle	5260	16.70	24.00	-7.30
High	5320	13.64	24.00	-10.36

802.11a Turbo Mode

Mode	Frequency (MHz)	Power (dBm)	Limit (dBm)	Margin (dB)
Low	5210	14.79	17.00	-2.21
Middle	5250	16.84	17.00	-0.16
High	5290	14.01	24.00	-9.99

PEAK POWER (BASE MODE)

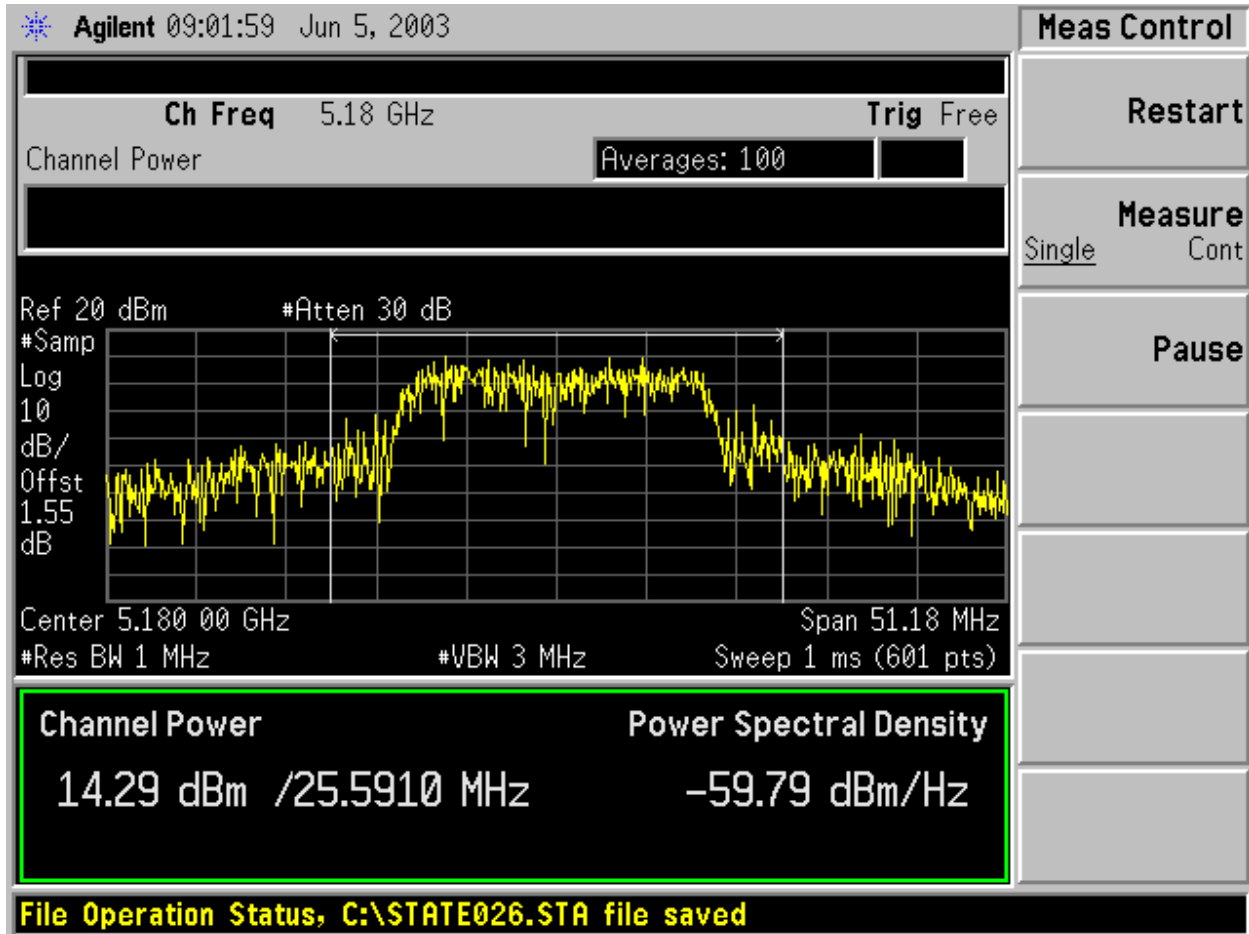

LOW CHANNEL NORMAL

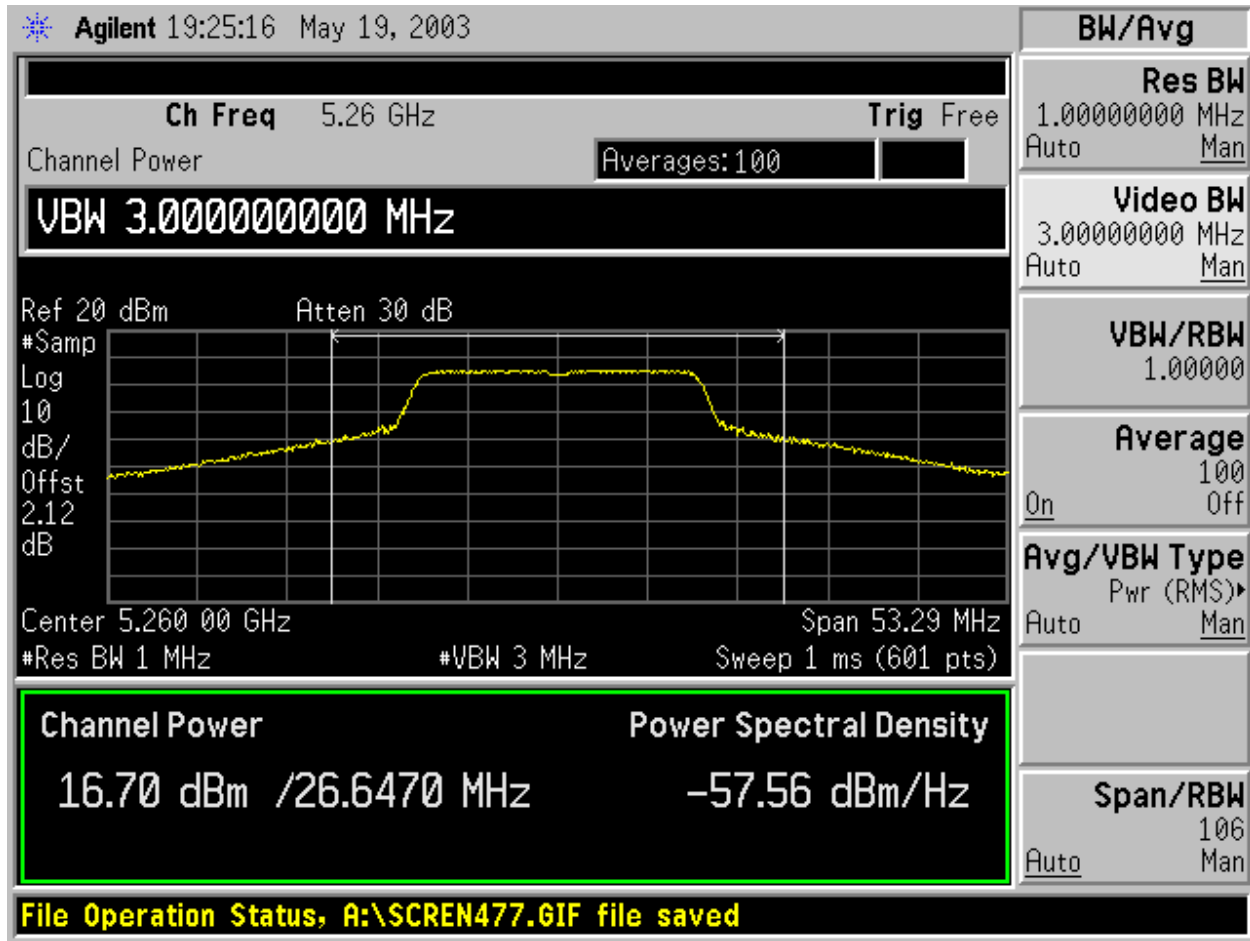

MID CHANNEL NORMAL

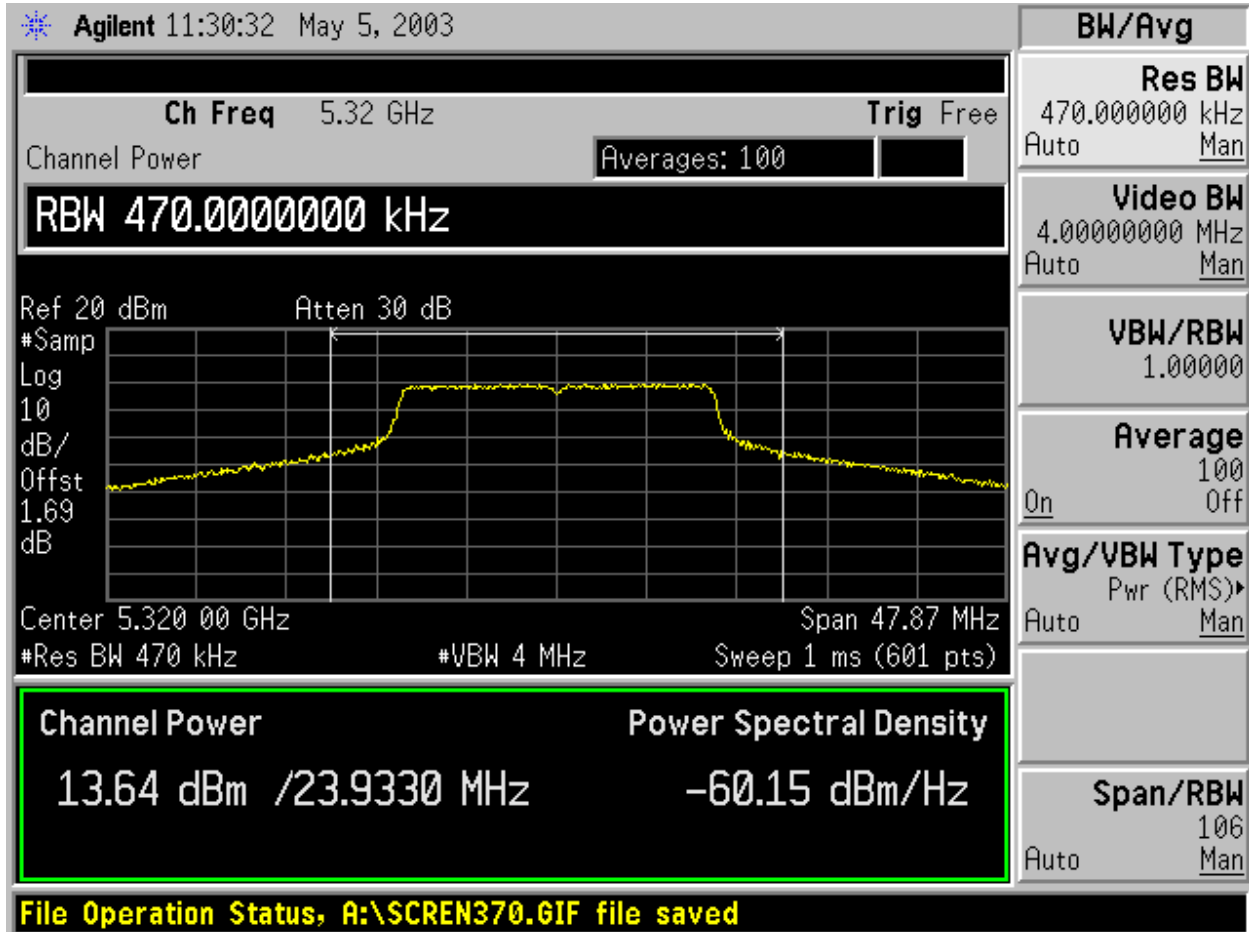

HI CHANNEL NORMAL

PEAK POWER (TURBO MODE)

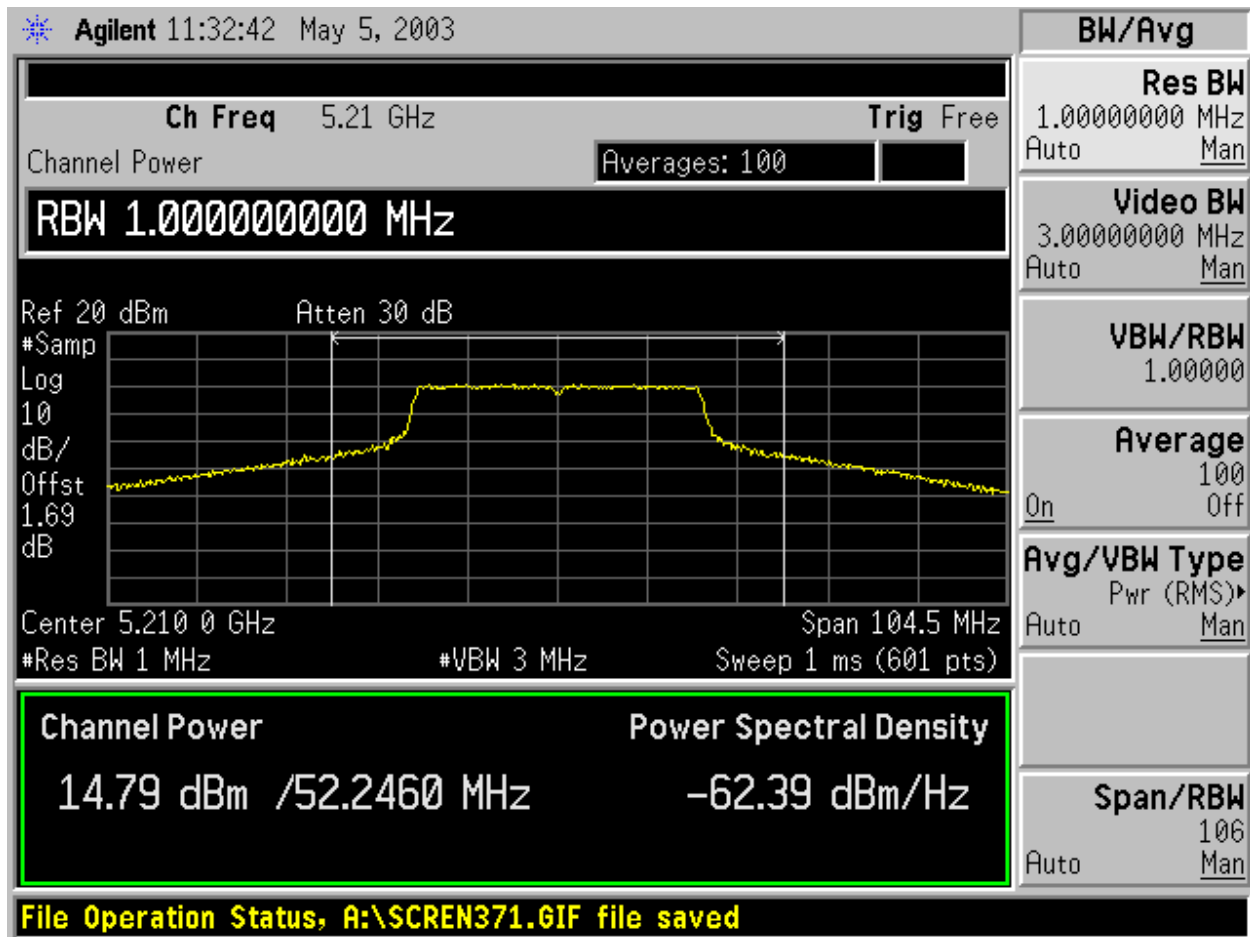

LOW CHANNEL TURBO

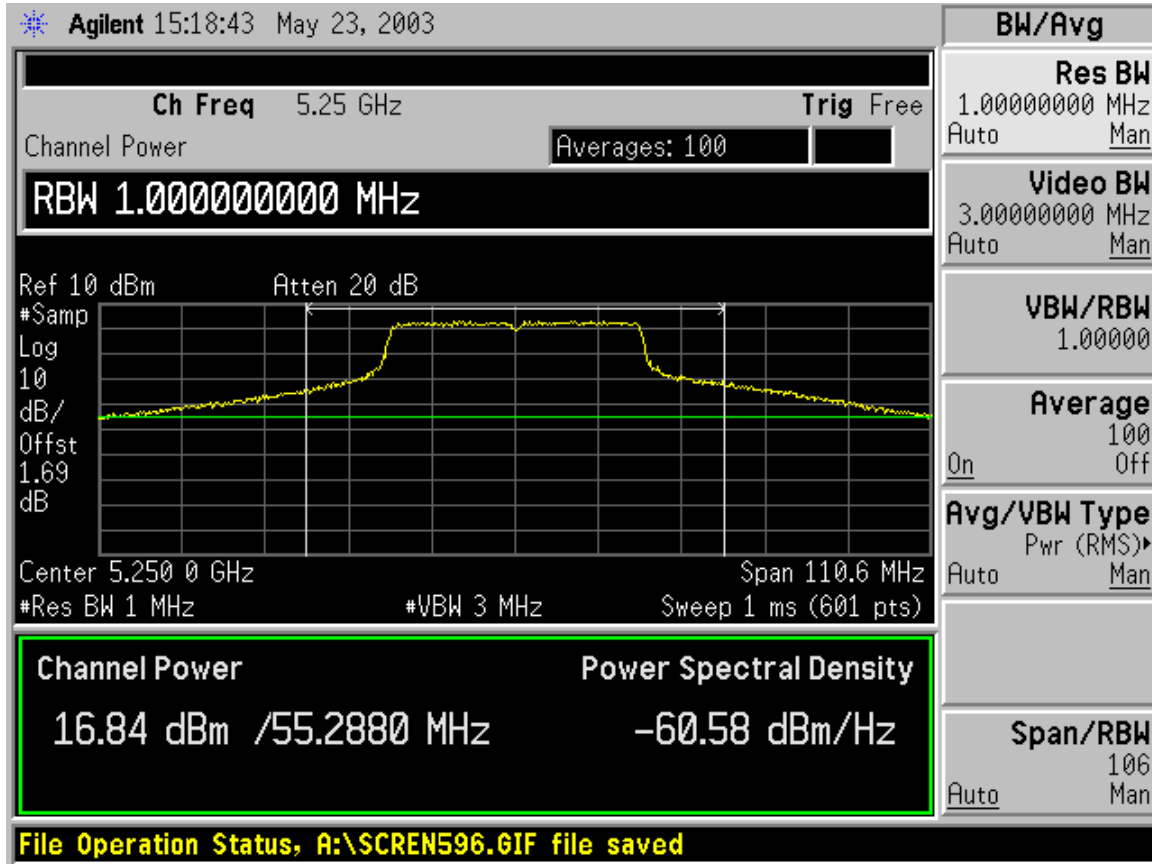

MID CHANNEL TURBO

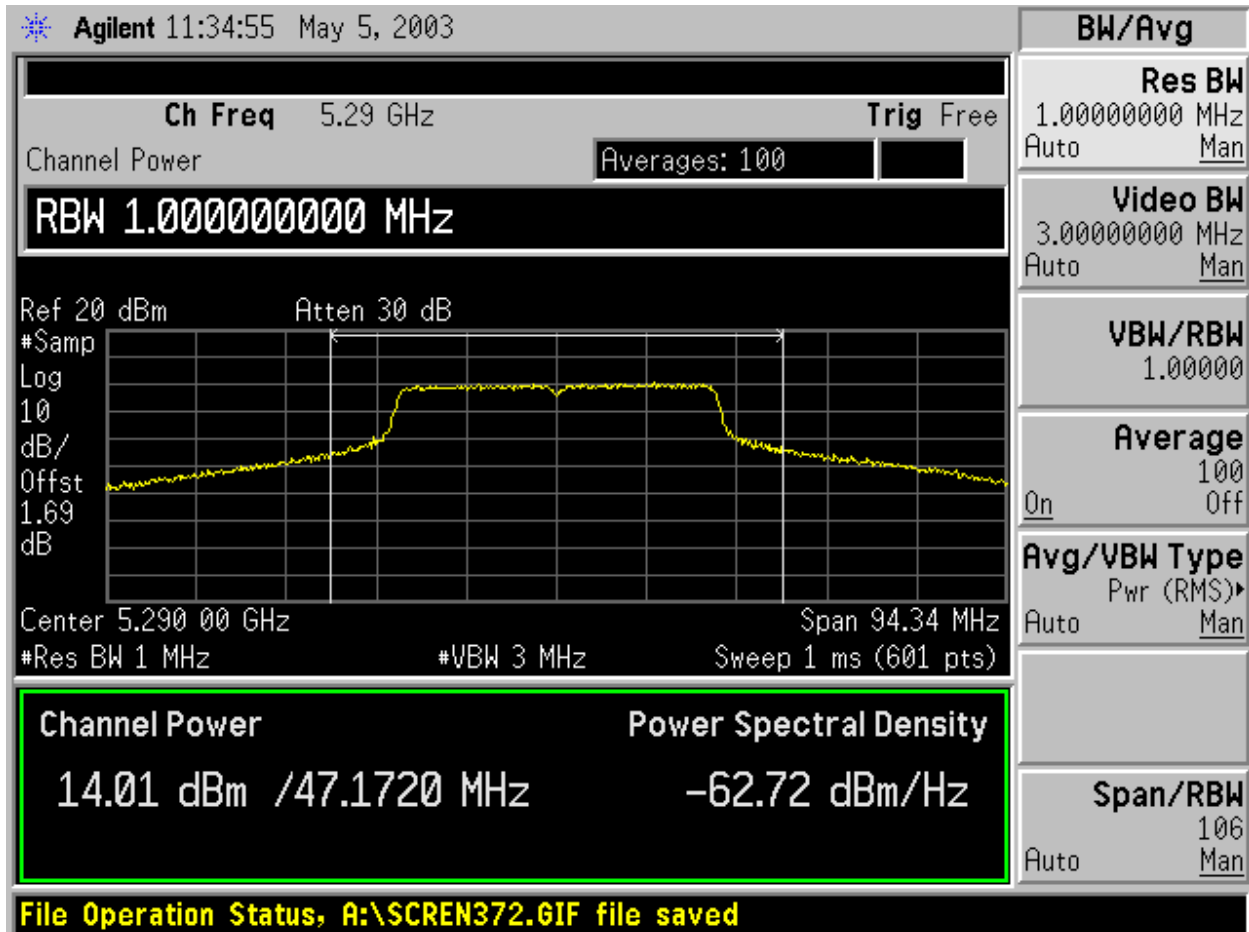

HI CHANNEL TURBO

7.3. MAXIMUM PERMISSIBLE EXPOSURE

LIMITS

§15.247 (b) (5) Systems operating under the provisions of this section shall be operated in a manner that ensures that the public is not exposed to radio frequency energy levels in excess of the Commission's guidelines. See §1.1307(b)(1) of this chapter.

CALCULATIONS

Given

$$E = \sqrt{(30 * P * G) / d}$$

and

$$S = E^2 / 3770$$

where

E = Field Strength in Volts / meter

P = Power in Watts

G = Numeric antenna gain

d = distance in meters

S = Power Density in milliwatts / square centimeter

Combining equations and rearranging the terms to express the distance as a function of the remaining variables yields:

$$d = \sqrt{((30 * P * G) / (3770 * S))}$$

Changing to units of mW and cm, using:

$$P \text{ (mW)} = P \text{ (W)} / 1000 \text{ and}$$

$$d \text{ (cm)} = 100 * d \text{ (m)}$$

yields

$$d = 100 * \sqrt{((30 * (P / 1000) * G) / (3770 * S))}$$

$$d = 0.282 * \sqrt{(P * G / S)}$$

where

d = distance in cm

P = Power in mW

G = Numeric antenna gain

S = Power Density in mW / cm²

Substituting the logarithmic form of power and gain using:

$$P \text{ (mW)} = 10^{(P \text{ (dBm)} / 10)} \text{ and}$$
$$G \text{ (numeric)} = 10^{(G \text{ (dBi)} / 10)}$$

yields

$$d = 0.282 * 10^{((P + G) / 20) / \sqrt{S}} \quad \text{Equation (1)}$$

where

- d = MPE distance in cm
- P = Power in dBm
- G = Antenna Gain in dBi
- S = Power Density Limit in mW / cm²

Equation (1) and the measured peak power is used to calculate the MPE distance.

LIMITS

S = 1.0 mW / cm² from 1.1310 Table 1

NOTE: For mobile or fixed location transmitters, the minimum separation distance is 20 cm, even if calculations indicate that the MPE distance would be less.

RESULTS

No non-compliance noted:

Mode	Power Density Limit (mW/cm ²)	Output Power (dBm)	Antenna Gain (dBi)	MPE Distance (cm)
802.11a Normal	1.0	16.70	4.80	3.35
802.11a Turbo	1.0	16.84	4.80	3.41

7.4. AVERAGE POWER

LIMIT

None; reporting requirement only.

TEST PROCEDURE

The transmitter output is connected to a power meter. The power meter is set to read average power.

RESULTS

No non-compliance noted:

The cable assembly insertion loss of 11.70 dB (including 10 dB pad and 1.69dB cable) was entered as an offset in the power meter to allow for direct reading of power.

Base Mode

Channel	Frequency (MHz)	Average Power (dBm)
Low	5180	14.02
Middle	5260	17.15
High	5320	14.26

Turbo Mode

Channel	Frequency (MHz)	Average Power (dBm)
Low	5210	14.25
Middle	5250	17.50
High	5290	13.74

7.5. PEAK POWER SPECTRAL DENSITY

LIMIT

§15.407 (a) (1) For the band 5.15-5.25 GHz, the peak transmit power over the frequency band of operation shall not exceed the lesser of 50 mW (17 dBm) or $4 \text{ dBm} + 10 \log B$, where B is the 26-dB emission bandwidth in MHz. In addition, the peak power spectral density shall not exceed 4 dBm in any 1-MHz band. If transmitting antennas of directional gain greater than 6 dBi are used, both the peak transmit power and the peak power spectral density shall be reduced by the amount in dB that the directional gain of the antenna exceeds 6 dBi.

§15.407 (a) (1) For the band 5.25-5.35 GHz, the peak transmit power over the frequency band of operation shall not exceed the lesser of 250 mW (24 dBm) or $11 \text{ dBm} + 10 \log B$, where B is the 26-dB emission bandwidth in MHz. In addition, the peak power spectral density shall not exceed 11 dBm in any 1-MHz band. If transmitting antennas of directional gain greater than 6 dBi are used, both the peak transmit power and the peak power spectral density shall be reduced by the amount in dB that the directional gain of the antenna exceeds 6 dBi.

The maximum antenna gain = 4.8 dBi, therefore there is no reduction due to antenna gain.

TEST PROCEDURE

The test is performed in accordance with FCC Public Notice: APPENDIX A Guidelines for Assessing Unlicensed National Information Infrastructure (U-NII) Devices – Part 15, Subpart E, August 2002. PPSD method #2 was used.

RESULTS

No non-compliance noted:

802.11a Normal Mode

Channel	Frequency (MHz)	PPSD (dBm)	Limit (dBm)	Margin (dB)
Low	5180	2.899	4	-1.101
Middle	5260	5.428	11	-5.572
High	5320	2.644	11	-8.356

802.11a Turbo Mode

Channel	Frequency (MHz)	PPSD (dBm)	Limit (dBm)	Margin (dB)
Low	5210	0.722	4	-3.278
Middle	5250	2.824	4	-1.176
High	5290	-0.693	11	-11.693

PPSD (BASE MODE)

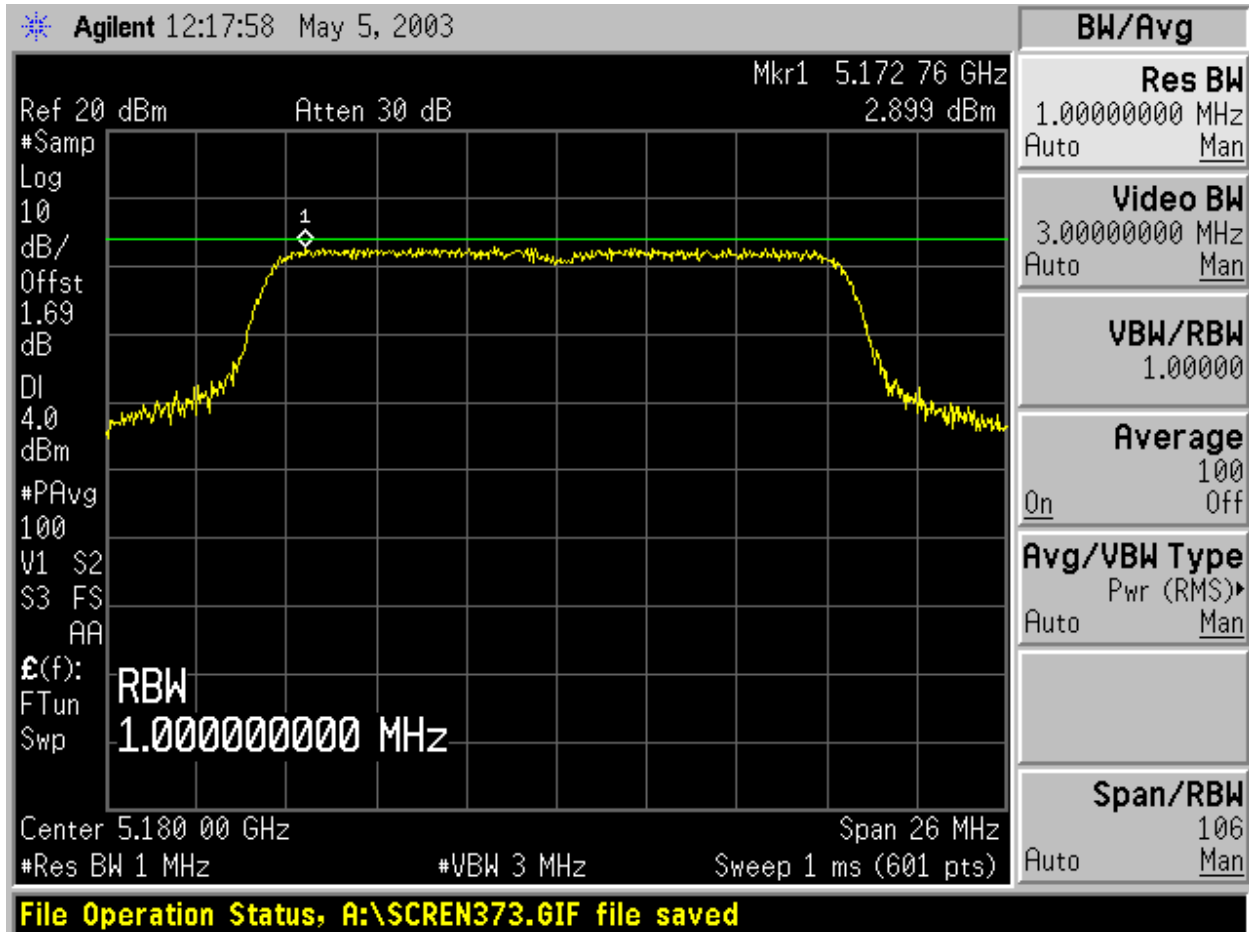

LOW CHANNEL NORMAL

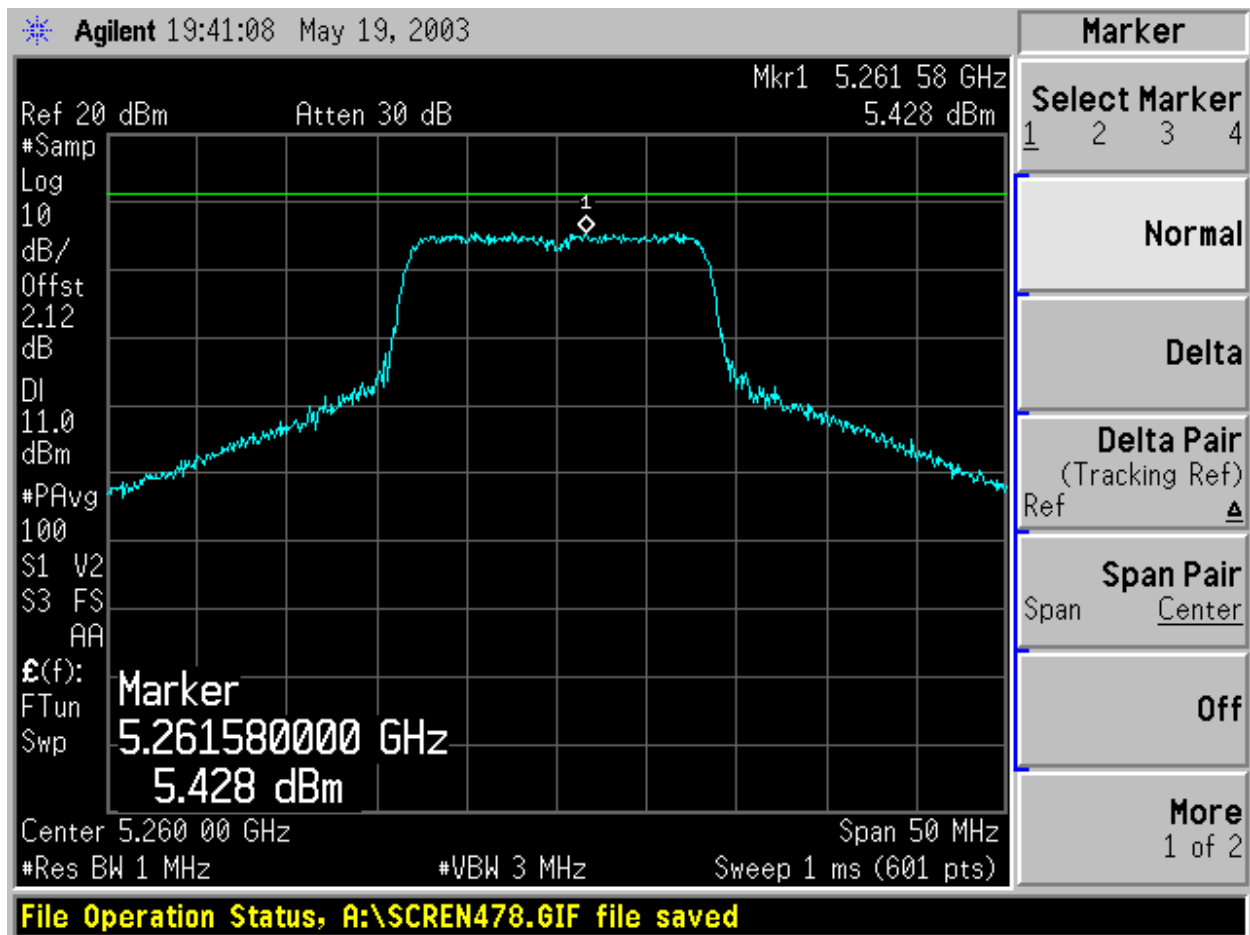

MID CHANNEL NORMAL

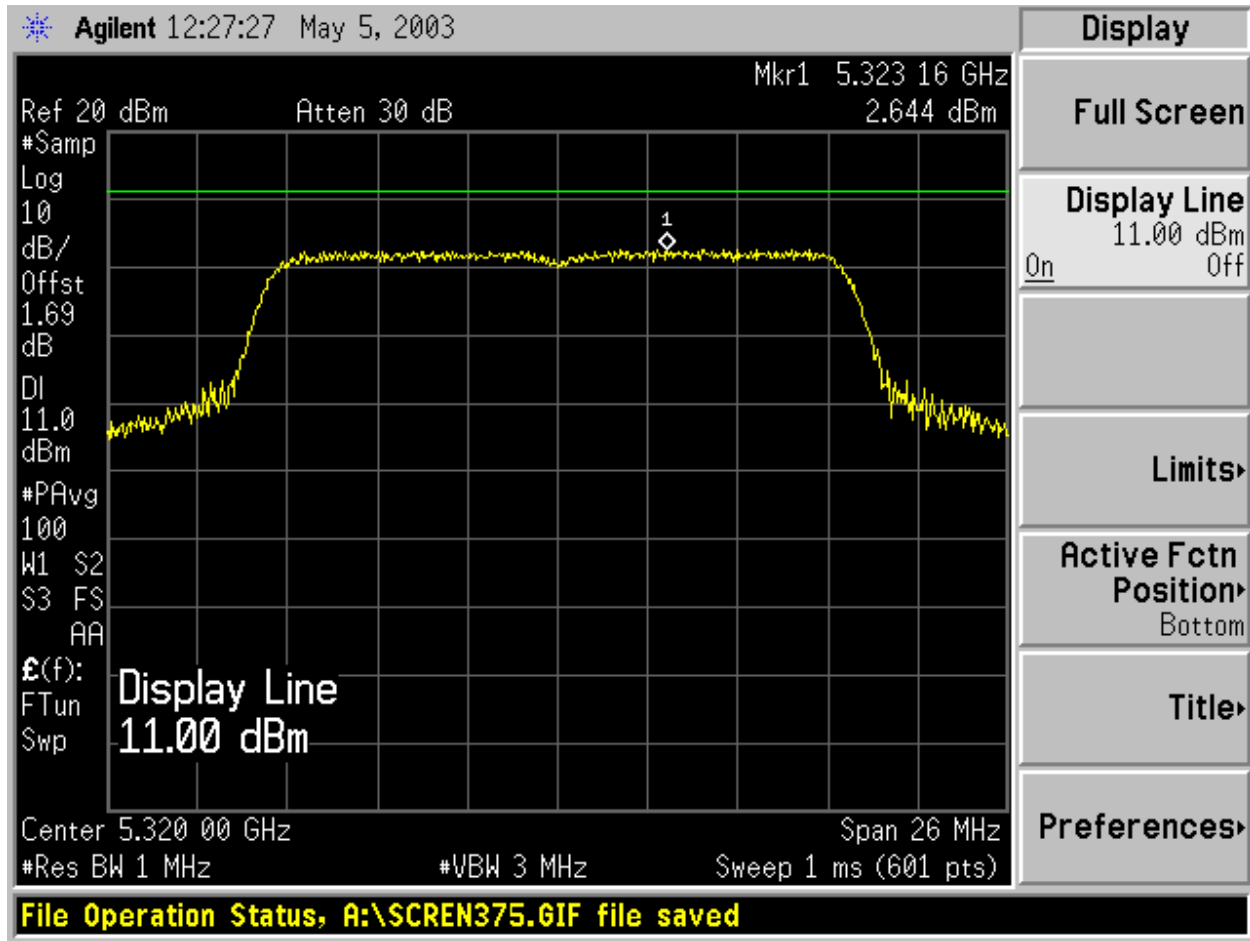

HI CHANNEL NORMAL

PPSD (TURBO MODE)

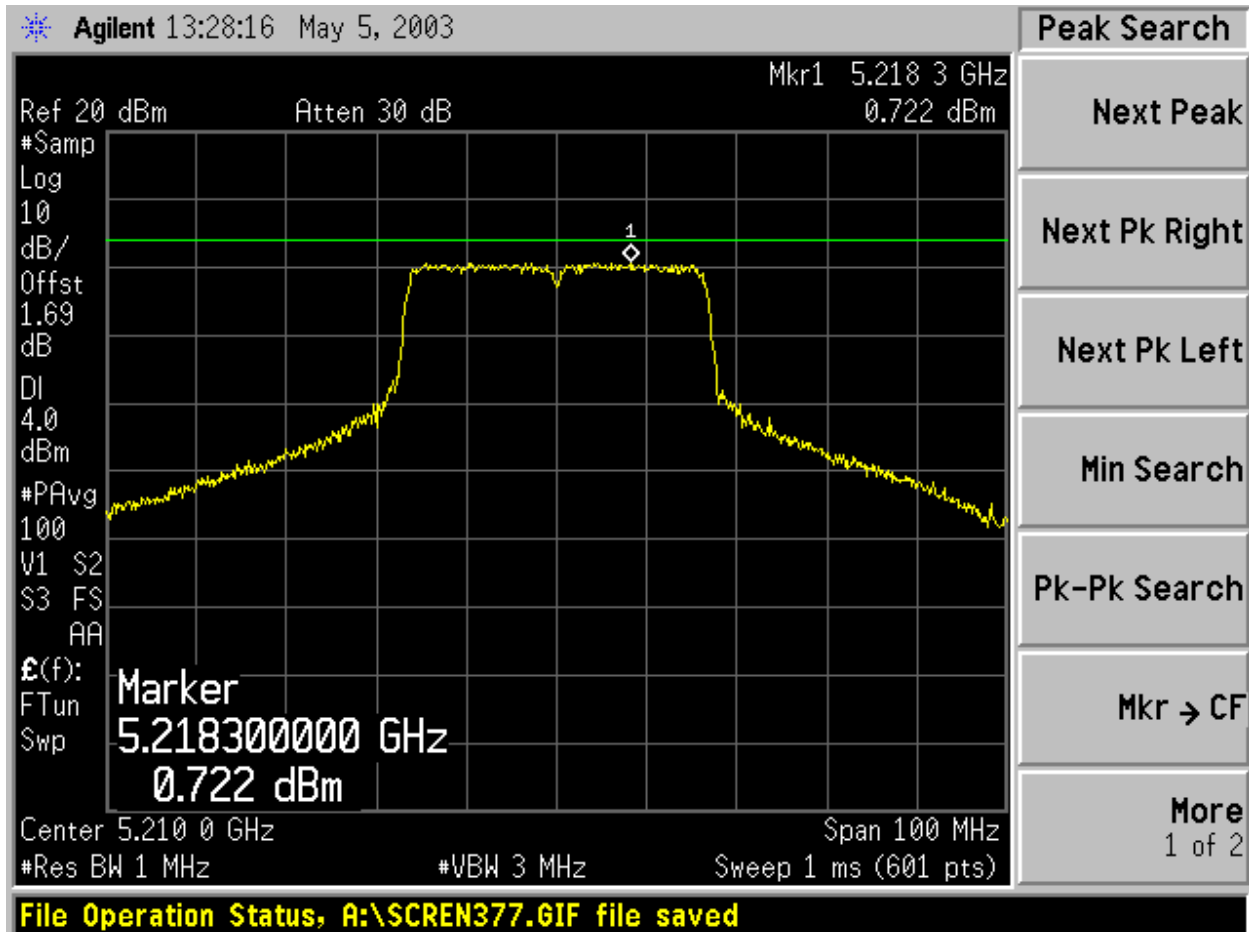

LOW CHANNEL TURBO

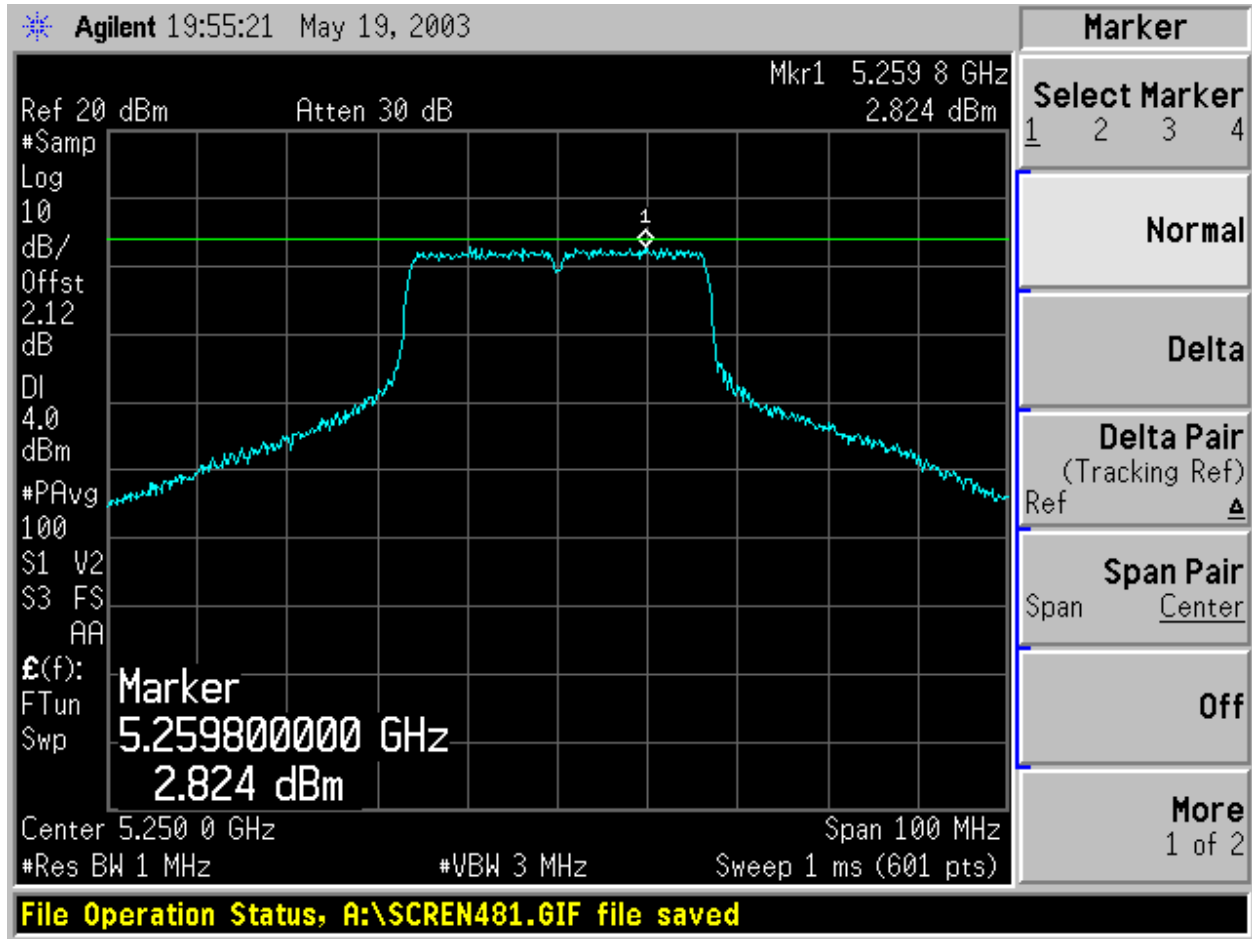

MID CHANNEL TURBO

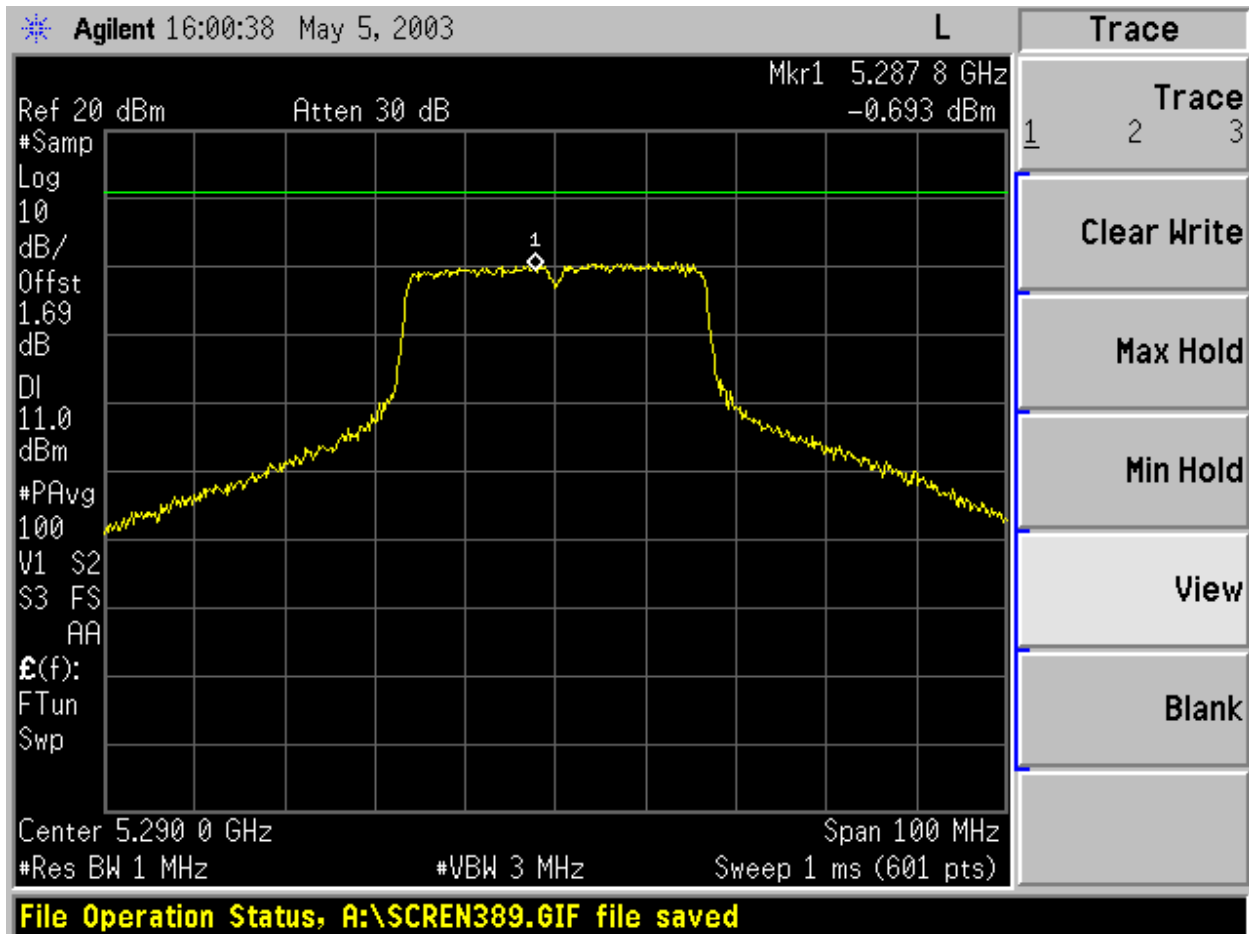

HI CHANNEL TURBO

7.6. PEAK EXCURSION

LIMIT

§15.407 (a) (6) The ratio of the peak excursion of the modulation envelope (measured using a peak hold function) to the peak transmit power (measured as specified above) shall not exceed 13 dB across any 1 MHz bandwidth or the emission bandwidth whichever is less.

TEST PROCEDURE

The test is performed in accordance with FCC Public Notice: APPENDIX A Guidelines for Assessing Unlicensed National Information Infrastructure (U-NII) Devices – Part 15, Subpart E, August 2002.

Since Method # 1 was used for peak power measurements, Method # 1 settings are used for the second PPSD trace.

RESULTS

No non-compliance noted:

802.11a Normal Mode

Channel	Frequenc (MHz)	Peak Excursion (dB)	Limit (dB)	Margin (dB)
Low	5180	8.93	13	-4.07
Middle	5260	9.18	13	-3.82
High	5320	9.28	13	-3.72

802.11a Turbo Mode

Channel	Frequenc (MHz)	Peak Excursion (dB)	Limit (dB)	Margin (dB)
Low	5210	7.54	13	-5.46
Middle	5250	8.2	13	-4.8
High	5290	8.26	13	-4.74

PEAK EXCURSION (BASE MODE)

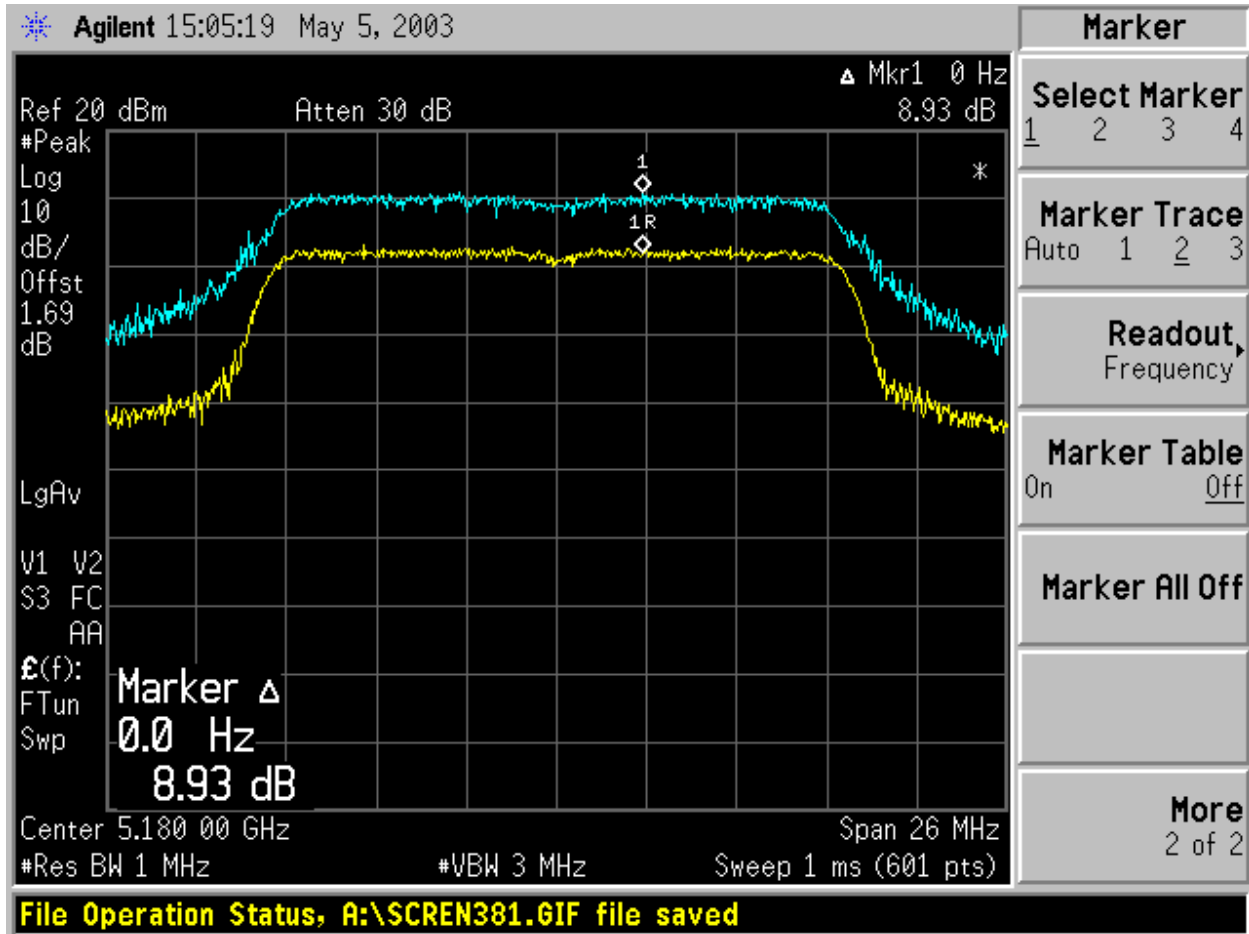

LOW CHANNEL NORMAL

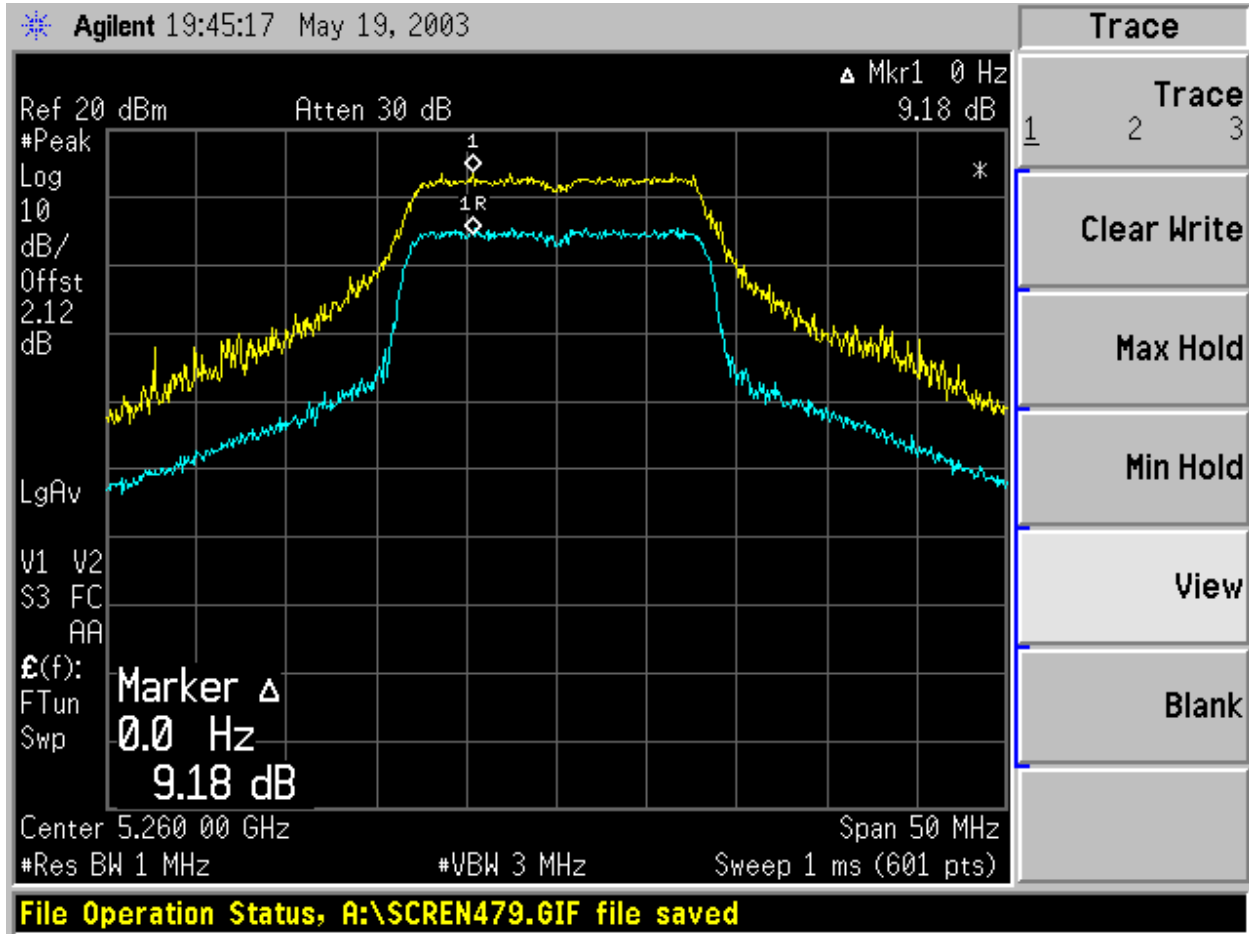

MID CHANNEL NORMAL

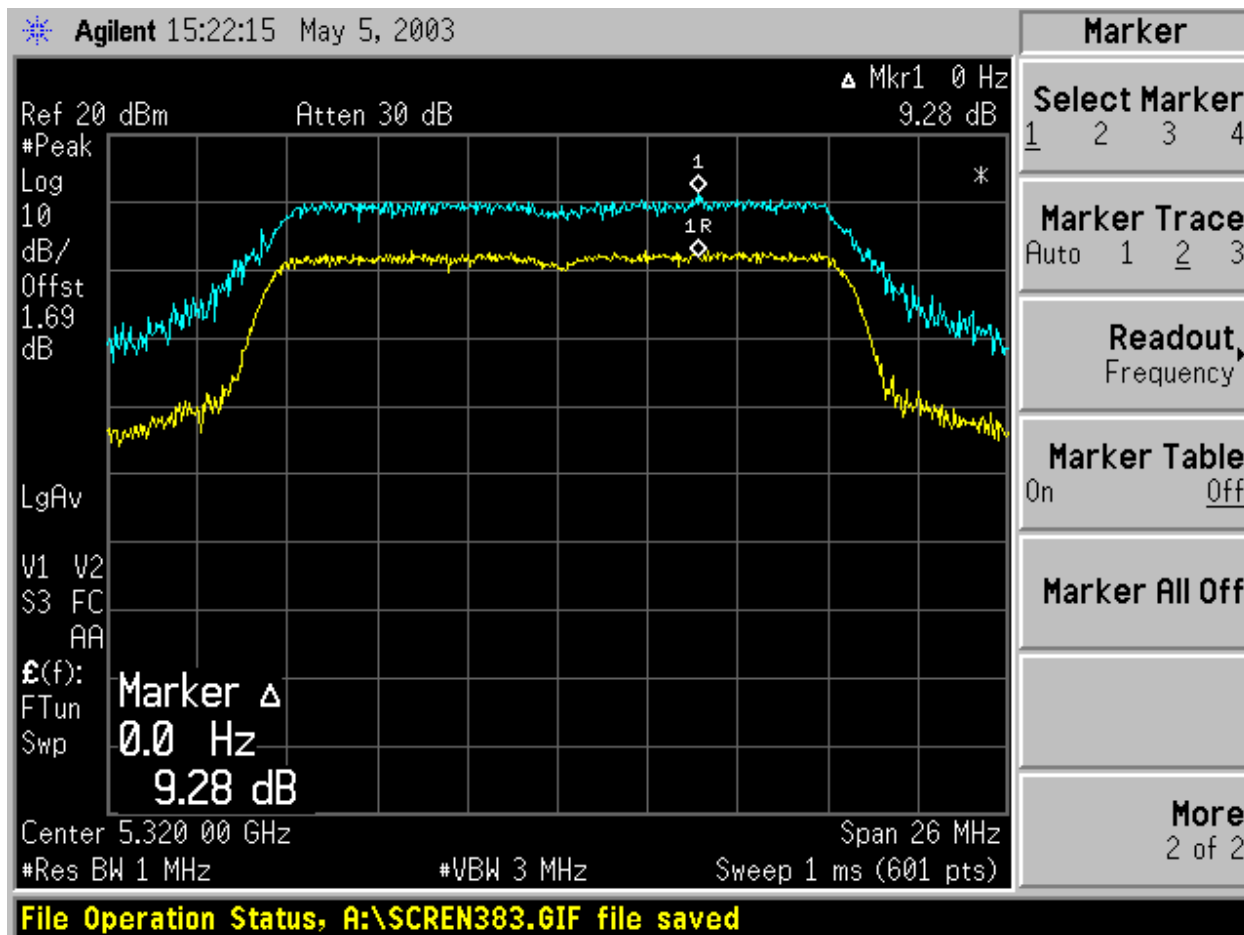

HI CHANNEL NORMAL

PEAK EXCURSION (TURBO MODE)

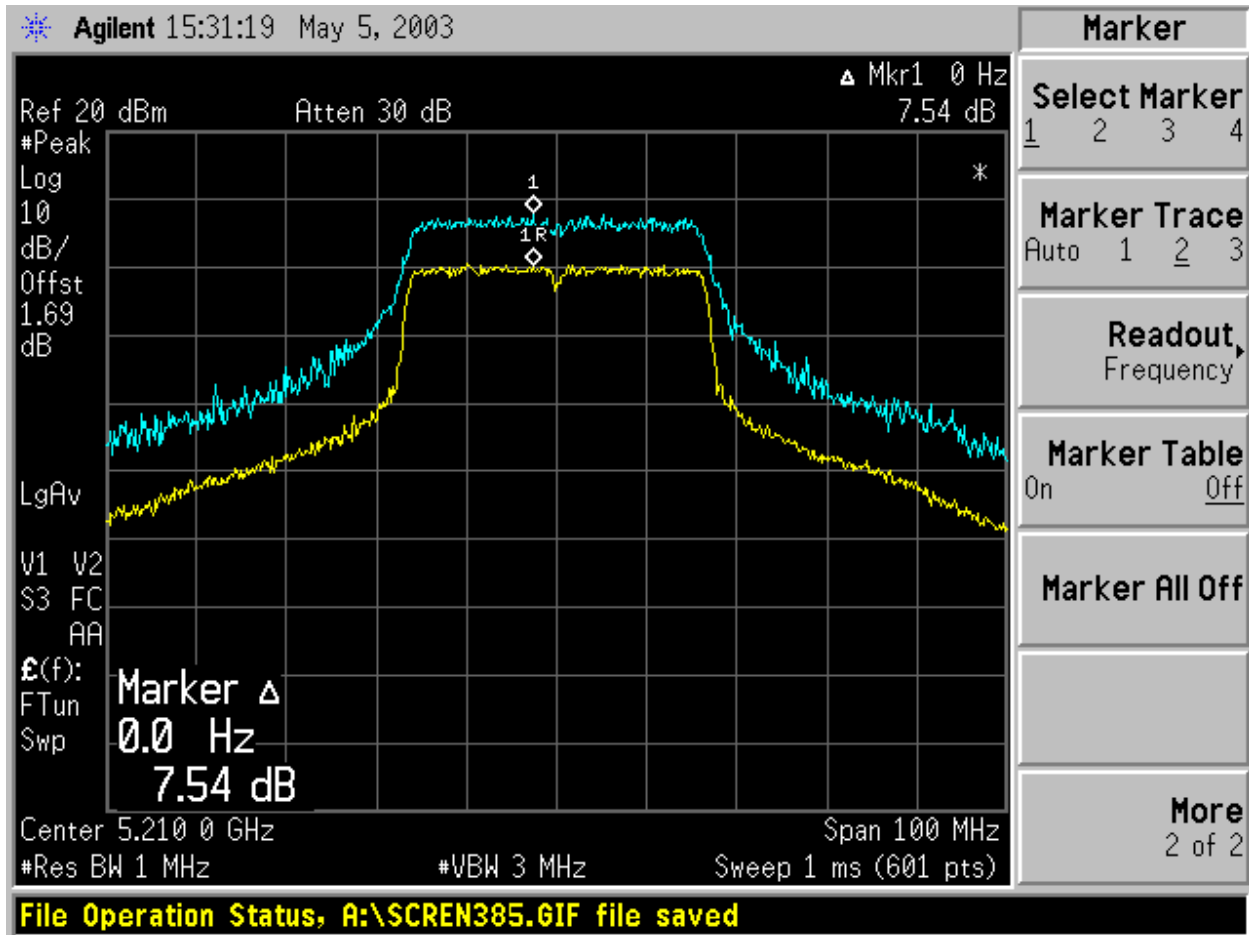

LOW CHANNEL TURBO

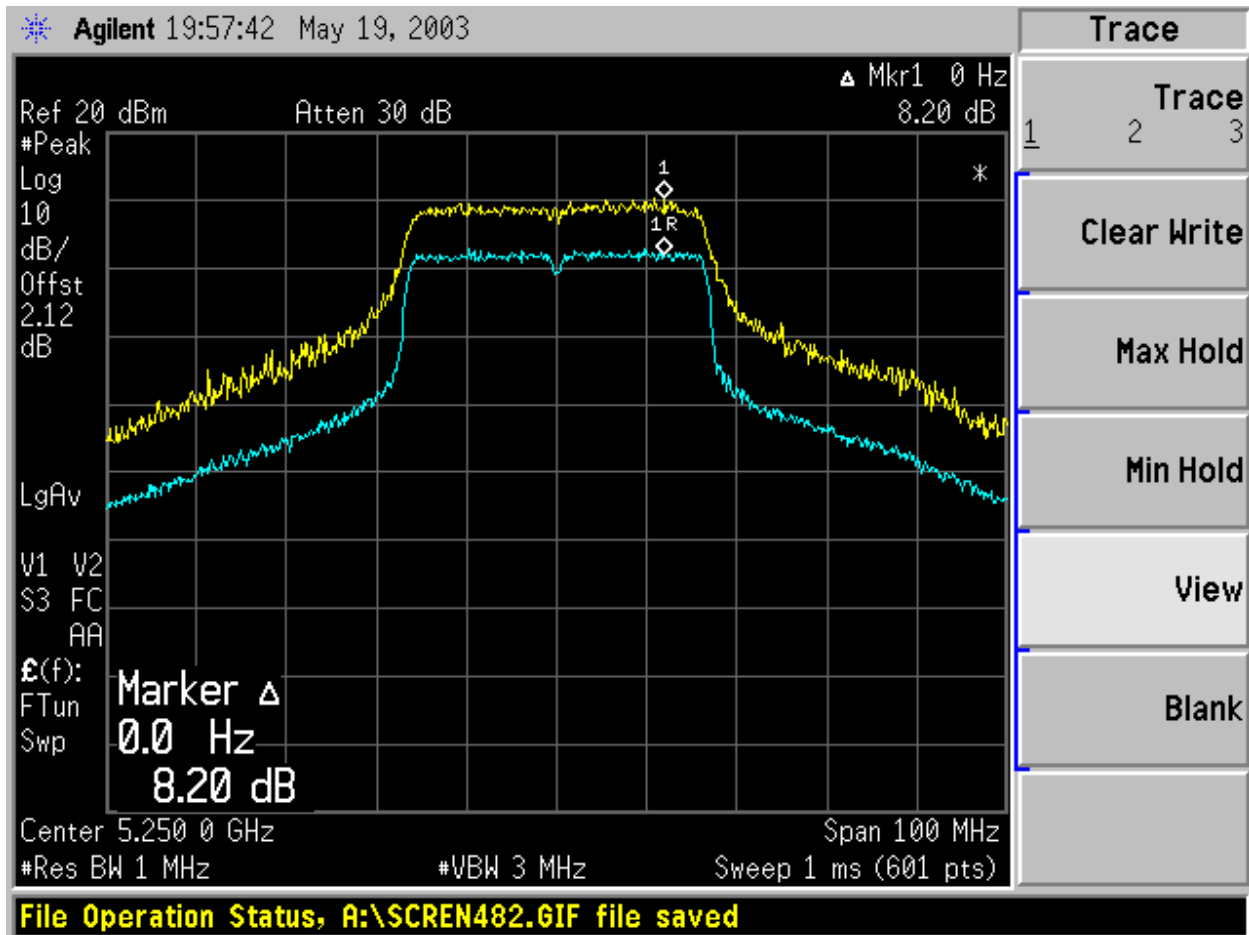

MID CHANNEL TURBO

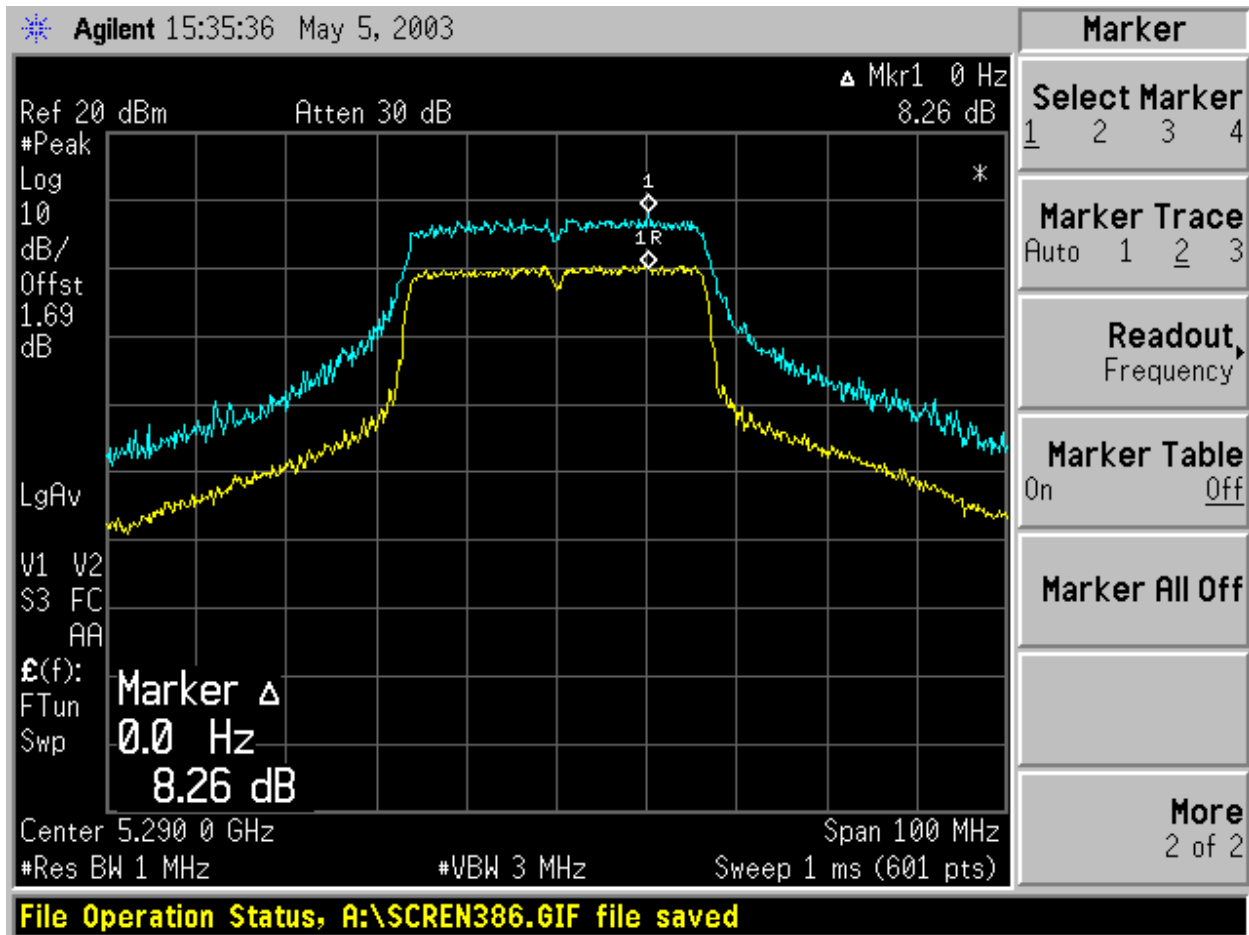

HI CHANNEL TURBO

7.7. TRANSMISSION IN THE ABSENCE OF DATA

RESULTS

No non-compliance noted:

See theory of operation

7.8. TYPE OF ANTENNA

RESULTS

No non-compliance noted:

Antenna is integral.

7.9. FREQUENCY STABILITY

RESULTS

No non-compliance noted:

Referring to the theory of operation, the crystal used to set the frequency has a temperature coefficient of +/- 20 ppm over the specified rated temperature range. For a transmitter fundamental frequency of 5.35 GHz, this corresponds to +/- 107 kHz.

7.10. CONDUCTED UNDESIRABLE EMISSIONS

LIMITS

§15.407 (b) (1 & 2) For transmitters operating in the 5.15-5.35 GHz band: all emissions outside of the 5.15-5.35 GHz band shall not exceed an EIRP of -27dBm / MHz.

TEST PROCEDURE

Conducted RF measurements of the transmitter output are made to confirm that the EUT antenna port conducted emissions meet the specified limit and to identify any spurious signals that require further investigation or measurements on the radiated emissions site.

The transmitter output is connected to the spectrum analyzer. The resolution bandwidth is set to 1 MHz. The video bandwidth is set to 1 MHz. Peak detection measurements are compared to the average EIRP limit, adjusted for the maximum antenna gain. If necessary, additional average detection measurements are made.

Measurements are made over the 30 MHz to 40 GHz range with the transmitter set to the lowest, middle, and highest channels.

RESULTS

No non-compliance noted: