

FCC SAR Test Report (Class II Permissive Change)

Product Name : Intel® Wi-Fi 6 AX201

Model No. : AX201NGW

Applicant : Dynabook Inc.

Address : 6-15, Toyosu 5-chome, Koto-ku, Tokyo, 135-8505, Japan

Date of Receipt : 2022/03/30

Issued Date : 2022/06/20

Report No. : 2231069R-SAUSSARV02-A

Report Version : V1.0



The test results relate only to the samples tested.

The test results shown in the test report are traceable to the national/international standard through the calibration report of the equipment and evaluated measurement uncertainty herein.

This report must not be used to claim product endorsement by TAF or any agency of the government.

The test report shall not be reproduced without the written approval of DEKRA Testing and Certification Co., Ltd.

Measurement uncertainties evaluated for each testing system and associated connections are given here to provide the system information for reference. Compliance determinations do not take into account measurement uncertainties for each testing system, but are based on the results of the compliance measurement.

Test Report

Issued Date: 2022/06/20

Report No.: 2231069R-SAUSSARV02-A



Product Name : Intel® Wi-Fi 6 AX201
 Applicant : Dynabook Inc.
 Address : 6-15, Toyosu 5-chome, Koto-ku, Tokyo, 135-8505, Japan
 Manufacturer : Intel Mobile Communications
 Model No. : AX201NGW
 Trade Name : Intel
 FCC ID : CJ6AX201NGWWB
 Applicable Standard : IEEE 1528-2013
 KDB 447498 D01 v06
 KDB 865664 D01 v01r04
 Measurement procedures : 47CFR § 2.1093
 KDB 248227 D01 v02r02
 KDB 616217 D04 v01r02
 Test Result : Max. SAR Measurement (1g)
 2.4GHz: **0.643** W/kg
 5 GHz: **0.767** W/kg
 Application Type : Certification

The above equipment has been tested by DEKRA, and found compliance with the requirement of the above standards. The test record, data evaluation & Equipment Under Test (EUT) configurations represented herein are true and accurate accounts of the measurements of the sample's SAR characteristics under the conditions specified in this report.

Documented By : April Chen
 (Senior Project Specialist / April Chen)

Tested By : Luke Cheng
 (Senior Engineer / Luke Cheng)

Approved By : San Lin
 (Supervisor / San Lin)

TABLE OF CONTENTS

| Description | Page |
|---|-----------|
| 1. General Information | 5 |
| 1.1 EUT Description..... | 5 |
| 1.2 Antenna List..... | 5 |
| 1.3 SAR Test Exclusion Calculation..... | 6 |
| 1.4 Test Environment | 6 |
| 2. SAR Measurement System | 8 |
| 2.1 DASY5 System Description | 8 |
| 2.1.1 Applications | 9 |
| 2.1.2 Area Scans | 9 |
| 2.1.3 Zoom Scan (Cube Scan Averaging)..... | 9 |
| 2.1.4 Uncertainty of Inter-/Extrapolation and Averaging | 9 |
| 2.2 DASY5 E-Field Probe | 10 |
| 2.2.1 Isotropic E-Field Probe Specification..... | 10 |
| 2.3 Boundary Detection Unit and Probe Mounting Device | 11 |
| 2.4 DATA Acquisition Electronics (DAE) and Measurement Server | 11 |
| 2.5 Robot | 12 |
| 2.6 Light Beam Unit | 12 |
| 2.7 Device Holder | 13 |
| 2.8 SAM Twin Phantom | 13 |
| 3. Tissue Simulating Liquid | 14 |
| 3.1 The composition of the tissue simulating liquid | 14 |
| 3.2 Tissue Calibration Result..... | 14 |
| 3.3 Tissue Dielectric Parameters for Head and Body Phantoms..... | 16 |
| 4. SAR Measurement Procedure | 17 |
| 4.1 SAR System Check | 17 |
| 4.1.1 Dipoles..... | 17 |
| 4.1.2 System Check Result | 17 |
| 4.2 SAR Measurement Procedure..... | 19 |
| 5. SAR Exposure Limits | 20 |
| 6. Test Equipment List | 21 |
| 7. Measurement Uncertainty | 24 |
| 8. Conducted Power Measurement (Including tolerance allowed for production unit) | 26 |
| 9. Test Results | 26 |
| 9.1 SAR Test Results Summary | 29 |
| 9.2 Simultaneous Transmission..... | 31 |
| 9.2.1 Simultaneous transmission of MIMO in 802.11 test exclusion considerations..... | 31 |
| 9.2.2 Simultaneous transmission of Wi-Fi and other wireless technologies | 32 |
| 10. SAR measurement variability | 32 |
| Appendix..... | 34 |
| Appendix A. SAR System Check Data | |
| Appendix B. SAR measurement Data | |
| Appendix C. Test Setup Photographs | |
| Appendix D. Probe Calibration Data | |
| Appendix E. Dipole Calibration Data | |
| Appendix F. Product Photos-Please refer to the file: 2231069R-Product Photos | |

Revision History

| Report No. | Version | Description | Issued Date |
|-----------------------|---------|-------------------------|-------------|
| 2231069R-SAUSSARV02-A | V1.0 | Initial issue of report | 2022/06/20 |

1. General Information

1.1 EUT Description

| | | | |
|---|---|------------------|---------------|
| Product Name | Intel® Wi-Fi 6 AX201 | | |
| Trade Name | Intel | | |
| Model No. | AX201NGW | | |
| Serial Number | P/N: 7330945500022 (for ANT1: High-Tek) P/N: 7330945500041 (for ANT2: SOUTHSTAR) | | |
| FCC ID | CJ6AX201NGWWB | | |
| Frequency Range | WLAN 2.4GHz: 2412-2472MHz WLAN 5GHz: 5180-5240MHz, 5260-5320, 5500-5720MHz, 5745-5825MHz BT: 2402-2480MHz | | |
| Type of Modulation | 802.11b: DSSS 802.11a/g/n/ac/ax: OFDM, OFDMA GFSK(1Mbps) / π / 4DQPSK(2Mbps) / 8DPSK(3Mbps) | | |
| Antenna Type | PIFA | | |
| Device Category | Portable | | |
| RF Exposure Environment | Uncontrolled | | |
| Summary of test result-Reported 1g SAR (W/Kg) | | | |
| Test configuration | DTS | NII | DSS(BT) |
| Body-Standalone | 0.643 | 0.767 | 0.120 |
| Body-Simultaneous | DTS (Main + Aux) | NII (Main + Aux) | NII + DSS(BT) |
| | 1.049 | 1.224 | 1.344 |

Note:

| Host information | | | |
|---|-------------------|---------------------|---|
| Brand | Product Name | Model No. | Difference |
| dynabook | Notebook Computer | SATELLITE PRO C50-K | All models are electrically identical, different model names are for marketing purpose. |
| | | SATELLITE C50-K | |
| The identification of test sample is SATELLITE PRO C50-K. | | | |

1.2 Antenna List

| No. | Manufacturer | Part No. | Antenna Type | Peak Gain |
|-----|-------------------------------|--|--------------|---|
| 1. | High-Tek Electronics Co., Ltd | DC33002PS00 (0ACCN021061N) (Main) (Aux) | PIFA | 2.52dBi for 2.4GHz 2.72dBi for 5.15~5.25GHz 2.73dBi for 5.25~5.35GHz 2.98dBi for 5.47~5.725GHz 2.80dBi for 5.725~5.850GHz |
| 2 | SOUTHSTAR TECHNOLOGY CO.,LTD | DC33002PX00(N12-8274-R0A) (Main) (Aux) | PIFA | 1.71dBi for 2.4GHz 2.66dBi for 5.15~5.25GHz 2.66dBi for 5.25~5.35GHz 2.21dBi for 5.47~5.725GHz 2.67dBi for 5.725~5.850GHz |

Note: The above EUT information is declared by manufacturer.

1.3 SAR Test Exclusion Calculation

According to KDB Publication 616217 D04, SAR evaluation is required for the bottom surface of the laptop keyboard.

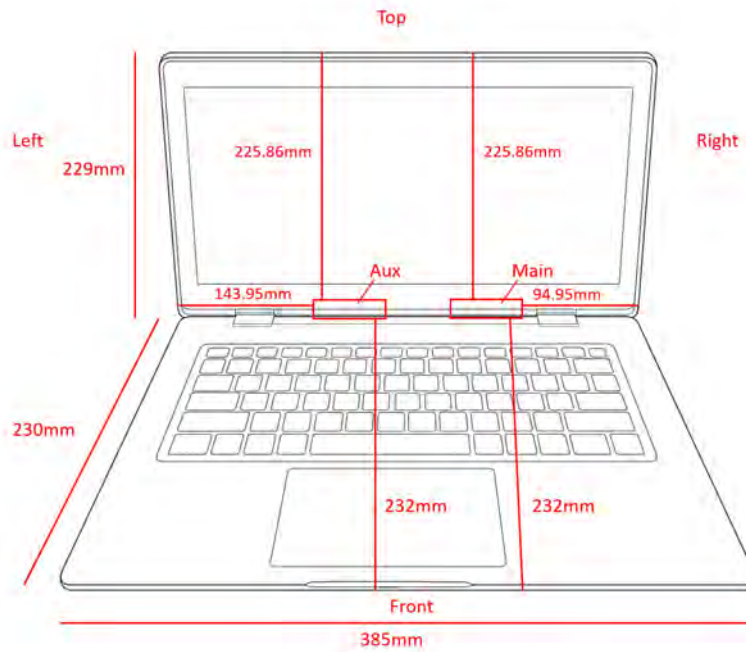

1.4 Test Environment

Ambient conditions in the laboratory:

Test Date: Apr. 13, 2022

| Items | Required | Actual |
|------------------|----------|---------|
| Temperature (°C) | 18-25 | 22.9± 2 |
| Humidity (%RH) | 30-70 | 51 |

Test Date: Apr. 14, 2022

| Items | Required | Actual |
|------------------|----------|---------|
| Temperature (°C) | 18-25 | 23.0± 2 |
| Humidity (%RH) | 30-70 | 49 |

USA : FCC Registration Number: TW0033
Canada : CAB Identifier Number: TW3023 / Company Number: 26930

Site Description : Accredited by TAF
Accredited Number: 3023

Test Laboratory : DEKRA Testing and Certification Co., Ltd
Address : No. 26, Huaya 1st Rd., Guishan Dist.,
Taoyuan City 333411, Taiwan, R.O.C.

Phone number : 886-3-275-7255
Fax number : 866-3-327-8031
Email address : info.tw@dekra.com
Website : <http://www.dekra.com.tw>

2. SAR Measurement System

2.1 DASY5 System Description

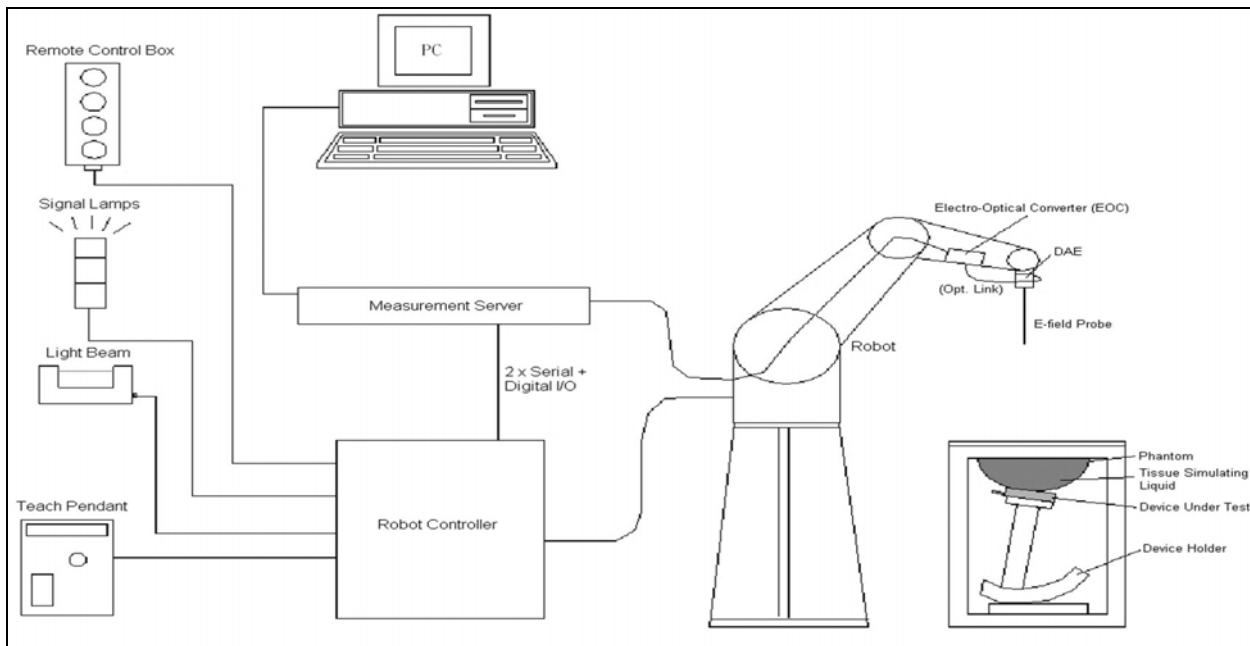

The DASY5 system for performing compliance tests consists of the following items:

- A standard high precision 6-axis robot with controller, teach pendant and software. An arm extension for accommodating the data acquisition electronics (DAE).
- A data acquisition electronics (DAE) which performs the signal amplification, signal multiplexing, AD-conversion, offset measurements, mechanical surface detection, collision detection, etc. The unit is battery powered with standard or rechargeable batteries. The signal is optically transmitted to the EOC.
- The Electro-optical converter (EOC) performs the conversion from optical to electrical signals for the digital communication to the DAE. To use optical surface detection, a special version of the EOC is required. The EOC signal is transmitted to the measurement server.
- The Light Beam used is for probe alignment. This improves the (absolute) accuracy of the probe positioning.
- A computer running WinXP and the DASY5 software.
- Remote control and teach pendant as well as additional circuitry for robot safety such as warning lamps, etc.
- The phantom, the device holder and other accessories according to the targeted measurement.

2.1.1 Applications

Predefined procedures and evaluations for automated compliance testing with all worldwide standards, e.g., IEEE 1528, OET 65, IEC 62209-1, IEC 62209-2, EN 50360, EN 50383 and others.

2.1.2 Area Scans

Area scans are defined prior to the measurement process being executed with a user defined variable spacing between each measurement point (integral) allowing low uncertainty measurements to be conducted. Scans defined for FCC applications utilize a 10mm² step integral, with 1mm interpolation used to locate the peak SAR area used for zoom scan assessments.

When an Area Scan has measured all reachable points, it computes the field maxima found in the scanned area, within a range of the global maximum. The range (in dB) is specified in the standards for compliance testing. For example, a 2 dB range is required in IEEE 1528-2013, EN 50361 and IEC 62209 standards, whereby 3 dB is a requirement when compliance is assessed in accordance with the ARIB standard (Japan).

2.1.3 Zoom Scan (Cube Scan Averaging)

Zoom Scans are used to assess the peak spatial SAR values within a cubic averaging volume containing 1 g and 10 g of simulated tissue. A density of 1000 kg/m³ is used to represent the head and body tissue density and not the phantom liquid density, in order to be consistent with the definition of the liquid dielectric properties, i.e. the side length of the 1 g cube is 10mm, with the side length of the 10 g cube 21,5mm.

The zoom scan integer steps can be user defined so as to reduce uncertainty, but normal practice for typical test applications (including FCC) utilize a physical step of 5x5x7 (8mmx8mmx5mm) providing a volume of 32mm in the X & Y axis, and 30mm in the Z axis.

2.1.4 Uncertainty of Inter-/Extrapolation and Averaging

In order to evaluate the uncertainty of the interpolation, extrapolation and averaged SAR calculation algorithms of the Postprocessor, DASY5 allows the generation of measurement grids which are artificially predefined by analytically based test functions. Therefore, the grids of area scans and zoom scans can be filled with uncertainty test data, according to the SAR benchmark functions of IEEE 1528. The three analytical functions shown in equations as below are used to describe the possible range of the expected SAR distributions for the tested handsets. The field gradients are covered by the spatially flat

distribution f1, the spatially steep distribution f3 and f2 accounts for H-field cancellation on the phantom/tissue surface.

$$f_1(x, y, z) = Ae^{-\frac{z}{2a}} \cos^2 \left(\frac{\pi \sqrt{x'^2 + y'^2}}{2 \cdot 5a} \right)$$

$$f_2(x, y, z) = Ae^{-\frac{z}{a}} \frac{a^2}{a^2 + x'^2} \left(3 - e^{-\frac{2z}{a}} \right) \cos^2 \left(\frac{\pi y'}{2 \cdot 3a} \right)$$

$$f_3(x, y, z) = A \frac{a^2}{\frac{a^2}{4} + x'^2 + y'^2} \left(e^{-\frac{2z}{a}} + \frac{a^2}{2(a + 2z)^2} \right)$$

2.2 DASY5 E-Field Probe

The SAR measurement is conducted with the dosimetric probe manufactured by SPEAG. The probe is specially designed and calibrated for use in liquid with high permittivity. The dosimetric probe has special calibration in liquid at different frequency.

SPEAG conducts the probe calibration in compliance with international and national standards (e.g. IEEE 1528, EN 62209-1, IEC 62209, etc.) under ISO 17025. The calibration data are in Appendix D.

2.2.1 Isotropic E-Field Probe Specification

| | | |
|----------------------|--|---|
| Model | Ex3DV4 | |
| Construction | Symmetrical design with triangular core Built-in shielding against static charges PEEK enclosure material (resistant to organic solvents, e.g., DGBE) | |
| Frequency | 10 MHz to 6 GHz Linearity: ± 0.2 dB (30 MHz to 6 GHz) |  |
| Directivity | ± 0.3 dB in HSL (rotation around probe axis) ± 0.5 dB in tissue material (rotation normal to probe axis) | |
| Dynamic Range | 10 µW/g to 100 mW/g Linearity: ± 0.2 dB (noise: typically < 1 µW/g) | |
| Dimensions | Overall length: 330 mm (Tip: 20 mm) Tip diameter: 2.5 mm (Body: 12 mm) Typical distance from probe tip to dipole centers: 1 mm | |
| Application | High precision dosimetric measurements in any exposure scenario (e.g., very strong gradient fields). Only probe which enables compliance testing for frequencies up to 6 GHz with precision of better 30%. | |

2.3 Boundary Detection Unit and Probe Mounting Device

The DASY probes use a precise connector and an additional holder for the probe, consisting of a plastic tube and a flexible silicon ring to center the probe. The connector at the DAE is flexibly mounted and held in the default position with magnets and springs. Two switching systems in the connector mount detect frontal and lateral probe collisions and trigger the necessary software response.

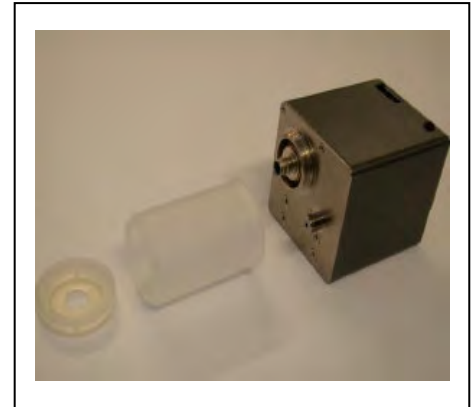

2.4 DATA Acquisition Electronics (DAE) and Measurement Server

The data acquisition electronics (DAE) consists of a highly sensitive electrometer-grade preamplifier with auto-zeroing, a channel and gain-switching multiplexer, a fast 16 bit AD-converter and a command decoder and control logic unit.

Transmission to the measurement server is accomplished through an optical downlink for data and status information as well as an optical uplink for commands and the clock.

The input impedance of the DAE4 is 200M Ohm; the inputs are symmetrical and floating. Common mode rejection is above 80dB.



The DASY5 measurement server is based on a PC/104 CPU board with a 400MHz Intel ULV Celeron, 128MB chipdisk and 128MB RAM. The necessary circuits for communication with the DAE electronics box, as well as the 16 bit AD converter system for optical detection and digital I/O interface are contained on the DASY5 I/O board, which is directly connected to the PC/104 bus of the CPU board.



2.5 Robot

The DASY5 system uses the high precision robots TX90 XL type out of the newer series from Stäubli SA (France). For the 6-axis controller DASY5 system, the CS8C robot controller version from Stäubli is used.

The XL robot series have many features that are important for our application:

- High precision (repeatability 0.02 mm)
- High reliability (industrial design)
- Jerk-free straight movements
- Low ELF interference (the closed metallic construction shields against motor control fields)
- 6-axis controller



2.6 Light Beam Unit

The light beam switch allows automatic "tooling" of the probe. During the process, the actual position of the probe tip with respect to the robot arm is measured, as well as the probe length and the horizontal probe offset. The software then corrects all movements, such that the robot coordinates are valid for the probe tip.

The repeatability of this process is better than 0.1 mm. If a position has been taught with an aligned probe, the same position will be reached with another aligned probe within 0.1 mm, even if the other probe has different dimensions. During probe rotations, the probe tip will keep its actual position.



2.7 Device Holder

The DASY5 device holder is designed to cope with different positions given in the standard. It has two scales for the device rotation (with respect to the body axis) and the device inclination (with respect to the line between the ear reference points). The rotation center for both scales is the ear reference point (EPR).

Thus the device needs no repositioning when changing the angles.

The DASY5 device holder has been made out of low-loss POM material having the following dielectric parameters: relative permittivity $\epsilon_r = 3$ and loss tangent $\delta = 0.02$. The amount of dielectric material has been reduced in the closest vicinity of the device, since measurements have suggested that the influence of the clamp on the test results could thus be lowered.



2.8 SAM Twin Phantom

The SAM twin phantom is a fiberglass shell phantom with 2mm shell thickness (except the ear region where shell thickness increases to 6mm). It has three measurement areas:

- Left head
- Right head
- Flat phantom



The bottom plate contains three pair of bolts for locking the device holder. The device holder positions are adjusted to the standard measurement positions in the three sections. A white cover is provided to tap the phantom during off-periods to prevent water evaporation and changes in the liquid parameters. On the phantom top, three reference markers are provided to identify the phantom position with respect to the robot.

3. Tissue Simulating Liquid

3.1 The composition of the tissue simulating liquid

| INGREDIENT (% Weight) | 2450MHz Head | 5GHz Head |
|--------------------------|-----------------|--------------|
| Water | 46.7 | 68.29 |
| Salt | 0.00 | 0.00 |
| Sugar | 0.00 | 0.00 |
| HEC | 0.00 | 0.00 |
| Preventol | 0.00 | 0.00 |
| DGBE | 53.3 | 2.44 |
| Triton X-100 | 0.00 | 29.27 |

3.2 Tissue Calibration Result

The dielectric parameters of the liquids were verified prior to the SAR evaluation using Dielectric Probe Kit and Vector Network Analyzer.

| Head Tissue Simulate Measurement | | | | |
|----------------------------------|------------------|-----------------------|----------------|----------------------|
| Frequency [MHz] | Description | Dielectric Parameters | | Tissue Temp. [°C] |
| | | ϵ_r | σ [s/m] | |
| 2450 MHz | Reference result | 39.2 | 1.8 | N/A |
| | ± 5% window | 37.24 to 41.16 | 1.71 to 1.89 | |
| | 13-Apr-22 | 39.49 | 1.78 | 21.9 |
| 2412 MHz | Channel 01 | 39.64 | 1.74 | 21.9 |
| 2437 MHz | Channel 06 | 39.54 | 1.77 | 21.9 |
| 2441 MHz | Channel 39 | 39.53 | 1.77 | 21.9 |
| 2462 MHz | Channel 11 | 39.45 | 1.81 | 21.9 |

| Head Tissue Simulate Measurement | | | | |
|----------------------------------|---------------------------------|-------------------------|----------------------|-------------------|
| Frequency [MHz] | Description | Dielectric Parameters | | Tissue Temp. [°C] |
| | | ϵ_r | σ [s/m] | |
| 5250 MHz | Reference result ± 5% window | 35.95 34.15 to 37.75 | 4.71 4.47 to 4.95 | N/A |
| | 14-Apr-22 | 35.85 | 4.61 | 22.2 |
| 5250 MHz | Channel 50 | 35.85 | 4.61 | 22.2 |

| Head Tissue Simulate Measurement | | | | |
|----------------------------------|---------------------------------|------------------------|----------------------|-------------------|
| Frequency [MHz] | Description | Dielectric Parameters | | Tissue Temp. [°C] |
| | | ϵ_r | σ [s/m] | |
| 5600 MHz | Reference result ± 5% window | 35.5 33.73 to 37.28 | 5.07 4.82 to 5.32 | N/A |
| | 14-Apr-22 | 34.88 | 5.09 | 22.2 |
| 5570 MHz | Channel 114 | 34.96 | 5.05 | 22.2 |
| 5690 MHz | Channel 138 | 34.64 | 5.21 | 22.2 |

| Head Tissue Simulate Measurement | | | | |
|----------------------------------|---------------------------------|------------------------|----------------------|-------------------|
| Frequency [MHz] | Description | Dielectric Parameters | | Tissue Temp. [°C] |
| | | ϵ_r | σ [s/m] | |
| 5800MHz | Reference result ± 5% window | 35.3 33.54 to 37.07 | 5.27 5.01 to 5.53 | N/A |
| | 14-Apr-22 | 34.33 | 5.34 | 22.2 |
| 5775 MHz | Channel 155 | 34.41 | 5.31 | 22.2 |

3.3 Tissue Dielectric Parameters for Head and Body Phantoms

The head tissue dielectric parameters recommended by the IEC 62209-1 have been incorporated in the following table. These head parameters are derived from planar layer models simulating the highest expected SAR for the dielectric properties and tissue thickness variations in a human head. Other head tissue parameters that have not been specified are interpolated according to the head parameters specified in IEC 62209-1

| Target Frequency (MHz) | Head | |
|---------------------------|--------------|----------------|
| | ϵ_r | σ (S/m) |
| 300 | 45.3 | 0.87 |
| 450 | 43.5 | 0.87 |
| 750 | 41.9 | 0.89 |
| 835 | 41.5 | 0.90 |
| 900 | 41.5 | 0.97 |
| 1450 | 40.5 | 1.20 |
| 1640 | 40.2 | 1.31 |
| 1750 | 40.1 | 1.37 |
| 1800 – 2000 | 40.0 | 1.40 |
| 2450 | 39.2 | 1.80 |
| 3000 | 38.5 | 2.40 |
| 5000 | 36.2 | 4.45 |
| 5200 | 36.0 | 4.66 |
| 5400 | 35.8 | 4.86 |
| 5600 | 35.3 | 5.27 |
| 5800 | 35.3 | 5.27 |
| 6000 | 35.1 | 5.48 |

(ϵ_r = relative permittivity, σ = conductivity and $\rho = 1000 \text{ kg/m}^3$)

4. SAR Measurement Procedure

4.1 SAR System Check

4.1.1 Dipoles

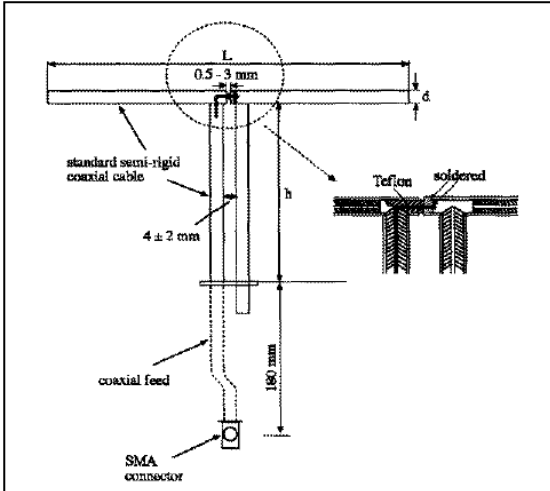

The dipoles used is based on the IEEE-1528 standard, and is complied with mechanical and electrical specifications in line with the requirements of both IEEE and FCC Supplement C. the table below provides details for the mechanical and electrical specifications for the dipoles.

| Frequency | L (mm) | h (mm) | d (mm) |
|---------------|--------|--------|--------|
| 2450MHz | 51.5 | 30.4 | 3.6 |
| 5200M~5800MHz | 20.6 | 40.3 | 3.6 |

4.1.2 System Check Result

| System Performance Check at 2450MHz Dipole Kit: D2450V2 | | | | |
|--|----------------------------------|------------------------|------------------------|-------------------|
| Frequency [MHz] | Description | SAR [w/kg] 1g | SAR [w/kg] 10g | Tissue Temp. [°C] |
| 2450 MHz | Reference result ± 10% window | 53.1 47.79 to 58.41 | 24.6 22.14 to 27.06 | N/A |
| | 13-Apr-22 | 56.8 | 26.16 | 21.9 |

Note: (1) The power level is used 250mW
 (2) All SAR values are normalized to 1W forward power.
 (3) The reference result is from Appendix E.

| System Performance Check at 5250MHz | | | | |
|---|----------------------------------|------------------------|------------------------|-------------------|
| Dipole Kit: D5GHzV2 | | | | |
| Frequency [MHz] | Description | SAR [w/kg] 1g | SAR [w/kg] 10g | Tissue Temp. [°C] |
| 5250 MHz | Reference result ± 10% window | 81.6 73.44 to 89.76 | 23.2 20.88 to 25.52 | N/A |
| | 14-Apr-22 | 79.7 | 22.9 | 22.2 |
| Note: (1) The power level is used 100mW (2) All SAR values are normalized to 1W forward power. (3) The reference result is from Appendix E. | | | | |

| System Performance Check at 5600MHz | | | | |
|---|----------------------------------|------------------------|------------------------|-------------------|
| Dipole Kit: D5GHzV2 | | | | |
| Frequency [MHz] | Description | SAR [w/kg] 1g | SAR [w/kg] 10g | Tissue Temp. [°C] |
| 5600 MHz | Reference result ± 10% window | 85.9 77.31 to 94.49 | 24.2 21.78 to 26.62 | N/A |
| | 14-Apr-22 | 84.2 | 23.9 | 22.2 |
| Note: (1) The power level is used 100mW (2) All SAR values are normalized to 1W forward power. (3) The reference result is from Appendix E. | | | | |

| System Performance Check at 5800MHz | | | | |
|---|----------------------------------|------------------------|------------------------|-------------------|
| Dipole Kit: D5GHzV2 | | | | |
| Frequency [MHz] | Description | SAR [w/kg] 1g | SAR [w/kg] 10g | Tissue Temp. [°C] |
| 5800 MHz | Reference result ± 10% window | 82.0 73.80 to 90.20 | 22.8 20.52 to 25.08 | N/A |
| | 14-Apr-22 | 81.7 | 23 | 22.2 |
| Note: (1) The power level is used 100mW (2) All SAR values are normalized to 1W forward power. (3) The reference result is from Appendix E. | | | | |

4.2 SAR Measurement Procedure

The Dasy5 calculates SAR using the following equation,

$$SAR = \frac{\sigma |E|^2}{\rho}$$

σ : represents the simulated tissue conductivity

ρ : represents the tissue density

The EUT is set to transmit at the required power in line with product specification, at each frequency relating to the LOW, MID, and HIGH channel settings.

Pre-scans are made on the device to establish the location for the transmitting antenna, using a large area scan in either air or tissue simulation fluid.

The EUT is placed against the Universal Phantom where the maximum area scan dimensions are larger than the physical size of the resonating antenna. When the scan size is not large enough to cover the peak SAR distribution, it is modified by either extending the area scan size in both the X and Y directions, or the device is shifted within the predefined area.

The area scan is then run to establish the peak SAR location (interpolated resolution set at 1mm^2) which is then used to orient the center of the zoom scan. The zoom scan is then executed and the 1g and 10g averages are derived from the zoom scan volume (interpolated resolution set at 1mm^3).

5. SAR Exposure Limits

SAR assessments have been made in line with the requirements of IEEE-1528, FCC Supplement C, and comply with ANSI/IEEE C95.1-1992 “Uncontrolled Environments” limits. These limits apply to a location which is deemed as “Uncontrolled Environment” which can be described as a situation where the general public may be exposed to an RF source with no prior knowledge or control over their exposure.

Limits for General Population/Uncontrolled Exposure (W/kg)

| Type Exposure | Uncontrolled Environment Limit |
|--|--------------------------------|
| Spatial Peak SAR (1g cube tissue for brain or body) | 1.60 W/kg |
| Spatial Average SAR (whole body) | 0.08 W/kg |
| Spatial Peak SAR (10g for hands, feet, ankles and wrist) | 4.00 W/kg |

6. Test Equipment List

| Instrument | Manufacturer | Model No. | Serial No. | Last Calibration | Next Calibration |
|-----------------------------|--------------|---------------|---------------|------------------|------------------|
| Reference Dipole 2450MHz | Speag | D2450V2 | 930 | 2019/11/21 | 2022/11/20 |
| Reference Dipole 5GHz | Speag | D5GHzV2 | 1041 | 2020/05/25 | 2023/05/24 |
| Device Holder | Speag | N/A | N/A | N/A | N/A |
| Data Acquisition Electronic | Speag | DAE4 | 1207 | 2021/11/22 | 2022/11/21 |
| E-Field Probe | Speag | EX3DV4 | 3698 | 2021/11/24 | 2022/11/23 |
| SAR Software | Speag | DASY52 | V52.10.0.1446 | N/A | N/A |
| Power Amplifier | Mini-Circuit | ZVE-8G | 541100241 | N/A | N/A |
| Directional Coupler | Agilent | 87300C | MY44300353 | N/A | N/A ¹ |
| Attenuator | Woken | WATT-218FS-10 | N/A | N/A | N/A ¹ |
| Attenuator | Mini-Circuit | BW-S20W2+ | N/A | N/A | N/A ¹ |
| Vector Network Analyzer | Keysight | E5071C | MY46106342 | 2021/10/18 | 2022/10/17 |
| Signal Generator | Anritsu | MG3694A | 041902 | 2021/08/26 | 2022/08/25 |
| Power Meter | Anritsu | ML2487A | 6K00001447 | 2021/11/02 | 2022/11/01 |
| Power Sensor | Anritsu | MA2411B | 1339194 | 2021/11/02 | 2022/11/01 |

Note: 1. System Check, the path loss measured by the network analyzer, includes the signal generator, amplifier, cable, attenuator and directional coupler.

Note:

Per KDB 865664 D01 requirements for dipole calibration, the following are recommended FCC procedures for SAR dipole calibration.

1. After a dipole is damaged and properly repaired to meet required specifications.
2. When the measured SAR deviates from the calibrated SAR value by more than 10% due to changes in physical, mechanical, electrical or other relevant dipole conditions.
3. When the most recent return-loss, measured at least annually, deviates by more than 20% from the previous measurement (i.e. 0.2 of the dB value) or not meeting the required -20 dB return-loss specification.

| | Frequency | Tissue | Return loss | Limit | Verified Date |
|-------------|-----------|--------|-------------|------------|---------------|
| Calibration | 2450 | Head | -25.2 dB | Within 20% | 2019/11/21 |
| Measurement | 2450 | Head | -24.77 dB | | 2020/11/18 |
| Measurement | 2450 | Head | -25.29 dB | | 2021/11/16 |

| | Frequency | Tissue | Return loss | Limit | Verified Date |
|-------------|-----------|--------|-------------|------------|---------------|
| Calibration | 5250 | Head | -26.9 dB | Within 20% | 2020/5/25 |
| Measurement | 5250 | Head | -24.16 dB | | 2021/5/18 |

| | Frequency | Tissue | Return loss | Limit | Verified Date |
|-------------|-----------|--------|-------------|------------|---------------|
| Calibration | 5600 | Head | -24.4 dB | Within 20% | 2020/5/25 |
| Measurement | 5600 | Head | -27.05 dB | | 2021/5/18 |

| | Frequency | Tissue | Return loss | Limit | Verified Date |
|-------------|-----------|--------|-------------|------------|---------------|
| Calibration | 5800 | Head | -26.8 dB | Within 20% | 2020/5/25 |
| Measurement | 5800 | Head | -25.64 dB | | 2021/5/18 |

4. When the most recent measurement of the real or imaginary parts of the impedance, measured at least annually, deviates by more than 5Ω from the previous measurement.

| | Frequency | Tissue | Impedance | Limit | Verified Date |
|-------------|-----------|--------|-----------|-------------------|---------------|
| Calibration | 2450 | Head | 54.4 dB | Within 5Ω | 2019/11/21 |
| Measurement | 2450 | Head | 56.58 dB | | 2020/11/18 |
| Measurement | 2450 | Head | 55.9 dB | | 2021/11/16 |

| | Frequency | Tissue | Return loss | Limit | Verified Date |
|-------------|-----------|--------|-------------|-------------------|---------------|
| Calibration | 5250 | Head | 49.0 dB | Within 5Ω | 2020/5/25 |
| Measurement | 5250 | Head | 45.54 dB | | 2021/5/18 |

| | Frequency | Tissue | Return loss | Limit | Verified Date |
|-------------|-----------|--------|-------------|-------------------|---------------|
| Calibration | 5600 | Head | 56.3 dB | Within 5Ω | 2020/5/25 |
| Measurement | 5600 | Head | 52.24 dB | | 2021/5/18 |

| | Frequency | Tissue | Return loss | Limit | Verified Date |
|-------------|-----------|--------|-------------|-------------------|---------------|
| Calibration | 5800 | Head | 54.3 dB | Within 5Ω | 2020/5/25 |
| Measurement | 5800 | Head | 49.85 dB | | 2021/5/18 |

7. Measurement Uncertainty

| Measurement uncertainty for 30 MHz to 3 GHz | | | | | | | | |
|---|---------------|-------------|------|---------|----------|----------------|-----------------|-----------------------|
| Error Description | Uncert. value | Prob. Dist. | Div. | (ci) 1g | (ci) 10g | Std. Unc. (1g) | Std. Unc. (10g) | (vi) V _{eff} |
| Measurement System | | | | | | | | |
| Probe Calibration | ±6% | N | 1 | 1 | 1 | ±6.0% | ±6.0% | ∞ |
| Axial Isotropy | ±4.7% | R | √3 | 0.7 | 0.7 | ±1.9% | ±1.9% | ∞ |
| Hemispherical Isotropy | ±9.6% | R | √3 | 0.7 | 0.7 | ±3.9% | ±3.9% | ∞ |
| Boundary Effects | ±1.0% | R | √3 | 1 | 1 | ±0.6% | ±0.6% | ∞ |
| Linearity | ±4.7% | R | √3 | 1 | 1 | ±2.7% | ±2.7% | ∞ |
| System Detection Limits | ±1.0% | R | √3 | 1 | 1 | ±0.6% | ±0.6% | ∞ |
| Modulation Response | ±2.4% | R | √3 | 1 | 1 | ±1.4% | ±1.4% | ∞ |
| Readout Electronics | ±0.3% | N | 1 | 1 | 1 | ±0.3% | ±0.3% | ∞ |
| Response Time | ±0.8% | R | √3 | 1 | 1 | ±0.5% | ±0.5% | ∞ |
| Integration Time | ±2.6% | R | √3 | 1 | 1 | ±1.5% | ±1.5% | ∞ |
| RF Ambient Noise | ±3.0% | R | √3 | 1 | 1 | ±1.7% | ±1.7% | ∞ |
| RF Ambient Reflections | ±3.0% | R | √3 | 1 | 1 | ±1.7% | ±1.7% | ∞ |
| Probe Positioner | ±0.4% | R | √3 | 1 | 1 | ±0.2% | ±0.2% | ∞ |
| Probe Positioning | ±2.9% | R | √3 | 1 | 1 | ±1.7% | ±1.7% | ∞ |
| Max. SAR Eval. | ±4.0% | R | √3 | 1 | 1 | ±1.2% | ±1.2% | ∞ |
| Test Sample Related | | | | | | | | |
| Device Positioning | ±2.9% | N | 1 | 1 | 1 | ±2.9% | ±2.9% | 145 |
| Device Holder | ±3.6% | N | 1 | 1 | 1 | ±3.6% | ±3.6% | 5 |
| Power Drift | ±5.0% | R | √3 | 1 | 1 | ±2.9% | ±2.9% | ∞ |
| Power Scaling | ±0% | R | √3 | 1 | 1 | ±0.0% | ±0.0% | |
| Phantom and Setup | | | | | | | | |
| Phantom Uncertainty | ±6.1% | R | √3 | 1 | 1 | ±3.5% | ±3.5% | ∞ |
| SAR correction | ±1.9% | R | √3 | 1 | 0.84 | ±1.1% | ±0.9% | ∞ |
| Liquid Conductivity (meas.) | ±2.5% | R | √3 | 0.78 | 0.71 | ±1.1% | ±1.0% | ∞ |
| Liquid Permittivity (meas.) | ±2.5% | R | √3 | 0.26 | 0.26 | ±0.3% | ±0.4% | ∞ |
| Temp. unc. - Conductivity | ±3.4% | R | √3 | 0.78 | 0.71 | ±1.5% | ±1.4% | ∞ |
| Temp. unc. - Permittivity | ±0.4% | R | √3 | 0.23 | 0.26 | ±0.1% | ±0.1% | ∞ |
| Combined Std. Uncertainty | | | | | | ±11.2% | ±11.1% | 361 |
| Expanded STD Uncertainty | | | | | | ±22.3% | ±22.2% | |

| Measurement uncertainty for 3GHz to 6 GHz | | | | | | | | |
|---|---------------|-------------|------|---------|----------|----------------|-----------------|-----------------------|
| Error Description | Uncert. value | Prob. Dist. | Div. | (ci) 1g | (ci) 10g | Std. Unc. (1g) | Std. Unc. (10g) | (vi) V _{eff} |
| Measurement System | | | | | | | | |
| Probe Calibration | ±6.55% | N | 1 | 1 | 1 | ±6.55% | ±6.55% | ∞ |
| Axial Isotropy | ±4.7% | R | √3 | 0.7 | 0.7 | ±1.9% | ±1.9% | ∞ |
| Hemispherical Isotropy | ±9.6% | R | √3 | 0.7 | 0.7 | ±3.9% | ±3.9% | ∞ |
| Boundary Effects | ±2.0% | R | √3 | 1 | 1 | ±1.2% | ±1.2% | ∞ |
| Linearity | ±4.7% | R | √3 | 1 | 1 | ±2.7% | ±2.7% | ∞ |
| System Detection Limits | ±1.0% | R | √3 | 1 | 1 | ±0.6% | ±0.6% | ∞ |
| Modulation Response | ±2.4% | R | √3 | 1 | 1 | ±1.4% | ±1.4% | ∞ |
| Readout Electronics | ±0.3% | N | 1 | 1 | 1 | ±0.3% | ±0.3% | ∞ |
| Response Time | ±0.8% | R | √3 | 1 | 1 | ±0.5% | ±0.5% | ∞ |
| Integration Time | ±2.6% | R | √3 | 1 | 1 | ±1.5% | ±1.5% | ∞ |
| RF Ambient Noise | ±3.0% | R | √3 | 1 | 1 | ±1.7% | ±1.7% | ∞ |
| RF Ambient Reflections | ±3.0% | R | √3 | 1 | 1 | ±1.7% | ±1.7% | ∞ |
| Probe Positioner | ±0.8% | R | √3 | 1 | 1 | ±0.5% | ±0.5% | ∞ |
| Probe Positioning | ±6.7% | R | √3 | 1 | 1 | ±3.9% | ±3.9% | ∞ |
| Post-processing | ±4.0% | R | √3 | 1 | 1 | ±2.3% | ±2.3% | ∞ |
| Test Sample Related | | | | | | | | |
| Device Positioning | ±2.9% | N | 1 | 1 | 1 | ±2.9% | ±2.9% | 145 |
| Device Holder | ±3.6% | N | 1 | 1 | 1 | ±3.6% | ±3.6% | 5 |
| Power Drift | ±5.0% | R | √3 | 1 | 1 | ±2.9% | ±2.9% | ∞ |
| Power Scaling | ±0% | R | √3 | 1 | 1 | ±0.0% | ±0.0% | |
| Phantom and Setup | | | | | | | | |
| Phantom Uncertainty | ±6.6% | R | √3 | 1 | 1 | ±3.8% | ±3.8% | ∞ |
| SAR correction | ±1.9% | R | √3 | 1 | 1 | ±1.1% | ±0.9% | ∞ |
| Liquid Conductivity (meas.) | ±2.5% | R | √3 | 1 | 0.84 | ±1.1% | ±1.0% | ∞ |
| Liquid Permittivity (meas.) | ±2.5% | R | √3 | 0.26 | 0.26 | ±0.3% | ±0.4% | ∞ |
| Temp. unc. - Conductivity | ±3.4% | R | √3 | 0.78 | 0.71 | ±1.5% | ±1.4% | ∞ |
| Temp. unc. - Permittivity | ±0.4% | R | √3 | 0.23 | 0.26 | ±0.1% | ±0.1% | ∞ |
| Combined Std. Uncertainty | | | | | | ±12.3% | ±12.2% | 748 |
| Expanded STD Uncertainty | | | | | | ±24.6% | ±24.5% | |

8. Conducted Power Measurement (Including tolerance allowed for production unit)

| WLAN 2.4G 2TX SISO | | | | | | | | | |
|--|-------------|------------|----|----------------|----------|-----------|---------------|----------|-----------|
| | Frequency | Mode | BW | SISO-Main(TX1) | | | SISO-Aux(TX2) | | |
| | | | | CH | AV Power | AV Target | CH | AV Power | AV Target |
| DSSS/OFDM mode specified maximum output power at an antenna port | WLAN 2.4GHz | b | 20 | 1 | 17.48 | 18 | 1 | 17.83 | 18 |
| | | | | 6 | 17.96 | 18 | 6 | 17.85 | 18 |
| | | | | 11 | 17.50 | 18 | 11 | 17.82 | 18 |
| | | | | 12 | 17.20 | 18 | 12 | 17.45 | 18 |
| | | | | 13 | 16.62 | 18 | 13 | 17.37 | 18 |
| | | g | 20 | 1 | 16.41 | 17 | 1 | 16.36 | 17 |
| | | | | 6 | 17.34 | 18 | 6 | 17.42 | 18 |
| | | | | 11 | 16.91 | 17.5 | 11 | 16.74 | 17.5 |
| | | | | 12 | 14.83 | 15.5 | 12 | 14.46 | 15 |
| | | | | 13 | 12.01 | 12.5 | 13 | 12.22 | 12.5 |
| | | n (HT) | 20 | 1 | 16.38 | 17 | 1 | 16.25 | 17 |
| | | | | 6 | 17.26 | 18 | 6 | 17.35 | 18 |
| | | | | 11 | 15.47 | 16 | 11 | 15.94 | 16.5 |
| | | | | 12 | 14.76 | 15.5 | 12 | 14.89 | 15 |
| | | | | 13 | 11.72 | 12 | 13 | 12.58 | 13 |
| | | | 40 | 3 | 16.94 | 17.5 | 3 | 16.48 | 17 |
| | | | | 6 | 17.36 | 18 | 6 | 15.43 | 16 |
| | | | | 9 | 15.32 | 16 | 9 | 15.49 | 16 |
| | | | | 10 | 11.88 | 12.5 | 10 | 11.80 | 12.5 |
| | | | | 11 | 11.99 | 12.5 | 11 | 11.91 | 12.5 |
| | | ax (HE) | 20 | 1 | 17.00 | 17.5 | 1 | 16.92 | 17.5 |
| | | | | 6 | 17.49 | 18 | 6 | 17.39 | 18 |
| | | | | 11 | 15.31 | 16 | 11 | 15.44 | 16 |
| | | | | 12 | 14.87 | 15.5 | 12 | 14.72 | 15.5 |
| | | | | 13 | 9.81 | 10.5 | 13 | 11.41 | 12 |
| | | | 40 | 3 | 15.98 | 16.5 | 3 | 15.75 | 16.5 |
| | | | | 6 | 16.38 | 16.5 | 6 | 15.24 | 16 |
| | | | | 9 | 15.41 | 16 | 9 | 15.26 | 16 |
| 10 | 11.72 | | | 12.5 | 10 | 11.32 | 12 | | |
| 11 | 11.92 | | | 12.5 | 11 | 12.49 | 13 | | |

| WLAN 5G 2TX SISO | | | | | | | | | | | | | | | | | | |
|---|----------------------------|-----------|-------|----------------|----------|-----------|---------------|----------|-----------|----------------------------|-----------|-------|----------------|----------|-----------|---------------|----------|-----------|
| OFDM mode specified maximum output power at an antenna port | Frequency | Mode | BW | SISO-Main(TX1) | | | SISO-Aux(TX2) | | | Frequency | Mode | BW | SISO-Main(TX1) | | | SISO-Aux(TX2) | | |
| | | | | CH | AV Power | AV Target | CH | AV Power | AV Target | | | | CH | AV Power | AV Target | CH | AV Power | AV Target |
| | | | | | | | | | | | | | | | | | | |
| OFDM mode specified maximum output power at an antenna port | U-NII-1 (5150~5250MHz) | a | 20 | 36 | 11.77 | 12.5 | 36 | 11.74 | 12.5 | U-NII-2C (5470~5725MHz) | a | 20 | 100 | 11.73 | 12.5 | 100 | 11.74 | 12.5 |
| | | | | 40 | 11.74 | 12.5 | 40 | 11.67 | 12.5 | | | | 112 | 11.74 | 12.5 | 112 | 11.82 | 12.5 |
| | | | | 44 | 11.74 | 12.5 | 44 | 11.79 | 12.5 | | | | 116 | 11.75 | 12.5 | 116 | 11.73 | 12.5 |
| | | | | 48 | 11.71 | 12.5 | 48 | 11.91 | 12.5 | | | | 128 | 11.73 | 12.5 | 128 | 11.95 | 12.5 |
| | | n (HT) | 20 | 36 | 11.71 | 12.5 | 36 | 11.79 | 12.5 | | n (HT) | 20 | 100 | 11.76 | 12.5 | 100 | 11.78 | 12.5 |
| | | | | 40 | 11.72 | 12.5 | 40 | 11.78 | 12.5 | | | | 112 | 11.75 | 12.5 | 112 | 11.89 | 12.5 |
| | | | | 44 | 11.68 | 12.5 | 44 | 11.89 | 12.5 | | | | 116 | 11.75 | 12.5 | 116 | 11.71 | 12.5 |
| | | | | 48 | 11.67 | 12.5 | 48 | 11.98 | 12.5 | | | | 128 | 11.79 | 12.5 | 128 | 11.91 | 12.5 |
| | | ac(VHT) | 80 | 38 | 11.77 | 12.5 | 38 | 11.91 | 12.5 | | ac(VHT) | 80 | 102 | 11.68 | 12.5 | 102 | 11.71 | 12.5 |
| | | | | 46 | 11.76 | 12.5 | 46 | 11.97 | 12.5 | | | | 110 | 11.73 | 12.5 | 110 | 11.73 | 12.5 |
| | | | | 36 | 11.73 | 12.5 | 36 | 11.76 | 12.5 | | | | 118 | 11.79 | 12.5 | 118 | 11.81 | 12.5 |
| | | | | 40 | 11.75 | 12.5 | 40 | 11.81 | 12.5 | | | | 126 | 11.74 | 12.5 | 126 | 11.84 | 12.5 |
| | ax (HE) | 20 | 44 | 11.72 | 12.5 | 44 | 11.94 | 12.5 | ax(HE) | 40 | 126 | 11.74 | 12.5 | 126 | 11.84 | 12.5 | | |
| | | | 48 | 11.71 | 12.5 | 48 | 11.91 | 12.5 | | | 134 | 11.67 | 12.5 | 134 | 11.77 | 12.5 | | |
| | | | 38 | 11.71 | 12.5 | 38 | 11.87 | 12.5 | | | 20 | 144 | 11.76 | 12.5 | 144 | 11.73 | 12.5 | |
| | | | 46 | 11.75 | 12.5 | 46 | 11.91 | 12.5 | | | 40 | 142 | 11.77 | 12.5 | 142 | 11.73 | 12.5 | |
| | ax (HE) | 40 | 42 | 11.74 | 12.5 | 42 | 11.87 | 12.5 | ax(VHT) | 80 | 138 | 12.41 | 12.5 | 138 | 12.42 | 12.5 | | |
| | | | 52 | 11.77 | 12.5 | 52 | 11.93 | 12.5 | | | 106 | 11.72 | 12.5 | 106 | 11.76 | 12.5 | | |
| | | | 56 | 11.74 | 12.5 | 56 | 11.87 | 12.5 | | | 122 | 11.77 | 12.5 | 122 | 11.88 | 12.5 | | |
| | | | 60 | 11.74 | 12.5 | 60 | 11.85 | 12.5 | | | 160 | 114 | 12.48 | 12.5 | 114 | 12.47 | 12.5 | |
| | U-NII-2A (5250~5350MHz) | a | 20 | 64 | 11.69 | 12.5 | 64 | 11.86 | 12.5 | U-NII-3 (5725~5850MHz) | a | 20 | 100 | 11.75 | 12.5 | 100 | 11.71 | 12.5 |
| | | | | 52 | 11.76 | 12.5 | 52 | 11.99 | 12.5 | | | | 112 | 11.77 | 12.5 | 112 | 11.75 | 12.5 |
| | | | | 56 | 11.71 | 12.5 | 56 | 11.93 | 12.5 | | | | 116 | 11.75 | 12.5 | 116 | 11.74 | 12.5 |
| | | | | 60 | 11.66 | 12.5 | 60 | 11.91 | 12.5 | | | | 128 | 11.71 | 12.5 | 128 | 11.89 | 12.5 |
| n (HT) | | 20 | 64 | 11.64 | 12.5 | 64 | 11.85 | 12.5 | ax(HE) | | 40 | 132 | 11.71 | 12.5 | 132 | 11.96 | 12.5 | |
| | | | 54 | 11.71 | 12.5 | 54 | 11.93 | 12.5 | | | | 144 | 11.73 | 12.5 | 144 | 11.72 | 12.5 | |
| | | | 62 | 11.76 | 12.5 | 62 | 11.88 | 12.5 | | | | 102 | 11.68 | 12.5 | 102 | 11.92 | 12.5 | |
| | | | 80 | 11.78 | 12.5 | 80 | 11.82 | 12.5 | | | | 110 | 11.75 | 12.5 | 110 | 11.98 | 12.5 | |
| ac (VHT) | | 160 | 50 | 12.47 | 12.5 | 50 | 12.46 | 12.5 | ax(HE) | | 40 | 118 | 11.77 | 12.5 | 118 | 11.89 | 12.5 | |
| | | | 52 | 11.72 | 12.5 | 52 | 11.86 | 12.5 | | | | 126 | 11.71 | 12.5 | 126 | 11.85 | 12.5 | |
| | | | 56 | 11.77 | 12.5 | 56 | 11.89 | 12.5 | | | | 134 | 11.76 | 12.5 | 134 | 11.82 | 12.5 | |
| | | | 60 | 11.75 | 12.5 | 60 | 11.81 | 12.5 | | | | 142 | 11.71 | 12.5 | 142 | 11.75 | 12.5 | |
| ax (HE) | 20 | 64 | 11.72 | 12.5 | 64 | 11.76 | 12.5 | ax(HE) | 80 | 106 | 11.71 | 12.5 | 106 | 11.93 | 12.5 | | | |
| | | 54 | 11.78 | 12.5 | 54 | 11.82 | 12.5 | | | 122 | 11.77 | 12.5 | 122 | 11.92 | 12.5 | | | |
| | | 62 | 11.75 | 12.5 | 62 | 11.87 | 12.5 | | | 160 | 114 | 11.79 | 12.5 | 114 | 11.84 | 12.5 | | |
| | | 80 | 11.77 | 12.5 | 80 | 11.85 | 12.5 | | | 20 | 149 | 11.68 | 12.5 | 149 | 11.79 | 12.5 | | |
| ax (HE) | 40 | 80 | 11.77 | 12.5 | 80 | 11.85 | 12.5 | ax(HE) | 80 | 157 | 11.76 | 12.5 | 157 | 11.93 | 12.5 | | | |
| | | 160 | 50 | 11.74 | 12.5 | 50 | 11.95 | | | 12.5 | 165 | 11.79 | 12.5 | 165 | 11.86 | 12.5 | | |
| | | 149 | 11.77 | 12.5 | 149 | 11.73 | 12.5 | | | 20 | 149 | 11.67 | 12.5 | 149 | 11.73 | 12.5 | | |
| | | 157 | 11.67 | 12.5 | 157 | 11.97 | 12.5 | | | 40 | 151 | 11.67 | 12.5 | 151 | 11.78 | 12.5 | | |
| ax (HE) | 80 | 165 | 11.79 | 12.5 | 165 | 11.89 | 12.5 | ax(HE) | 80 | 155 | 11.73 | 12.5 | 155 | 11.92 | 12.5 | | | |
| | | 151 | 11.67 | 12.5 | 151 | 11.78 | 12.5 | | | 149 | 11.67 | 12.5 | 149 | 11.96 | 12.5 | | | |
| | | 159 | 11.73 | 12.5 | 159 | 11.92 | 12.5 | | | 20 | 157 | 11.73 | 12.5 | 157 | 11.86 | 12.5 | | |
| | | 155 | 12.42 | 12.5 | 155 | 12.43 | 12.5 | | | 40 | 165 | 11.74 | 12.5 | 165 | 11.89 | 12.5 | | |
| ax (HE) | 80 | 149 | 11.67 | 12.5 | 149 | 11.96 | 12.5 | ax(HE) | 80 | 151 | 11.74 | 12.5 | 151 | 11.86 | 12.5 | | | |
| | | 157 | 11.73 | 12.5 | 157 | 11.86 | 12.5 | | | 159 | 11.79 | 12.5 | 159 | 11.86 | 12.5 | | | |
| | | 165 | 11.74 | 12.5 | 165 | 11.89 | 12.5 | | | 138 | 11.74 | 12.5 | 138 | 11.94 | 12.5 | | | |
| | | 151 | 11.74 | 12.5 | 151 | 11.86 | 12.5 | | | 155 | 11.71 | 12.5 | 155 | 11.83 | 12.5 | | | |
| ax (HE) | 80 | 159 | 11.79 | 12.5 | 159 | 11.86 | 12.5 | ax(HE) | 80 | 138 | 11.74 | 12.5 | 138 | 11.94 | 12.5 | | | |
| | | 155 | 11.71 | 12.5 | 155 | 11.83 | 12.5 | | | 155 | 11.71 | 12.5 | 155 | 11.83 | 12.5 | | | |

| BT Only Support Aux | | | | | | | | | |
|-------------------------------------|-----------|------|------------|----------------|----------|-----------|---------------|----------|-----------|
| Bluetooth mode maximum output power | Frequency | Mode | Modulation | SISO-Main(TX1) | | | SISO-Aux(TX2) | | |
| | | | | CH | AV Power | AV Target | CH | AV Power | AV Target |
| | BT 2.4GHz | BR | GFSK | 0 | N/A | N/A | 0 | 8.21 | 9.0 |
| | | | | 39 | N/A | N/A | 39 | 8.49 | 9.0 |
| | | | | 78 | N/A | N/A | 78 | 8.33 | 9.0 |
| | | EDR | 8DPSK | 0 | N/A | N/A | 0 | 7.68 | 8.5 |
| | | | | 39 | N/A | N/A | 39 | 7.57 | 8.5 |
| | | | | 78 | N/A | N/A | 78 | 7.34 | 8.5 |
| | | BLE | GFSK | 0 | N/A | N/A | 0 | 6.49 | 7.0 |
| | | | | 19 | N/A | N/A | 19 | 6.56 | 7.0 |
| | | | | 39 | N/A | N/A | 39 | 6.45 | 7.0 |

9. Test Results

9.1 SAR Test Results Summary

| SAR MEASUREMENT | | | | | | | | | |
|---|------------------|-----------|-----------|------|------------------------------|---------------|---------------|----------------|----------|
| Liquid Temperature (°C) : 21.9 ±2 | | | | | Relative Humidity (%) : 51 % | | | | |
| Ambient Temperature (°C) : 22.9 ±2 | | | | | Depth of Liquid (cm) : >15 | | | | |
| Test Position | Antenna Position | Dist (mm) | Frequency | | Conducted Power (dBm) | | SAR 1g (W/kg) | | Plot No. |
| | | | Channel | MHz | Measurement | Tune-up Limit | Measurement | Tune-up Scaled | |
| Test Mode: 802.11b(AX201NGW)_Main_High-Tek | | | | | | | | | |
| Bottom | Fixed | 0 | 6 | 2437 | 17.96 | 18 | 0.282 | 0.285 | |
| Test Mode: 802.11b(AX201NGW)_Main_SOUTHSTAR | | | | | | | | | |
| Bottom | Fixed | 0 | 6 | 2437 | 17.96 | 18 | 0.402 | 0.406 | |
| Test Mode: 802.11b(AX201NGW)_Aux_High-Tek | | | | | | | | | |
| Bottom | Fixed | 0 | 1 | 2412 | 17.83 | 18 | 0.358 | 0.372 | |
| Bottom | Fixed | 0 | 6 | 2437 | 17.85 | 18 | 0.378 | 0.391 | |
| Bottom | Fixed | 0 | 11 | 2462 | 17.82 | 18 | 0.433 | 0.451 | |
| Test Mode : 802.11b(AX201NGW)_Aux_SOUTHSTAR | | | | | | | | | |
| Bottom | Fixed | 0 | 1 | 2412 | 17.83 | 18 | 0.543 | 0.565 | |
| Bottom | Fixed | 0 | 6 | 2437 | 17.85 | 18 | 0.621 | 0.643 | 1 |
| Bottom | Fixed | 0 | 11 | 2462 | 17.82 | 18 | 0.569 | 0.593 | |
| Test Mode : BT-1M(AX201NGW)_Aux_High-Tek | | | | | | | | | |
| Bottom | Fixed | 0 | 39 | 2441 | 8.49 | 9 | 0.071 | 0.080 | |
| Test Mode : BT-1M(AX201NGW)_Aux_SOUTHSTAR | | | | | | | | | |
| Bottom | Fixed | 0 | 39 | 2441 | 8.49 | 9 | 0.107 | 0.120 | 2 |
| <p>Note : 1. When the highest reported SAR for DSSS is adjusted by the ratio of OFDM to DSSS specified maximum output power and the adjusted SAR is ≤ 1.2 W/kg, SAR is not required.</p> <p>2. When the reported SAR of the highest measured maximum output power channel for the exposure configuration is ≤ 0.8 W/kg, no further SAR testing is required for 802.11b DSSS in that exposure configuration.</p> | | | | | | | | | |

| SAR MEASUREMENT | | | | | | | | | |
|--|------------------|-----------|-----------|------|------------------------------|---------------|---------------|----------------|----------|
| Liquid Temperature (°C) : 22.2 ±2 | | | | | Relative Humidity (%) : 49 % | | | | |
| Ambient Temperature (°C) : 23.0 ±2 | | | | | Depth of Liquid (cm) : >15 | | | | |
| Test Position | Antenna Position | Dist (mm) | Frequency | | Conducted Power (dBm) | | SAR 1g (W/kg) | | Plot No. |
| | | | Channel | MHz | Measurement | Tune-up Limit | Measurement | Tune-up Scaled | |
| Test Mode: 802.11ac80M(AX201NGW)_Main_High-Tek | | | | | | | | | |
| Bottom | Fixed | 0 | 138 | 5690 | 12.41 | 12.5 | 0.403 | 0.411 | |
| Bottom | Fixed | 0 | 155 | 5775 | 12.42 | 12.5 | 0.316 | 0.322 | |
| Test Mode: 802.11ac80M(AX201NGW)_Main_SOUTHSTAR | | | | | | | | | |
| Bottom | Fixed | 0 | 138 | 5690 | 12.41 | 12.5 | 0.513 | 0.524 | |
| Bottom | Fixed | 0 | 155 | 5775 | 12.42 | 12.5 | 0.300 | 0.306 | |
| Test Mode: 802.11ac160M(AX201NGW)_Main_High-Tek | | | | | | | | | |
| Bottom | Fixed | 0 | 50 | 5250 | 12.47 | 12.5 | 0.562 | 0.566 | |
| Bottom | Fixed | 0 | 114 | 5570 | 12.48 | 12.5 | 0.453 | 0.455 | |
| Test Mode: 802.11ac160M(AX201NGW)_Main_SOUTHSTAR | | | | | | | | | |
| Bottom | Fixed | 0 | 50 | 5250 | 12.47 | 12.5 | 0.762 | 0.767 | 3 |
| Bottom | Fixed | 0 | 114 | 5570 | 12.48 | 12.5 | 0.619 | 0.622 | 4 |
| Test Mode: 802.11ac80M(AX201NGW)_Aux_High-Tek | | | | | | | | | |
| Bottom | Fixed | 0 | 138 | 5690 | 12.42 | 12.5 | 0.535 | 0.545 | |
| Bottom | Fixed | 0 | 155 | 5775 | 12.43 | 12.5 | 0.470 | 0.478 | 5 |
| Test Mode: 802.11ac80M(AX201NGW)_Aux_SOUTHSTAR | | | | | | | | | |
| Bottom | Fixed | 0 | 138 | 5690 | 12.42 | 12.5 | 0.347 | 0.353 | |
| Bottom | Fixed | 0 | 155 | 5775 | 12.43 | 12.5 | 0.331 | 0.336 | |
| Test Mode: 802.11ac160M(AX201NGW)_Aux_High-Tek | | | | | | | | | |
| Bottom | Fixed | 0 | 50 | 5250 | 12.46 | 12.5 | 0.600 | 0.606 | |
| Bottom | Fixed | 0 | 114 | 5570 | 12.47 | 12.5 | 0.553 | 0.557 | |
| Test Mode: 802.11ac160M(AX201NGW)_Aux_SOUTHSTAR | | | | | | | | | |
| Bottom | Fixed | 0 | 50 | 5250 | 12.46 | 12.5 | 0.392 | 0.396 | |
| Bottom | Fixed | 0 | 114 | 5570 | 12.47 | 12.5 | 0.454 | 0.457 | |
| Note : 1. When multiple transmission modes have the same specified maximum output power, largest channel bandwidth, lowest order modulation and lowest data rate, the lowest order 802.11 mode is selected. 2. When the reported SAR of the highest measured maximum output power channel for the exposure configuration is ≤ 0.8 W/kg, no further SAR testing is required in that exposure configuration. 3. When the reported SAR of the highest measured maximum U-NII-2A for the exposure configuration is ≤ 1.2 W/kg, SAR is not required for U-NII-1 band. | | | | | | | | | |

9.2 Simultaneous Transmission

| Simultaneous Transmission Configurations | |
|--|---|
| 1 | WLAN 2.4GHz Main + WLAN 2.4GHz Aux |
| 2 | WLAN 2.4GHz Main + BT Aux |
| 3 | WLAN 5GHz Main + BT Aux |
| 4 | WLAN 5GHz Main + WLAN 5GHz Aux |
| 5 | WLAN 5GHz Main + WLAN 5GHz Aux + BT Aux |

9.2.1 Simultaneous transmission of MIMO in 802.11 test exclusion considerations

| Antenna : High-Tek | | | | | | |
|--------------------|----------------------|----------------------|---------------------|----------------------------------|--------------------|--------------------------------|
| Frequency (GHz) | Test Position (Body) | WLAN Main SAR (W/Kg) | WLAN Aux SAR (W/Kg) | Simultaneous Transmission (W/Kg) | Antenna pair in mm | Peak location separation ratio |
| 2.4 | Bottom | 0.285 | 0.451 | 0.736 | N/A | N/A |
| 5 | Bottom | 0.566 | 0.606 | 1.172 | N/A | N/A |

| Antenna : SOUTHSTAR | | | | | | |
|---------------------|----------------------|----------------------|---------------------|----------------------------------|--------------------|--------------------------------|
| Frequency (GHz) | Test Position (Body) | WLAN Main SAR (W/Kg) | WLAN Aux SAR (W/Kg) | Simultaneous Transmission (W/Kg) | Antenna pair in mm | Peak location separation ratio |
| 2.4 | Bottom | 0.406 | 0.643 | 1.049 | N/A | N/A |
| 5 | Bottom | 0.767 | 0.457 | 1.224 | N/A | N/A |

Note : The sum of value is less than 1.6W/Kg or the ratio is determined by $(SAR1 + SAR2)^{1.5}/R_i$, rounded to two decimal digits, and must be ≤ 0.04 for all antenna pairs in the configuration to qualify for SAR test exclusion.

9.2.2 simultaneous transmission of Wi-Fi and other wireless technologies

When the sum of SAR is larger than the limit, The ratio is determined by $(SAR1 + SAR2)^{1.5}/R_i$, rounded to two decimal digits, and must be ≤ 0.04 for all antenna pairs in the configuration to qualify for 1-g SAR test exclusion. The estimation result as below:

For DTS Band:

| Antenna : High-Tek | | | | | |
|--------------------|----------------------|---------------|----------------------------------|--------------------|--------------------------------|
| Mode | WLAN Main SAR (W/Kg) | BT SAR (W/Kg) | Simultaneous Transmission (W/Kg) | Antenna pair in mm | Peak location separation ratio |
| Bottom | 0.285 | 0.080 | 0.365 | N/A | N/A |

The sum of value is less than 1.6W/Kg, thus simultaneous SAR testing is not needed.

| Antenna : SOUTHSTAR | | | | | |
|---------------------|----------------------|---------------|----------------------------------|--------------------|--------------------------------|
| Mode | WLAN Main SAR (W/Kg) | BT SAR (W/Kg) | Simultaneous Transmission (W/Kg) | Antenna pair in mm | Peak location separation ratio |
| Bottom | 0.406 | 0.120 | 0.526 | N/A | N/A |

The sum of value is less than 1.6W/Kg, thus simultaneous SAR testing is not needed.

For U-NII Band:

| Antenna : High-Tek | | | | | |
|--------------------|----------------------|---------------|----------------------------------|--------------------|--------------------------------|
| Mode | WLAN Main SAR (W/Kg) | BT SAR (W/Kg) | Simultaneous Transmission (W/Kg) | Antenna pair in mm | Peak location separation ratio |
| Bottom | 0.566 | 0.080 | 0.646 | N/A | N/A |

The sum of value is less than 1.6W/Kg, thus simultaneous SAR testing is not needed.

| Antenna : High-Tek | | | | | | |
|--------------------|----------------------|---------------------|---------------|----------------------------------|--------------------|--------------------------------|
| Mode | WLAN Main SAR (W/Kg) | WLAN Aux SAR (W/Kg) | BT SAR (W/Kg) | Simultaneous Transmission (W/Kg) | Antenna pair in mm | Peak location separation ratio |
| Bottom | 0.566 | 0.606 | 0.080 | 1.252 | N/A | N/A |

The sum of value is less than 1.6W/Kg, thus simultaneous SAR testing is not needed.

| Antenna : SOUTHSTAR | | | | | |
|---------------------|----------------------|---------------|----------------------------------|--------------------|--------------------------------|
| Mode | WLAN Main SAR (W/Kg) | BT SAR (W/Kg) | Simultaneous Transmission (W/Kg) | Antenna pair in mm | Peak location separation ratio |
| Bottom | 0.767 | 0.120 | 0.887 | N/A | N/A |

The sum of value is less than 1.6W/Kg, thus simultaneous SAR testing is not needed.

| Antenna : SOUTHSTAR | | | | | | |
|---------------------|----------------------|---------------------|---------------|----------------------------------|--------------------|--------------------------------|
| Mode | WLAN Main SAR (W/Kg) | WLAN Aux SAR (W/Kg) | BT SAR (W/Kg) | Simultaneous Transmission (W/Kg) | Antenna pair in mm | Peak location separation ratio |
| Bottom | 0.767 | 0.457 | 0.120 | 1.344 | N/A | N/A |

The sum of value is less than 1.6W/Kg, thus simultaneous SAR testing is not needed.

10. SAR measurement variability

- 1) Repeated measurement is not required when the original highest measured SAR is < 0.80 W/kg; steps 2) through 4) do not apply.
- 2) When the original highest measured SAR is ≥ 0.80 W/kg, repeat that measurement once.
- 3) Perform a second repeated measurement only if the ratio of largest to smallest SAR for the original and first repeated measurements is > 1.20 or when the original or repeated measurement is ≥ 1.45 W/kg (~ 10% from the 1-g SAR limit).
- 4) Perform a third repeated measurement only if the original, first or second repeated measurement is ≥ 1.5 W/kg and the ratio of largest to smallest SAR for the original, first and second repeated measurements is > 1.20 .

| Frequency | | SAR 1g (W/kg) | | | | | | |
|-----------|------|---------------|----------------|-------|-----------------|-------|----------------|-------|
| Channel | MHz | Original | First Repeated | | Second Repeated | | Third Repeated | |
| | | | Value | Ratio | Value | Ratio | Value | Ratio |
| 6 | 2437 | 0.643 | N/A | N/A | N/A | N/A | N/A | N/A |
| 50 | 5250 | 0.767 | N/A | N/A | N/A | N/A | N/A | N/A |

Appendix

Appendix A. SAR System Check Data

Appendix B. SAR measurement Data

Appendix C. Test Setup Photographs

Appendix D. Probe Calibration Data

Appendix E. Dipole Calibration Data

Appendix F. Product Photos-Please refer to the file: 2231069R-Product Photos

Appendix A. SAR System Check Data

Test Laboratory: DEKRA

Date: 2022/04/13

System Performance Check_2450MHz-Head

DUT: Dipole 2450 MHz; Type: D2450V2

Communication System: UID 10000, CW; Frequency: 2450 MHz;

Communication System PAR: 0 dB

Medium parameters used: $f = 2450$ MHz; $\sigma = 1.78$ S/m; $\epsilon_r = 39.49$; $\rho = 1000$ kg/m³

Phantom section: Flat Section

Ambient Temperature (°C) : 22.9, Liquid Temperature (°C) : 21.9

Measurement Standard: DASYS (IEEE/IEC/ANSI C63.19-2011)

DASY5 Configuration:

- Probe: EX3DV4 - SN3698; ConvF(7.19, 7.19, 7.19); Calibrated: 2021/11/24;
- Sensor-Surface: 1.4mm (Mechanical Surface Detection)
- Electronics: DAE4 Sn1207; Calibrated: 2021/11/22
- Phantom: SAM with left table; Type: SAM;
- Measurement SW: DASYS2, Version 52.10 (0); SEMCAD X Version 14.6.10 (7417)

Configuration/2450MHz_Head/Area Scan (8x9x1): Measurement grid: dx=12mm, dy=12mm

Maximum value of SAR (measured) = 19.7 W/kg

Configuration/2450MHz_Head/Zoom Scan (7x7x7)/Cube 0: Measurement grid: dx=5mm, dy=5mm, dz=5mm

Reference Value = 120.3 V/m; Power Drift = 0.03 dB

Peak SAR (extrapolated) = 28.2 W/kg

SAR(1 g) = 14.2 W/kg; SAR(10 g) = 6.54 W/kg

Maximum value of SAR (measured) = 24.5 W/kg

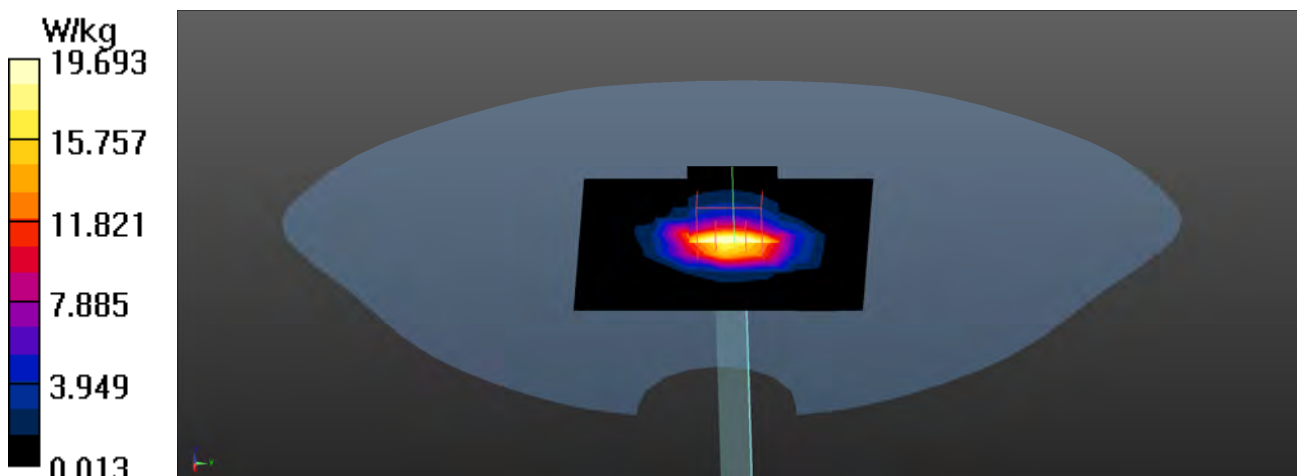

Test Laboratory: DEKRA

Date: 2022/04/14

System Performance Check_5250MHz-Head**DUT: Dipole 5GHz; Type: D5GHzV2**

Communication System: UID 0, CW; Frequency: 5250 MHz;

Communication System PAR: 0 dB

Medium parameters used: $f = 5250$ MHz; $\sigma = 4.61$ S/m; $\epsilon_r = 35.85$; $\rho = 1000$ kg/m³

Phantom section: Flat Section

Ambient Temperature (°C) : 23.0, Liquid Temperature (°C) : 22.2

Measurement Standard: DASYS5 (IEEE/IEC/ANSI C63.19-2011)

DASY5 Configuration:

- Probe: EX3DV4 - SN3698; ConvF(4.7, 4.7, 4.7); Calibrated: 2021/11/24;
- Sensor-Surface: 1.4mm (Mechanical Surface Detection)
- Electronics: DAE4 Sn1207; Calibrated: 2021/11/22
- Phantom: SAM with right table; Type: SAM;
- Measurement SW: DASY52, Version 52.10 (0); SEMCAD X Version 14.6.10 (7417)

Configuration/5250MHz-Head/Area Scan (8x8x1): Measurement grid: dx=10mm, dy=10mm

Maximum value of SAR (measured) = 12.4 W/kg

Configuration/5250MHz-Head/Zoom Scan (7x7x7)/Cube 0: Measurement grid: dx=4mm, dy=4mm, dz=1.4mm

Reference Value = 72.20 V/m; Power Drift = 0.01 dB

Peak SAR (extrapolated) = 27.8 W/kg

SAR(1 g) = 7.97 W/kg; SAR(10 g) = 2.29 W/kg

Maximum value of SAR (measured) = 20.3 W/kg

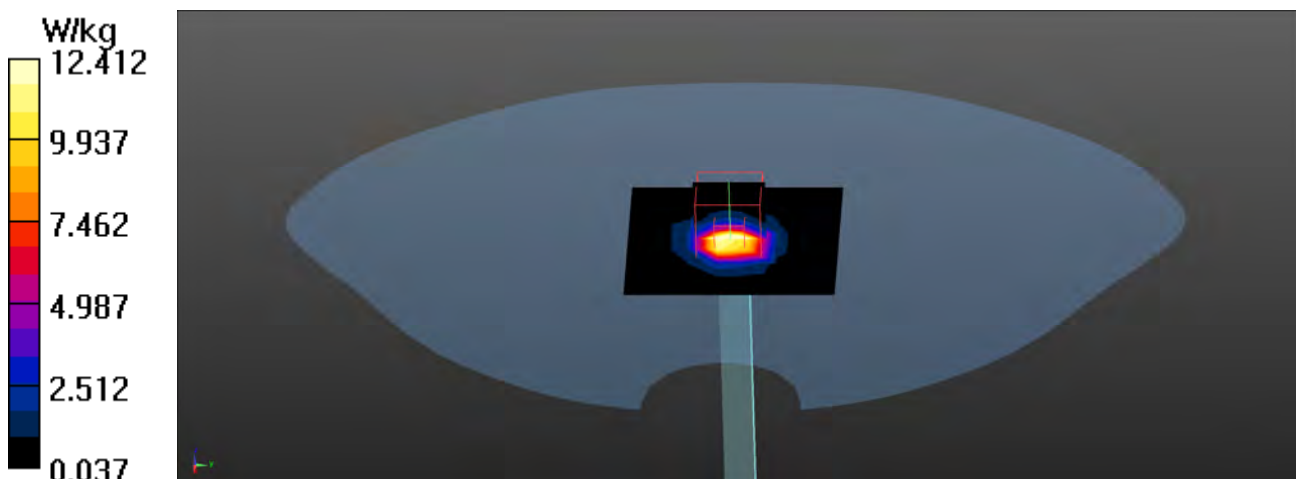

Test Laboratory: DEKRA

Date: 2022/04/14

System Performance Check_5600MHz-Head**DUT: Dipole 5GHz; Type: D5GHzV2**

Communication System: UID 0, CW; Frequency: 5600 MHz;

Communication System PAR: 0 dB

Medium parameters used: $f = 5600$ MHz; $\sigma = 5.09$ S/m; $\epsilon_r = 34.88$; $\rho = 1000$ kg/m³

Phantom section: Flat Section

Ambient Temperature (°C) : 23.0, Liquid Temperature (°C) : 22.2

Measurement Standard: DASYS (IEEE/IEC/ANSI C63.19-2011)

DASY5 Configuration:

- Probe: EX3DV4 - SN3698; ConvF(4.35, 4.35, 4.35); Calibrated: 2021/11/24;
- Sensor-Surface: 1.4mm (Mechanical Surface Detection)
- Electronics: DAE4 Sn1207; Calibrated: 2021/11/22
- Phantom: SAM with right table; Type: SAM;
- Measurement SW: DASY52, Version 52.10 (0); SEMCAD X Version 14.6.10 (7417)

Configuration/5600MHz-Head/Area Scan (8x8x1): Measurement grid: dx=10mm, dy=10mm

Maximum value of SAR (measured) = 13.7 W/kg

Configuration/5600MHz-Head/Zoom Scan (7x7x7)/Cube 0: Measurement grid: dx=4mm, dy=4mm, dz=1.4mm

Reference Value = 72.55 V/m; Power Drift = -0.05 dB

Peak SAR (extrapolated) = 31.3 W/kg

SAR(1 g) = 8.42 W/kg; SAR(10 g) = 2.39 W/kg

Maximum value of SAR (measured) = 21.9 W/kg

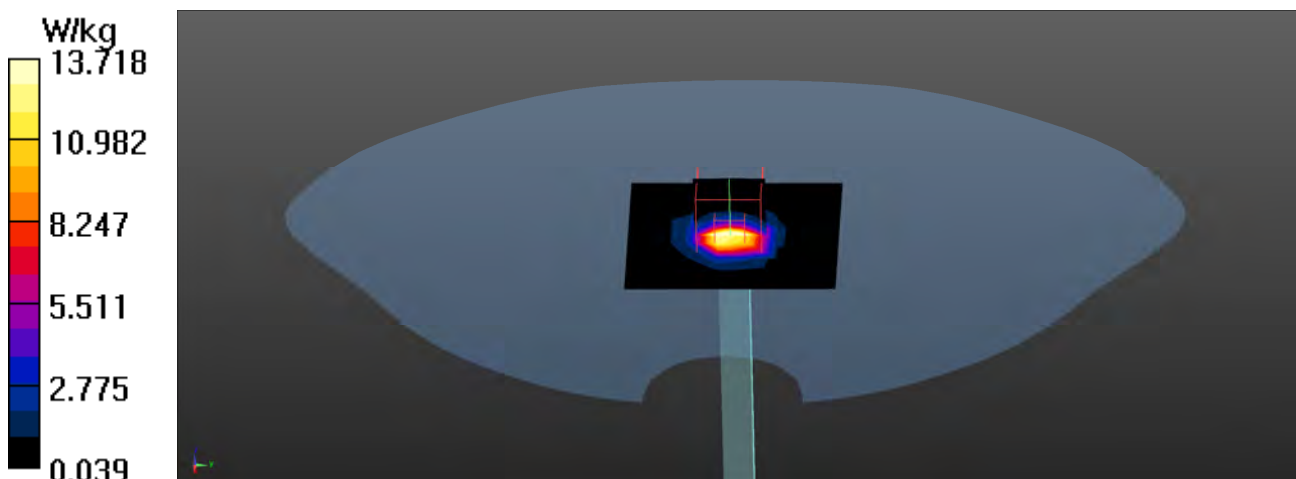

Test Laboratory: DEKRA

Date: 2022/04/14

System Performance Check_5800MHz-Head**DUT: Dipole 5GHz; Type: D5GHzV2**

Communication System: UID 0, CW; Frequency: 5800 MHz;

Communication System PAR: 0 dB

Medium parameters used: $f = 5800$ MHz; $\sigma = 5.34$ S/m; $\epsilon_r = 34.33$; $\rho = 1000$ kg/m³

Phantom section: Flat Section

Ambient Temperature (°C) : 23.0, Liquid Temperature (°C) : 22.2

Measurement Standard: DASYS (IEEE/IEC/ANSI C63.19-2011)

DASY5 Configuration:

- Probe: EX3DV4 - SN3698; ConvF(4.58, 4.58, 4.58); Calibrated: 2021/11/24;
- Sensor-Surface: 1.4mm (Mechanical Surface Detection)
- Electronics: DAE4 Sn1207; Calibrated: 2021/11/22
- Phantom: SAM with right table; Type: SAM;
- Measurement SW: DASYS2, Version 52.10 (0); SEMCAD X Version 14.6.10 (7417)

Configuration/5800MHz-Head/Area Scan (8x8x1): Measurement grid: dx=10mm, dy=10mm

Maximum value of SAR (measured) = 13.3 W/kg

Configuration/5800MHz-Head/Zoom Scan (7x7x7)/Cube 0: Measurement grid: dx=4mm, dy=4mm, dz=1.4mm

Reference Value = 70.89 V/m; Power Drift = 0.01 dB

Peak SAR (extrapolated) = 32.1 W/kg

SAR(1 g) = 8.17 W/kg; SAR(10 g) = 2.3 W/kg

Maximum value of SAR (measured) = 21.9 W/kg

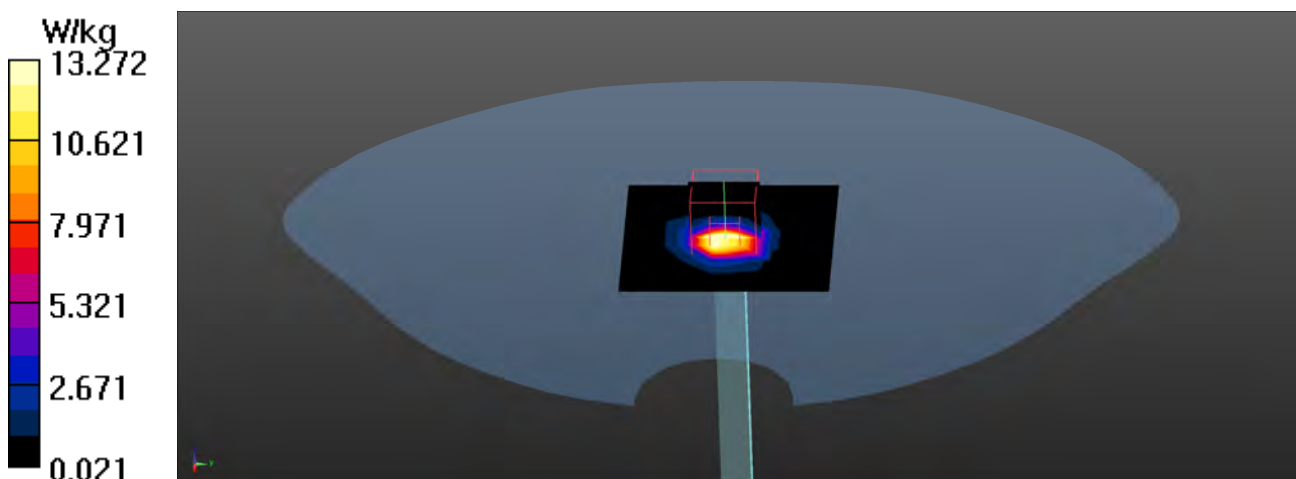

Appendix B. SAR measurement Data

Test Laboratory: DEKRA

Date: 2022/04/13

01_802.11b_6-Bottom Aux_SOUTHSTAR

DUT: Notebook Computer; Type: SATELLITE PRO C50-K

Communication System: UID 0, WLAN 2.4G; Frequency: 2437 MHz;

Communication System PAR: 0 dB

Medium parameters used: $f = 2437$ MHz; $\sigma = 1.77$ S/m; $\epsilon_r = 39.54$; $\rho = 1000$ kg/m³

Phantom section: Flat Section

Ambient Temperature (°C) : 22.9, Liquid Temperature (°C) : 21.9

Measurement Standard: DASYS (IEEE/IEC/ANSI C63.19-2011)

DASY5 Configuration:

- Probe: EX3DV4 - SN3698; ConvF(7.19, 7.19, 7.19); Calibrated: 2021/11/24;
- Sensor-Surface: 1.4mm (Mechanical Surface Detection)
- Electronics: DAE4 Sn1207; Calibrated: 2021/11/22
- Phantom: SAM with left table; Type: SAM;
- Measurement SW: DASY52, Version 52.10 (0); SEMCAD X Version 14.6.10 (7417)

Configuration/Flat/Area Scan (9x18x1): Measurement grid: dx=12mm, dy=12mm

Maximum value of SAR (measured) = 1.11 W/kg

Configuration/Flat/Zoom Scan (7x7x7)/Cube 0: Measurement grid: dx=5mm, dy=5mm, dz=5mm

Reference Value = 25.90 V/m; Power Drift = -0.02 dB

Peak SAR (extrapolated) = 1.47 W/kg

SAR(1 g) = 0.621 W/kg; SAR(10 g) = 0.275 W/kg

Maximum value of SAR (measured) = 1.12 W/kg

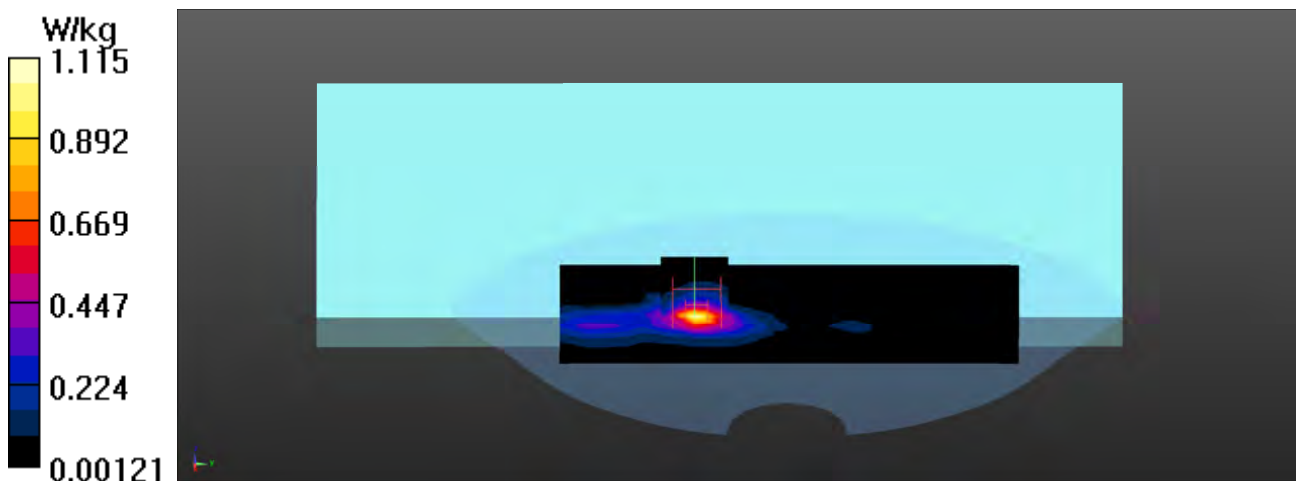

Test Laboratory: DEKRA

Date: 2022/04/13

02_BT-1M_39-Bottom Aux_SOUTHSTAR**DUT: Notebook Computer; Type: SATELLITE PRO C50-K**

Communication System: UID 0, BT 1M&3M&BLE; Frequency: 2441 MHz;

Communication System PAR: 0 dB

Medium parameters used: $f = 2441$ MHz; $\sigma = 1.77$ S/m; $\epsilon_r = 39.53$; $\rho = 1000$ kg/m³

Phantom section: Flat Section

Ambient Temperature (°C) : 22.9, Liquid Temperature (°C) : 21.9

Measurement Standard: DASYS (IEEE/IEC/ANSI C63.19-2011)

DASY5 Configuration:

- Probe: EX3DV4 - SN3698; ConvF(7.19, 7.19, 7.19); Calibrated: 2021/11/24;
- Sensor-Surface: 1.4mm (Mechanical Surface Detection)
- Electronics: DAE4 Sn1207; Calibrated: 2021/11/22
- Phantom: SAM with left table; Type: SAM;
- Measurement SW: DASY52, Version 52.10 (0); SEMCAD X Version 14.6.10 (7417)

Configuration/Flat/Area Scan (10x18x1): Measurement grid: dx=12mm, dy=12mm

Maximum value of SAR (measured) = 0.188 W/kg

Configuration/Flat/Zoom Scan (7x7x7)/Cube 0: Measurement grid: dx=5mm,

dy=5mm, dz=5mm

Reference Value = 10.66 V/m; Power Drift = 0.07 dB

Peak SAR (extrapolated) = 0.259 W/kg

SAR(1 g) = 0.107 W/kg; SAR(10 g) = 0.049 W/kg

Maximum value of SAR (measured) = 0.192 W/kg

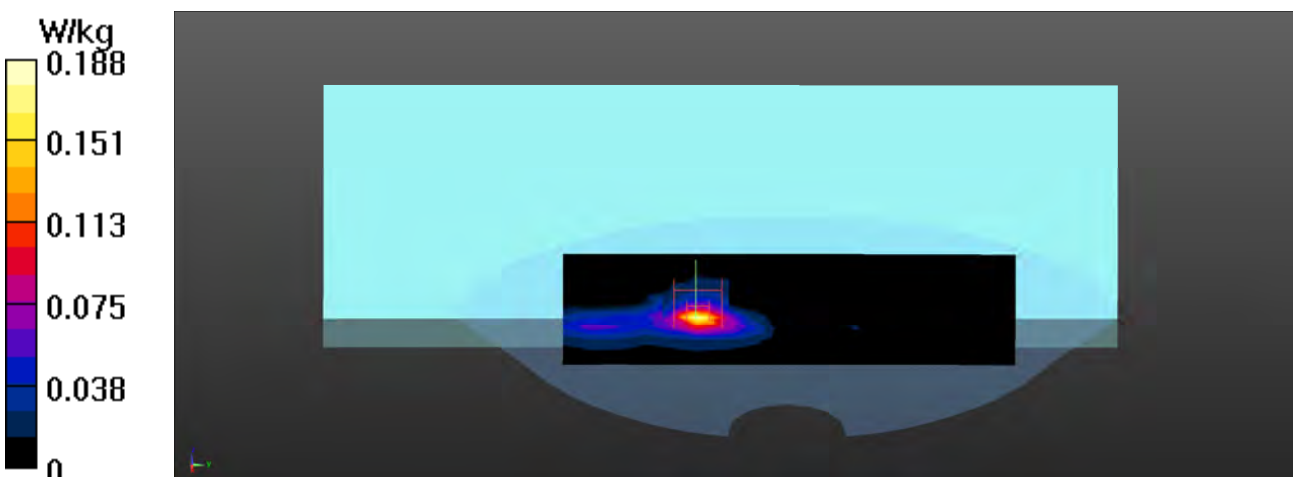

802.11b EUT Bottom (SOUTHSTAR Aux Antenna) Z-Axis plot

Channel: 6

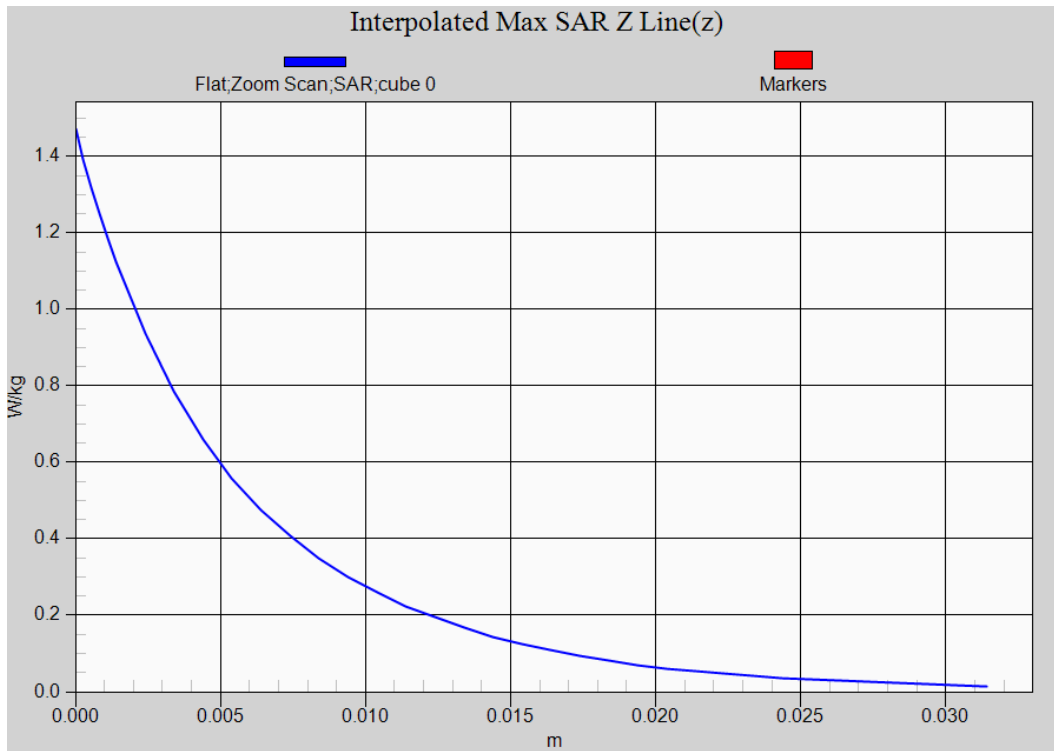

Test Laboratory: DEKRA

Date: 2022/04/14

03_802.11ac160M_50-Bottom Main_SOUTHSTAR**DUT: Notebook Computer; Type: SATELLITE PRO C50-K**

Communication System: UID 0, WLAN 5G; Frequency: 5250 MHz;

Communication System PAR: 0 dB

Medium parameters used: $f = 5250$ MHz; $\sigma = 4.61$ S/m; $\epsilon_r = 35.85$; $\rho = 1000$ kg/m³

Phantom section: Flat Section

Ambient Temperature (°C) : 23.0, Liquid Temperature (°C) : 22.2

Measurement Standard: DASYS (IEEE/IEC/ANSI C63.19-2011)

DASY5 Configuration:

- Probe: EX3DV4 - SN3698; ConvF(4.7, 4.7, 4.7); Calibrated: 2021/11/24;
- Sensor-Surface: 1.4mm (Mechanical Surface Detection)
- Electronics: DAE4 Sn1207; Calibrated: 2021/11/22
- Phantom: SAM with right table; Type: SAM;
- Measurement SW: DASY52, Version 52.10 (0); SEMCAD X Version 14.6.10 (7417)

Configuration/Flat/Area Scan (11x16x1): Measurement grid: dx=10mm, dy=10mm

Maximum value of SAR (measured) = 1.41 W/kg

Configuration/Flat/Zoom Scan (7x7x7)/Cube 0: Measurement grid: dx=4mm,

dy=4mm, dz=1.4mm

Reference Value = 22.42 V/m; Power Drift = -0.05 dB

Peak SAR (extrapolated) = 2.90 W/kg

SAR(1 g) = 0.762 W/kg; SAR(10 g) = 0.221 W/kg

Maximum value of SAR (measured) = 1.83 W/kg

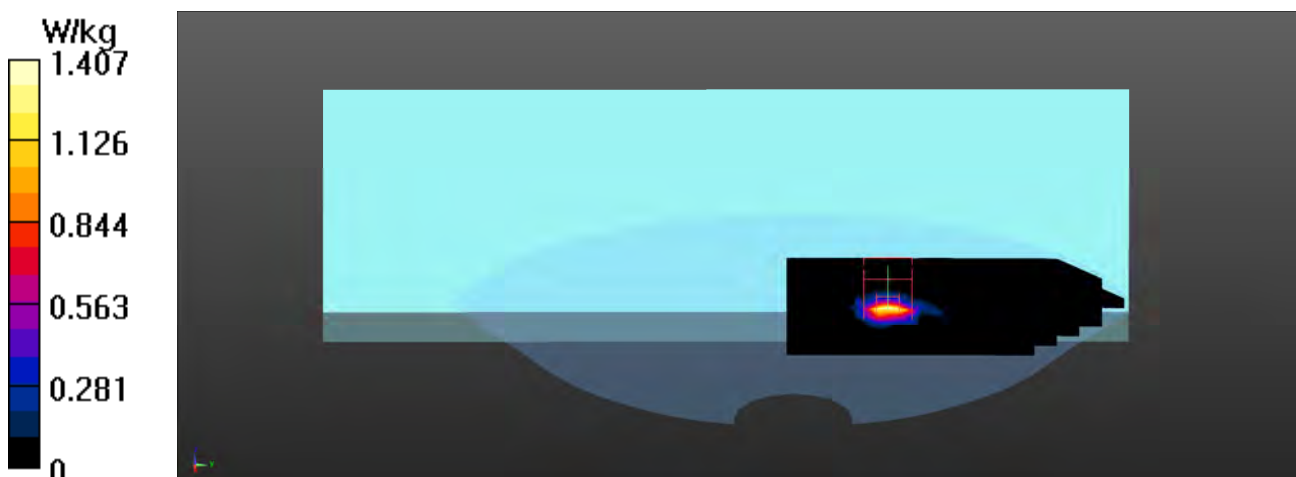

Test Laboratory: DEKRA

Date: 2022/04/14

04_802.11ac160M_114-Bottom Main_SOUTHSTAR**DUT: Notebook Computer; Type: SATELLITE PRO C50-K**

Communication System: UID 0, WLAN 5G; Frequency: 5570 MHz;

Communication System PAR: 0 dB

Medium parameters used: $f = 5570$ MHz; $\sigma = 5.05$ S/m; $\epsilon_r = 34.96$; $\rho = 1000$ kg/m³

Phantom section: Flat Section

Ambient Temperature (°C) : 23.0, Liquid Temperature (°C) : 22.2

Measurement Standard: DASYS (IEEE/IEC/ANSI C63.19-2011)

DASY5 Configuration:

- Probe: EX3DV4 - SN3698; ConvF(4.35, 4.35, 4.35); Calibrated: 2021/11/24;
- Sensor-Surface: 1.4mm (Mechanical Surface Detection)
- Electronics: DAE4 Sn1207; Calibrated: 2021/11/22
- Phantom: SAM with right table; Type: SAM;
- Measurement SW: DASY52, Version 52.10 (0); SEMCAD X Version 14.6.10 (7417)

Configuration/Flat/Area Scan (10x15x1): Measurement grid: dx=10mm, dy=10mm

Maximum value of SAR (measured) = 1.34 W/kg

Configuration/Flat/Zoom Scan (7x7x7)/Cube 0: Measurement grid: dx=4mm,

dy=4mm, dz=1.4mm

Reference Value = 18.86 V/m; Power Drift = -0.03 dB

Peak SAR (extrapolated) = 2.95 W/kg

SAR(1 g) = 0.619 W/kg; SAR(10 g) = 0.197 W/kg

Maximum value of SAR (measured) = 1.50 W/kg



Test Laboratory: DEKRA

Date: 2022/04/14

05_802.11ac80M_155-Bottom Aux_High-Tek**DUT: Notebook Computer; Type: SATELLITE PRO C50-K**

Communication System: UID 0, WLAN 5G; Frequency: 5775 MHz;

Communication System PAR: 0 dB

Medium parameters used: $f = 5775$ MHz; $\sigma = 5.31$ S/m; $\epsilon_r = 34.41$; $\rho = 1000$ kg/m³

Phantom section: Flat Section

Ambient Temperature (°C) : 23.0, Liquid Temperature (°C) : 22.2

Measurement Standard: DASYS (IEEE/IEC/ANSI C63.19-2011)

DASY5 Configuration:

- Probe: EX3DV4 - SN3698; ConvF(4.58, 4.58, 4.58); Calibrated: 2021/11/24;
- Sensor-Surface: 1.4mm (Mechanical Surface Detection)
- Electronics: DAE4 Sn1207; Calibrated: 2021/11/22
- Phantom: SAM with right table; Type: SAM;
- Measurement SW: DASYS2, Version 52.10 (0); SEMCAD X Version 14.6.10 (7417)

Configuration/Flat/Area Scan (8x16x1): Measurement grid: dx=10mm, dy=10mm
Maximum value of SAR (measured) = 0.949 W/kg**Configuration/Flat/Zoom Scan (7x7x7)/Cube 0:** Measurement grid: dx=4mm, dy=4mm, dz=1.4mm

Reference Value = 16.37 V/m; Power Drift = -0.06 dB

Peak SAR (extrapolated) = 2.00 W/kg

SAR(1 g) = 0.470 W/kg; SAR(10 g) = 0.153 W/kg

Maximum value of SAR (measured) = 1.16 W/kg

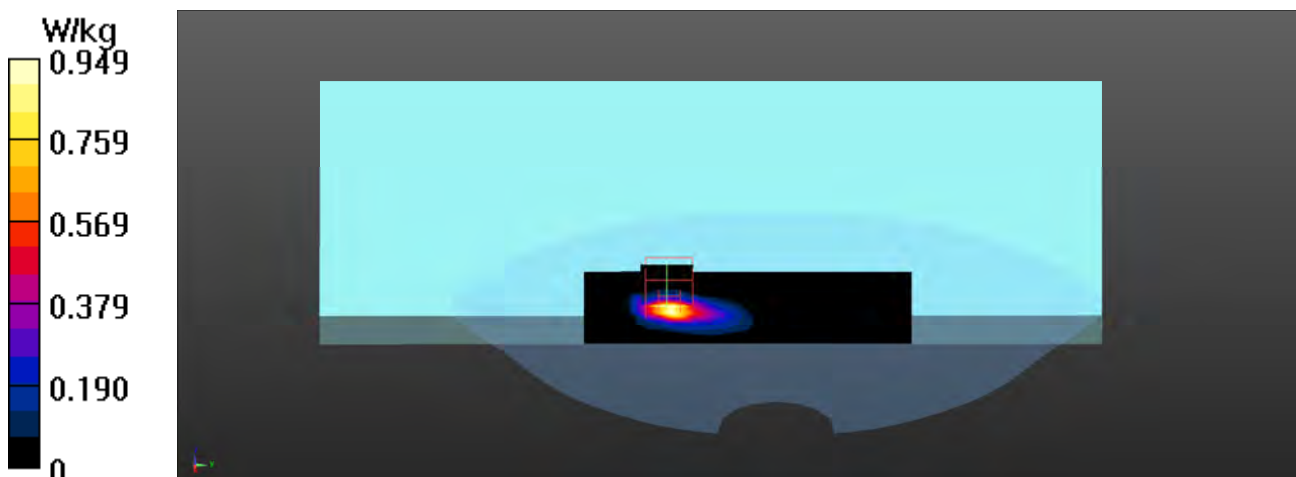

802.11ac160M EUT Bottom (SOUTHSTAR Main Antenna) Z-Axis plot

Channel: 50

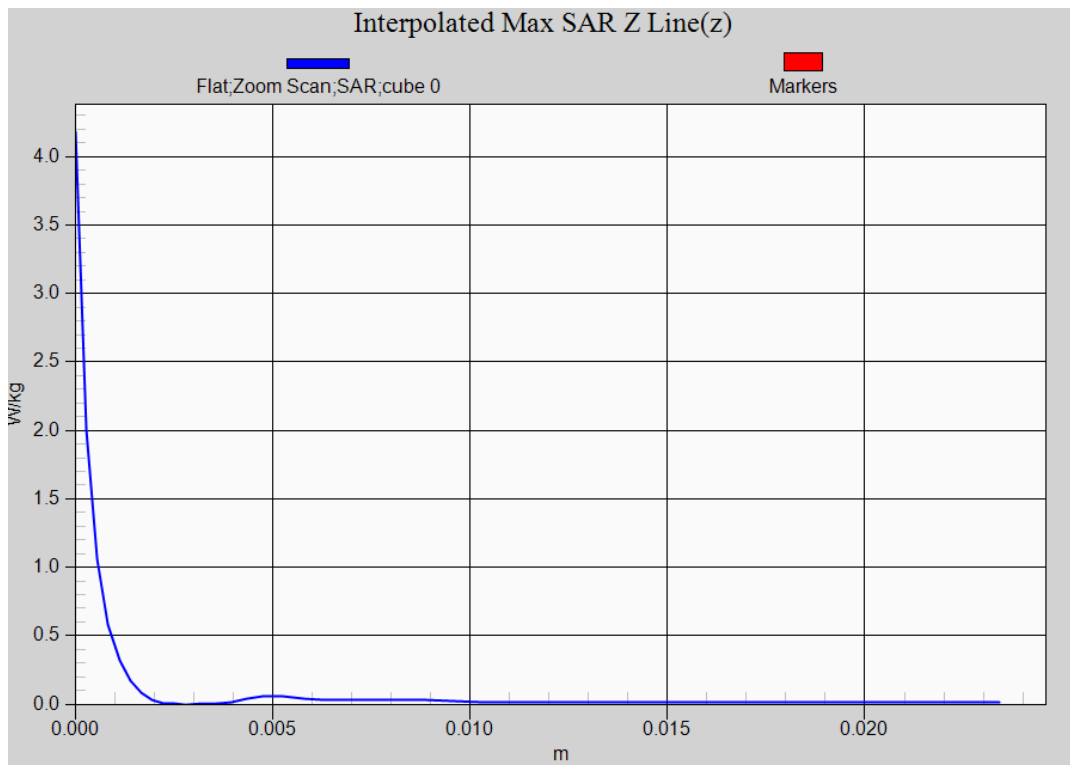



Appendix D. Probe Calibration

Object: EX3DV4 - SN : 3698



Accredited by the Swiss Accreditation Service (SAS)
The Swiss Accreditation Service is one of the signatories to the EA
Multilateral Agreement for the recognition of calibration certificates

Accreditation No.: **SCS 0108**

Client **DEKRA (Auden)**

Certificate No: **EX3-3698_Nov21**

CALIBRATION CERTIFICATE

Object: **EX3DV4 - SN:3698**

Calibration procedure(s): **QA CAL-01.v9, QA CAL-12.v9, QA CAL-14.v6, QA CAL-23.v5,
QA CAL-25.v7
Calibration procedure for dosimetric E-field probes**

Calibration date: **November 24, 2021**

This calibration certificate documents the traceability to national standards, which realize the physical units of measurements (SI).
The measurements and the uncertainties with confidence probability are given on the following pages and are part of the certificate.

All calibrations have been conducted in the closed laboratory facility: environment temperature (22 ± 3)°C and humidity < 70%.

Calibration Equipment used (M&TE critical for calibration)

| Primary Standards | ID | Cal Date (Certificate No.) | Scheduled Calibration |
|----------------------------|------------------|-----------------------------------|------------------------|
| Power meter NRP | SN: 104778 | 09-Apr-21 (No. 217-03291/03292) | Apr-22 |
| Power sensor NRP-Z91 | SN: 103244 | 09-Apr-21 (No. 217-03291) | Apr-22 |
| Power sensor NRP-Z91 | SN: 103245 | 09-Apr-21 (No. 217-03292) | Apr-22 |
| Reference 20 dB Attenuator | SN: CC2552 (20x) | 09-Apr-21 (No. 217-03343) | Apr-22 |
| DAE4 | SN: 660 | 23-Dec-20 (No. DAE4-660_Dec20) | Dec-21 |
| Reference Probe ES3DV2 | SN: 3013 | 30-Dec-20 (No. ES3-3013_Dec20) | Dec-21 |
| Secondary Standards | ID | Check Date (in house) | Scheduled Check |
| Power meter E4419B | SN: GB41293874 | 06-Apr-16 (in house check Jun-20) | In house check: Jun-22 |
| Power sensor E4412A | SN: MY41498087 | 06-Apr-16 (in house check Jun-20) | In house check: Jun-22 |
| Power sensor E4412A | SN: 000110210 | 06-Apr-16 (in house check Jun-20) | In house check: Jun-22 |
| RF generator HP 8648C | SN: US3642U01700 | 04-Aug-99 (in house check Jun-20) | In house check: Jun-22 |
| Network Analyzer E8358A | SN: US41080477 | 31-Mar-14 (in house check Oct-20) | In house check: Oct-22 |

| | Name | Function | Signature |
|----------------|----------------|-----------------------|-----------|
| Calibrated by: | Jeton Kastrati | Laboratory Technician | |
| Approved by: | Niels Kuster | Quality Manager | |

Issued: November 26, 2021

This calibration certificate shall not be reproduced except in full without written approval of the laboratory.



Accredited by the Swiss Accreditation Service (SAS)

Accreditation No.: **SCS 0108**

The Swiss Accreditation Service is one of the signatories to the EA
Multilateral Agreement for the recognition of calibration certificates

Glossary:

| | |
|-----------------------|---|
| TSL | tissue simulating liquid |
| NORM _{x,y,z} | sensitivity in free space |
| ConvF | sensitivity in TSL / NORM _{x,y,z} |
| DCP | diode compression point |
| CF | crest factor (1/duty_cycle) of the RF signal |
| A, B, C, D | modulation dependent linearization parameters |
| Polarization φ | φ rotation around probe axis |
| Polarization ϑ | ϑ rotation around an axis that is in the plane normal to probe axis (at measurement center), i.e., ϑ = 0 is normal to probe axis |
| Connector Angle | information used in DASY system to align probe sensor X to the robot coordinate system |

Calibration is Performed According to the Following Standards:

- a) IEC/IEEE 62209-1528, "Measurement Procedure For The Assessment Of Specific Absorption Rate Of Human Exposure To Radio Frequency Fields From Hand-Held And Body-Worn Wireless Communication Devices - Part 1528: Human Models, Instrumentation And Procedures (Frequency Range of 4 MHz to 10 GHz)", October 2020.
- b) KDB 865664, "SAR Measurement Requirements for 100 MHz to 6 GHz"

Methods Applied and Interpretation of Parameters:

- *NORM_{x,y,z}*: Assessed for E-field polarization ϑ = 0 (f ≤ 900 MHz in TEM-cell; f > 1800 MHz: R22 waveguide). *NORM_{x,y,z}* are only intermediate values, i.e., the uncertainties of *NORM_{x,y,z}* does not affect the E²-field uncertainty inside TSL (see below *ConvF*).
- *NORM(f)_{x,y,z}* = *NORM_{x,y,z}* * *frequency_response* (see Frequency Response Chart). This linearization is implemented in DASY4 software versions later than 4.2. The uncertainty of the frequency response is included in the stated uncertainty of *ConvF*.
- *DCP_{x,y,z}*: DCP are numerical linearization parameters assessed based on the data of power sweep with CW signal (no uncertainty required). DCP does not depend on frequency nor media.
- *PAR*: PAR is the Peak to Average Ratio that is not calibrated but determined based on the signal characteristics
- *A_{x,y,z}*; *B_{x,y,z}*; *C_{x,y,z}*; *D_{x,y,z}*; *VR_{x,y,z}*; *A, B, C, D* are numerical linearization parameters assessed based on the data of power sweep for specific modulation signal. The parameters do not depend on frequency nor media. *VR* is the maximum calibration range expressed in RMS voltage across the diode.
- *ConvF* and *Boundary Effect Parameters*: Assessed in flat phantom using E-field (or Temperature Transfer Standard for f ≤ 800 MHz) and inside waveguide using analytical field distributions based on power measurements for f > 800 MHz. The same setups are used for assessment of the parameters applied for boundary compensation (alpha, depth) of which typical uncertainty values are given. These parameters are used in DASY4 software to improve probe accuracy close to the boundary. The sensitivity in TSL corresponds to *NORM_{x,y,z}* * *ConvF* whereby the uncertainty corresponds to that given for *ConvF*. A frequency dependent *ConvF* is used in DASY version 4.4 and higher which allows extending the validity from ± 50 MHz to ± 100 MHz.
- *Spherical isotropy (3D deviation from isotropy)*: in a field of low gradients realized using a flat phantom exposed by a patch antenna.
- *Sensor Offset*: The sensor offset corresponds to the offset of virtual measurement center from the probe tip (on probe axis). No tolerance required.
- *Connector Angle*: The angle is assessed using the information gained by determining the *NORM_x* (no uncertainty required).

DASY/EASY - Parameters of Probe: EX3DV4 - SN:3698

Basic Calibration Parameters

| | Sensor X | Sensor Y | Sensor Z | Unc (k=2) |
|---|----------|----------|----------|--------------|
| Norm ($\mu\text{V}/(\text{V}/\text{m})^2$) ^A | 0.41 | 0.34 | 0.37 | $\pm 10.1\%$ |
| DCP (mV) ^B | 105.0 | 101.0 | 105.0 | |

Calibration Results for Modulation Response

| UID | Communication System Name | | A dB | B dB $\sqrt{\mu\text{V}}$ | C | D dB | VR mV | Max dev. | Unc ^E (k=2) |
|-----|---------------------------|---|---------|------------------------------|-----|---------|----------|-------------|---------------------------|
| 0 | CW | X | 0.0 | 0.0 | 1.0 | 0.00 | 147.1 | $\pm 3.3\%$ | $\pm 4.7\%$ |
| | | Y | 0.0 | 0.0 | 1.0 | | 129.5 | | |
| | | Z | 0.0 | 0.0 | 1.0 | | 141.3 | | |

The reported uncertainty of measurement is stated as the standard uncertainty of measurement multiplied by the coverage factor $k=2$, which for a normal distribution corresponds to a coverage probability of approximately 95%.

^A The uncertainties of Norm X,Y,Z do not affect the E²-field uncertainty inside TSL (see Page 5).

^B Numerical linearization parameter: uncertainty not required.

^E Uncertainty is determined using the max. deviation from linear response applying rectangular distribution and is expressed for the square of the field value.

DASY/EASY - Parameters of Probe: EX3DV4 - SN:3698

Other Probe Parameters

| | |
|---|------------|
| Sensor Arrangement | Triangular |
| Connector Angle (°) | -137 |
| Mechanical Surface Detection Mode | enabled |
| Optical Surface Detection Mode | disabled |
| Probe Overall Length | 337 mm |
| Probe Body Diameter | 10 mm |
| Tip Length | 9 mm |
| Tip Diameter | 2.5 mm |
| Probe Tip to Sensor X Calibration Point | 1 mm |
| Probe Tip to Sensor Y Calibration Point | 1 mm |
| Probe Tip to Sensor Z Calibration Point | 1 mm |
| Recommended Measurement Distance from Surface | 1.4 mm |

Note: Measurement distance from surface can be increased to 3-4 mm for an *Area Scan* job.

DASY/EASY - Parameters of Probe: EX3DV4 - SN:3698

Calibration Parameter Determined in Head Tissue Simulating Media

| f (MHz) ^C | Relative Permittivity ^F | Conductivity (S/m) ^F | ConvF X | ConvF Y | ConvF Z | Alpha ^G | Depth ^G (mm) | Unc (k=2) |
|----------------------|------------------------------------|---------------------------------|---------|---------|---------|--------------------|-------------------------|-----------|
| 450 | 43.5 | 0.87 | 9.73 | 9.73 | 9.73 | 0.16 | 1.30 | ± 13.3 % |
| 750 | 41.9 | 0.89 | 9.10 | 9.10 | 9.10 | 0.46 | 0.80 | ± 12.0 % |
| 835 | 41.5 | 0.90 | 8.90 | 8.90 | 8.90 | 0.38 | 0.96 | ± 12.0 % |
| 900 | 41.5 | 0.97 | 8.81 | 8.81 | 8.81 | 0.47 | 0.80 | ± 12.0 % |
| 1450 | 40.5 | 1.20 | 8.18 | 8.18 | 8.18 | 0.58 | 0.80 | ± 12.0 % |
| 1640 | 40.2 | 1.31 | 8.08 | 8.08 | 8.08 | 0.30 | 0.86 | ± 12.0 % |
| 1750 | 40.1 | 1.37 | 7.96 | 7.96 | 7.96 | 0.28 | 0.86 | ± 12.0 % |
| 1950 | 40.0 | 1.40 | 7.60 | 7.60 | 7.60 | 0.39 | 0.86 | ± 12.0 % |
| 2300 | 39.5 | 1.67 | 7.39 | 7.39 | 7.39 | 0.33 | 0.90 | ± 12.0 % |
| 2450 | 39.2 | 1.80 | 7.19 | 7.19 | 7.19 | 0.27 | 0.90 | ± 12.0 % |
| 2600 | 39.0 | 1.96 | 6.97 | 6.97 | 6.97 | 0.36 | 0.90 | ± 12.0 % |
| 3300 | 38.2 | 2.71 | 6.65 | 6.65 | 6.65 | 0.30 | 1.35 | ± 13.1 % |
| 3500 | 37.9 | 2.91 | 6.30 | 6.30 | 6.30 | 0.35 | 1.30 | ± 13.1 % |
| 3700 | 37.7 | 3.12 | 6.15 | 6.15 | 6.15 | 0.35 | 1.30 | ± 13.1 % |
| 5250 | 35.9 | 4.71 | 4.70 | 4.70 | 4.70 | 0.40 | 1.80 | ± 13.1 % |
| 5600 | 35.5 | 5.07 | 4.35 | 4.35 | 4.35 | 0.40 | 1.80 | ± 13.1 % |
| 5800 | 35.3 | 5.27 | 4.58 | 4.58 | 4.58 | 0.40 | 1.80 | ± 13.1 % |

^C Frequency validity above 300 MHz of ± 100 MHz only applies for DASY v4.4 and higher (see Page 2), else it is restricted to ± 50 MHz. The uncertainty is the RSS of the ConvF uncertainty at calibration frequency and the uncertainty for the indicated frequency band. Frequency validity below 300 MHz is ± 10, 25, 40, 50 and 70 MHz for ConvF assessments at 30, 64, 128, 150 and 220 MHz respectively. Validity of ConvF assessed at 6 MHz is 4-9 MHz, and ConvF assessed at 13 MHz is 9-19 MHz. Above 5 GHz frequency validity can be extended to ± 110 MHz.

^F At frequencies below 3 GHz, the validity of tissue parameters (ϵ and σ) can be relaxed to ± 10% if liquid compensation formula is applied to measured SAR values. At frequencies above 3 GHz, the validity of tissue parameters (ϵ and σ) is restricted to ± 5%. The uncertainty is the RSS of the ConvF uncertainty for indicated target tissue parameters.

^G Alpha/Depth are determined during calibration. SPEAG warrants that the remaining deviation due to the boundary effect after compensation is always less than ± 1% for frequencies below 3 GHz and below ± 2% for frequencies between 3-6 GHz at any distance larger than half the probe tip diameter from the boundary.

Frequency Response of E-Field (TEM-Cell:ifi110 EXX, Waveguide: R22)

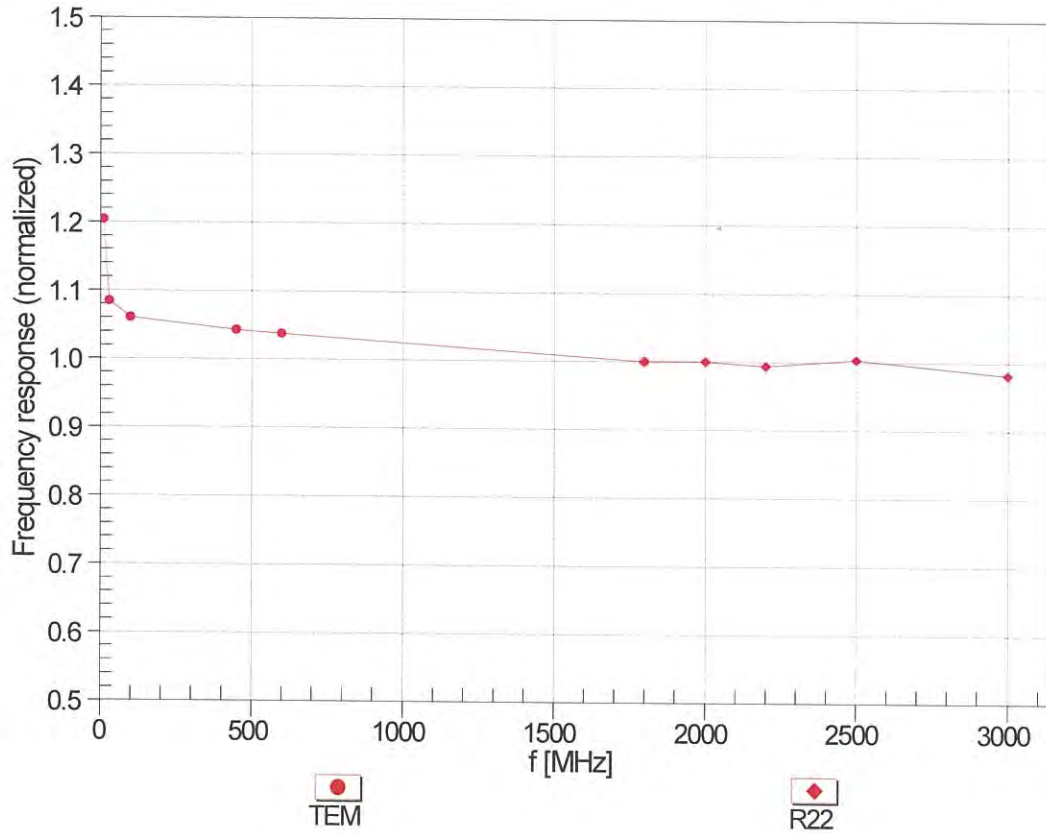

Uncertainty of Frequency Response of E-field: $\pm 6.3\%$ (k=2)

Receiving Pattern (ϕ), $\vartheta = 0^\circ$

f=600 MHz, TEM

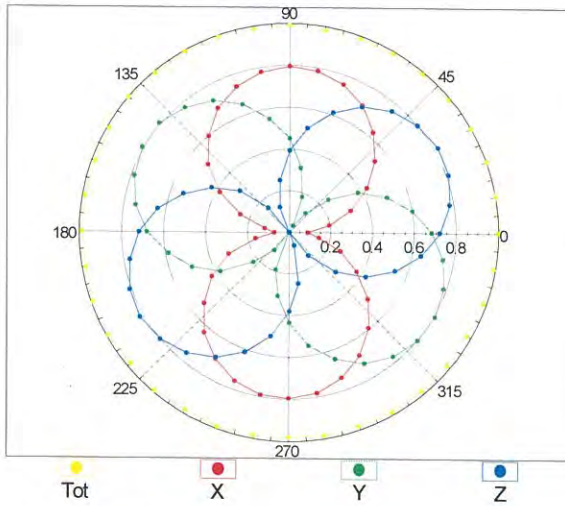

f=1800 MHz, R22

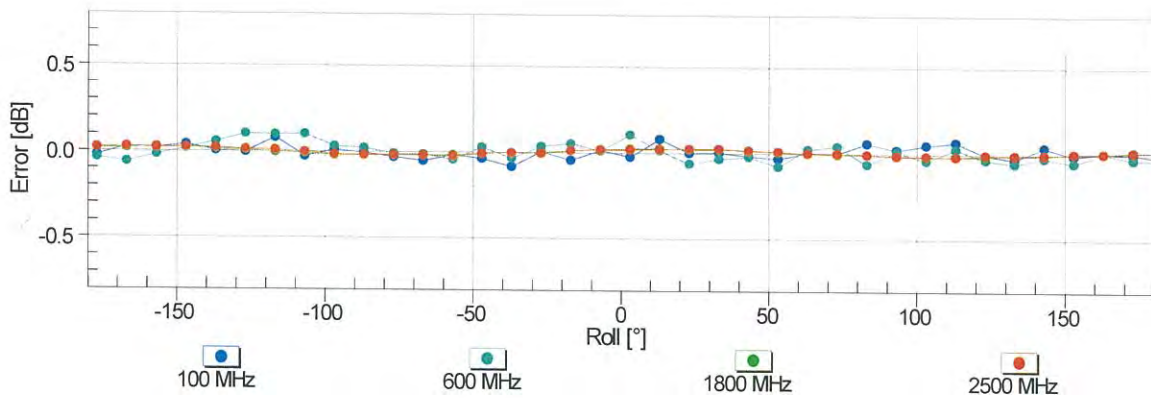
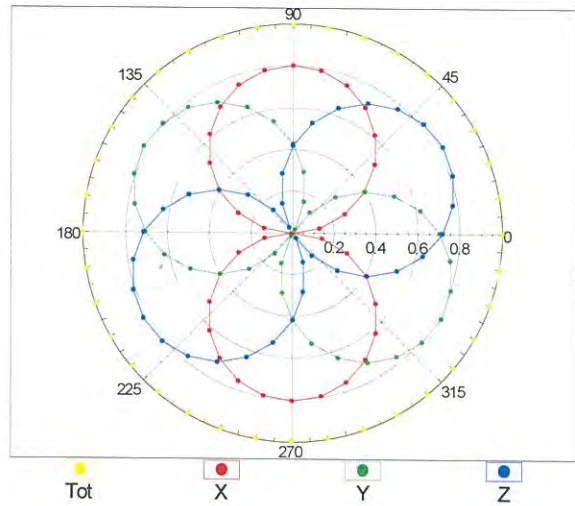

Uncertainty of Axial Isotropy Assessment: $\pm 0.5\%$ ($k=2$)

Dynamic Range $f(\text{SAR}_{\text{head}})$ (TEM cell , $f_{\text{eval}}= 1900 \text{ MHz}$)

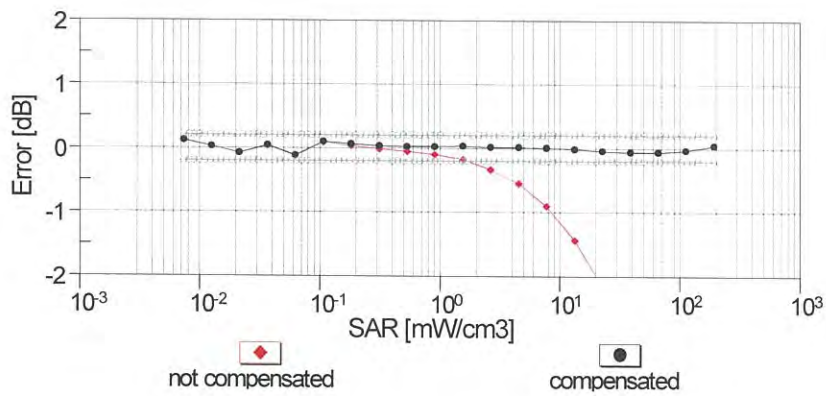
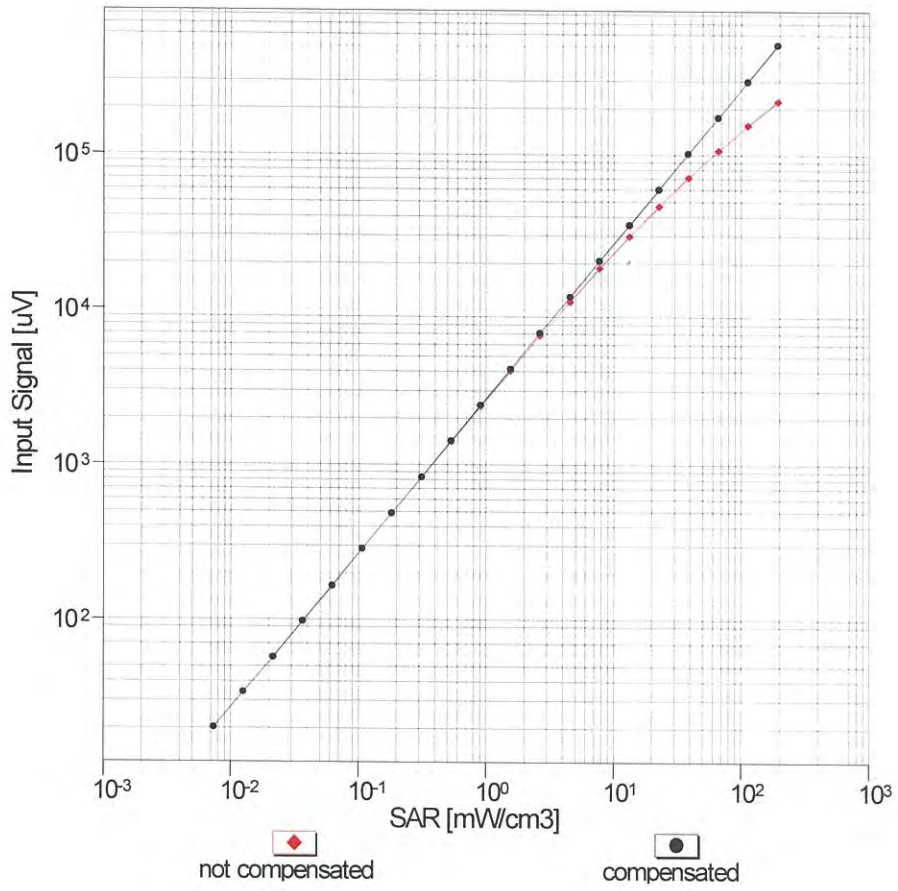

Uncertainty of Linearity Assessment: $\pm 0.6\%$ ($k=2$)

Conversion Factor Assessment

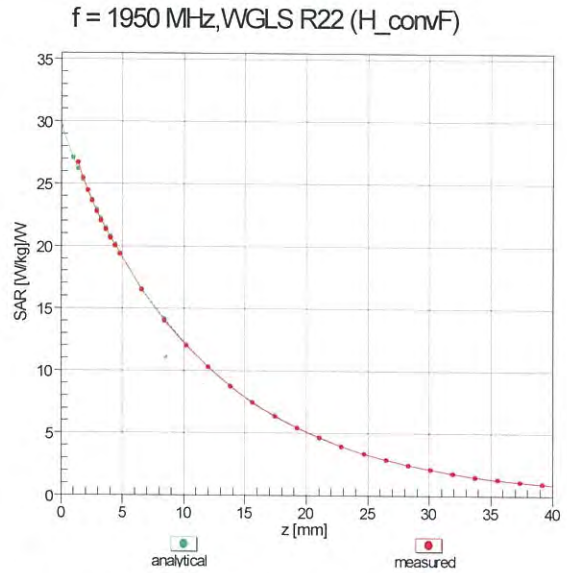
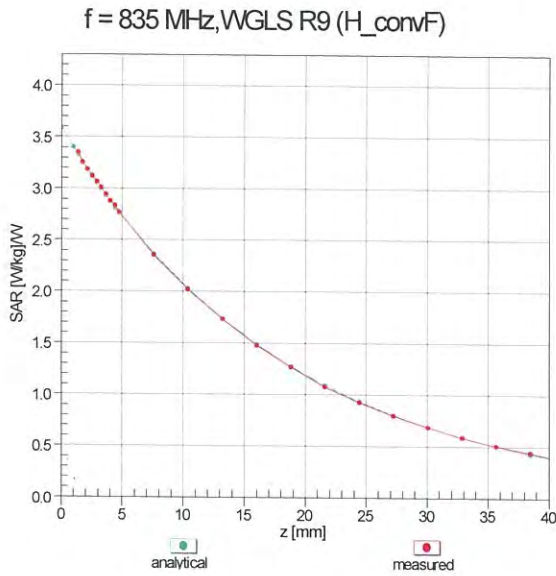

Deviation from Isotropy in Liquid

Error (ϕ, θ), f = 900 MHz

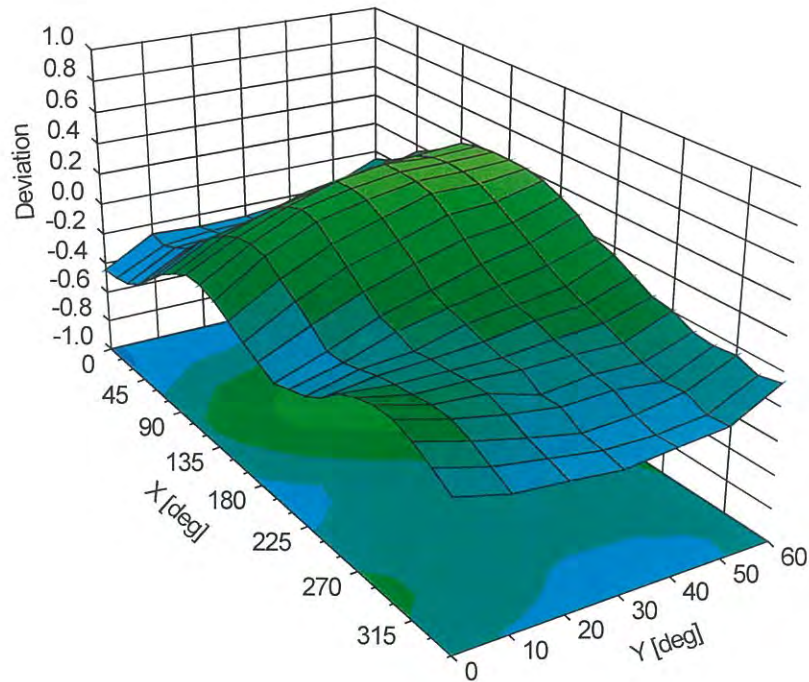

Uncertainty of Spherical Isotropy Assessment: $\pm 2.6\%$ (k=2)



Appendix E. Dipole Calibration

139817

**Calibration Laboratory of
Schmid & Partner
Engineering AG**
Zeughausstrasse 43, 8004 Zurich, Switzerland



S Schweizerischer Kalibrierdienst
C Service suisse d'étalonnage
S Servizio svizzero di taratura
S Swiss Calibration Service

Accredited by the Swiss Accreditation Service (SAS)
The Swiss Accreditation Service is one of the signatories to the EA
Multilateral Agreement for the recognition of calibration certificates

Accreditation No.: **SCS 0108**

Client **DEKRA (Auden)**

Certificate No: **D2450V2-930_Nov19**

CALIBRATION CERTIFICATE

Object **D2450V2 - SN:930**

Calibration procedure(s) **QA CAL-05.v11
Calibration Procedure for SAR Validation Sources between 0.7-3 GHz**

Calibration date: **November 21, 2019**

This calibration certificate documents the traceability to national standards, which realize the physical units of measurements (SI).
The measurements and the uncertainties with confidence probability are given on the following pages and are part of the certificate.

All calibrations have been conducted in the closed laboratory facility: environment temperature (22 ± 3)°C and humidity < 70%.

Calibration Equipment used (M&TE critical for calibration)

| Primary Standards | ID # | Cal Date (Certificate No.) | Scheduled Calibration |
|---------------------------------|--------------------|-----------------------------------|------------------------|
| Power meter NRP | SN: 104778 | 03-Apr-19 (No. 217-02892/02893) | Apr-20 |
| Power sensor NRP-Z91 | SN: 103244 | 03-Apr-19 (No. 217-02892) | Apr-20 |
| Power sensor NRP-Z91 | SN: 103245 | 03-Apr-19 (No. 217-02893) | Apr-20 |
| Reference 20 dB Attenuator | SN: 5058 (20k) | 04-Apr-19 (No. 217-02894) | Apr-20 |
| Type-N mismatch combination | SN: 5047.2 / 06327 | 04-Apr-19 (No. 217-02895) | Apr-20 |
| Reference Probe EX3DV4 | SN: 7349 | 29-May-19 (No. EX3-7349_May19) | May-20 |
| DAE4 | SN: 601 | 30-Apr-19 (No. DAE4-601_Apr19) | Apr-20 |
| Secondary Standards | ID # | Check Date (in house) | Scheduled Check |
| Power meter E4419B | SN: GB39512475 | 30-Oct-14 (in house check Feb-19) | In house check: Oct-20 |
| Power sensor HP 8481A | SN: US37292783 | 07-Oct-15 (in house check Oct-18) | In house check: Oct-20 |
| Power sensor HP 8481A | SN: MY41092317 | 07-Oct-15 (in house check Oct-18) | In house check: Oct-20 |
| RF generator R&S SMT-06 | SN: 100972 | 15-Jun-15 (in house check Oct-18) | In house check: Oct-20 |
| Network Analyzer Agilent E8358A | SN: US41080477 | 31-Mar-14 (in house check Oct-19) | In house check: Oct-20 |

| | | | |
|----------------|-------------------------|-----------------------------------|---------------|
| Calibrated by: | Name Claudio Leubler | Function Laboratory Technician | Signature |
| Approved by: | Katja Pokovic | Technical Manager | |

Issued: November 25, 2019

This calibration certificate shall not be reproduced except in full without written approval of the laboratory.



Accredited by the Swiss Accreditation Service (SAS)
The Swiss Accreditation Service is one of the signatories to the EA
Multilateral Agreement for the recognition of calibration certificates

Glossary:

| | |
|-------|---------------------------------|
| TSL | tissue simulating liquid |
| ConvF | sensitivity in TSL / NORM x,y,z |
| N/A | not applicable or not measured |

Calibration is Performed According to the Following Standards:

- IEEE Std 1528-2013, "IEEE Recommended Practice for Determining the Peak Spatial-Averaged Specific Absorption Rate (SAR) in the Human Head from Wireless Communications Devices: Measurement Techniques", June 2013
- IEC 62209-1, "Measurement procedure for the assessment of Specific Absorption Rate (SAR) from hand-held and body-mounted devices used next to the ear (frequency range of 300 MHz to 6 GHz)", July 2016
- IEC 62209-2, "Procedure to determine the Specific Absorption Rate (SAR) for wireless communication devices used in close proximity to the human body (frequency range of 30 MHz to 6 GHz)", March 2010
- KDB 865664, "SAR Measurement Requirements for 100 MHz to 6 GHz"

Additional Documentation:

- DASY4/5 System Handbook

Methods Applied and Interpretation of Parameters:

- Measurement Conditions:* Further details are available from the Validation Report at the end of the certificate. All figures stated in the certificate are valid at the frequency indicated.
- Antenna Parameters with TSL:* The dipole is mounted with the spacer to position its feed point exactly below the center marking of the flat phantom section, with the arms oriented parallel to the body axis.
- Feed Point Impedance and Return Loss:* These parameters are measured with the dipole positioned under the liquid filled phantom. The impedance stated is transformed from the measurement at the SMA connector to the feed point. The Return Loss ensures low reflected power. No uncertainty required.
- Electrical Delay:* One-way delay between the SMA connector and the antenna feed point. No uncertainty required.
- SAR measured:* SAR measured at the stated antenna input power.
- SAR normalized:* SAR as measured, normalized to an input power of 1 W at the antenna connector.
- SAR for nominal TSL parameters:* The measured TSL parameters are used to calculate the nominal SAR result.

The reported uncertainty of measurement is stated as the standard uncertainty of measurement multiplied by the coverage factor $k=2$, which for a normal distribution corresponds to a coverage probability of approximately 95%.

Measurement Conditions

DASY system configuration, as far as not given on page 1.

| | | |
|------------------------------|------------------------|-------------|
| DASY Version | DASY5 | V52.10.3 |
| Extrapolation | Advanced Extrapolation | |
| Phantom | Modular Flat Phantom | |
| Distance Dipole Center - TSL | 10 mm | with Spacer |
| Zoom Scan Resolution | dx, dy, dz = 5 mm | |
| Frequency | 2450 MHz ± 1 MHz | |

Head TSL parameters

The following parameters and calculations were applied.

| | Temperature | Permittivity | Conductivity |
|---|-----------------|--------------|------------------|
| Nominal Head TSL parameters | 22.0 °C | 39.2 | 1.80 mho/m |
| Measured Head TSL parameters | (22.0 ± 0.2) °C | 38.2 ± 6 % | 1.84 mho/m ± 6 % |
| Head TSL temperature change during test | < 0.5 °C | ---- | ---- |

SAR result with Head TSL

| SAR averaged over 1 cm ³ (1 g) of Head TSL | Condition | |
|---|--------------------|---------------------------------|
| SAR measured | 250 mW input power | 13.5 W/kg |
| SAR for nominal Head TSL parameters | normalized to 1W | 53.1 W/kg ± 17.0 % (k=2) |

| SAR averaged over 10 cm ³ (10 g) of Head TSL | condition | |
|---|--------------------|---------------------------------|
| SAR measured | 250 mW input power | 6.22 W/kg |
| SAR for nominal Head TSL parameters | normalized to 1W | 24.6 W/kg ± 16.5 % (k=2) |

Body TSL parameters

The following parameters and calculations were applied.

| | Temperature | Permittivity | Conductivity |
|---|-----------------|--------------|------------------|
| Nominal Body TSL parameters | 22.0 °C | 52.7 | 1.95 mho/m |
| Measured Body TSL parameters | (22.0 ± 0.2) °C | 50.8 ± 6 % | 2.01 mho/m ± 6 % |
| Body TSL temperature change during test | < 0.5 °C | ---- | ---- |

SAR result with Body TSL

| SAR averaged over 1 cm ³ (1 g) of Body TSL | Condition | |
|---|--------------------|---------------------------------|
| SAR measured | 250 mW input power | 13.3 W/kg |
| SAR for nominal Body TSL parameters | normalized to 1W | 52.0 W/kg ± 17.0 % (k=2) |

| SAR averaged over 10 cm ³ (10 g) of Body TSL | condition | |
|---|--------------------|---------------------------------|
| SAR measured | 250 mW input power | 6.17 W/kg |
| SAR for nominal Body TSL parameters | normalized to 1W | 24.3 W/kg ± 16.5 % (k=2) |

Appendix (Additional assessments outside the scope of SCS 0108)

Antenna Parameters with Head TSL

| | |
|--------------------------------------|--------------------------------|
| Impedance, transformed to feed point | 54.4 Ω + 3.8 j Ω |
| Return Loss | - 25.2 dB |

Antenna Parameters with Body TSL

| | |
|--------------------------------------|--------------------------------|
| Impedance, transformed to feed point | 51.2 Ω + 5.1 j Ω |
| Return Loss | - 25.8 dB |

General Antenna Parameters and Design

| | |
|----------------------------------|----------|
| Electrical Delay (one direction) | 1.158 ns |
|----------------------------------|----------|

After long term use with 100W radiated power, only a slight warming of the dipole near the feedpoint can be measured.

The dipole is made of standard semirigid coaxial cable. The center conductor of the feeding line is directly connected to the second arm of the dipole. The antenna is therefore short-circuited for DC-signals. On some of the dipoles, small end caps are added to the dipole arms in order to improve matching when loaded according to the position as explained in the "Measurement Conditions" paragraph. The SAR data are not affected by this change. The overall dipole length is still according to the Standard.

No excessive force must be applied to the dipole arms, because they might bend or the soldered connections near the feedpoint may be damaged.

Additional EUT Data

| | |
|-----------------|-------|
| Manufactured by | SPEAG |
|-----------------|-------|

DASY5 Validation Report for Head TSL

Date: 21.11.2019

Test Laboratory: SPEAG, Zurich, Switzerland

DUT: Dipole 2450 MHz; Type: D2450V2; Serial: D2450V2 - SN:930

Communication System: UID 0 - CW; Frequency: 2450 MHz

Medium parameters used: $f = 2450$ MHz; $\sigma = 1.84$ S/m; $\epsilon_r = 38.2$; $\rho = 1000$ kg/m³

Phantom section: Flat Section

Measurement Standard: DASY5 (IEEE/IEC/ANSI C63.19-2011)

DASY52 Configuration:

- Probe: EX3DV4 - SN7349; ConvF(7.9, 7.9, 7.9) @ 2450 MHz; Calibrated: 29.05.2019
- Sensor-Surface: 1.4mm (Mechanical Surface Detection)
- Electronics: DAE4 Sn601; Calibrated: 30.04.2019
- Phantom: Flat Phantom 5.0 (front); Type: QD 000 P50 AA; Serial: 1001
- DASY52 52.10.3(1513); SEMCAD X 14.6.13(7474)

Dipole Calibration for Head Tissue/Pin=250 mW, d=10mm/Zoom Scan (7x7x7)/Cube 0:

Measurement grid: dx=5mm, dy=5mm, dz=5mm

Reference Value = 117.5 V/m; Power Drift = 0.07 dB

Peak SAR (extrapolated) = 26.6 W/kg

SAR(1 g) = 13.5 W/kg; SAR(10 g) = 6.22 W/kg

Smallest distance from peaks to all points 3 dB below = 9 mm

Ratio of SAR at M2 to SAR at M1 = 50.8%

Maximum value of SAR (measured) = 22.0 W/kg

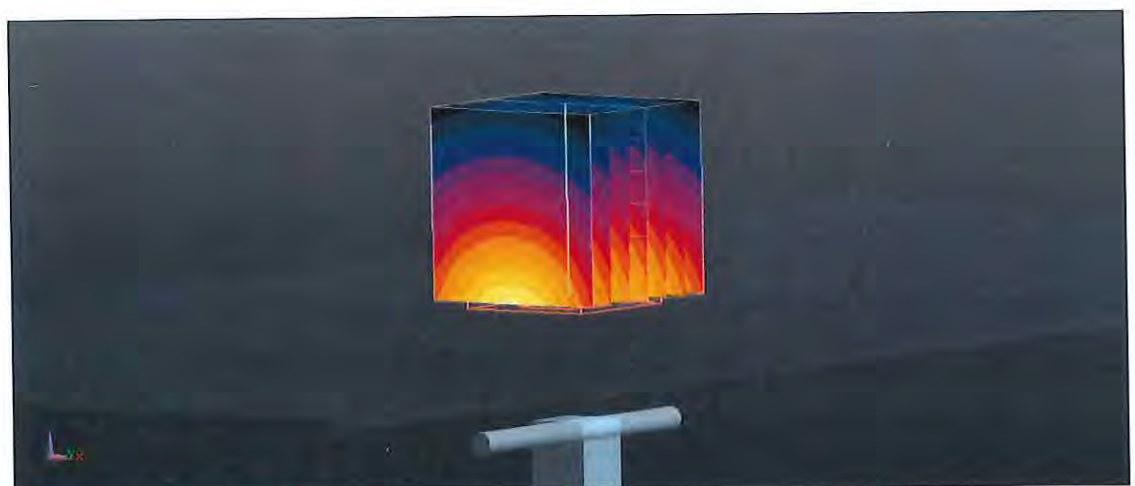
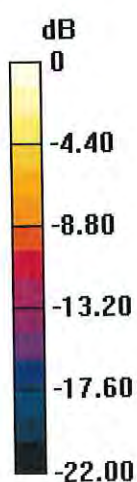

0 dB = 22.0 W/kg = 13.42 dBW/kg

Impedance Measurement Plot for Head TSL

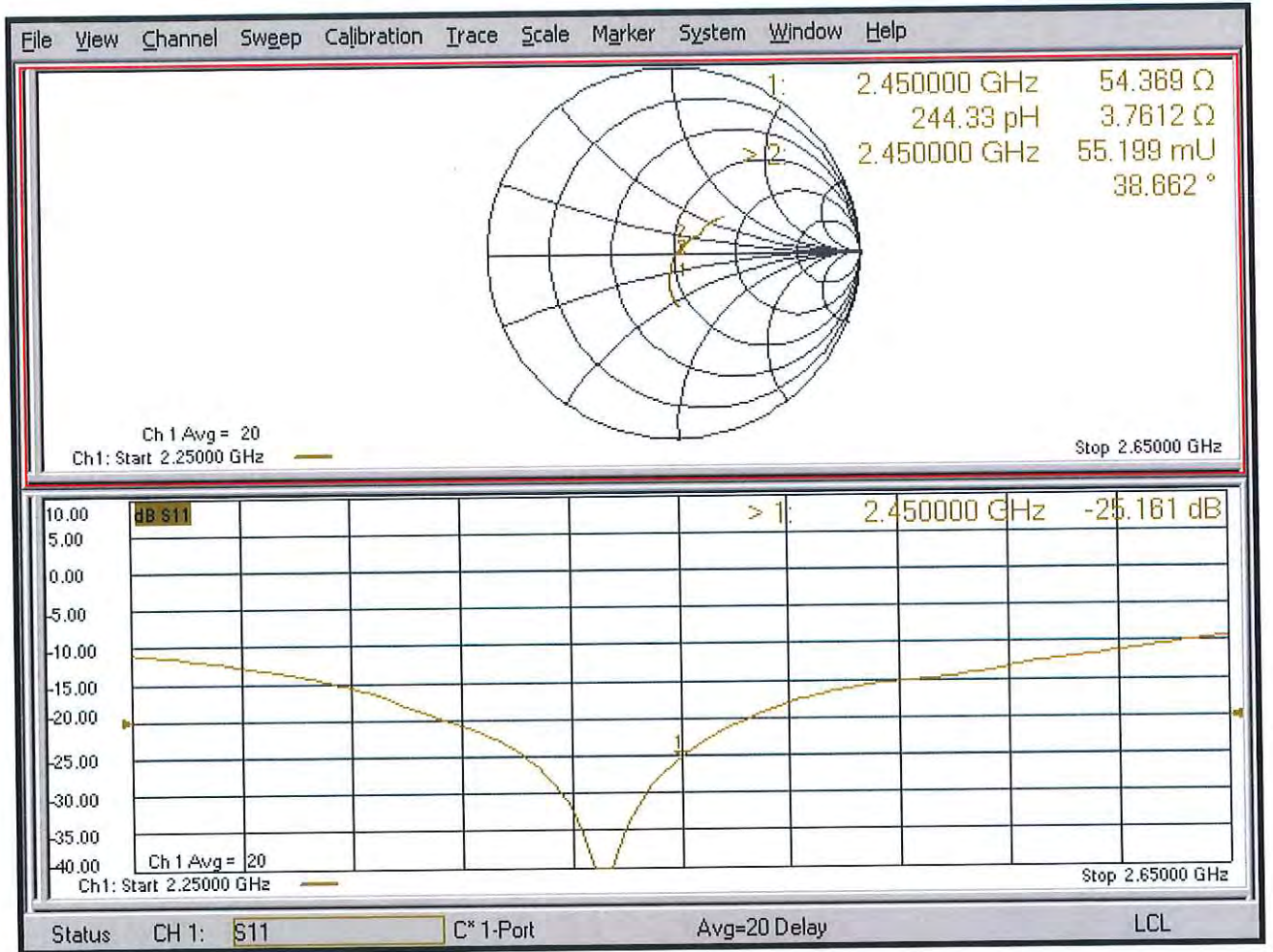

DASY5 Validation Report for Body TSL

Date: 21.11.2019

Test Laboratory: SPEAG, Zurich, Switzerland

DUT: Dipole 2450 MHz; Type: D2450V2; Serial: D2450V2 - SN:930

Communication System: UID 0 - CW; Frequency: 2450 MHz

Medium parameters used: $f = 2450$ MHz; $\sigma = 2.01$ S/m; $\epsilon_r = 50.8$; $\rho = 1000$ kg/m³

Phantom section: Flat Section

Measurement Standard: DASY5 (IEEE/IEC/ANSI C63.19-2011)

DASY52 Configuration:

- Probe: EX3DV4 - SN7349; ConvF(7.94, 7.94, 7.94) @ 2450 MHz; Calibrated: 29.05.2019
- Sensor-Surface: 1.4mm (Mechanical Surface Detection)
- Electronics: DAE4 Sn601; Calibrated: 30.04.2019
- Phantom: Flat Phantom 5.0 (back); Type: QD 000 P50 AA; Serial: 1002
- DASY52 52.10.3(1513); SEMCAD X 14.6.13(7474)

Dipole Calibration for Body Tissue/Pin=250 mW, d=10mm/Zoom Scan (7x7x7)/Cube 0:

Measurement grid: dx=5mm, dy=5mm, dz=5mm

Reference Value = 110.8 V/m; Power Drift = -0.03 dB

Peak SAR (extrapolated) = 26.5 W/kg

SAR(1 g) = 13.3 W/kg; SAR(10 g) = 6.17 W/kg

Smallest distance from peaks to all points 3 dB below = 8.5 mm

Ratio of SAR at M2 to SAR at M1 = 51%

Maximum value of SAR (measured) = 21.9 W/kg

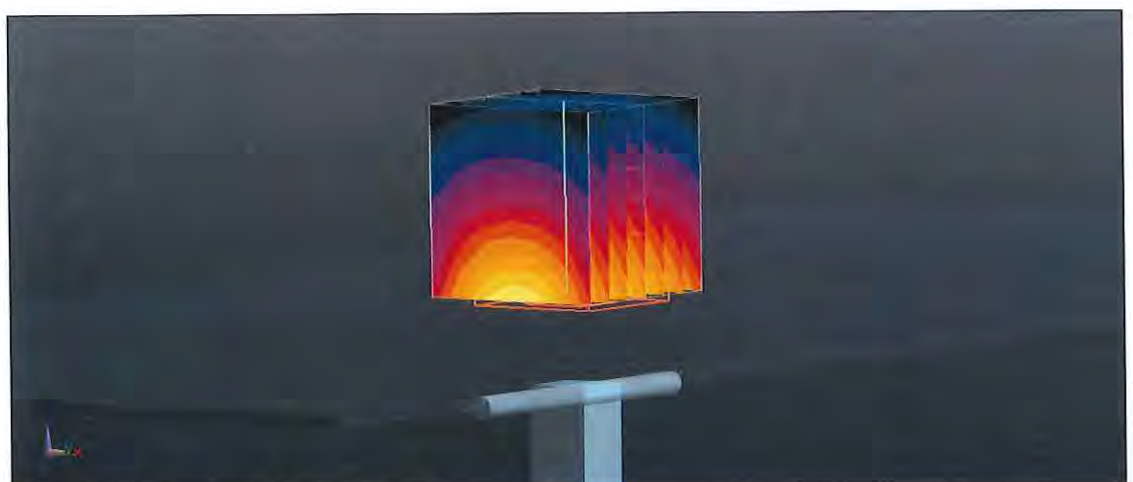
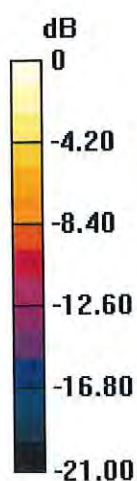

0 dB = 21.9 W/kg = 13.40 dBW/kg

Impedance Measurement Plot for Body TSL

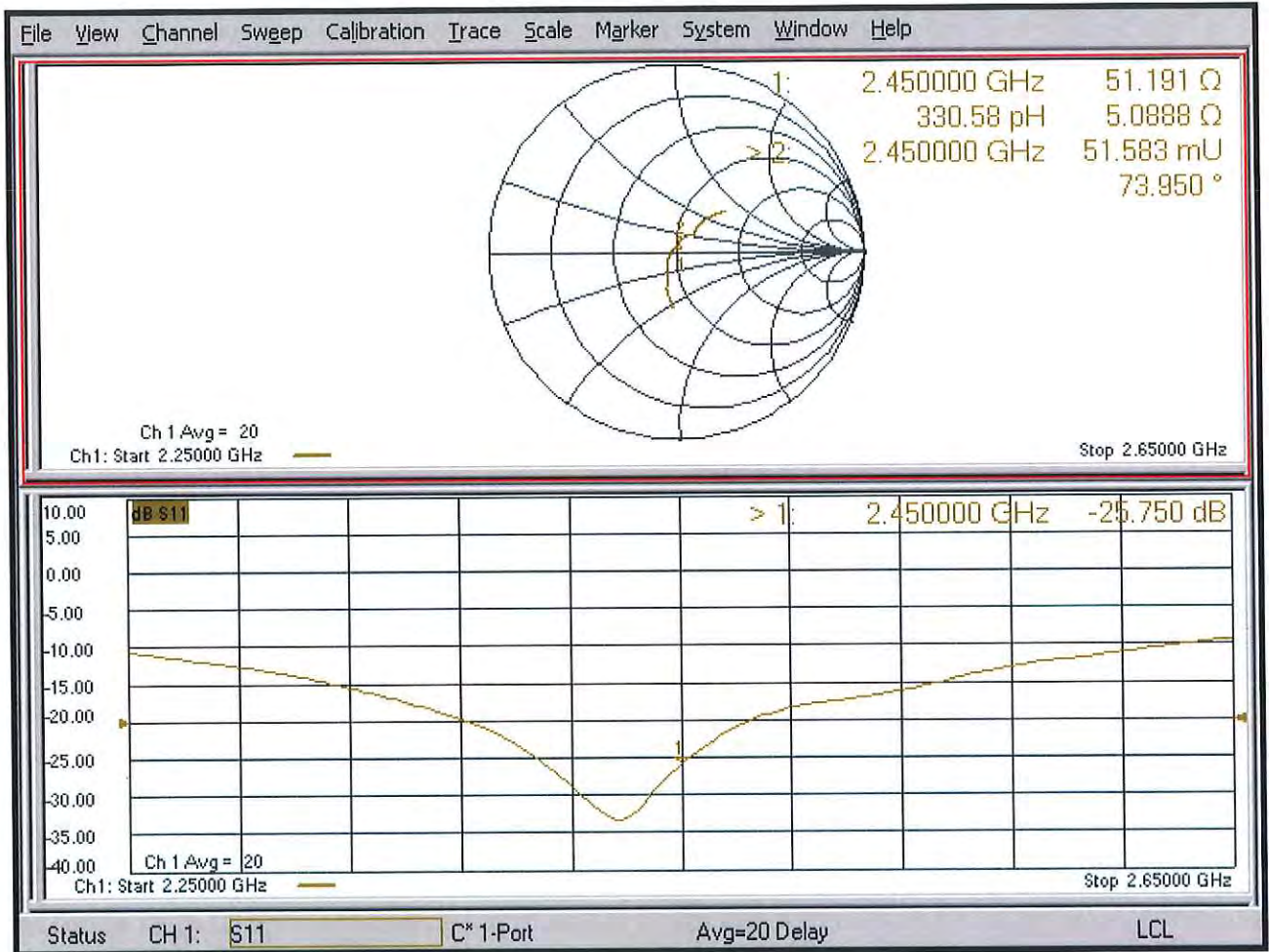



Accredited by the Swiss Accreditation Service (SAS)
The Swiss Accreditation Service is one of the signatories to the EA
Multilateral Agreement for the recognition of calibration certificates

Accreditation No.: **SCS 0108**

Client **DEKRA (Auden)**

Certificate No: **D5GHzV2-1041_May20**

CALIBRATION CERTIFICATE

Object **D5GHzV2 - SN:1041**

Calibration procedure(s) **QA CAL-22.v4
Calibration Procedure for SAR Validation Sources between 3-6 GHz**

Calibration date: **May 25, 2020**

This calibration certificate documents the traceability to national standards, which realize the physical units of measurements (SI).
The measurements and the uncertainties with confidence probability are given on the following pages and are part of the certificate.

All calibrations have been conducted in the closed laboratory facility: environment temperature (22 ± 3)°C and humidity < 70%.

Calibration Equipment used (M&TE critical for calibration)

| Primary Standards | ID # | Cal Date (Certificate No.) | Scheduled Calibration |
|-----------------------------|--------------------|---------------------------------|-----------------------|
| Power meter NRP | SN: 104778 | 01-Apr-20 (No. 217-03100/03101) | Apr-21 |
| Power sensor NRP-Z91 | SN: 103244 | 01-Apr-20 (No. 217-03100) | Apr-21 |
| Power sensor NRP-Z91 | SN: 103245 | 01-Apr-20 (No. 217-03101) | Apr-21 |
| Reference 20 dB Attenuator | SN: BH9394 (20k) | 31-Mar-20 (No. 217-03106) | Apr-21 |
| Type-N mismatch combination | SN: 310982 / 06327 | 31-Mar-20 (No. 217-03104) | Apr-21 |
| Reference Probe EX3DV4 | SN: 3503 | 31-Dec-19 (No. EX3-3503_Dec19) | Dec-20 |
| DAE4 | SN: 601 | 27-Dec-19 (No. DAE4-601_Dec19) | Dec-20 |

| Secondary Standards | ID # | Check Date (in house) | Scheduled Check |
|---------------------------------|----------------|-----------------------------------|------------------------|
| Power meter E4419B | SN: GB39512475 | 30-Oct-14 (in house check Feb-19) | In house check: Oct-20 |
| Power sensor HP 8481A | SN: US37292783 | 07-Oct-15 (in house check Oct-18) | In house check: Oct-20 |
| Power sensor HP 8481A | SN: MY41092317 | 07-Oct-15 (in house check Oct-18) | In house check: Oct-20 |
| RF generator R&S SMT-06 | SN: 100972 | 15-Jun-15 (in house check Oct-18) | In house check: Oct-20 |
| Network Analyzer Agilent E8358A | SN: US41080477 | 31-Mar-14 (in house check Oct-19) | In house check: Oct-20 |

| | | | |
|----------------|------------------------------|-----------------------------------|---------------|
| Calibrated by: | Name Michael Weber | Function Laboratory Technician | Signature |
|----------------|------------------------------|-----------------------------------|---------------|

| | | | |
|--------------|------------------------------|-------------------------------|---------------|
| Approved by: | Name Katja Pokovic | Function Technical Manager | Signature |
|--------------|------------------------------|-------------------------------|---------------|

Issued: May 26, 2020

This calibration certificate shall not be reproduced except in full without written approval of the laboratory.



Accredited by the Swiss Accreditation Service (SAS)

The Swiss Accreditation Service is one of the signatories to the EA
Multilateral Agreement for the recognition of calibration certificates

Accreditation No.: **SCS 0108**

Glossary:

| | |
|-------|---------------------------------|
| TSL | tissue simulating liquid |
| ConvF | sensitivity in TSL / NORM x,y,z |
| N/A | not applicable or not measured |

Calibration is Performed According to the Following Standards:

- IEEE Std 1528-2013, "IEEE Recommended Practice for Determining the Peak Spatial-Averaged Specific Absorption Rate (SAR) in the Human Head from Wireless Communications Devices: Measurement Techniques", June 2013
- IEC 62209-1, "Measurement procedure for the assessment of Specific Absorption Rate (SAR) from hand-held and body-mounted devices used next to the ear (frequency range of 300 MHz to 6 GHz)", July 2016
- IEC 62209-2, "Procedure to determine the Specific Absorption Rate (SAR) for wireless communication devices used in close proximity to the human body (frequency range of 30 MHz to 6 GHz)", March 2010
- KDB 865664, "SAR Measurement Requirements for 100 MHz to 6 GHz"

Additional Documentation:

- DASY4/5 System Handbook

Methods Applied and Interpretation of Parameters:

- Measurement Conditions:** Further details are available from the Validation Report at the end of the certificate. All figures stated in the certificate are valid at the frequency indicated.
- Antenna Parameters with TSL:** The dipole is mounted with the spacer to position its feed point exactly below the center marking of the flat phantom section, with the arms oriented parallel to the body axis.
- Feed Point Impedance and Return Loss:** These parameters are measured with the dipole positioned under the liquid filled phantom. The impedance stated is transformed from the measurement at the SMA connector to the feed point. The Return Loss ensures low reflected power. No uncertainty required.
- Electrical Delay:** One-way delay between the SMA connector and the antenna feed point. No uncertainty required.
- SAR measured:** SAR measured at the stated antenna input power.
- SAR normalized:** SAR as measured, normalized to an input power of 1 W at the antenna connector.
- SAR for nominal TSL parameters:** The measured TSL parameters are used to calculate the nominal SAR result.

The reported uncertainty of measurement is stated as the standard uncertainty of measurement multiplied by the coverage factor $k=2$, which for a normal distribution corresponds to a coverage probability of approximately 95%.

Measurement Conditions

DASY system configuration, as far as not given on page 1.

| | | |
|-------------------------------------|--|----------------------------------|
| DASY Version | DASY5 | V52.10.4 |
| Extrapolation | Advanced Extrapolation | |
| Phantom | Modular Flat Phantom V5.0 | |
| Distance Dipole Center - TSL | 10 mm | with Spacer |
| Zoom Scan Resolution | dx, dy = 10.0 mm, dz = 10.0 mm | Graded Ratio = 1.4 (Z direction) |
| Frequency | 5250 MHz ± 1 MHz 5600 MHz ± 1 MHz 5800 MHz ± 1 MHz | |

Head TSL parameters at 5250 MHz

The following parameters and calculations were applied.

| | Temperature | Permittivity | Conductivity |
|--|-----------------|--------------|------------------|
| Nominal Head TSL parameters | 22.0 °C | 35.9 | 4.71 mho/m |
| Measured Head TSL parameters | (22.0 ± 0.2) °C | 35.3 ± 6 % | 4.55 mho/m ± 6 % |
| Head TSL temperature change during test | < 0.5 °C | ---- | ---- |

SAR result with Head TSL at 5250 MHz

| SAR averaged over 1 cm³ (1 g) of Head TSL | Condition | |
|---|--------------------|---------------------------------|
| SAR measured | 100 mW input power | 8.20 W/kg |
| SAR for nominal Head TSL parameters | normalized to 1W | 81.6 W/kg ± 19.9 % (k=2) |

| SAR averaged over 10 cm³ (10 g) of Head TSL | condition | |
|---|--------------------|---------------------------------|
| SAR measured | 100 mW input power | 2.33 W/kg |
| SAR for nominal Head TSL parameters | normalized to 1W | 23.2 W/kg ± 19.5 % (k=2) |

Head TSL parameters at 5600 MHz

The following parameters and calculations were applied.

| | Temperature | Permittivity | Conductivity |
|--|-----------------|--------------|------------------|
| Nominal Head TSL parameters | 22.0 °C | 35.5 | 5.07 mho/m |
| Measured Head TSL parameters | (22.0 ± 0.2) °C | 34.8 ± 6 % | 4.90 mho/m ± 6 % |
| Head TSL temperature change during test | < 0.5 °C | ---- | ---- |

SAR result with Head TSL at 5600 MHz

| SAR averaged over 1 cm³ (1 g) of Head TSL | Condition | |
|---|--------------------|---------------------------------|
| SAR measured | 100 mW input power | 8.63 W/kg |
| SAR for nominal Head TSL parameters | normalized to 1W | 85.9 W/kg ± 19.9 % (k=2) |

| SAR averaged over 10 cm³ (10 g) of Head TSL | condition | |
|---|--------------------|---------------------------------|
| SAR measured | 100 mW input power | 2.43 W/kg |
| SAR for nominal Head TSL parameters | normalized to 1W | 24.2 W/kg ± 19.5 % (k=2) |

Head TSL parameters at 5800 MHz

The following parameters and calculations were applied.

| | Temperature | Permittivity | Conductivity |
|---|-----------------|--------------|------------------|
| Nominal Head TSL parameters | 22.0 °C | 35.3 | 5.27 mho/m |
| Measured Head TSL parameters | (22.0 ± 0.2) °C | 34.5 ± 6 % | 5.11 mho/m ± 6 % |
| Head TSL temperature change during test | < 0.5 °C | ---- | ---- |

SAR result with Head TSL at 5800 MHz

| SAR averaged over 1 cm ³ (1 g) of Head TSL | Condition | |
|---|--------------------|---------------------------------|
| SAR measured | 100 mW input power | 8.25 W/kg |
| SAR for nominal Head TSL parameters | normalized to 1W | 82.0 W/kg ± 19.9 % (k=2) |

| SAR averaged over 10 cm ³ (10 g) of Head TSL | condition | |
|---|--------------------|---------------------------------|
| SAR measured | 100 mW input power | 2.30 W/kg |
| SAR for nominal Head TSL parameters | normalized to 1W | 22.8 W/kg ± 19.5 % (k=2) |

Appendix (Additional assessments outside the scope of SCS 0108)

Antenna Parameters with Head TSL at 5250 MHz

| | |
|--------------------------------------|--------------------------------|
| Impedance, transformed to feed point | 49.0 Ω - 4.4 j Ω |
| Return Loss | - 26.9 dB |

Antenna Parameters with Head TSL at 5600 MHz

| | |
|--------------------------------------|--------------------------------|
| Impedance, transformed to feed point | 56.3 Ω - 1.2 j Ω |
| Return Loss | - 24.4 dB |

Antenna Parameters with Head TSL at 5800 MHz

| | |
|--------------------------------------|--------------------------------|
| Impedance, transformed to feed point | 54.3 Ω - 2.1 j Ω |
| Return Loss | - 26.8 dB |

General Antenna Parameters and Design

| | |
|----------------------------------|----------|
| Electrical Delay (one direction) | 1.197 ns |
|----------------------------------|----------|

After long term use with 100W radiated power, only a slight warming of the dipole near the feedpoint can be measured.

The dipole is made of standard semirigid coaxial cable. The center conductor of the feeding line is directly connected to the second arm of the dipole. The antenna is therefore short-circuited for DC-signals. On some of the dipoles, small end caps are added to the dipole arms in order to improve matching when loaded according to the position as explained in the "Measurement Conditions" paragraph. The SAR data are not affected by this change. The overall dipole length is still according to the Standard.

No excessive force must be applied to the dipole arms, because they might bend or the soldered connections near the feedpoint may be damaged.

Additional EUT Data

| | |
|-----------------|-------|
| Manufactured by | SPEAG |
|-----------------|-------|

DASY5 Validation Report for Head TSL

Date: 25.05.2020

Test Laboratory: SPEAG, Zurich, Switzerland

DUT: Dipole D5GHzV2; Type: D5GHzV2; Serial: D5GHzV2 - SN:1041

Communication System: UID 0 - CW; Frequency: 5250 MHz, Frequency: 5600 MHz, Frequency: 5800 MHz

Medium parameters used: $f = 5250$ MHz; $\sigma = 4.55$ S/m; $\epsilon_r = 35.3$; $\rho = 1000$ kg/m³,

Medium parameters used: $f = 5600$ MHz; $\sigma = 4.9$ S/m; $\epsilon_r = 34.8$; $\rho = 1000$ kg/m³,

Medium parameters used: $f = 5800$ MHz; $\sigma = 5.11$ S/m; $\epsilon_r = 34.5$; $\rho = 1000$ kg/m³

Phantom section: Flat Section

Measurement Standard: DASY5 (IEEE/IEC/ANSI C63.19-2011)

DASY52 Configuration:

- Probe: EX3DV4 - SN3503; ConvF(5.5, 5.5, 5.5) @ 5250 MHz, ConvF(5.1, 5.1, 5.1) @ 5600 MHz, ConvF(5.01, 5.01, 5.01) @ 5800 MHz; Calibrated: 31.12.2019
- Sensor-Surface: 1.4mm (Mechanical Surface Detection)
- Electronics: DAE4 Sn601; Calibrated: 27.12.2019
- Phantom: Flat Phantom 5.0 (front); Type: QD 000 P50 AA; Serial: 1001
- DASY52 52.10.4(1527); SEMCAD X 14.6.14(7483)

Dipole Calibration for Head Tissue/Pin=100mW, dist=10mm, f=5250 MHz/Zoom Scan, dist=1.4mm (8x8x7)/Cube 0: Measurement grid: dx=4mm, dy=4mm, dz=1.4mm

Reference Value = 79.63 V/m; Power Drift = 0.04 dB

Peak SAR (extrapolated) = 28.8 W/kg

SAR(1 g) = 8.20 W/kg; SAR(10 g) = 2.33 W/kg

Smallest distance from peaks to all points 3 dB below = 7.2 mm

Ratio of SAR at M2 to SAR at M1 = 69.4%

Maximum value of SAR (measured) = 18.9 W/kg

Dipole Calibration for Head Tissue/Pin=100mW, dist=10mm, f=5600 MHz/Zoom Scan, dist=1.4mm (8x8x7)/Cube 0: Measurement grid: dx=4mm, dy=4mm, dz=1.4mm

Reference Value = 79.80 V/m; Power Drift = 0.05 dB

Peak SAR (extrapolated) = 32.6 W/kg

SAR(1 g) = 8.63 W/kg; SAR(10 g) = 2.43 W/kg

Smallest distance from peaks to all points 3 dB below = 7.4 mm

Ratio of SAR at M2 to SAR at M1 = 66.8%

Maximum value of SAR (measured) = 20.6 W/kg

Dipole Calibration for Head Tissue/Pin=100mW, dist=10mm, f=5800 MHz/Zoom Scan, dist=1.4mm (8x8x7)/Cube 0: Measurement grid: dx=4mm, dy=4mm, dz=1.4mm

Reference Value = 77.63 V/m; Power Drift = 0.04 dB

Peak SAR (extrapolated) = 33.4 W/kg

SAR(1 g) = 8.25 W/kg; SAR(10 g) = 2.30 W/kg

Smallest distance from peaks to all points 3 dB below = 7.2 mm

Ratio of SAR at M2 to SAR at M1 = 64.8%

Maximum value of SAR (measured) = 20.2 W/kg

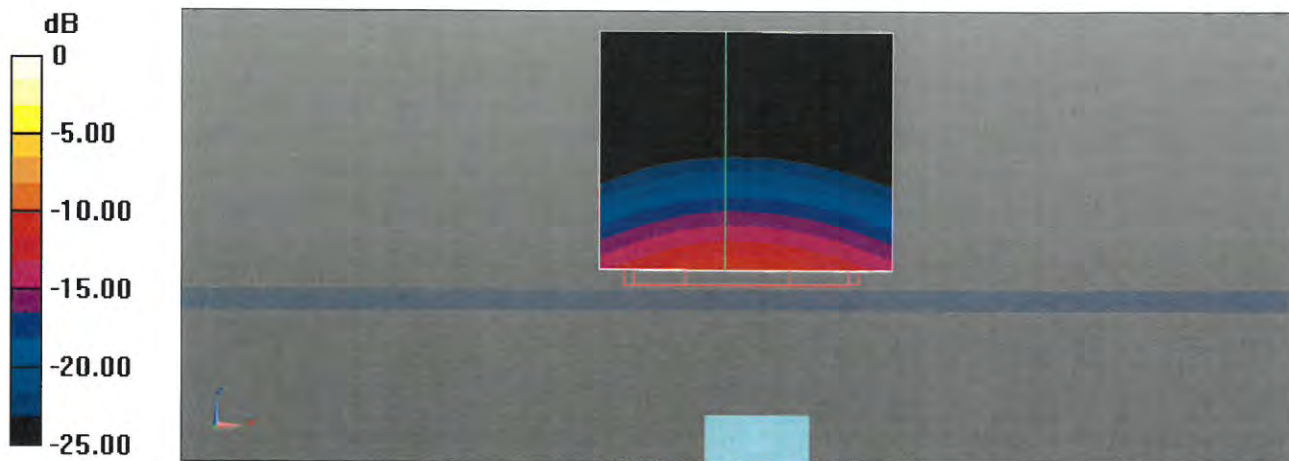

0 dB = 20.6 W/kg = 13.13 dBW/kg

Impedance Measurement Plot for Head TSL

