

**ELECTRONIC TECHNOLOGY SYSTEMS
DR. GENZ GMBH**

FCC TEST - REPORT

FCC RULES PARTS 74 Subpart H, Section 74.861

FCC ID : CINUH-2000

Test report no.:

W6M20405-5191-C-1

TABLE OF CONTENTS

| | | |
|----------|--|-----------|
| 1 | GENERAL INFORMATION | 3 |
| 1.1 | NOTES | 3 |
| 1.2 | TESTING LABORATORY | 4 |
| 1.2.1 | <i>Location</i> | 4 |
| 1.2.2 | <i>Details of accreditation status</i> | 4 |
| 1.3 | DETAILS OF APPROVAL HOLDER | 4 |
| 1.4 | APPLICATION DETAILS | 5 |
| 1.5 | GENERAL INFORMATION OF TEST ITEM | 5 |
| | TECHNICAL DATA | 5 |
| 1.6 | TEST STANDARDS | 6 |
| 2 | TECHNICAL TEST | 6 |
| 2.1 | SUMMARY OF TEST RESULTS | 6 |
| 2.2 | TEST ENVIRONMENT | 6 |
| 2.3 | TEST EQUIPMENT LIST | 7 |
| 2.4 | GENERAL TEST PROCEDURE | 20 |
| 3 | TEST RESULTS (ENCLOSURE)..... | 21 |
| 4 | RF POWER OUTPUT (CONDUCTED) , FCC 2.1046 (A) ; 74.861 (E)..... | 22 |
| 4.1 | TEST PROCEDURE | 22 |
| 4.2 | TEST RESULTS | 22 |
| 5 | RADIATED POWER | 23 |
| 5.1 | TEST PROCEDURE | 23 |
| 5.2 | TEST RESULTS | 24 |
| 6 | MODULATION DEVIATION , FCC 2.1047 (B) ; 74.861(E)..... | 25 |
| 6.1 | TEST PROCEDURE | 25 |
| 6.2 | TEST RESULTS | 25 |
| 7 | AUDIO FREQUENCY RESPONSE , FCC 2.1047 (A) | 26 |
| 7.1 | TEST PROCEDURE | 26 |
| 7.2 | TEST RESULTS | 26 |
| 8 | OCCUPIED BANDWIDTH/EMISSION MASK, FCC 2.1049 (C) ; 74.861 (E)(5)..... | 27 |
| 8.1 | TEST PROCEDURE | 27 |
| 8.2 | TEST RESULTS | 27 |
| 9 | SPURIOUS EMISSIONS AT ANTENNA TERMINALS FCC2.1051 ; 74.861 (E)..... | 28 |
| 9.1 | TEST PROCEDURE | 28 |
| 9.2 | TEST RESULTS | 28 |
| 9.2 | LIMIT | 29 |

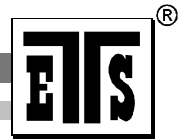

Registration number: W6M20405-5191-C-1
FCC ID: CINUH-2000

10 RADIATED SPURIOUS EMISSION , FCC 2.1053 ; 74.861 (E) 30

10.1 TEST PROCEDURE 30

10.2 TEST RESULTS..... 30

10.3 EXPLANATION OF TEST RESULT 32

10.4 LIMITS..... 32

11 LINE CONDUCTED EMISSION , FCC 15.207 33

11.1 TEST PROCEDURE 33

11.2 TEST RESULTS..... 33

12 FREQUENCY STABILITY VS. TEMPERATURE , FCC 2.1055 , 74.861 (E)..... 34

12.1 TEST PROCEDURE 34

12.2 TEST RESULTS..... 34

13 FREQUENCY STABILITY VS. VOLTAGE , FCC 2.1055 (D) ; 74.861 (E) 36

13.1 TEST PROCEDURE 36

13.2 TEST RESULTS..... 36

APPENDIX 37

APPENDIX A 38

APPENDIX B 39

APPENDIX C 41

APPENDIX D 43

APPENDIX E 44

APPENDIX F 45

APPENDIX G 46

APPENDIX I 48

Registration number: W6M20405-5191-C-1
FCC ID: CINUH-2000

1 General Information

1.1 Notes

The purpose of conformity testing is to increase the probability of adherence to the essential requirements or conformity specifications, as appropriate.

The complexity of the technical specifications, however, means that full and thorough testing is impractical for both technical and economic reasons.

Furthermore, there is no guarantee that a test sample which has Passed all the relevant tests conforms to a specification.

Neither is there any guarantee that such a test sample will interwork with other genuinely open systems.

The existence of the tests nevertheless provides the confidence that the test sample possesses the qualities as maintained and that its performance generally conforms to representative cases of communications equipment.

The test results of this test report relate exclusively to the item tested as specified in 1.5.

The test report may only be reproduced or published in full.

Reproduction or publication of extracts from the report requires the prior written approval of the ELECTRONIC TECHNOLOGY SYSTEMS DR. GENZ GMBH.

Tester:

03.07.2004

Ralf Schultze



Date

ETS-Lab.

Name

Signature

Technical responsibility for area of testing:

03.07.2004

N. Kasper



Date

ETS

Name

Signature



Registration number: W6M20405-5191-C-1
FCC ID: CINUH-2000

1.2 Testing laboratory

1.2.1 Location

ELECTRONIC TECHNOLOGY SYSTEM DR. GENZ GMBH (ETS)
Storkower Straße 38c
D-15526 Reichenwalde b. Berlin
Germany
Telefon : +49 33631 888 00
Telefax : +49 33631 888 66

1.2.2 Details of accreditation status

Accredited testing laboratory
DAR-REGISTRATION NUMBER: TTI-P-G 126/96

Accredited Competent Body
DAR-REGISTRATION NUMBER: BPT-ZE-026/96

FCC FILED TEST LABORATORY REG. No. 96970

BLUETOOTH QUALIFICATION TEST FACILITY (BQTF)
ACCREDITED BY:BLUETOOTH QUALIFICATION REVIEW BOARD (BQRF)

INDUSTRY CANADA FILED TEST LABORATORY REG. No. IC 3470

A2LA ACCREDITED Certificate Number: 1983-01

1.3 Details of approval holder

Name : Chiayo Electronics Co., Ltd.
Street : No. 88, Chung Hsiao Street 2
Town : Chiayi
Country : Taiwan , R.O.C.
Telephone : +886-5-271-1000
Fax : +886-5-276-7611

Contact : Ms. Teresa Hung
Telephone : +886-5-271-1000

Registration number: W6M20405-5191-C-1

FCC ID: CINUH-2000

1.4 Application details

Date of receipt of application : 25.05.2004
 Date of receipt of test sample : 26.05.2004
 Date of test : from 26.05.2004 to 15.06.2004

1.5 General information of Test item

Type of test item : Wireless Microphone Transmitter
 Model Number : UH-2000
 Brand Name : Chiayo
 Serial number : without
 Photos : see Annex

Technical data

Frequency band :

| Frequency(MHz) | TV Band | Used Band |
|-----------------|-------------------------------------|-------------------------------------|
| 26.100-26.480 | <input type="checkbox"/> | <input type="checkbox"/> |
| 54.000-72.000 | <input checked="" type="checkbox"/> | <input type="checkbox"/> |
| 76.000-88.000 | <input checked="" type="checkbox"/> | <input type="checkbox"/> |
| 161.625-161.775 | <input type="checkbox"/> | <input type="checkbox"/> |
| 174.000-216.000 | <input checked="" type="checkbox"/> | <input type="checkbox"/> |
| 450.000-451.000 | <input type="checkbox"/> | <input type="checkbox"/> |
| 455.000-456.000 | <input type="checkbox"/> | <input type="checkbox"/> |
| 470.000-488.000 | <input type="checkbox"/> | <input type="checkbox"/> |
| 488.000-494.000 | <input checked="" type="checkbox"/> | <input type="checkbox"/> |
| 494.000-608.000 | <input checked="" type="checkbox"/> | <input type="checkbox"/> |
| 614.000-806.000 | <input checked="" type="checkbox"/> | <input checked="" type="checkbox"/> |
| 944.000-952.000 | <input type="checkbox"/> | <input type="checkbox"/> |

Frequency (ch A) : 615 MHz
 Frequency (ch B) : 710 MHz
 Frequency (ch C) : 804.975 MHz

Registration number: W6M20405-5191-C-1

FCC ID: CINUH-2000

Antenna Type : integral
Antenna Gain : 1 dBi
Power supply : 3VDC (1.5V x 2 Battery)
Operation modes : Simplex

Manufacturer:
(if applicable)

Name : ./.
Street : ./.
Town : ./.
Country : ./.

1.6 Test standards

Technical standard : FCC Part 74 Subpart H , section 74.861

Additional information : none

2 Technical test

2.1 Summary of test results

No deviations from the technical specification(s) were ascertained in the course of the tests performed.

or

The deviations as specified in 2.5 were ascertained in the course of the tests performed.

2.2 Test environment

Temperature : 23 °C
Relative humidity content : 20 ... 75 %
Air pressure : 86 ... 103 kPa

Registration number: W6M20405-5191-C-1
FCC ID: CINUH-2000

2.3 Test Equipment List

| No. | Test equipment | Type | Manufacturer |
|----------|--------------------------------|-----------------|--------------------|
| ETS 0001 | Test receiver | ESHS 10 | Rohde & Schwarz |
| ETS 0002 | Test receiver | ESVP | Rohde & Schwarz |
| ETS 0003 | Test receiver | ESVS 10 | Rohde & Schwarz |
| ETS 0004 | Spektrum- and Network-Analyzer | FSMS 26 | Rohde & Schwarz |
| ETS 0005 | Test receiver | SMV 11 | MEB |
| ETS 0006 | Test receiver system | SME 12 | MEB |
| ETS 0008 | Antenna | Loop antenna | Siemens |
| ETS 0009 | Antenna | ARA 2 | MEB |
| ETS 0010 | Antenna | Loop antenna | MEB |
| ETS 0011 | Antenna | van Veen/ Frame | Rohde & Schwarz |
| ETS 0012 | Antenna | HK 116 | Rohde & Schwarz |
| ETS 0013 | Antenna | HL 223 | Rohde & Schwarz |
| ETS 0014 | Antenna | HL 025 | Rohde & Schwarz |
| ETS 0015 | Antenna | HL 025 | Rohde & Schwarz |
| ETS 0016 | Precision antenna kit | VHAP | Schwarzbeck |
| ETS 0017 | Precision antenna kit | UHAP | Schwarzbeck |
| ETS 0020 | Antenna | DP 21 | MEB |
| ETS 0021 | Antenna | DP 3 | MEB |
| ETS 0022 | Antenna | SAS-200/ 521 | A.H. Systeme+D65 |
| ETS 0023 | Antenna | DP 1 | MEB |
| ETS 0024 | Antenna mast | AF 2 | MEB |
| ETS 0025 | Antenna mast | AF 2 | MEB |
| ETS 0026 | Tripod | | Heinrich Deisel |
| ETS 0027 | Tripod | | Heinrich Deisel |
| ETS 0028 | Tripod | STA 2 | C. Lorenz AG |
| ETS 0029 | Tripod | | Berlebach |
| ETS 0031 | Turn table | DS 412 | Heinrich Deisel |
| ETS 0032 | Controller | HD 050 | Heinrich Deisel |
| ETS 0033 | RF generator | SMG | Rohde & Schwarz |
| ETS 0034 | RF generator/ Amplifier | SMLR | Rohde & Schwarz |
| ETS 0035 | RF generator/ Amplifier | SMLM | Rohde & Schwarz |
| ETS 0038 | RF amplifier | 150L | Amplifier Research |
| ETS 0039 | Absorbing clamp | MDS 21 | Rohde & Schwarz |
| ETS 0040 | Artificial mains | ESH3-Z5 | Rohde & Schwarz |

Registration number: W6M20405-5191-C-1
FCC ID: CINUH-2000

| No. | Test equipment | Type | Manufacturer |
|----------|------------------------------|-----------------|---------------------|
| ETS 0041 | Artificial mains | ESH3-Z4 | Rohde & Schwarz |
| ETS 0042 | Artificial mains | ESH3-Z6 | Rohde & Schwarz |
| ETS 0044 | Artificial mains | NNB 111 | MEB |
| ETS 0045 | Stripe line | IEC 801-3 | ETS |
| ETS 0046 | Power supply | LTS 006 | RFT |
| ETS 0047 | Power supply | TG 20/ 1 | Statron |
| ETS 0048 | Power supply | TG 20/ 1 | Statron |
| ETS 0049 | Power supply | T 102 | TPW |
| ETS 0050 | Power supply | T 101b | TPW |
| ETS 0051 | Oscilloscope | TDS 640A | Tektronix |
| ETS 0052 | Audio analyzer | UPA 4 | Rohde & Schwarz |
| ETS 0053 | ECAT Controlcentre | CE 40 | Keytek/ EMV |
| ETS 0054 | EFT simulator | E 412 | Keytek/ EMV |
| ETS 0055 | Modul network coupler | E 4551 | Keytek/ EMV |
| ETS 0056 | Blank plug-in | | Keytek/ EMV |
| ETS 0057 | Module SURGE with DC coupler | E 501 | Keytek/ EMV |
| ETS 0058 | Capacitive coupling clamp | E 502 B | Keytek/ EMV |
| ETS 0059 | Kikusui amplfier | PCR 2000L | Keytek/ EMV |
| ETS 0060 | Xitron power analyzer | | Keytek/ EMV |
| ETS 0061 | Power/ Arb (Harm., Ramp) | | Keytek/ EMV |
| ETS 0062 | Reference impedance | | Keytek/ EMV |
| ETS 0063 | Blank plug-in | | Keytek/ EMV |
| ETS 0064 | CDN IEC 1000-4-6 | | Keytek/ EMV |
| ETS 0065 | ESD-generator minizap | | Keytek/ EMV |
| ETS 0066 | EM Injection Clamp | | FCC/ EMV |
| ETS 0067 | Calibration Fixture | IEC 801-2031 CF | FCC/ EMV |
| ETS 0068 | CDN IEC 1000-4-6 | CDN | FCC/ EMV |
| ETS 0069 | EM Radiation Monitor | EMR-20 | Wandel & Goltermann |
| ETS 0070 | PC Transfer set EMR-20 | EMR-20 | Wandel & Goltermann |
| ETS 0071 | Videocamera system | KMB012 | Kocom |
| ETS 0072 | Interphone system | JS-1400 | Jiuh Sheng |
| ETS 0073 | Audio noise meter | GSM 2 | MKD/ RFT |
| ETS 0074 | RF milivoltmeter | QRV 2 | MKD/ RFT |
| ETS 0075 | NF generator | GF 22 | Präcitronic |
| ETS 0076 | Feeding bridge A | SBA 1000 | ESP |
| ETS 0077 | Audio/ Video Filter set | AV 55020 | ETS |

Registration number: W6M20405-5191-C-1

FCC ID: CINUH-2000

| No. | Test equipment | Type | Manufacturer |
|----------|--------------------------------------|----------------|-----------------|
| ETS 0078 | LCR meter | SR 720 | SRS |
| ETS 0079 | Functional generator | MX-2020 | Maxcom |
| ETS 0080 | EMI Software | ES-K1 | Rohde & Schwarz |
| ETS 0081 | EMI Software | ES-K10 | Rohde & Schwarz |
| ETS 0082 | PC Novell network system | Novell | Esotronic |
| ETS 0083 | Apple computer sstem | Performa 630 | Macintosh |
| ETS 0084 | Processcontroler | PSA 15 | Rohde & Schwarz |
| ETS 0085 | Shielded room | SR 1 | Frankonia |
| ETS 0086 | Anechoic chamber | AC 1 | Frankonia |
| ETS 0087 | Climatic cell | HC 4033 | Heraeus |
| ETS 0088 | Colour TV pattern generator | PM 5518-TX VPS | Philips |
| ETS 0089 | Radiocommunication tester | CMS 54 | Rohde & Schwarz |
| ETS 0090 | DECT type approval CTR06 | TS 8930 | Rohde & Schwarz |
| ETS 0091 | RF signal generator | SME 03 | Rohde & Schwarz |
| ETS 0092 | DM-Coder | SME-B11 | Rohde & Schwarz |
| ETS 0093 | Pulse Modulator | SM-B8 | Rohde & Schwarz |
| ETS 0095 | DECT system controller | PSMD | Rohde & Schwarz |
| ETS 0096 | DECT Signalling unit | PSMD-B11 | Rohde & Schwarz |
| ETS 0097 | Rack, 19", 36 HU | TS 89RA | Rohde & Schwarz |
| ETS 0098 | System engineering and software | CS 893BE | Rohde & Schwarz |
| ETS 0099 | Extension unit for basic version | TS 8930B | Rohde & Schwarz |
| ETS 0100 | RF signal generator | SME-06 | Rohde & Schwarz |
| ETS 0101 | DM-Coder | SME-B11 | Rohde & Schwarz |
| ETS 0102 | Pulse modulator | SM-B8 | Rohde & Schwarz |
| ETS 0103 | Pulse generator | SM-B4 | Rohde & Schwarz |
| ETS 0105 | High power synthesizer/ sweeper | SMP 22 / 02 | Rohde & Schwarz |
| ETS 0106 | Frequency extension | SMP-B11 | Rohde & Schwarz |
| ETS 0107 | RF attenuator for SMP 22 | SMP-B15 | Rohde & Schwarz |
| ETS 0108 | DECT protocol tester TBR 22 | TS 1220 | Rohde & Schwarz |
| ETS 0109 | Process controller | PSM 2 | Rohde & Schwarz |
| ETS 0110 | Real time signalling unit | PSMD-B2 | Rohde & Schwarz |
| ETS 0111 | PCM Realtime audio interface for PSM | PSMD-B3 | Rohde & Schwarz |
| ETS 0112 | Synthesizer Module | PSMD-B4 | Rohde & Schwarz |
| ETS 0113 | Keyboard | PSA-Z2 | Rohde & Schwarz |
| ETS 0114 | RF step attenuator | RSG | Rohde & Schwarz |

Registration number: W6M20405-5191-C-1

FCC ID: CINUH-2000

| No. | Test equipment | Type | Manufacturer |
|----------|---------------------------------|---------------|-----------------|
| ETS 0115 | Glide path | | Rohde & Schwarz |
| ETS 0116 | RF Millivoltmeter | URV 55 | Rohde & Schwarz |
| ETS 0117 | Insertion unit | URV-Z2 | Rohde & Schwarz |
| ETS 0118 | Mixer | MFC 1000 | Avcom |
| ETS 0119 | Mixer | MFC 2000 | Avcom |
| ETS 0120 | RF step attenuator | TRI-50-20 | INCO |
| ETS 0121 | Oscilloscope | EO 147A | Serute |
| ETS 0122 | Oscilloscope | 5201 | Dagatron |
| ETS 0123 | RF step attenuator | RBU | Rohde & Schwarz |
| ETS 0124 | Tripod | STA 2 | Rohde & Schwarz |
| ETS 0126 | Uninterruptable power supply | UPS - 1500 | Sendon |
| ETS 0127 | Uninterruptable power supply | UPS - 1000 LC | Sendon |
| ETS 0128 | Uninterruptable power supply | UPS - 1000 | Sendon |
| ETS 0129 | Uninterruptable power supply | UPS - 500 | Sendon |
| ETS 0130 | Uninterruptable power supply | Power saver | Sendon |
| ETS 0131 | Telephone connection box | | Systel |
| ETS 0132 | Frequency doubler | TR-0616 | EMG |
| ETS 0133 | Probe body | P6015 | Tektronix |
| ETS 0134 | Mains filter | MSF | Erika Fiedler |
| ETS 0135 | Measureing switching point | AK 11 | RFT |
| ETS 0136 | Attenuator | 33-6-34 | Weinschel |
| ETS 0137 | Multimeter | YX-360TRA | Mastech |
| ETS 0138 | Multimeter | DT-9410 | Diditec |
| ETS 0139 | Multimeter | ST-9202 | Standard |
| ETS 0140 | High voltage generator | IP 6Wa | TPW |
| ETS 0141 | Sliding bridge | J 573 | RFT |
| ETS 0142 | Impedanz converter | TK 11 | RFT |
| ETS 0143 | Impedanz converter | TK 12 | RFT |
| ETS 0146 | Aktive RF probe | ESH2-Z2 | Rohde & Schwarz |
| ETS 0147 | Probe | TK 103 | MEB |
| ETS 0148 | Test TV | 21PT4301/00 | Philips |
| ETS 0149 | Power divider | ZAPD-21 | MCL |
| ETS 0150 | Switcher | HR07-720 | Wisi |
| ETS 0151 | Interference pulse generator | NSG 500C | Schaffner |
| ETS 0152 | Simulator for Load-Dump-Impulse | NSG 506C (I) | Schaffner |
| ETS 0153 | Simulator for Load-Dump-Impulse | NSG 506C (II) | Schaffner |

Registration number: W6M20405-5191-C-1

FCC ID: CINUH-2000

| No. | Test equipment | Type | Manufacturer |
|----------|---------------------------------------|----------------|-----------------|
| ETS 0154 | Signalgenerator | SMG | Rohde & Schwarz |
| ETS 0155 | Signalgenerator | SMG | Rohde & Schwarz |
| ETS 0156 | Adjacent channel power meter | NKS | Rohde & Schwarz |
| ETS 0157 | TV and Sat-Signalgenerator | VTG 700 | Grundig |
| ETS 0158 | TV and Sat Signalgenerator | VTG 700 | Grundig |
| ETS 0159 | Programmable power supply | TOE 8815 | Toellner |
| ETS 0160 | Protective wire and isolation tester | PI 6001 D | SPS electronic |
| ETS 0161 | Filter system / consumer electronic | | Fiedler |
| ETS 0162 | Acoustic chamber | 403-A | IAC |
| ETS 0163 | Test head | BK 4602 | Brüel & Kjær |
| ETS 0164 | Simulator ear | BK 4185 | Brüel & Kjær |
| ETS 0165 | Simulator mouth | BK 4227 | Brüel & Kjær |
| ETS 0166 | Acoustic calibrator | BK 4231 | Brüel & Kjær |
| ETS 0167 | Communication Analysis System | CAS TE I | HEAD acoustics |
| ETS 0168 | Acoustical test for DECT | CTR 10 | HEAD acoustics |
| ETS 0169 | Measurement - Frontend (analog) | MFE III | HEAD acoustics |
| ETS 0170 | Measurement - Frontend (digital) | MFE IV | HEAD acoustics |
| ETS 0171 | Electronic test cradle | TEH | HEAD acoustics |
| ETS 0172 | Noise generator | HNG III.1 | HEAD acoustics |
| ETS 0173 | Speaker | Canton S Pluss | HEAD acoustics |
| ETS 0174 | Measurement - Frontend line interface | MFE V | HEAD acoustics |
| ETS 0175 | Software Line interface (analog) | COPTZV5 | HEAD acoustics |
| ETS 0176 | Acoustic volt meter | COP 4 | HEAD acoustics |
| ETS 0177 | Feeding bridge B | SBB 1000 | ESP |
| ETS 0178 | Open area test side | 10m | ETS |
| ETS 0180 | Artificial mains | NNB01/RFZ | RFZ |
| ETS 0181 | Test pin for protective wire | PE 156-i | SPS electronic |
| ETS 0182 | Power supply | MX-9300 | Maxcom |
| ETS 0183 | Frequency counter | MX-9300 | Maxcom |
| ETS 0184 | Function generator | MX-9300 | Maxcom |
| ETS 0185 | Digital multimeter | MX-9300 | Maxcom |
| ETS 0186 | Power supply | DF 1730 | WJG |
| ETS 0187 | Power supply | | TPW/RFT |
| ETS 0189 | Spectrum Analyzer | FSEB | Rohde & Schwarz |
| ETS 0190 | Function generator | MX 2020 | Maxcom |

Registration number: W6M20405-5191-C-1
FCC ID: CINUH-2000

| No. | Test equipment | Type | Manufacturer |
|----------|-----------------------------------|-----------|-----------------|
| ETS 0191 | Sweep function generator | 7202 | Dagatron |
| ETS 0192 | Audio generator | 7101 | Dagatron |
| ETS 0193 | Vibration table | N1-201-M | Sandbox |
| ETS 0194 | Digital multimeter | PMM 208 | Dagatron |
| ETS 0195 | Thermo hygro recorder | | Amarell |
| ETS 0196 | Digital thermometer | AK-688 | KD |
| ETS 0197 | Digital thermometer | | Prima |
| ETS 0198 | Digital thermometer | ad 170th | ama-digit |
| ETS 0199 | Digital thermometer | ad 31th | ama-digit |
| ETS 0200 | Digital thermometer / hygro meter | ad 90h | ama-digit |
| ETS 0201 | Digital thermometer / hygro meter | 37950-10 | Cole Parmer |
| ETS 0202 | Digital thermometer | ad 15th | ama-digit |
| ETS 0203 | Digital thermometer | Type K | Amarell |
| ETS 0204 | Digital thermometer | ad 20th | ama-digit |
| ETS 0205 | High voltage test generator | HA 3300 D | SPS electronic |
| ETS 0206 | High voltage test accessoires | HVGZ 312 | SPS electronic |
| ETS 0207 | Socket-Outlet torque balance | F 37.13 | PTL |
| ETS 0208 | Unjointed Finger probe | P 10.05 | PTL |
| ETS 0209 | Flixible Finger probe | P 10.01 | PTL |
| ETS 0210 | Spring operated impact hammer | P 22.50 | PTL |
| ETS 0211 | Metallic ball | F 53.32 | PTL |
| ETS 0212 | Hazardous live probe | P 10.06 | PTL |
| ETS 0213 | Hazardous live probe | P 10.11 | PTL |
| ETS 0214 | Ball pressure test apparatus | T 10.02 | PTL |
| ETS 0215 | Glow Wire tester | T 03.14 | PTL |
| ETS 0216 | Force indicator 50N | P 10.31 | PTL |
| ETS 0217 | Millivolt meter | URV 55 | Rohde & Schwarz |
| ETS 0218 | RF probe | URV5-Z7 | Rohde & Schwarz |
| ETS 0219 | Power sensor | NRV-Z2 | Rohde & Schwarz |
| ETS 0220 | Insertion unit | URV5-Z4 | Rohde & Schwarz |
| ETS 0221 | ISDN-S0-Analyzer | K1403 | Siemens |
| ETS 0222 | ISDN Protocol Analyser | TE965 | Tekelec Teleco. |
| ETS 0223 | GSM/ PCN/ PCS-Simul. | TS8915B | Rohde & Schwarz |
| ETS 0224 | GSM System Simulator | FTA | Rohde & Schwarz |
| ETS 0225 | SIM Simulator | | Orga |
| ETS 0226 | SIM Editor | | Orga |

Registration number: W6M20405-5191-C-1
FCC ID: CINUH-2000

| No. | Test equipment | Type | Manufacturer |
|----------|---------------------------|-------------|--------------------|
| ETS 0227 | Vibration table | TIRA vib | GenRad |
| ETS 0228 | Climatic chamber | VT 4010 | Vötsch |
| ETS 0229 | Radio Commun. Tester | CMT 54 | Rohde & Schwarz |
| ETS 0230 | Radio Commun. Tester | CMD 65 | Rohde & Schwarz |
| ETS 0231 | Testreceiver | ESVS 30 | Rohde & Schwarz |
| ETS 0232 | Radiation test source | VSQ 1 | MEB |
| ETS 0233 | Direction coupler | RK 100 | MEB |
| ETS 0234 | Power meter | NRVD | Rohde & Schwarz |
| ETS 0235 | RF-network-analyser | 8752 C | Hewlett Packard |
| ETS 0236 | RF-amplifier | 100A100 | Amplifier Research |
| ETS 0237 | RF-amplifier | 100W1000M1 | Amplifier Research |
| ETS 0238 | Field strong meter | FM 2000 | Amplifier Research |
| ETS 0239 | Isotr. field probe 40 GHz | FP 2080 Kit | Amplifier Research |
| ETS 0240 | Isotr. field probe 1 GHz | FP 2000 Kit | Amplifier Research |
| ETS 0241 | Pulse Generator | 4050 | PicoSecond PL |
| ETS 0242 | Harmonics analyser | F 41B | Fluke |
| ETS 0243 | AC-clamp 1000 A | 80i 1000s | Fluke |
| ETS 0244 | Burst generator | EFT 200 | EM-Test |
| ETS 0245 | Load dump generator | LD 200 | EM-Test |
| ETS 0246 | Voltage drop simulator | VDS 200 | EM-Test |
| ETS 0247 | Microsecond generator | MPG 200 | EM-Test |
| ETS 0248 | Switch unit | AN 200 | EM-Test |
| ETS 0249 | Coupling network | CNA 200 | EM-Test |
| ETS 0250 | Coupling clamp | ACC | EM-Test |
| ETS 0252 | System controller | PSM 12 | Rohde & Schwarz |
| ETS 0253 | Spectrum analyser | FSIQ | Rohde & Schwarz |
| ETS 0254 | RF generator | SMIQ 03 | Rohde & Schwarz |
| ETS 0255 | RF generator | SMIQ 03 | Rohde & Schwarz |
| ETS 0256 | RF generator | SMP 03 | Rohde & Schwarz |
| ETS 0257 | Step attenuator | RSP | Rohde & Schwarz |
| ETS 0258 | Rubidium standard | RSTU | DATUM GmbH |
| ETS 0259 | Power meter | NRVD | Rohde & Schwarz |
| ETS 0260 | Power sensor | NRVD-Z1 | Rohde & Schwarz |
| ETS 0261 | Power sensor | NRVD-Z1 | Rohde & Schwarz |
| ETS 0262 | Switching unit | SSCU | Rohde & Schwarz |
| ETS 0263 | Signaling unit | | Wird |

Registration number: W6M20405-5191-C-1

FCC ID: CINUH-2000

| No. | Test equipment | Type | Manufacturer |
|----------|-----------------------|-----------|--------------------|
| ETS 0264 | Spectrum analyser | F 1048 | HAMEG |
| ETS 0265 | Loop antenna | HFRA 9150 | Schwarzbeck |
| ETS 0267 | RF signal generator | SMT 03 | Rohde & Schwarz |
| ETS 0268 | RF signal generator | SMP 02 | Rohde & Schwarz |
| ETS 0270 | RF signal generator | SMP 04 | Rohde & Schwarz |
| ETS 0271 | Test receiver | ESI 40 | Rohde & Schwarz |
| ETS 0272 | RF signal generator | SME 03 | Rohde & Schwarz |
| ETS 0273 | RF signal generator | SME 03 | Rohde & Schwarz |
| ETS 0274 | RF signal generator | SMY 01 | Rohde & Schwarz |
| ETS 0275 | Power sensor | NRV-Z51 | Rohde & Schwarz |
| ETS 0276 | Audio analyser | UPL | Rohde & Schwarz |
| ETS 0277 | Power sensor | NRV-Z1 | Rohde & Schwarz |
| ETS 0278 | Power sensor | NRV-Z31 | Rohde & Schwarz |
| ETS 0279 | Step attenuator | RSP | Rohde & Schwarz |
| ETS 0280 | Power meter | NRVD | Rohde & Schwarz |
| ETS 0281 | Spectrum analyser | FSM | Rohde & Schwarz |
| ETS 0282 | RF bridge | 86207 A | Hewlett Packard |
| ETS 0283 | RF bridge | 86205 A | Hewlett Packard |
| ETS 0284 | Field probe | 11940 A | Hewlett Packard |
| ETS 0285 | Field probe | 11941 A | Hewlett Packard |
| ETS 0286 | Limiter | 11867 A | Hewlett Packard |
| ETS 0287 | Test receiver | ESHS 10 | Rohde & Schwarz |
| ETS 0288 | Artificial mains | ESH2-Z5 | Rohde & Schwarz |
| ETS 0289 | Audio generator | TAG 101 | Troneer |
| ETS 0290 | Audio generator | TAG 101 | Troneer |
| ETS 0291 | Loop antenna | HFH2-Z2 | Rohde & Schwarz |
| ETS 0292 | RF generator | SMHU | Rohde & Schwarz |
| ETS 0293 | Artificial mains | NNBM 8125 | Schwarzbeck |
| ETS 0294 | Biconical antenna | HK 116 | Rohde & Schwarz |
| ETS 0295 | LPD antenna | HL 223 | Rohde & Schwarz |
| ETS 0296 | Oscilloscope | TDS 520 A | Tektronix |
| ETS 0297 | Power pulse generator | IGUF 2910 | Schwarzbeck |
| ETS 0298 | ICO tester | TS 1232 | Rohde & Schwarz |
| ETS 0299 | DECT protocol tester | TS 1220 | Rohde & Schwarz |
| ETS 0300 | RF amplifier | 75 A 250 | Amplifier Research |
| ETS 0301 | Relay switch unit | RSU | Rohde & Schwarz |

Registration number: W6M20405-5191-C-1

FCC ID: CINUH-2000

| No. | Test equipment | Type | Manufacturer |
|----------|------------------------------|--------------|-----------------|
| ETS 0302 | Data line CDN | CM-I/O CD | Keytek |
| ETS 0303 | Telecom line CDN | CM-TEL CD | Keytek |
| ETS 0304 | Test receiver | ESHS 10 | Rohde & Schwarz |
| ETS 0305 | Test receiver | ESVS 10 | Rohde & Schwarz |
| ETS 0306 | Function generator | HP 33120A | Hewlett Packard |
| ETS 0307 | Commu. Sign. Analyzer | CSA 803 A | Tektronix |
| ETS 0308 | Spectrum analyzer | R 3361A | Advantest |
| ETS 0309 | Anechoic chamber | AC 2 | Frankonia |
| ETS 0310 | Anechoic chamber | AC 3 | Frankonia |
| ETS 0311 | Anechoic chamber | AC 4 | Frankonia |
| ETS 0312 | Climatic chamber | VC 0033 | Vötsch |
| ETS 0313 | Power sensor | NRV-Z51 | Rohde & Schwarz |
| ETS 0314 | LPD antenna | HL 223 | Rohde & Schwarz |
| ETS 0315 | Biconical antenna | HK 116 | Rohde & Schwarz |
| ETS 0316 | Switcher | Hr 07-720 | WISI |
| ETS 0317 | Switcher | Hr 07-720 | WISI |
| ETS 0318 | Dial pulse/ DTMF tester | 210 | HE |
| ETS 0319 | Opto link | GPIB 140 | NI |
| ETS 0320 | Opto link | GPIB 140 | NI |
| ETS 0321 | RF Millivoltmeter | URV 55 | Rohde & Schwarz |
| ETS 0322 | Insertion unit | URV5-Z4 | Rohde & Schwarz |
| ETS 0323 | DECT portable part | Gigaset 1000 | SIEMENS |
| ETS 0324 | DECT fix part | Gigaset 1000 | SIEMENS |
| ETS 0325 | DECT portable part | | Philipps |
| ETS 0326 | DECT fix part | | Philipps |
| ETS 0327 | Blue Unit | V 2.0 | Nokia |
| ETS 0328 | BT Protocol tester | PTW 60 | Rohde & Schwarz |
| ETS 0330 | Spectrum analyser | FSM | Rohde & Schwarz |
| ETS 0333 | turn table | DE 350 | Heinrich Deisel |
| ETS 0334 | Controller | HD 100 | Heinrich Deisel |
| ETS 0335 | BT Development kit | CASIRA | CSR |
| ETS 0336 | LPD Antenna | HL 223 | Rohde & Schwarz |
| ETS 0337 | Professional Power Amplifier | SE-1200 | Wharfedale Pro |
| ETS 0338 | Coupling network | KN002 | ETS |
| ETS 0339 | Isolating Transformer | KN003 | ETS |
| ETS 0340 | Thermometer | | Proficell |

Registration number: W6M20405-5191-C-1

FCC ID: CINUH-2000

| No. | Test equipment | Type | Manufacturer |
|----------|--------------------------|-------------------|---------------|
| ETS 0341 | Thermometer | | Proficell |
| ETS 0342 | Thermometer | | Proficell |
| ETS 0343 | Thermometer | | Proficell |
| ETS 0344 | Thermometer | | Proficell |
| ETS 0345 | Thermometer | | Proficell |
| ETS 0346 | Thermometer | | Proficell |
| ETS 0347 | Current Probe | EZ-17 | R & S |
| ETS 0348 | RF Millivolt meter | URV 55 | R & S |
| ETS 0349 | Insertion unit | URV5-Z4 | R & S |
| ETS 0350 | Horn Antenna | BBHA 9120-C | Schwarzbeck |
| ETS 0351 | RF amplifier | DWT-1857 | Microwave |
| ETS 0352 | | | |
| ETS 0353 | | | |
| ETS 0354 | RF amplifier | DBS-0408N423 | Microwave |
| ETS 0355 | high pass | H03G12G3 | Microwave |
| ETS 0356 | high pass | H03G12G3 | Microwave |
| ETS 0357 | high pass | H08G18G3 | Microwave |
| ETS 0358 | RF amplifier | AFD3-010040-15-ln | MITEQ |
| ETS 0359 | RF amplifier | M/N AM-1331 | MITEQ |
| ETS 0360 | RF amplifier | DBS-0408N423 | Microwave |
| ETS 0361 | RF amplifier | DBS 1826N515 | Microwave |
| ETS 0362 | high pass | H03G12G3 | Microwave |
| ETS 0363 | high pass | H08G18G3 | Microwave |
| ETS 0364 | high pass | H08G18G3 | Microwave |
| ETS 0365 | Notch filter 2.4 GHz | WRCT2.40/248 | Wain Wright |
| ETS 0366 | high pass | H08G18G3 | Microwave |
| ETS 0367 | high pass | H03G12G3 | Microwave |
| ETS 0368 | Notch filter 0.5-1 GHz | BN86883 | Schomandl |
| ETS 0369 | Notch filter 210-500 MHz | BN86882 | Schomandl |
| ETS 0370 | Notch filter 15-90 MHz | BN86880 | Schomandl |
| ETS 0371 | Notch filter 85-250 MHz | BN86881 | Schomandl |
| ETS 0372 | Direction coupler | RK 100 | MEB |
| ETS 0373 | Direction coupler | DC3001 | emv |
| ETS 0374 | Insertion Unit | URV 5-Z2 | R&S |
| ETS 0375 | RCo Network | 8 Ohm | Erika Fiedler |
| ETS 0376 | RCo Network | 300 Ohm | Erika Fiedler |
| ETS 0377 | RCo Network | 10K Ohm | Erika Fiedler |
| ETS 0378 | RCo Network | 10K Ohm | Erika Fiedler |
| ETS 0379 | Abschlusswiderstand | 150 Ohm | Erika Fiedler |
| ETS 0380 | Abschlusswiderstand | 150 Ohm | Erika Fiedler |
| ETS 0381 | RCi Network | 100 Ohm | Erika Fiedler |
| ETS 0382 | RCi Network | 2.2K Ohm | Erika Fiedler |
| ETS 0383 | RCi Network | 1K Ohm | Erika Fiedler |

Registration number: W6M20405-5191-C-1
FCC ID: CINUH-2000

| No. | Test equipment | Type | Manufacturer |
|----------|----------------------|------------------------|---------------|
| ETS 0384 | RCi Network | 22K Ohm | Erika Fiedler |
| ETS 0385 | RCi Network | 22K Ohm | Erika Fiedler |
| ETS 0386 | Bandpass 0.5-3kHz | nach EN 55020-D.2 | |
| ETS 0387 | Tiefpass 15 kHz | nach EN 55020-D.1 | |
| ETS 0388 | Tiefpass 15 kHz | nach EN 55020-D.1 | |
| ETS 0389 | Bandpass 0.5-3kHz | nach EN 55020-D.2 | |
| ETS 0390 | Netz Filter | Mains Filter 'M' | Erika Fiedler |
| ETS 0391 | Bewertungsnetzwerk | nach EN 55020-B.3 | |
| ETS 0392 | Matching Network | MN 50-150Ohm | Erika Fiedler |
| ETS 0393 | Matching Network | MN 50-150Ohm | Erika Fiedler |
| ETS 0394 | RCo Network | Loudspeaker Load 8 Ohm | Erika Fiedler |
| ETS 0395 | RCo Network | Loudspeaker Load 8 Ohm | Erika Fiedler |
| ETS 0396 | RCo Network | Loudspeaker Load 8 Ohm | Erika Fiedler |
| ETS 0397 | RCo Network | Phone Load 300 Ohm | Erika Fiedler |
| ETS 0398 | RCo Network | Phone Load 300 Ohm | Erika Fiedler |
| ETS 0399 | RCo Network | Phone Load 300 Ohm | Erika Fiedler |
| ETS 0400 | RCo Network | Audio Adapter | Erika Fiedler |
| ETS 0401 | RCo Network | Audio Adapter | Erika Fiedler |
| ETS 0402 | Coupling Unit | SR (47K Ohm) | Erika Fiedler |
| ETS 0403 | Coupling Unit | SR (47K Ohm) | Erika Fiedler |
| ETS 0404 | Coupling Unit | SR (47K Ohm) | Erika Fiedler |
| ETS 0405 | Coupling Unit | SR (2.2K Ohm) | Erika Fiedler |
| ETS 0406 | Coupling Unit | SR (22K Ohm) | Erika Fiedler |
| ETS 0407 | Coupling Network | "M" | Erika Fiedler |
| ETS 0408 | Coupling Network | "A" | Erika Fiedler |
| ETS 0409 | Coupling Network | "A" | Erika Fiedler |
| ETS 0410 | Coupling Network | "A" | Erika Fiedler |
| ETS 0411 | Coupling Network | "L" | Erika Fiedler |
| ETS 0412 | Coupling Network | "L" | Erika Fiedler |
| ETS 0413 | Coupling Network | "L" | Erika Fiedler |
| ETS 0414 | A/V adapter | Type 2 | Erika Fiedler |
| ETS 0415 | A/V adapter | Type 2 | Erika Fiedler |
| ETS 0416 | A/V adapter | Type 2 | Erika Fiedler |
| ETS 0417 | A/V adapter | Type 3 | Erika Fiedler |
| ETS 0418 | A/V adapter | Type 1 | Erika Fiedler |
| ETS 0419 | A/V adapter | Type 1 | Erika Fiedler |
| ETS 0420 | Verstärker 0.1-1 GHz | M/N AM-1331 | MITEC |
| ETS 0421 | Verstärker 1-4 GHz | AFD3-010040-15-LN | MITEC |
| ETS 0422 | Verstärker 4-8 GHz | DBS-0408N423 | Narda |

Registration number: W6M20405-5191-C-1
FCC ID: CINUH-2000

| No. | Test equipment | Type | Manufacturer |
|----------|--------------------------------|------------------|-----------------------------|
| ETS 0423 | Verstärker 8-18 GHz | DWT-18057 | Narda |
| ETS 0424 | Verstärker 18-26.5 GHz | DBS-1826N515 | Narda |
| ETS 0425 | T-Network | ESH 3-Z4 | R&S |
| ETS 0426 | CDN | T4 HF | MEB |
| ETS 0427 | Power sensor | NRV-Z6 | R&S |
| ETS 0428 | 4-WIRE ISN mit B1 | ENY41 | R&S |
| ETS 0429 | Current Probe Test Jig | SW14 7LY | Chase |
| ETS 0430 | RF signal generator | SML02 | R&S |
| ETS 0431 | AC Mains Adaptor | BS5733 | Travel Emporium |
| ETS 0432 | RF Verstärkermatrix | RSU-ETS-BT | ETS |
| ETS 0433 | RF Verstärkermatrix | RSU-ETS-CTR6 | ETS |
| ETS 0434 | Reserviert Tre | RSU-ETS-GSM | |
| ETS 0435 | HP-Filter | H1G04G01 | Microwave |
| ETS 0436 | HP-Filter | H1G04G01 | Microwave |
| ETS 0437 | HP-Filter | H0G408G1 | Microwave |
| ETS 0438 | HP-Filter | H0G408G1 | Microwave |
| ETS 0439 | Reserviert Tre | | |
| ETS 0440 | Reserviert Tre | | |
| ETS 0441 | Bluetooth Protocol Tester | PTW 60 | R & S |
| ETS 0442 | Nokia Tester for Bluetooth 1.1 | DTL - 1 | Nokia |
| ETS 0443 | IBM BT PC Card | BTPCN101 | IBM / Motorola |
| ETS 0444 | Sony BT DUN Modem | BTA- NW 1 | Sony |
| ETS 0445 | RF-Attenuattor 6dB | 50FH-006-300 | JFK |
| ETS 0446 | RF-Attenuattor 30dB | 50FH-030-300 | JFK |
| ETS 0447 | KFZ-Bordnetznachbildung | LN-KFZ/200 | R. Heine Hochfrequenztechn. |
| ETS 0448 | RF Power Amplifier | AR 60S1G3 | AR Amplifier Resarch |
| ETS 0449 | Stäubli Robot | RX90B L | Stäubli |
| ETS 0450 | Stäubli Robot Controller | CS/MBs&p | Stäubli |
| ETS 0451 | DASY 4 Measurement Server | | Schmidt & Partner |
| ETS 0452 | Control Pendant | | Stäubli |
| ETS 0453 | Compaq Computer | Pentium IV 2 GHz | Schmidt & Partner |
| ETS 0454 | Dabu Acquisition Electronis | DAE3V1 | Schmidt & Partner |
| ETS 0455 | Dummy Probe | | Schmidt & Partner |
| ETS 0456 | Dosimetric E-Field Probe | ET3DV6 | Schmidt & Partner |
| ETS 0457 | Dosimetric E-Field Probe | ET3DV6 | Schmidt & Partner |
| ETS 0458 | Dosimetric H-Field Probe | H3DV6 | Schmidt & Partner |
| ETS 0459 | System Validation Kit | D900V2 | Schmidt & Partner |
| ETS 0460 | System Validation Kit | D1800V2 | Schmidt & Partner |
| ETS 0461 | System Validation Kit | D1900V2 | Schmidt & Partner |
| ETS 0462 | System Validation Kit | D2450V2 | Schmidt & Partner |
| ETS 0463 | Probe Alignment Unit | LBV2 | Schmidt & Partner |
| ETS 0464 | SAM Twin phantom | V4.0 | |
| ETS 0465 | Mounting Device | V 3.1 | |

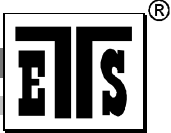

Registration number: W6M20405-5191-C-1
FCC ID: CINUH-2000

| No. | Test equipment | Type | Manufacturer |
|----------|---------------------------------|--------------|--------------|
| ETS 0466 | Directional Coupler | HP 87300B | |
| ETS 0467 | Universal Radio Communication T | CMU 200 | R & S |
| ETS 0468 | | | |
| ETS 0469 | Dielectric Probe Kit | 85070C | Agilent |
| ETS 0470 | Amplifier | AM-1300-1103 | MITEQ |
| | | | |
| | | | |
| | | | |
| | | | |

Registration number: W6M20405-5191-C-1
FCC ID: CINUH-2000

2.4 General Test Procedure

POWER LINE CONDUCTED INTERFERENCE: The procedure used was ANSI STANDARD C63.4-2000 using a 50 μ H LISN (if necessary). Both lines were observed. The bandwidth of the spectrum analyzer was 10 kHz with an appropriate sweep speed.

RADIATION INTERFERENCE: The test procedure used was according to ANSI STANDARD C63.4-2000 employing a spectrum analyzer. For investigated frequency is equal to or below 1GHz, the RBW and VBW of the spectrum analyzer was 100 kHz and 100kHz respectively with an appropriate sweep speed. For investigated frequency is above 1GHz, both of RBW and VBW of the spectrum analyzer were 1 MHz with an appropriate sweep speed. The analyzer was calibrated in dB above a microvolt at the output of the antenna. The ambient temperature of the UUT was 23°C with a humidity of 40 %.

The table used for radiated measurements is capable of continuous rotation. The spectrum was scanned from 30 MHz to the frequency specified as follows:

- (1) If the intentional radiator operates below 10 GHz: to the tenth harmonic of the highest fundamental frequency or to 40 GHz, whichever is lower.
- (2) If the intentional radiator operates at or above 10 GHz and below 30 GHz: to the fifth harmonic of the highest fundamental frequency or to 100 GHz, whichever is lower.
- (3) If the intentional radiator operates at or above 30 GHz: to the fifth harmonic of the highest fundamental frequency or to 200 GHz, whichever is lower, unless specified otherwise elsewhere in the rules.
- (4) If the intentional radiator contains a digital device, regardless of whether this digital device controls the functions of the intentional radiator or the digital device is used for additional control or function purposes other than to enable the operation of the intentional radiator, the frequency range shall be investigated up to the range specified in paragraphs (a)(1)-(a)(3) of this section or the range applicable to the digital device, as shown in paragraph (b)(1) of this Section, whichever is the higher frequency range of investigation.

For hand-held devices, a exploratory test was performed with three (3) orthogonal planes to determine the highest emissions.

Measurements were made by ETS Dr. Genz GmbH, Germany at the registered open field test site located at Storkower Str. 38c, 15526 Reichenwalde Germany. The Registration Number: 96970. When an emission was found, the table was rotated to produce the maximum signal strength. At this point, the antenna was raised and lowered from 1m to 4m. The antenna was placed in both the horizontal and vertical planes.

ANTENNA & GROUND:

This unit uses internal antenna. There is no provision for an external antenna (see photo).

Registration number: W6M20405-5191-C-1
 FCC ID: CINUH-2000

3 Test results (enclosure)

| TEST CASE | | Required | Test passed | Test failed |
|---|---------------------------------|-------------------------------------|-------------------------------------|--------------------------|
| RF Power Output | 2.1046 (a); 74.861 (e)(1) | <input checked="" type="checkbox"/> | <input checked="" type="checkbox"/> | <input type="checkbox"/> |
| Modulation Deviation | 2.1047 (b); 74.861 (e)(2) | <input checked="" type="checkbox"/> | <input checked="" type="checkbox"/> | <input type="checkbox"/> |
| Audio Frequency Response | 2.1047 (a) | <input checked="" type="checkbox"/> | <input checked="" type="checkbox"/> | <input type="checkbox"/> |
| Occupied Bandwidth / Emission Mask | 2.1049 (c)(1); 74.861 (e)(5) | <input checked="" type="checkbox"/> | <input checked="" type="checkbox"/> | <input type="checkbox"/> |
| Spurious Emissions at Antenna Terminals | 2.1051 74.861(e)(6) | <input checked="" type="checkbox"/> | <input checked="" type="checkbox"/> | <input type="checkbox"/> |
| Radiated Spurious Emission | 2.1053 74.861(e)(6) | <input checked="" type="checkbox"/> | <input checked="" type="checkbox"/> | <input type="checkbox"/> |
| Line Conducted Emissions | 15.207 | <input type="checkbox"/> | <input type="checkbox"/> | <input type="checkbox"/> |
| Frequency Stability vs. Temperature | 2.1055 (b); 74.861(e)(4) | <input checked="" type="checkbox"/> | <input checked="" type="checkbox"/> | <input type="checkbox"/> |
| Frequency Stability vs. Voltage | 2.1055 (a)(1); 74.861 (e)(4) | <input checked="" type="checkbox"/> | <input checked="" type="checkbox"/> | <input type="checkbox"/> |

The follows is intended to leave blank.

Registration number: W6M20405-5191-C-1
FCC ID: CINUH-2000

4 RF Power Output (conducted) , FCC 2.1046 (a) ; 74.861 (e)

4.1 Test procedure

This transmitter output was connected to a calibrated coaxial attenuator, the other end of which was connected to a spectrum analyzer. Transmitter output was derived with the spectrum analyzer in dBm.

The power output at the transmitter antenna port was determined by assign the value of the attenuator to the spectrum analyzer reading.

An HP power meter was also used to measure the RF power.

Tests were performed with an unmodulated carrier at three frequencies (low , middle and high channels) and on all power levels , which can be set-up on the transmitters.

4.2 Test Results

| Frequency Channel | Peak Output Power (dBm) |
|-------------------|---------------------------|
| 615 MHz | -1.50 |
| 710 MHz | -1.82 |
| 804.975 MHz | -4.40 |

Limits:

| LPAS operating in TV bands | |
|---------------------------------|-------------------------------|
| Frequency [MHz] | Conducted output power [mW] |
| 54 – 72 76 – 88 174 - 216 | 50 (17 dBm) |
| 470 – 608 614 - 806 | 250 (24 dBm) |

| LPAS operating in other than TV bands | |
|---------------------------------------|---|
| Conducted power [W] | |
| | 1 |

Comment : see attached diagrams.

Registration number: W6M20405-5191-C-1
FCC ID: CINUH-2000

5 Radiated Power

5.1 Test Procedure

The EUT was positioned on a non-conductive turntable, 0.8m above the ground on an open test site.

The radiated emission at the fundamental frequency was measured at 3m distance with a test antenna and spectrum analyzer.

Worst case emission was recorded with the rotation of the turntable and the raising and lowering of the test antenna.

Substitution RF power Measurement at ETS Dr. Genz GmbH

General :

The applied substitution method follows ANSI/TIA/EIA-603, ANSI/TIA/EIA-102.CAAA or the appropriate ETSI rules respectively.

The actual signal generated by the EUT can be determined by means of a substitution measurement in which a known signal source replaces the device to be measured.

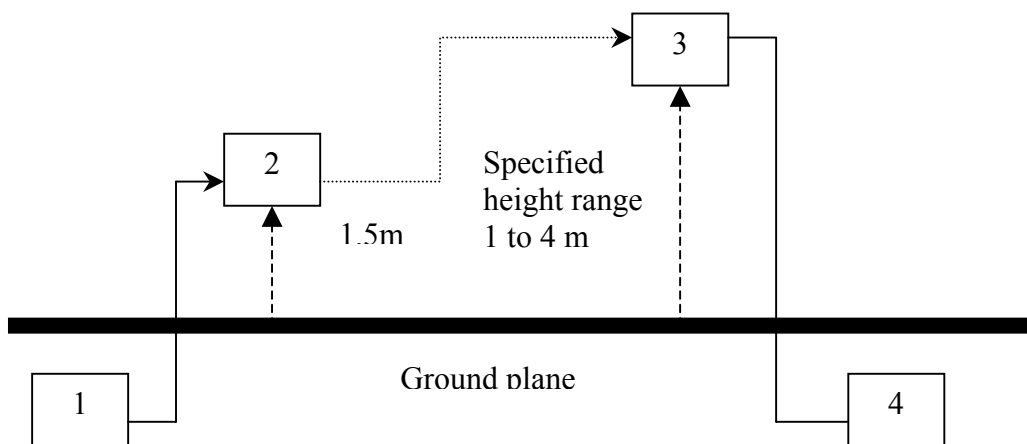

- 1) Signal generator ;
- 2) Substitution antenna ;
- 3) Test antenna ;
- 4) Spectrum analyzer or selective voltmeter.

The substitution antenna replaces the transmitter antenna at the same position and in vertical polarization. The frequency of the signal generator shall be adjusted to the measurement frequency.

The test antenna shall be raised or lowered, if necessary, to ensure that the maximum signal is still received. The input signal to the substitution antenna shall be adjusted in level until an equal or a known related level to that detected from the transmitter is obtained in the measurement receiver.

If a fully anechoic chamber is used as test site in order to provide free space conditions there is no need to change the height of the antenna.

Registration number: W6M20405-5191-C-1
FCC ID: CINUH-2000

The measurement will be repeated in horizontal position.

Calibration :

In order to make this kind of measurement more effective and to avoid subjective measurement faults ETS has installed automatic computer controlled measurement procedures.

With the above described substitution method a test site is calibrated over the full frequency range which is used in suitable frequency steps. For a certain power level on the substitution antenna the received power over the whole frequency range is documented. All necessary antenna gains, cable losses, filter losses and amplifications of preamplifiers are taken in consideration. The summary of this calibration measurement performs a transducer factor that is related to the considered test site and a certain measurement distance. Differences of the radiated power levels of different test samples are determined by internal attenuation of measurement receiver . The proper function of such test site will be maintained by short term plausibility checks and periodical re-calibration.

Testing :

Now the test sample will be putted on the table at the defined position and the radiated power will be receiver and documented by the measurement receiver.

On test sites with ground plane the measurement antenna will be lowered and raised to maximum values at significant frequencies.

For peak power measurements the sample is turned by the turntable over 360 degree in order to find the direction with the maximum radiation or to document the max reading with the MAXHOLD function during the rotation.

5.2 Test results

| Radiated Power (dBm) | |
|------------------------|-------|
| Channel A | 0.35 |
| Channel B | -0.50 |
| Channel C | -2.42 |

Comment : see attached diagrams.

Registration number: W6M20405-5191-C-1
FCC ID: CINUH-2000

6 Modulation Deviation , FCC 2.1047 (b) ; 74.861(e)

6.1 Test procedure

Modulation limiting is the transmitter circuit's ability to limit the transmitter from producing deviations in excess of rated system deviation.

The audio signal generator is connected to the audio input of the EUT with its full rating.

The modulation response is measured at certain modulation frequencies, related to 1000Hz reference signal. Tests are performed for positive and negative modulation.

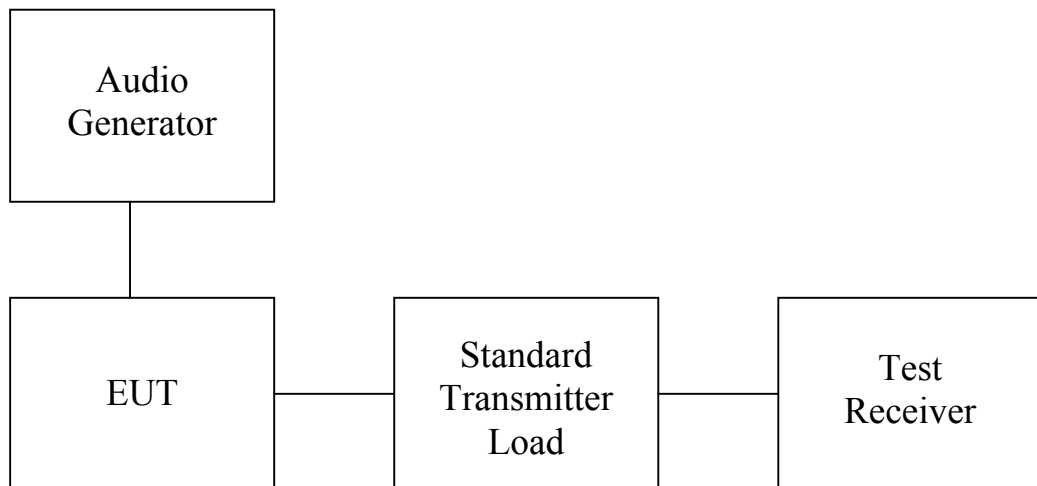

6.2 Test results

Limits : ± 75 kHz

Comment : see attached diagrams.

Registration number: W6M20405-5191-C-1
FCC ID: CINUH-2000

7 Audio frequency response , FCC 2.1047 (a)

7.1 Test procedure

The audio frequency response is the degree of closeness to which the frequency deviation of the transmitter follows a prescribed characteristic.

The frequency response of the audio modulation part is measured over a frequency range of 100 Hz to 5000Hz.

For 1000Hz tone reference signal the audio generator level is adjusted to get 20% of the rated system deviation.

The deviations obtained over the frequency range from 100Hz to 5000Hz are recorded and compared with the reference deviation as follows :

$$\text{Audio Frequency Response} = 20 \log [\text{DEV}_{\text{Freq}} / \text{DEV}_{\text{ref}}].$$

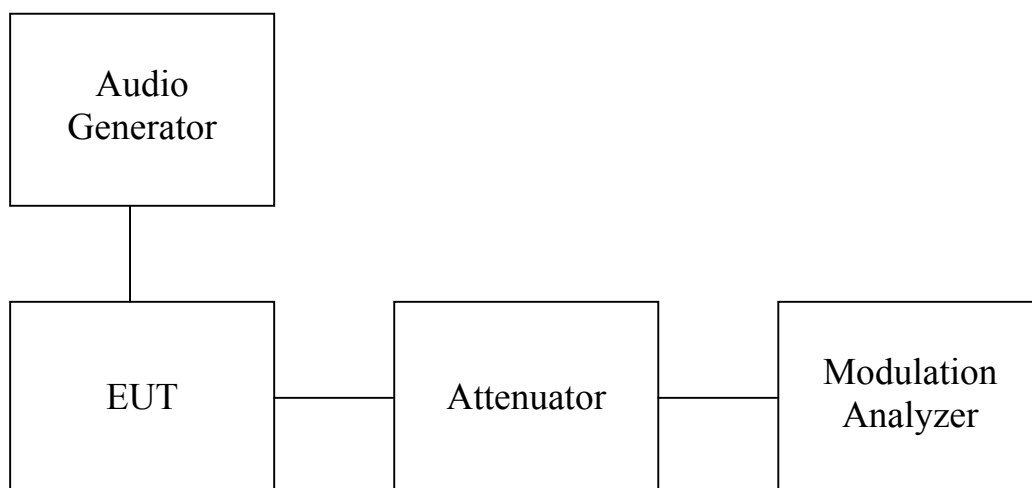

7.2 Test results

Comment : see attached diagrams.

Registration number: W6M20405-5191-C-1
FCC ID: CINUH-2000

8 Occupied Bandwidth/Emission Mask, FCC 2.1049 (c) ; 74.861 (e)(5)

The occupied bandwidth, that is the frequency bandwidth such that, below its lower and above its upper frequency limits, the mean powers radiated are each equal to 0.5 percent of the total mean power.

Near the carrier an Emission Mask is defined by the standard.

8.1 Test procedure

The RF output of the transceiver was connected to the input of the spectrum analyzer through sufficient attenuation.

Occupied Bandwidth was measured with a occupied bandwidth function of the analyzer.

The near the carrier emissions are measured by normal power measurement function of the analyzer.

8.2 Test Results

1000 Hz Modulation

| Occupied Channel Bandwidth (kHz) | |
|------------------------------------|--------------|
| Channel A | 113.02605210 |
| Channel B | 145.89178357 |
| Channel C | 141.08216433 |

2500 Hz Modulation

| Occupied Channel Bandwidth (kHz) | |
|------------------------------------|--------------|
| Channel A | 114.62925852 |
| Channel B | 141.88376754 |
| Channel C | 132.26452906 |

Comment : see attached diagram in appendix.

For near the carrier emissions see attached diagrams.

Registration number: W6M20405-5191-C-1
FCC ID: CINUH-2000

9 Spurious Emissions at Antenna Terminals FCC2.1051 ; 74.861 (e)

9.1 Test procedure

This transmitter output was connected to a calibrated coaxial attenuator, the other end of which was connected to a spectrum analyzer. Transmitter output was derived with the spectrum analyzer in dBm.

The Spurious Emissions at Antenna Terminals was measured by the spectrum analyzer with a suitable notch filter and high-pass filter.

Tests were performed with an unmodulated carrier at three frequencies (low , middle and high channels) and on all power levels , which can be set-up on the transmitters.

9.2 Test Results

Summary table with conducted data of the test plots for Carrier Test Frequency 615 MHz

| Frequency Marker Indication [MHz] | Indication Power Level [dBm] | Compliance Limit [dBm] | Margin |
|-----------------------------------|------------------------------|------------------------|--------|
| 615.08016032 | -13.69 | Carrier | |
| 2815.63126 | -54.32 | -13 | -41.32 |
| 6909.81964 | -53.01 | -13 | -40.01 |
| 1163.927856 | -53.85 | -13 | -40.85 |

Summary table with conducted data of the test plots for Carrier Test Frequency 710 MHz

| Frequency Marker Indication [MHz] | Indication Power Level [dBm] | Compliance Limit [dBm] | Margin |
|-----------------------------------|------------------------------|------------------------|--------|
| 710.82164329 | -17.11 | Carrier | |
| 2653.30661 | -54.46 | -13 | -41.46 |
| 6989.97996 | -52.58 | -13 | -39.58 |
| 1167.935872 | -54.60 | -13 | -41.60 |

Registration number: W6M20405-5191-C-1

FCC ID: CINUH-2000

**Summary table with conducted data of the test plots for Carrier Test Frequency
804.975 MHz**

| Frequency Marker Indication [MHz] | Indication Power Level [dBm] | Compliance Limit [dBm] | Margin |
|-----------------------------------|------------------------------|------------------------|--------|
| 804.60921844 | -23.35 | Carrier | |
| 2521.04208 | -54.24 | -13 | -41.24 |
| 6973.94790 | -52.96 | -13 | -39.96 |
| 1162.324649 | -53.96 | -13 | -40.96 |

9.2 Limit

Compliance with § 74.861 requires that any emission be attenuated below the transmitter power at least $43 + 10 \log_{10} P$ (P = transmitter power in Watts).

The compliance limit was calculated as an example per the following table :

| | |
|----------------------------------|--|
| Maximum transmitter output power | -1.50 dBm |
| Required attenuation | $43 + 10 \log_{10} 0.00070795W = 11.50 \text{ dB}$ |
| Maximum transmitter output power | -1.50 dBm |
| <u>Required attenuation</u> | <u>11.50 dB</u> |
| Compliance limit | -13 dBm |

Comment : see attached diagrams in appendix.

Registration number: W6M20405-5191-C-1
FCC ID: CINUH-2000

10 Radiated Spurious Emission , FCC 2.1053 ; 74.861 (e)

10.1 Test procedure

The EUT was positioned on a non-conductive turntable , 0.8m above the ground plane. The radiated emission at the fundamental frequency was measured at 3 m distance with a test antenna and spectrum analyzer.

Worst case emission was recorded with the rotation of the turntable and the raising and lowering of the test antenna.

ERP was measured using a substitution method. The EUT was replaced by reference antenna connected to a signal generator.

The test of spurious radiated emission have been carried out with the ESK-Software from Rode & Schwarz. The measurements below 1GHz were performed with a measurement bandwidth of 100kHz, above 1GHz with a bandwidth of 1 MHz.

Spurious emission limits near the carrier are defined by a emission mask. This measurements are done in conducted mode.

10.2 Test Results

The measurements of the spurious emission at the upper , center and lower channel. The measurement diagrams show that all significant spurs are well below the limit line.

Summary table with radiated data of the test plots for Carrier Test Frequency 615 MHz

| Spectral Plot | Frequency Marker Indication [MHz] | Indication Power Level [dBm] | External Attn. [dB] | Worst Case Emission Level [dBm] | Compliance Limit [dBm] | Margin |
|---------------|-----------------------------------|------------------------------|---------------------|---------------------------------|------------------------|--------|
| vertical | 106.713 | -52.39 | | -52.39 | -13 | -39.39 |
| horizontal | 198.597 | -56.85 | | -56.85 | -13 | -43.85 |
| vertical | 615.230 | -65.23 | | -65.23 | -13 | -52.23 |
| horizontal | 959.920 | -67.36 | | -67.36 | -13 | -54.36 |
| vertical | 1228 | -46.65 | | -46.65 | -13 | -33.65 |
| horizontal | 3693 | -38.36 | | -38.36 | -13 | -25.36 |
| vertical | 8000 | -52.73 | | -52.73 | -13 | -39.73 |
| horizontal | 5531 | -50.14 | | -50.14 | -13 | -37.14 |
| vertical | 1250.9 | -43.41 | | -43.41 | -13 | -30.41 |
| horizontal | 1246.9 | -44.63 | | -44.63 | -13 | -31.63 |

Registration number: W6M20405-5191-C-1

FCC ID: CINUH-2000

**Summary table with radiated data of the test plots for Carrier Test Frequency
710 MHz**

| Spectral Plot | Frequency Marker Indication [MHz] | Indication Power Level [dBm] | External Attn. [dB] | Worst Case Emission Level [dBm] | Compliance Limit [dBm] | Margin |
|---------------|-----------------------------------|------------------------------|---------------------|---------------------------------|------------------------|--------|
| vertical | 104.960 | -52.43 | | -52.43 | -13 | -39.43 |
| horizontal | 190.180 | -56.85 | | -56.85 | -13 | -43.85 |
| vertical | 709.820 | -60.82 | | -60.82 | -13 | -47.82 |
| horizontal | 982.365 | -67.21 | | -67.21 | -13 | -54.21 |
| vertical | 3555 | -44.81 | | -44.81 | -13 | -31.81 |
| horizontal | 3549 | -40.37 | | -40.37 | -13 | -27.37 |
| vertical | 7768 | -53.04 | | -53.04 | -13 | -40.04 |
| horizontal | 7102 | -49.76 | | -49.76 | -13 | -36.76 |
| vertical | 1237.9 | -43.98 | | -43.98 | -13 | -30.98 |
| horizontal | 1241.9 | -44.22 | | -44.22 | -13 | -31.22 |

**Summary table with radiated data of the test plots for Carrier Test Frequency
804.975 MHz**

| Spectral Plot | Frequency Marker Indication [MHz] | Indication Power Level [dBm] | External Attn. [dB] | Worst Case Emission Level [dBm] | Compliance Limit [dBm] | Margin |
|---------------|-----------------------------------|------------------------------|---------------------|---------------------------------|------------------------|--------|
| vertical | 106.713 | -53.13 | | -53.13 | -13 | -40.13 |
| horizontal | 187.375 | -57.17 | | -57.17 | -13 | -44.17 |
| vertical | 806.012 | -65.04 | | -65.04 | -13 | -52.04 |
| horizontal | 959.920 | -66.20 | | -66.20 | -13 | -53.20 |
| vertical | 3543 | -49.44 | | -49.44 | -13 | -36.44 |
| horizontal | 3543 | -49.10 | | -49.10 | -13 | -36.10 |
| vertical | 4024 | -46.87 | | -46.87 | -13 | -33.87 |
| horizontal | 4024 | -39.68 | | -39.68 | -13 | -26.68 |
| vertical | 1252.9 | -44.44 | | -44.44 | -13 | -31.44 |
| horizontal | 1247.9 | -44.41 | | -44.41 | -13 | -31.41 |

Registration number: W6M20405-5191-C-1
FCC ID: CINUH-2000

10.3 Explanation of test result

The measurements of the spurious emissions at the equipment output terminals were performed pursuant to the test procedure above in order to verify that any emissions are below the limits given by § 74.861 (6).

Calculation of test results :

Such factors like antenna correction , cable loss , external attenuation etc. are already included in the provided measurement results. This is done by using validated test software and calibrated test system according the accreditation requirements.

In the Table being listed the critical peak and average value an exhibit the compliance with the above calculated Limits.

10.4 Limits

Compliance with § 74.861 requires that any emission be attenuated below the transmitter power at least $43 + 10 \log_{10} P$ (P = transmitter power in Watts).

The compliance limit was calculated as an example per the following table :

| | |
|----------------------------------|---|
| Maximum transmitter output power | 0.35 dBm |
| Required attenuation | $43 + 10 \log_{10} 0.00108393 \text{ W} = 13.35 \text{ dB}$ |
| Maximum transmitter output power | 0.35 dBm |
| <u>Required attenuation</u> | <u>13.35 dB</u> |
| Compliance limit | -13 dBm |

Comment : see attached diagrams in appendix.

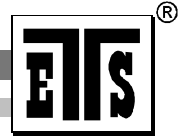

Registration number: W6M20405-5191-C-1
 FCC ID: CINUH-2000

11 Line Conducted Emission , FCC 15.207

11.1 Test procedure

For an intentional radiator which is designed to be connected to the public utility (AC) power line, the radio frequency voltage that is conducted back onto the AC line on any frequency or frequencies within the band 150 kHz to 30 MHz shall not exceed the limits in the table bellows with this provision shall be based on the measurement of the radio frequency voltage between each power line and ground at the power terminals.

This measurement was transact first with instrumentation using an average and peak detector and a 10 kHz bandwidth. If the peak detector achieves a calculated level, the measurement is repeated by an instrumentation using a quasi-peak detector.

11.2 Test Results

| Frequency | Max. Level (dBμV) | |
|-----------|-------------------|---------|
| | quasi-peak | average |
| -- kHz | -- | -- |

Limits:

| Frequency of Emission (MHz) | Conducted Limit (dBuV) | |
|-----------------------------|------------------------|----------|
| | Quasi Peak | Average |
| 0.15-0.5 | 66 to 56 | 56 to 46 |
| 0.5-5 | 56 | 46 |
| 5-30 | 60 | 50 |

Comment : The is not required the sample is battery used.

Registration number: W6M20405-5191-C-1
FCC ID: CINUH-2000

12 Frequency Stability vs. Temperature , FCC 2.1055 , 74.861 (e)

12.1 Test procedure

The equipment under test was connected to an external DC power supply and the RF output was connected to a frequency counter via feed through attenuators. The EUT was placed inside the temperature chamber. The DC leads and RF output cable, exited the chamber through an opening made for that purpose.

After the temperature stabilized the frequency output was recorded from the counter.

12.2 Test Results

615 MHz

| °C | Frequency Error (kHz) | Frequency Error (%) |
|-----|-----------------------|---------------------|
| -30 | -13.2 | -0.00214634 |
| -20 | -8.6 | -0.00139837 |
| -10 | -5 | -0.00081301 |
| 0 | -2.9 | -0.00047154 |
| 10 | -2.69 | -0.00043730 |
| 20 | -2.64 | -0.00042927 |
| 30 | -2.4 | -0.00039024 |
| 40 | -3 | -0.00048780 |
| 50 | -4.09 | -0.00066504 |

710 MHz

| °C | Frequency Error (kHz) | Frequency Error (%) |
|-----|-----------------------|---------------------|
| -30 | -1.9 | -0.00026761 |
| -20 | 2 | 0.00028169 |
| -10 | 4.5 | 0.00063380 |
| 0 | 2.8 | 0.00039437 |
| 10 | 1.7 | 0.00023944 |
| 20 | -0.5 | -0.00007042 |
| 30 | -2.9 | -0.00040845 |
| 40 | -5.3 | -0.00074648 |
| 50 | -10.05 | -0.00141549 |



Registration number: W6M20405-5191-C-1
FCC ID: CINUH-2000

804.975 MHz

| °C | Frequency Error (kHz) | Frequency Error (%) |
|-----|-----------------------|---------------------|
| -30 | -5 | -0.00062127 |
| -20 | 1.5 | 0.00018638 |
| -10 | 2.5 | 0.00031064 |
| 0 | 2.32 | 0.00028827 |
| 10 | 0.77 | 0.00009568 |
| 20 | -0.11 | -0.00001367 |
| 30 | -1.28 | -0.00015905 |
| 40 | -4.44 | -0.00055169 |
| 50 | -7 | -0.00086978 |

Limit : ±0.005%

Registration number: W6M20405-5191-C-1
FCC ID: CINUH-2000

13 Frequency Stability vs. Voltage , FCC 2.1055 (d) ; 74.861 (e)

13.1 Test procedure

An external variable DC power supply was connected to the battery terminals of the equipment under test.

For hand carried , battery powered equipment primary supply voltage was reduced to the battery operating end point as specified by the manufacturer. The output frequency was recorded for each battery voltage.

13.2 Test Results

| Frequency in MHz | Frequency Error (kHz) | Frequency Error (%) |
|------------------|-----------------------|---------------------|
| 614.9915 | -13.2 | 0.00214 |
| 709.9965 | -10.05 | 0.00141 |
| 804.9794 | -5 | 0.000621 |

Limit : $\pm 0.005\%$

Registration number: W6M20405-5191-C-1
FCC ID: CINUH-2000

Appendix

- A RF Power Output
- B Audio frequency response
- C Occupied Bandwidth / Emission Mask
- D Spurious Emissions at Antenna Terminals
- E Radiation Spurious Emission
- F Line Conducted Emissions
- G Frequency Stability vs. Temperature
- H Frequency Stability vs. Voltage
- I Pictures



Registration number: W6M20405-5191-C-1
FCC ID: CINUH-2000

Appendix A

RF Power Output

Transmitter carrier power under normal conditions

in according to FCC Part 74.861

EUT: Wireless Microphone Transmitter
MODEL NO.: UH-2000 Low channel
Approval Holder: CHIAYO ELECTRONICS CO.,LTD
Test Site / Operator: ETS / PIERCE PENG
Temperature/Voltage: Temp.: 23°C/ Unom.: 3 VDC (1.5 x 2 Battery)
Test Specification: 74.861
Comment 1: Dist.: 3m, Ant.: HL 223
Freq:614.994MHz Pmax:0.35dBm RBW: 100 kHz

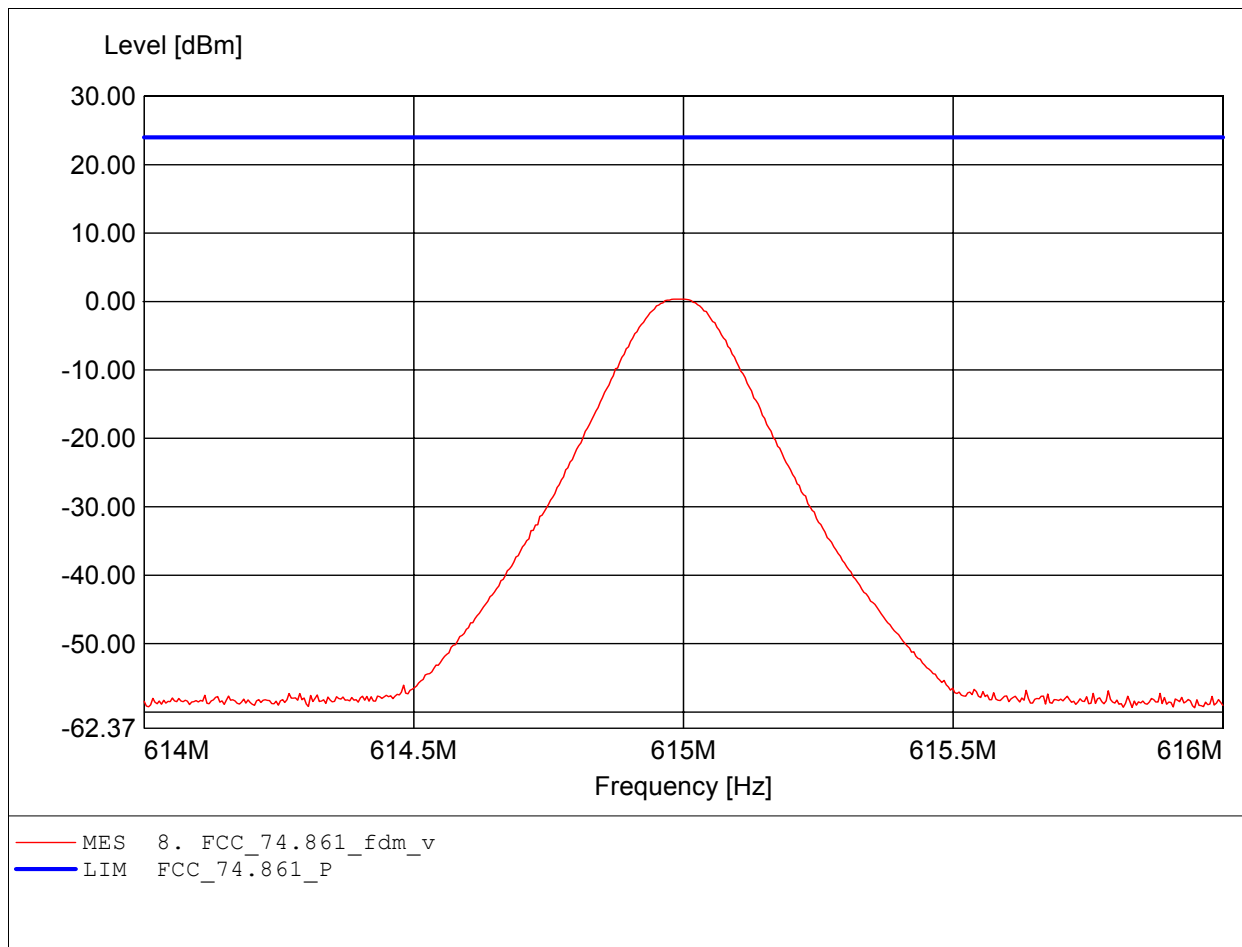

Transmitter carrier power under normal conditions

in according to FCC Part 74.861

EUT: Wireless Microphone Transmitter
MODEL NO.: UH-2000 Low channel
Approval Holder: CHIAYO ELECTRONICS CO.,LTD
Test Site / Operator: ETS / PIERCE PENG
Temperature/Voltage: Temp.: 23°C/ Unom.: 3 VDC (1.5 x 2 Battery)
Test Specification: 74.861
Comment 1: Dist.: 3m, Ant.: HL 223
Freq:614.998MHz Pmax:-8.32dBm RBW: 100 kHz

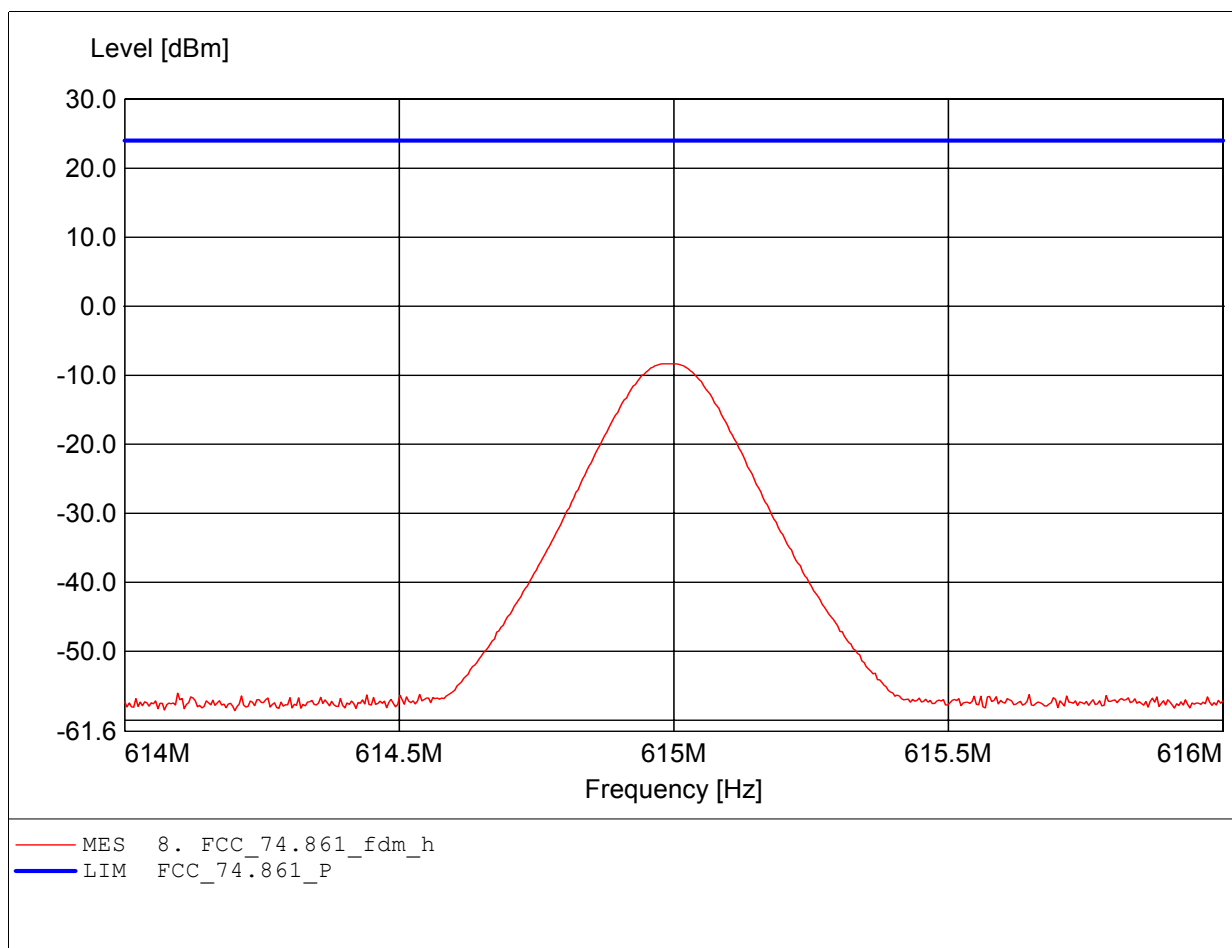

Transmitter carrier power under normal conditions

in according to FCC Part 74.861

EUT: Wireless Microphone Transmitter
MODEL NO.: UH-2000 Middle channel
Approval Holder: CHIAYO ELECTRONICS CO.,LTD
Test Site / Operator: ETS / PIERCE PENG
Temperature/Voltage: Temp.: 23°C/ Unom.: 3 VDC (1.5 x 2 Battery)
Test Specification: 74.861
Comment 1: Dist.: 3m, Ant.: HL 223
Freq:709.998MHz Pmax:-0.50dBm RBW: 100 kHz

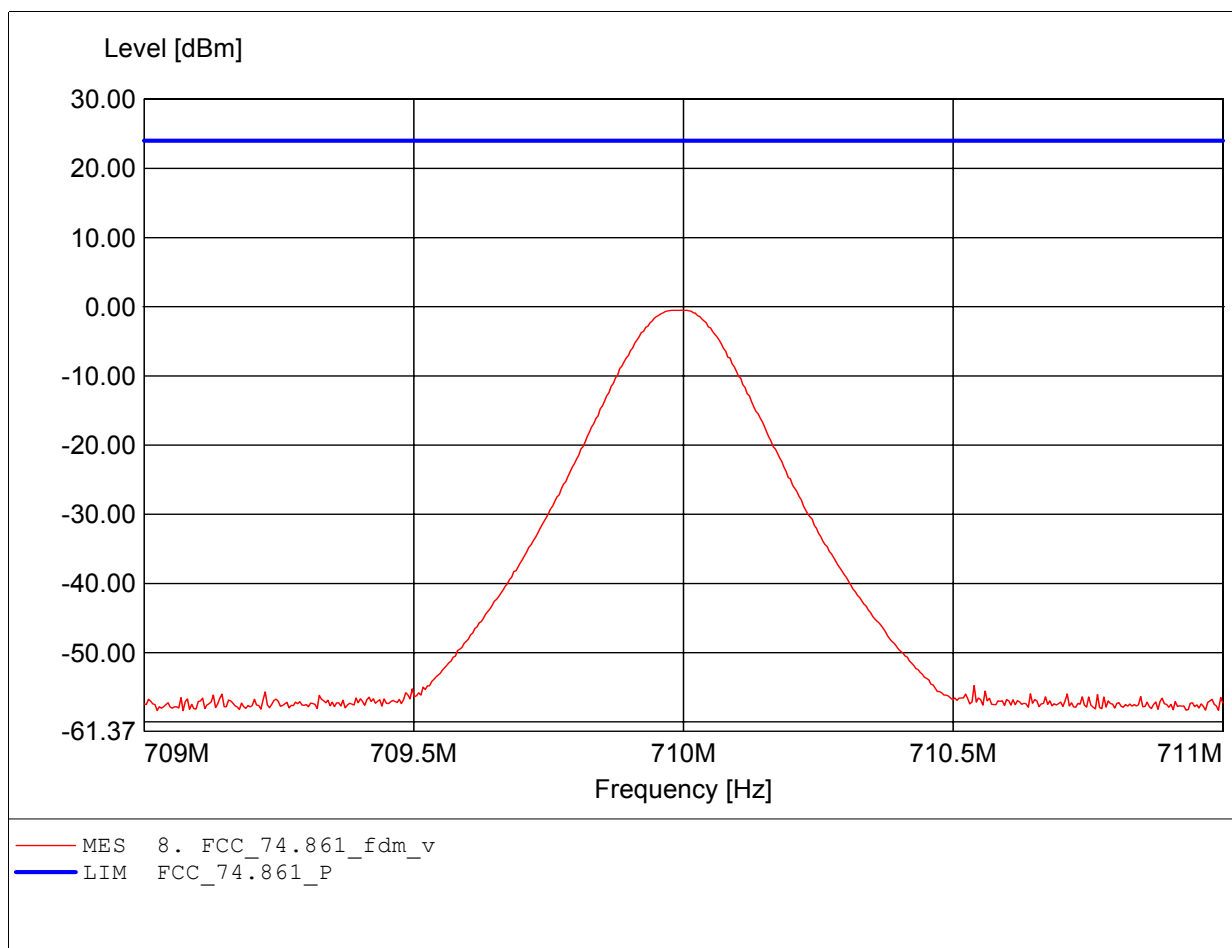

Transmitter carrier power under normal conditions

in according to FCC Part 74.861

EUT: Wireless Microphone Transmitter
MODEL NO.: UH-2000 Middle channel
Approval Holder: CHIAYO ELECTRONICS CO.,LTD
Test Site / Operator: ETS / PIERCE PENG
Temperature/Voltage: Temp.: 23°C/ Unom.: 3 VDC (1.5 x 2 Battery)
Test Specification: 74.861
Comment 1: Dist.: 3m, Ant.: HL 223
Freq:709.994MHz Pmax:-9.36dBm RBW: 100 kHz

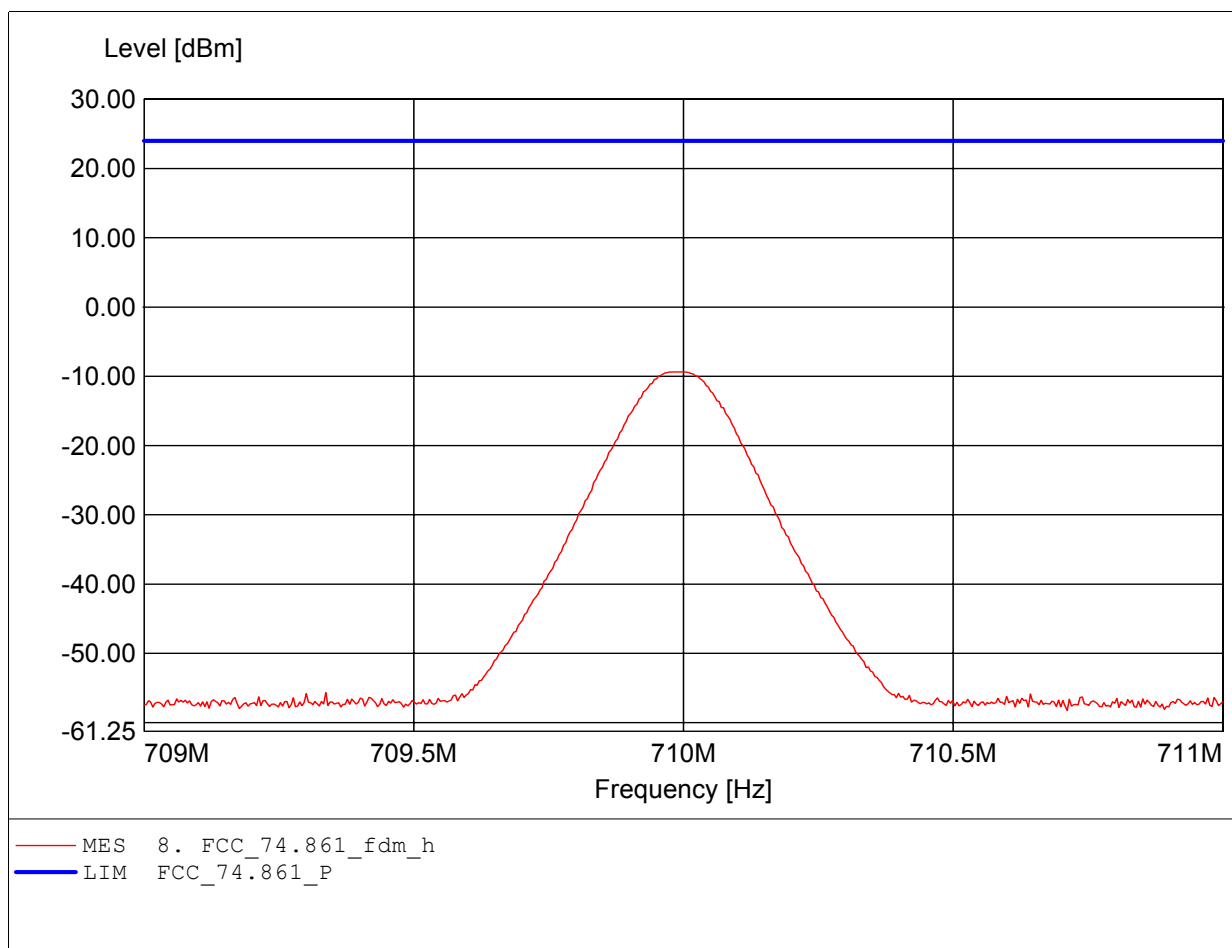

Transmitter carrier power under normal conditions

in according to FCC Part 74.861

EUT: Wireless Microphone Transmitter
MODEL NO.: UH-2000 High channel
Approval Holder: CHIAYO ELECTRONICS CO.,LTD
Test Site / Operator: ETS / PIERCE PENG
Temperature/Voltage: Temp.: 23°C/ Unom.: 3 VDC (1.5 x 2 Battery)
Test Specification: 74.861
Comment 1: Dist.: 3m, Ant.: HL 223
Freq:804.973MHz Pmax:-2.42dBm RBW: 100 kHz

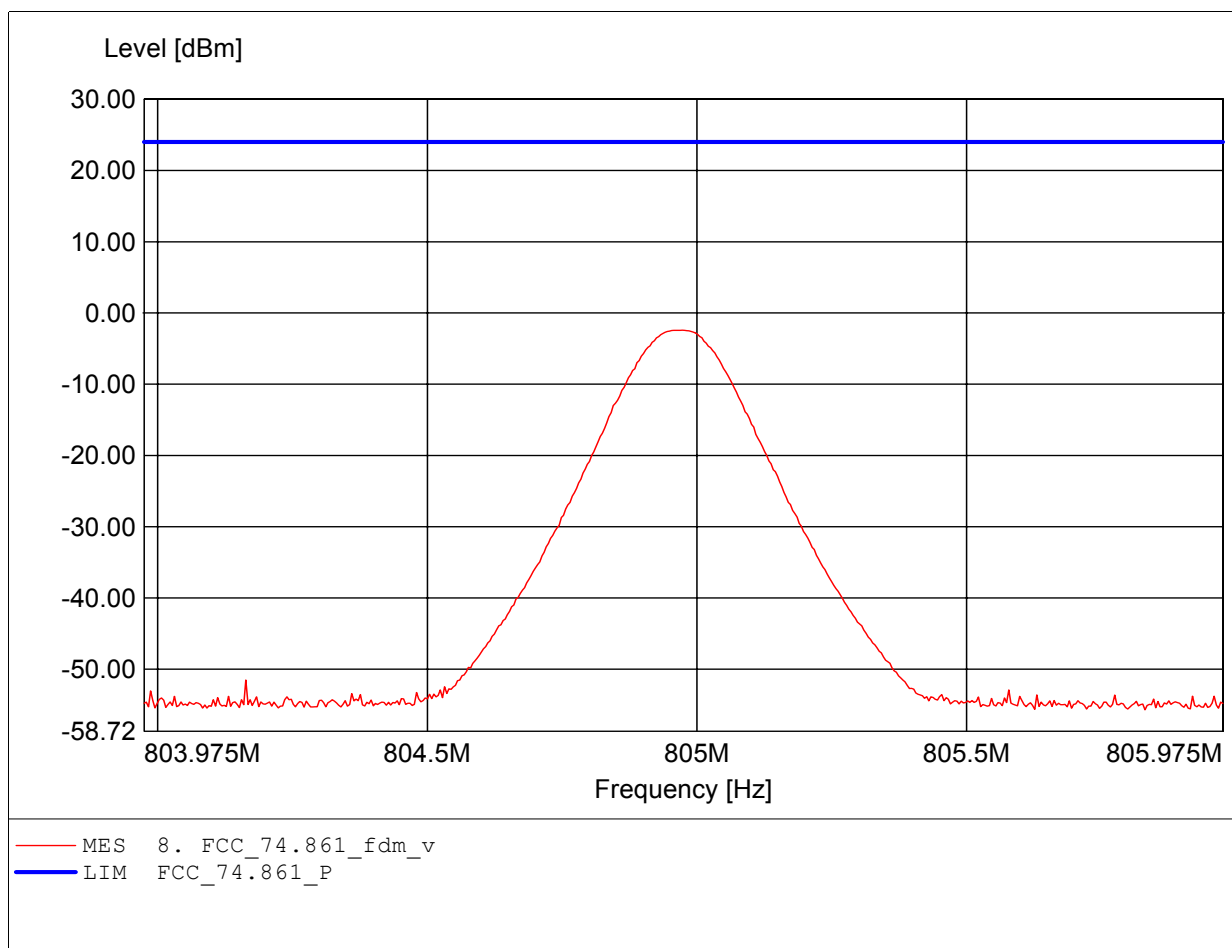

Transmitter carrier power under normal conditions

in according to FCC Part 74.861

EUT: Wireless Microphone Transmitter
MODEL NO.: UH-2000 High channel
Approval Holder: CHIAYO ELECTRONICS CO.,LTD
Test Site / Operator: ETS / PIERCE PENG
Temperature/Voltage: Temp.: 23°C/ Unom.: 3 VDC (1.5 x 2 Battery)
Test Specification: 74.861
Comment 1: Dist.: 3m, Ant.: HL 223
Freq:804.961MHz Pmax:-18.62dBm RBW: 100 kHz

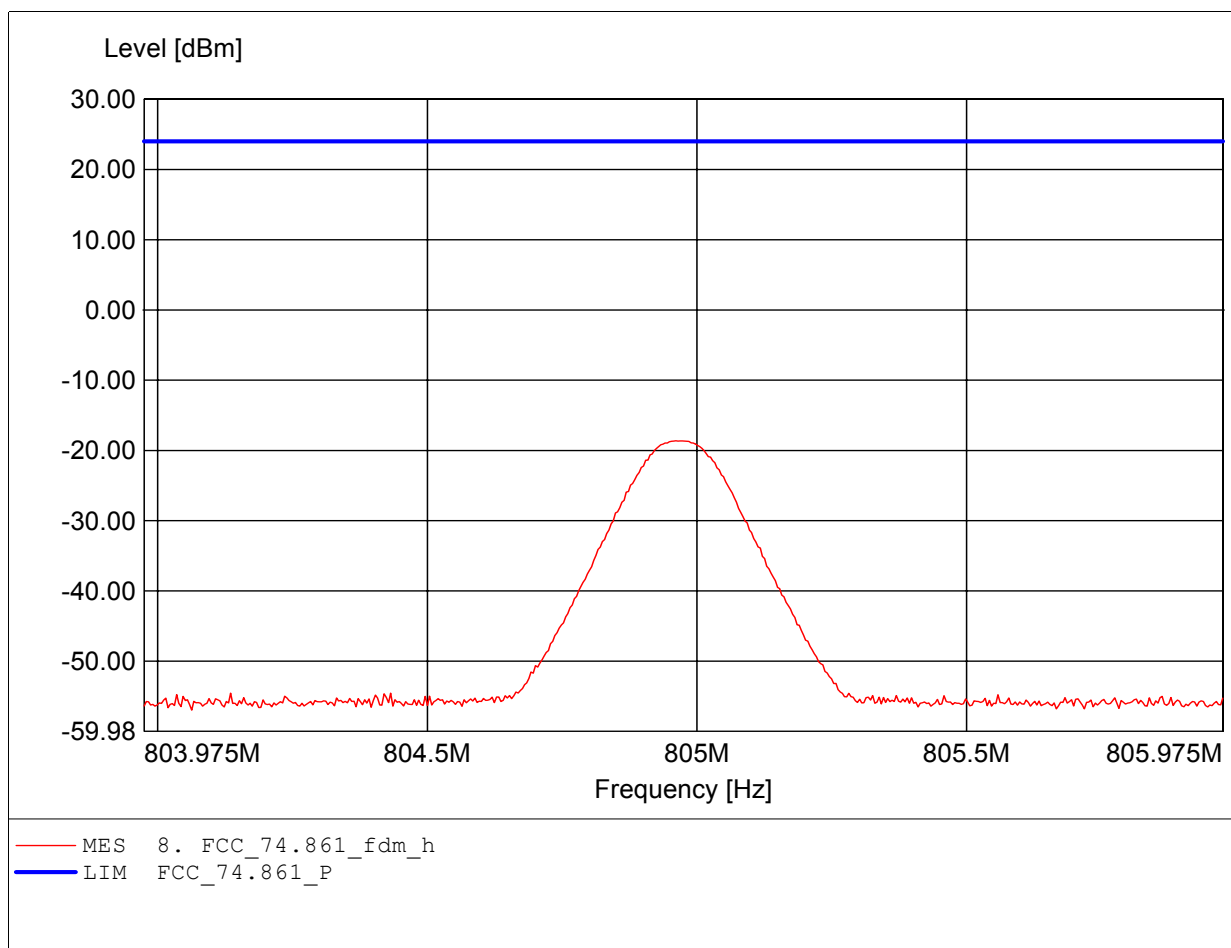



Marker 1 [T1] RBW 100 kHz RF Att 50 dB
Ref Lvl -1.50 dBm VBW 100 kHz
30 dBm 614.99549098 MHz SWT 200 ms Unit dBm

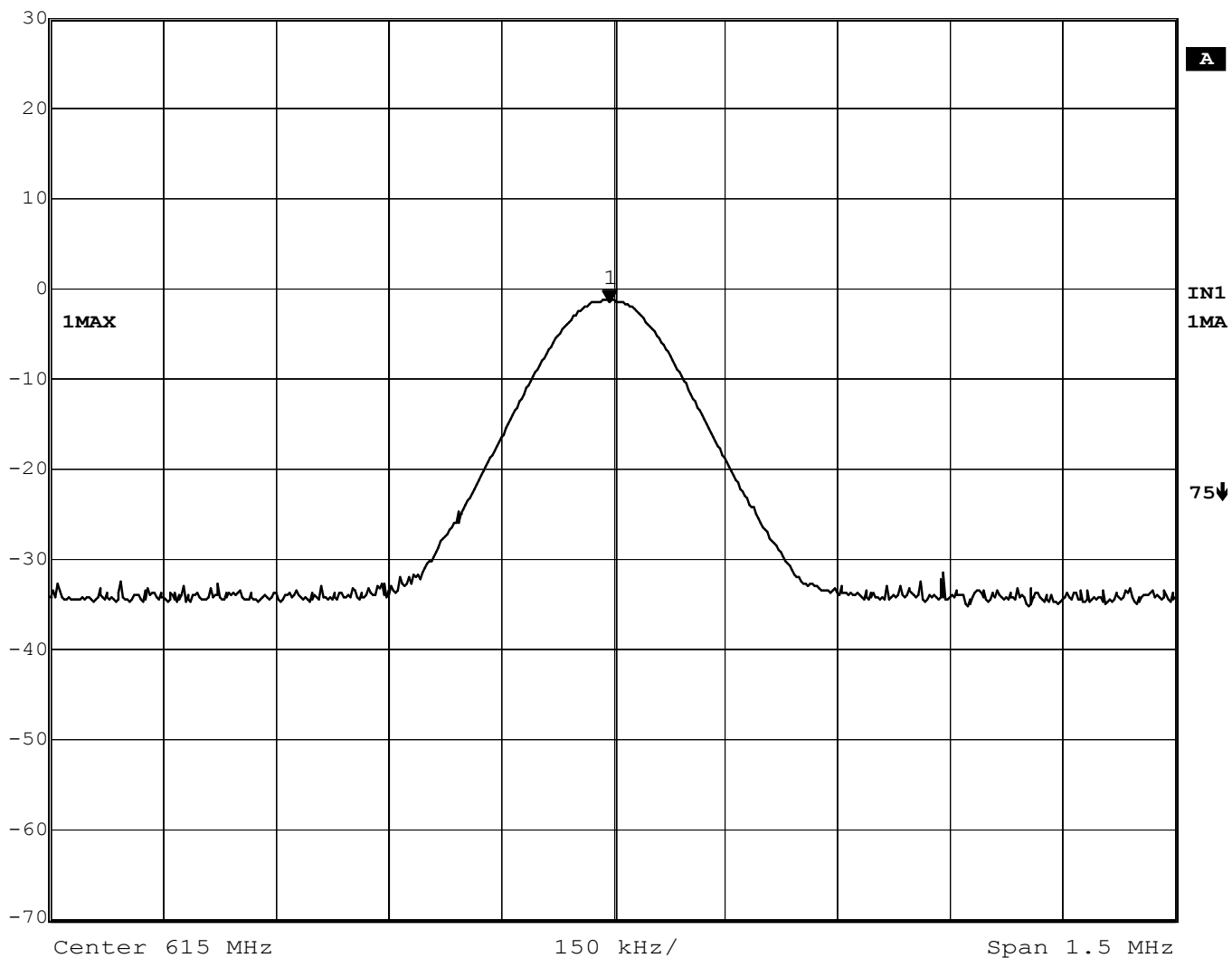

Title: 615MHz
Date: 20.JUL.2004 15:20:12



| | | | | | |
|---------|------------------|-----|---------|--------|-------|
| Ref Lvl | Marker 1 [T1] | RBW | 100 kHz | RF Att | 50 dB |
| 30 dBm | -1.82 dBm | VBW | 100 kHz | Unit | |
| | 709.99248497 MHz | SWT | 200 ms | | dBm |

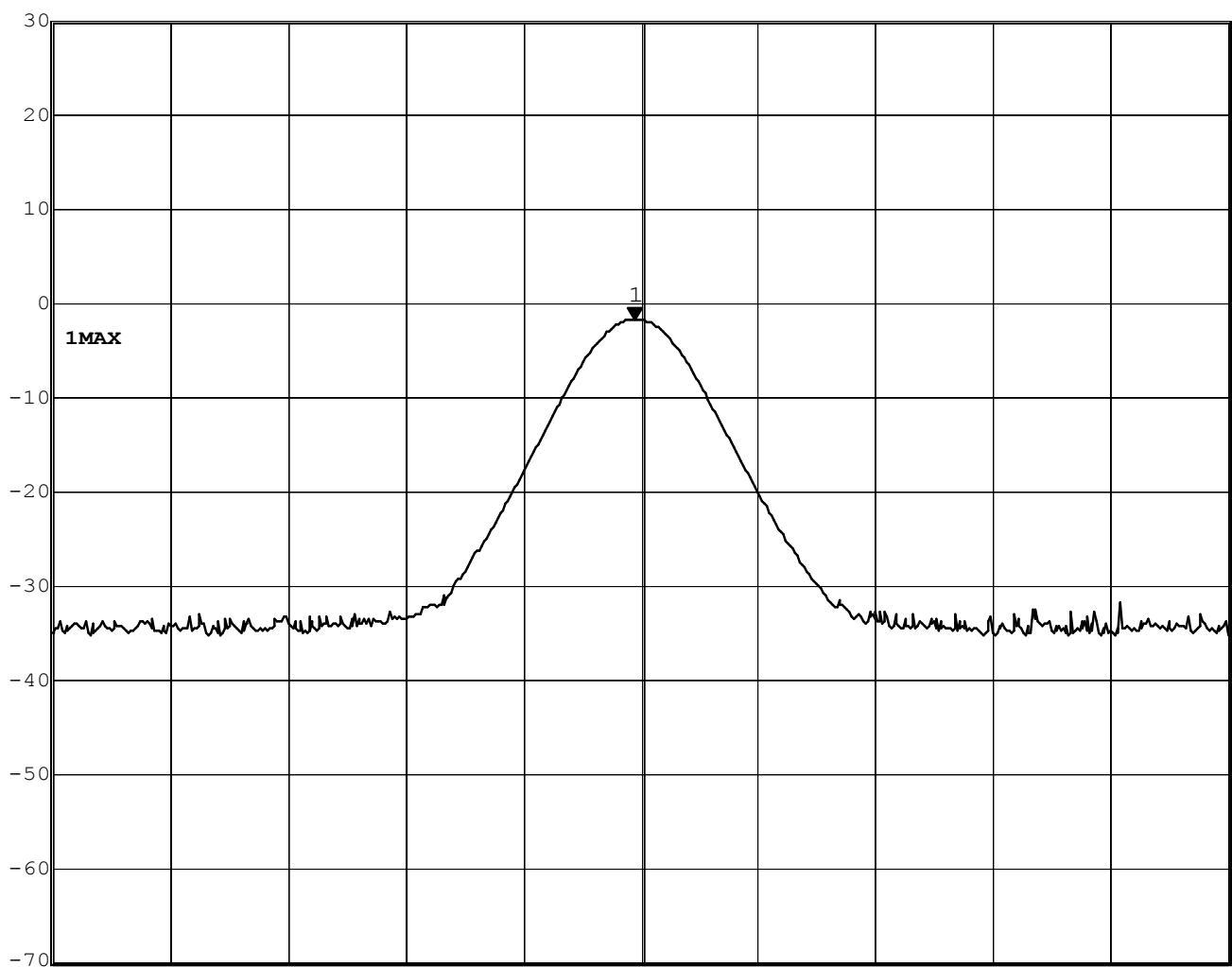

Title: 710MHz
Date: 20.JUL.2004 15:28:28



Marker 1 [T1] RBW 100 kHz RF Att 40 dB
Ref Lvl -4.40 dBm VBW 100 kHz
10 dBm 804.97049098 MHz SWT 200 ms Unit dBm

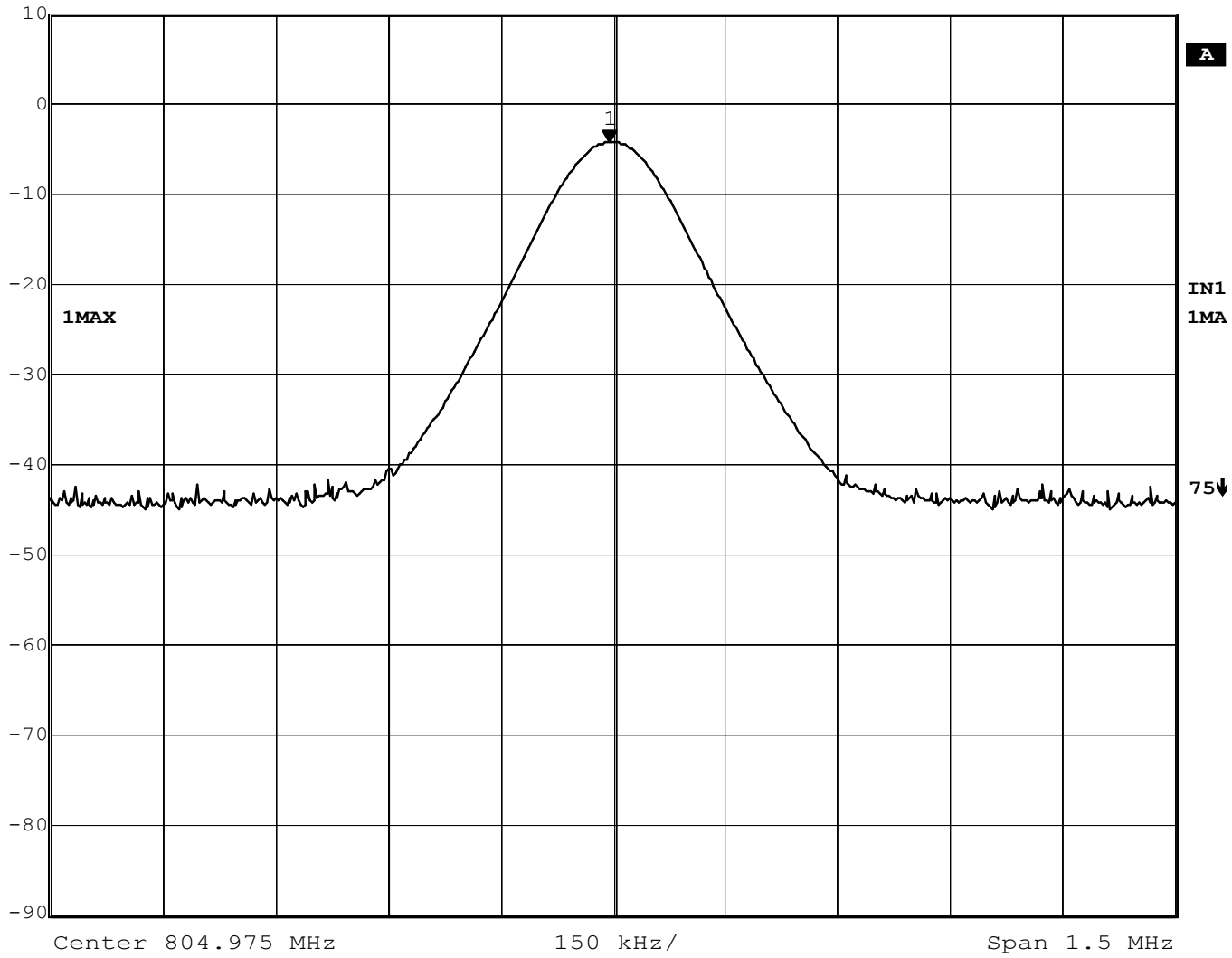

Title: 804.975MHz
Date: 20.JUL.2004 17:55:17



Registration number: W6M20405-5191-C-1
FCC ID: CINUH-2000

Appendix B

Audio frequency response

Registration number: W6M20405-5191-C-1
 FCC ID: CINUH-2000

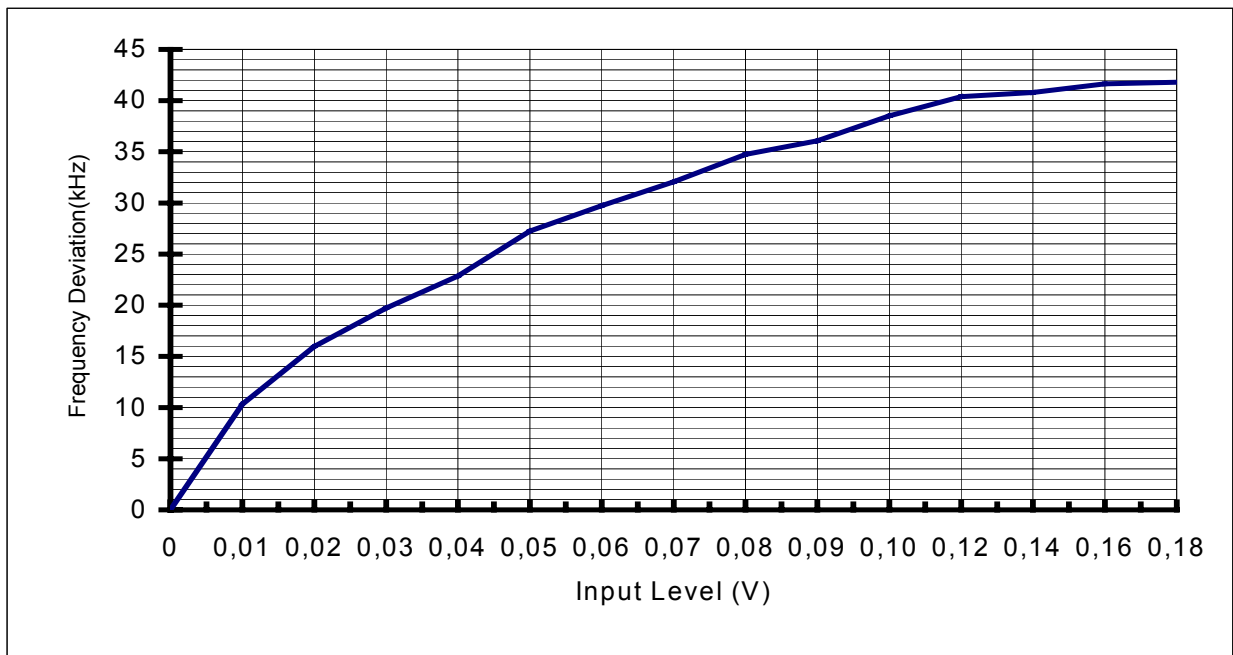
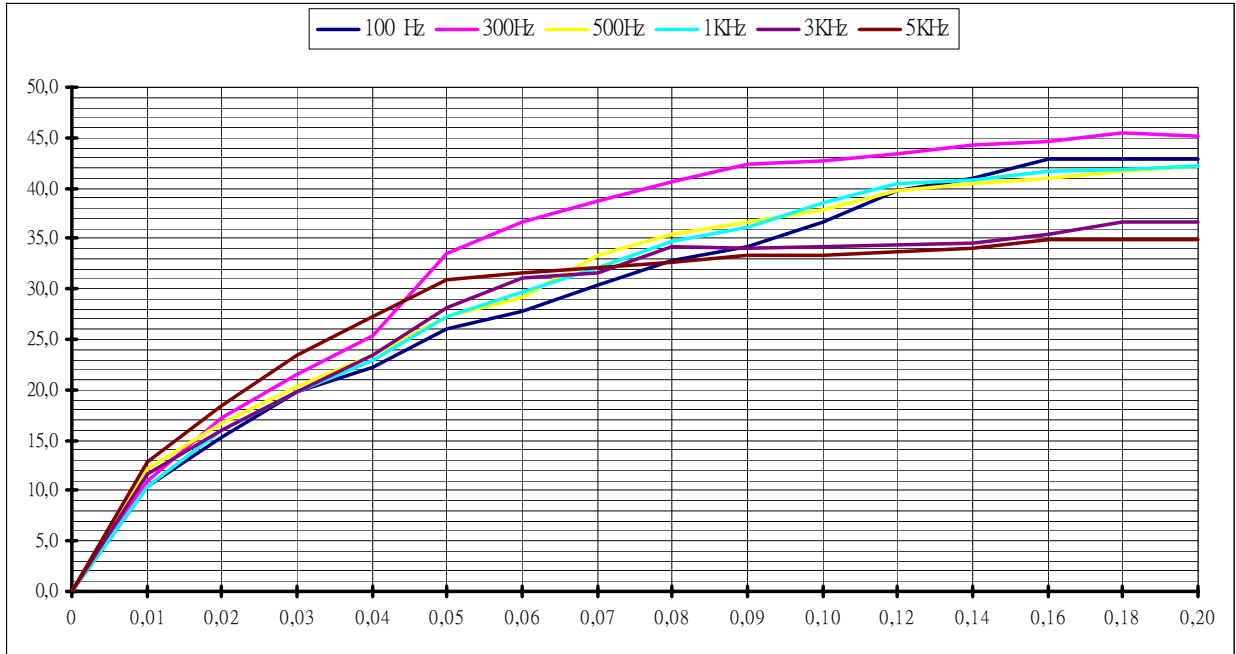

Registration number: W6M20405-5191-C-1
FCC ID: CINUH-2000

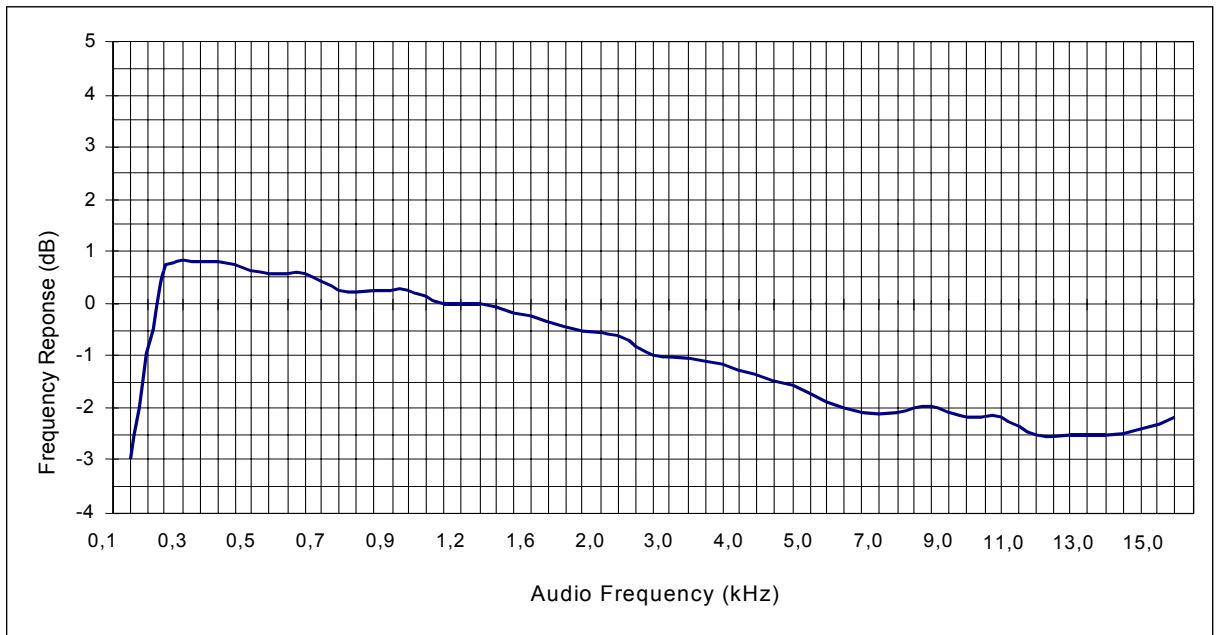
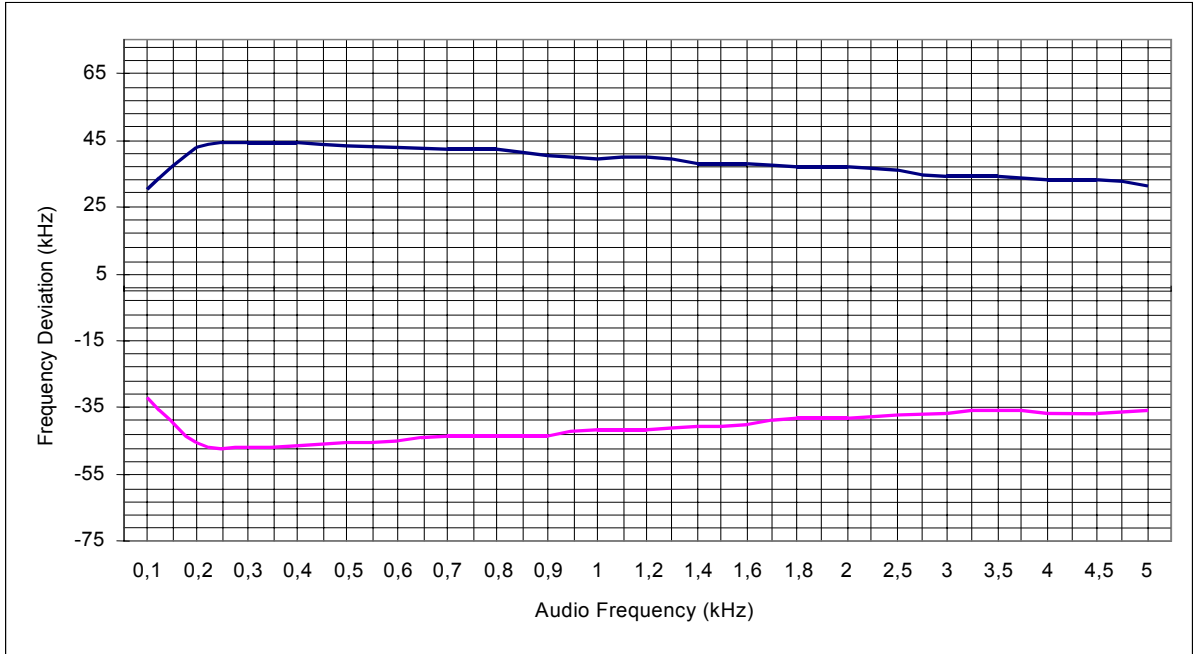



Registration number: W6M20405-5191-C-1
FCC ID: CINUH-2000

Appendix C

Occupied Bandwidth / Emission Mask



Marker 1 [T1] RBW 3 kHz RF Att 30 dB
Ref Lvl -26.62 dBm VBW 3 kHz
10 dBm 614.99799599 MHz SWT 1 s Unit dBm

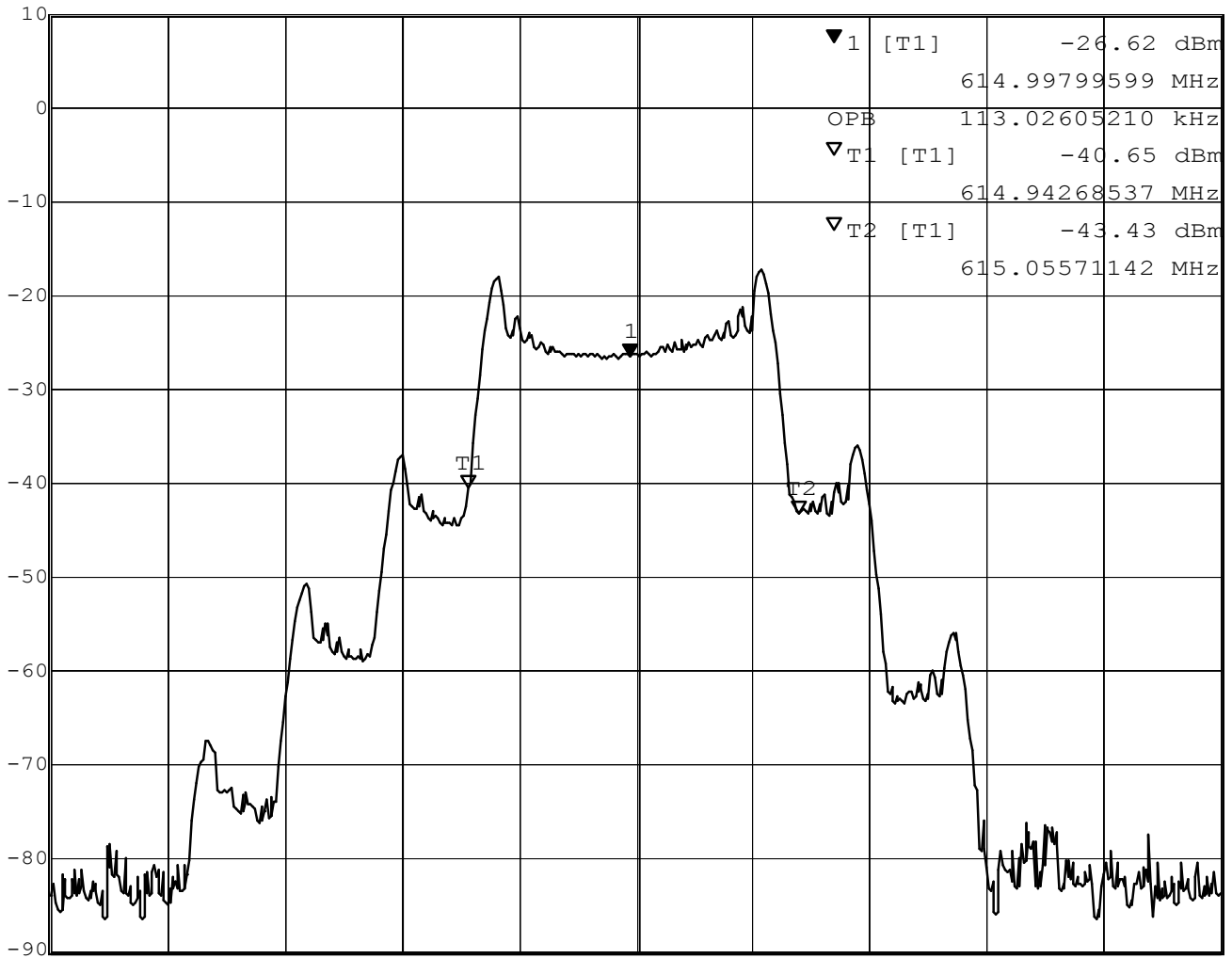

A

IN1
1MA

Title: With 1000Hz Modulation
Date: 26.MAY.2004 19:00:08



Marker 1 [T1] RBW 3 kHz RF Att 30 dB
Ref Lvl -27.02 dBm VBW 3 kHz
10 dBm 614.99799599 MHz SWT 1 s Unit dBm

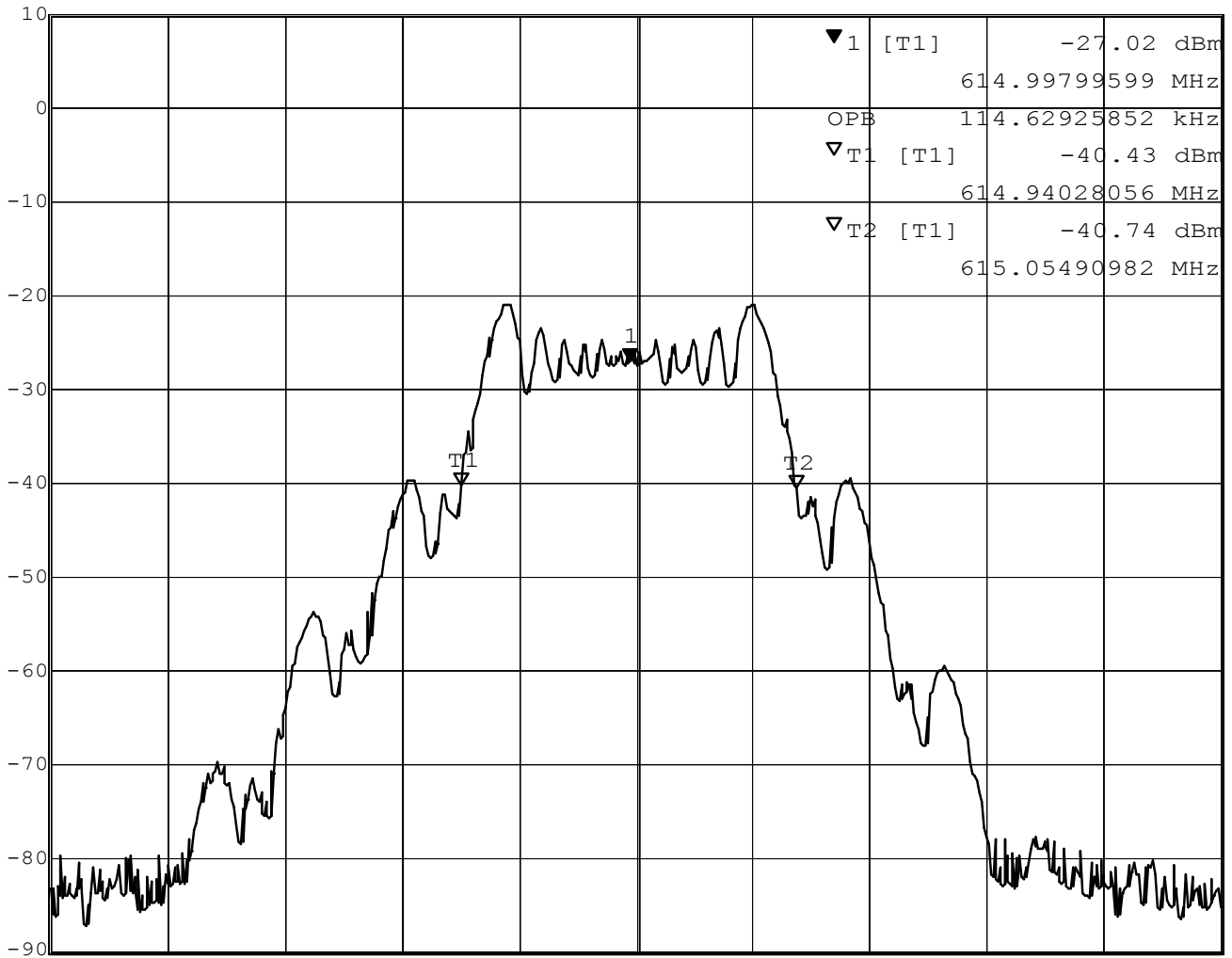

A

IN1
1MA

Title: With 2500Hz Modulation
Date: 26.MAY.2004 18:58:56



Marker 1 [T1] RBW 3 kHz RF Att 30 dB
Ref Lvl -26.67 dBm VBW 3 kHz
10 dBm 709.99799599 MHz SWT 1 s Unit dBm

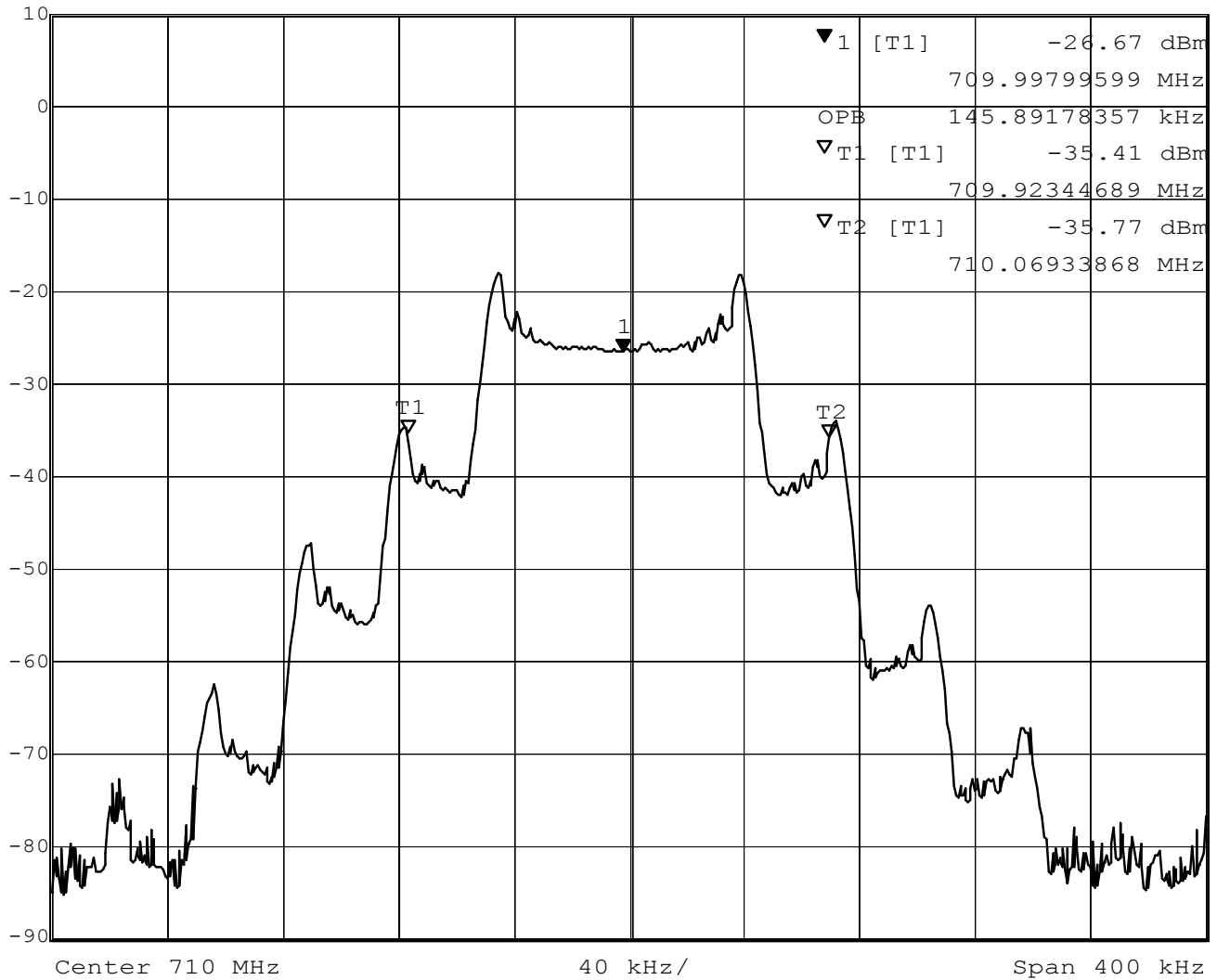

Title: With 1000Hz Modulation
Date: 26.MAY.2004 18:25:17



Marker 1 [T1] RBW 3 kHz RF Att 30 dB
Ref Lvl -29.92 dBm VBW 3 kHz
10 dBm 709.99799599 MHz SWT 1 s Unit dBm

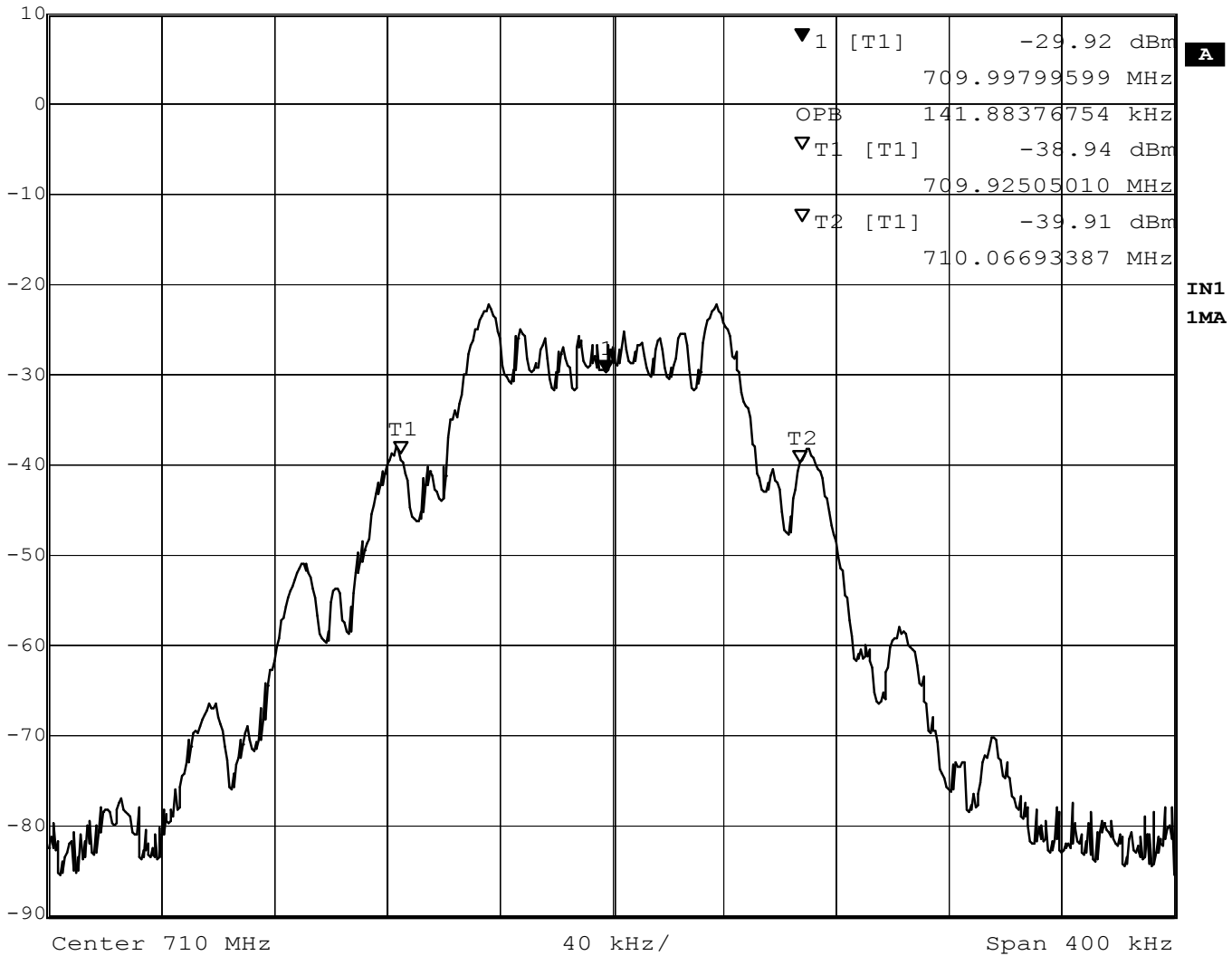

Title: With 2500Hz Modulation
Date: 26.MAY.2004 18:22:57



Marker 1 [T1] RBW 3 kHz RF Att 30 dB
Ref Lvl -31.90 dBm VBW 3 kHz
10 dBm 804.97292180 MHz SWT 1 s Unit dBm

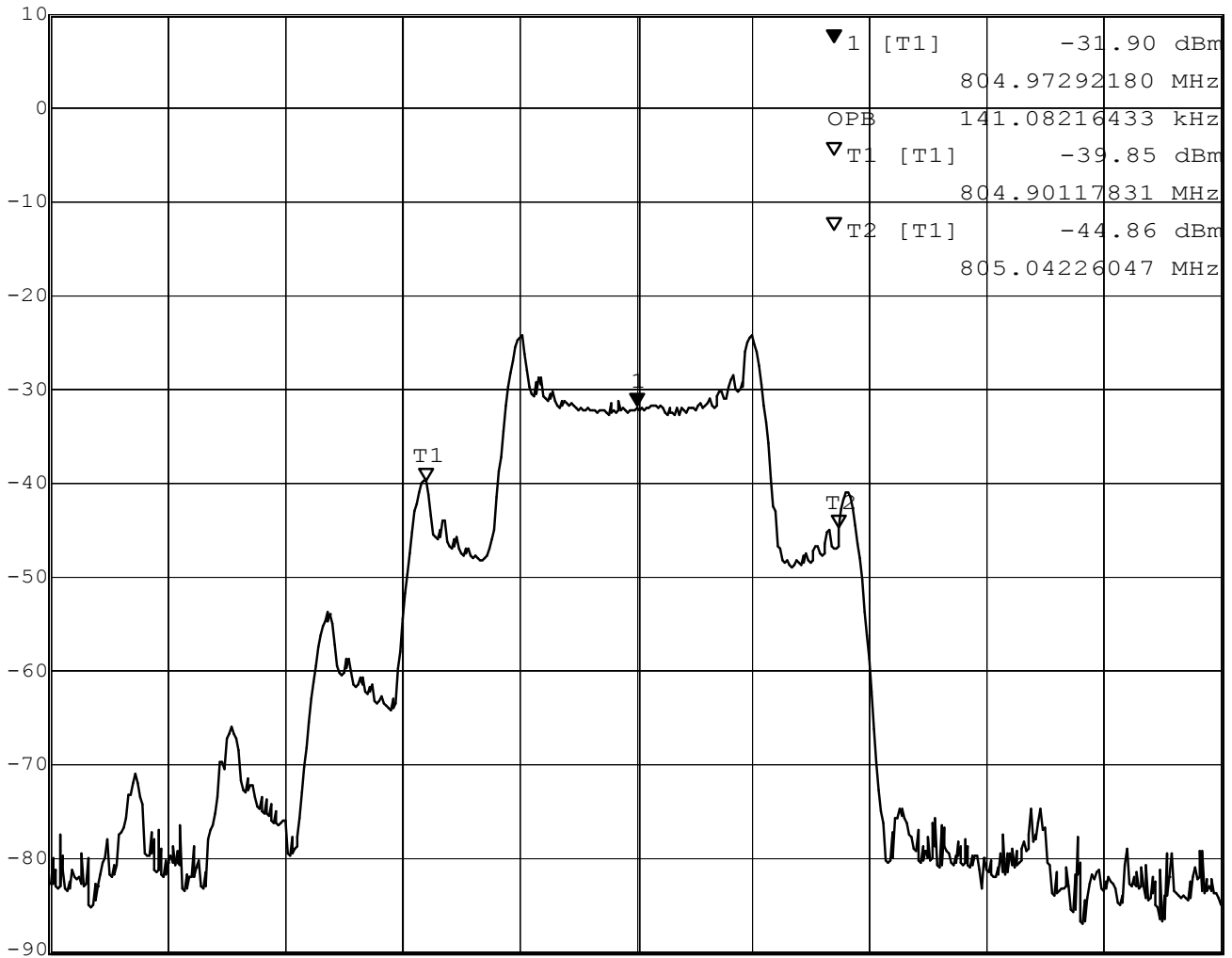

Center 804.9729218 MHz 40 kHz/ Span 400 kHz

Title: With 1000Hz Modulation
Date: 26.MAY.2004 17:09:09



Marker 1 [T1] RBW 3 kHz RF Att 30 dB
Ref Lvl -32.22 dBm VBW 3 kHz
10 dBm 804.97292180 MHz SWT 1 s Unit dBm

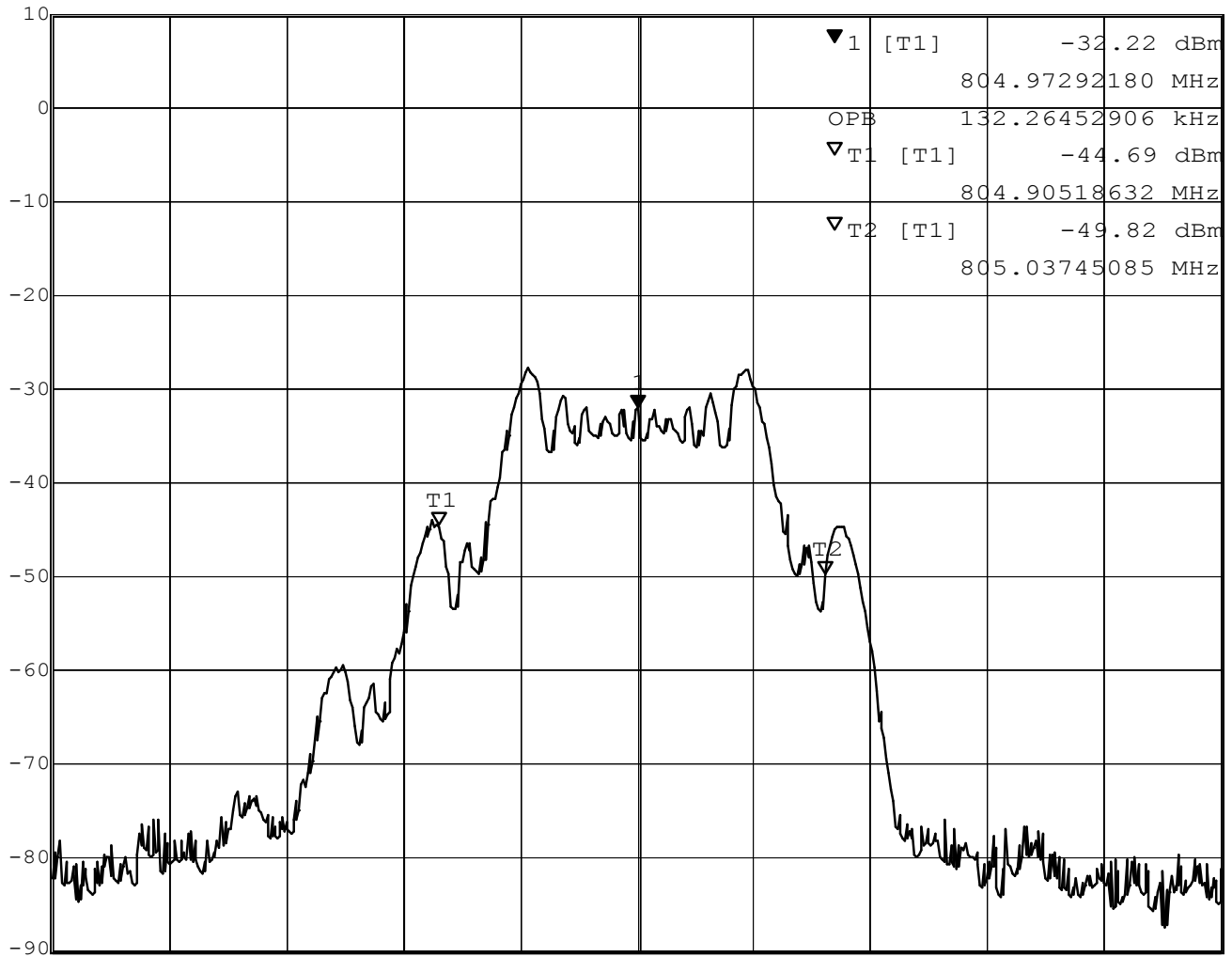

Center 804.9729218 MHz 40 kHz/ Span 400 kHz

Title: With 2500Hz Modulation
Date: 26.MAY.2004 17:10:39



Marker 1 [T1] RBW 1 kHz RF Att 20 dB
Ref Lvl -21.16 dBm VBW 1 kHz
-1 dBm 614.99799599 MHz SWT 5 s Unit dBm

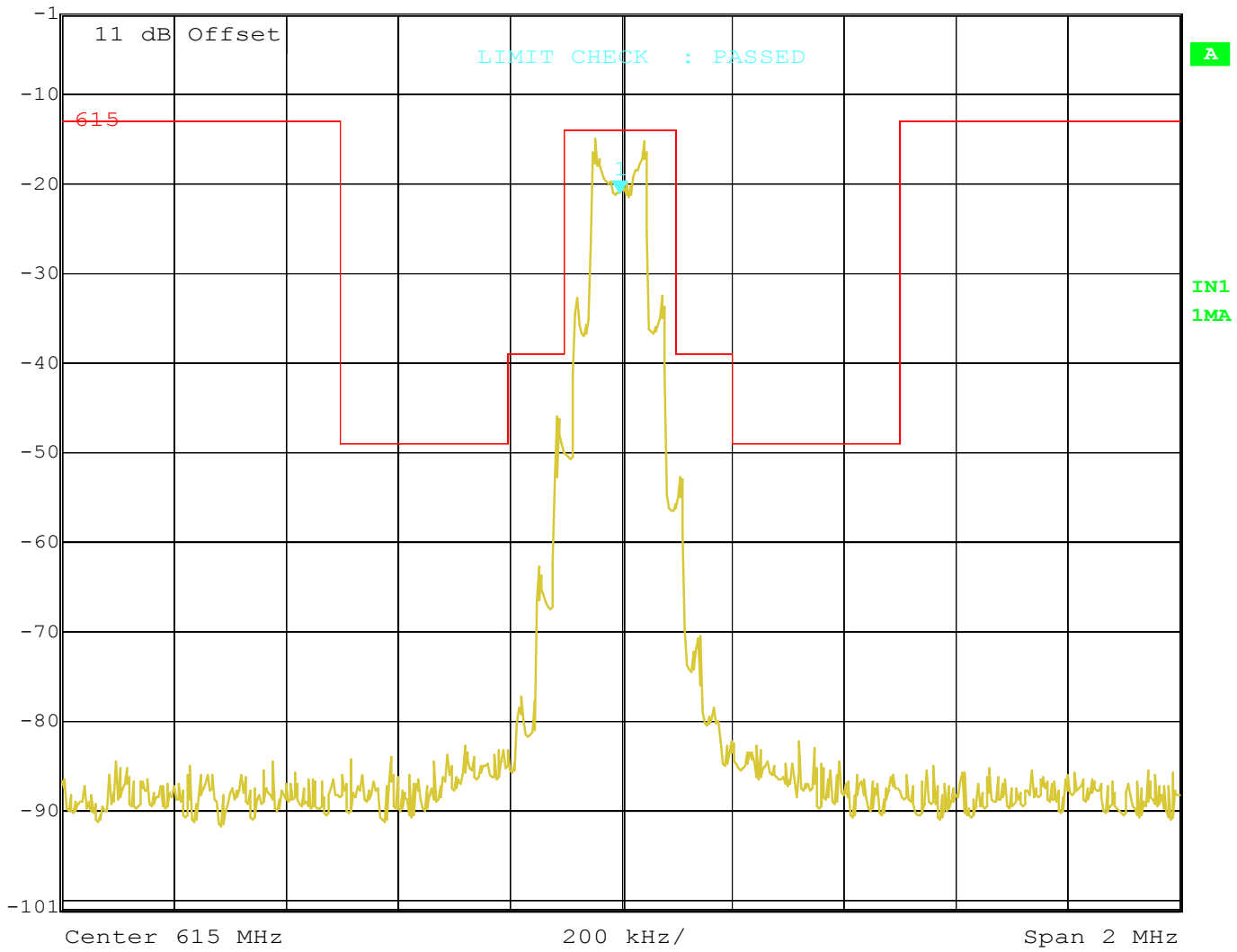

Title: 615
Date: 28.MAY.2004 15:46:19



Marker 1 [T1] RBW 1 kHz RF Att 20 dB
Ref Lvl -18.52 dBm VBW 1 kHz
2 dBm 709.99799599 MHz SWT 5 s Unit dBm

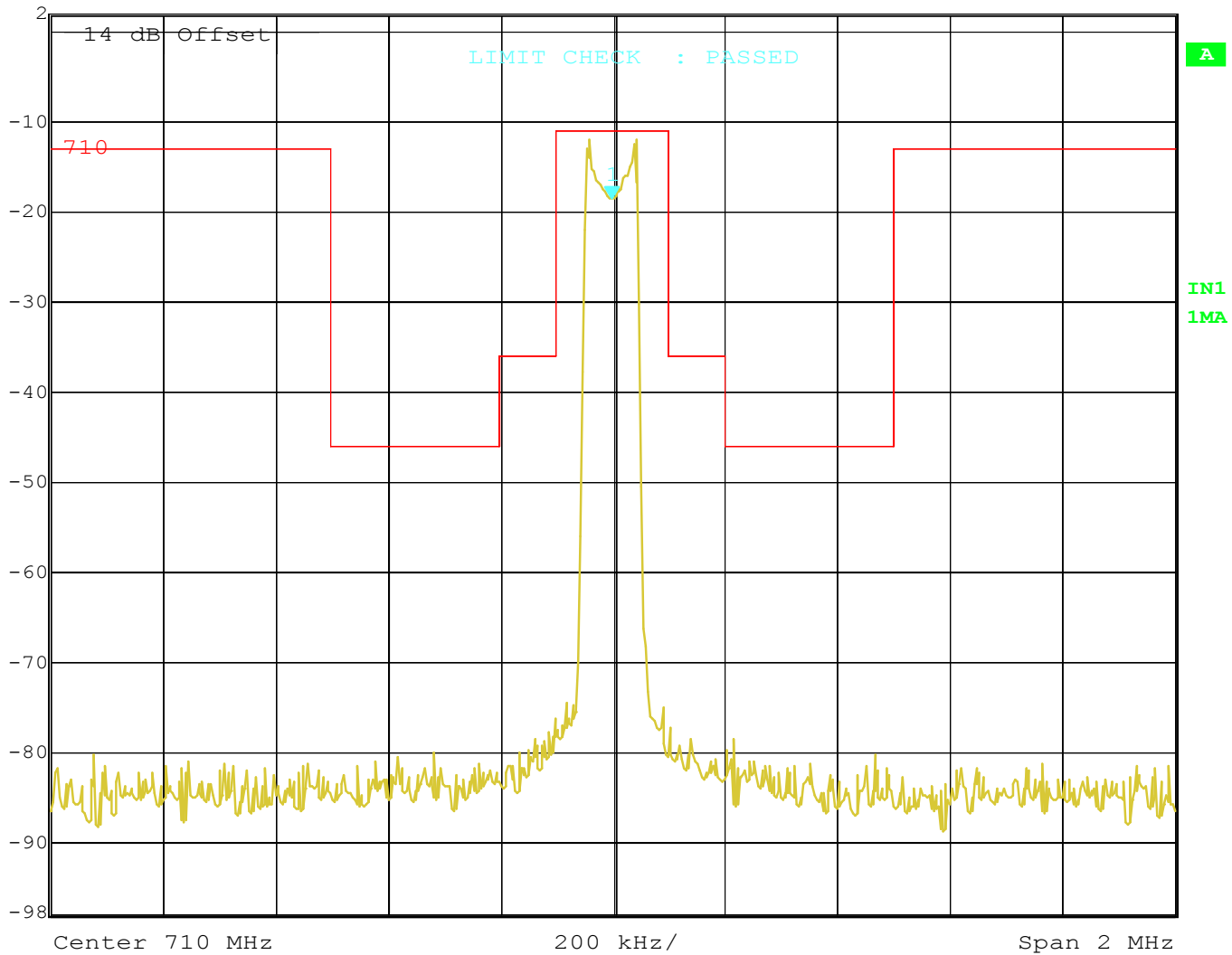

Title: 710
Date: 28.MAY.2004 15:39:37



Marker 1 [T1] RBW 1 kHz RF Att 20 dB
Ref Lvl -24.91 dBm VBW 1 kHz
2 dBm 804.97299599 MHz SWT 5 s Unit dBm

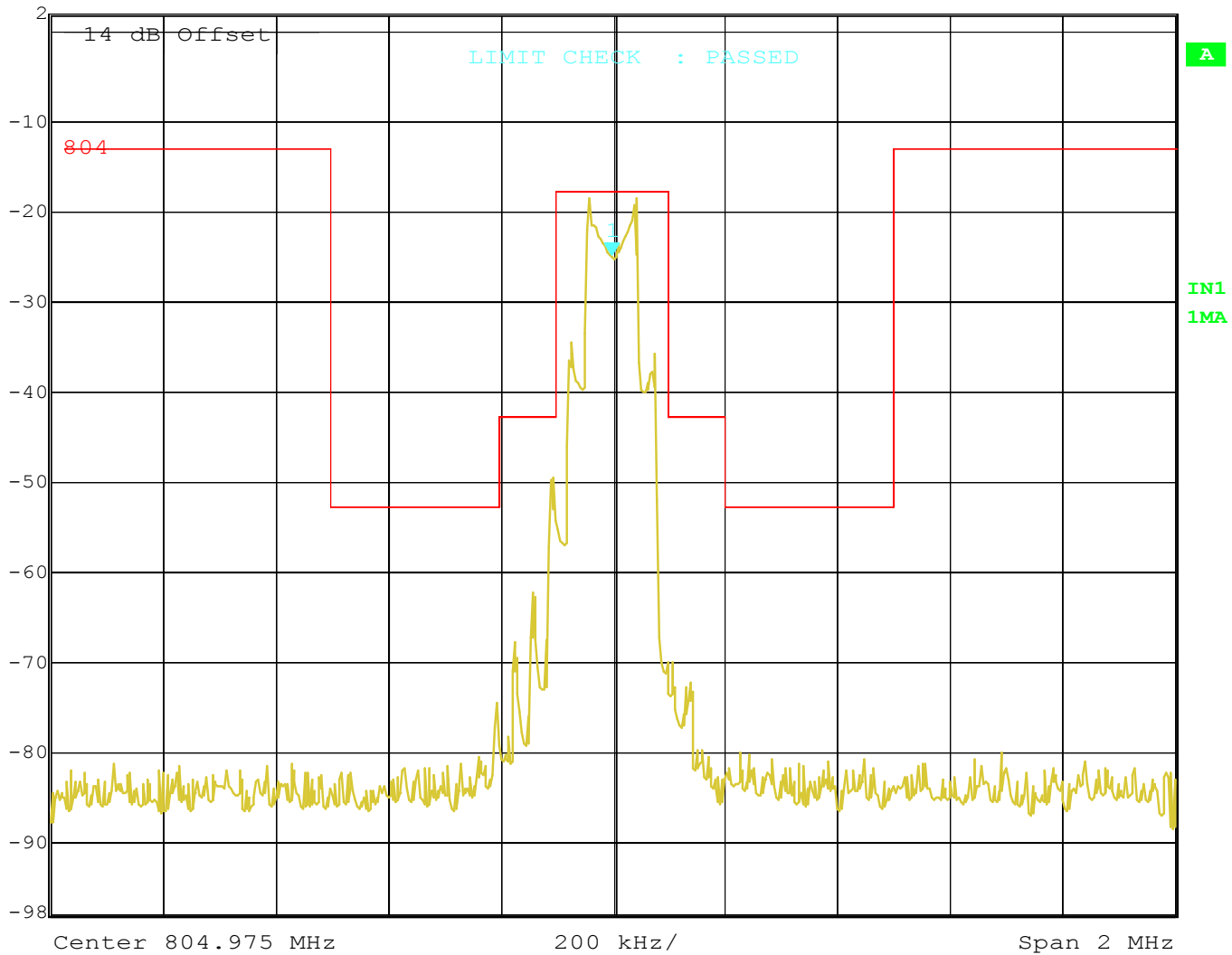

Title: 804.975
Date: 28.MAY.2004 15:30:39



Registration number: W6M20405-5191-C-1
FCC ID: CINUH-2000

Appendix D

Spurious Emissions at Antenna Terminals



Marker 1 [T1] RBW 100 kHz RF Att 30 dB
Ref Lvl -13.69 dBm VBW 100 kHz
10 dBm 615.08016032 MHz SWT 300 ms Unit dBm

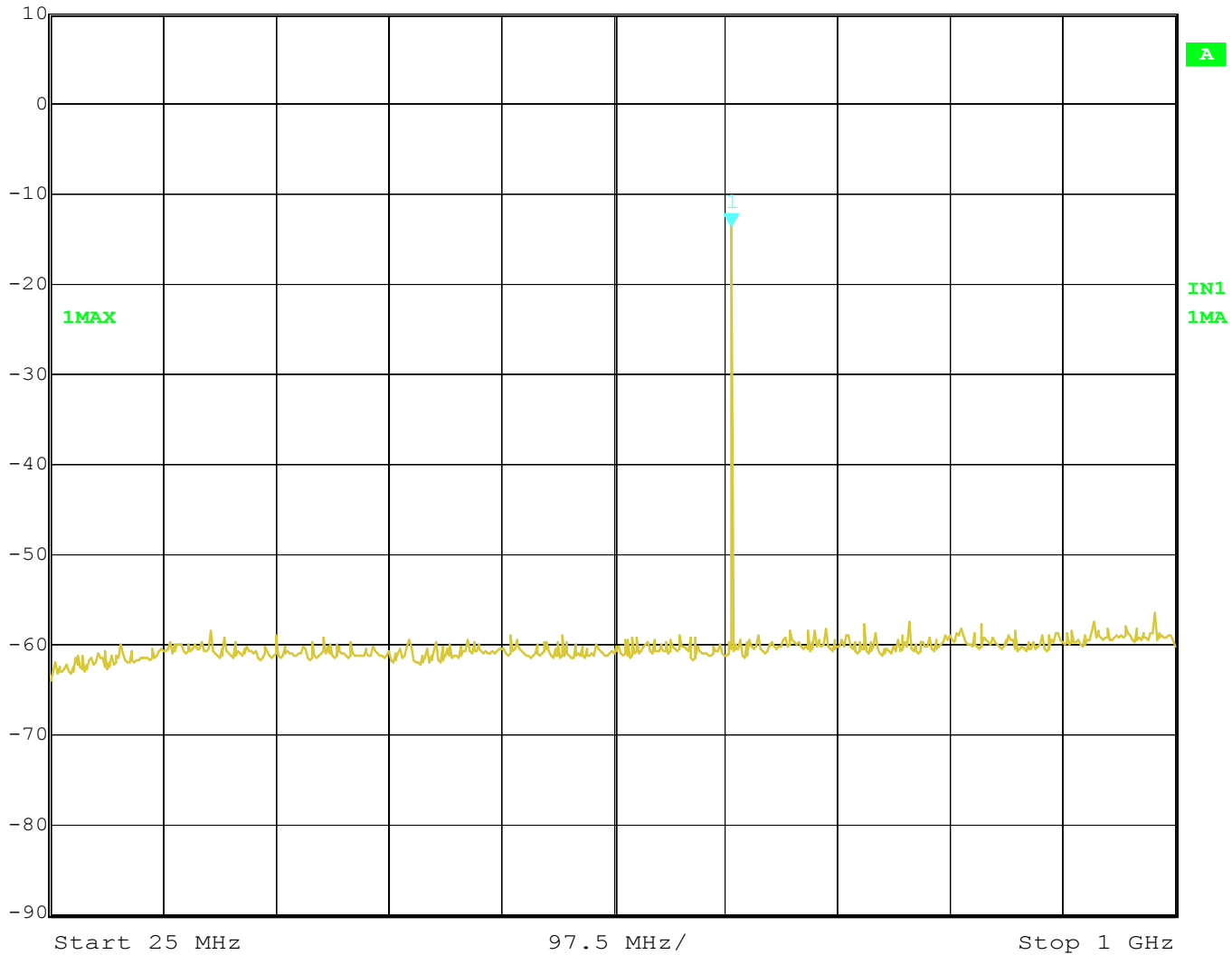

Title: 615MHz
Date: 10.JUN.2004 10:30:59



Marker 1 [T1] RBW 100 kHz RF Att 30 dB
Ref Lvl -54.32 dBm VBW 100 kHz
10 dBm 2.81563126 GHz SWT 1 s Unit dBm

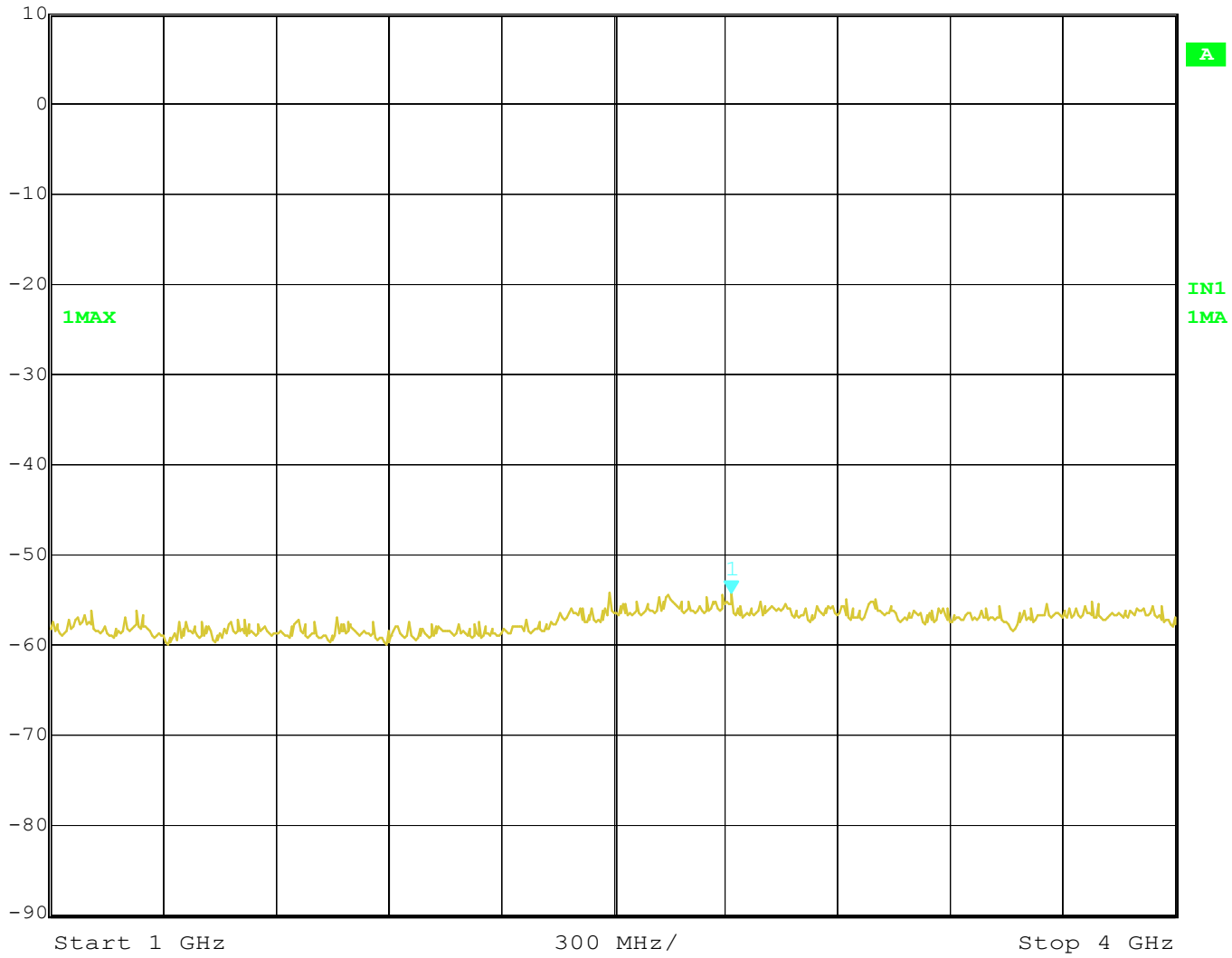

Title: 615MHz
Date: 10.JUN.2004 10:31:43



Marker 1 [T1] RBW 100 kHz RF Att 30 dB
Ref Lvl -53.01 dBm VBW 100 kHz
10 dBm 6.90981964 GHz SWT 1 s Unit dBm

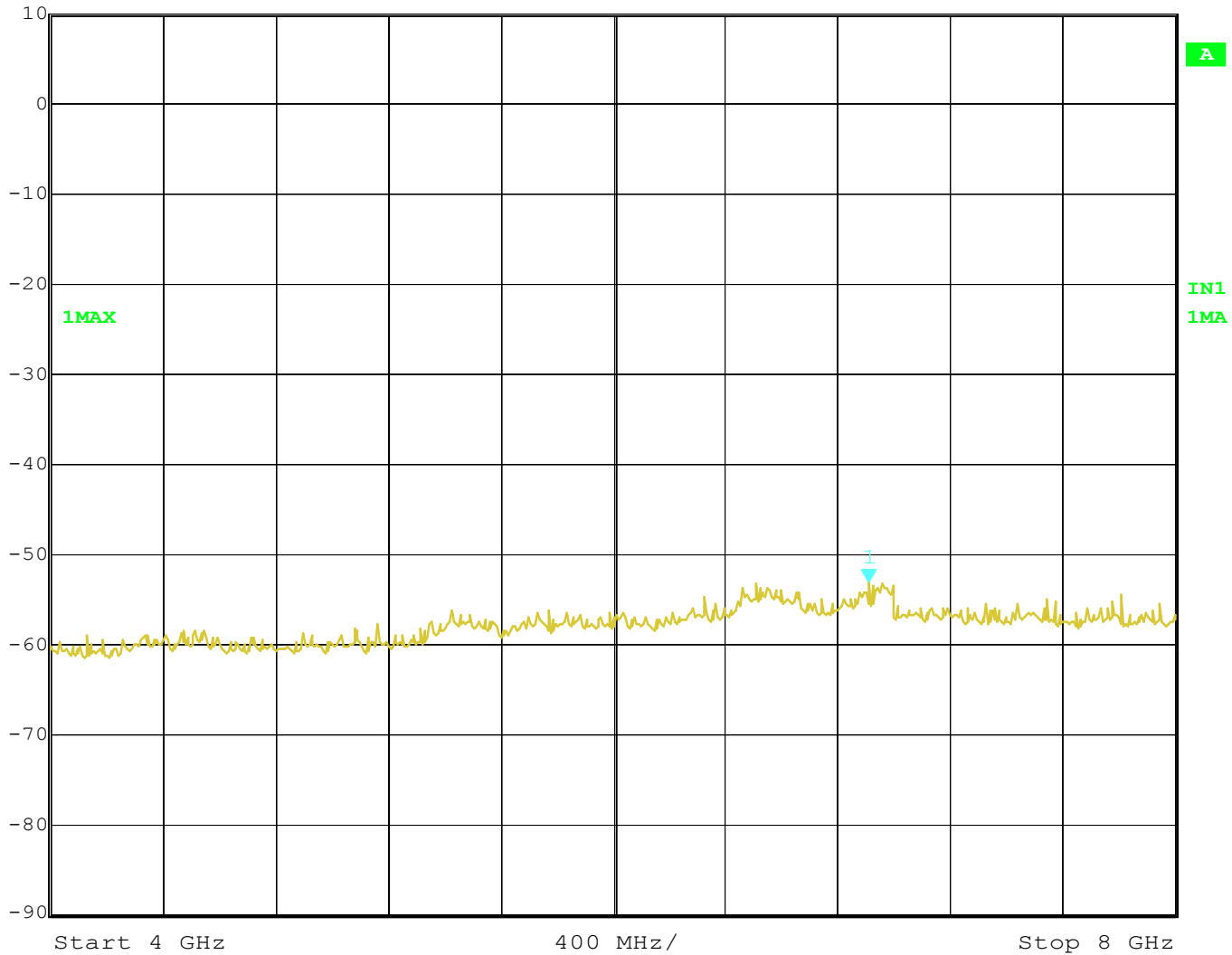

Title: 615MHz
Date: 10.JUN.2004 10:32:21



Marker 1 [T1] RBW 100 kHz RF Att 30 dB
Ref Lvl -53.85 dBm VBW 100 kHz
10 dBm 11.63927856 GHz SWT 1 s Unit dBm

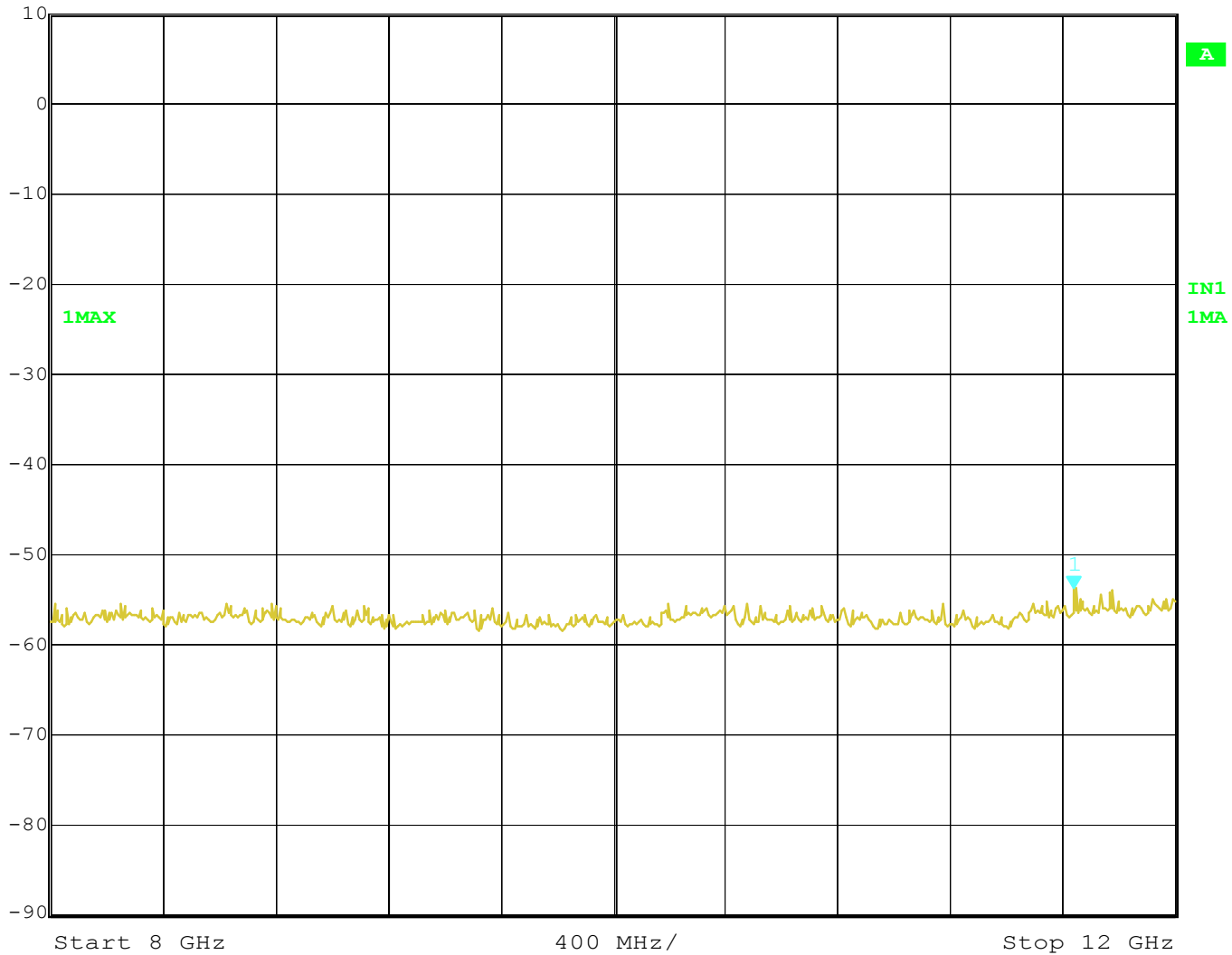

Title: 615MHz
Date: 10.JUN.2004 10:51:36



Marker 1 [T1] RBW 100 kHz RF Att 30 dB
Ref Lvl -17.11 dBm VBW 100 kHz
10 dBm 710.82164329 MHz SWT 300 ms Unit dBm

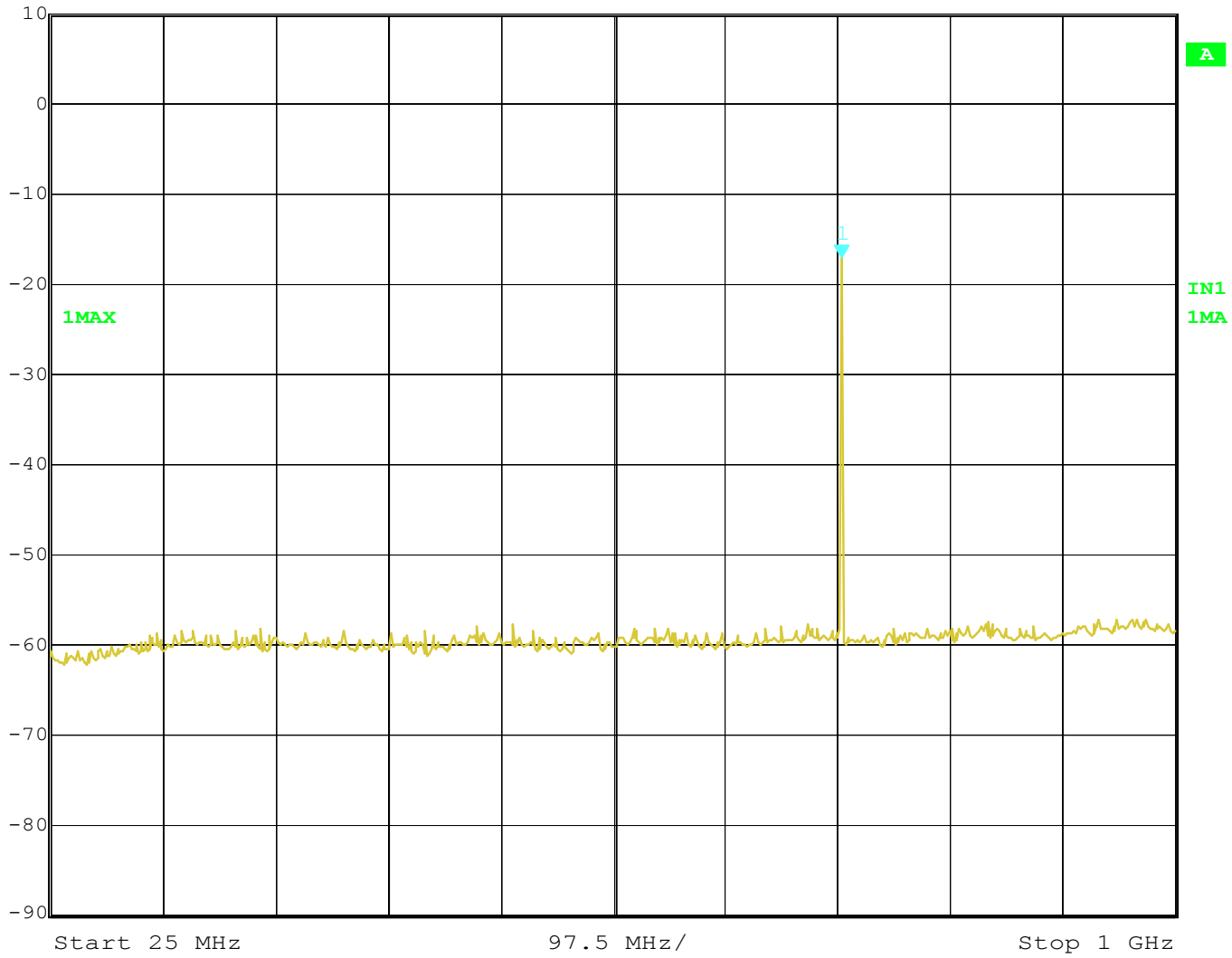

Title: 710MHz
Date: 10.JUN.2004 10:46:08



Marker 1 [T1] RBW 100 kHz RF Att 30 dB
Ref Lvl -54.46 dBm VBW 100 kHz
10 dBm 2.65330661 GHz SWT 1 s Unit dBm

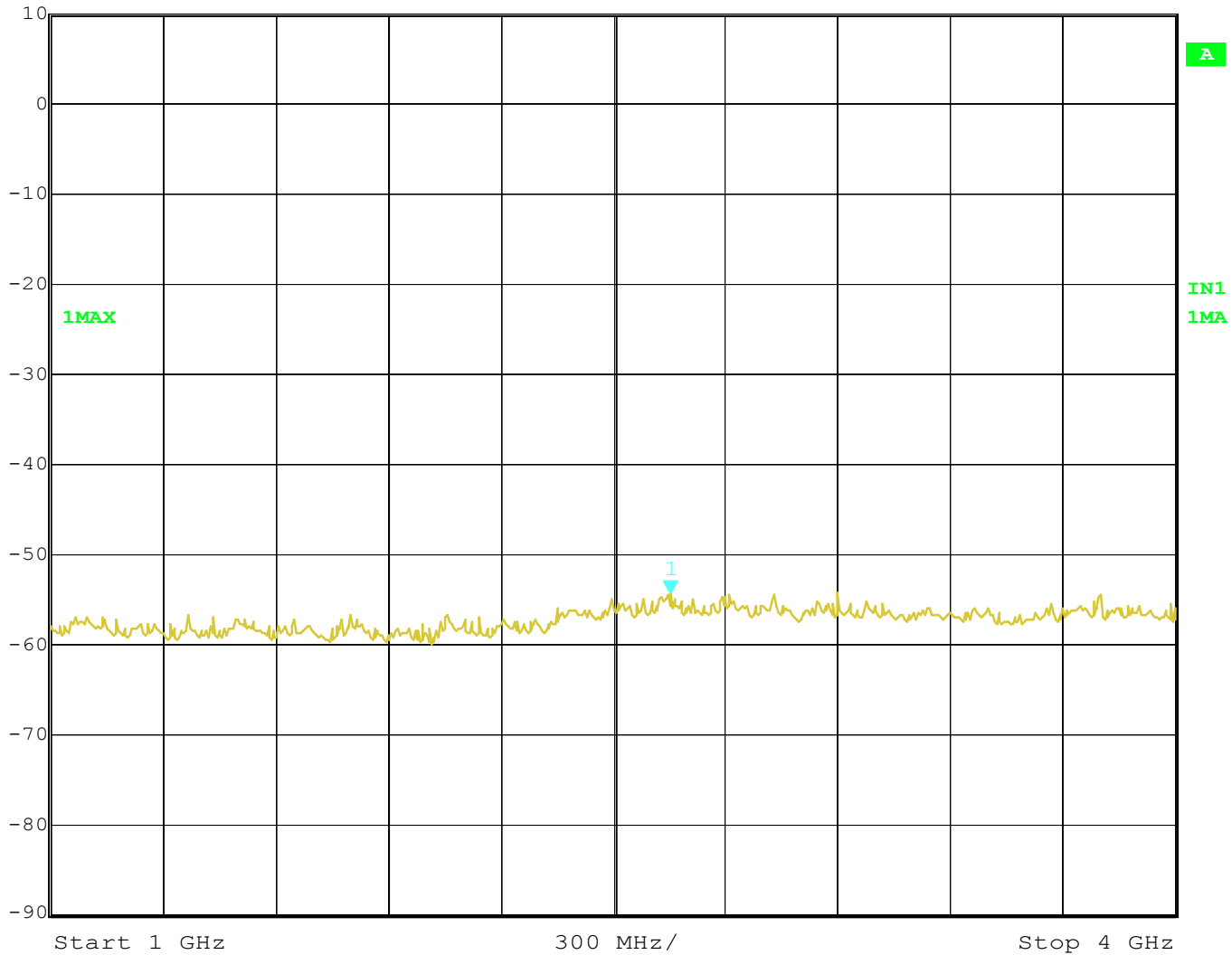

Title: 710MHz
Date: 10.JUN.2004 10:46:54



Marker 1 [T1] RBW 100 kHz RF Att 30 dB
Ref Lvl -52.58 dBm VBW 100 kHz
10 dBm 6.98997996 GHz SWT 1 s Unit dBm

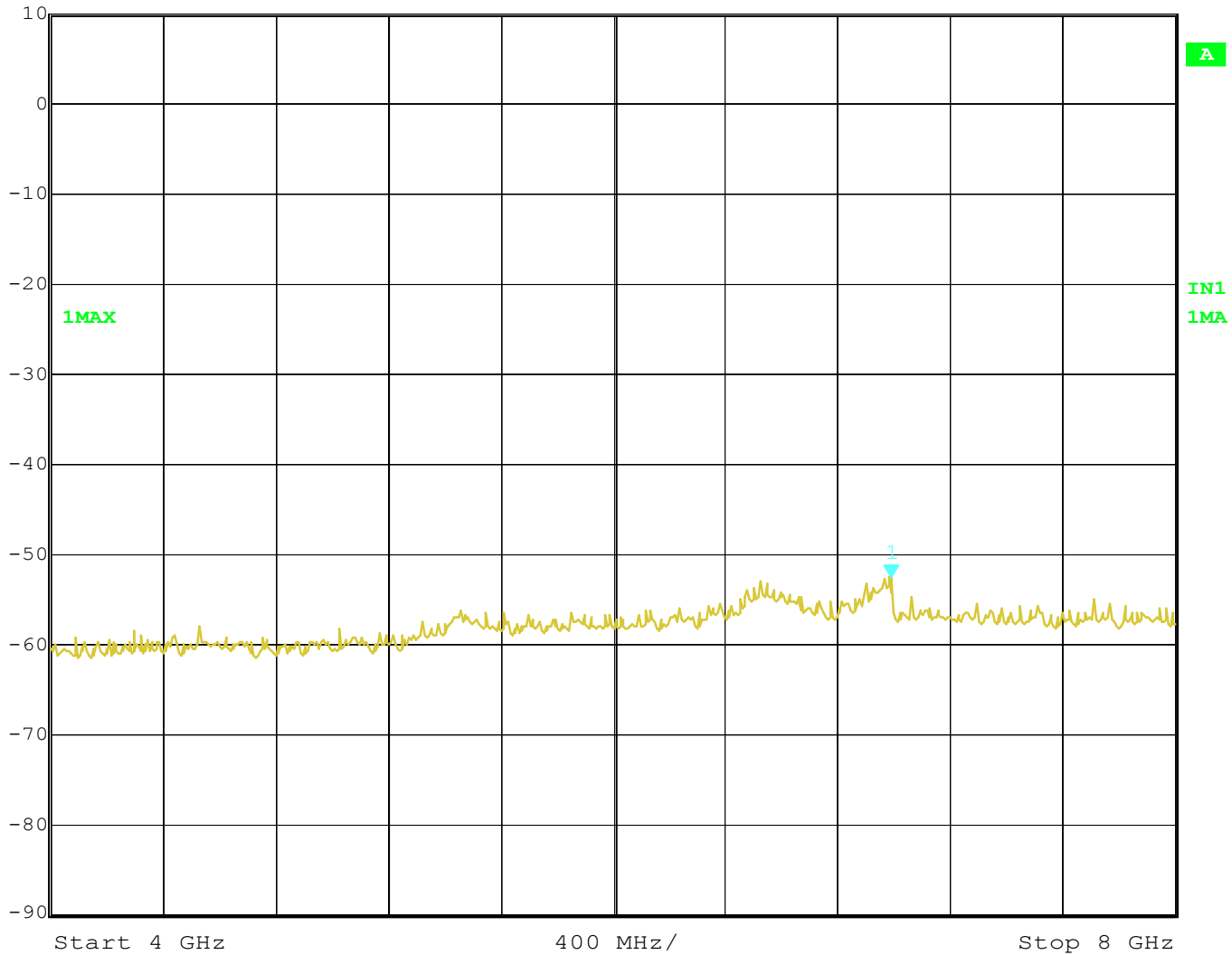

Title: 710MHz
Date: 10.JUN.2004 10:47:24



Marker 1 [T1] RBW 100 kHz RF Att 30 dB
Ref Lvl -54.60 dBm VBW 100 kHz
10 dBm 11.67935872 GHz SWT 1 s Unit dBm

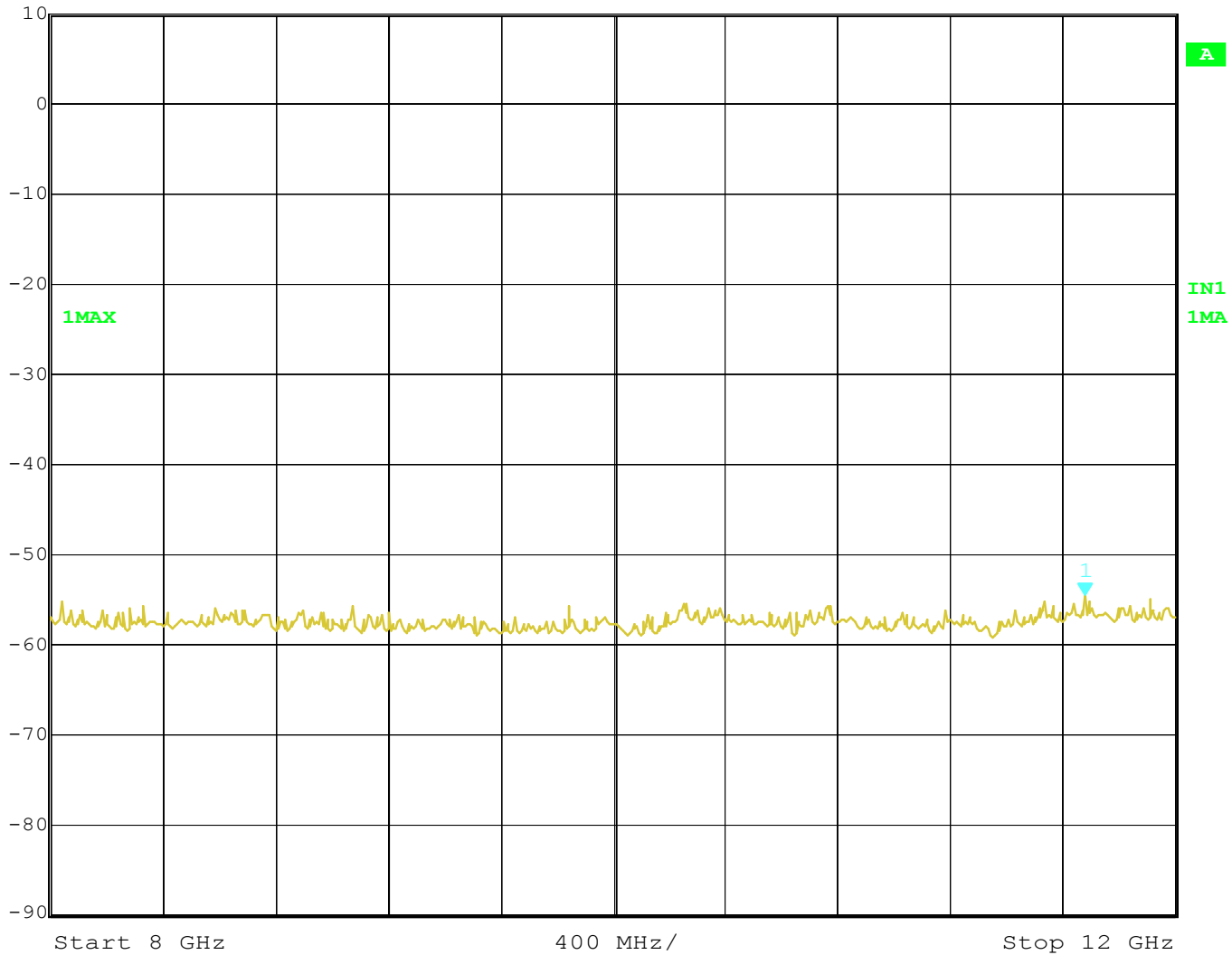

Title: 710MHz
Date: 10.JUN.2004 10:47:54



Marker 1 [T1] RBW 100 kHz RF Att 30 dB
Ref Lvl -23.35 dBm VBW 100 kHz
10 dBm 804.60921844 MHz SWT 300 ms Unit dBm

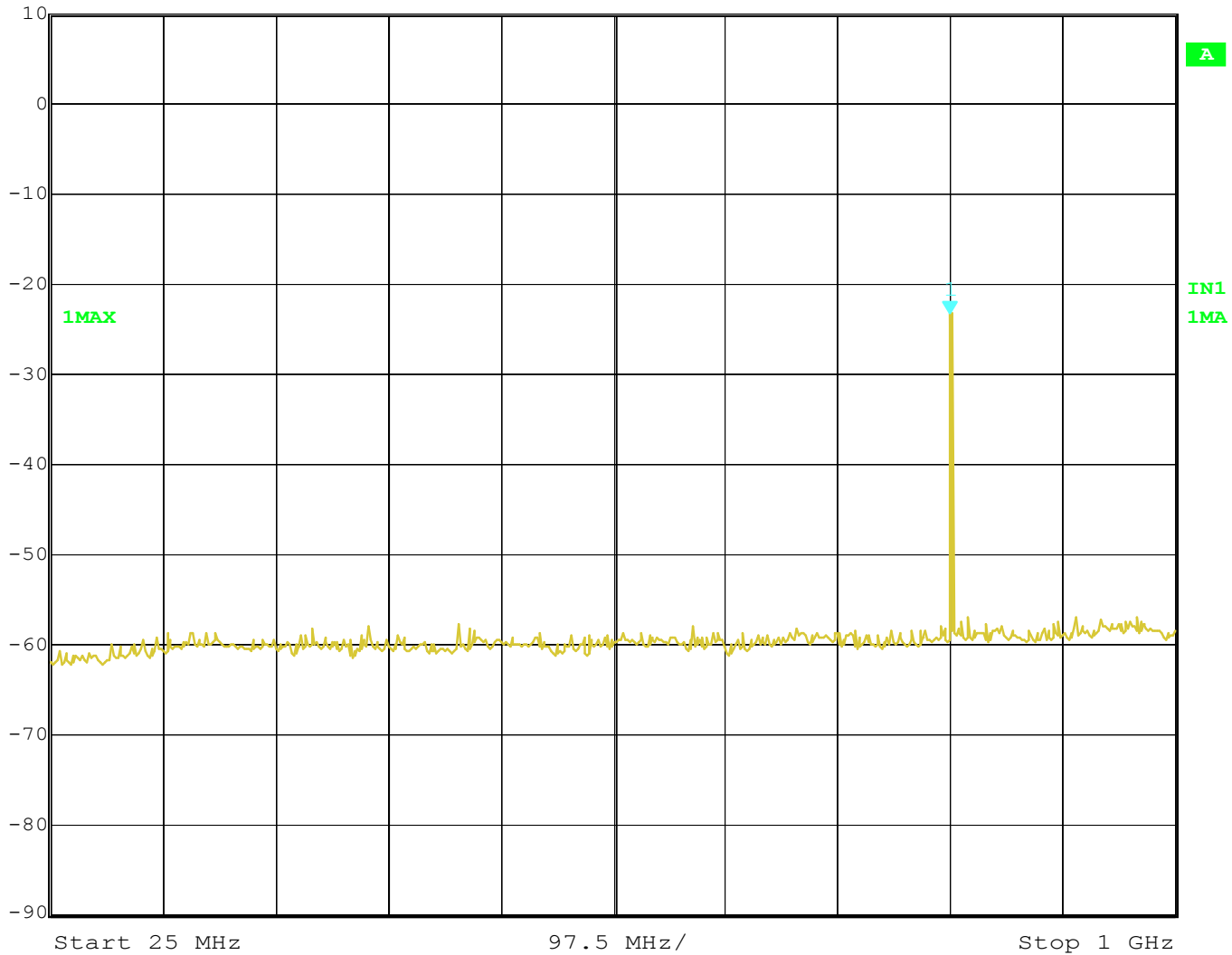

Title: 804.975MHz
Date: 10.JUN.2004 10:57:46



Marker 1 [T1] RBW 100 kHz RF Att 30 dB
Ref Lvl -54.24 dBm VBW 100 kHz
10 dBm 2.52104208 GHz SWT 1 s Unit dBm

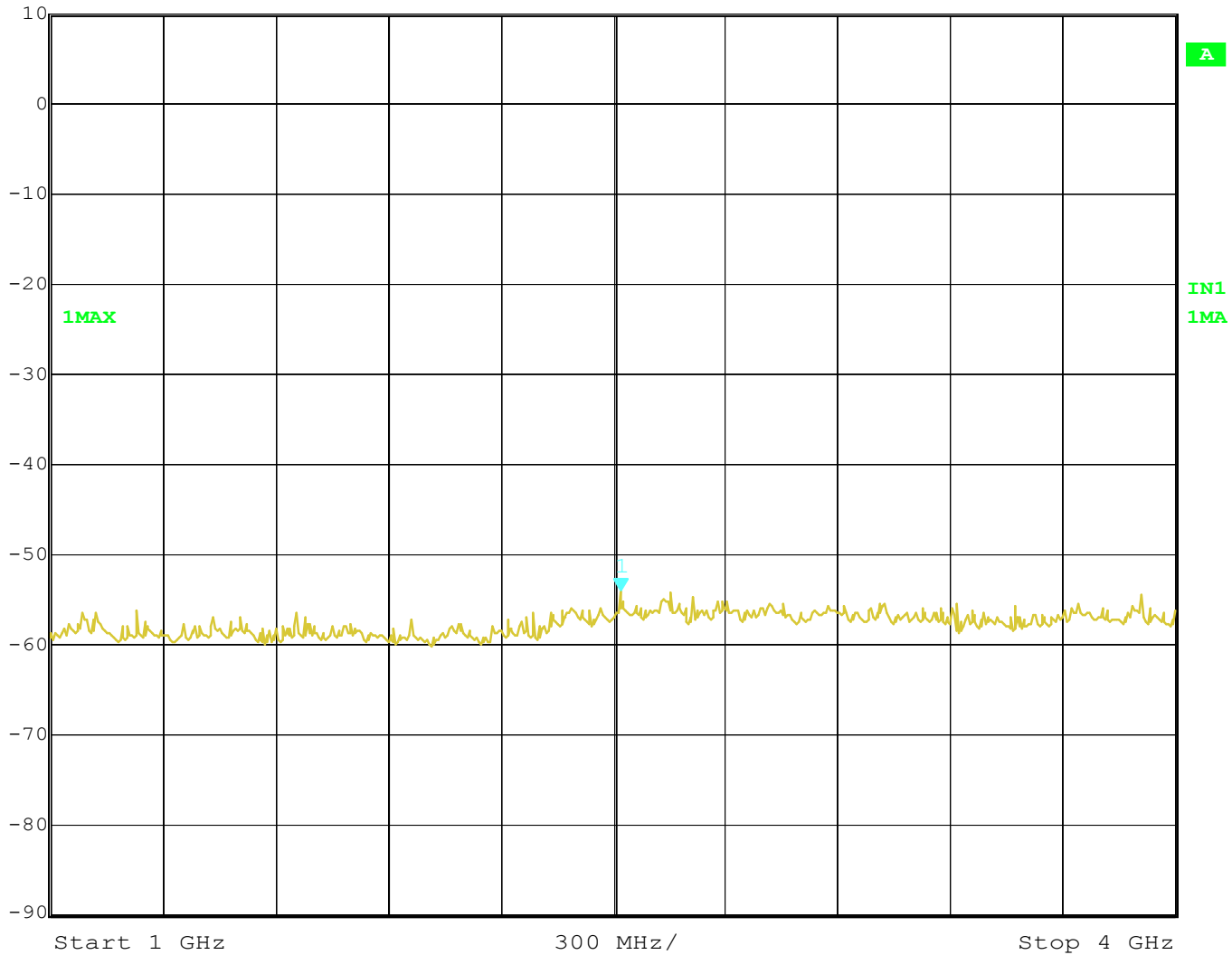

Title: 804.975MHz
Date: 10.JUN.2004 10:55:50



Marker 1 [T1] RBW 100 kHz RF Att 30 dB
Ref Lvl -52.96 dBm VBW 100 kHz
10 dBm 6.97394790 GHz SWT 1 s Unit dBm

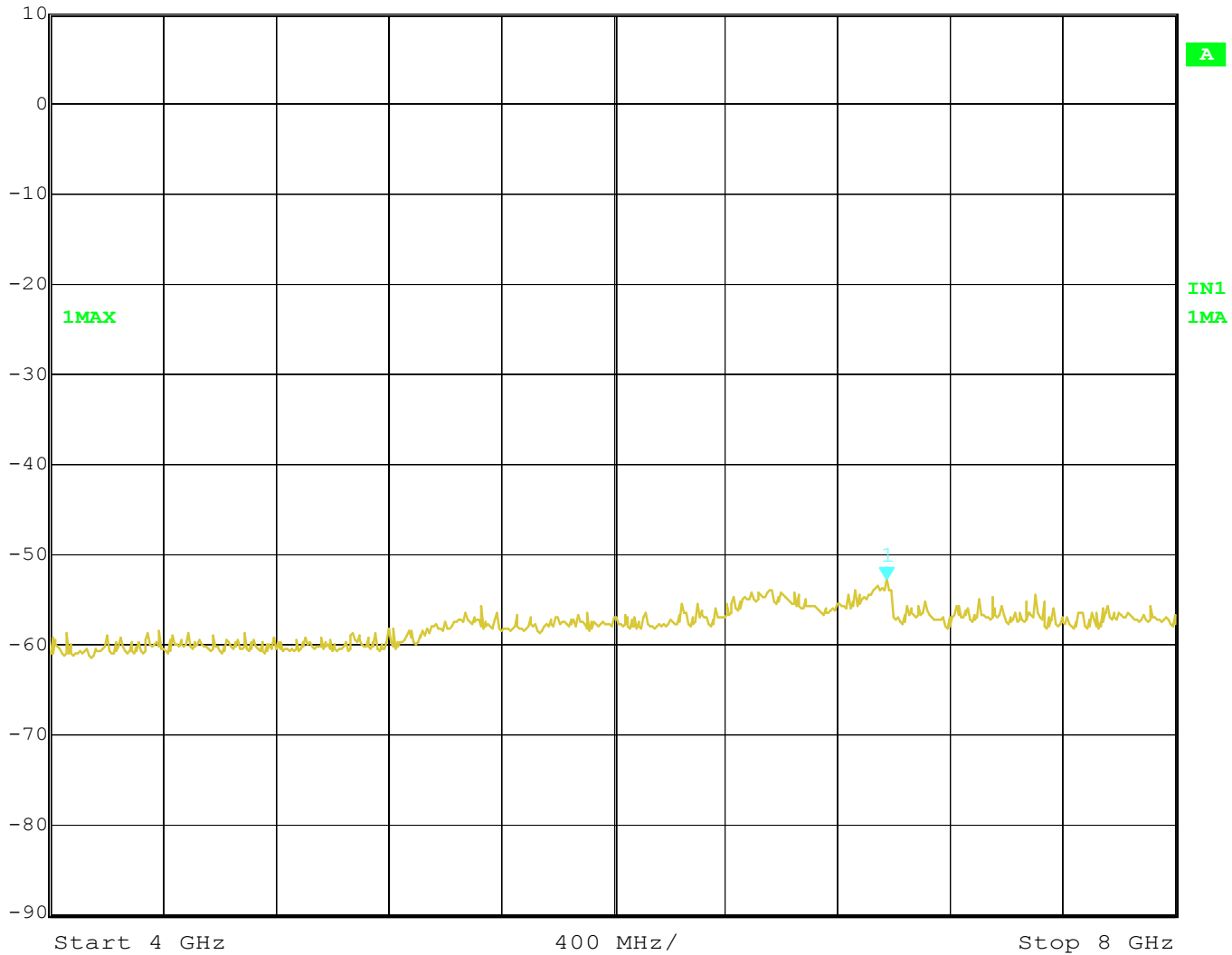

Title: 804.975MHz
Date: 10.JUN.2004 10:55:14



Marker 1 [T1] RBW 100 kHz RF Att 30 dB
Ref Lvl -53.96 dBm VBW 100 kHz
10 dBm 11.62324649 GHz SWT 1 s Unit dBm

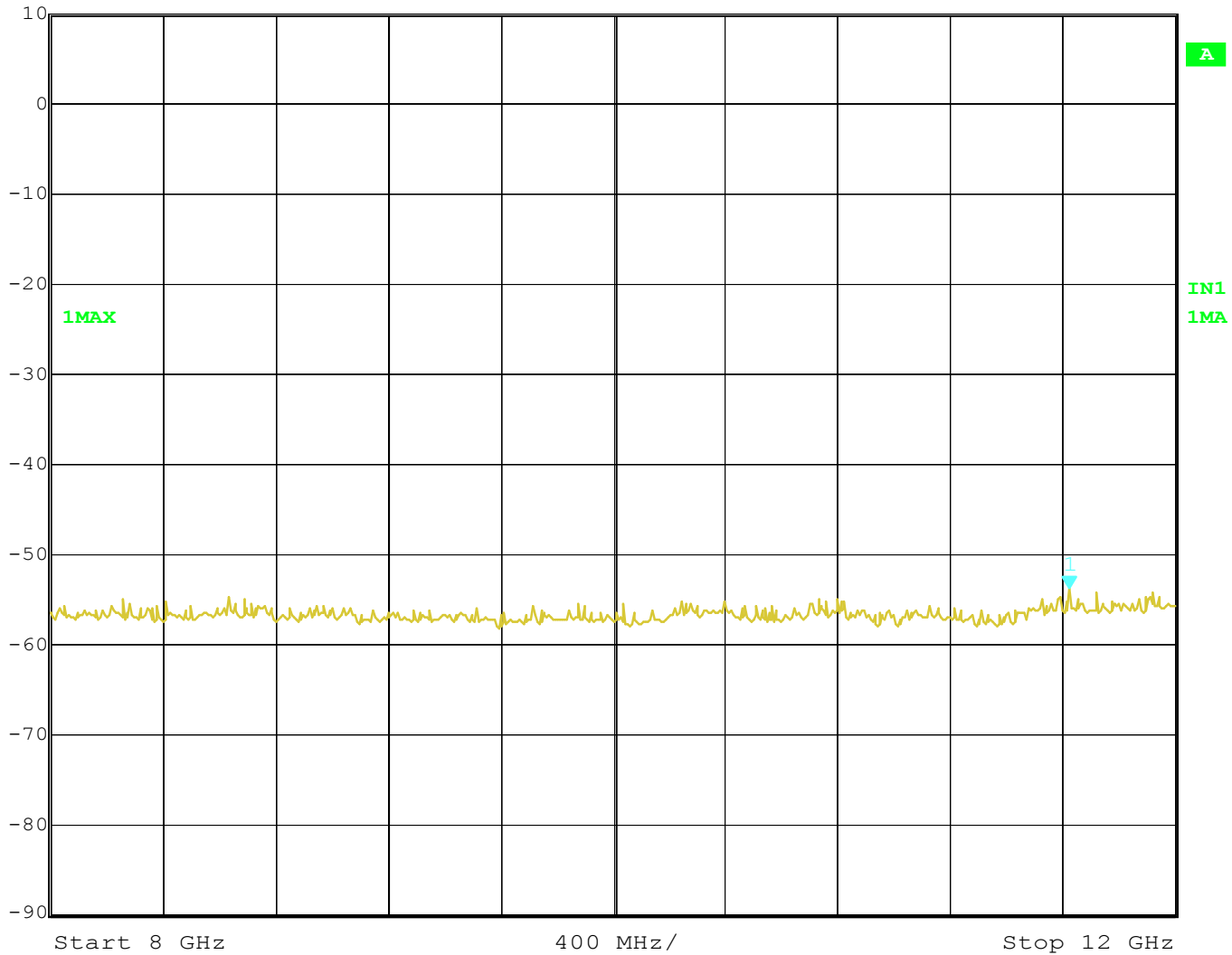

Title: 804.975MHz
Date: 10.JUN.2004 10:54:44



Registration number: W6M20405-5191-C-1
FCC ID: CINUH-2000

Appendix E

Radiation Spurious Emission

Spurious emissions under normal conditions

in according to FCC Part 74.861

EUT: Wireless Microphone Transmitter
MODEL NO.: UH-2000 Low channel
Approval Holder: CHIAYO ELECTRONICS CO.,LTD
Test Site / Operator: ETS / PIERCE PENG
Temperature/Voltage: Temp.: 23°C/ Unom.: 3 VDC (1.5 x 2 Battery)
Test Specification: 74.861
Comment 1: Dist.: 3m, Ant.: HK 116
Freq:106.713MHz Pmax:-52.39dBm RBW: 100 kHz

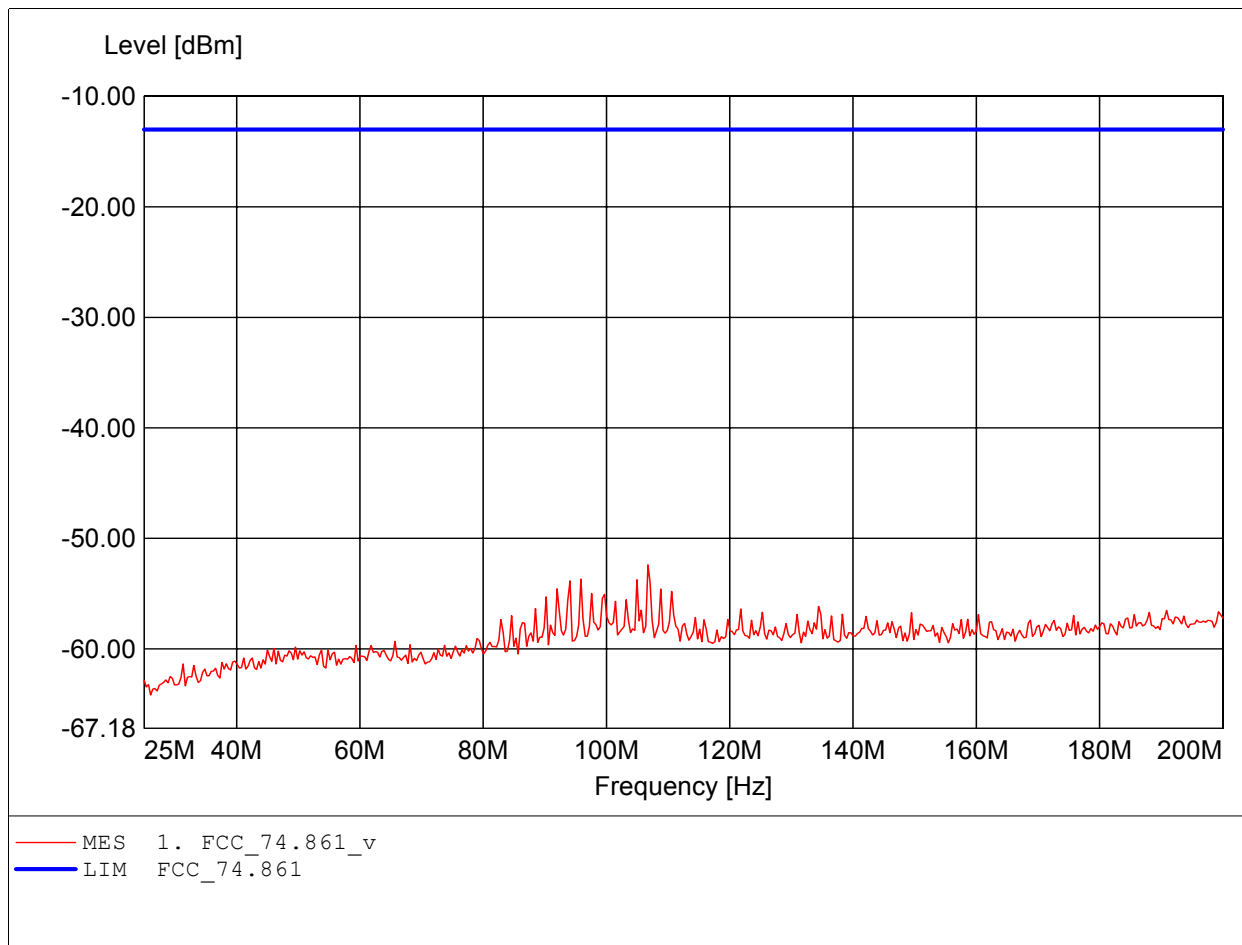

Spurious emissions under normal conditions

in according to FCC Part 74.861

EUT: Wireless Microphone Transmitter
MODEL NO.: UH-2000 Low channel
Approval Holder: CHIAYO ELECTRONICS CO.,LTD
Test Site / Operator: ETS / PIERCE PENG
Temperature/Voltage: Temp.: 23°C/ Unom.: 3 VDC (1.5 x 2 Battery)
Test Specification: 74.861
Comment 1: Dist.: 3m, Ant.: HK 116
Freq:198.597MHz Pmax:-56.85dBm RBW: 100 kHz

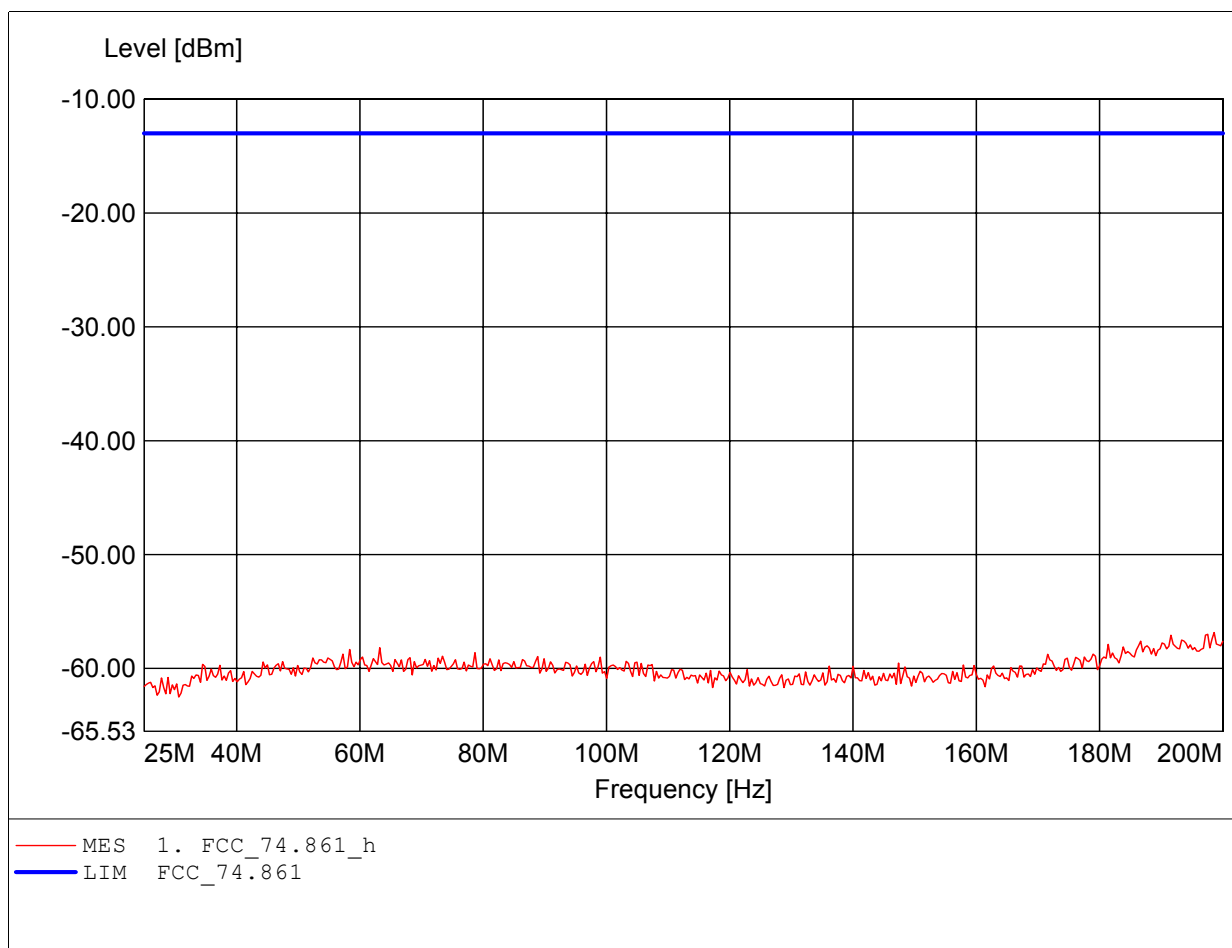

Spurious emissions under normal conditions

in according to FCC Part 74.861

EUT: Wireless Microphone Transmitter
MODEL NO.: UH-2000 Low channel
Approval Holder: CHIAYO ELECTRONICS CO.,LTD
Test Site / Operator: ETS / PIERCE PENG
Temperature/Voltage: Temp.: 23°C/ Unom.: 3 VDC (1.5 x 2 Battery)
Test Specification: 74.861
Comment 1: Dist.: 3m, Ant.: HL 223, ampl.: 0.1-1GHz
Freq:615.230MHz Pmax:-65.23dBm RBW: 100 kHz

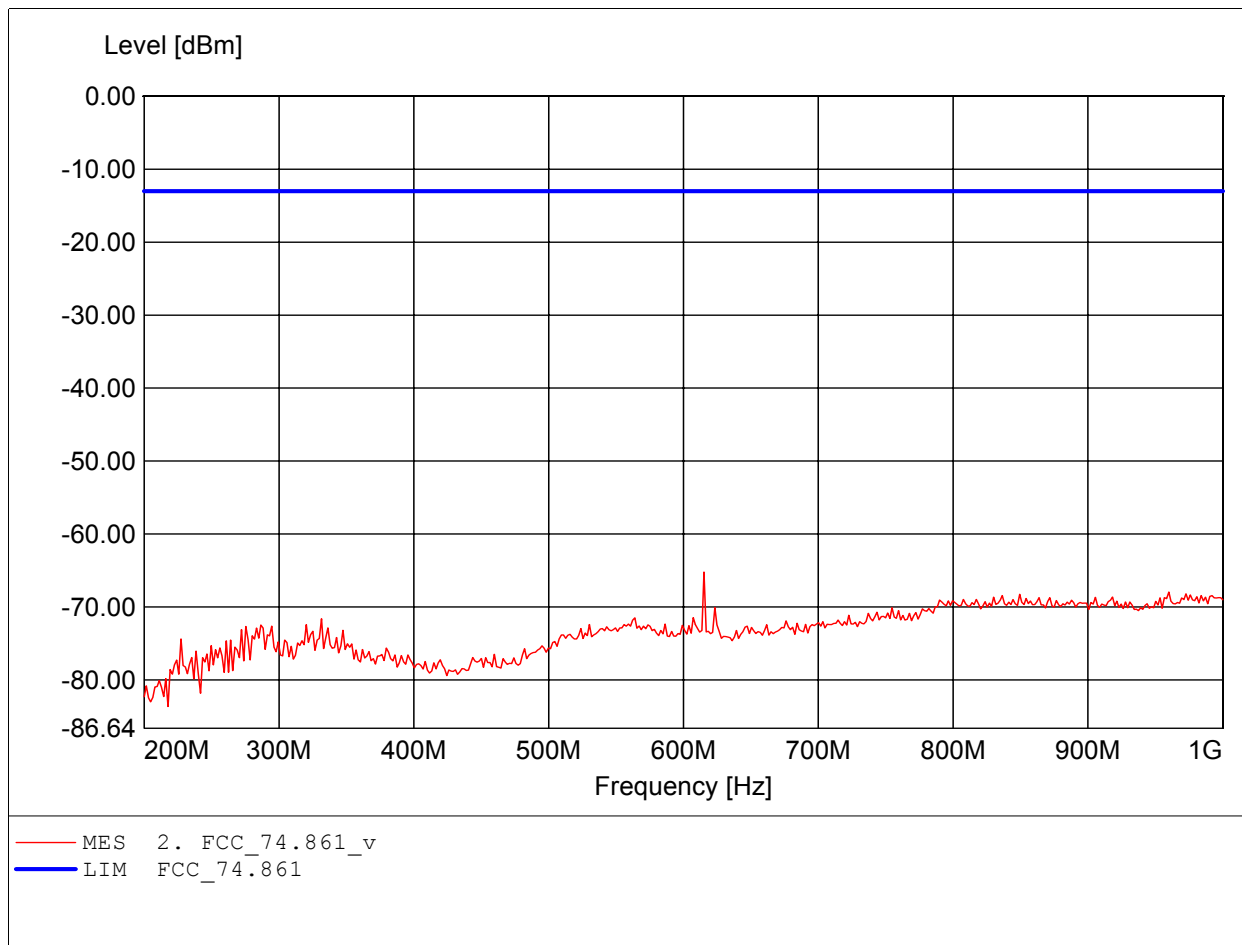

Spurious emissions under normal conditions

in according to FCC Part 74.861

EUT: Wireless Microphone Transmitter
MODEL NO.: UH-2000 Low channel
Approval Holder: CHIAYO ELECTRONICS CO.,LTD
Test Site / Operator: ETS / PIERCE PENG
Temperature/Voltage: Temp.: 23°C/ Unom.: 3 VDC (1.5 x 2 Battery)
Test Specification: 74.861
Comment 1: Dist.: 3m, Ant.: HL 223, ampl.: 0.1-1GHz
Freq:959.920MHz Pmax:-67.36dBm RBW: 100 kHz

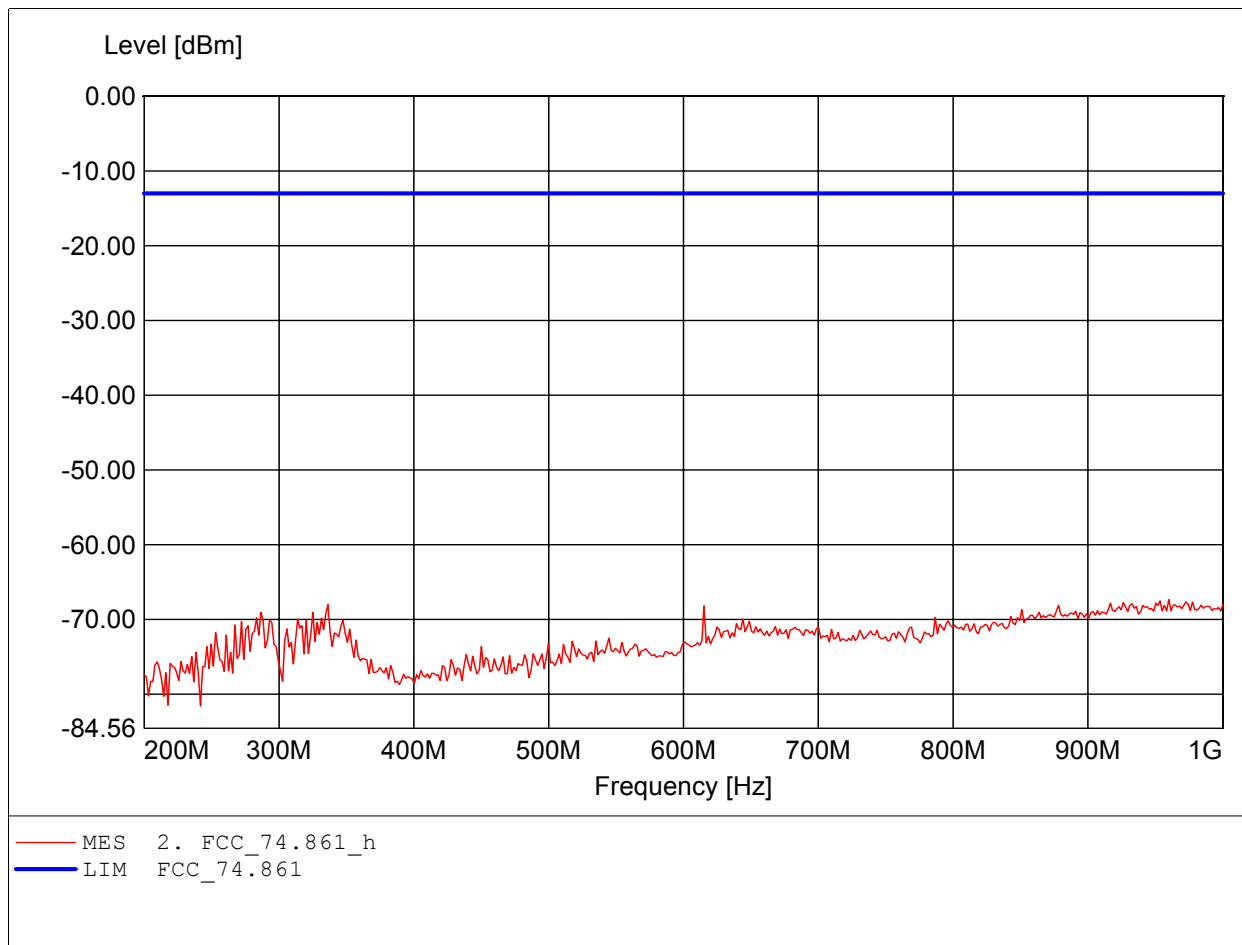

Spurious emissions under normal conditions

in according to FCC Part 74.861

EUT: Wireless Microphone Transmitter
MODEL NO.: UH-2000 Low channel
Approval Holder: CHIAYO ELECTRONICS CO.,LTD
Test Site / Operator: ETS / PIERCE PENG
Temperature/Voltage: Temp.: 23°C/ Unom.: 3 VDC (1.5 x 2 Battery)
Test Specification: 74.861
Comment 1: Dist.: 3m, Ant.: HL 025, ampl.: 1-4GHz
Freq:1.228GHz Pmax:-46.65dBm RBW: 1 MHz

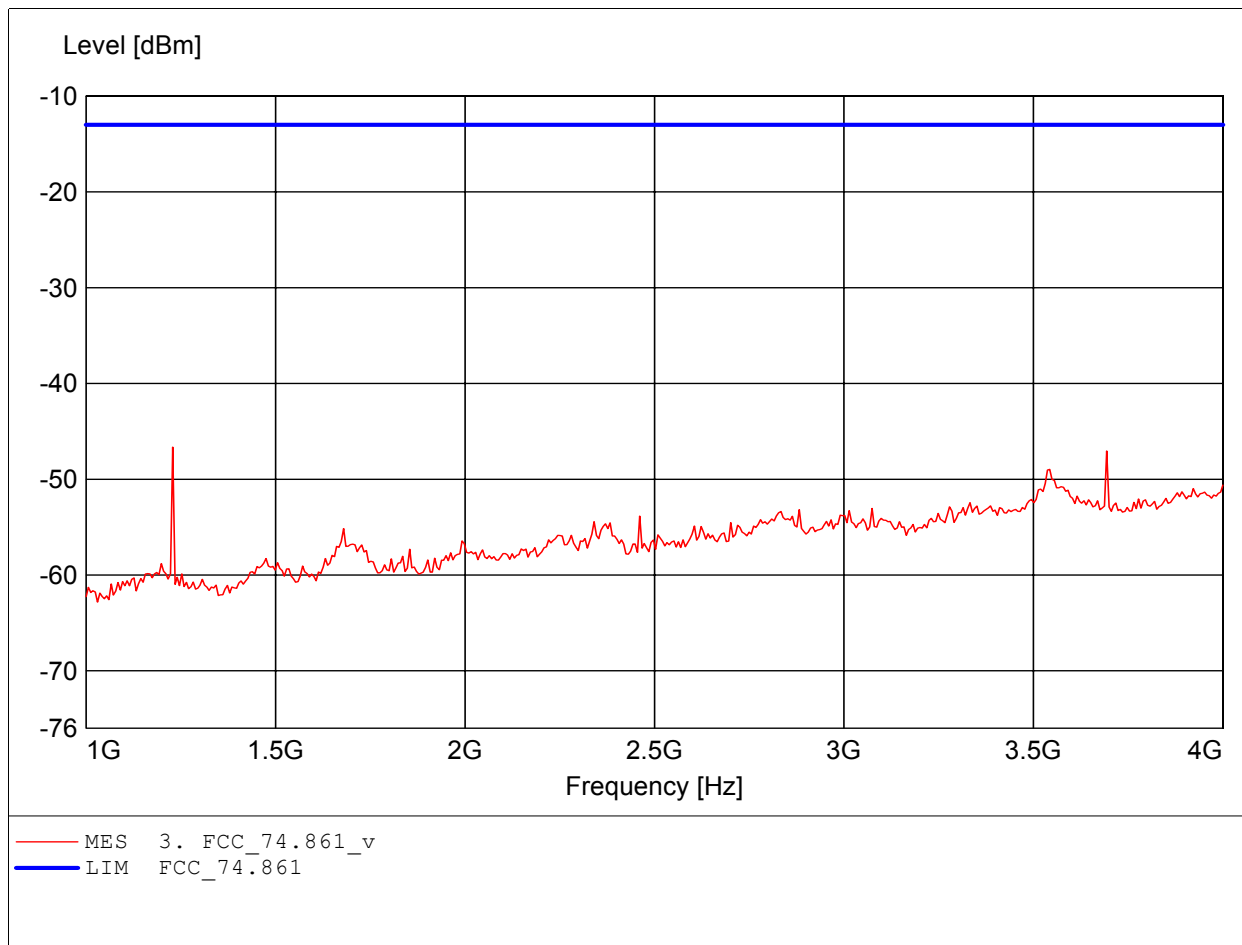

Spurious emissions under normal conditions

in according to FCC Part 74.861

EUT: Wireless Microphone Transmitter
MODEL NO.: UH-2000 Low channel
Approval Holder: CHIAYO ELECTRONICS CO.,LTD
Test Site / Operator: ETS / PIERCE PENG
Temperature/Voltage: Temp.: 23°C/ Unom.: 3 VDC (1.5 x 2 Battery)
Test Specification: 74.861
Comment 1: Dist.: 3m, Ant.: HL 025, ampl.: 1-4GHz
Freq:3.693GHz Pmax:-38.36dBm RBW: 1 MHz

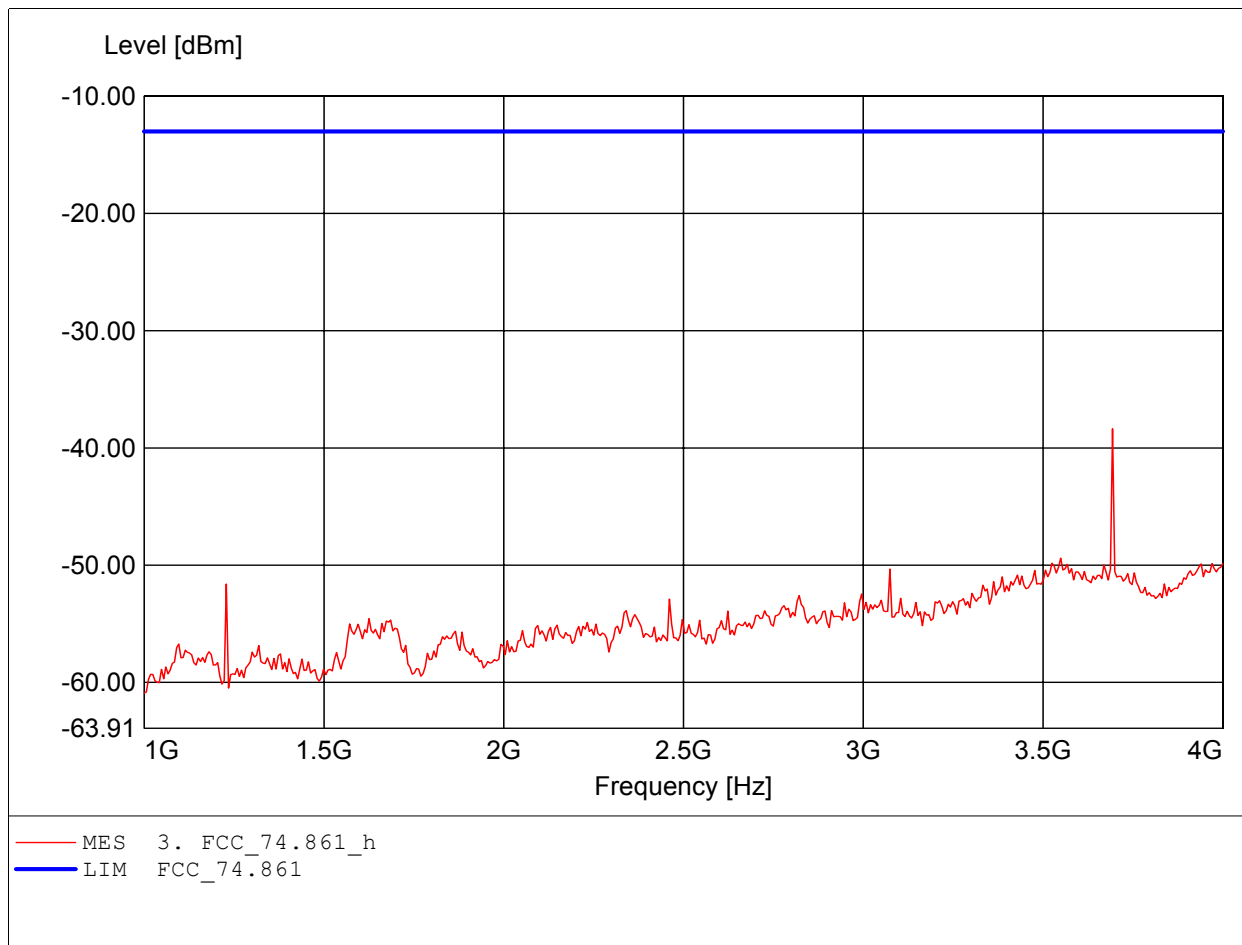

Spurious emissions under normal conditions

in according to FCC Part 74.861

EUT: Wireless Microphone Transmitter
MODEL NO.: UH-2000 Low channel
Approval Holder: CHIAYO ELECTRONICS CO.,LTD
Test Site / Operator: ETS / PIERCE PENG
Temperature/Voltage: Temp.: 23°C/ Unom.: 3 VDC (1.5 x 2 Battery)
Test Specification: 74.861
Comment 1: Dist.: 1m, Ant.: HL 025, ampl.: 4-8GHz
Freq:8.000GHz Pmax:-52.73dBm RBW: 1 MHz

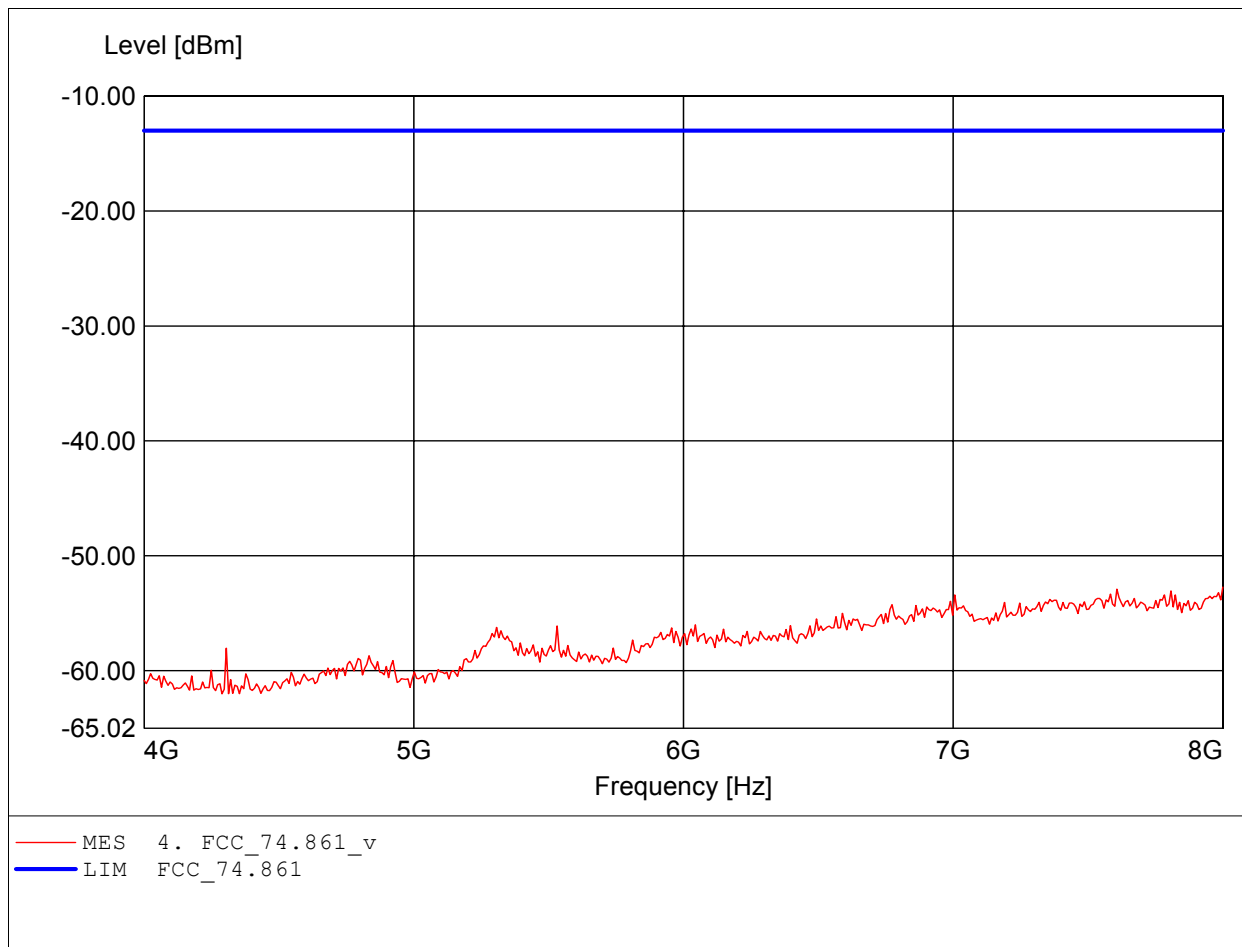

Spurious emissions under normal conditions

in according to FCC Part 74.861

EUT: Wireless Microphone Transmitter
MODEL NO.: UH-2000 Low channel
Approval Holder: CHIAYO ELECTRONICS CO.,LTD
Test Site / Operator: ETS / PIERCE PENG
Temperature/Voltage: Temp.: 23°C/ Unom.: 3 VDC (1.5 x 2 Battery)
Test Specification: 74.861
Comment 1: Dist.: 1m, Ant.: HL 025, ampl.: 4-8GHz
Freq:5.531GHz Pmax:-50.14dBm RBW: 1 MHz

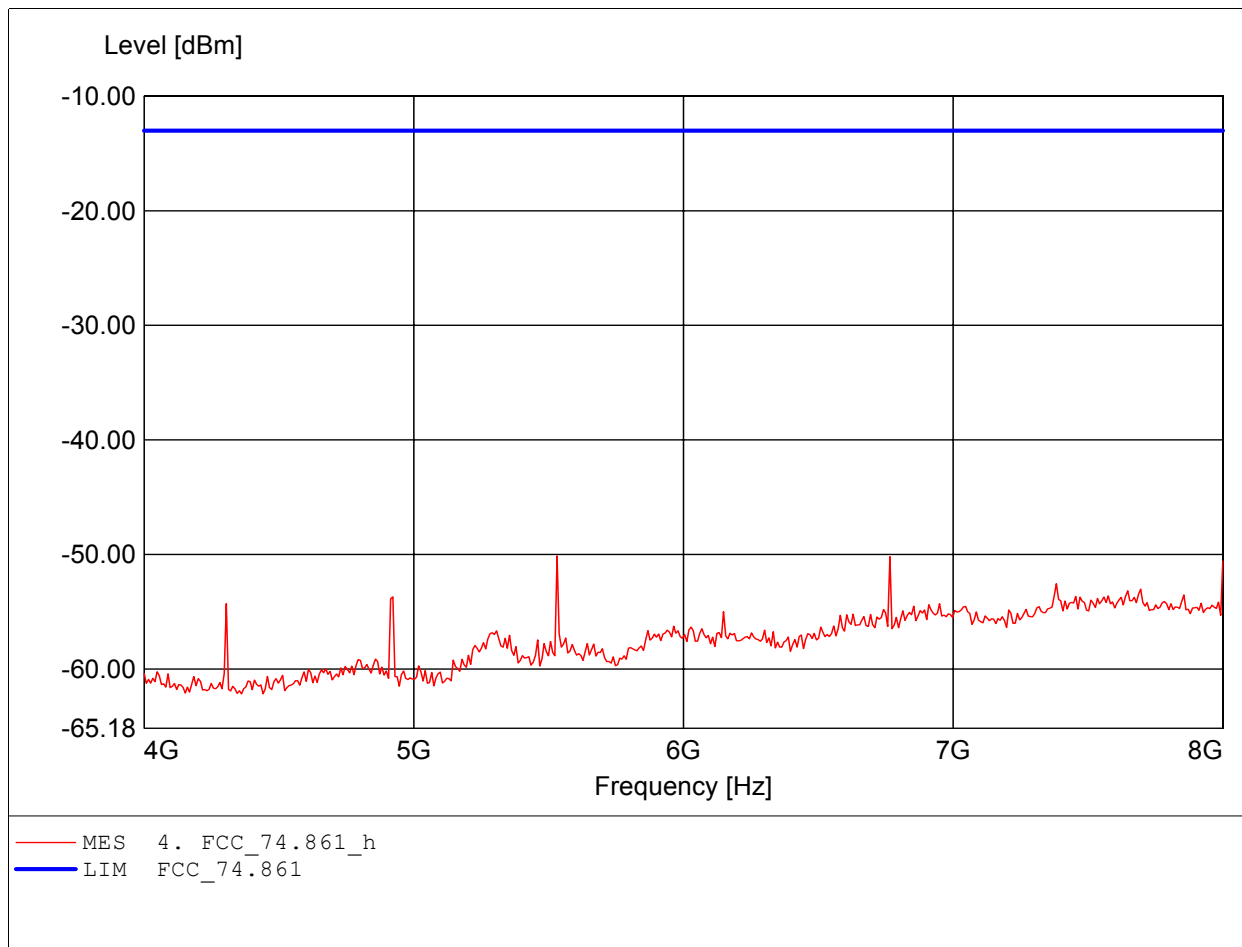

Spurious emissions under normal conditions

in according to FCC Part 74.861

EUT: Wireless Microphone Transmitter
MODEL NO.: UH-2000 Low channel
Approval Holder: CHIAYO ELECTRONICS CO.,LTD
Test Site / Operator: ETS / PIERCE PENG
Temperature/Voltage: Temp.: 23°C/ Unom.: 3 VDC (1.5 x 2 Battery)
Test Specification: 74.861
Comment 1: Dist.: 1m, Ant.: HL 025, ampl.: 8-18GHz
Freq:12.509GHz Pmax:-43.41dBm RBW: 1 MHz

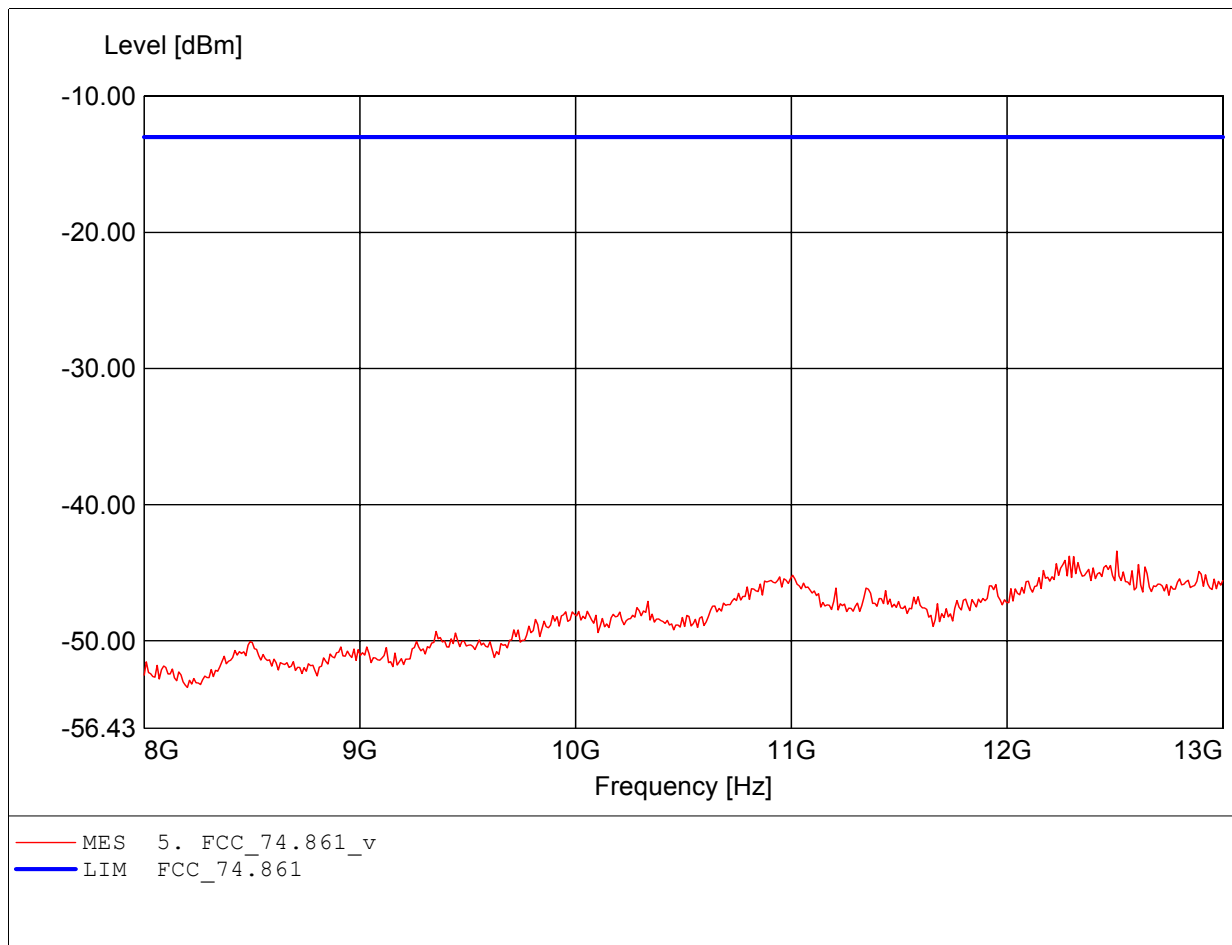

Spurious emissions under normal conditions

in according to FCC Part 74.861

EUT: Wireless Microphone Transmitter
MODEL NO.: UH-2000 Low channel
Approval Holder: CHIAYO ELECTRONICS CO.,LTD
Test Site / Operator: ETS / PIERCE PENG
Temperature/Voltage: Temp.: 23°C/ Unom.: 3 VDC (1.5 x 2 Battery)
Test Specification: 74.861
Comment 1: Dist.: 1m, Ant.: HL 025, ampl.: 8-18GHz
Freq:12.469GHz Pmax:-44.63dBm RBW: 1 MHz

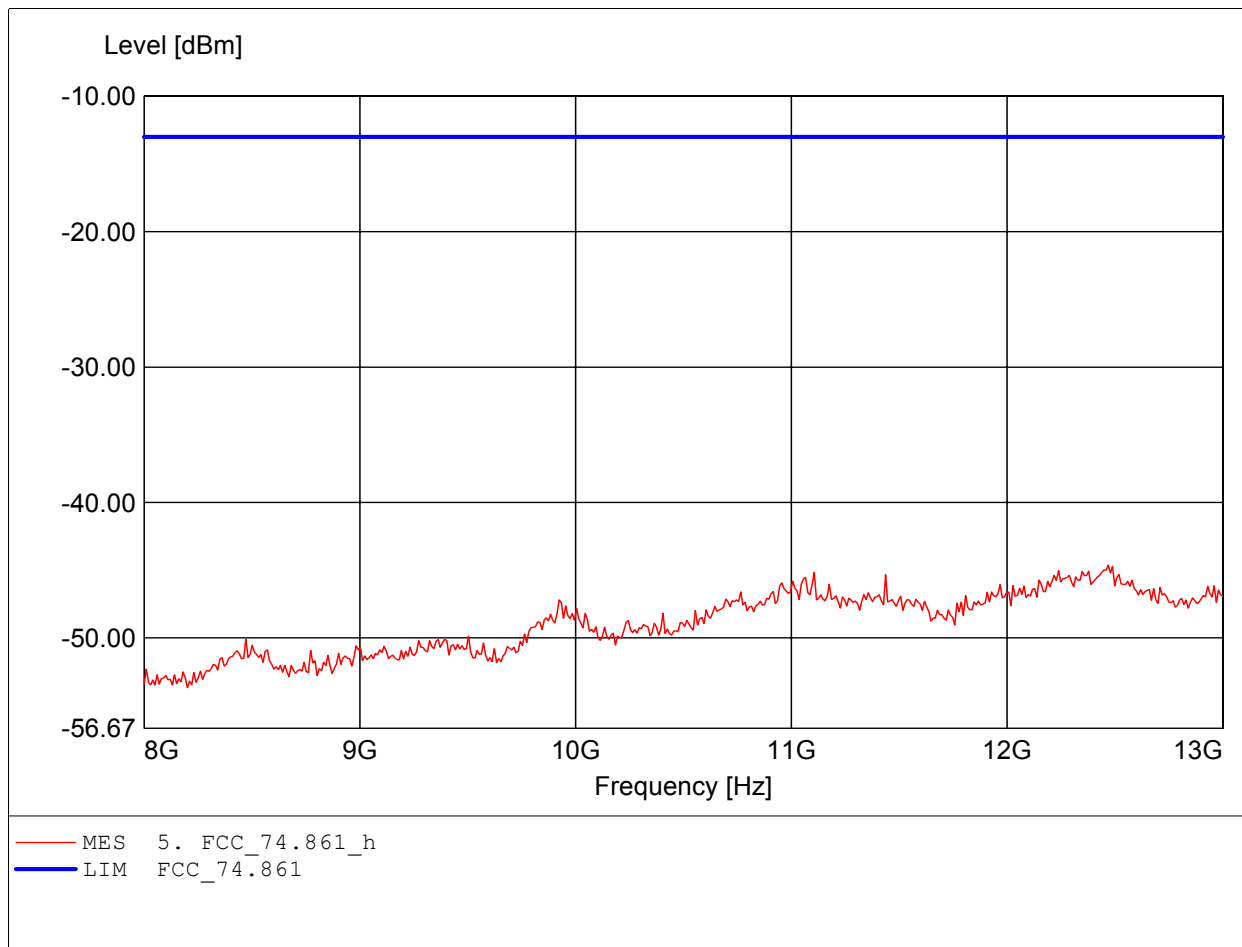

Spurious emissions under normal conditions

in according to FCC Part 74.861

EUT: Wireless Microphone Transmitter
MODEL NO.: UH-2000 Middle channel
Approval Holder: CHIAYO ELECTRONICS CO.,LTD
Test Site / Operator: ETS / PIERCE PENG
Temperature/Voltage: Temp.: 23°C/ Unom.: 3 VDC (1.5 x 2 Battery)
Test Specification: 74.861
Comment 1: Dist.: 3m, Ant.: HK 116
Freq:104.960MHz Pmax:-52.43dBm RBW: 100 kHz

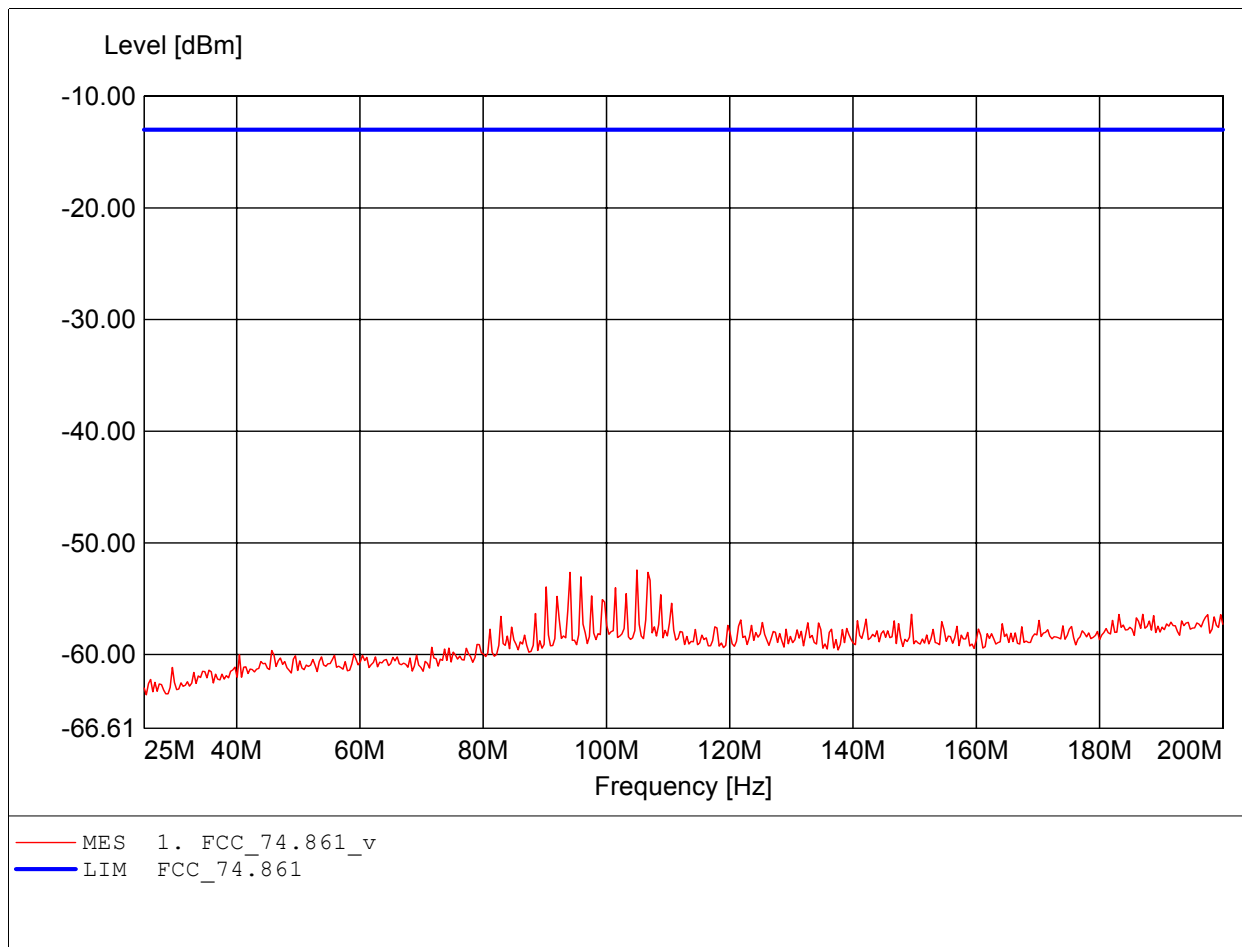

Spurious emissions under normal conditions

in according to FCC Part 74.861

EUT: Wireless Microphone Transmitter
MODEL NO.: UH-2000 Middle channel
Approval Holder: CHIAYO ELECTRONICS CO.,LTD
Test Site / Operator: ETS / PIERCE PENG
Temperature/Voltage: Temp.: 23°C/ Unom.: 3 VDC (1.5 x 2 Battery)
Test Specification: 74.861
Comment 1: Dist.: 3m, Ant.: HK 116
Freq:190.180MHz Pmax:-56.85dBm RBW: 100 kHz

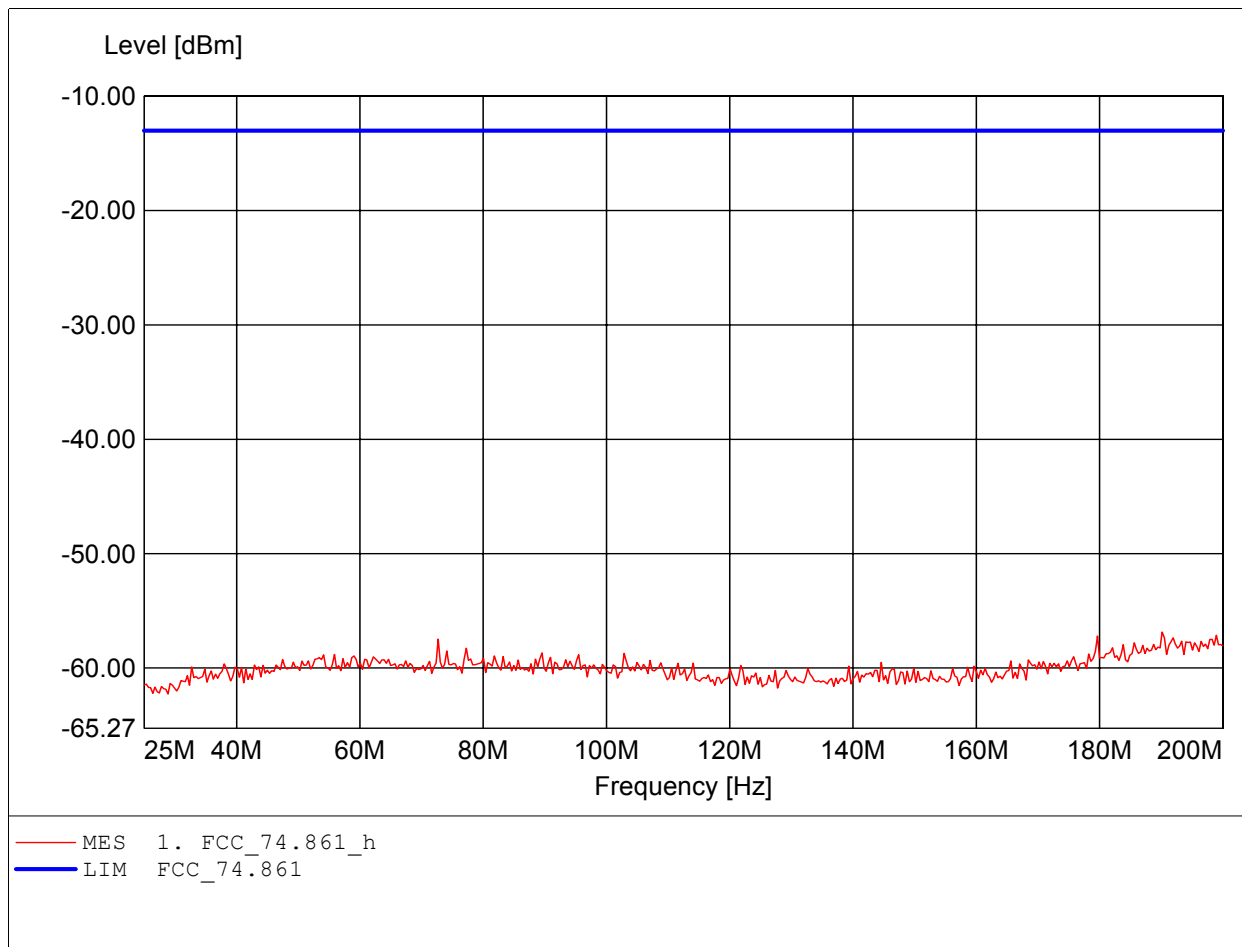

Spurious emissions under normal conditions

in according to FCC Part 74.861

EUT: Wireless Microphone Transmitter
MODEL NO.: UH-2000 Middle channel
Approval Holder: CHIAYO ELECTRONICS CO.,LTD
Test Site / Operator: ETS / PIERCE PENG
Temperature/Voltage: Temp.: 23°C/ Unom.: 3 VDC (1.5 x 2 Battery)
Test Specification: 74.861
Comment 1: Dist.: 3m, Ant.: HL 223, ampl.: 0.1-1GHz
Freq:709.820MHz Pmax:-60.82dBm RBW: 100 kHz

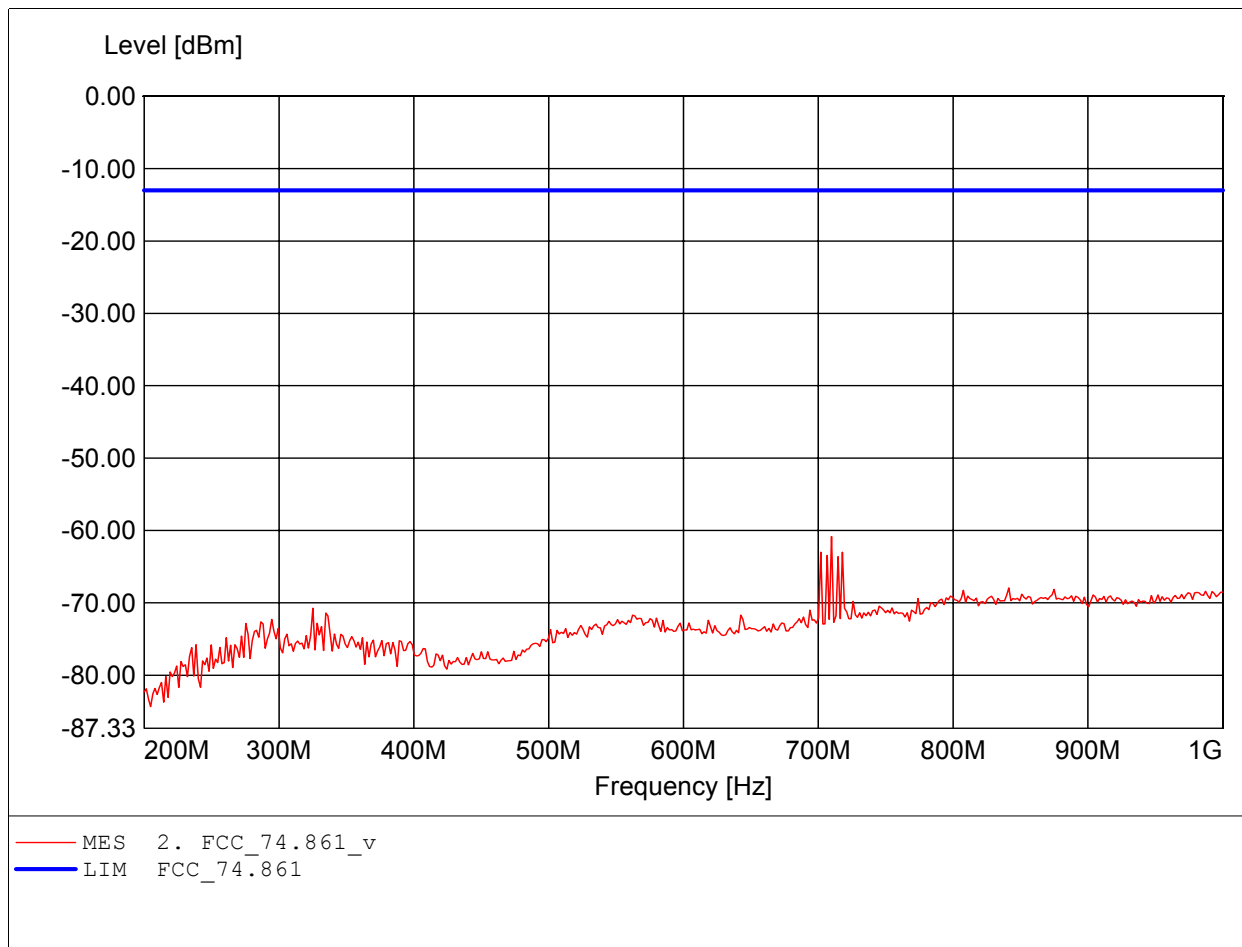

Spurious emissions under normal conditions

in according to FCC Part 74.861

EUT: Wireless Microphone Transmitter
MODEL NO.: UH-2000 Middle channel
Approval Holder: CHIAYO ELECTRONICS CO.,LTD
Test Site / Operator: ETS / PIERCE PENG
Temperature/Voltage: Temp.: 23°C/ Unom.: 3 VDC (1.5 x 2 Battery)
Test Specification: 74.861
Comment 1: Dist.: 3m, Ant.: HL 223, ampl.: 0.1-1GHz
Freq:982.365MHz Pmax:-67.21dBm RBW: 100 kHz

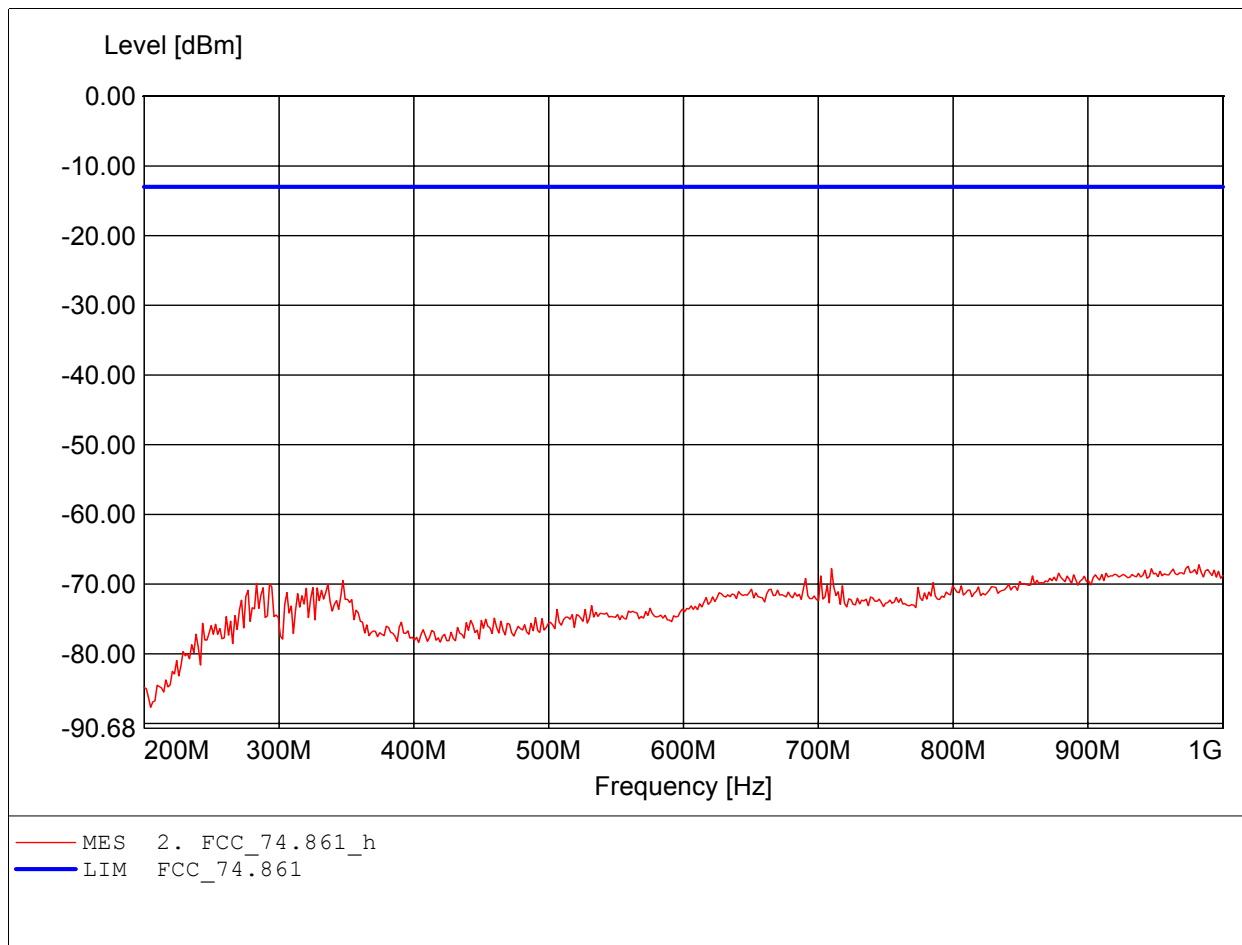

Spurious emissions under normal conditions

in according to FCC Part 74.861

EUT: Wireless Microphone Transmitter
MODEL NO.: UH-2000 Middle channel
Approval Holder: CHIAYO ELECTRONICS CO.,LTD
Test Site / Operator: ETS / PIERCE PENG
Temperature/Voltage: Temp.: 23°C/ Unom.: 3 VDC (1.5 x 2 Battery)
Test Specification: 74.861
Comment 1: Dist.: 3m, Ant.: HL 025, ampl.: 1-4GHz
Freq:3.555GHz Pmax:-44.81dBm RBW: 1 MHz

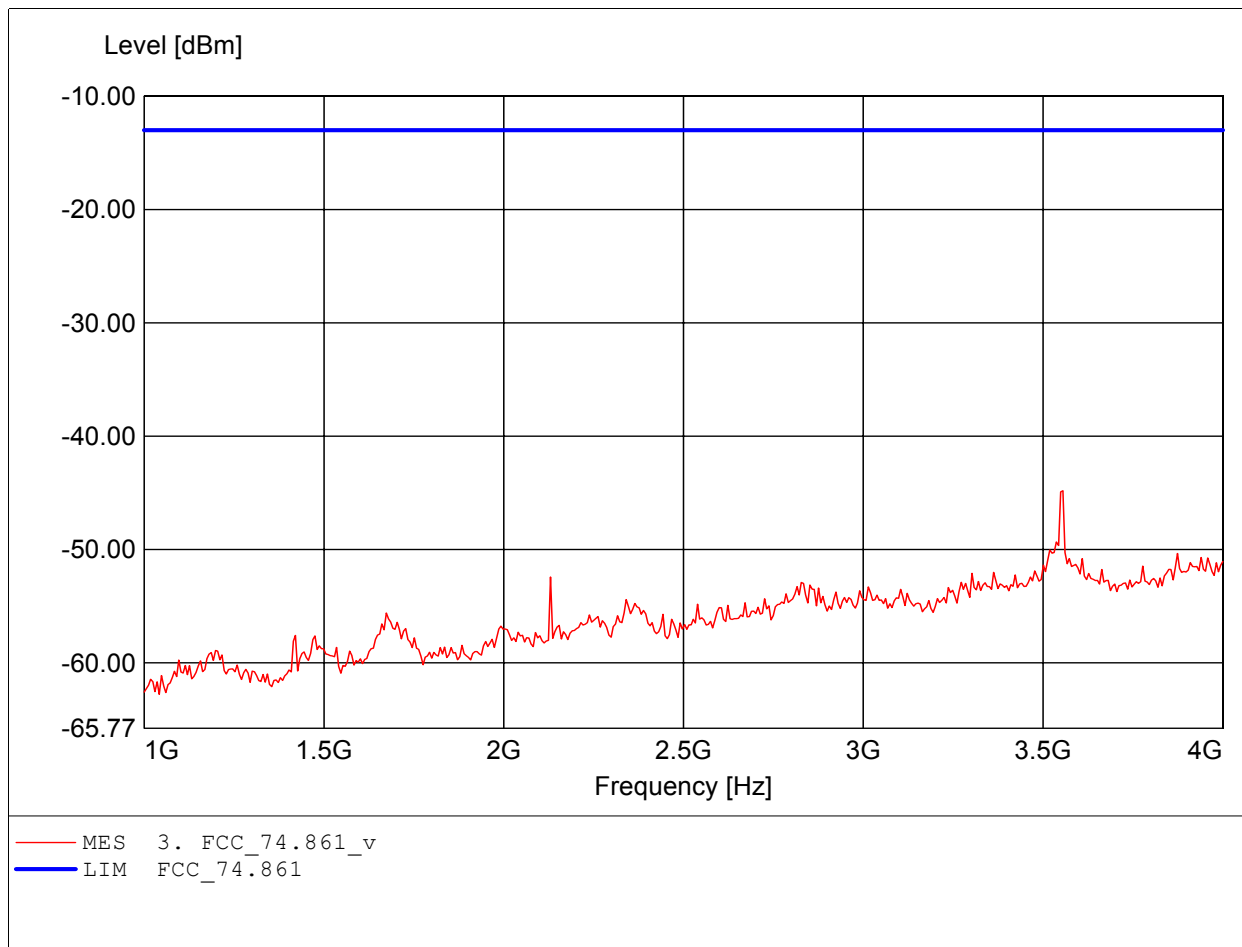

Spurious emissions under normal conditions

in according to FCC Part 74.861

EUT: Wireless Microphone Transmitter
MODEL NO.: UH-2000 Middle channel
Approval Holder: CHIAYO ELECTRONICS CO.,LTD
Test Site / Operator: ETS / PIERCE PENG
Temperature/Voltage: Temp.: 23°C/ Unom.: 3 VDC (1.5 x 2 Battery)
Test Specification: 74.861
Comment 1: Dist.: 3m, Ant.: HL 025, ampl.: 1-4GHz
Freq:3.549GHz Pmax:-40.37dBm RBW: 1 MHz

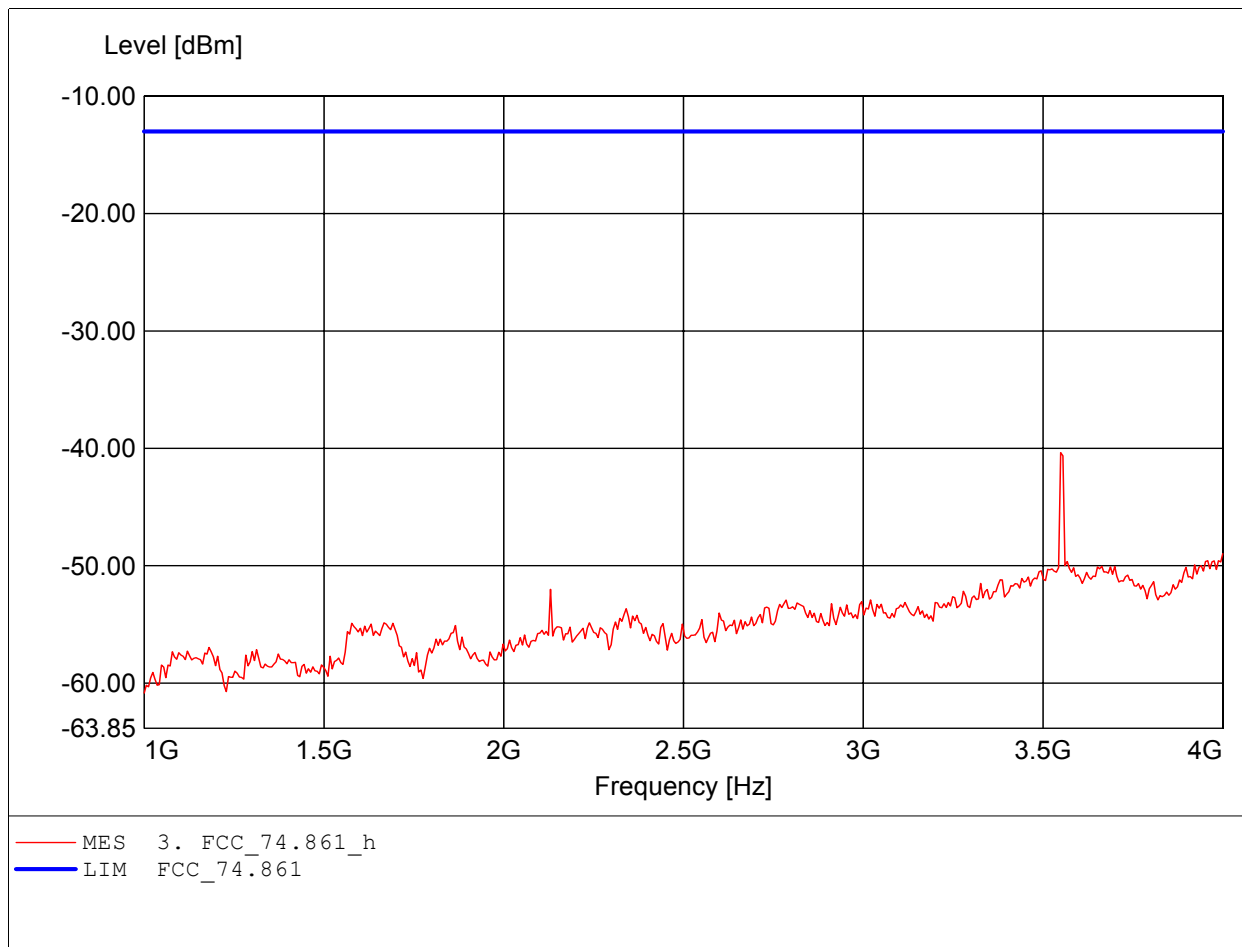

Spurious emissions under normal conditions

in according to FCC Part 74.861

EUT: Wireless Microphone Transmitter
MODEL NO.: UH-2000 Middle channel
Approval Holder: CHIAYO ELECTRONICS CO.,LTD
Test Site / Operator: ETS / PIERCE PENG
Temperature/Voltage: Temp.: 23°C/ Unom.: 3 VDC (1.5 x 2 Battery)
Test Specification: 74.861
Comment 1: Dist.: 1m, Ant.: HL 025, ampl.: 4-8GHz
Freq:7.768GHz Pmax:-53.04dBm RBW: 1 MHz

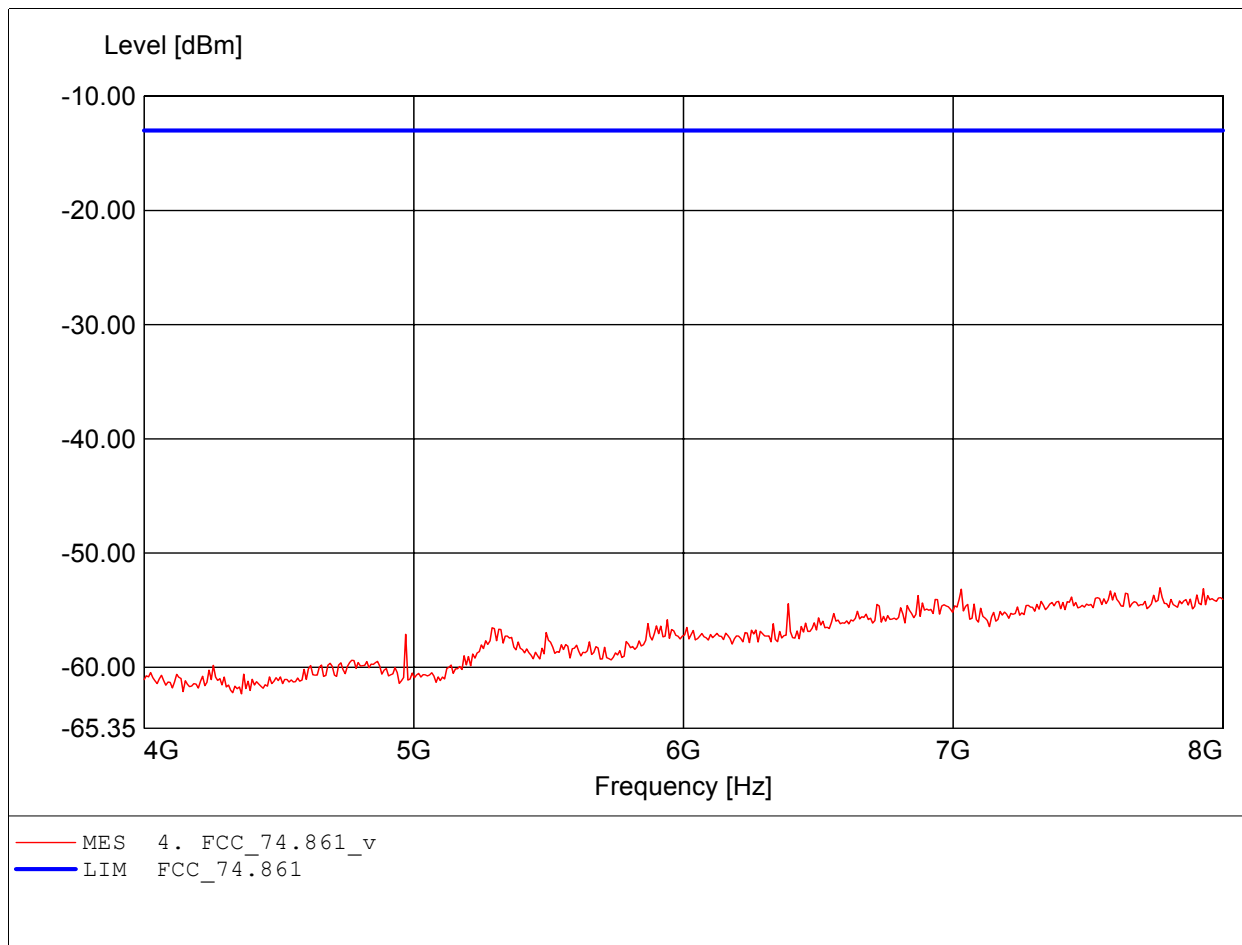

Spurious emissions under normal conditions

in according to FCC Part 74.861

EUT: Wireless Microphone Transmitter
MODEL NO.: UH-2000 Middle channel
Approval Holder: CHIAYO ELECTRONICS CO.,LTD
Test Site / Operator: ETS / PIERCE PENG
Temperature/Voltage: Temp.: 23°C/ Unom.: 3 VDC (1.5 x 2 Battery)
Test Specification: 74.861
Comment 1: Dist.: 1m, Ant.: HL 025, ampl.: 4-8GHz
Freq:7.102GHz Pmax:-49.76dBm RBW: 1 MHz

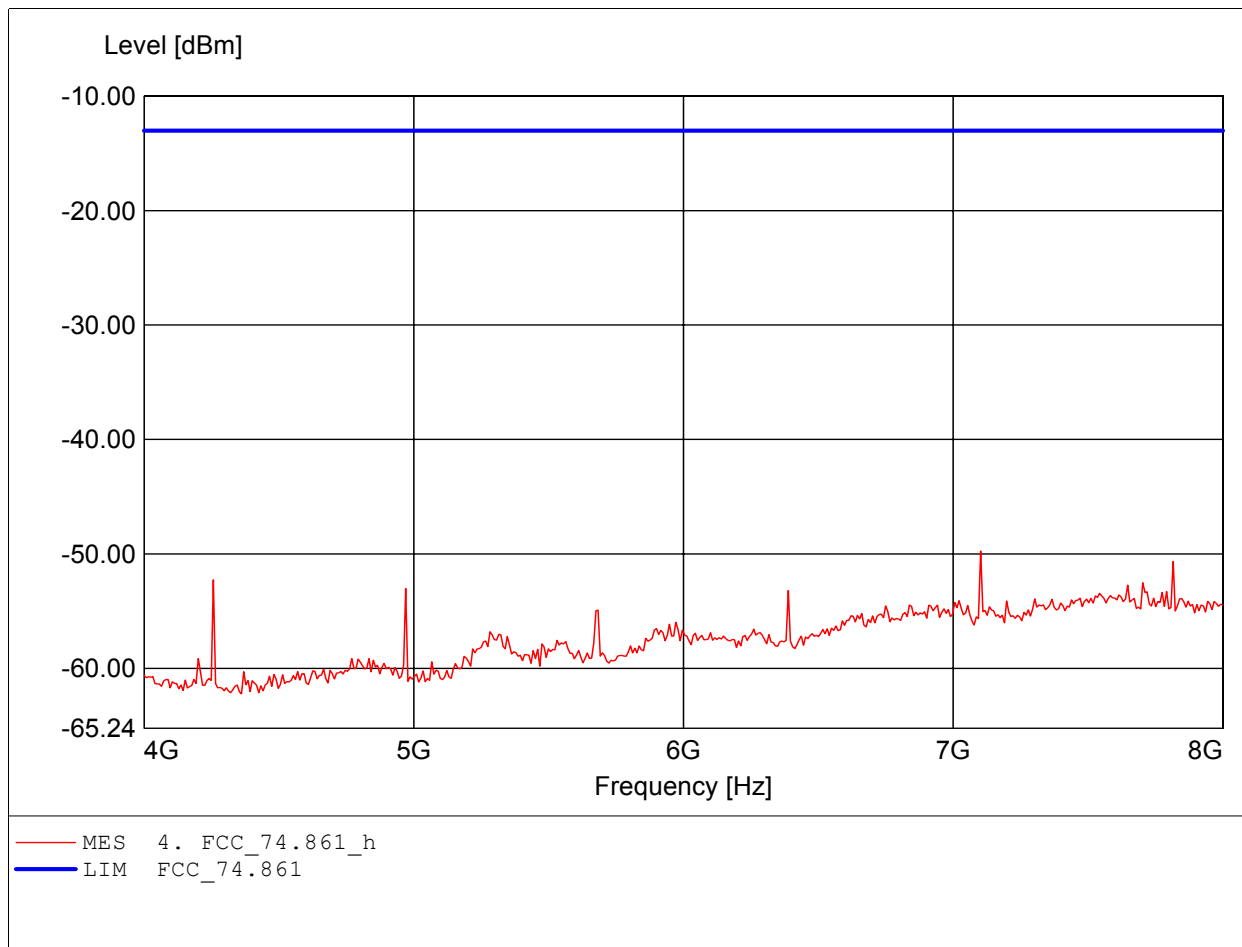

Spurious emissions under normal conditions

in according to FCC Part 74.861

EUT: Wireless Microphone Transmitter
MODEL NO.: UH-2000 Middle channel
Approval Holder: CHIAYO ELECTRONICS CO.,LTD
Test Site / Operator: ETS / PIERCE PENG
Temperature/Voltage: Temp.: 23°C/ Unom.: 3 VDC (1.5 x 2 Battery)
Test Specification: 74.861
Comment 1: Dist.: 1m, Ant.: HL 025, ampl.: 8-18GHz
Freq:12.379GHz Pmax:-43.98dBm RBW: 1 MHz

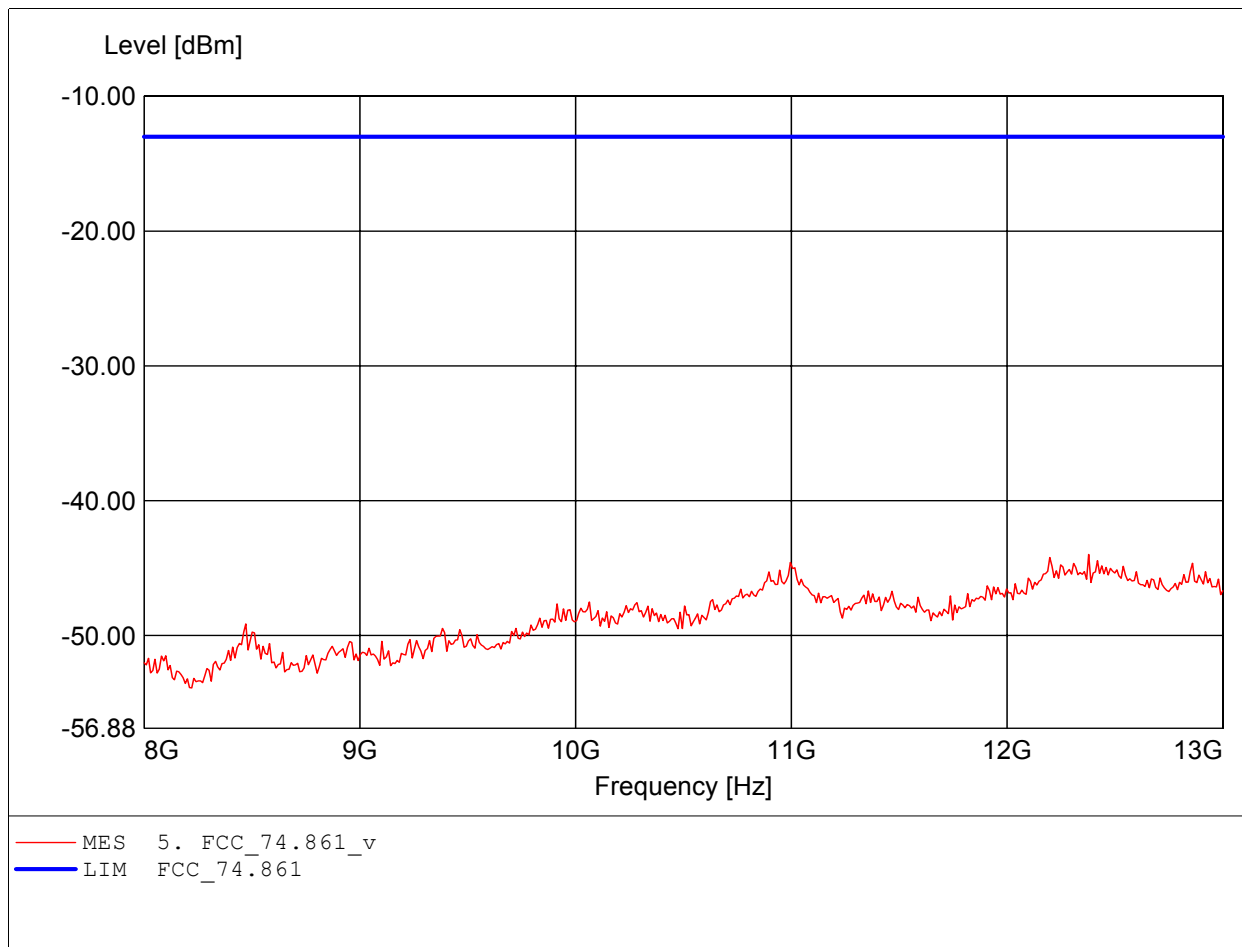

Spurious emissions under normal conditions

in according to FCC Part 74.861

EUT: Wireless Microphone Transmitter
MODEL NO.: UH-2000 Middle channel
Approval Holder: CHIAYO ELECTRONICS CO.,LTD
Test Site / Operator: ETS / PIERCE PENG
Temperature/Voltage: Temp.: 23°C/ Unom.: 3 VDC (1.5 x 2 Battery)
Test Specification: 74.861
Comment 1: Dist.: 1m, Ant.: HL 025, ampl.: 8-18GHz
Freq:12.419GHz Pmax:-44.22dBm RBW: 1 MHz

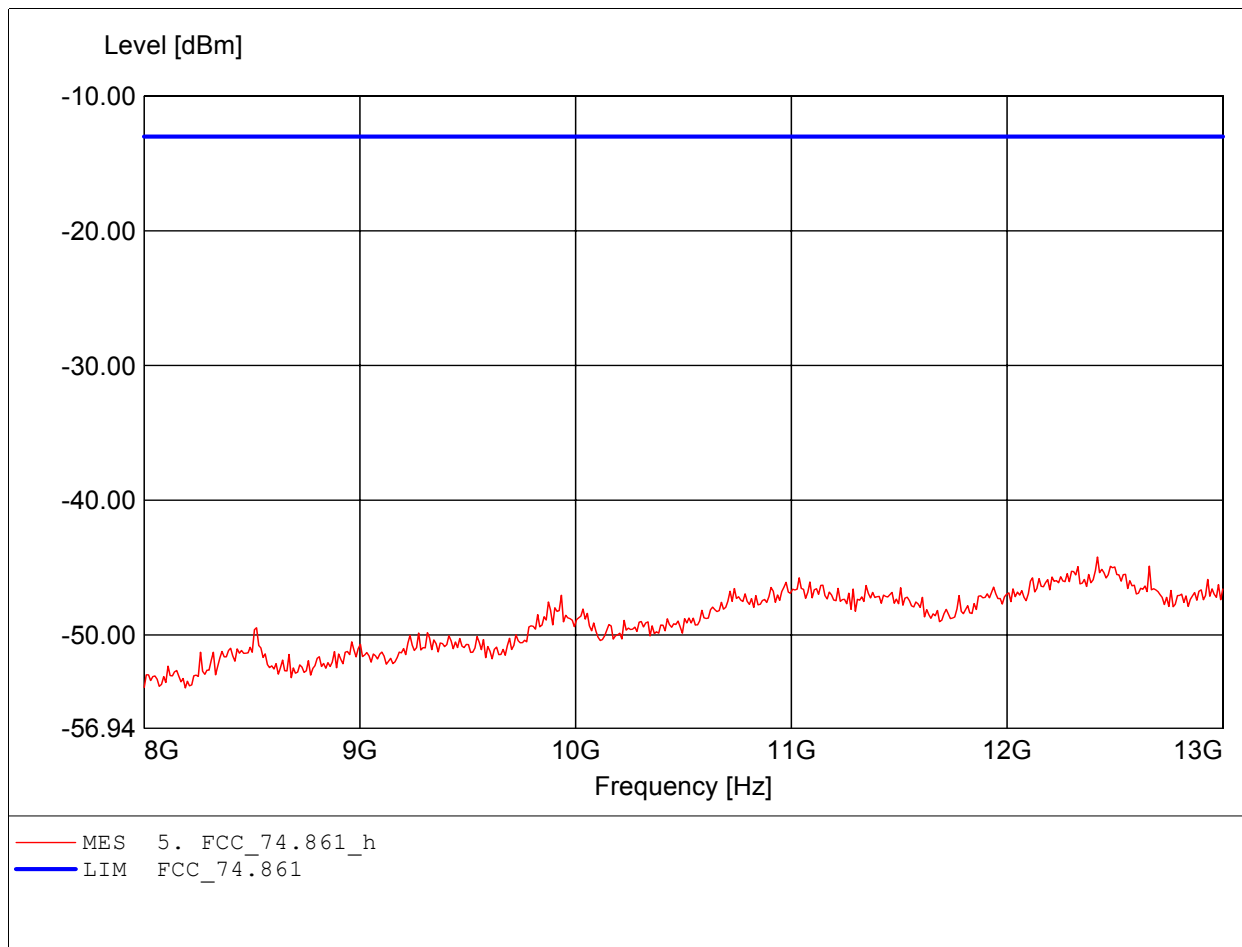

Spurious emissions under normal conditions

in according to FCC Part 74.861

EUT: Wireless Microphone Transmitter
MODEL NO.: UH-2000 High channel
Approval Holder: CHIAYO ELECTRONICS CO.,LTD
Test Site / Operator: ETS / PIERCE PENG
Temperature/Voltage: Temp.: 23°C/ Unom.: 3 VDC (1.5 x 2 Battery)
Test Specification: 74.861
Comment 1: Dist.: 3m, Ant.: HK 116
Freq:106.713MHz Pmax:-53.13dBm RBW: 100 kHz

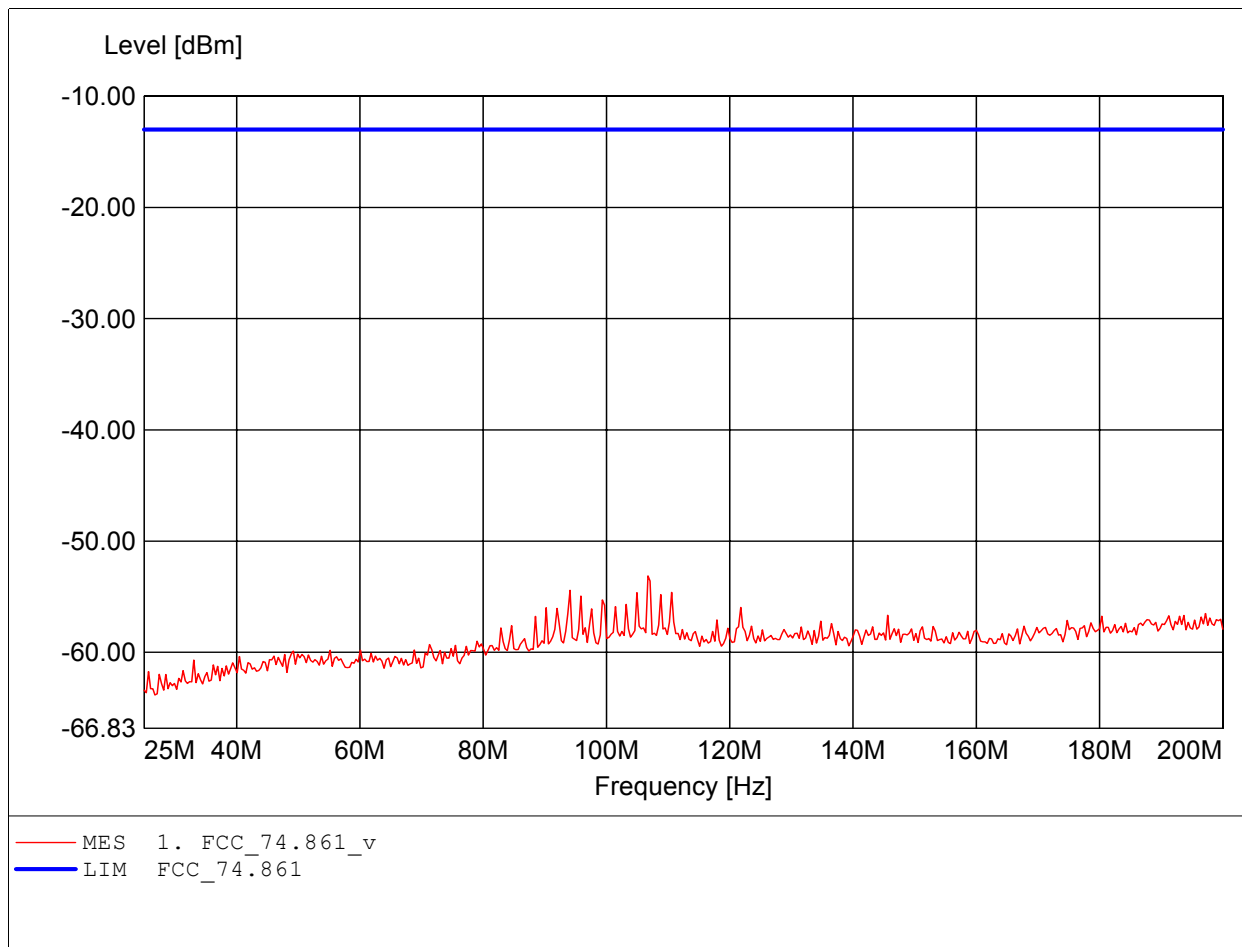

Spurious emissions under normal conditions

in according to FCC Part 74.861

EUT: Wireless Microphone Transmitter
MODEL NO.: UH-2000 High channel
Approval Holder: CHIAYO ELECTRONICS CO.,LTD
Test Site / Operator: ETS / PIERCE PENG
Temperature/Voltage: Temp.: 23°C/ Unom.: 3 VDC (1.5 x 2 Battery)
Test Specification: 74.861
Comment 1: Dist.: 3m, Ant.: HK 116
Freq:187.375MHz Pmax:-57.17dBm RBW: 100 kHz

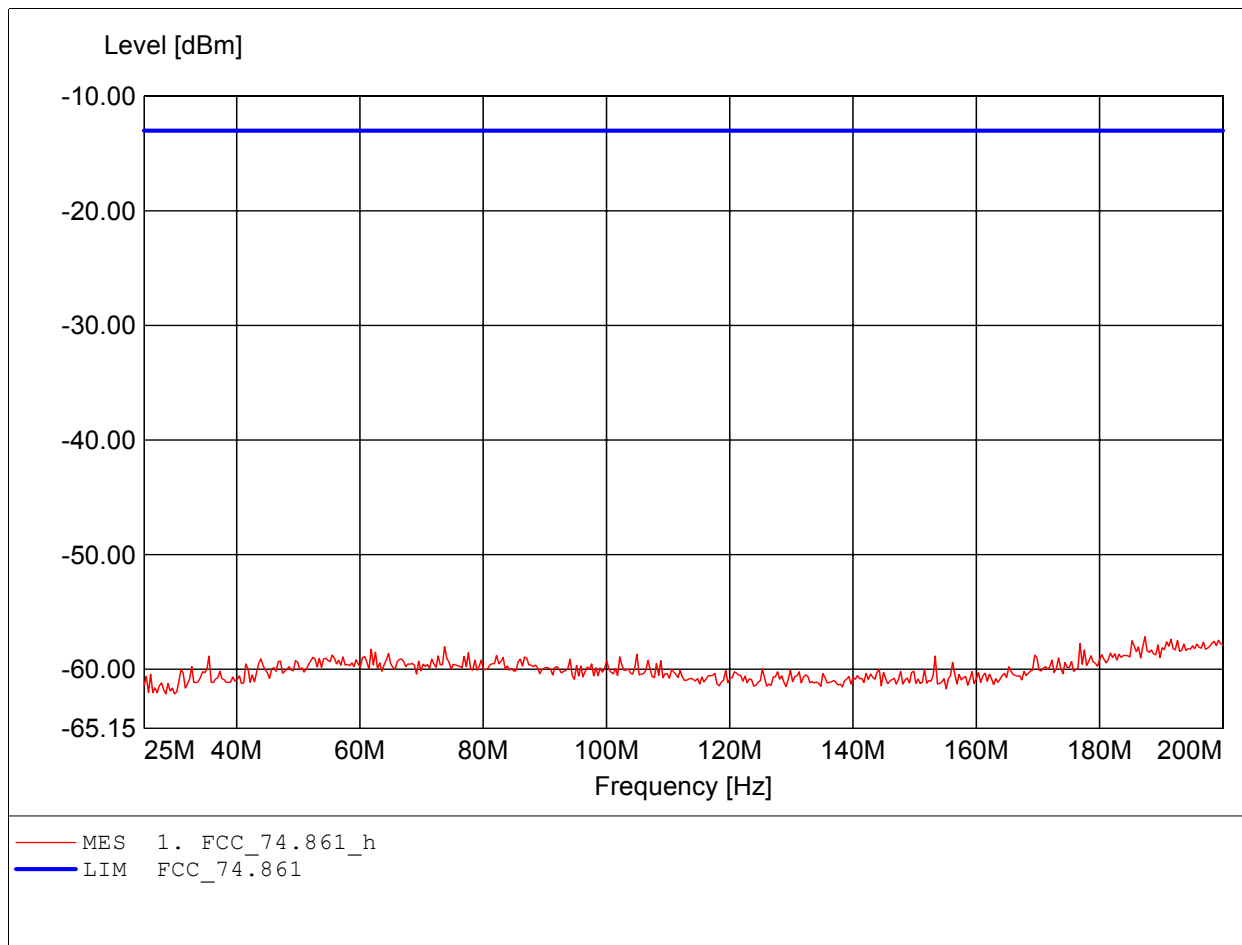

Spurious emissions under normal conditions

in according to FCC Part 74.861

EUT: Wireless Microphone Transmitter
MODEL NO.: UH-2000 High channel
Approval Holder: CHIAYO ELECTRONICS CO.,LTD
Test Site / Operator: ETS / PIERCE PENG
Temperature/Voltage: Temp.: 23°C/ Unom.: 3 VDC (1.5 x 2 Battery)
Test Specification: 74.861
Comment 1: Dist.: 3m, Ant.: HL 223, ampl.: 0.1-1GHz
Freq:806.012MHz Pmax:-65.04dBm RBW: 100 kHz

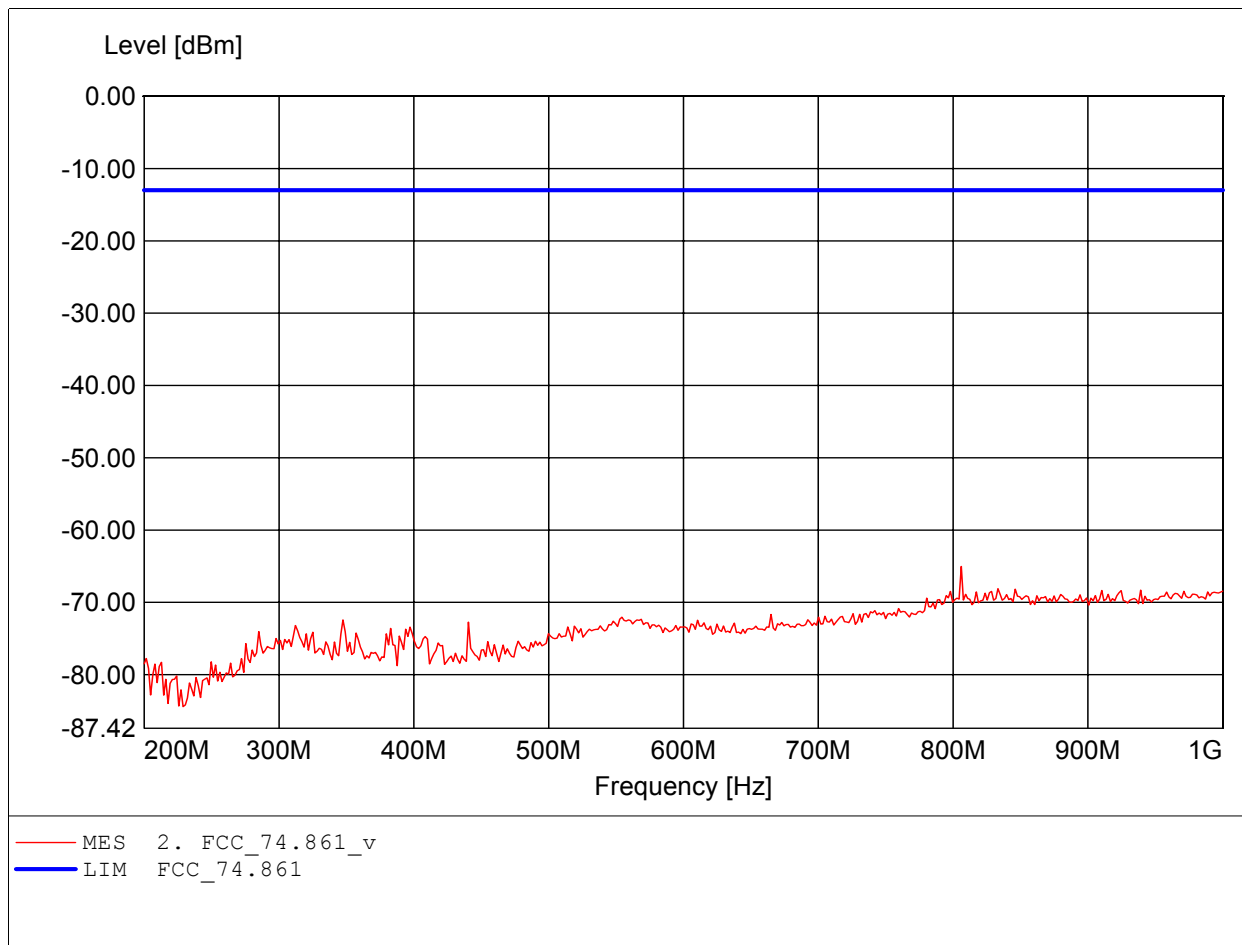

Spurious emissions under normal conditions

in according to FCC Part 74.861

EUT: Wireless Microphone Transmitter
MODEL NO.: UH-2000 High channel
Approval Holder: CHIAYO ELECTRONICS CO.,LTD
Test Site / Operator: ETS / PIERCE PENG
Temperature/Voltage: Temp.: 23°C/ Unom.: 3 VDC (1.5 x 2 Battery)
Test Specification: 74.861
Comment 1: Dist.: 3m, Ant.: HL 223, ampl.: 0.1-1GHz
Freq:959.920MHz Pmax:-66.20dBm RBW: 100 kHz

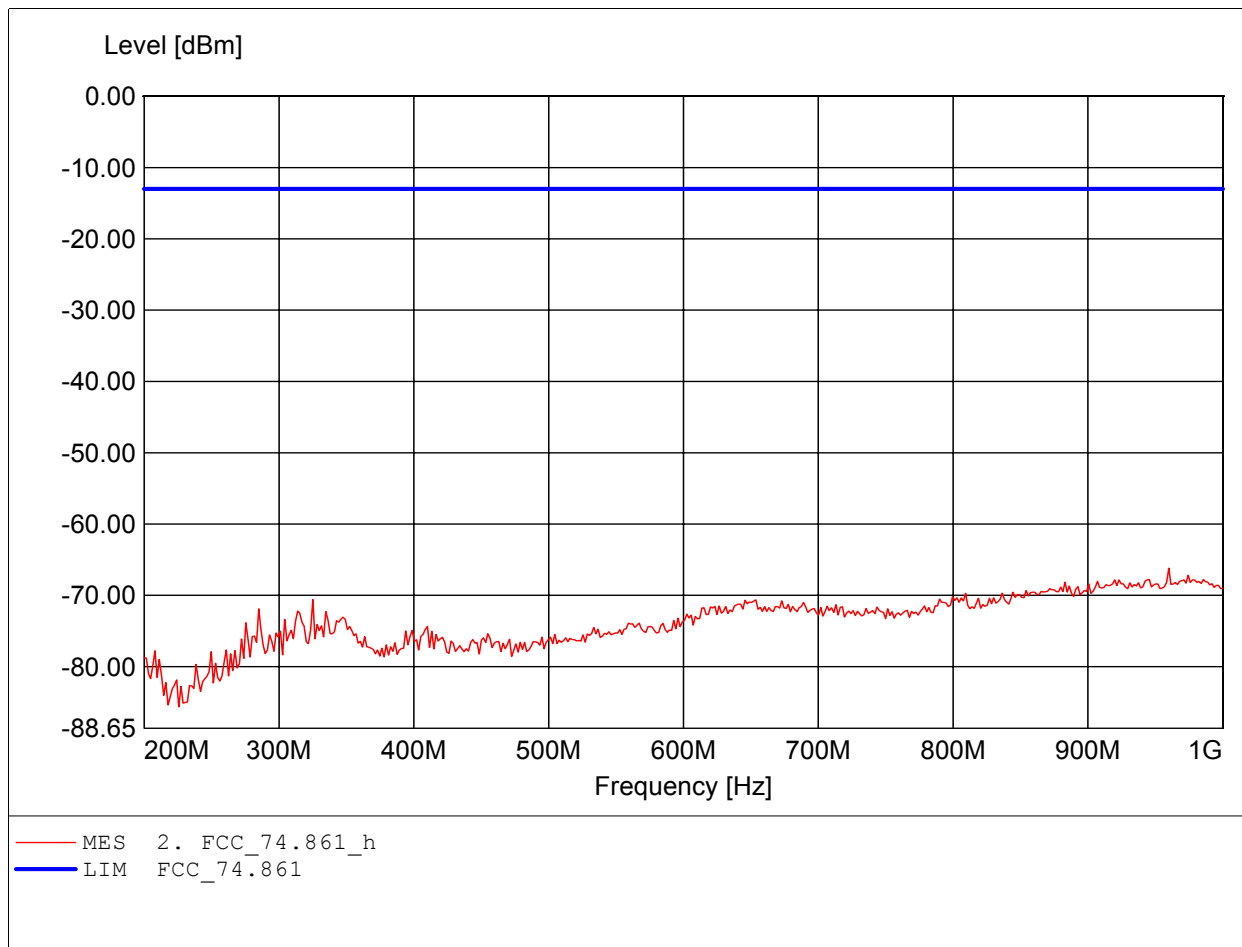

Spurious emissions under normal conditions

in according to FCC Part 74.861

EUT: Wireless Microphone Transmitter
MODEL NO.: UH-2000 High channel
Approval Holder: CHIAYO ELECTRONICS CO.,LTD
Test Site / Operator: ETS / PIERCE PENG
Temperature/Voltage: Temp.: 23°C/ Unom.: 3 VDC (1.5 x 2 Battery)
Test Specification: 74.861
Comment 1: Dist.: 3m, Ant.: HL 025, ampl.: 1-4GHz
Freq:3.543GHz Pmax:-49.44dBm RBW: 1 MHz

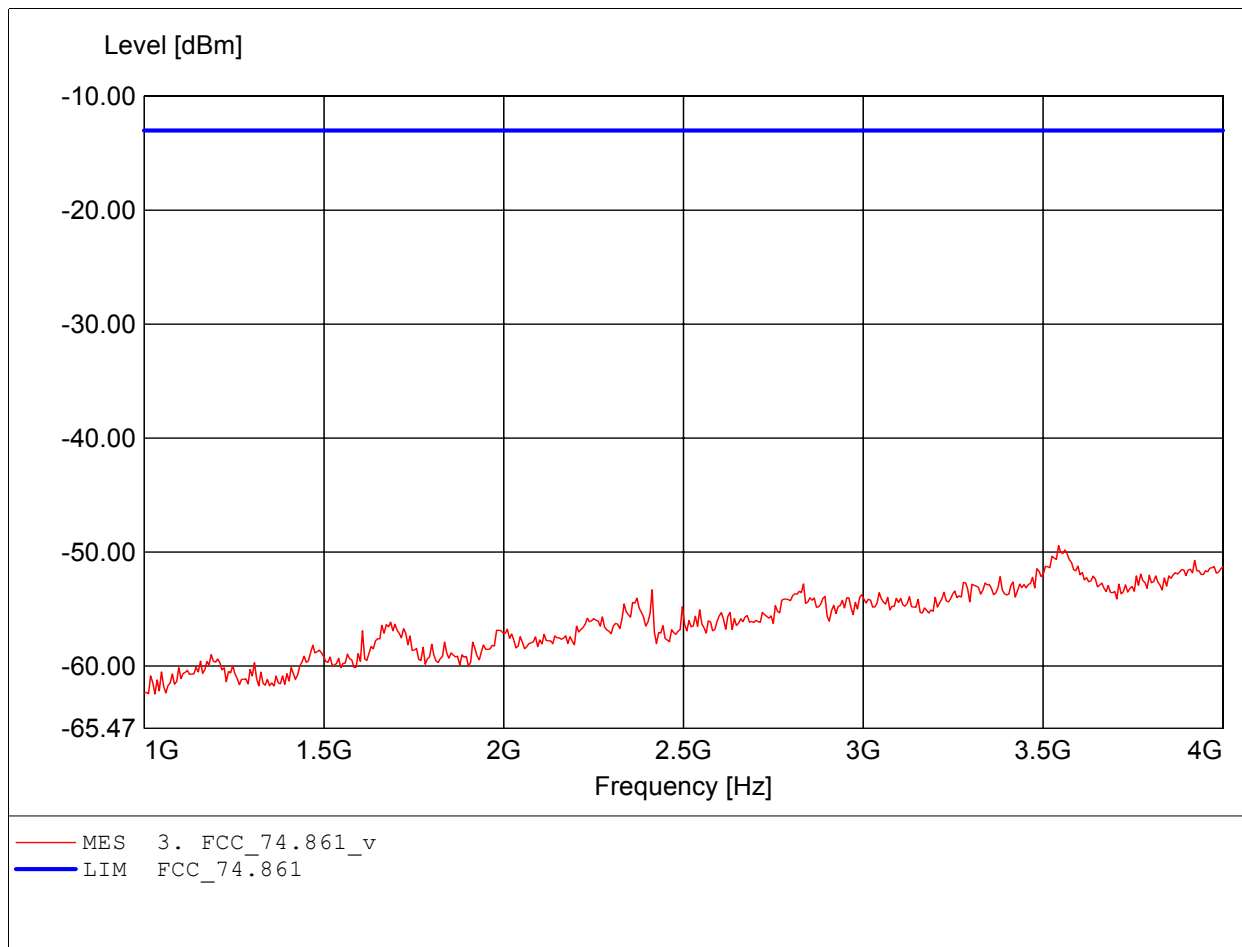

Spurious emissions under normal conditions

in according to FCC Part 74.861

EUT: Wireless Microphone Transmitter
MODEL NO.: UH-2000 High channel
Approval Holder: CHIAYO ELECTRONICS CO.,LTD
Test Site / Operator: ETS / PIERCE PENG
Temperature/Voltage: Temp.: 23°C/ Unom.: 3 VDC (1.5 x 2 Battery)
Test Specification: 74.861
Comment 1: Dist.: 3m, Ant.: HL 025, ampl.: 1-4GHz
Freq:3.543GHz Pmax:-49.10dBm RBW: 1 MHz

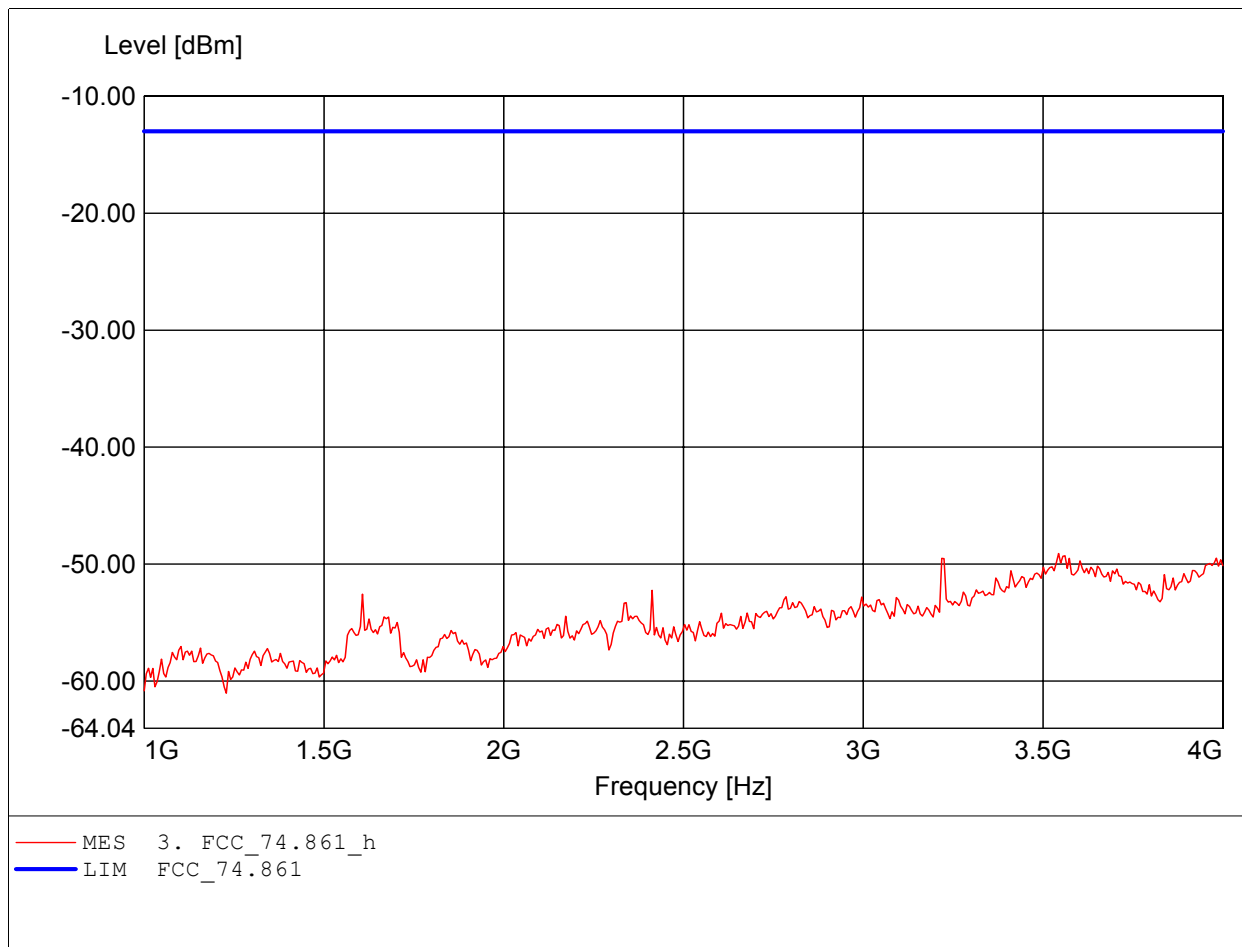

Spurious emissions under normal conditions

in according to FCC Part 74.861

EUT: Wireless Microphone Transmitter
MODEL NO.: UH-2000 High channel
Approval Holder: CHIAYO ELECTRONICS CO.,LTD
Test Site / Operator: ETS / PIERCE PENG
Temperature/Voltage: Temp.: 23°C/ Unom.: 3 VDC (1.5 x 2 Battery)
Test Specification: 74.861
Comment 1: Dist.: 1m, Ant.: HL 025, ampl.: 4-8GHz
Freq:4.024GHz Pmax:-46.87dBm RBW: 1 MHz

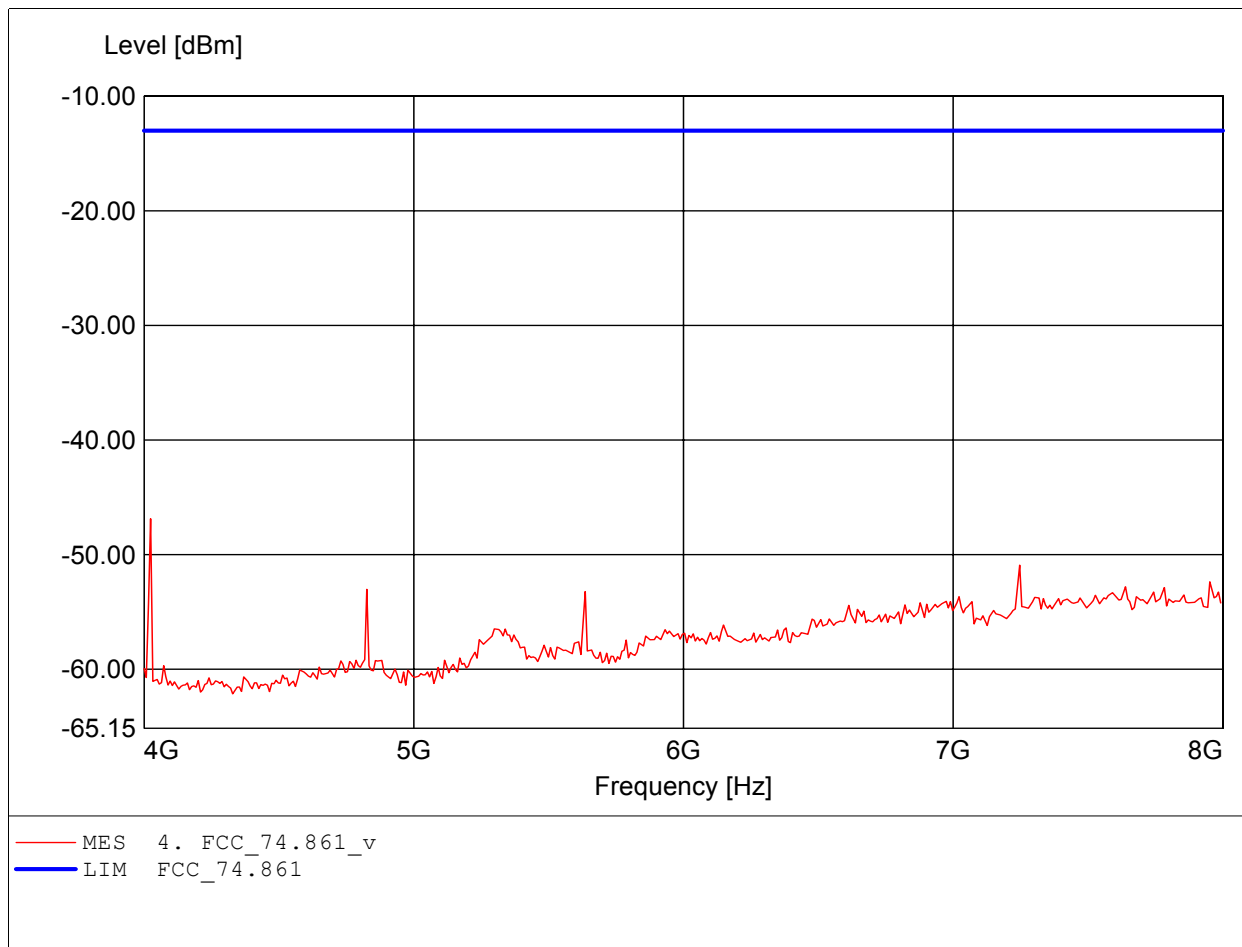

Spurious emissions under normal conditions

in according to FCC Part 74.861

EUT: Wireless Microphone Transmitter
MODEL NO.: UH-2000 High channel
Approval Holder: CHIAYO ELECTRONICS CO.,LTD
Test Site / Operator: ETS / PIERCE PENG
Temperature/Voltage: Temp.: 23°C/ Unom.: 3 VDC (1.5 x 2 Battery)
Test Specification: 74.861
Comment 1: Dist.: 1m, Ant.: HL 025, ampl.: 4-8GHz
Freq:4.024GHz Pmax:-39.68dBm RBW: 1 MHz

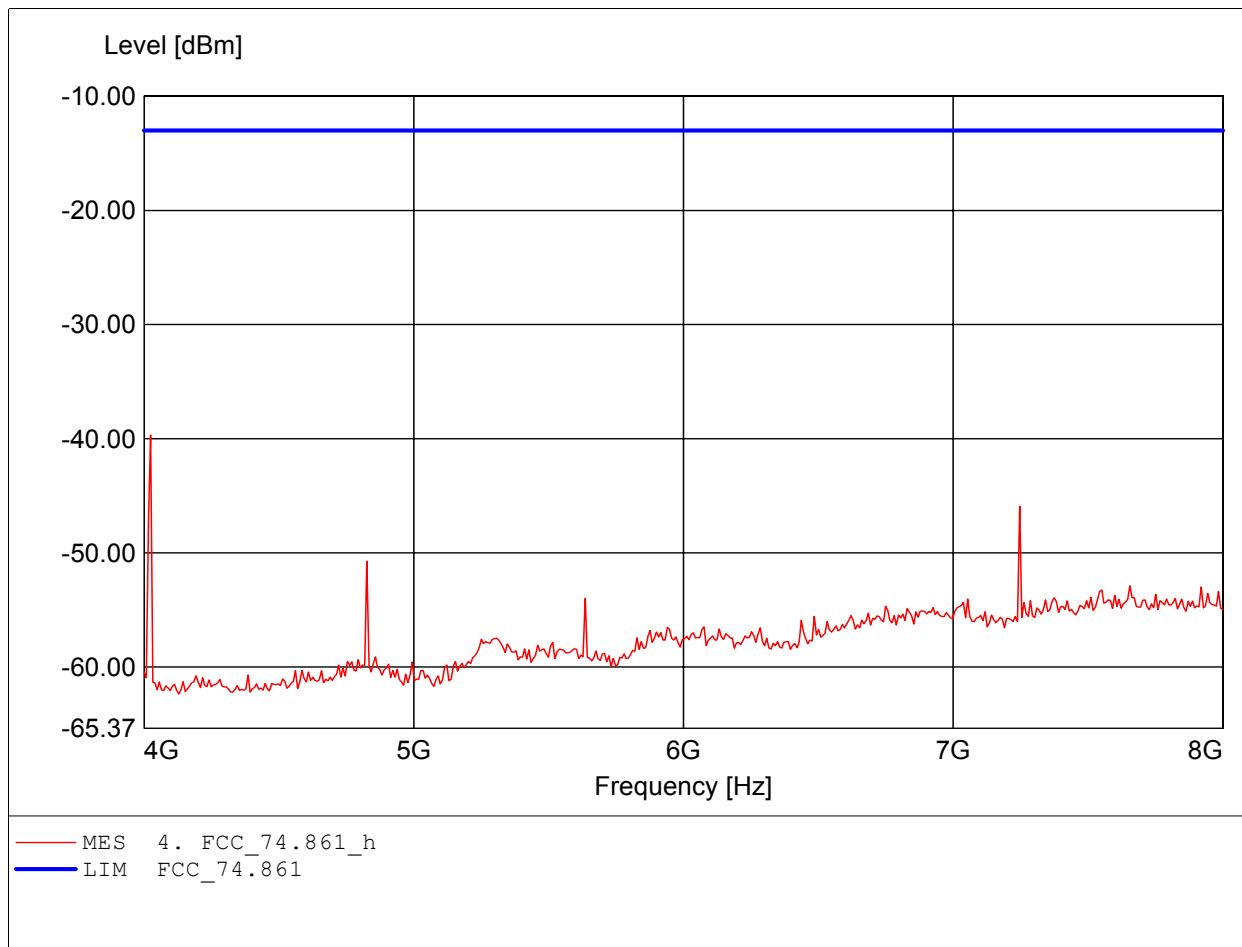

Spurious emissions under normal conditions

in according to FCC Part 74.861

EUT: Wireless Microphone Transmitter
MODEL NO.: UH-2000 High channel
Approval Holder: CHIAYO ELECTRONICS CO.,LTD
Test Site / Operator: ETS / PIERCE PENG
Temperature/Voltage: Temp.: 23°C/ Unom.: 3 VDC (1.5 x 2 Battery)
Test Specification: 74.861
Comment 1: Dist.: 1m, Ant.: HL 025, ampl.: 8-18GHz
Freq:12.529GHz Pmax:-44.44dBm RBW: 1 MHz

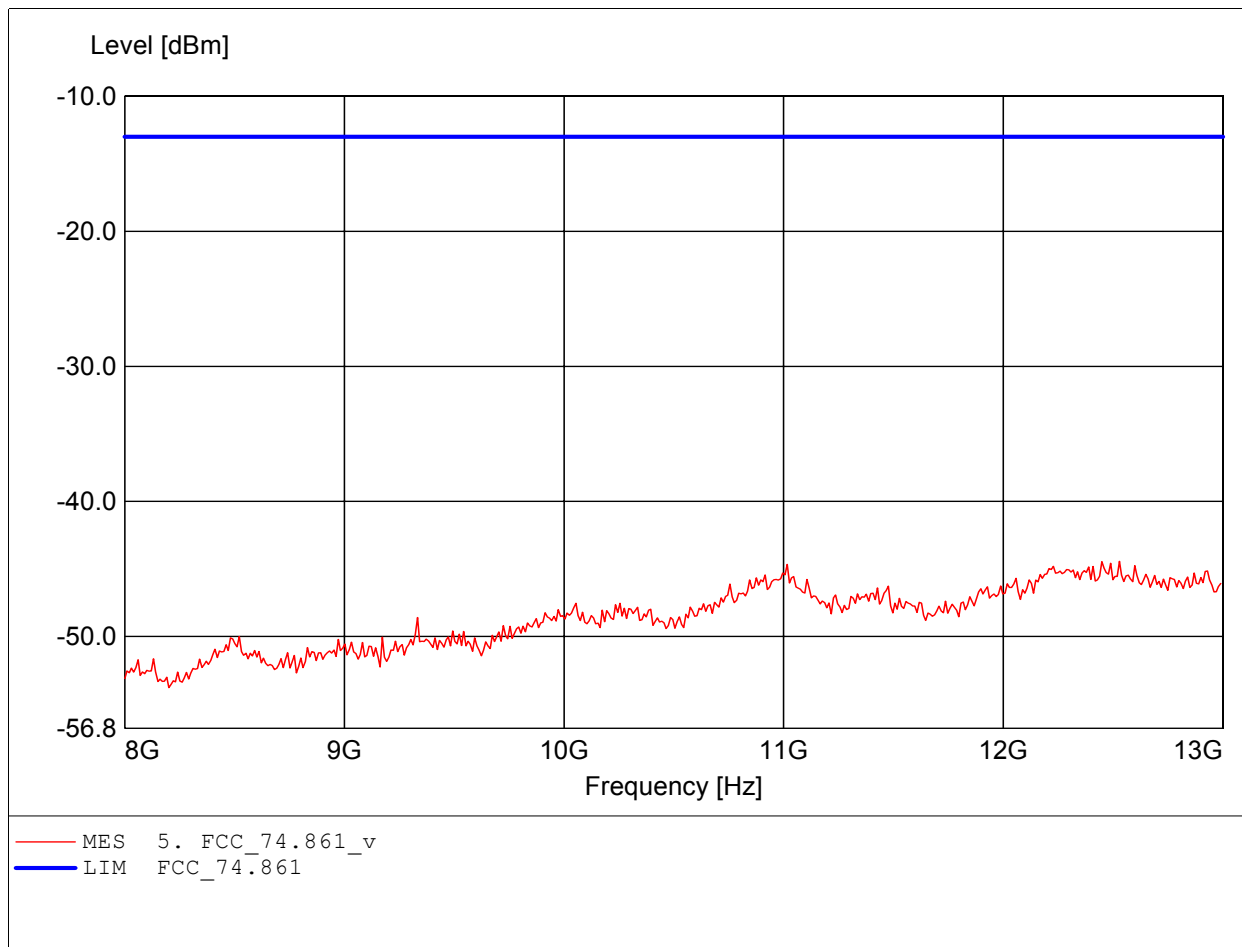

Spurious emissions under normal conditions

in according to FCC Part 74.861

EUT: Wireless Microphone Transmitter
MODEL NO.: UH-2000 High channel
Approval Holder: CHIAYO ELECTRONICS CO.,LTD
Test Site / Operator: ETS / PIERCE PENG
Temperature/Voltage: Temp.: 23°C/ Unom.: 3 VDC (1.5 x 2 Battery)
Test Specification: 74.861
Comment 1: Dist.: 1m, Ant.: HL 025, ampl.: 8-18GHz
Freq:12.479GHz Pmax:-44.41dBm RBW: 1 MHz

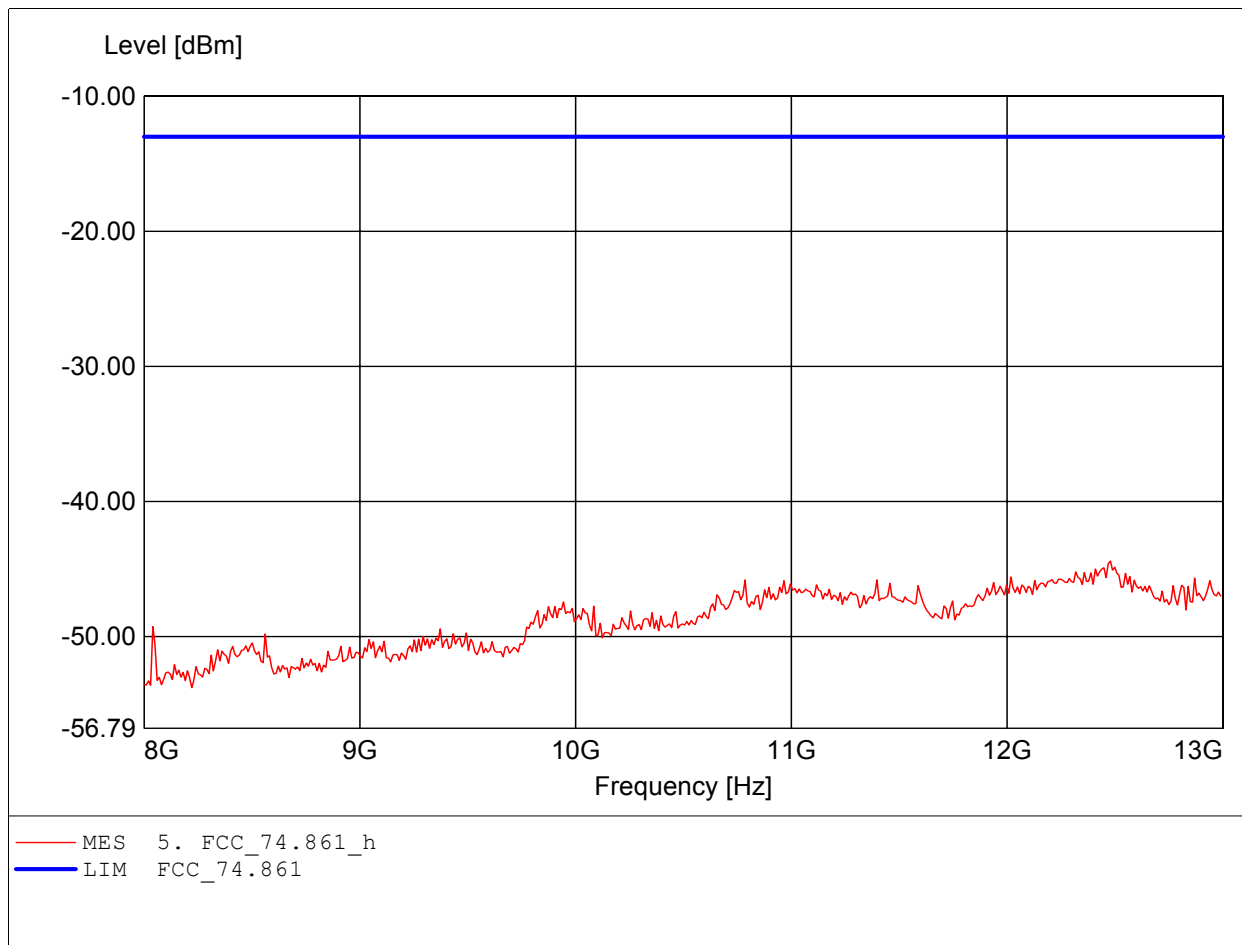

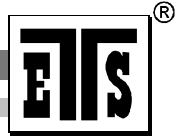

Registration number: W6M20405-5191-C-1
FCC ID: CINUH-2000

Appendix F

Line Conducted Emissions

This is not required the sample is battery used.



Registration number: W6M20405-5191-C-1
FCC ID: CINUH-2000

Appendix G

Frequency Stability vs. Temperature

No diagrams
Refer to point 12.2



Registration number: W6M20405-5191-C-1
FCC ID: CINUH-2000

Appendix H

Frequency Stability vs. Voltage

No diagrams
Refer to point 13.2



Registration number: W6M20405-5191-C-1
FCC ID: CINUH-2000

Appendix I

Pictures

Registration number: W6M20405-5191-C-1
FCC ID: CINUH-2000

External



Registration number: W6M20405-5191-C-1
FCC ID: CINUH-2000



Registration number: W6M20405-5191-C-1
FCC ID: CINUH-2000



Registration number: W6M20405-5191-C-1
FCC ID: CINUH-2000



Registration number: W6M20405-5191-C-1
FCC ID: CINUH-2000

Internal

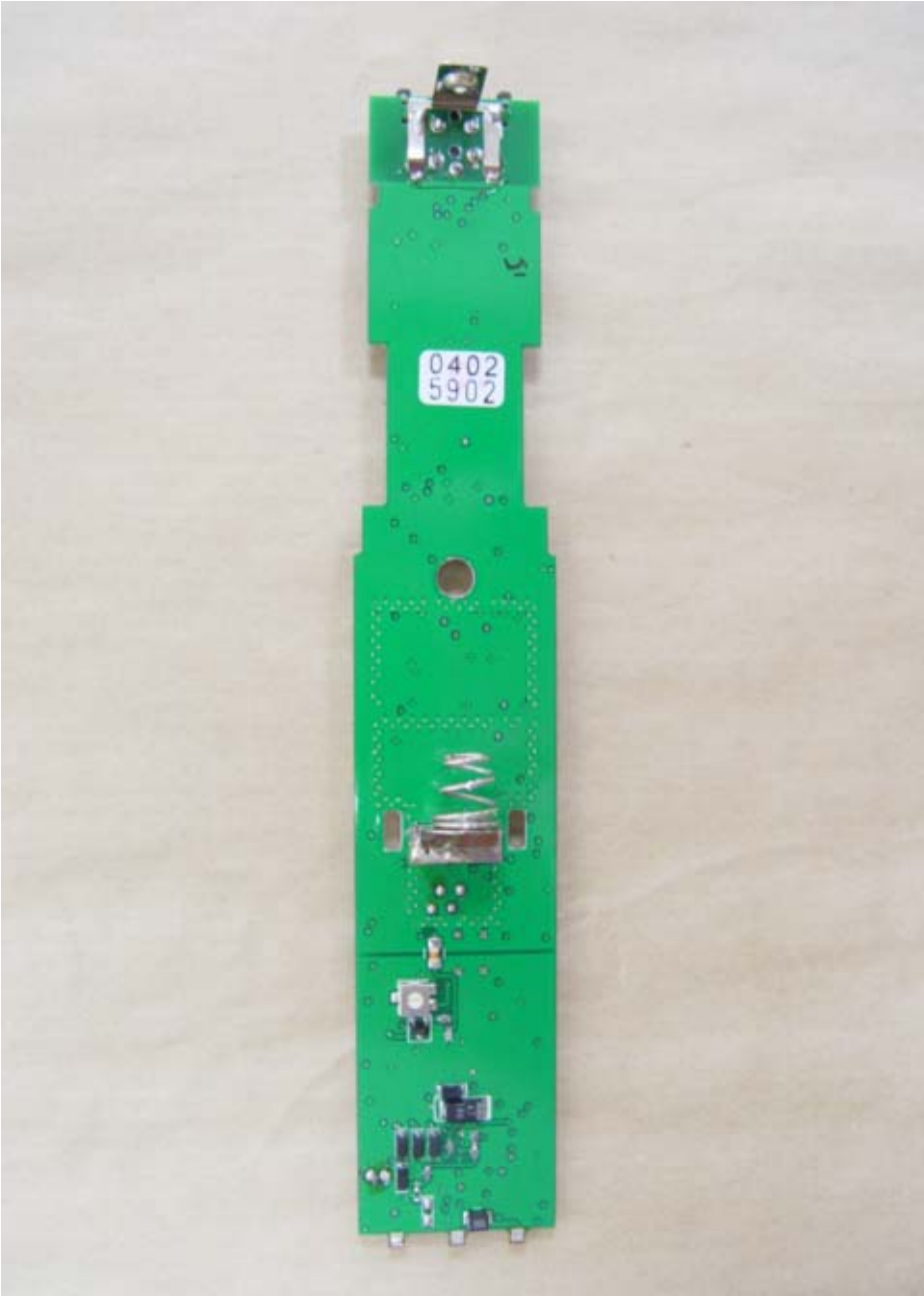

Registration number: W6M20405-5191-C-1
FCC ID: CINUH-2000

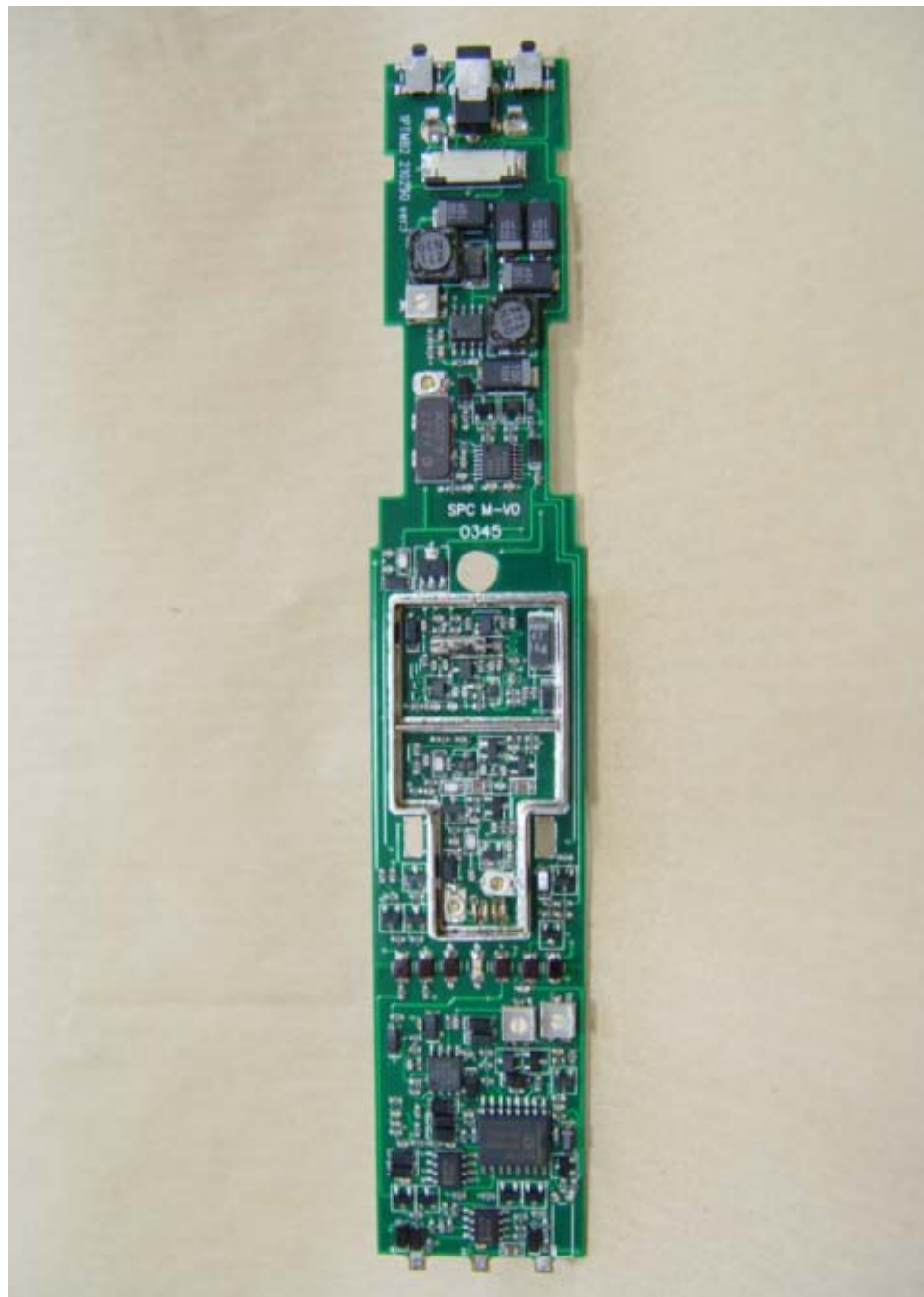

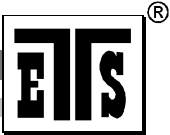

Registration number: W6M20405-5191-C-1
FCC ID: CINUH-2000

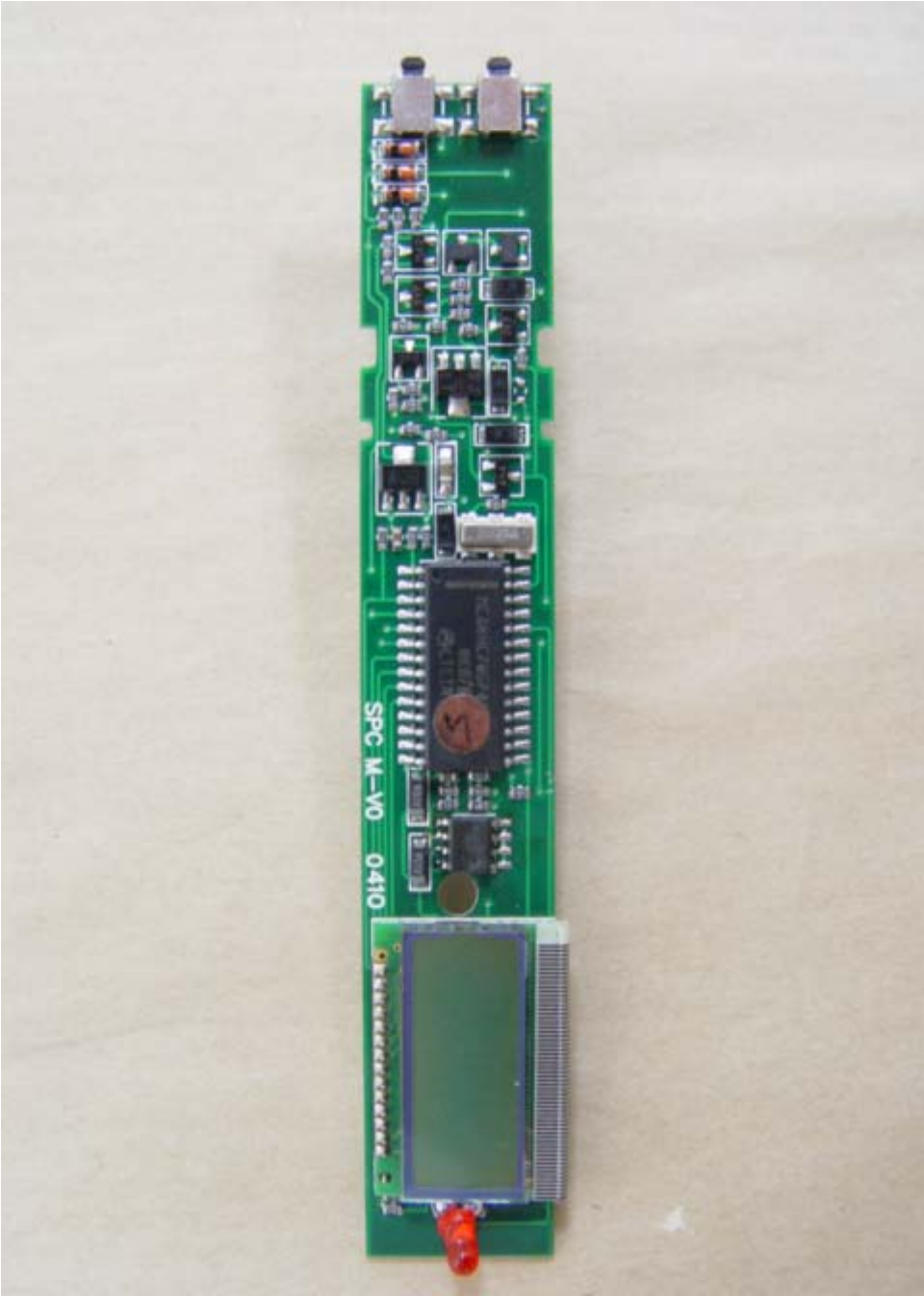

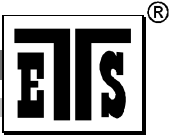

Registration number: W6M20405-5191-C-1
FCC ID: CINUH-2000

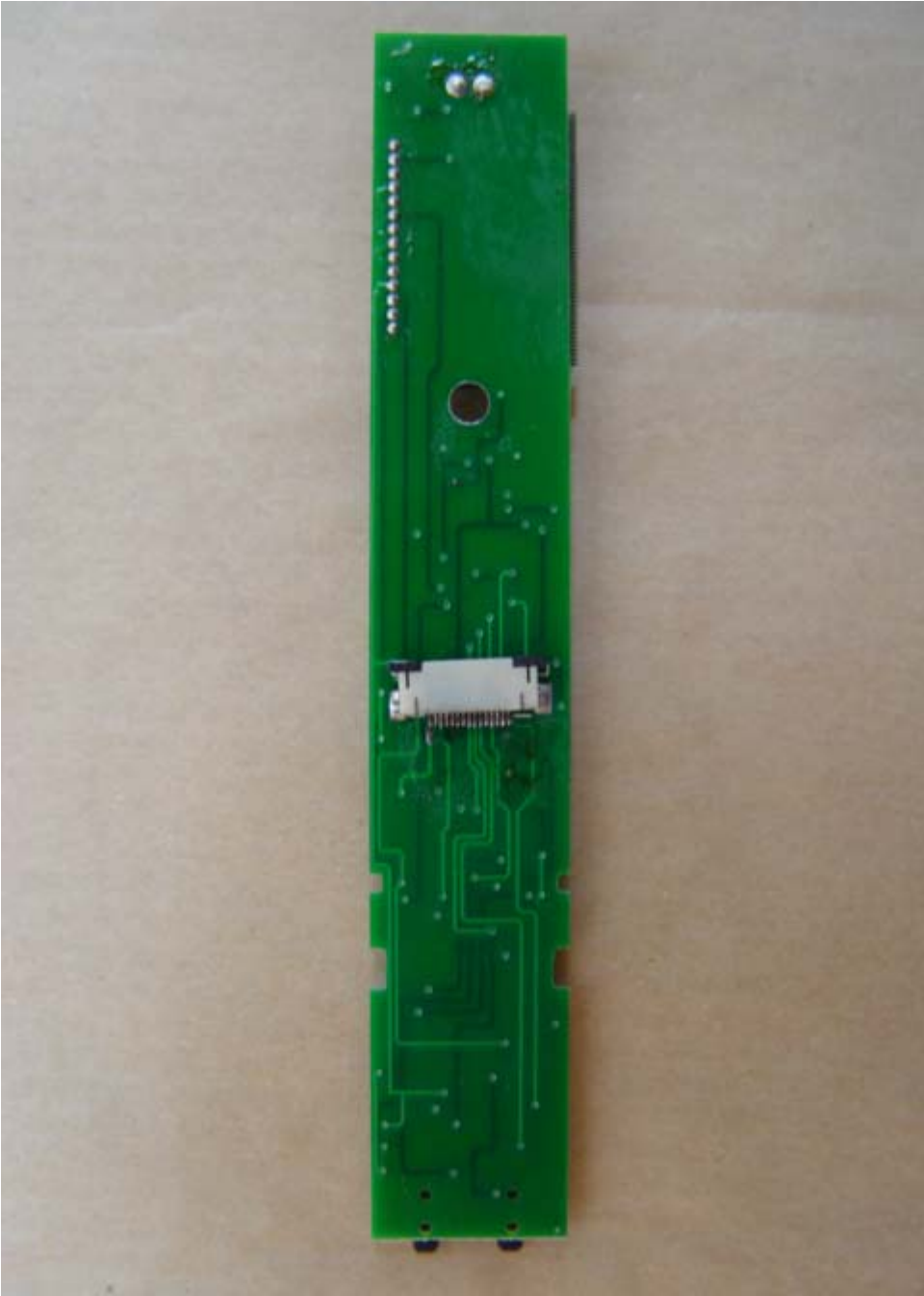

Registration number: W6M20405-5191-C-1
FCC ID: CINUH-2000



Registration number: W6M20405-5191-C-1
FCC ID: CINUH-2000



Registration number: W6M20405-5191-C-1
FCC ID: CINUH-2000



Registration number: W6M20405-5191-C-1
FCC ID: CINUH-2000

Test set-up



Registration number: W6M20405-5191-C-1
FCC ID: CINUH-2000



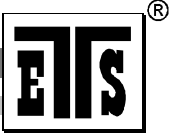

Registration number: W6M20405-5191-C-1
FCC ID: CINUH-2000



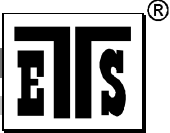

Registration number: W6M20405-5191-C-1
FCC ID: CINUH-2000

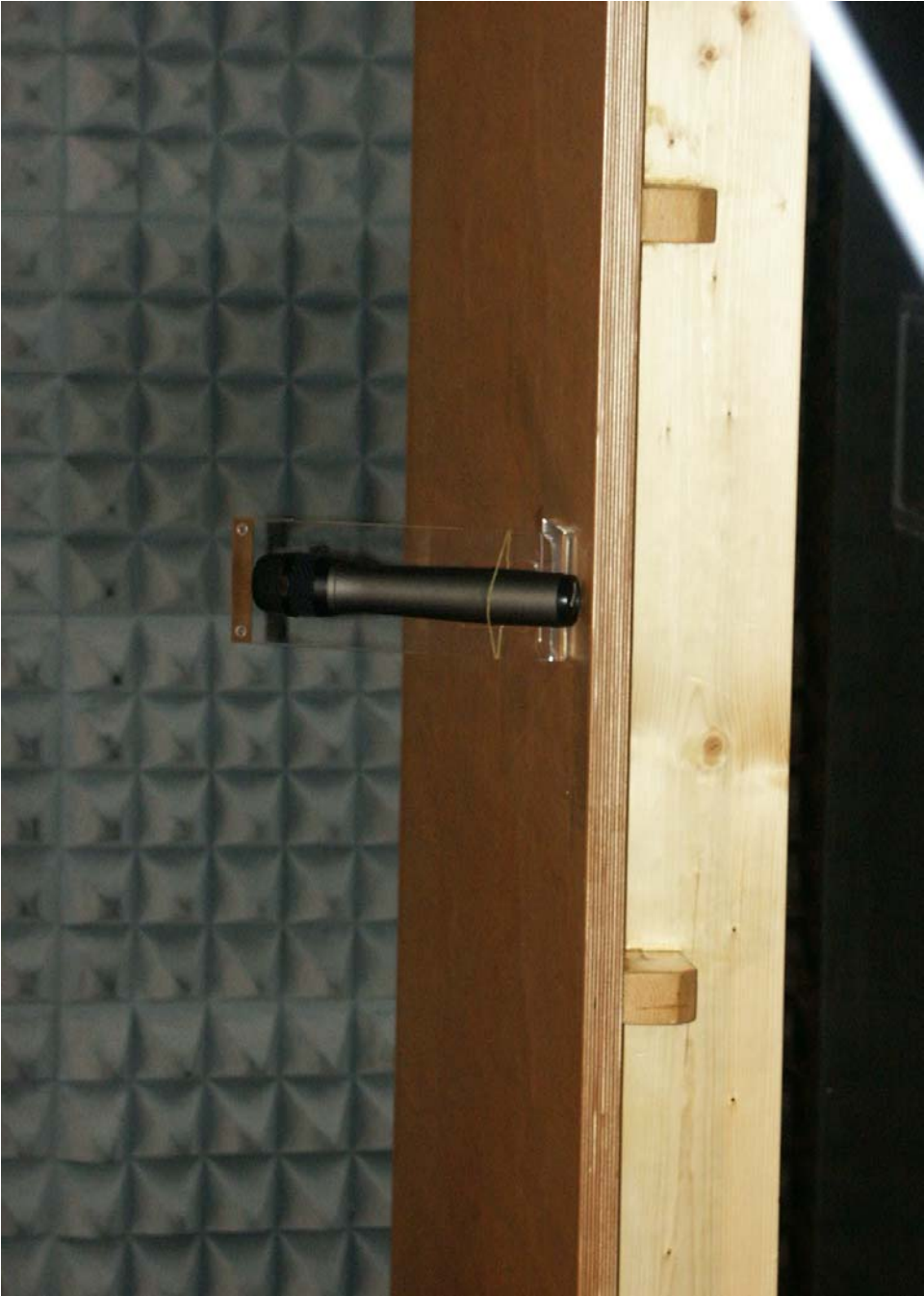

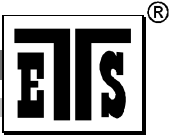

Registration number: W6M20405-5191-C-1
FCC ID: CINUH-2000



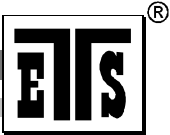

Registration number: W6M20405-5191-C-1
FCC ID: CINUH-2000



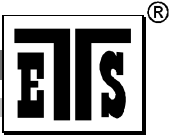

Registration number: W6M20405-5191-C-1
FCC ID: CINUH-2000



Registration number: W6M20405-5191-C-1
FCC ID: CINUH-2000

