

**FCC PART 74 TEST REPORT**

**for**

**Wireless Microphone**

**Model No.: SQ-6100 IrDA**

**FCC ID: CINSQ-6100IRDA**

**of**

Applicant: **CHIAYO ELECTRONICS CO., LTD.**

Address: **No.88, Chung Hsiao Street 2, Chiayi, Taiwan, R.O.C.**

Tested and Prepared

by

**Worldwide Testing Services (Taiwan) Co., Ltd.**

**FCC Registration No.: 930600**

**Industry Canada filed test laboratory Reg. No. IC 5679A-1, IC 5107A-1**

**A2LA Accredited No.: 2732.01**



**Report No.: W6M21504-14935-C-1**

6F, NO. 58, LANE 188, RUEY-KUANG RD., NEIHU TAIPEI 114, TAIWAN, R.O.C.  
TEL: 886-2-66068877 FAX: 886-2-66068879 E-mail: [wts@wts-lab.com](mailto:wts@wts-lab.com)



Registration number: W6M21504-14935-C-1  
FCC ID: CINSQ-6100IRDA

## TABLE OF CONTENTS

<b>1</b>	<b>GENERAL INFORMATION.....</b>	<b>3</b>
1.1	NOTES.....	3
1.2	TESTING LABORATORY .....	4
1.2.1	Location .....	4
1.2.2	Details of accreditation status .....	4
1.2.3	Test location.....	4
1.3	DETAILS OF APPROVAL HOLDER.....	5
1.4	APPLICATION DETAILS .....	5
1.5	GENERAL INFORMATION OF TEST ITEM .....	5
1.6	TEST STANDARDS.....	6
<b>2</b>	<b>TECHNICAL TEST.....</b>	<b>7</b>
2.1	SUMMARY OF TEST RESULTS .....	7
2.2	TEST ENVIRONMENT .....	7
2.3	TEST EQUIPMENT LIST.....	8
2.4	GENERAL TEST PROCEDURE .....	10
<b>3</b>	<b>TEST RESULTS (ENCLOSURE) .....</b>	<b>11</b>
<b>4</b>	<b>RF POWER OUTPUT (CONDUCTED) , FCC 2.1046 (A) ; 74.861 (E) .....</b>	<b>12</b>
4.1	TEST PROCEDURE.....	12
4.2	TEST RESULTS .....	12
<b>5</b>	<b>RADIATED POWER.....</b>	<b>13</b>
5.1	TEST PROCEDURE .....	13
5.2	TEST RESULTS .....	15
<b>6</b>	<b>MODULATION DEVIATION , FCC 2.1047 (B) ; 74.861(E).....</b>	<b>27</b>
6.1	TEST PROCEDURE.....	27
6.2	TEST RESULTS .....	27
<b>7</b>	<b>AUDIO FREQUENCY RESPONSE , FCC 2.1047 (A).....</b>	<b>28</b>
7.1	TEST PROCEDURE.....	28
7.2	TEST RESULTS .....	28
<b>8</b>	<b>OCCUPIED BANDWIDTH/EMISSION MASK, FCC 2.1049 (C) ; 74.861 (E)(5) .....</b>	<b>29</b>
8.1	TEST PROCEDURE.....	29
8.2	TEST RESULTS .....	29
8.3	LIMIT .....	38
<b>9</b>	<b>SPURIOUS EMISSIONS AT ANTENNA TERMINALS FCC2.1051 ; 74.861 (E) .....</b>	<b>39</b>
9.1	TEST PROCEDURE.....	39
9.2	TEST RESULTS .....	39



# ***Worldwide Testing Services(Taiwan) Co., Ltd.***

Registration number: W6M21504-14935-C-1

FCC ID: CINSQ-6100IRDA

9.3	LIMIT .....	39
<b>10</b>	<b>RADIATED SPURIOUS EMISSION , FCC 2.1053 ; 74.861 (E).....</b>	<b>40</b>
10.1	TEST PROCEDURE.....	40
10.2	TEST RESULTS .....	40
10.3	EXPLANATION OF TEST RESULT.....	41
10.4	LIMITS .....	41
<b>11</b>	<b>LINE CONDUCTED EMISSION , FCC 15.207.....</b>	<b>42</b>
11.1	TEST PROCEDURE.....	42
11.2	TEST RESULTS .....	42
<b>12</b>	<b>FREQUENCY STABILITY VS. TEMPERATURE , FCC 2.1055 , 74.861 (E) .....</b>	<b>43</b>
12.1	TEST PROCEDURE.....	43
12.2	TEST RESULTS .....	43
<b>13</b>	<b>FREQUENCY STABILITY VS. VOLTAGE , FCC 2.1055 (D) ; 74.861 (E).....</b>	<b>46</b>
13.1	TEST PROCEDURE.....	46
13.2	TEST RESULTS .....	46
<b>APPENDIX</b> .....		<b>47</b>



# Worldwide Testing Services(Taiwan) Co., Ltd.

Registration number: W6M21504-14935-C-1  
FCC ID: CINSQ-6100IRDA

## 1 General Information

### 1.1 Notes

The purpose of conformity testing is to increase the probability of adherence to the essential requirements or conformity specifications, as appropriate.

The complexity of the technical specifications, however, means that full and thorough testing is impractical for both technical and economic reasons.

Furthermore, there is no guarantee that a test sample which has passed all the relevant tests conforms to a specification.

Neither is there any guarantee that such a test sample will interwork with other genuinely open systems. The existence of the tests nevertheless provides the confidence that the test sample possesses the qualities as maintained and that its performance generally conforms to representative cases of communications equipment.

The test results of this test report relate exclusively to the item tested as specified in 1.5.

The test report may only be reproduced or published in full.

Reproduction or publication of extracts from the report requires the prior written approval of the Worldwide Testing Services (Taiwan) Co., Ltd.

### **Tester:**

June 04, 2015

Spencer Yang

---

Date

WTS-Lab.

Name

Signature

### **Technical responsibility for area of testing:**

June 04, 2015

Kevin Wang

---

Date

WTS

Name

Signature



# ***Worldwide Testing Services(Taiwan) Co., Ltd.***

Registration number: W6M21504-14935-C-1  
FCC ID: CINSQ-6100IRDA

## **1.2 Testing laboratory**

### **1.2.1 Location**

OATS

No.5-1, Lishui, Shuang Sing Village,  
Wanli Dist., New Taipei City 207,  
Taiwan (R.O.C.)

3 meter semi-anechoic chamber

No.35, Aly. 21, Ln. 228, Ankang Rd., Neihu Dist., Taipei City 114, Taiwan (R.O.C.)

TEL:886-2-6613-0228

FAX:886-2-2791-5046

Company

Worldwide Testing Services(Taiwan) Co., Ltd.

6F, NO. 58, LANE 188, RUEY-KUANG RD.

NEIHU, TAIPEI 114, TAIWAN R.O.C.

Tel : 886-2-66068877

Fax : 886-2-66068879

### **1.2.2 Details of accreditation status**

**Accredited testing laboratory**

**A2LA accredited number: 2732.01**

**FCC filed test laboratory Reg. No. 930600**

**Industry Canada filed test laboratory Reg. No. IC 5679A-1, IC 5107A-1**

### **1.2.3 Test location, where different from Worldwide Testing Services (Taiwan) Co., Ltd. :**

Name:	./.
Accredited number:	./.
Street:	./.
Town:	./.
Country:	./.
Telephone:	./.
Fax:	./.



# ***Worldwide Testing Services(Taiwan) Co., Ltd.***

Registration number: W6M21504-14935-C-1

FCC ID: CINSQ-6100IRDA

## **1.3 Details of approval holder**

Name: CHIAYO ELECTRONICS CO., LTD.  
Street: No.88, Chung Hsiao Street 2,  
Town: Chiayi,  
Country: Taiwan, R.O.C.  
Telephone: +886-5-271-1000  
Fax: +886-5-276-7611

## **1.4 Application details**

Date of receipt of test sample: April 08, 2015  
Date of test: from April 09, 2015 to June 03, 2015

## **1.5 General information of Test item**

Type of test item: Wireless Microphone  
Model Number: SQ-6100 IrDA  
Brand Name: CHIAYO  
Multi-listing model number: SQ-7100 IrDA  
Photos: see Annex

## **Technical data**

Frequency band :

<b>Frequency(MHz)</b>	<b>TV Band</b>	<b>Used Band</b>
26.100-26.480	<input type="checkbox"/>	<input type="checkbox"/>
54.000-72.000	<input type="checkbox"/>	<input type="checkbox"/>
76.000-88.000	<input type="checkbox"/>	<input type="checkbox"/>
161.625-161.775	<input type="checkbox"/>	<input type="checkbox"/>
174.000-216.000	<input type="checkbox"/>	<input type="checkbox"/>
450.000-451.000	<input type="checkbox"/>	<input type="checkbox"/>
455.000-456.000	<input type="checkbox"/>	<input type="checkbox"/>
470.000-488.000	<input checked="" type="checkbox"/>	<input checked="" type="checkbox"/>
488.000-494.000	<input checked="" type="checkbox"/>	<input checked="" type="checkbox"/>
494.000-608.000	<input checked="" type="checkbox"/>	<input checked="" type="checkbox"/>
614.000-697.000	<input checked="" type="checkbox"/>	<input checked="" type="checkbox"/>
944.000-952.000	<input type="checkbox"/>	<input type="checkbox"/>



# ***Worldwide Testing Services(Taiwan) Co., Ltd.***

Registration number: W6M21504-14935-C-1

FCC ID: CINSQ-6100IRDA

Frequency ( ch A): 470.1 MHz  
Frequency ( ch B): 539 MHz  
Frequency ( ch C): 607.9 MHz  
Frequency ( ch D): 614.1 MHz  
Frequency ( ch E): 655.95 MHz  
Frequency ( ch F): 697.8 MHz

Antenna Type: Helical Antenna

Antenna Gain: 0 dBi

Power supply: Battery 1.2 VDC\*2

Operation modes: Simplex

## **Manufacturer:** (if different from approval holder)

Name: ./.  
Street: ./.  
Town: ./.  
Country: ./.

## **1.6 Test standards**

Technical standard: FCC Part 74 Subpart H , section 74.861 (2014-10)



Registration number: W6M21504-14935-C-1

FCC ID: CINSQ-6100IRDA

**2 Technical test**

**2.1 Summary of test results**

No deviations from the technical specification(s) were ascertained in the course of the tests performed.

**or**

The deviations as specified in 3 were ascertained in the course of the tests performed.

**2.2 Test environment**

Temperature: 23 °C

Relative humidity content: 20 ... 75 %

Air pressure: 86-103 KPa





# Worldwide Testing Services(Taiwan) Co., Ltd.

Registration number: W6M21504-14935-C-1

FCC ID: CINSQ-6100IRDA

## 2.3 Test Equipment List

No.	Test equipment	Type	Serial No.	Manufacturer	Cal. Date	Next Cal. Date
ETSTW-CE 001	EMI TEST RECEIVER	ESHS10	842121/013	R&S	2014/9/2	2015/9/1
ETSTW-CE 003	AC POWER SOURCE	APS-9102	D161137	GW	Function Test	
ETSTW-CE 008	HF-EICHLLEITUNG RF STEP ATTENUATOR 139dB DPSP	334.6010.02	844581/024	R&S	Function Test	
ETSTW-CE 009	TEMP.&HUMIDITY CHAMBER	GTH-225-40-1P-U	MAA0305-009	GIANT FORCE	2014/7/8	2015/7/7
ETSTW-CE 016	TWO-LINE V-NETWORK	ENV216	100050	R&S	2014/10/13	2015/10/12
ETSTW-RE 004	EMI TEST RECEIVER	ESI 40	832427/004	R&S	2014/9/2	2015/9/1
ETSTW-RE 005	EMI TEST RECEIVER	ESVS10	843207/020	R&S	2014/9/2	2015/9/1
ETSTW-RE 012	TUNABLE BANDREJECT FILTER	D.C 0309	146	K&L	Function Test	
ETSTW-RE 013	TUNABLE BANDREJECT FILTER	D.C 0336	397	K&L	Function Test	
ETSTW-RE 018	MICROWAVE HORN ANTENNA	AT4560	27212	AR	2014/10/15	2015/10/14
ETSTW-RE 027	Passive Loop Antenna	6512	00034563	ETS-Lindgren	2014/7/01	2015/6/30
ETSTW-RE 030	Double-Ridged Guide Horn Antenna	3117	00035224	ETS-Lindgren	2015/3/17	2016/3/16
ETSTW-RE 045	ESA-E SERIES SPECTRUM ANALYZER	E4404B	MY45111242	Agilent	Pre-test Use	
ETSTW-RE 049	TRILOG Super Broadband test Antenna	VULB 9160	9160-3185	Schwarzbeck	2015/3/19	2016/3/18
ETSTW-RE 050	Attenuator 10dB	50HF-010-1	None	JFW	2015/3/2	2016/3/1
ETSTW-RE 051	Attenuator 6dB	50HF-006-1	None	JFW	2015/3/2	2016/3/1
ETSTW-RE 053	Attenuator 3dB	50HF-003-1	None	JFW	2015/3/2	2016/3/1
ETSTW-RE 055	SPECTRUM ANALYZER	FSU 26	200074	R&S	2014/6/05	2015/6/04
ETSTW-RE 060	Attenuator 30dB	5015-30	F651012z-01	ATM	2015/3/2	2016/3/1
ETSTW-RE 062	Amplifier Module	CHC 2	None	KMIC	2014/11/26	2015/11/25
ETSTW-RE 064	Bluetooth Test Set	MT8852B-042	6K00005709	Anritsu	Function Test	
ETSTW-RE 069	Double-Ridged Guide Horn Antenna	3117	00069377	ETS-Lindgren	Function Test	
ETSTW-RE 072	CELL SITE TEST SET	8921A	3339A00375	HP	2014/10/9	2015/10/8
ETSTW-RE 088	SOLID STATE AMPLIFIER	KMA180265A01	99057	KMIC	2014/9/22	2015/9/21
ETSTW-RE 099	DC Block	50DB-007-1	None	JFW	2015/3/2	2016/3/1
ETSTW-RE 106	Humidity Temperature Meter	TES-1366	091011113	TES	2014/11/7	2015/11/6
ETSTW-RE 111	TRILOG Super Broadband test Antenna	VULB 9160	9160-3309	Schwarz beck	2014/12/5	2015/12/4
ETSTW-RE 112	AC POWER SOURCE	TFC-1005	T-0A023536	T-Power	Function test	
ETSTW-RE 115	2.4GHz Notch Filter	N0124411	473874	MICROWAVE CIRCUITS	2015/1/7	2016/1/6
ETSTW-RE 120	RF Player	MP9200	MP9210-111022	ADIVIC	Function test	
ETSTW-RE 122	SIGNAL GENERATOR	SMF100A	102149	R&S	2014/6/11	2015/6/10
ETSTW-RE 125	5GHz Notch filter	5NSL11-5200/E221.3-O/O	1	K&L Microwave	2014/8/12	2015/8/11



# Worldwide Testing Services(Taiwan) Co., Ltd.

Registration number: W6M21504-14935-C-1

FCC ID: CINSQ-6100IRDA

ETSTW-RE 126	5GHz Notch filter	5NSL11-5800/E221.3-O/O	1	K&L Microwave	2014/8/12	2015/8/11
ETSTW-RE 127	RF Switch Box	RFS-01	None	WTS	2015/3/2	2016/3/1
ETSTW-RE 128	5.3GHz Notch filter	N0153001	SN487233	Microwave Circuits	2014/8/12	2015/8/11
ETSTW-RE 129	5.5GHz Notch filter	N0555984	SN487234	Microwave Circuits	2014/8/12	2015/8/11
ETSTW-RE 130	Handheld RF Spectrum Analyzer	N9340A	CN0147000204	Agilent	Pre-test Use	
ETSTW-GSM 002	Universal Radio Communication Tester	CMU 200	109439	R&S	2014/10/20	2015/10/19
ETSTW-GSM 003	Radio Communication Analyzer	MT8820C	6201342073	Anritsu	2015/3/5	2016/3/4
ETSTW-GSM 019	Band Reject Filter	WRCTF824/849-822/851-40 /12+9SS	3	WI	2015/1/7	2016/1/6
ETSTW-GSM 020	Band Reject Filter	WRCD1747/1748-1743/1752-32/5SS	1	WI	2015/1/7	2016/1/6
ETSTW-GSM 021	Band Reject Filter	WRCD1879.5/1880.5-1875.5/1884.5-32/5SS	3	WI	2015/1/7	2016/1/6
ETSTW-GSM 022	Band Reject Filter	WRCT901.9/903.1-904.25-50/8SS	1	WI	2015/1/7	2016/1/6
ETSTW-GSM 023	Power Divider	4901.19.A	None	SUHNER	2014/9/17	2015/9/16
ETSTW-Cable 010	BNC Cable	5 M BNC Cable	None	JYE BAO CO.,LTD.	2014/10/15	2015/10/14
ETSTW-Cable 011	BNC Cable	BNC Cable 1	None	JYE BAO CO.,LTD.	Pre-test Use NCR	
ETSTW-Cable 012	N TYPE To SMA Cable	Cable 012	None	JYE BAO CO.,LTD.	2014/10/15	2015/10/14
ETSTW-Cable 016	BNC Cable	Switch Box	B Cable 1	Schwarz beck	2015/2/25	2016/2/24
ETSTW-Cable 017	BNC Cable	X Cable	B Cable 2	Schwarz beck	2015/2/25	2016/2/24
ETSTW-Cable 018	BNC Cable	Y Cable	B Cable 3	Schwarz beck	2015/2/25	2016/2/24
ETSTW-Cable 019	BNC Cable	Z Cable	B Cable 4	Schwarz beck	2015/2/25	2016/2/24
ETSTW-Cable 020	N TYPE Cable	OATS Cable 1	N30N30-L335-15M	JYE BAO CO.,LTD.	2015/4/23	2016/4/22
ETSTW-Cable 022	N TYPE Cable	5006	0002	JYE BAO CO.,LTD.	2015/3/19	2016/3/18
ETSTW-Cable 026	Microwave Cable	SUCOFLEX 104	279075	HUBER+SUHNER	2015/3/2	2016/3/1
ETSTW-Cable 027	Microwave Cable	SUCOFLEX 104	279083	HUBER+SUHNER	2015/5/14	2016/5/13
ETSTW-Cable 028	Microwave Cable	FA147A0015M2020	30064-2	UTIFLEX	2015/1/16	2016/1/15
ETSTW-Cable 029	Microwave Cable	FA147A0015M2020	30064-3	UTIFLEX	2014/9/22	2015/9/21
ETSTW-Cable 030	Microwave Cable	SUCOFLEX 104 (S_Cable 9)	279067	HUBER+SUHNER	2015/3/2	2016/3/1
ETSTW-Cable 031	Microwave Cable	SUCOFLEX 104 (S_Cable 10)	238092	HUBER+SUHNER	2014/11/26	2015/11/25
ETSTW-Cable 043	Microwave Cable	SUCOFLEX 104	317576	HUBER+SUHNER	2014/11/26	2015/11/25
ETSTW-Cable 048	Microwave Cable	SUCOFLEX 104	325518	HUBER+SUHNER	2014/11/26	2015/11/25
ETSTW-Cable 053	N TYPE To SMA Cable	RG142	None	JYE BAO CO.,LTD.	2015/3/19	2016/3/18
ETSTW-Cable 058	Microwave Cable	SUCOFLEX 104	none	HUBER+SUHNER	2015/3/19	2016/3/18
WTSTW-SW 002	EMI TEST SOFTWARE	EZ EMC	None	Farad	Version ETS-03A1	



Registration number: W6M21504-14935-C-1  
FCC ID: CINSQ-6100IRDA

## **2.4 General Test Procedure**

**POWER LINE CONDUCTED INTERFERENCE:** The procedure used was ANSI STANDARD C63.4-2009 5.2 using a 50 $\mu$ H LISN (if necessary). Both lines were observed. The bandwidth of the spectrum analyzer was 10 kHz with an appropriate sweep speed.

**RADIATION INTERFERENCE:** The test procedure used was according to ANSI STANDARD C63.4-2009 6.4 employing a spectrum analyzer. For investigated frequency is equal to or below 1GHz, the RBW and VBW of the spectrum analyzer was 100 kHz and 100 kHz respectively with an appropriate sweep speed. For investigated frequency is above 1GHz, both of RBW and VBW of the spectrum analyzer were 1 MHz with an appropriate sweep speed. The analyzer was calibrated in dB above a microvolt at the output of the antenna. The ambient temperature of the UUT was 23°C with a humidity of 40 %.

The table used for radiated measurements is capable of continuous rotation. The spectrum was scanned from 30 MHz to the frequency specified as follows:

- (1) If the intentional radiator operates below 10 GHz: to the tenth harmonic of the highest fundamental frequency or to 40 GHz, whichever is lower.
- (2) If the intentional radiator operates at or above 10 GHz and below 30 GHz: to the fifth harmonic of the highest fundamental frequency or to 100 GHz, whichever is lower.
- (3) If the intentional radiator operates at or above 30 GHz: to the fifth harmonic of the highest fundamental frequency or to 200 GHz, whichever is lower, unless specified otherwise elsewhere in the rules.
- (4) If the intentional radiator contains a digital device, regardless of whether this digital device controls the functions of the intentional radiator or the digital device is used for additional control or function purposes other than to enable the operation of the intentional radiator, the frequency range shall be investigated up to the range specified in paragraphs (a)(1)-(a)(3) of this section or the range applicable to the digital device, as shown in paragraph (b)(1) of this Section, whichever is the higher frequency range of investigation.

For hand-held devices, a exploratory test was performed with three (3) orthogonal planes to determine the highest emissions.

Measurements were made by at the registered open field test site located at The Registration Number:

When an emission was found, the table was rotated to produce the maximum signal strength. At this point, the antenna was raised and lowered from 1m to 4m. The antenna was placed in both the horizontal and vertical planes.

ANSI STANDARD C63.4-2009 10.2.7: Any measurements that utilize special test software shall be indicated and referenced in the test report. During testing, test software 'EZ EMC' was used for setting up different operation modes.



Registration number: W6M21504-14935-C-1  
 FCC ID: CINSQ-6100IRDA

**3 Test results (enclosure)**

Test case	Para. Number	Required	Test passed	Test failed
RF Power Output	2.1046 (a); 74.861 (e)(1)	<input checked="" type="checkbox"/>	<input checked="" type="checkbox"/>	<input type="checkbox"/>
Modulation Deviation	2.1047 (b); 74.861 (e)(2)	<input checked="" type="checkbox"/>	<input checked="" type="checkbox"/>	<input type="checkbox"/>
Audio Frequency Response	2.1047 (a)	<input checked="" type="checkbox"/>	<input checked="" type="checkbox"/>	<input type="checkbox"/>
Occupied Bandwidth / Emission Mask	2.1049 (c)(1); 74.861 (e)(5)	<input checked="" type="checkbox"/>	<input checked="" type="checkbox"/>	<input type="checkbox"/>
Spurious Emissions at Antenna Terminals	2.1051 74.861(e)(6)	<input type="checkbox"/>	<input type="checkbox"/>	<input type="checkbox"/>
Radiated Spurious Emission	2.1053 74.861(e)(6)	<input checked="" type="checkbox"/>	<input checked="" type="checkbox"/>	<input type="checkbox"/>
Line Conducted Emissions	15.207	<input type="checkbox"/>	<input type="checkbox"/>	<input type="checkbox"/>
Frequency Stability vs. Temperature	2.1055 (b); 74.861(e)(4)	<input checked="" type="checkbox"/>	<input checked="" type="checkbox"/>	<input type="checkbox"/>
Frequency Stability vs. Voltage	2.1055 (a)(1); 74.861 (e)(4)	<input checked="" type="checkbox"/>	<input checked="" type="checkbox"/>	<input type="checkbox"/>

The following is intentionally left blank.



Registration number: W6M21504-14935-C-1  
 FCC ID: CINSQ-6100IRDA

**4 RF Power Output (conducted) , FCC 2.1046 (a) ; 74.861 (e)**

**4.1 Test procedure**

This transmitter output was connected to a calibrated coaxial attenuator, the other end of which was connected to a spectrum analyzer. Transmitter output was derived with the spectrum analyzer in dBm. The power output at the transmitter antenna port was determined by assign the value of the attenuator to the spectrum analyzer reading.

An HP power meter was also used to measure the RF power.

Tests were performed with an un-modulated carrier at three frequencies (low , middle and high channels ) and on all power levels , which can be set-up on the transmitters.

**4.2 Test Results**

Frequency Channel	Peak Output Power ( dBm )
470.1 MHz	--
539 MHz	--
607.9 MHz	--
614.1 MHz	--
655.95 MHz	--
697.8 MHz	--

Limits:

LPAS operating in TV bands	
Frequency [MHz]	Conducted output power [ mW ]
54 – 72 76 – 88 174 - 216	50 (17 dBm)
470 – 608 614 - 698	250 (24 dBm)

LPAS operating in other than TV bands	
Conducted power [W]	1

Test equipment used: ETSTW-RE 055, ETSTW-RE 050

Explanation :This test is not required.

Registration number: W6M21504-14935-C-1  
 FCC ID: CINSQ-6100IRDA

## 5 Radiated Power

### 5.1 Test Procedure

The EUT was positioned on a non-conductive turntable, 0.8m above the ground on an open test site. The radiated emission at the fundamental frequency was measured at 3m distance with a test antenna and spectrum analyzer.

Worst case emission was recorded with the rotation of the turntable and the raising and lowering of the test antenna.

### Substitution RF power Measurement at WTS Taiwan

General :

The applied substitution method follows ANSI/TIA/EIA-603, ANSI/TIA/EIA-102.CAAA or the appropriate ETSI rules respectively.

The actual signal generated by the EUT can be determined by means of a substitution measurement in which a known signal source replaces the device to be measured.

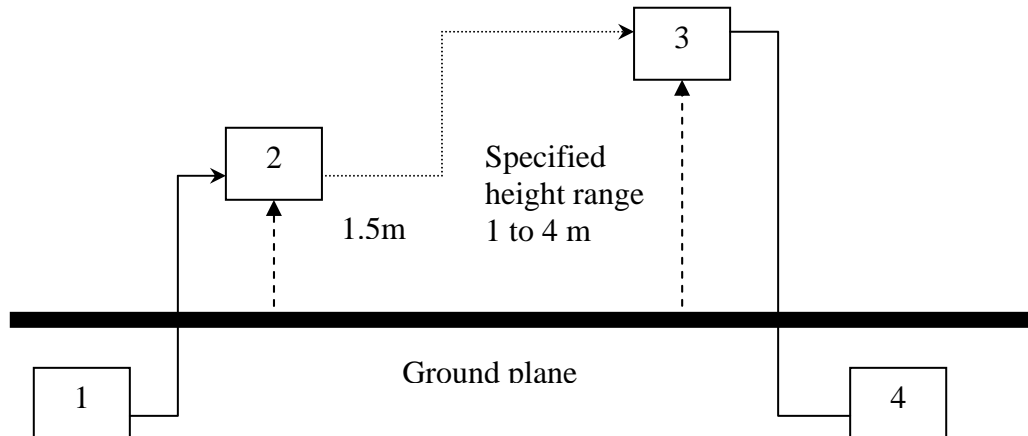

- 1) Signal generator ;
- 2) Substitution antenna ;
- 3) Test antenna ;
- 4) Spectrum analyzer or selective voltmeter.

The substitution antenna replaces the transmitter antenna at the same position and in vertical polarization. The frequency of the signal generator shall be adjusted to the measurement frequency.

The test antenna shall be raised or lowered, if necessary, to ensure that the maximum signal is still received. The input signal to the substitution antenna shall be adjusted in level until an equal or a known related level to that detected from the transmitter is obtained in the measurement receiver.

If a fully anechoic chamber is used as test site in order to provide free space conditions there is no need to change the height of the antenna.

The measurement will be repeated in horizontal position.



Registration number: W6M21504-14935-C-1  
FCC ID: CINSQ-6100IRDA

## **Calibration :**

In order to make this kind of measurement more effective and to avoid subjective measurement faults ETS has installed automatic computer controlled measurement procedures.

With the above described substitution method a test site is calibrated over the full frequency range which is used in suitable frequency steps. For a certain power level on the substitution antenna the received power over the whole frequency range is documented. All necessary antenna gains, cable losses, filter losses and amplifications of preamplifiers are taken in consideration. The summary of this calibration measurement performs a transducer factor that is related to the considered test site and a certain measurement distance. Differences of the radiated power levels of different test samples are determined by internal attenuation of measurement receiver . The proper function of such test site will be maintained by short term plausibility checks and periodical re-calibration.

## **Testing :**

Now the test sample will be putted on the table at the defined position and the radiated power will be receiver and documented by the measurement receiver.

On test sites with ground plane the measurement antenna will be lowered and raised to maximum values at significant frequencies.

For peak power measurements the sample is turned by the turntable over 360 degree in order to find the direction with the maximum radiation or to document the max reading with the MAXHOLD function during the rotation.

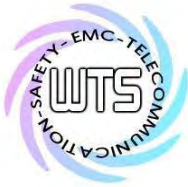

# Worldwide Testing Services(Taiwan) Co., Ltd.

Registration number: W6M21504-14935-C-1

FCC ID: CINSQ-6100IRDA

## 5.2 Test results

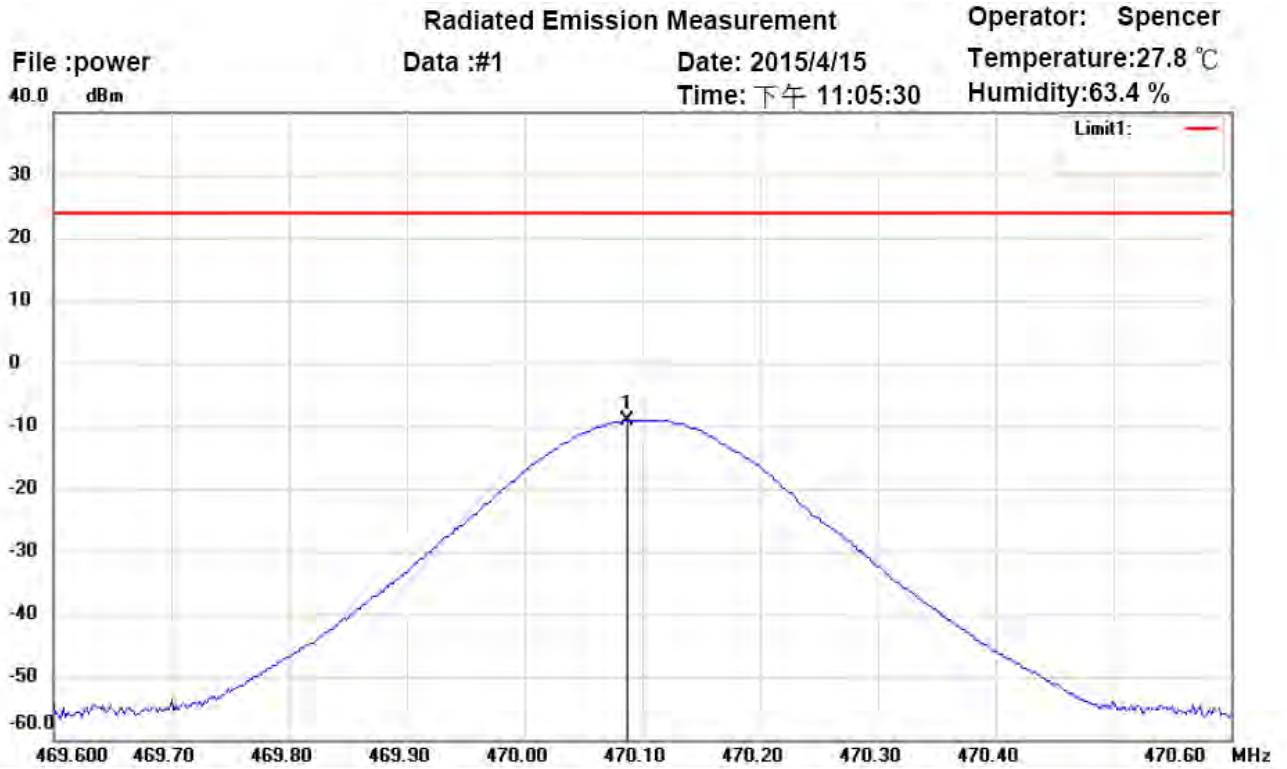

Site : Chamber

Condition : FCC 74.861 power(470-608 and 614-806)

EUT : W6M21504-14935

M/N:

Test Mode : 470.1MHz

Note :

Polarization: *Horizontal*

Power : 2.4 Vd.c.

Distance: 3m

Mk.	Frequency (MHz)	Reading (dBm)	Detector	Corr. factor (dB)	Result (dBm)	Limit (dBm)	Ant.Pos (cm)	Tab.Pos (deg.)	Margin (dB)	Comment
*	470.0870	-42.93	peak	33.73	-9.20	24.00	150	93	-33.20	





# Worldwide Testing Services(Taiwan) Co., Ltd.

Registration number: W6M21504-14935-C-1  
 FCC ID: CINSQ-6100IRDA

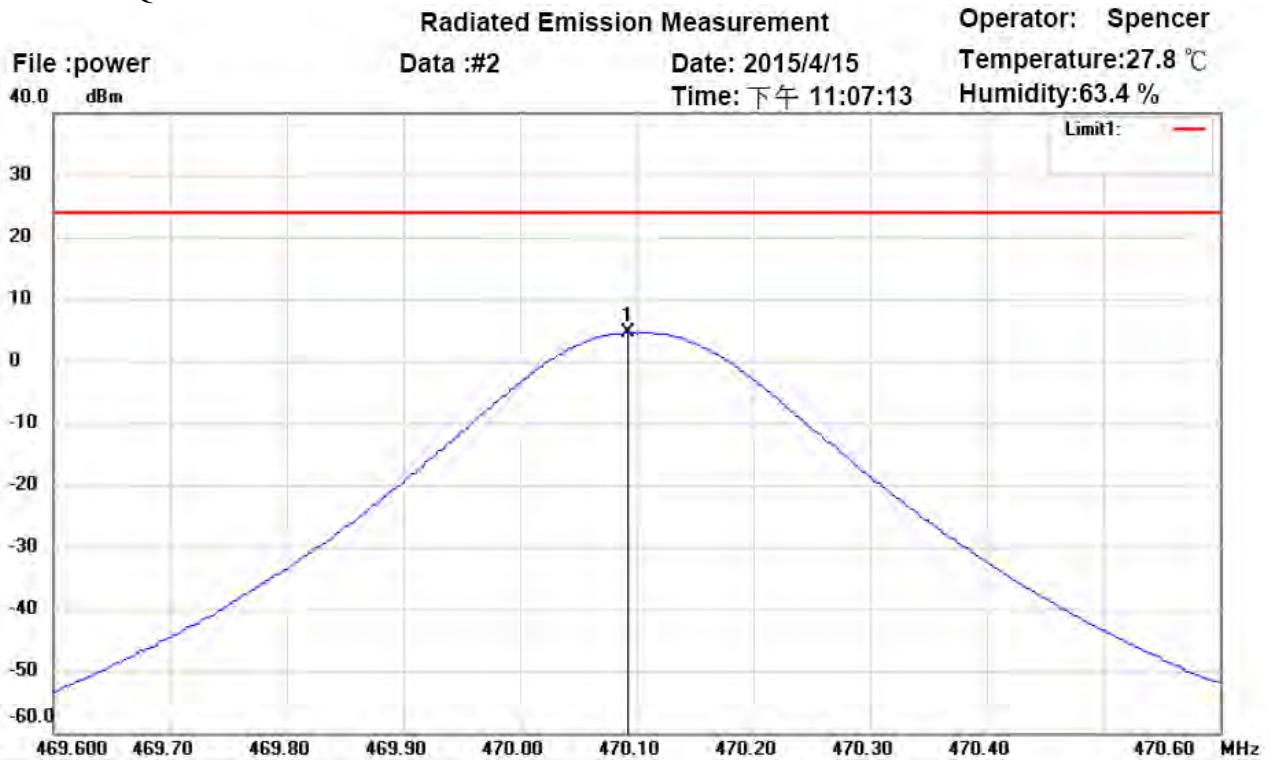

Site : Chamber

Condition : FCC 74.861 power(470-608 and 614-806)

EUT : W6M21504-14935

M/N:

Test Mode : 470.1MHz

Note :

Polarization: *Vertical*

Power : 2.4Vd.c.

Distance: 3m

Mk.	Frequency (MHz)	Reading (dBm)	Detector	Corr. factor (dB)	Result (dBm)	Limit (dBm)	Ant.Pos (cm)	Tab.Pos (deg.)	Margin (dB)	Comment
*	470.0930	-26.35	peak	30.88	4.53	24.00	150	198	-19.47	



# Worldwide Testing Services(Taiwan) Co., Ltd.

Registration number: W6M21504-14935-C-1  
 FCC ID: CINSQ-6100IRDA

## Radiated Emission Measurement

Operator: Spencer

File :power

Data :#1

Date: 2015/4/15

Temperature:27.8 °C

40.0 dBm

Time: 下午 11:00:52

Humidity:63.4 %

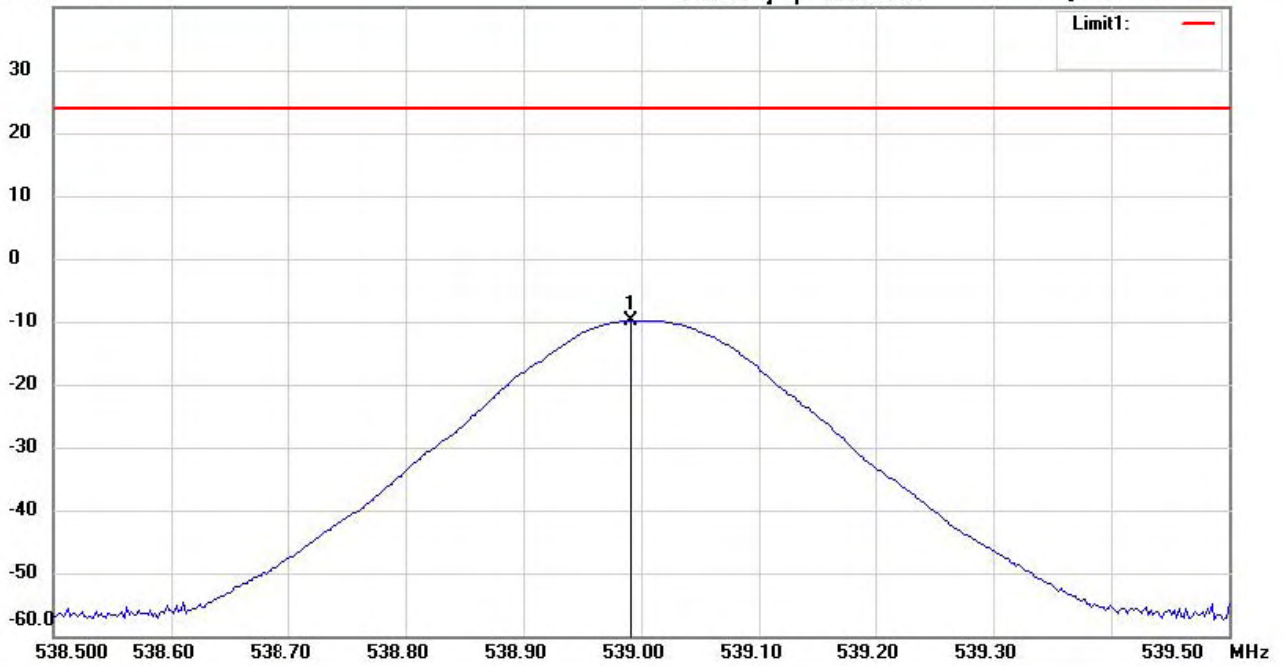

Site : Chamber

Condition : FCC 74.861 power(470-608 and 614-806)

Polarization: *Horizontal*

EUT : W6M21504-14935

Power : 2.4 Vd.c.

M/N:

Distance: 3m

Test Mode : 539MHz

Note :

Mk.	Frequency (MHz)	Reading (dBm)	Detector	Corr. factor (dB)	Result (dBm)	Limit (dBm)	Ant.Pos (cm)	Tab.Pos (deg)	Margin (dB)	Comment
*	538.9910	-42.49	peak	32.61	-9.88	24.00	150	93	-33.88	



# Worldwide Testing Services(Taiwan) Co., Ltd.

Registration number: W6M21504-14935-C-1  
 FCC ID: CINSQ-6100IRDA

## Radiated Emission Measurement

Operator: Spencer

File :power

Data :#2

Date: 2015/4/15

Temperature:27.8 °C

40.0 dBm

Time: 下午 11:02:28

Humidity:63.4 %

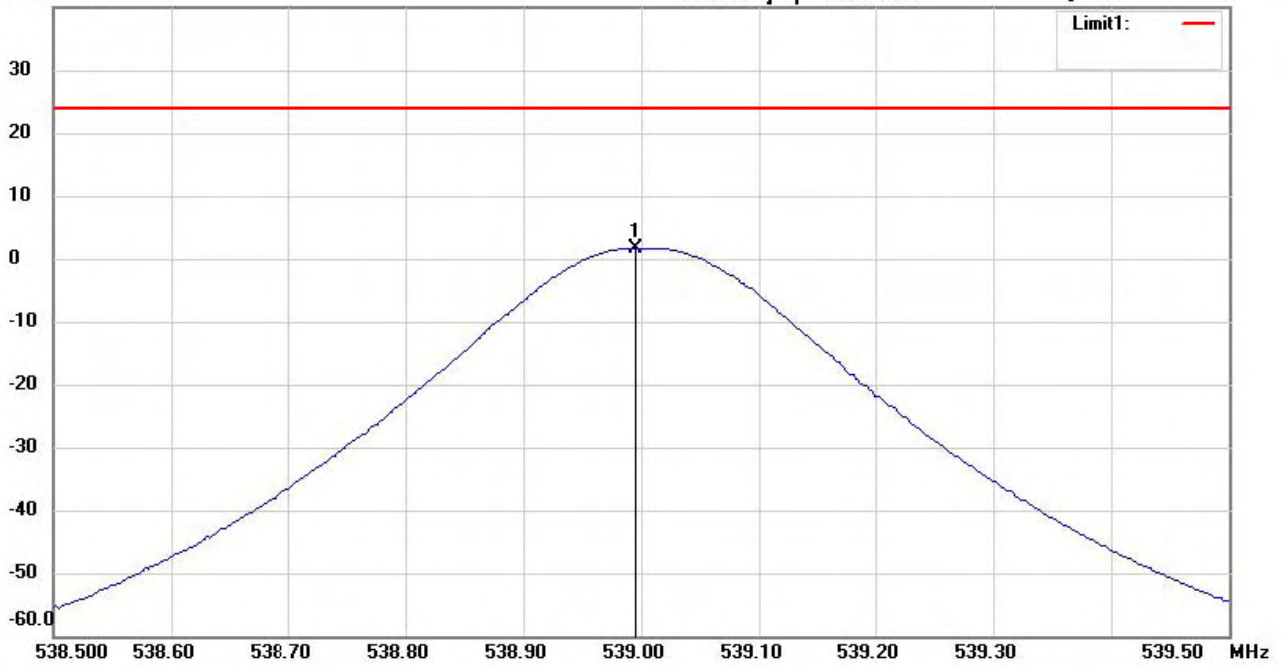

Site : Chamber

Condition : FCC 74.861 power(470-608 and 614-806)

Polarization: *Vertical*

EUT : W6M21504-14935

Power : 2.4 Vd.c.

M/N:

Distance: 3m

Test Mode : 539MHz

Note :

Mk.	Frequency (MHz)	Reading (dBm)	Detector	Corr. factor (dB)	Result (dBm)	Limit (dBm)	Ant.Pos (cm)	Tab.Pos (deg)	Margin (dB)	Comment
*	538.9950	-30.40	peak	32.07	1.67	24.00	150	206	-22.33	



# Worldwide Testing Services(Taiwan) Co., Ltd.

Registration number: W6M21504-14935-C-1  
 FCC ID: CINSQ-6100IRDA

## Radiated Emission Measurement

Operator: Spencer

File :power

Data :#1

Date: 2015/4/15

Temperature:27.8 °C

40.0 dBm

Time: 下午 10:56:36

Humidity:63.4 %

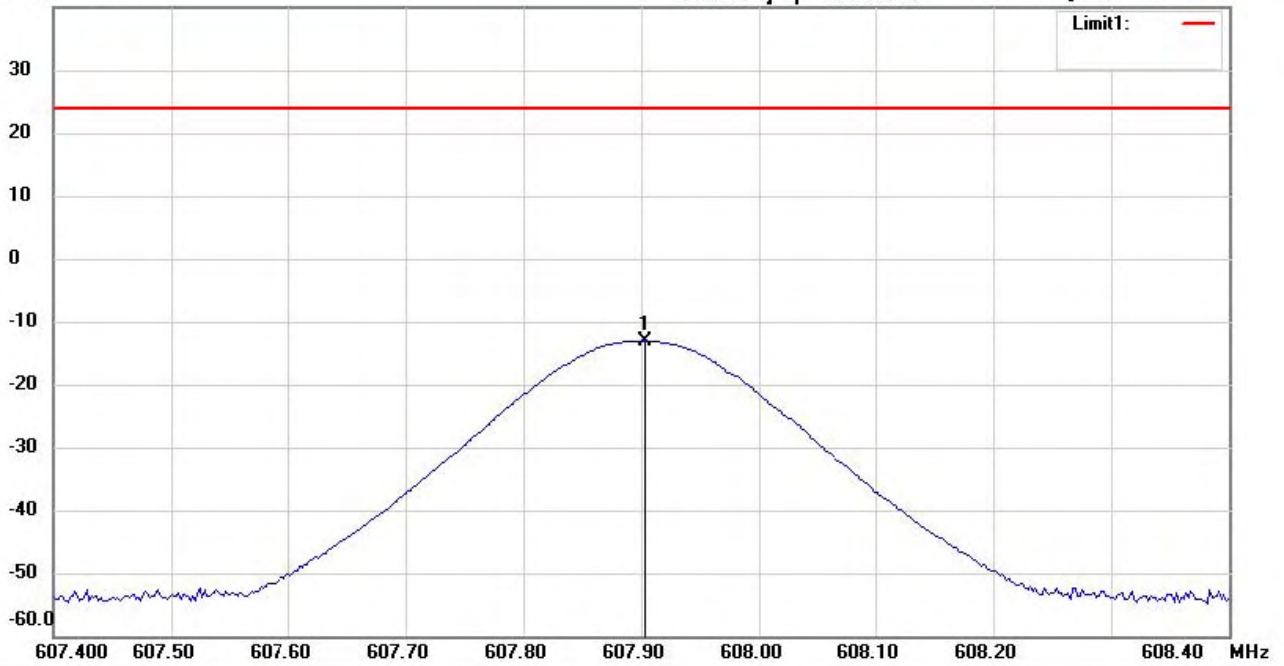

Site : Chamber

Condition : FCC 74.861 power(470-608 and 614-806)

Polarization: *Horizontal*

EUT : W6M21504-14935

Power : 2.4 Vd.c.

M/N:

Distance: 3m

Test Mode : 607.9MHz

Note :

Mk.	Frequency (MHz)	Reading (dBm)	Detector	Corr. factor (dB)	Result (dBm)	Limit (dBm)	Ant.Pos (cm)	Tab.Pos (deg)	Margin (dB)	Comment
*	607.9030	-48.08	peak	35.04	-13.04	24.00	150	103	-37.04	



# Worldwide Testing Services(Taiwan) Co., Ltd.

Registration number: W6M21504-14935-C-1  
 FCC ID: CINSQ-6100IRDA

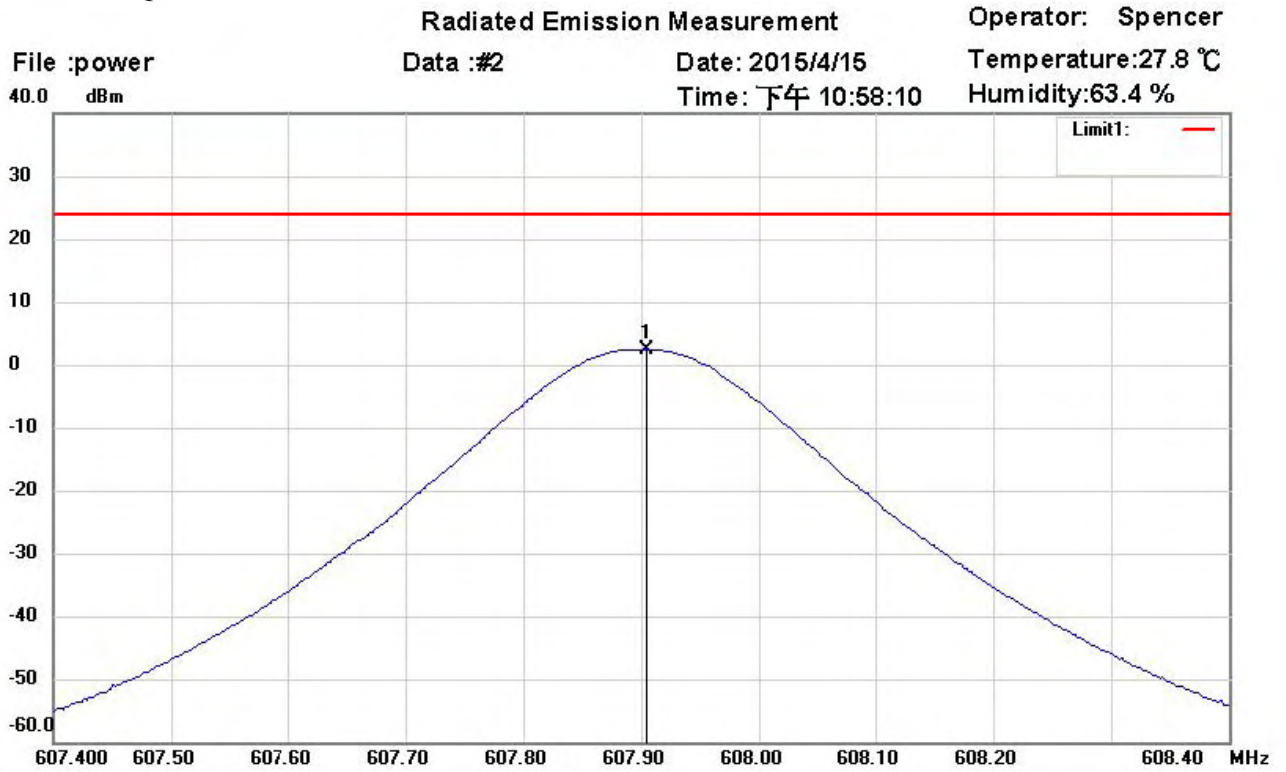

Site : Chamber

Condition : FCC 74.861 power(470-608 and 614-806)

EUT : W6M21504-14935

M/N:

Test Mode : 607.9MHz

Note :

Polarization: *Vertical*

Power : 2.4 Vd.c.

Distance: 3m

Mk.	Frequency (MHz)	Reading (dBm)	Detector	Corr. factor (dB)	Result (dBm)	Limit (dBm)	Ant.Pos (cm)	Tab.Pos (deg)	Margin (dB)	Comment
*	607.9050	-30.21	peak	32.64	2.43	24.00	150	168	-21.57	



# Worldwide Testing Services(Taiwan) Co., Ltd.

Registration number: W6M21504-14935-C-1  
 FCC ID: CINSQ-6100IRDA

### Radiated Emission Measurement

Operator: Spencer

File :power  
 40.0 dBm

Data :#1

Date: 2015/4/15

Temperature:27.8 °C

Time: 下午 10:51:35

Humidity:63.4 %

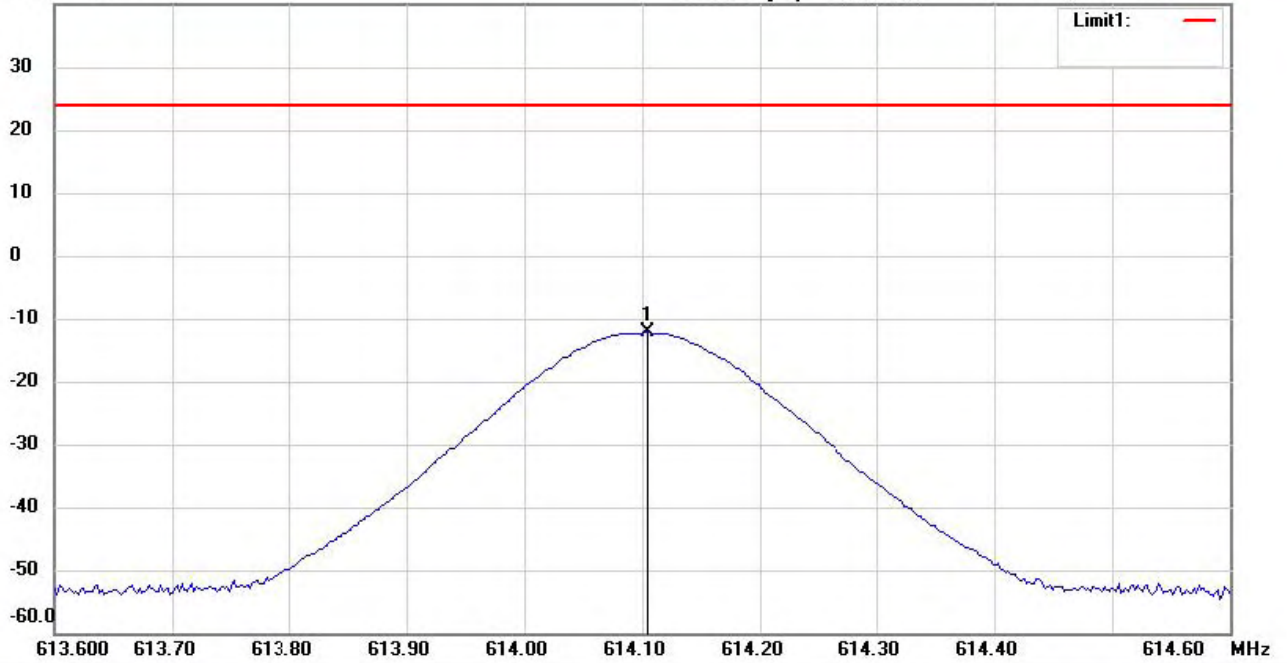

Site : Chamber

Condition : FCC 74.861 power(470-608 and 614-806)

Polarization: *Horizontal*

EUT : W6M21504-14935

Power : 2.4 Vd.c.

M/N:

Distance: 3m

Test Mode : 614.1MHz

Note :

Mk.	Frequency (MHz)	Reading (dBm)	Detector	Corr. factor (dB)	Result (dBm)	Limit (dBm)	Ant.Pos (cm)	Tab.Pos (deg)	Margin (dB)	Comment
*	614.1050	-47.47	peak	35.25	-12.22	24.00	150	196	-36.22	



# Worldwide Testing Services(Taiwan) Co., Ltd.

Registration number: W6M21504-14935-C-1  
 FCC ID: CINSQ-6100IRDA

## Radiated Emission Measurement

Operator: Spencer

File :power

Data :#2

Date: 2015/4/15

Temperature:27.8 °C

40.0 dBm

Time: 下午 10:54:05

Humidity:63.4 %

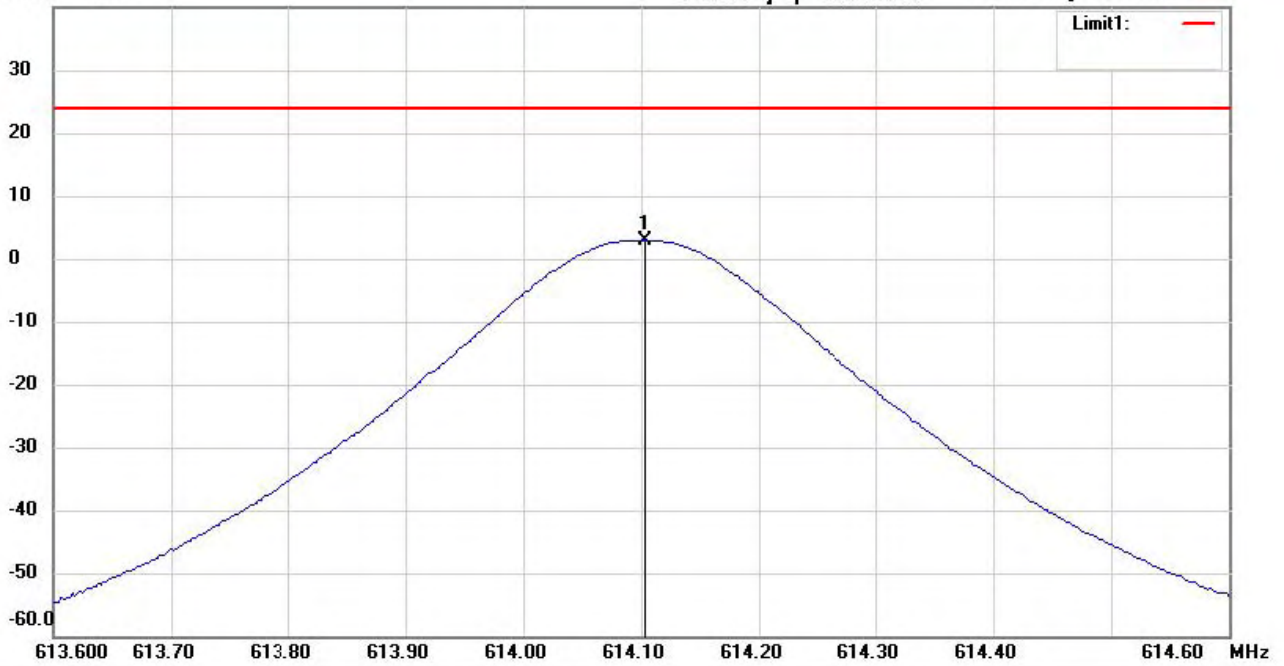

Site : Chamber

Condition : FCC 74.861 power(470-608 and 614-806)

Polarization: *Vertical*

EUT : W6M21504-14935

Power : 2.4 Vd.c.

M/N:

Distance: 3m

Test Mode : 614.1MHz

Note :

Mk.	Frequency (MHz)	Reading (dBm)	Detector	Corr. factor (dB)	Result (dBm)	Limit (dBm)	Ant.Pos (cm)	Tab.Pos (deg)	Margin (dB)	Comment
*	614.1030	-29.81	peak	32.73	2.92	24.00	150	88	-21.08	



# Worldwide Testing Services(Taiwan) Co., Ltd.

Registration number: W6M21504-14935-C-1  
 FCC ID: CINSQ-6100IRDA

## Radiated Emission Measurement

Operator: Spencer

File :power

Data :#1

Date: 2015/4/15

Temperature:27.8 °C

40.0 dBm

Time: 下午 10:46:17

Humidity:63.4 %

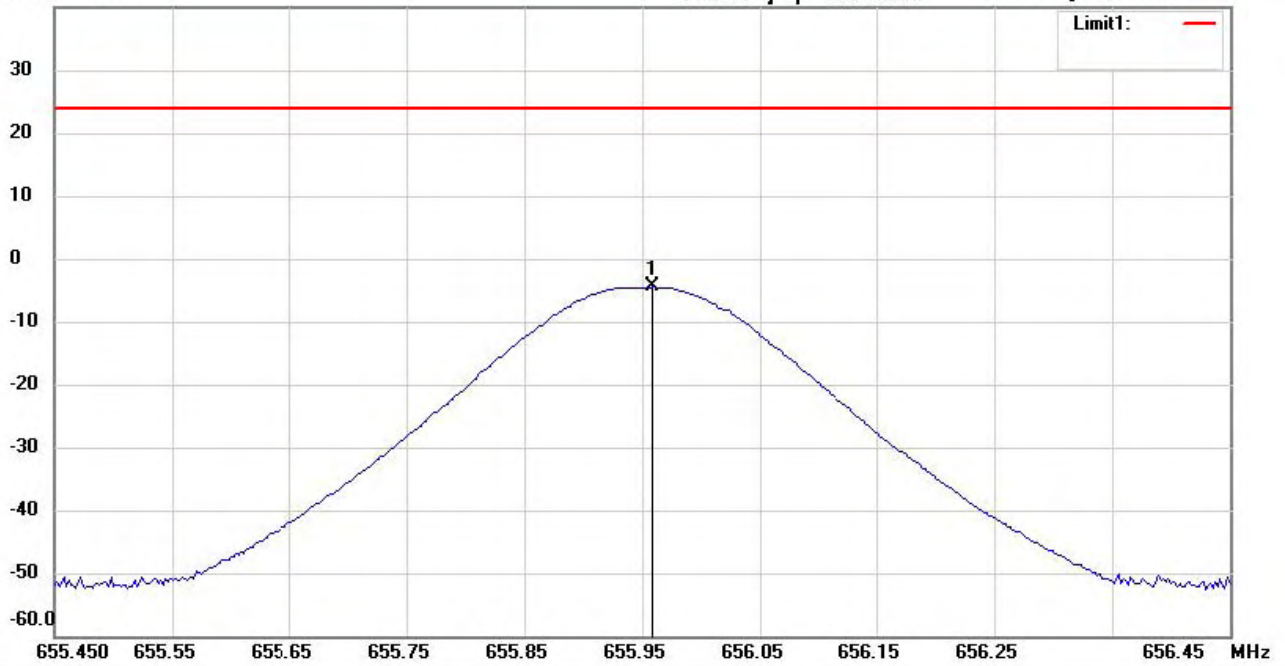

Site : Chamber

Condition : FCC 74.861 power(470-608 and 614-806)

Polarization: *Horizontal*

EUT : W6M21504-14935

Power : 2.4 Vd.c.

M/N:

Distance: 3m

Test Mode : 655.95MHz

Note :

Mk.	Frequency (MHz)	Reading (dBm)	Detector	Corr. factor (dB)	Result (dBm)	Limit (dBm)	Ant.Pos (cm)	Tab.Pos (deg)	Margin (dB)	Comment
*	655.9590	-41.11	peak	36.62	-4.49	24.00	150	299	-28.49	





# Worldwide Testing Services(Taiwan) Co., Ltd.

Registration number: W6M21504-14935-C-1  
 FCC ID: CINSQ-6100IRDA

## Radiated Emission Measurement

Operator: Spencer

File :power

Data :#2

Date: 2015/4/15

Temperature:27.8 °C

40.0 dBm

Time: 下午 10:47:54

Humidity:63.4 %

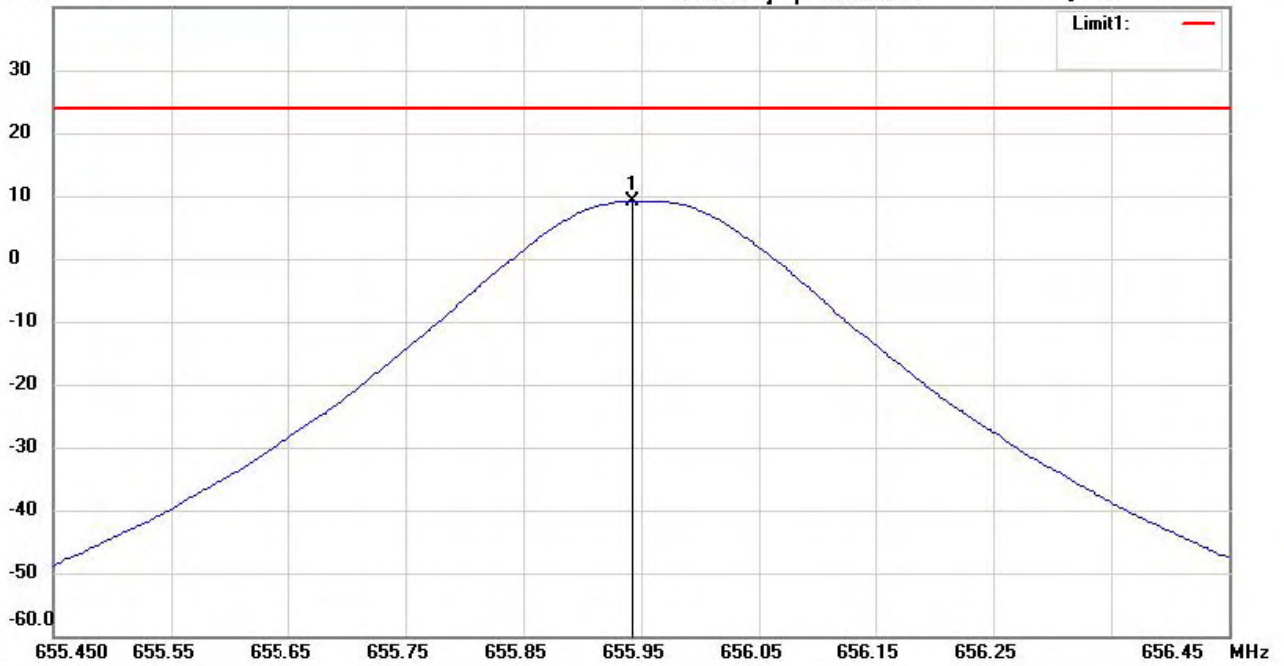

Site : Chamber

Condition : FCC 74.861 power(470-608 and 614-806)

Polarization: *Vertical*

EUT : W6M21504-14935

Power : 2.4 Vd.c.

M/N:

Distance: 3m

Test Mode : 655.95MHz

Note :

Mk.	Frequency (MHz)	Reading (dBm)	Detector	Corr. factor (dB)	Result (dBm)	Limit (dBm)	Ant.Pos (cm)	Tab.Pos (deg)	Margin (dB)	Comment
*	655.9430	-24.17	peak	33.38	9.21	24.00	150	198	-14.79	



# Worldwide Testing Services(Taiwan) Co., Ltd.

Registration number: W6M21504-14935-C-1  
 FCC ID: CINSQ-6100IRDA

## Radiated Emission Measurement

Operator: Spencer

File :power

Data :#1

Date: 2015/4/15

Temperature:27.8 °C

40.0 dBm

Time: 下午 10:38:59

Humidity:63.4 %

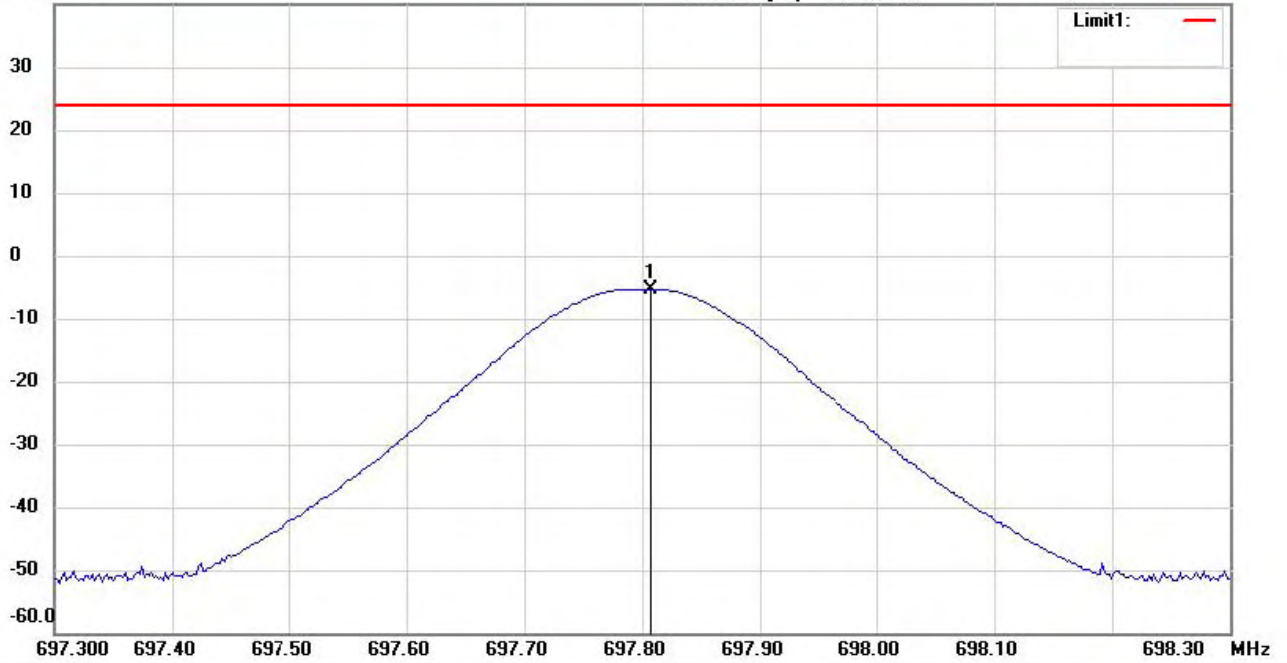

Site : Chamber

Condition : FCC 74.861 power(470-608 and 614-806)

Polarization: *Horizontal*

EUT : W6M21504-14935

Power : 2.4 Vd.c.

M/N:

Distance: 3m

Test Mode : 697.8MHz

Note :

Mk.	Frequency (MHz)	Reading (dBm)	Detector	Corr. factor (dB)	Result (dBm)	Limit (dBm)	Ant.Pos (cm)	Tab.Pos (deg)	Margin (dB)	Comment
*	697.8070	-42.94	peak	37.61	-5.33	24.00	150	106	-29.33	



# Worldwide Testing Services(Taiwan) Co., Ltd.

Registration number: W6M21504-14935-C-1  
 FCC ID: CINSQ-6100IRDA

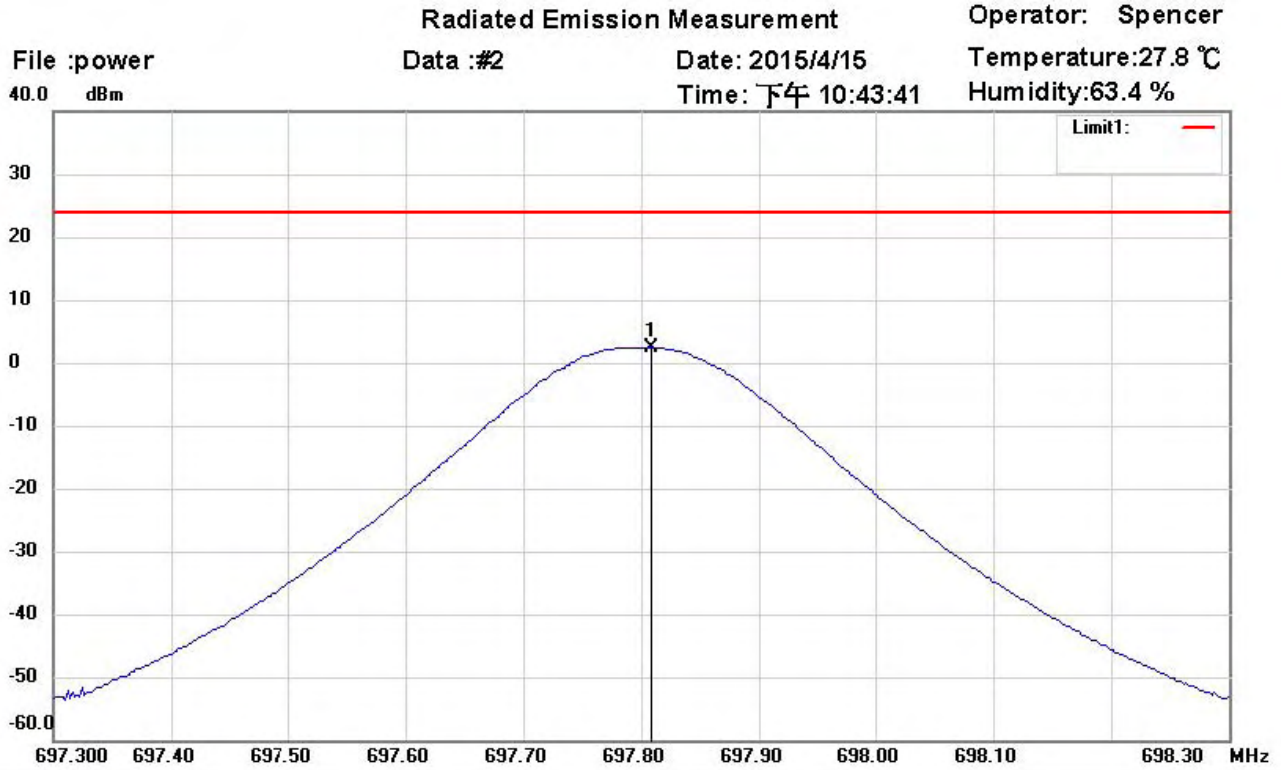

Site : Chamber  
 Condition : FCC 74.861 power(470-608 and 614-806)  
 EUT : W6M21504-14935  
 M/N:  
 Test Mode : 697.8MHz  
 Note :

Polarization: *Vertical*  
 Power : 2.4 Vd.c.  
 Distance: 3m

Mk.	Frequency (MHz)	Reading (dBm)	Detector	Corr. factor (dB)	Result (dBm)	Limit (dBm)	Ant.Pos (cm)	Tab.Pos (deg)	Margin (dB)	Comment
*	697.8090	-31.95	peak	34.32	2.37	24.00	150	187	-21.63	

Test equipment used: ETSTW-RE 004, ETSTW-RE 122, ETSTW-RE 042, ETSTW-RE 043



Registration number: W6M21504-14935-C-1

FCC ID: CINSQ-6100IRDA

**6 Modulation Deviation , FCC 2.1047 (b) ; 74.861(e)**

**6.1 Test procedure**

Modulation limiting is the transmitter circuit's ability to limit the transmitter from producing deviations in excess of rated system deviation.

The audio signal generator is connected to the audio input of the EUT with its full rating.

The modulation response is measured at certain modulation frequencies, related to 1000Hz reference signal. Tests are performed for positive and negative modulation.

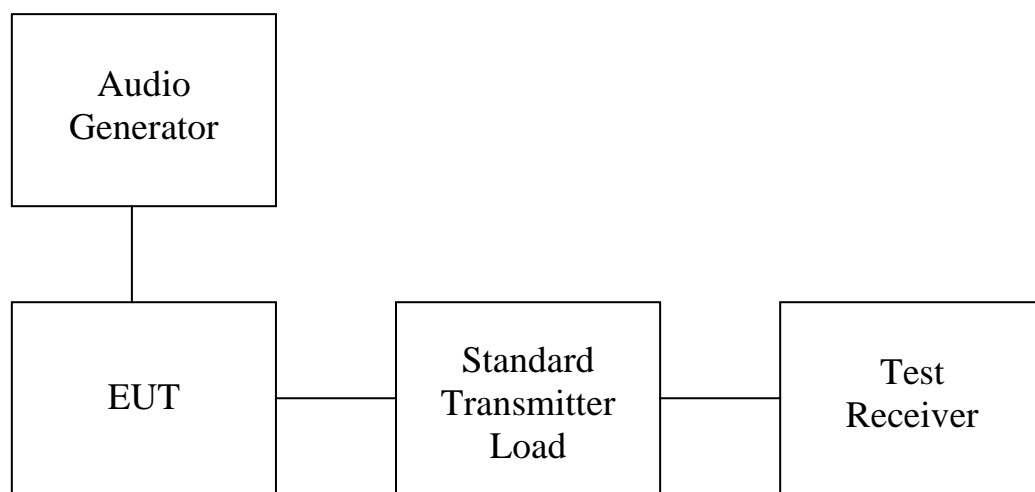

**6.2 Test results**

Explanation: Please see attached diagrams as appendix.

Limits :  $\pm 75$  kHz

Test equipment used: ETSTW-RE 072, ETSTW-RE 055, ETSTW-RE 050



Registration number: W6M21504-14935-C-1

FCC ID: CINSQ-6100IRDA

**7 Audio frequency response , FCC 2.1047 (a)**

**7.1 Test procedure**

The audio frequency response is the degree of closeness to which the frequency deviation of the transmitter follows a prescribed characteristic.

The frequency response of the audio modulation part is measured over a frequency range of 100 Hz to 5000 Hz.

For 1000 Hz tone reference signal the audio generator level is adjusted to get 20% of the rated system deviation.

The deviations obtained over the frequency range from 100 Hz to 5000 Hz are recorded and compared with the reference deviation as follows :

$$\text{Audio Frequency Response} = 20 \log [ \text{DEV}_{\text{Freq}} / \text{DEV}_{\text{ref}} ].$$

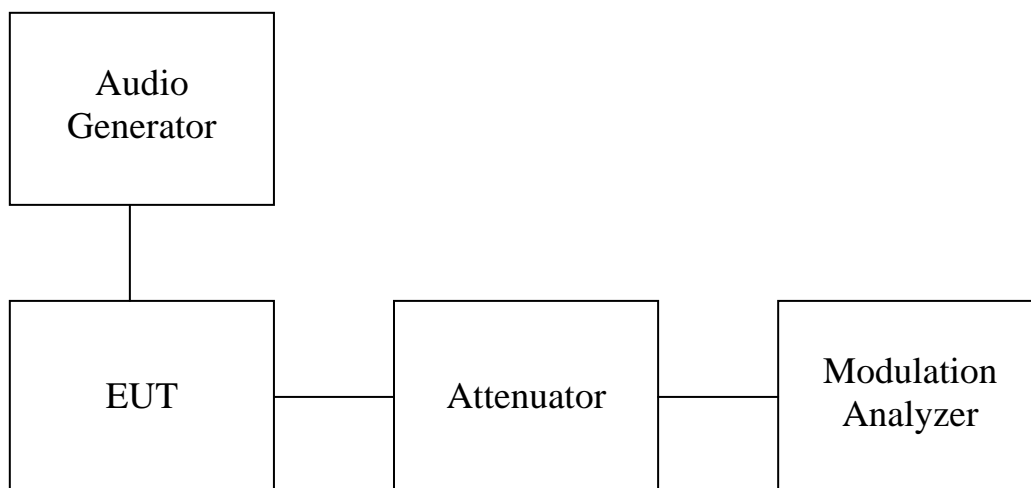

**7.2 Test results**

Explanation: Please see attached diagrams as appendix.

Test equipment used: ETSTW-RE 072



Registration number: W6M21504-14935-C-1

FCC ID: CINSQ-6100IRDA

## 8 Occupied Bandwidth/Emission Mask, FCC 2.1049 (c) ; 74.861 (e)(5)

The occupied bandwidth, that is the frequency bandwidth such that, below its lower and above its upper frequency limits, the mean powers radiated are each equal to 0.5 percent of the total mean power. Near the carrier an Emission Mask is defined by the standard.

### 8.1 Test procedure

The RF output of the transceiver was connected to the input of the spectrum analyzer through sufficient attenuation.

Occupied Bandwidth was measured with a occupied bandwidth function of the analyzer.

The near the carrier emissions are measured by normal power measurement function of the analyzer.

### 8.2 Test Results

Occupied Bandwidth

1 kHz

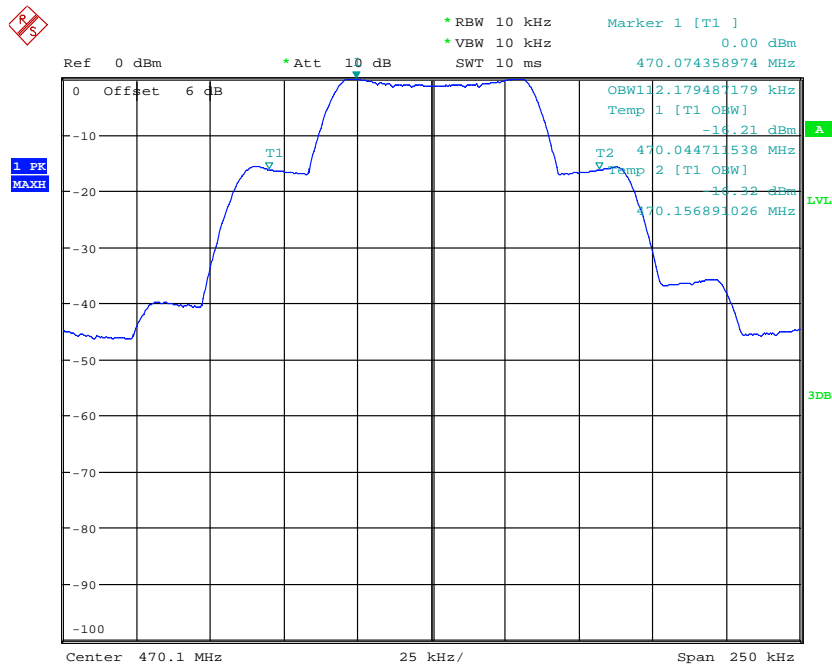

OCCUPIED BANDWIDTH 470.1MHZ 1KHZ  
 Date: 15.APR.2015 00:57:04

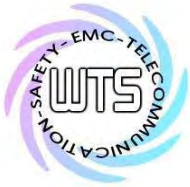

# Worldwide Testing Services(Taiwan) Co., Ltd.

Registration number: W6M21504-14935-C-1

FCC ID: CINSQ-6100IRDA

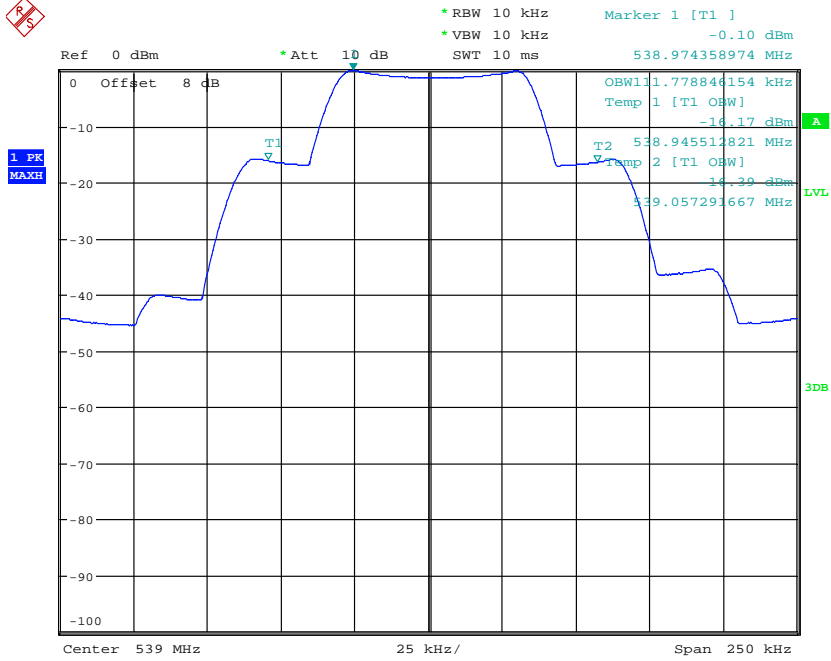

OCCUPIED BANDWIDTH 539MHZ 1KHZ

Date: 15.APR.2015 00:53:27

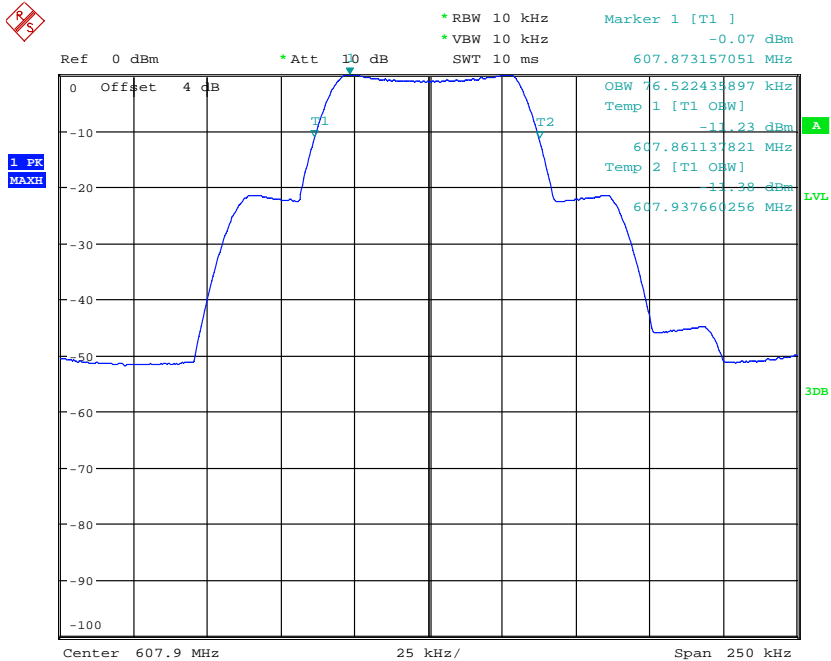

OCCUPIED BANDWIDTH 607.9MHZ 1KHZ

Date: 15.APR.2015 00:46:44

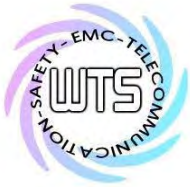

# Worldwide Testing Services(Taiwan) Co., Ltd.

Registration number: W6M21504-14935-C-1

FCC ID: CINSQ-6100IRDA

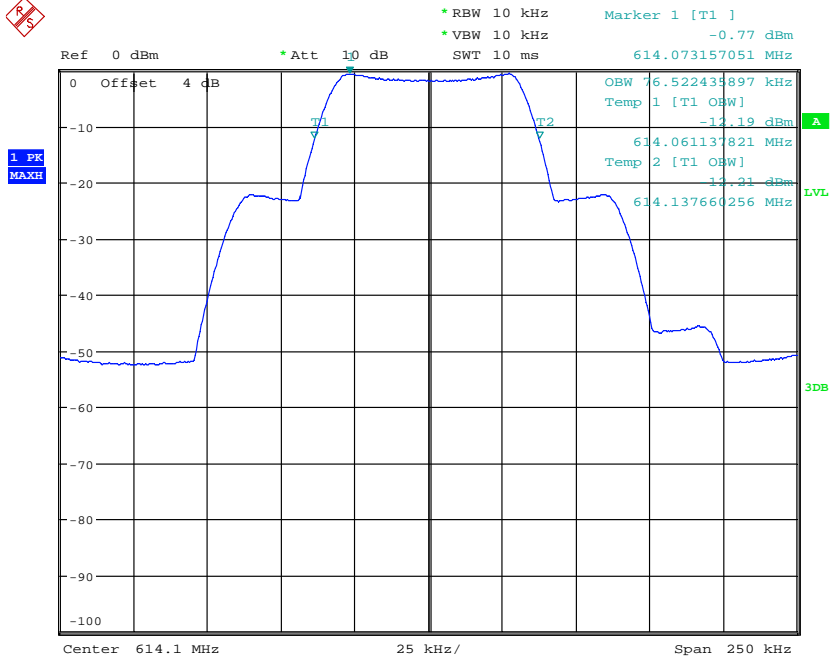

OCCUPIED BANDWIDTH 614.1MHZ 1KHZ

Date: 15.APR.2015 00:45:03

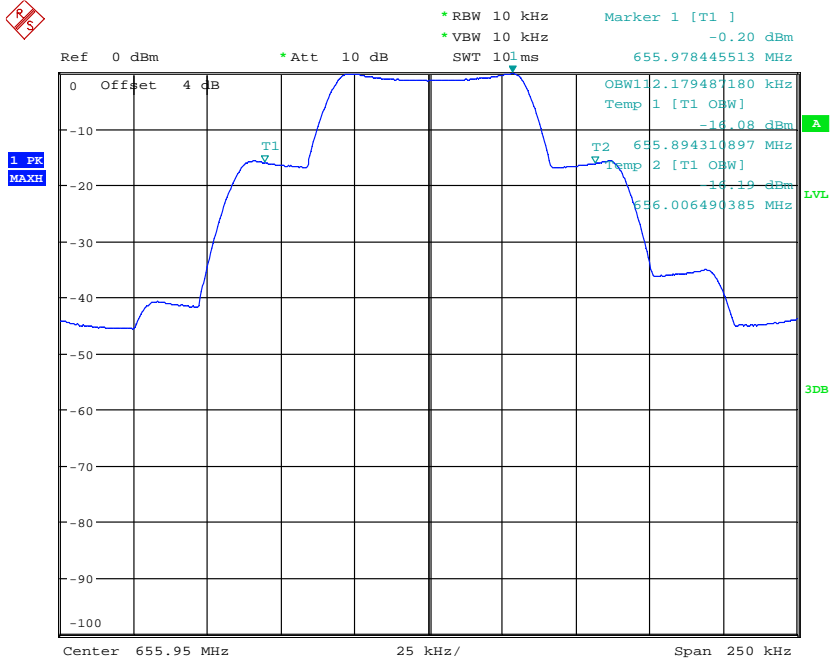

OCCUPIED BANDWIDTH 655.95MHZ 1KHZ

Date: 15.APR.2015 00:51:03





# Worldwide Testing Services(Taiwan) Co., Ltd.

Registration number: W6M21504-14935-C-1

FCC ID: CINSQ-6100IRDA

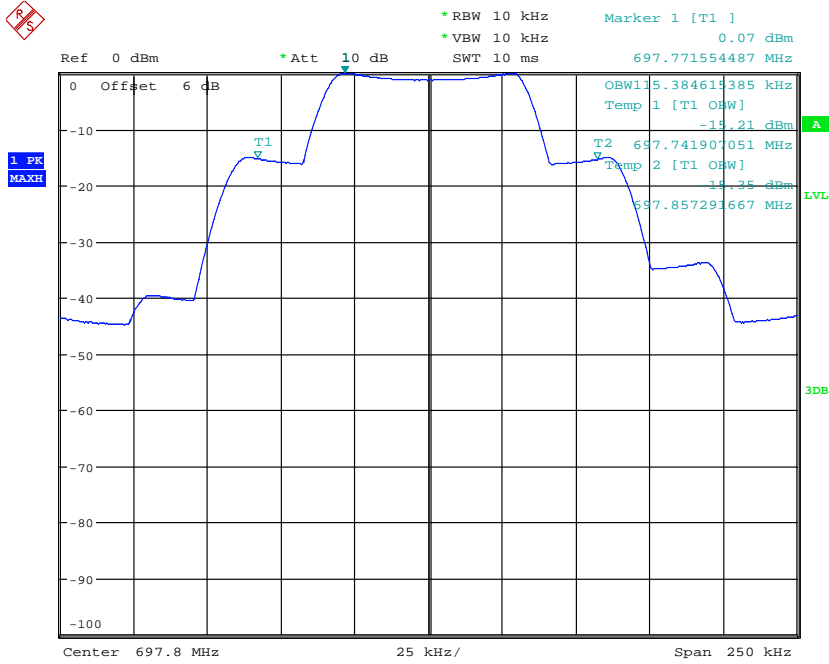

OCCUPIED BANDWIDTH 697.8MHZ 1KHZ

Date: 15.APR.2015 00:59:22

2.5 kHz

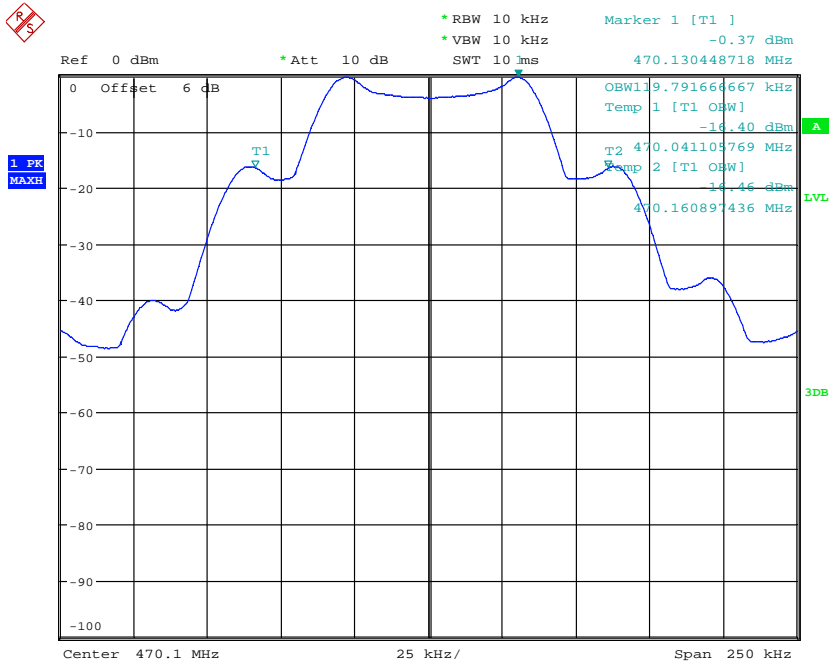

OCCUPIED BANDWIDTH 470.1MHZ 2.5KHZ

Date: 15.APR.2015 00:56:15



# Worldwide Testing Services(Taiwan) Co., Ltd.

Registration number: W6M21504-14935-C-1

FCC ID: CINSQ-6100IRDA

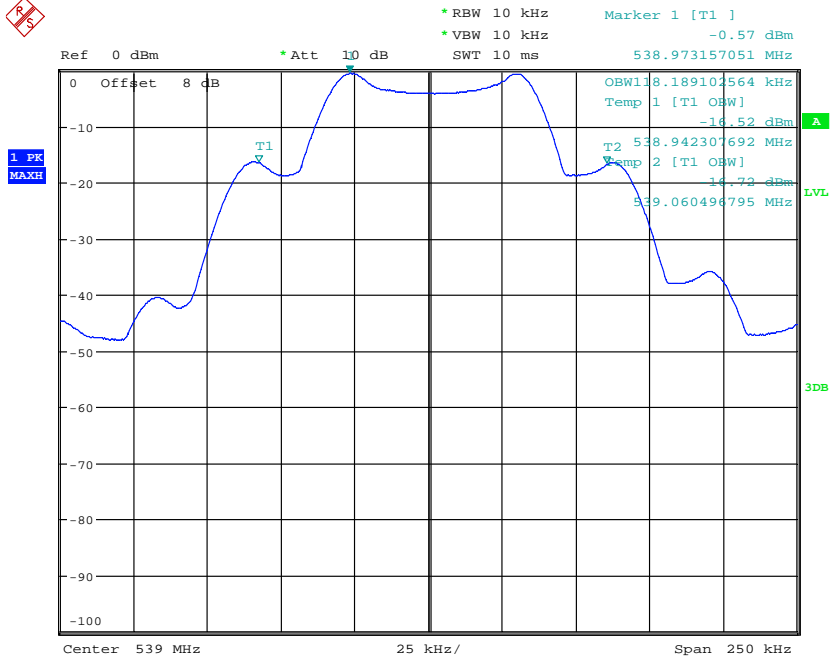

OCCUPIED BANDWIDTH 539MHZ 2.5KHZ

Date: 15.APR.2015 00:53:51

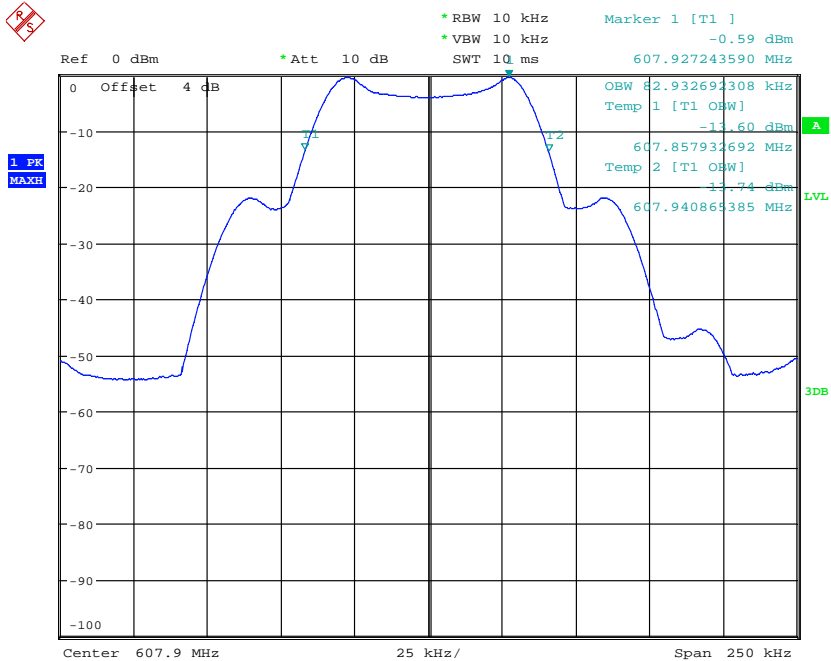

OCCUPIED BANDWIDTH 607.9MHZ 2.5KHZ

Date: 15.APR.2015 00:47:27



# Worldwide Testing Services(Taiwan) Co., Ltd.

Registration number: W6M21504-14935-C-1

FCC ID: CINSQ-6100IRDA

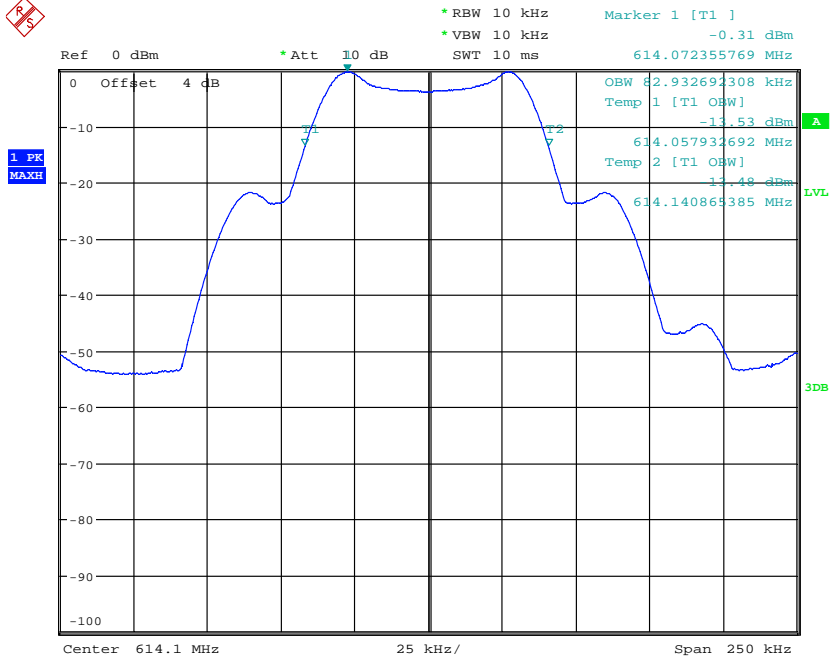

OCCUPIED BANDWIDTH 614.1MHZ 2.5KHZ

Date: 15.APR.2015 00:43:54

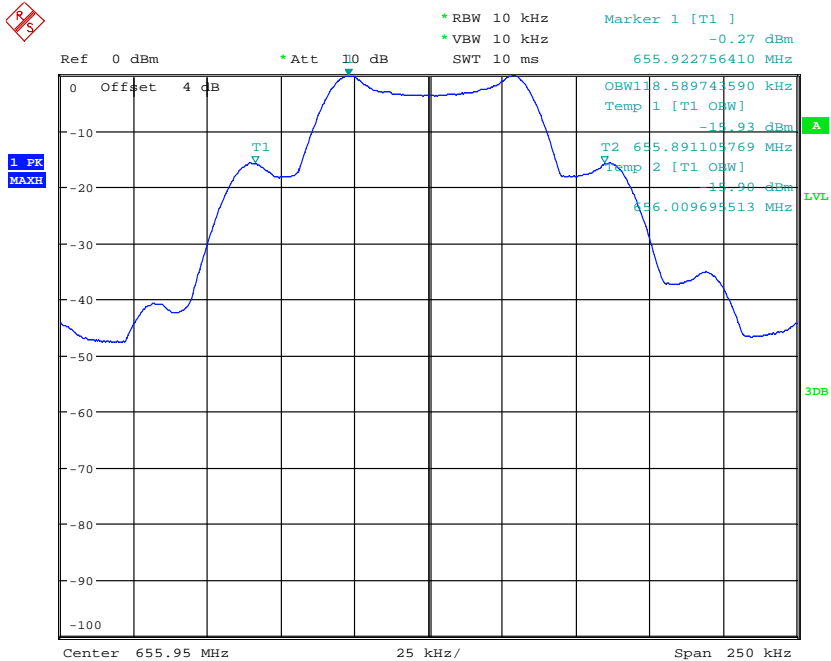

OCCUPIED BANDWIDTH 655.95MHZ 2.5KHZ

Date: 15.APR.2015 00:49:59



# Worldwide Testing Services(Taiwan) Co., Ltd.

Registration number: W6M21504-14935-C-1

FCC ID: CINSQ-6100IRDA

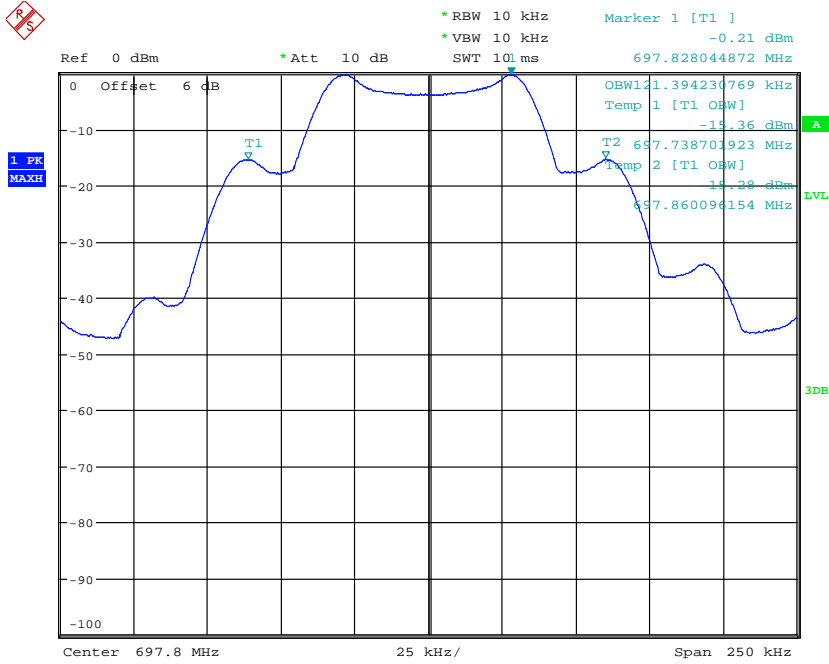

OCCUPIED BANDWIDTH 697.8MHZ 2.5KHZ

Date: 15.APR.2015 00:59:45

## Emission Mask

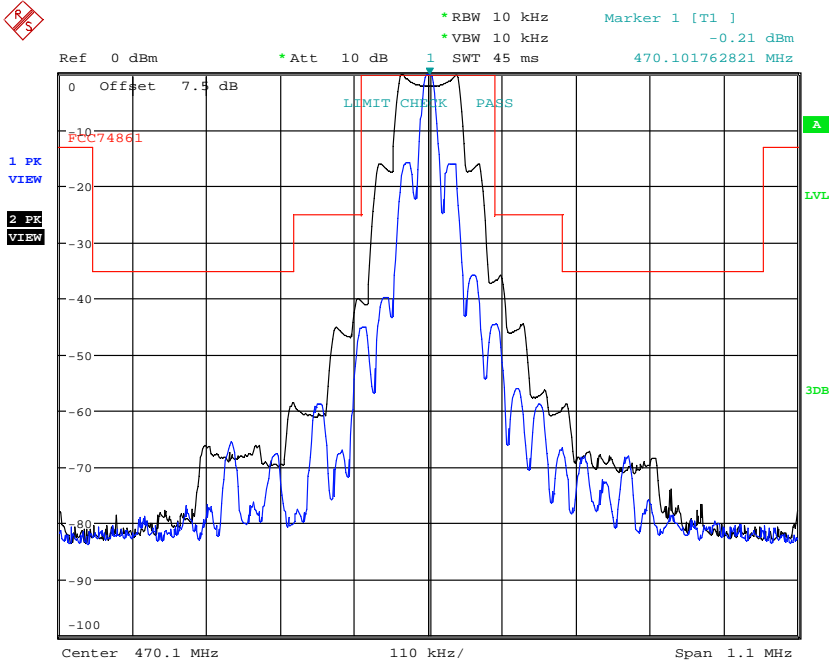

EMISSION MASK 470.1MHZ

Date: 14.APR.2015 20:16:54



# Worldwide Testing Services(Taiwan) Co., Ltd.

Registration number: W6M21504-14935-C-1

FCC ID: CINSQ-6100IRDA

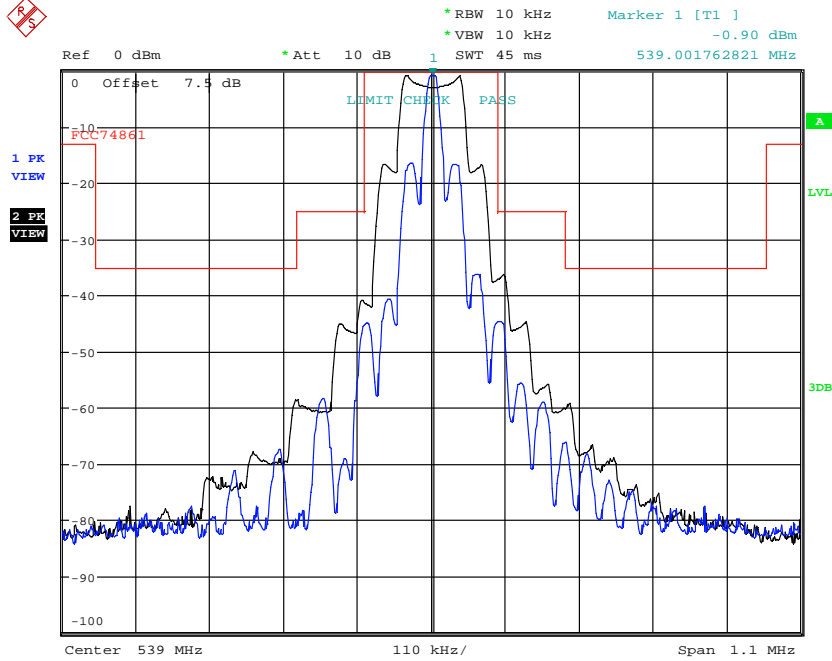

EMISSION MASK 539MHZ  
Date: 14.APR.2015 20:24:44

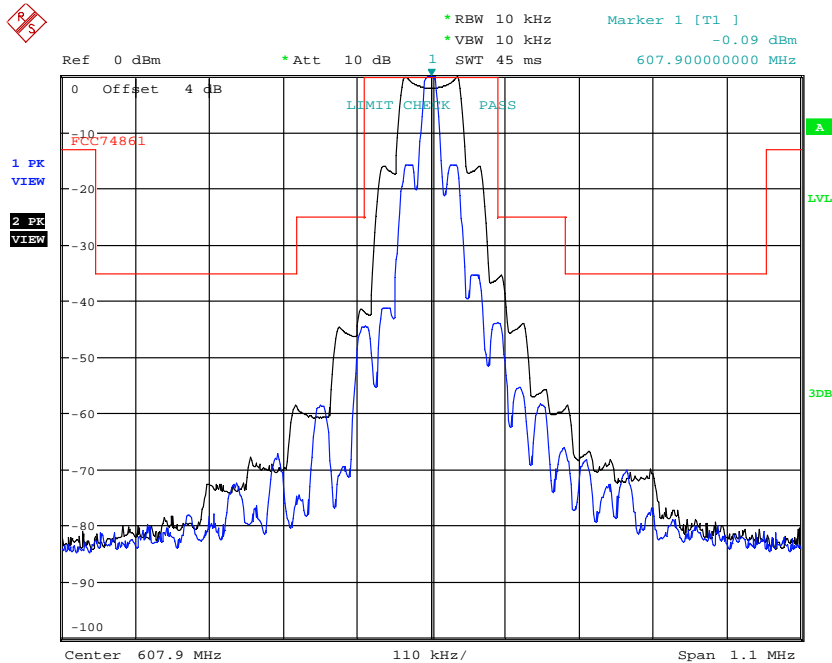

EMISSION MASK 607.9MHZ  
Date: 15.APR.2015 00:24:14

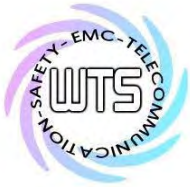

# Worldwide Testing Services(Taiwan) Co., Ltd.

Registration number: W6M21504-14935-C-1

FCC ID: CINSQ-6100IRDA

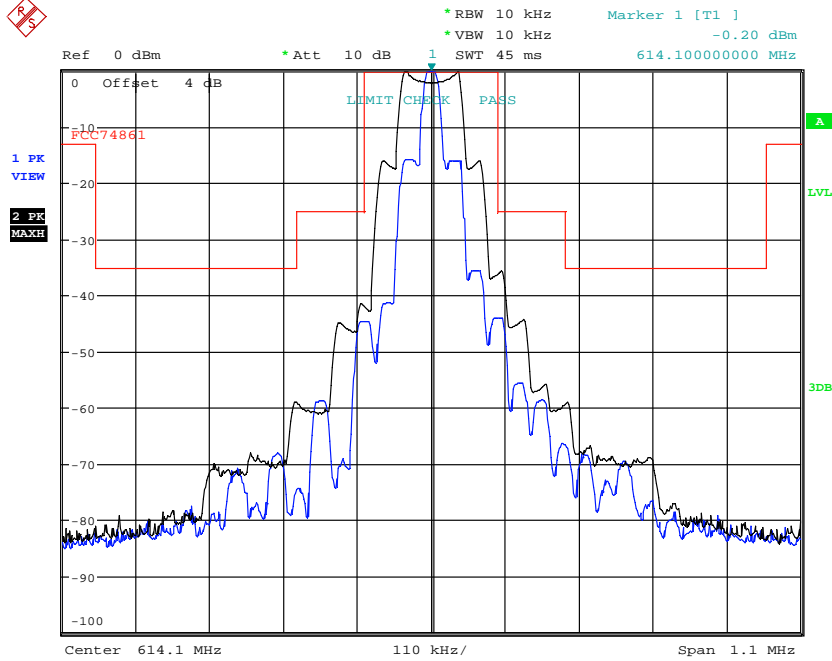

EMISSION MASK 614.1MHZ

Date: 15.APR.2015 00:16:00

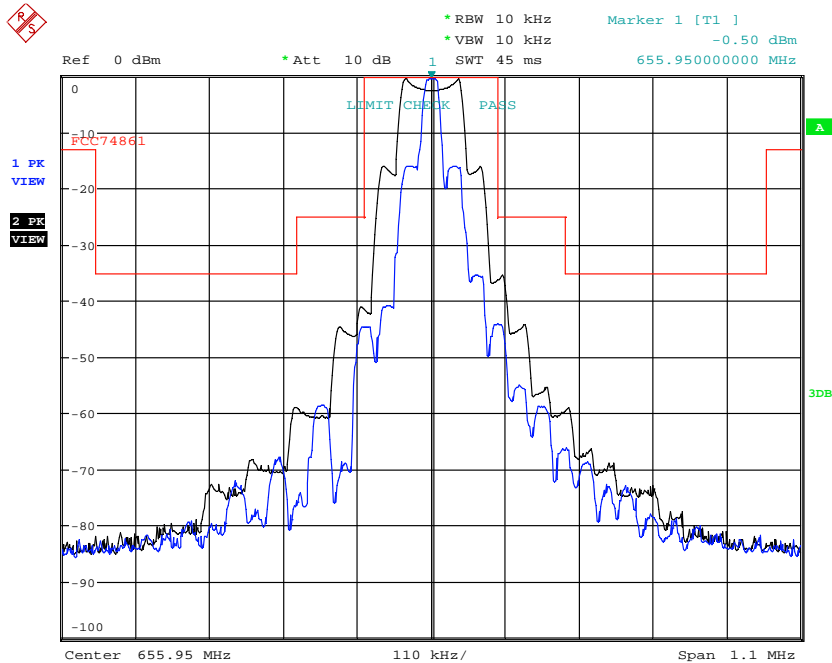

EMISSION MASK 655.95MHZ

Date: 15.APR.2015 00:00:14

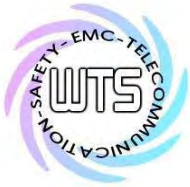

Registration number: W6M21504-14935-C-1

FCC ID: CINSQ-6100IRDA

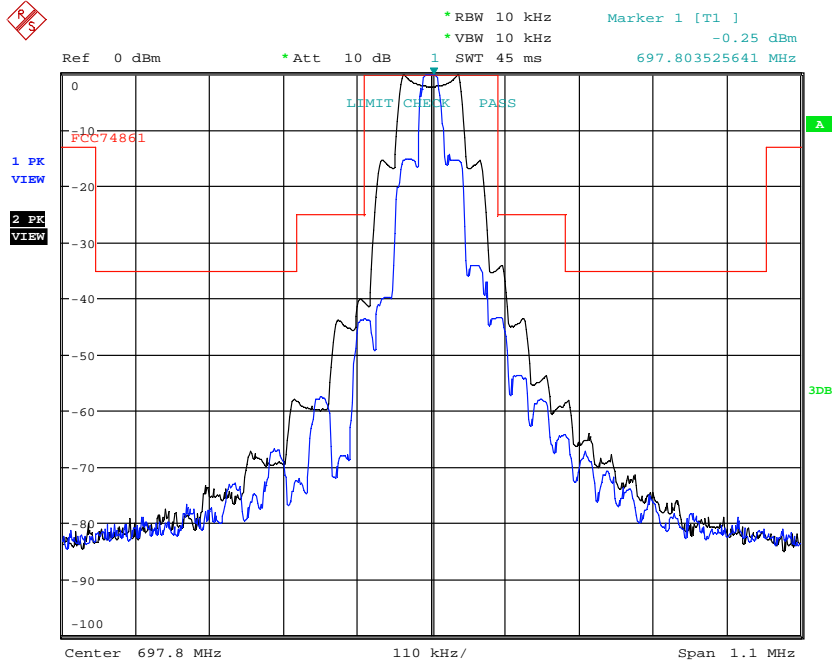

EMISSION MASK 697.8MHZ  
Date: 14.APR.2015 23:56:39

### 8.3 Limit

The operating bandwidth shall not exceed 200 kHz.

Test equipment used: ETSTW-RE 055 , ETSTW-RE 072, ETSTW-RE 050



Registration number: W6M21504-14935-C-1

FCC ID: CINSQ-6100IRDA

**9 Spurious Emissions at Antenna Terminals FCC2.1051 ; 74.861 (e)**

**9.1 Test procedure**

This transmitter output was connected to a calibrated coaxial attenuator, the other end of which was connected to a spectrum analyzer. Transmitter output was derived with the spectrum analyzer in dBm.

The Spurious Emissions at Antenna Terminals was measured by the spectrum analyzer with a suitable notch filter and high-pass filter.

Tests were performed with an un-modulated carrier at three frequencies (low , middle and high channels ) and on all power levels , which can be set-up on the transmitters.

**9.2 Test Results**

**Summary table with conducted data of the test plots for Carrier Test Frequency**

Frequency Marker Indication [MHz]	Indication Power Level [dBm]	Compliance Limit [dBm]	Margin
--	--	--	--
--	--	--	--

**9.3 Limit**

Compliance with § 74.861 requires that any emission be attenuated below the transmitter power at least  $43 + 10 \log_{10} P$  ( P = transmitter power in Watts ).

The compliance limit was calculated as an example per the following table :

Maximum transmitter output power	9.21 dBm
Required attenuation	$43 + 10 \log_{10} 0.00834 \text{ W} = 22.21 \text{ dB}$
Maximum transmitter output power	9.21 dBm
<u>Required attenuation</u>	<u>22.21 dB</u>
Compliance limit	-13 dBm

Test equipment used: ETSTW-RE 055, ETSTW-RE 050





Registration number: W6M21504-14935-C-1

FCC ID: CINSQ-6100IRDA

## **10 Radiated Spurious Emission , FCC 2.1053 ; 74.861 (e)**

### **10.1 Test procedure**

The EUT was positioned on a non-conductive turntable , 0.8m above the ground plane.

The radiated emission at the fundamental frequency was measured at 3 m distance with a test antenna and spectrum analyzer.

Worst case emission was recorded with the rotation of the turntable and the raising and lowering of the test antenna.

ERP was measured using a substitution method. The EUT was replaced by reference antenna connected to a signal generator.

The test of spurious radiated emission have been carried out with the ESK-Software from Rode & Schwarz. The measurements below 1GHz were performed with a measurement bandwidth of 100kHz, above 1GHz with a bandwidth of 1 MHz.

Spurious emission limits near the carrier are defined by a emission mask. This measurements are done in conducted mode.

### **10.2 Test Results**

The measurements of the spurious emission at the upper , center and lower channel.

The measurement diagrams show that all significant spurs are well below the limit line.

#### **Summary table with radiated data of the test plots for Carrier Test Frequency**

Model: --	Date: --						
Mode: --	Temperature: -- °C	Engineer: --					
Polarization: Horizontal	Humidity: -- %						

Frequency (MHz)	Reading (dBm) Peak	Factor (dB) Corr.	Result (dBm)	Limit (dBm)	Margin (dB)	Table Degree (Deg.)	Ant. High (cm)
--	--	--	--	--	--	--	--
--	--	--	--	--	--	--	--

Polarization: Vertical							
------------------------	--	--	--	--	--	--	--

Frequency (MHz)	Reading (dBm) Peak	Factor (dB) Corr.	Result (dBm)	Limit (dBm)	Margin (dB)	Table Degree (Deg.)	Ant. High (cm)
--	--	--	--	--	--	--	--
--	--	--	--	--	--	--	--

**Note:**

1. **Correction Factor = Antenna Gain + Cable Loss + Amplifier Gain**
2. **The formula of measured value as: Test Result = Reading + Correction Factor**
3. **All not in the table noted test results are more than 20 dB below the relevant limits.**
4. **Measurement uncertainty: 30-200MHz : ±2.84 dB, 200-1000MHz : ±2.84 dB, 1-18GHz : ±3.31 dB; Reported uncertainties represent expanded uncertainties expressed at approximately the 95% confidence level using a coverage factor of k = 2.**
5. **See the attached diagram as appendix.**



Registration number: W6M21504-14935-C-1

FCC ID: CINSQ-6100IRDA

### **10.3 Explanation of test result**

The measurements of the spurious emissions at the equipment output terminals were performed pursuant to the test procedure above in order to verify that any emissions are below the limits given by § 74.861 (6).

Calculation of test results :

Such factors like antenna correction , cable loss , external attenuation etc. are already included in the provided measurement results. This is done by using validated test software and calibrated test system according the accreditation requirements.

In the Table being listed the critical peak and average value an exhibit the compliance with the above calculated Limits.

### **10.4 Limits**

Compliance with § 74.861 requires that any emission be attenuated below the transmitter power at least  $43 + 10 \log_{10} P$  ( P = transmitter power in Watts ).

The compliance limit was calculated as an example per the following table :

Maximum transmitter output power	9.21 dBm
Required attenuation	$43 + 10 \log_{10} 0.00834 \text{ W} = 22.21 \text{ dB}$
Maximum transmitter output power	9.21 dBm
<u>Required attenuation</u>	<u>22.21 dB</u>
Compliance limit	-13 dBm

Test equipment used: ETSTW-RE 004, ETSTW-RE 122, ETSTW-RE 030,  
ETSTW-RE 042, ETSTW-RE 043, ETSTW-RE 044

Explanation : See attached diagrams in appendix.



Registration number: W6M21504-14935-C-1

FCC ID: CINSQ-6100IRDA

**11 Line Conducted Emission , FCC 15.207**

**11.1 Test procedure**

For an intentional radiator which is designed to be connected to the public utility (AC) power line, the radio frequency voltage that is conducted back onto the AC line on any frequency or frequencies within the band 150 kHz to 30 MHz shall not exceed the limits in the table bellows with this provision shall be based on the measurement of the radio frequency voltage between each power line and ground at the power terminals.

This measurement was transact first with instrumentation using an average and peak detector and a 10 kHz bandwidth. If the peak detector achieves a calculated level, the measurement is repeated by an instrumentation using a quasi-peak detector.

**11.2 Test Results**

Frequency	Max. Level (dBμV)	
	quasi-peak	average
-- kHz	--	--

**Note**

1. **The formula of measured value as: Test Result = Reading + Correction Factor**
2. **The Correction Factor = Cable Loss + LISN Insertion Loss + Pulse Limit Loss**
3. **Detector function in the form : PK = Peak, QP = Quasi Peak, AV = Average**
4. **All not in the table noted test results are more than 20 dB below the relevant limits.**
5. **Measurement uncertainty = ±1.67 dB; Reported uncertainties represent expanded uncertainties expressed at approximately the 95% confidence level using a coverage factor of k = 2.**
6. **Up Line: QP Limit Line, Down Line: Ave Limit Line.**
7. **This test is not required because the EUT is battery-used.**

**Limits:**

Frequency of Emission (MHz)	Conducted Limit (dBUV)	
	Quasi Peak	Average
0.15-0.5	66 to 56	56 to 46
0.5-5	56	46
5-30	60	50

Test equipment used: ETSTW-CE 001, ETSTW-CE 016, ETSTW-CE 006, ETSTW-RE 045

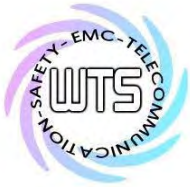

Registration number: W6M21504-14935-C-1

FCC ID: CINSQ-6100IRDA

**12 Frequency Stability vs. Temperature , FCC 2.1055 , 74.861 (e)**

**12.1 Test procedure**

The equipment under test was connected to an external DC power supply and the RF output was connected to a frequency counter via feed through attenuators. The EUT was placed inside the temperature chamber. The DC leads and RF output cable, exited the chamber through an opening made for that purpose.

After the temperature stabilized the frequency output was recorded from the counter.

**12.2 Test Results**

407.1 MHz

°C	Freq	Error(kHz)	Error(ppm)
-30	470.100000	0.000	0.000
-20	470.104006	4.006	8.522
-10	470.101602	1.602	3.408
0	470.102404	2.404	5.113
+10	470.102404	2.404	5.113
+20	470.100801	0.801	1.704
+30	470.101602	1.602	3.408
+40	470.100000	0.000	0.000
+50	470.100000	0.000	0.000
Limit		23.505	50

539 MHz

°C	Freq	Error(kHz)	Error(ppm)
-30	539.005609	8.013	14.866
-20	539.006410	8.814	16.353
-10	539.004807	7.211	13.379
0	539.006140	8.544	15.852
+10	539.003205	5.609	10.406
+20	539.004006	6.410	11.892
+30	539.003205	5.609	10.406
+40	539.000801	3.205	5.947
+50	539.002403	4.807	8.918
Limit		26.950	50



# ***Worldwide Testing Services(Taiwan) Co., Ltd.***

Registration number: W6M21504-14935-C-1

FCC ID: CINSQ-6100IRDA

## 607.9 MHz

°C	Freq	Error(kHz)	Error(ppm)
-30	607.902403	4.807	7.908
-20	607.902404	4.808	7.909
-10	607.903205	5.609	9.227
0	607.901603	4.007	6.591
+10	607.900801	3.205	5.273
+20	607.899198	1.602	2.635
+30	607.901602	4.006	6.590
+40	607.900000	2.404	3.955
+50	607.900801	3.205	5.272
Limit		30.395	50

## 614.1 MHz

°C	Freq	Error(kHz)	Error(ppm)
-30	614.104808	6.411	13.637
-20	614.103205	4.808	10.228
-10	614.102403	4.006	8.522
0	614.100801	2.404	5.114
+10	614.100000	1.603	3.410
+20	614.099198	0.801	1.704
+30	614.098397	0.000	0.000
+40	614.098397	0.000	0.001
+50	614.100000	1.603	3.410
Limit		30.705	50

## 655.95 MHz

°C	Freq	Error(kHz)	Error(ppm)
-30	655.955608	8.012	14.865
-20	655.949199	1.603	2.973
-10	655.951602	4.006	7.432
0	655.952404	4.808	8.920
+10	655.954006	6.410	11.892
+20	655.954807	7.211	13.379
+30	655.952403	4.807	8.918
+40	655.948589	0.993	1.842
+50	655.949198	1.602	2.972
Limit		32.798	50



# ***Worldwide Testing Services(Taiwan) Co., Ltd.***

Registration number: W6M21504-14935-C-1

FCC ID: CINSQ-6100IRDA

697.8 MHz

°C	Freq	Error(kHz)	Error(ppm)
-30	697.792788	-4.808	-7.909
-20	697.802404	4.808	7.909
-10	697.800801	3.205	5.272
0	697.803205	5.609	9.227
+10	697.800801	3.205	5.273
+20	697.802403	4.807	7.908
+30	697.798397	0.801	1.318
+40	697.799199	1.603	2.636
+50	697.798397	0.801	1.318
Limit		34.890	50

Test equipment used: ETSTW-RE 055, ETSTW-CE 009



Registration number: W6M21504-14935-C-1

FCC ID: CINSQ-6100IRDA

**13 Frequency Stability vs. Voltage , FCC 2.1055 (d) ; 74.861 (e)**

**13.1 Test procedure**

An external variable DC power supply was connected to the battery terminals of the equipment under test.

For hand carried , battery powered equipment primary supply voltage was reduced to the battery operating end point as specified by the manufacturer. The output frequency was recorded for each battery voltage.

**13.2 Test Results**

Test voltage: 2.04 Vdc

Frequency in MHz	Frequency Error (kHz)	Frequency Error (ppm)
470.100801	0.801	1.704
538.998397	0.801	1.486
607.903205	5.609	9.227
614.100000	1.603	3.410
655.947596	0.000	0.000
697.796795	-0.801	-1.318

Limit :  $\pm 0.005\%$

Test equipment used: ETSTW-RE 055



Registration number: W6M21504-14935-C-1  
FCC ID: CINSQ-6100IRDA

## **Appendix**

### **A Photos**

1. External Photos
2. Internal Photos
3. Set Up Photo of Radiated Emission

### **B Measurement diagrams**

1. Modulation Deviation and Audio frequency response
2. Radiation Spurious Emission



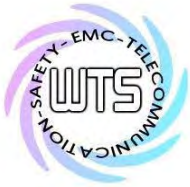

Registration number: W6M21504-14935-C-1

FCC ID: CINSM-6100IRDA

**External Photos**



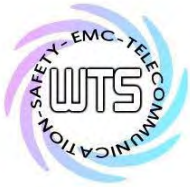

# Worldwide Testing Services(Taiwan) Co., Ltd.

Registration number: W6M21504-14935-C-1

FCC ID: CINSQ-6100IRDA





**Worldwide Testing Services(Taiwan) Co., Ltd.**

Registration number: W6M21504-14935-C-1  
FCC ID: CINSQ-6100IRDA





**Worldwide Testing Services(Taiwan) Co., Ltd.**

Registration number: W6M21504-14935-C-1  
FCC ID: CINSQ-6100IRDA



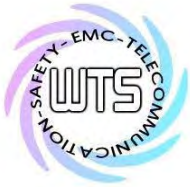

# Worldwide Testing Services(Taiwan) Co., Ltd.

Registration number: W6M21504-14935-C-1

FCC ID: CINSQ-6100IRDA



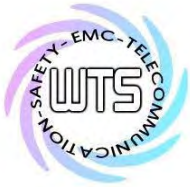

# Worldwide Testing Services(Taiwan) Co., Ltd.

Registration number: W6M21504-14935-C-1

FCC ID: CINSQ-6100IRDA



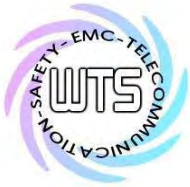

# Worldwide Testing Services(Taiwan) Co., Ltd.

Registration number: W6M21504-14935-C-1

FCC ID: CINSQ-6100IRDA

## Internal Photos





# Worldwide Testing Services(Taiwan) Co., Ltd.

Registration number: W6M21504-14935-C-1  
FCC ID: CINSQ-6100IRDA







Registration number: W6M21504-14935-C-1

FCC ID: CINSQ-6100IRDA

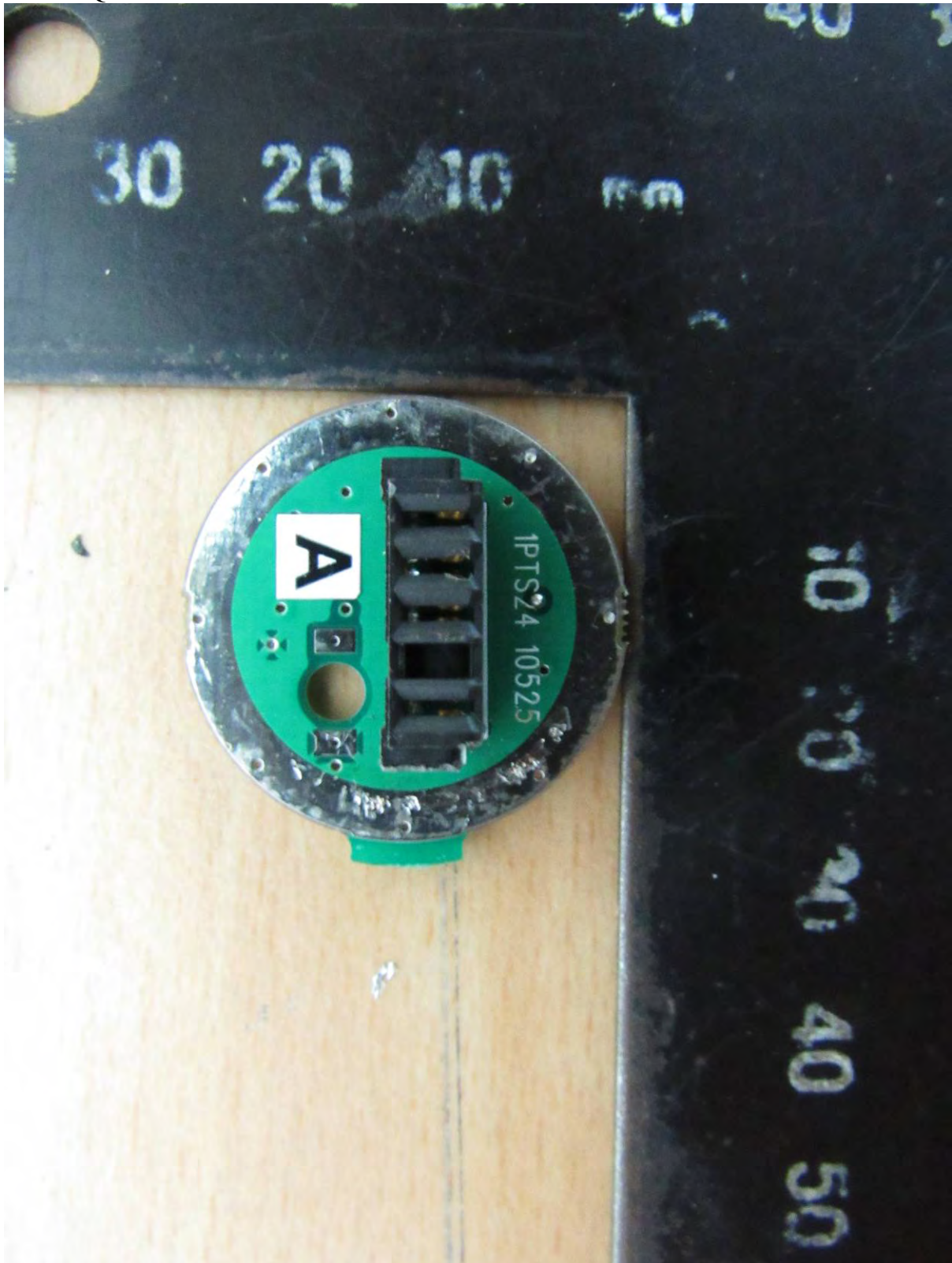

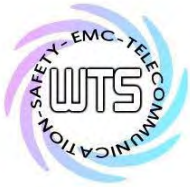

Registration number: W6M21504-14935-C-1

FCC ID: CINSQ-6100IRDA

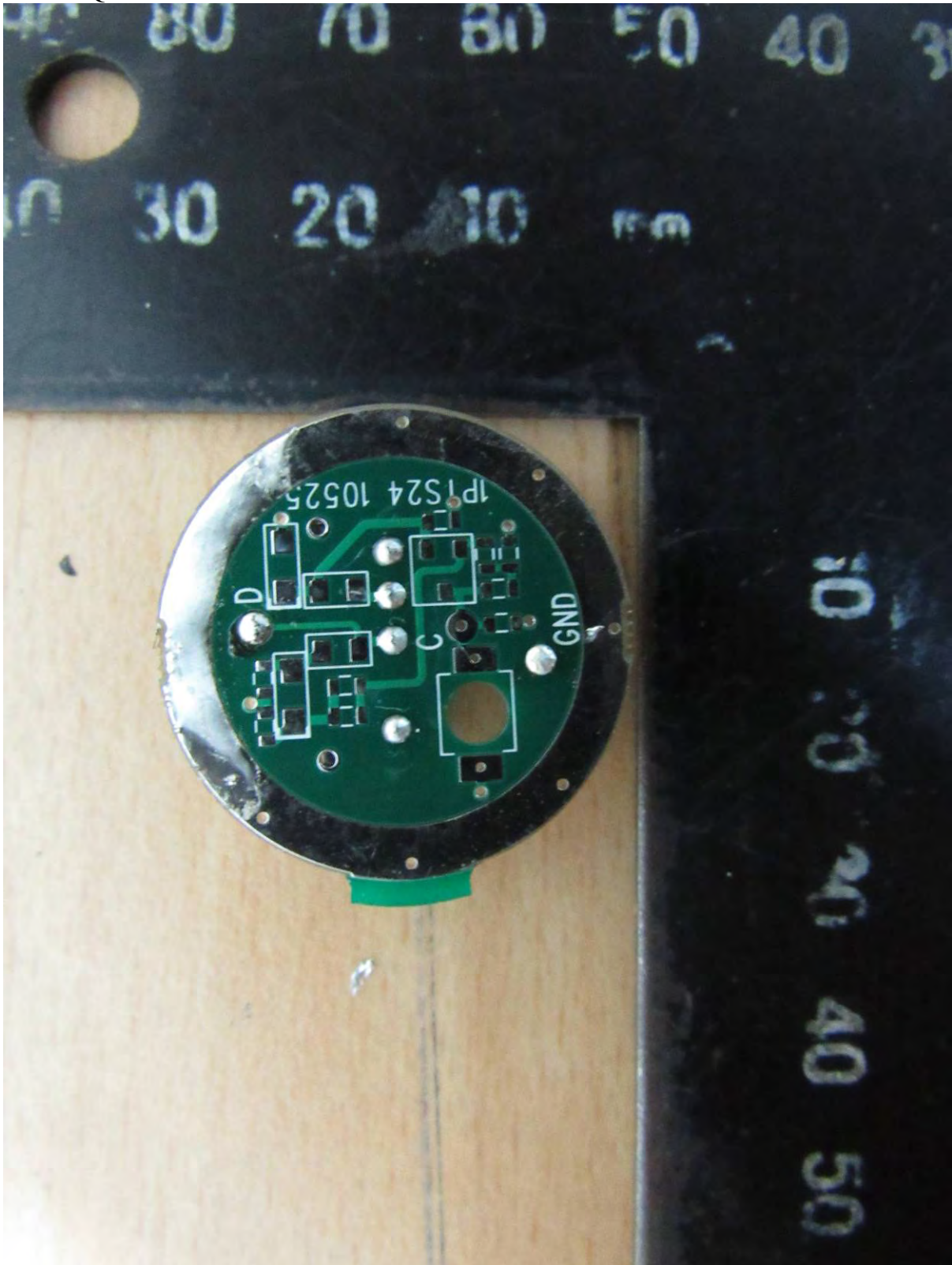

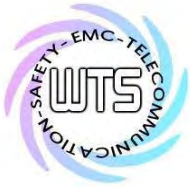

# Worldwide Testing Services(Taiwan) Co., Ltd.

Registration number: W6M21504-14935-C-1

FCC ID: CINSQ-6100IRDA



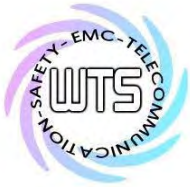

Registration number: W6M21504-14935-C-1

FCC ID: CINSQ-6100IRDA



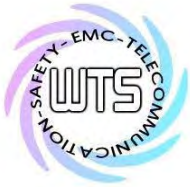

Registration number: W6M21504-14935-C-1

FCC ID: CINSQ-6100IRDA

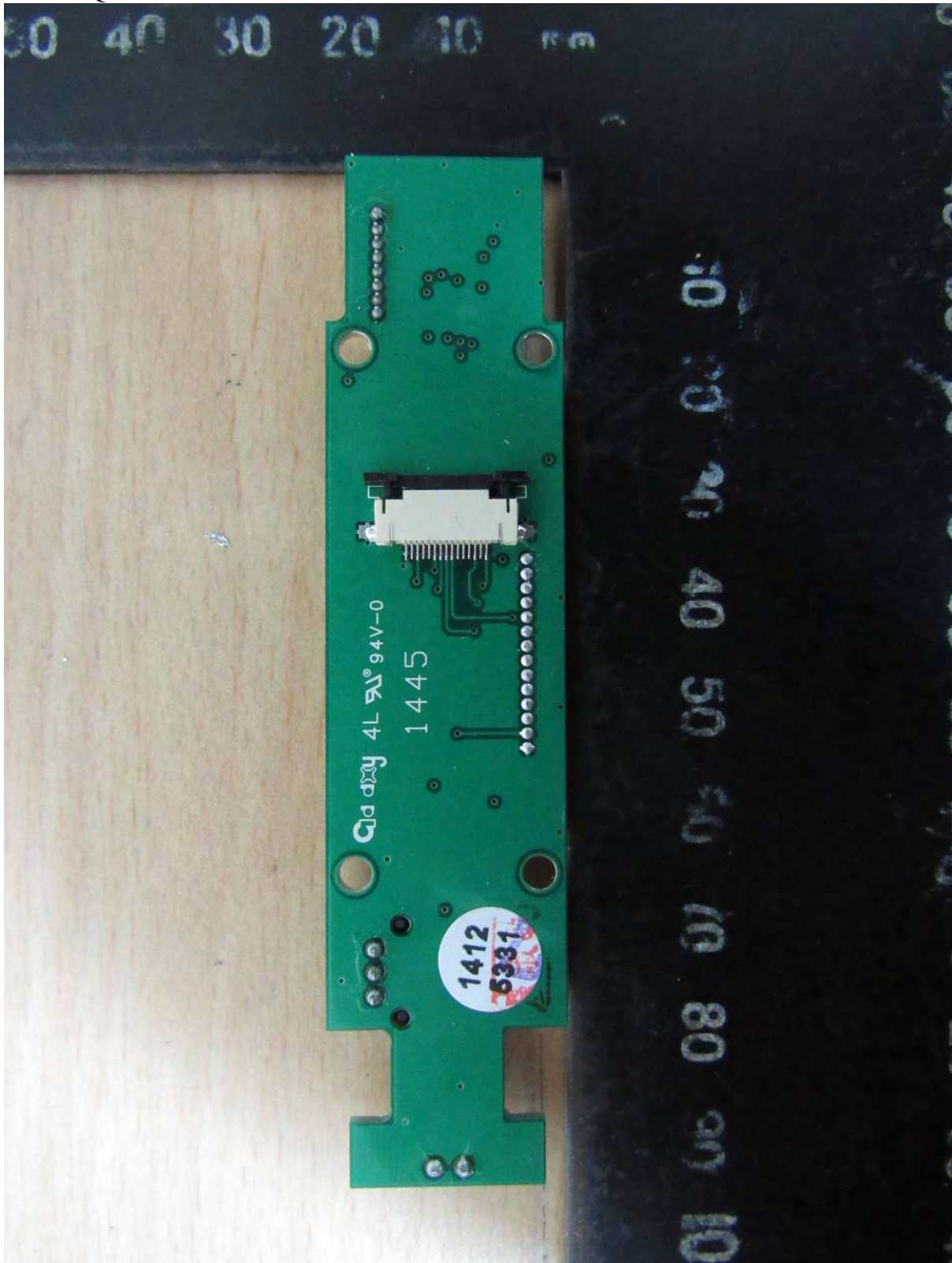

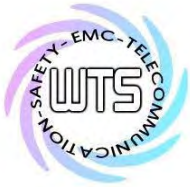

Registration number: W6M21504-14935-C-1

FCC ID: CINSQ-6100IRDA

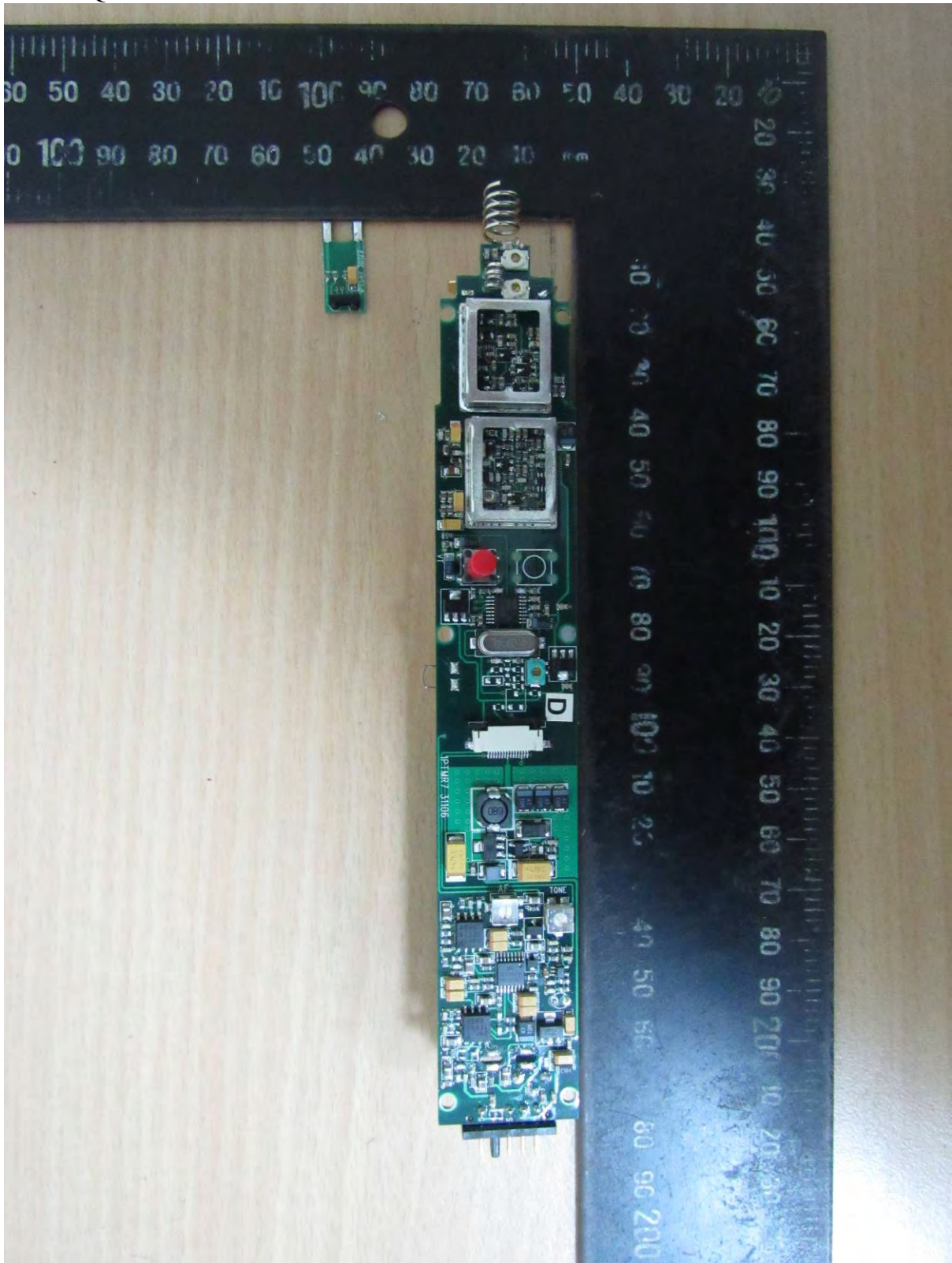

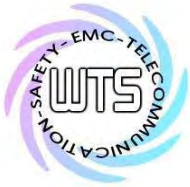

Registration number: W6M21504-14935-C-1

FCC ID: CINSQ-6100IRDA

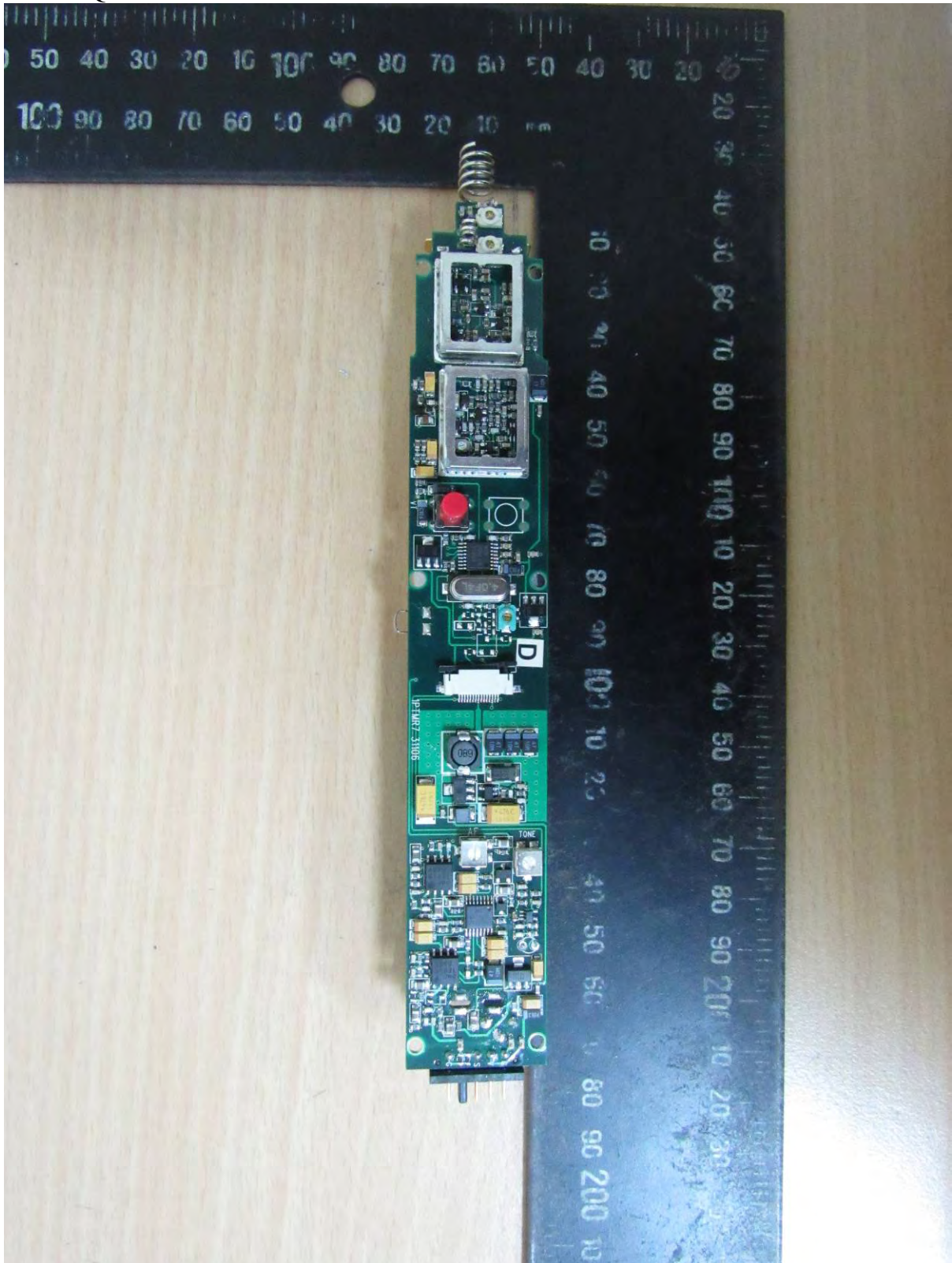

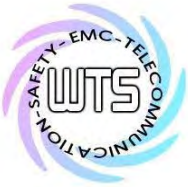

Registration number: W6M21504-14935-C-1

FCC ID: CINSQ-6100IRDA





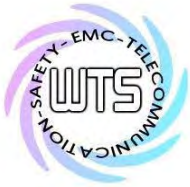

# Worldwide Testing Services(Taiwan) Co., Ltd.

Registration number: W6M21504-14935-C-1

FCC ID: CINSQ-6100IRDA

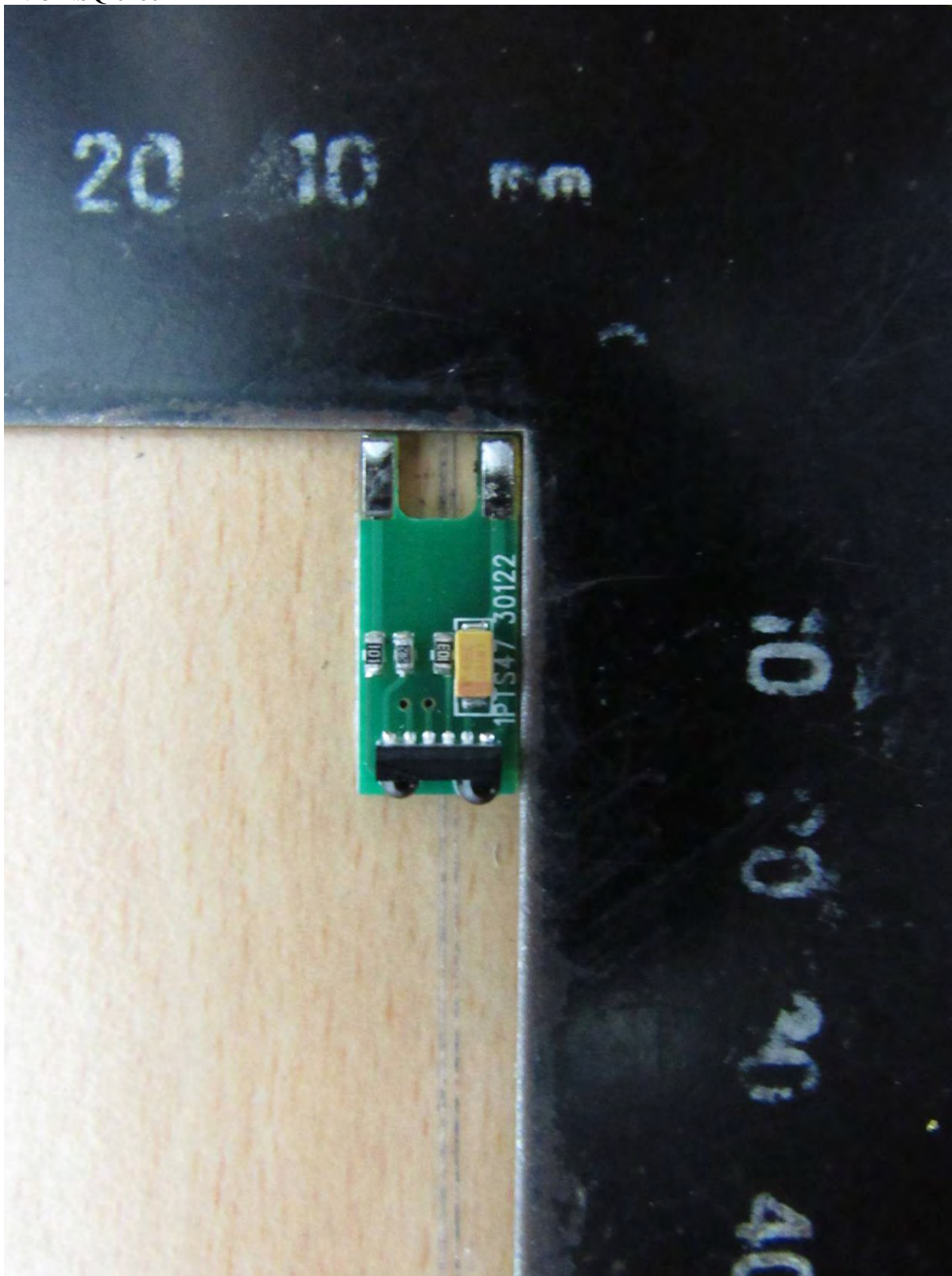

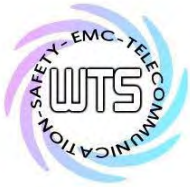

**Worldwide Testing Services(Taiwan) Co., Ltd.**

Registration number: W6M21504-14935-C-1

FCC ID: CINSQ-6100IRDA

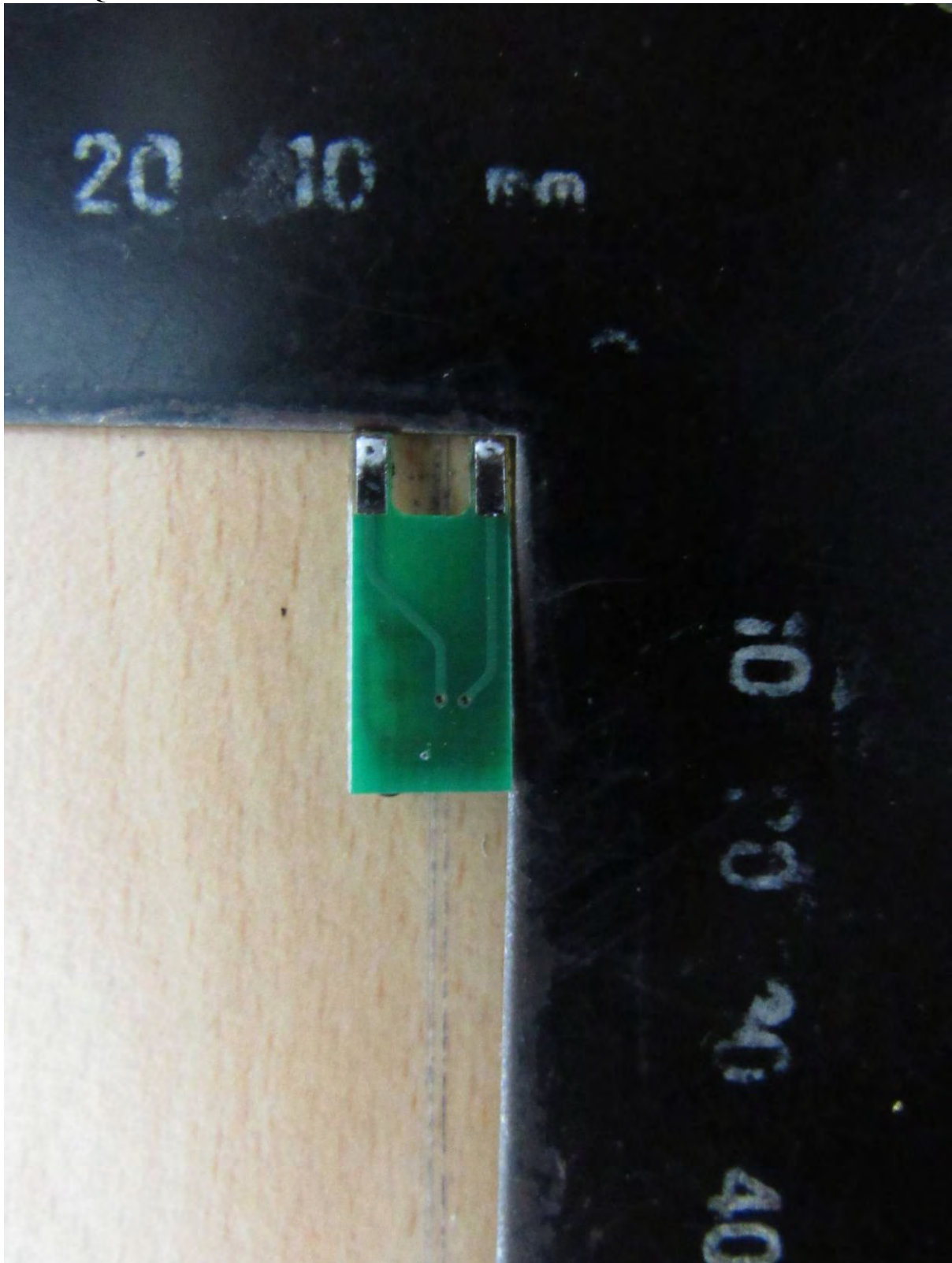



# Worldwide Testing Services(Taiwan) Co., Ltd.

Registration number: W6M21504-14935-C-1

FCC ID: CINSQ-6100IRDA



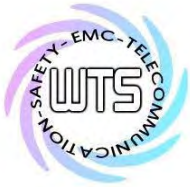

Registration number: W6M21504-14935-C-1

FCC ID: CINSQ-6100IRDA

**Set Up Photo of Radiated Emission**

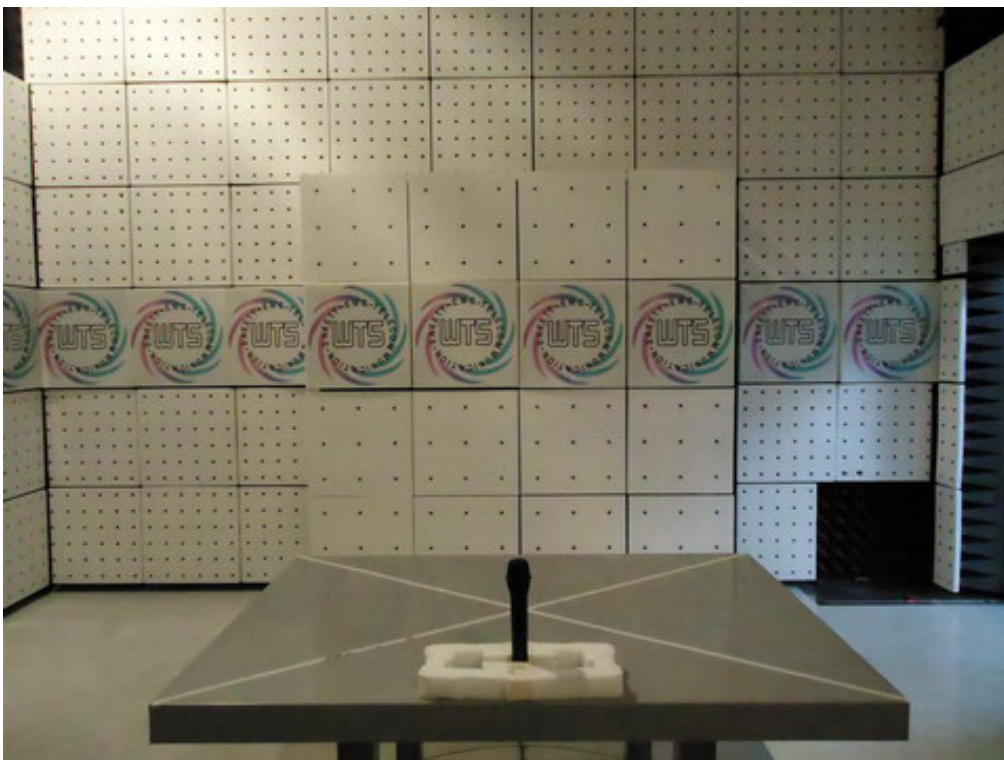



Registration number: W6M21504-14935-C-1

FCC ID: CINSQ-6100IRDA

470.1 MHz

Modulation Characteristics

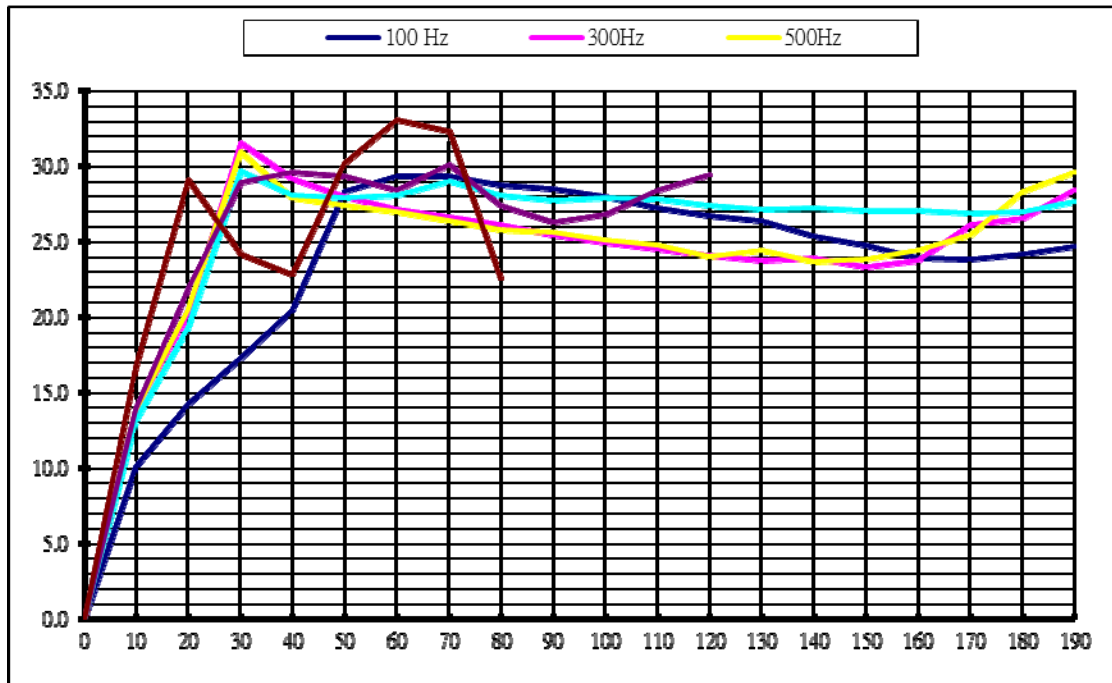

Frequency Deviation at 1kHz

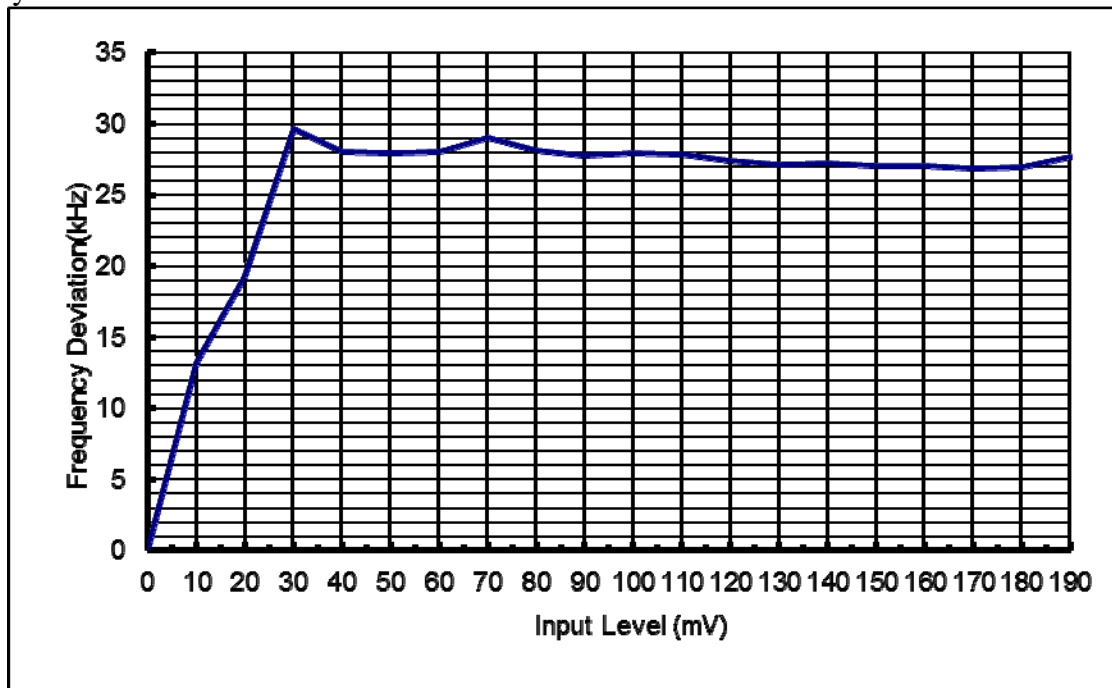



Registration number: W6M21504-14935-C-1

FCC ID: CINSQ-6100IRDA

Frequency Deviation

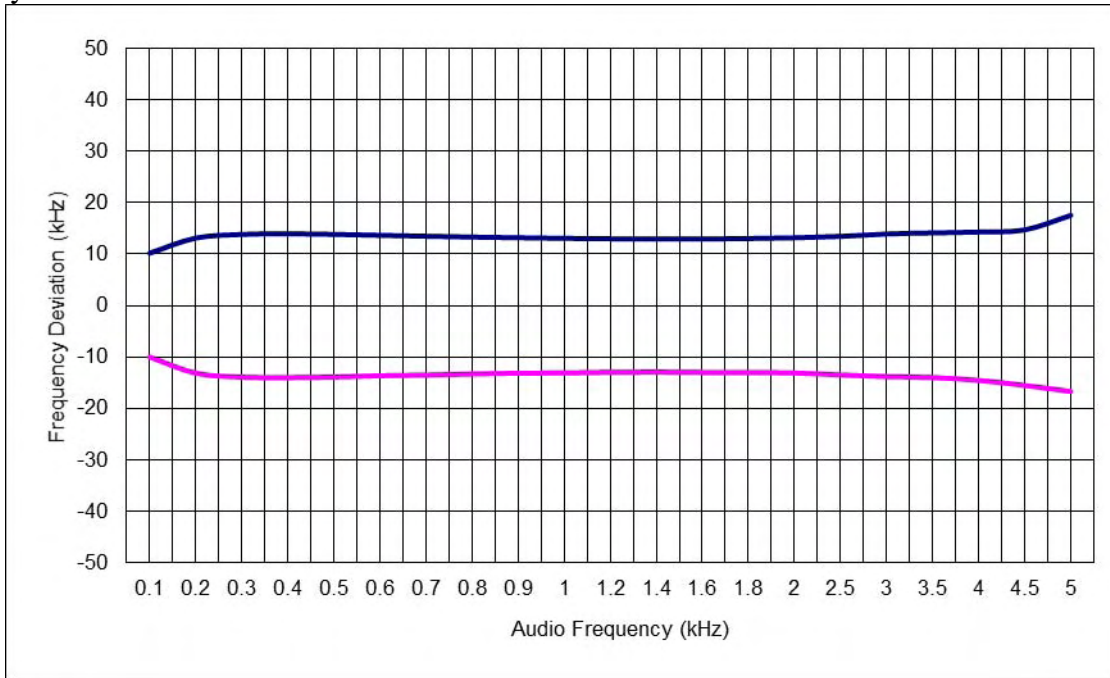

Audio Response

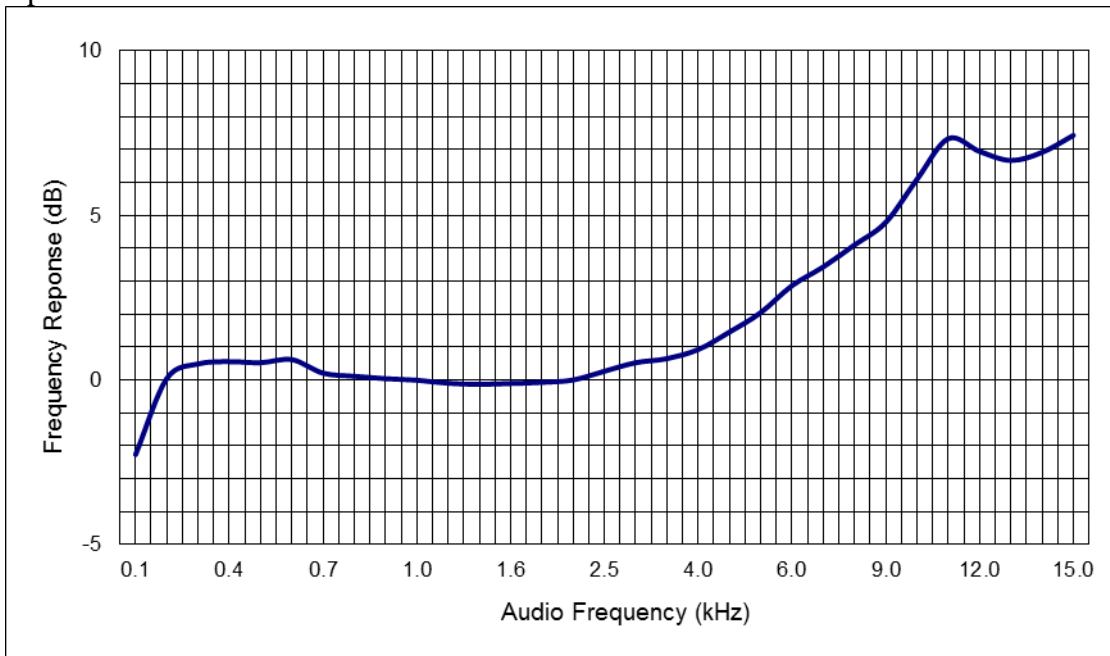

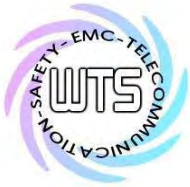

Registration number: W6M21504-14935-C-1

FCC ID: CINSQ-6100IRDA

539MHz

Modulation Characteristics

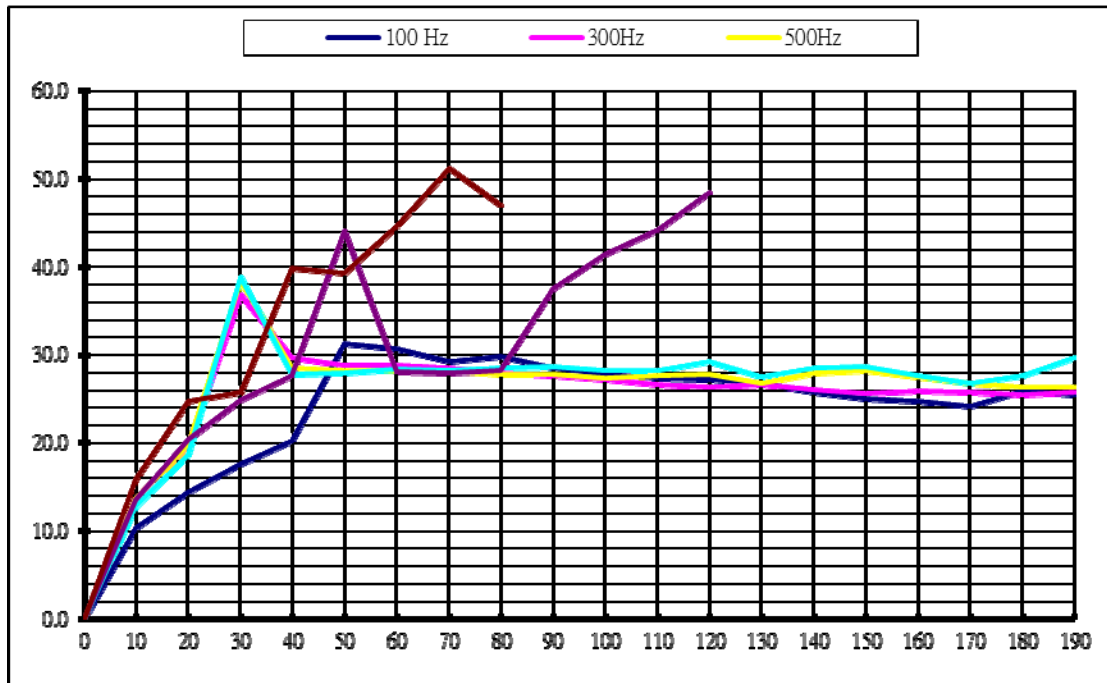

Frequency Deviation at 1kHz

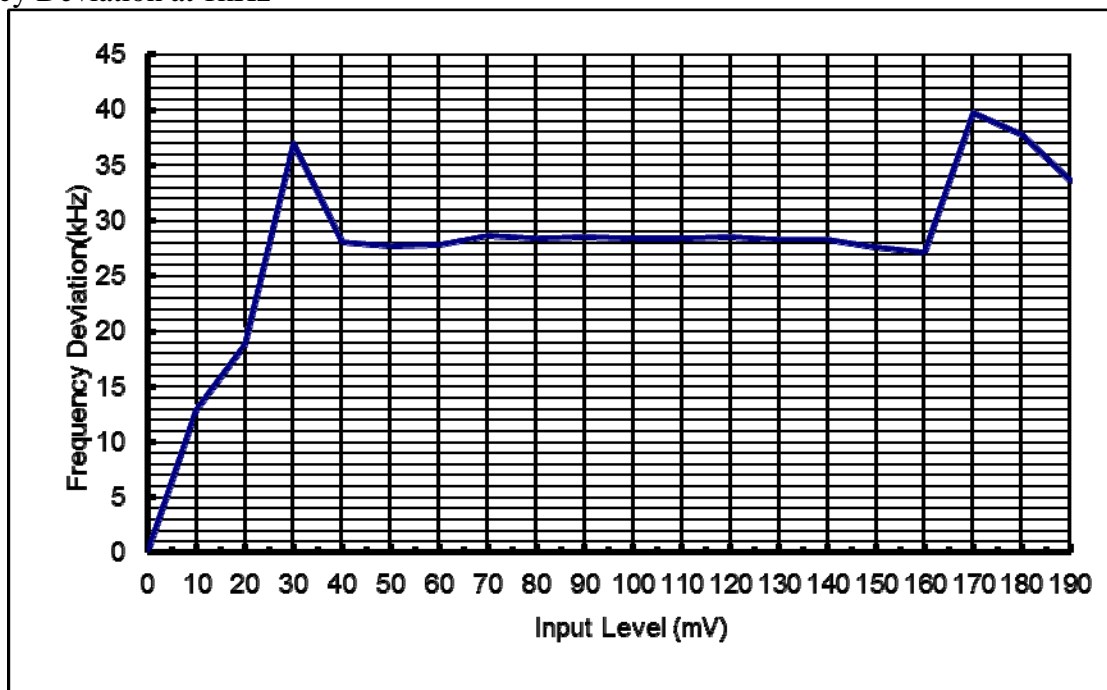

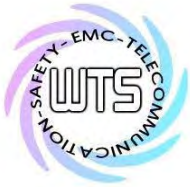

Registration number: W6M21504-14935-C-1

FCC ID: CINSQ-6100IRDA

Frequency Deviation

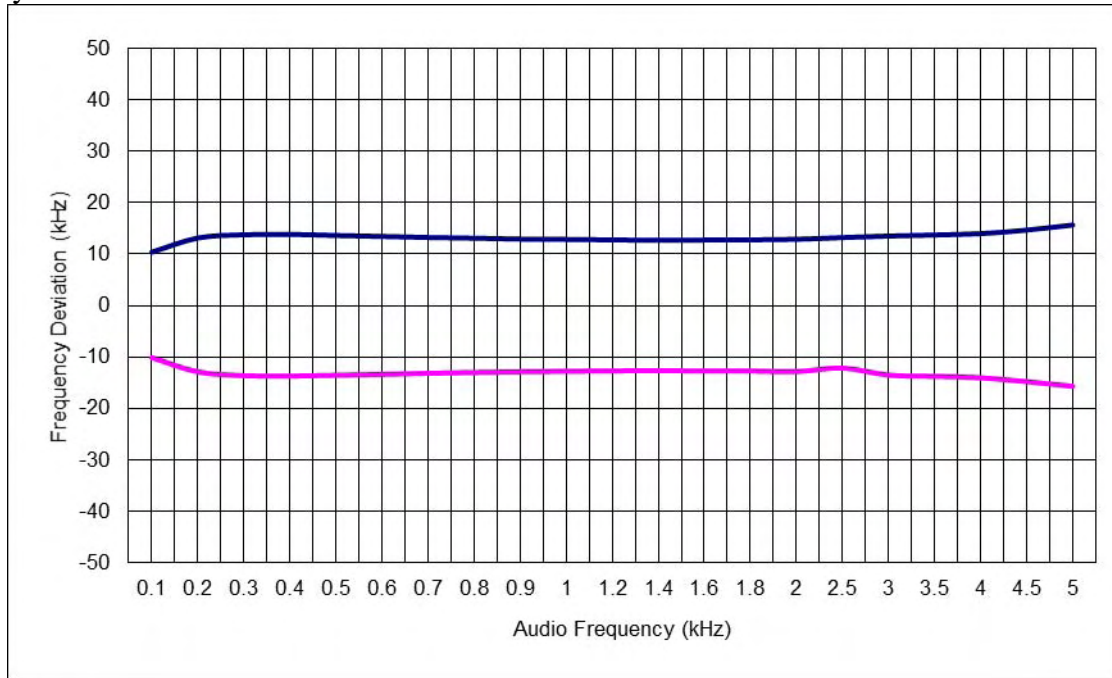

Audio Response

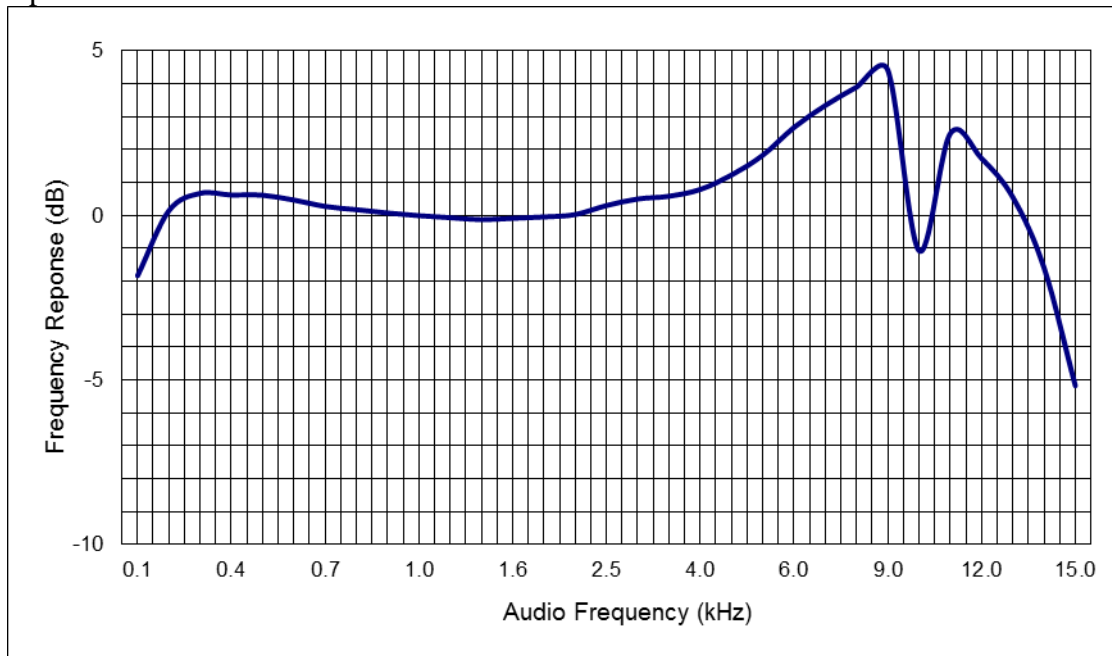



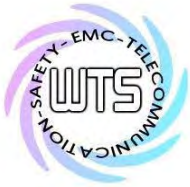

Registration number: W6M21504-14935-C-1

FCC ID: CINSQ-6100IRDA

607.9 MHz

Modulation Characteristics

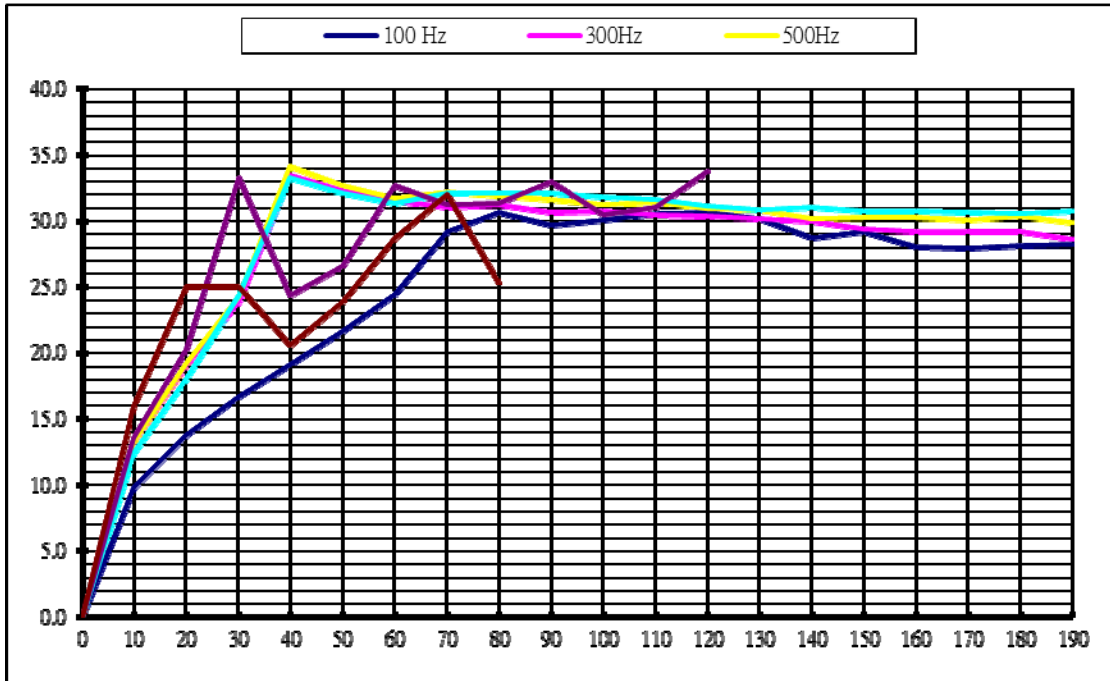

Frequency Deviation at 1kHz

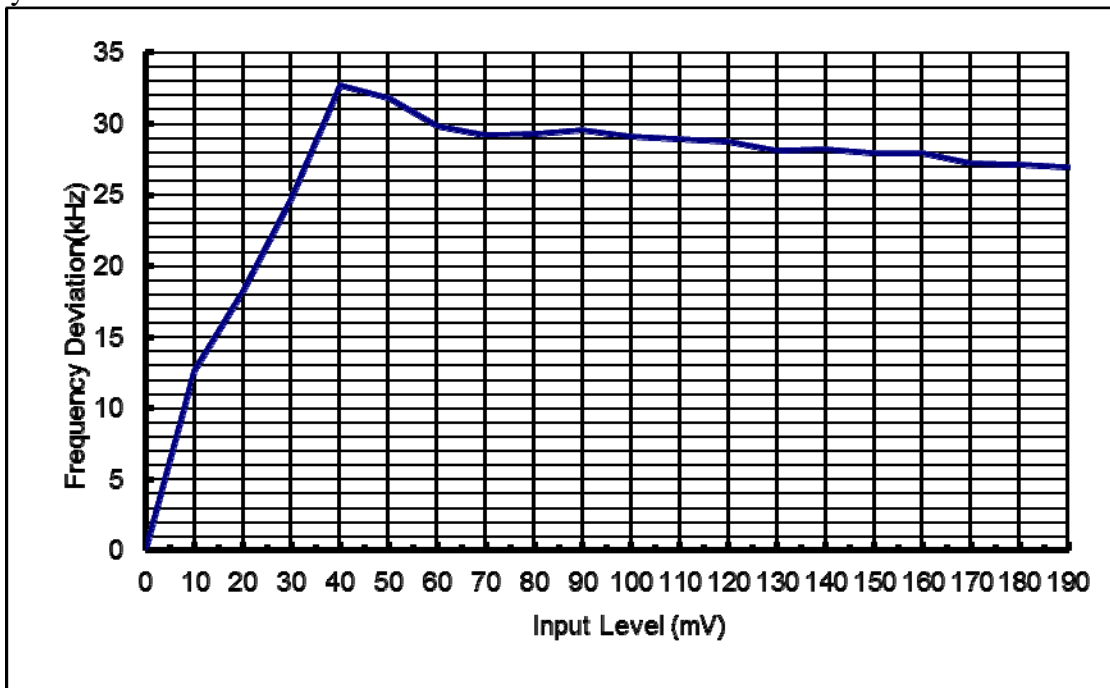



Registration number: W6M21504-14935-C-1

FCC ID: CINSQ-6100IRDA

Frequency Deviation

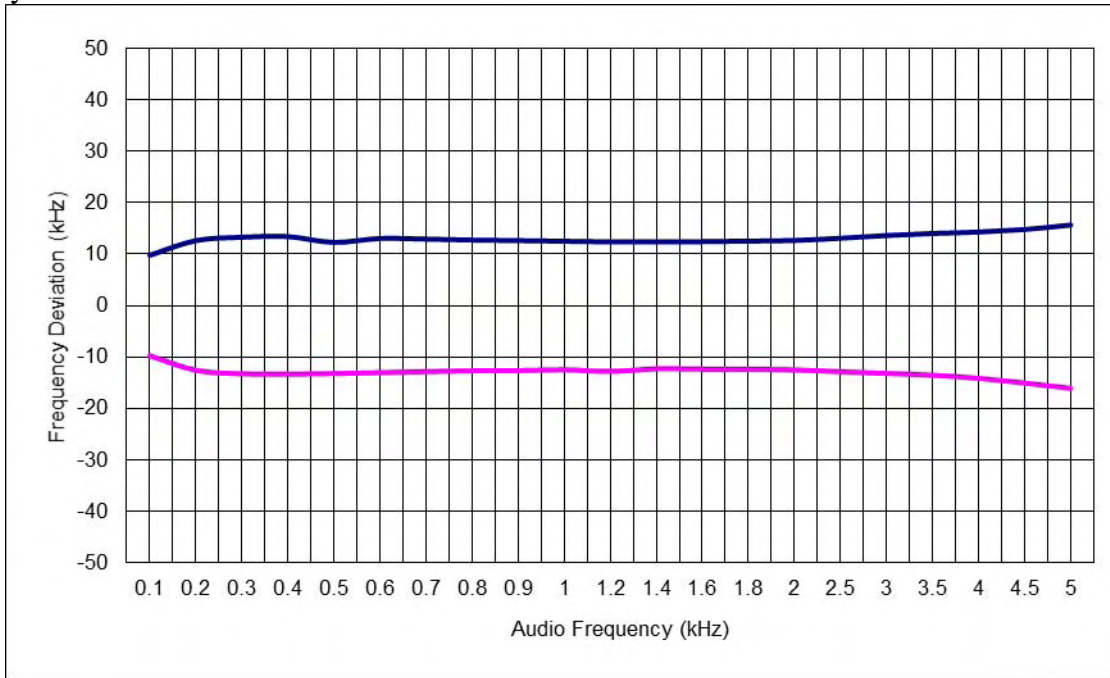

Audio Response

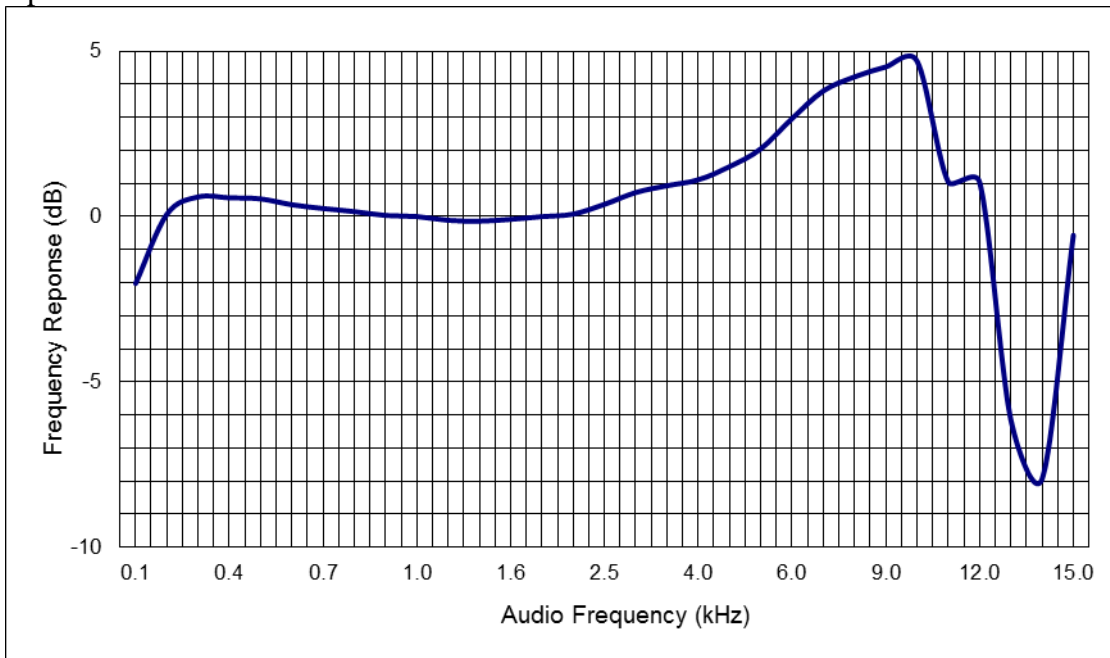



Registration number: W6M21504-14935-C-1

FCC ID: CINSQ-6100IRDA

614.1 MHz

Modulation Characteristics

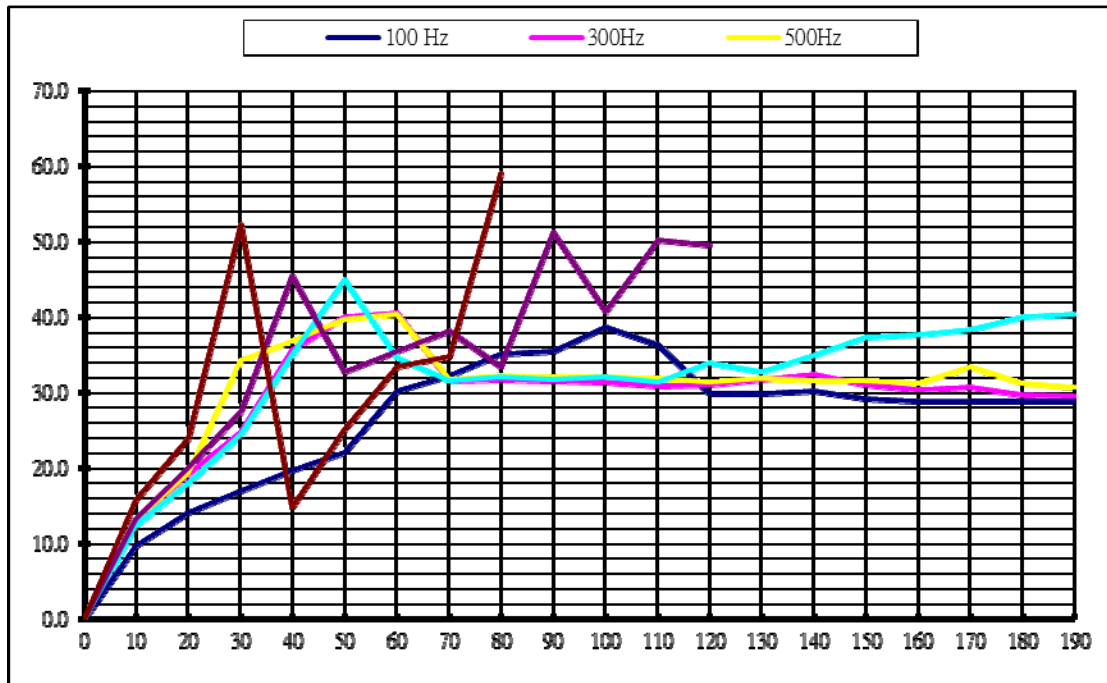

Frequency Deviation at 1kHz

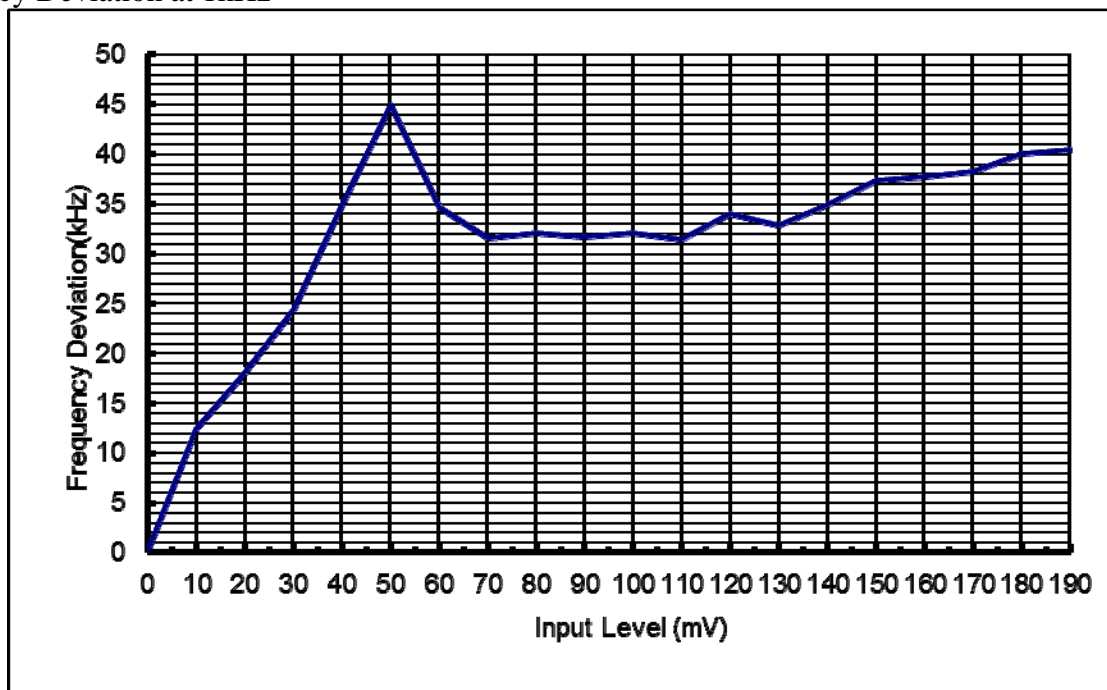

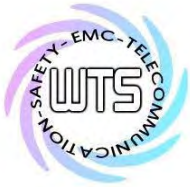

Registration number: W6M21504-14935-C-1

FCC ID: CINSQ-6100IRDA

Frequency Deviation

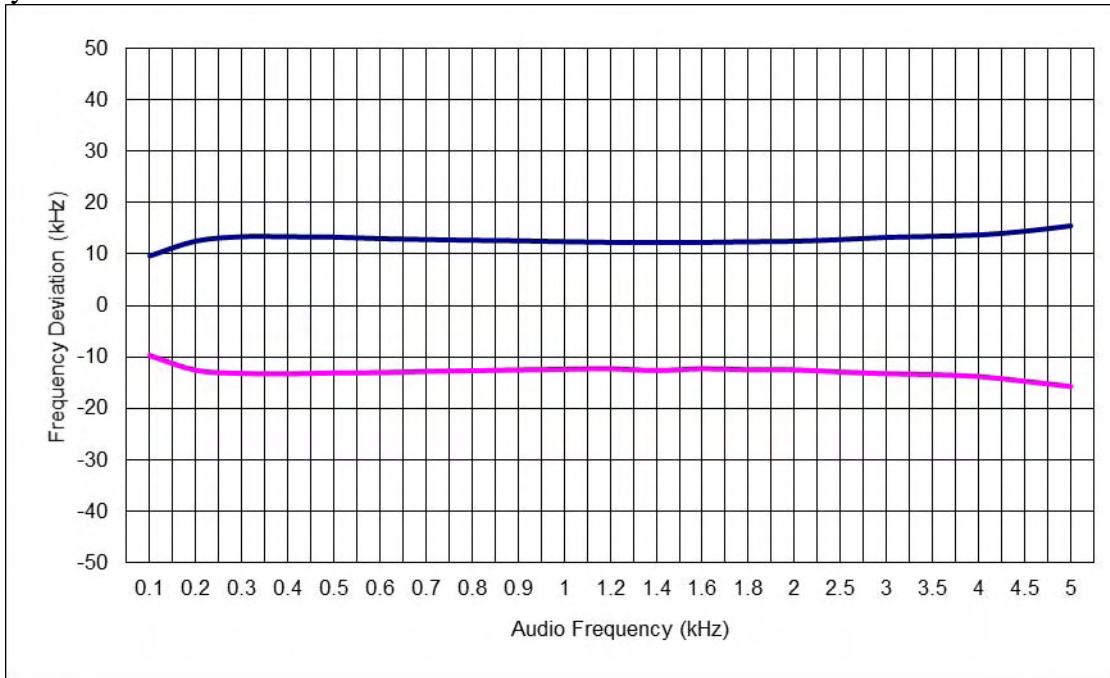

Audio Response

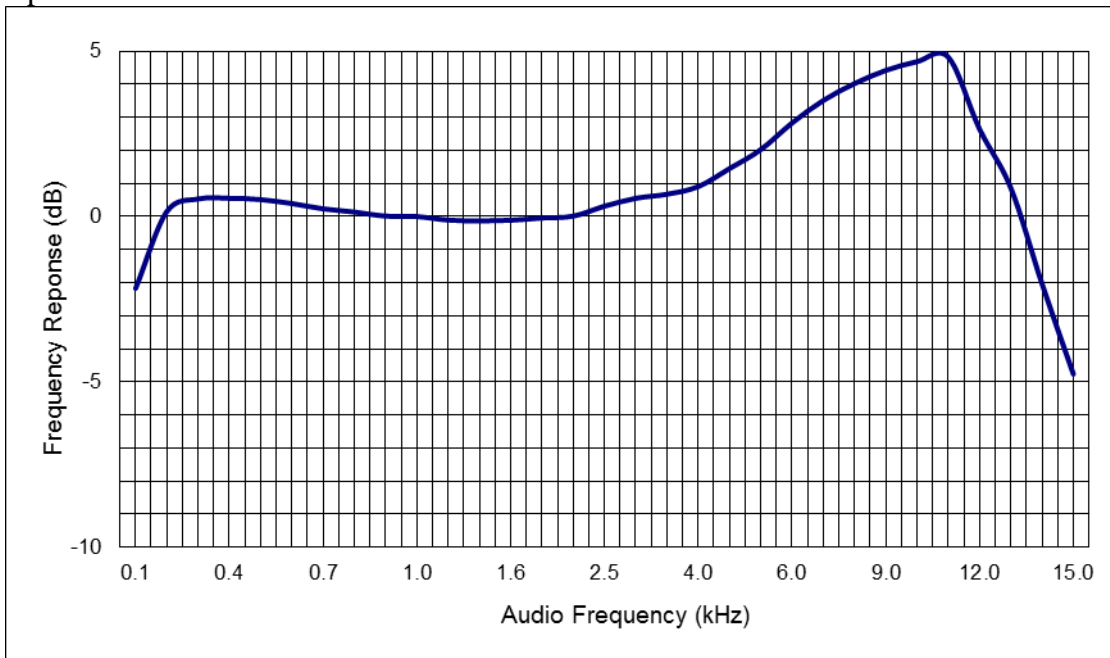



Registration number: W6M21504-14935-C-1

FCC ID: CINSQ-6100IRDA

655.95MHz

Modulation Characteristics

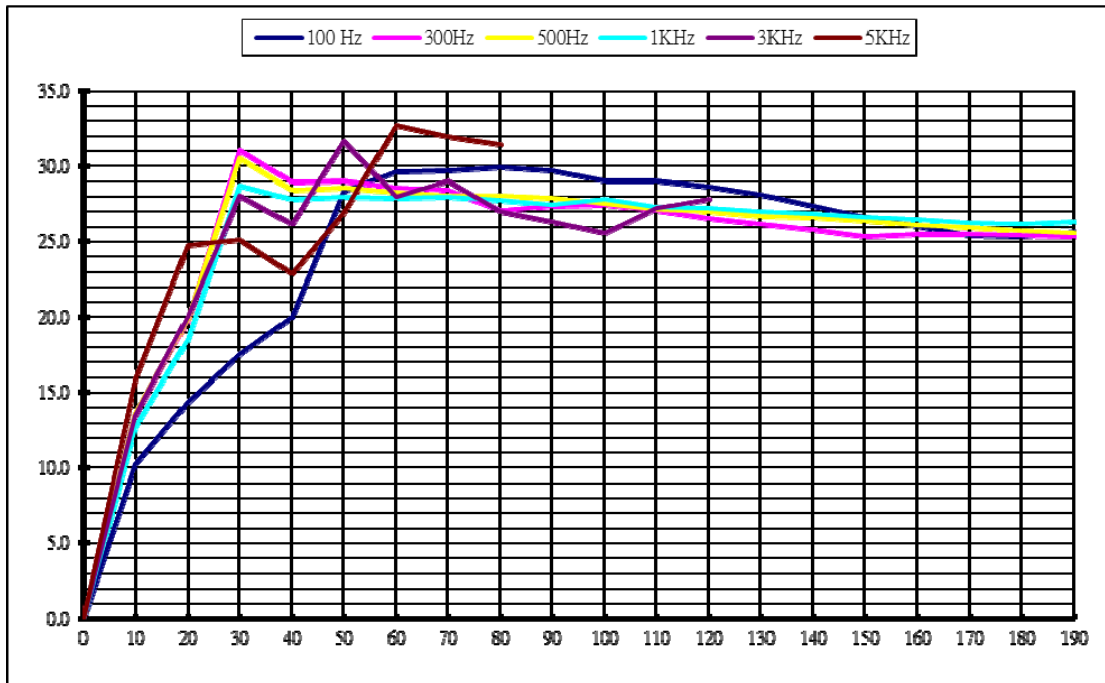

Frequency Deviation at 1kHz

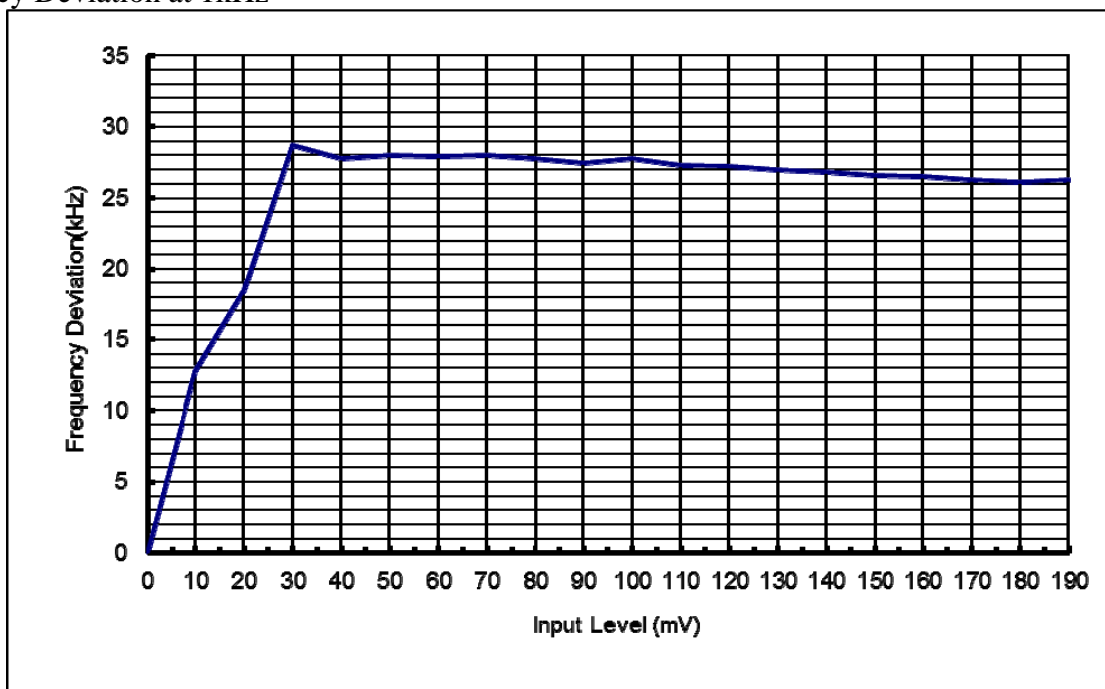



Registration number: W6M21504-14935-C-1

FCC ID: CINSQ-6100IRDA

Frequency Deviation

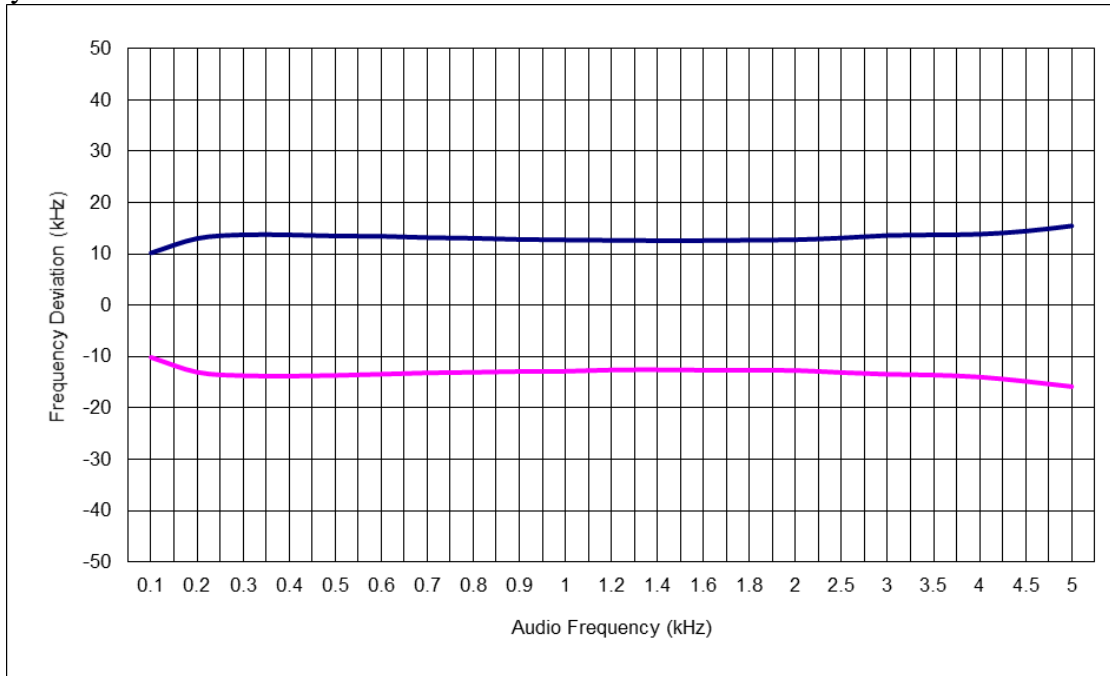

Audio Response

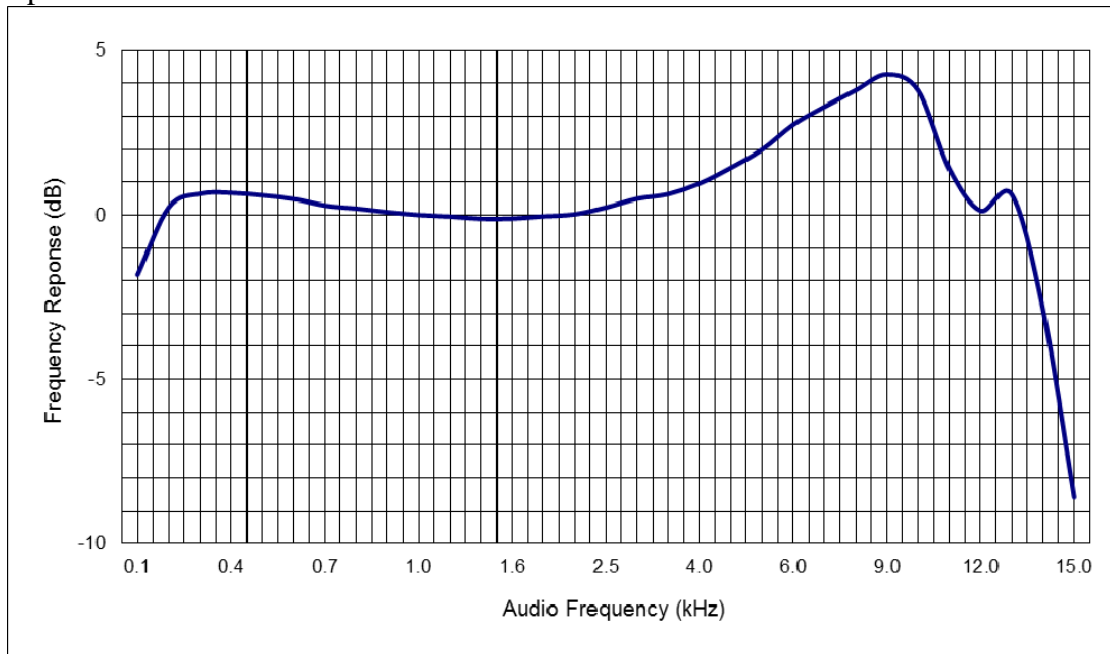

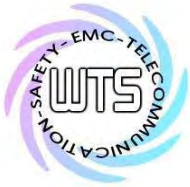

Registration number: W6M21504-14935-C-1

FCC ID: CINSQ-6100IRDA

697.8 MHz

Modulation Characteristics

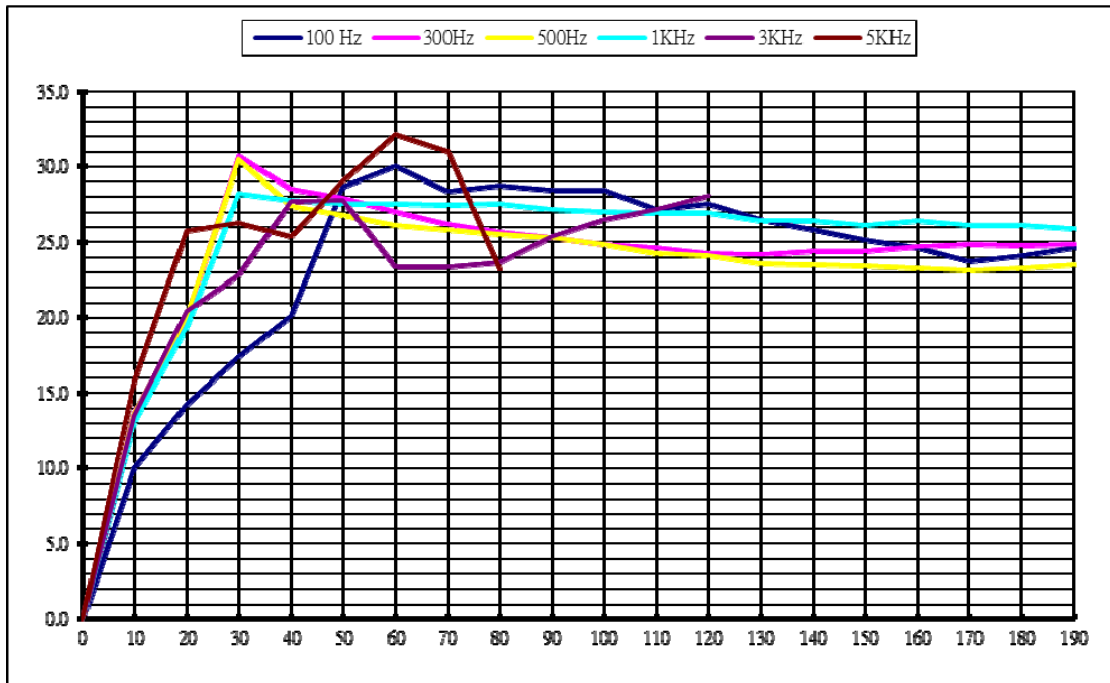

Frequency Deviation at 1kHz

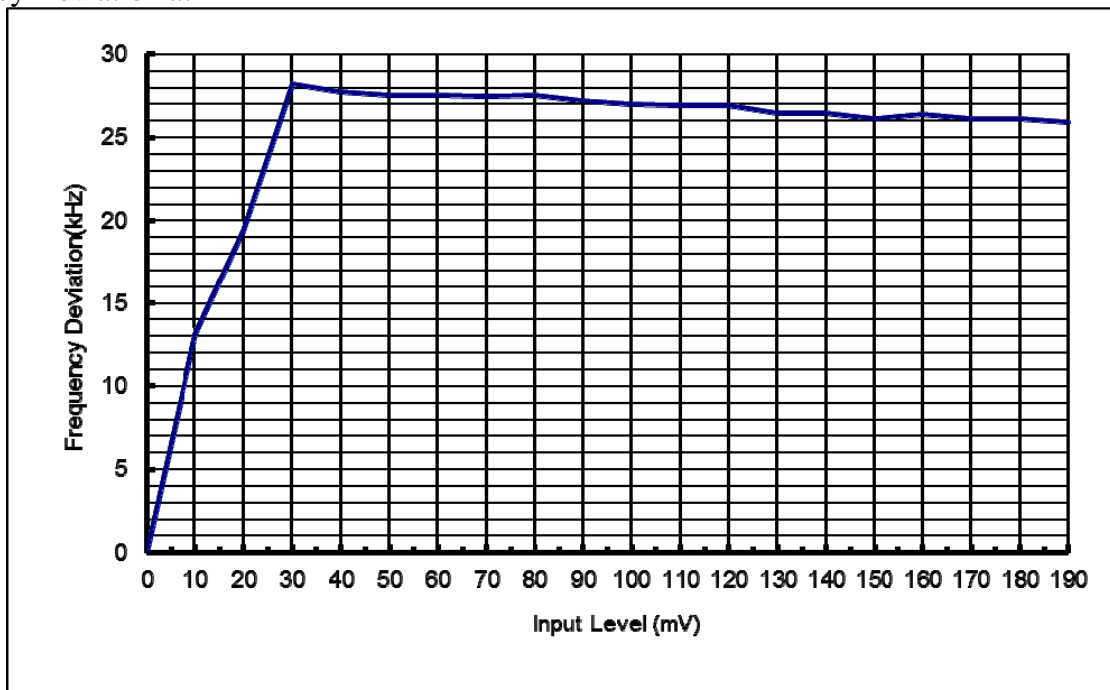

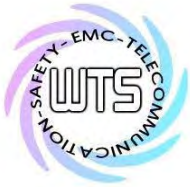

Registration number: W6M21504-14935-C-1

FCC ID: CINSQ-6100IRDA

Frequency Deviation

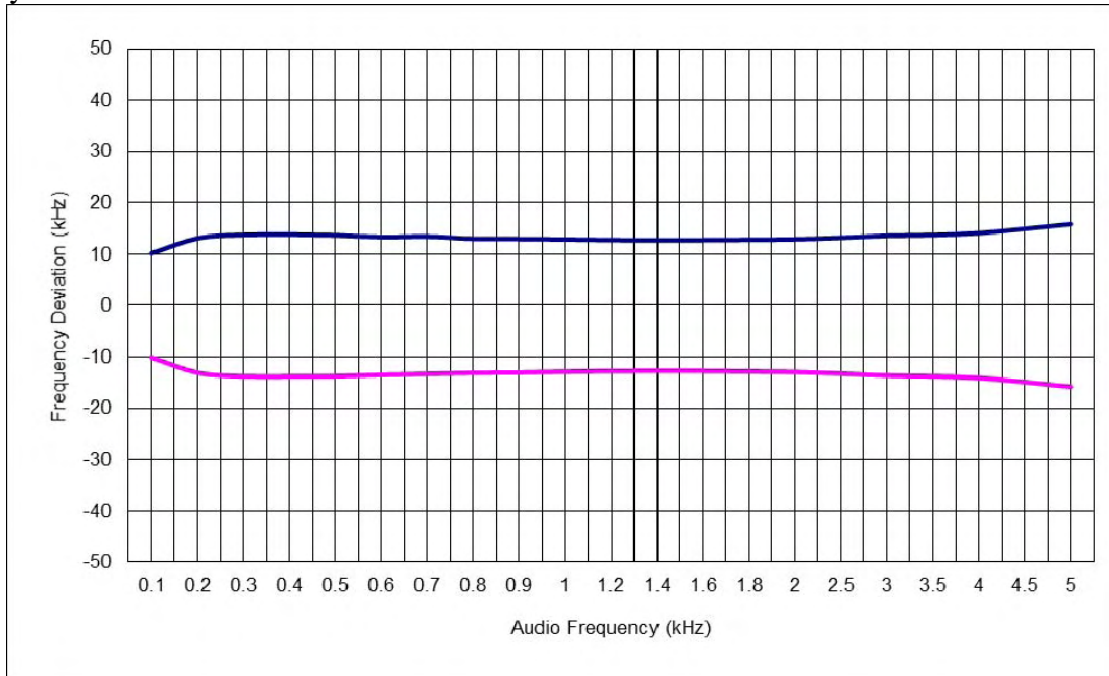

Audio Response

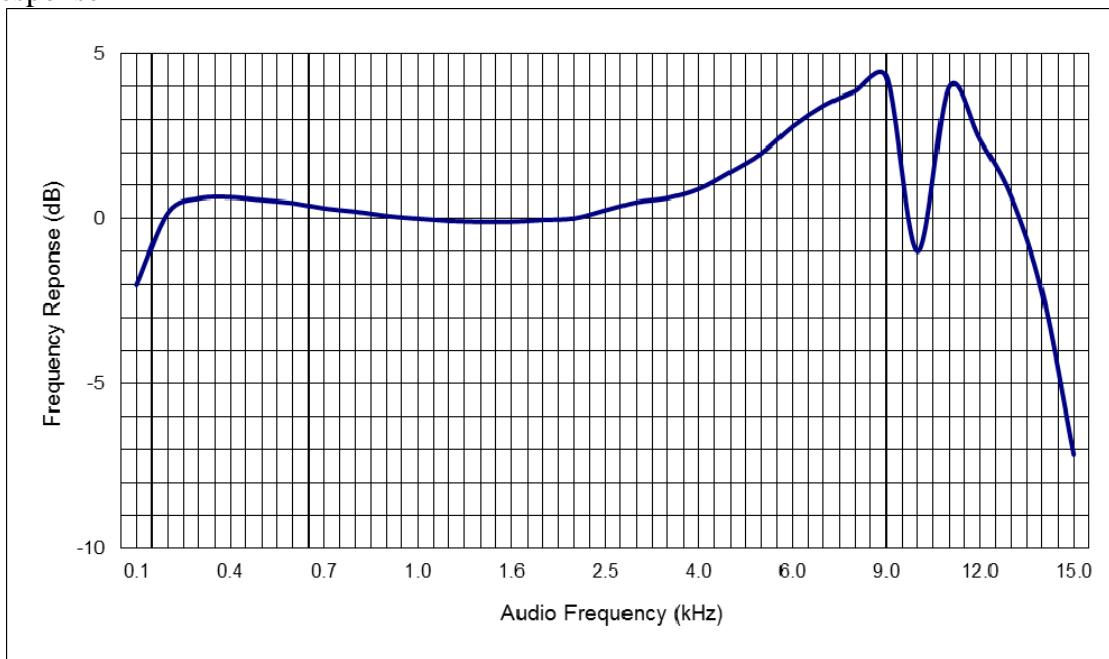





Radiated Emission Measurement

Operator: Spencer

File :1

Data :#1

Date: 2015/4/15

Temperature:27.8 °C

5.0 dBm

Time: 下午 09:51:00

Humidity:63.4 %

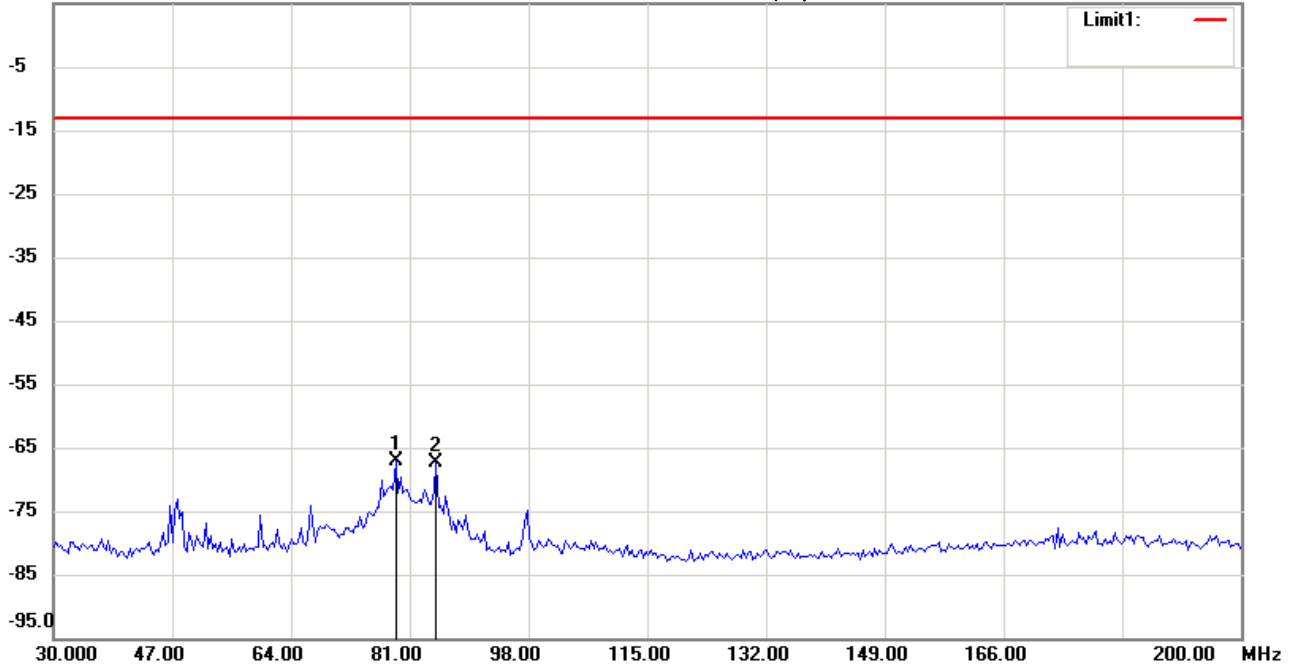

Site : Chamber

Condition : FCC 74.861 spurious emission

Polarization: *Horizontal*

EUT : W6M21504-14935

Power : 2.4 Vd.c.

M/N:

Distance: 3m

Test Mode : 470.1MHz

Note :

Mk.	Frequency (MHz)	Reading (dBm)	Detector	Corr. factor (dB)	Result (dBm)	Limit (dBm)	Ant.Pos (cm)	Tab.Pos (deg.)	Margin (dB)	Comment
*	79.0581	-90.85	peak	23.85	-67.00	-13.00	150	196	-54.00	
	84.8497	-91.03	peak	23.71	-67.32	-13.00	150	287	-54.32	



Radiated Emission Measurement

Operator: Spencer

File :1

Data :#2

Date: 2015/4/15

Temperature:27.8 °C

5.0 dBm

Time: 下午 09:52:50

Humidity:63.4 %

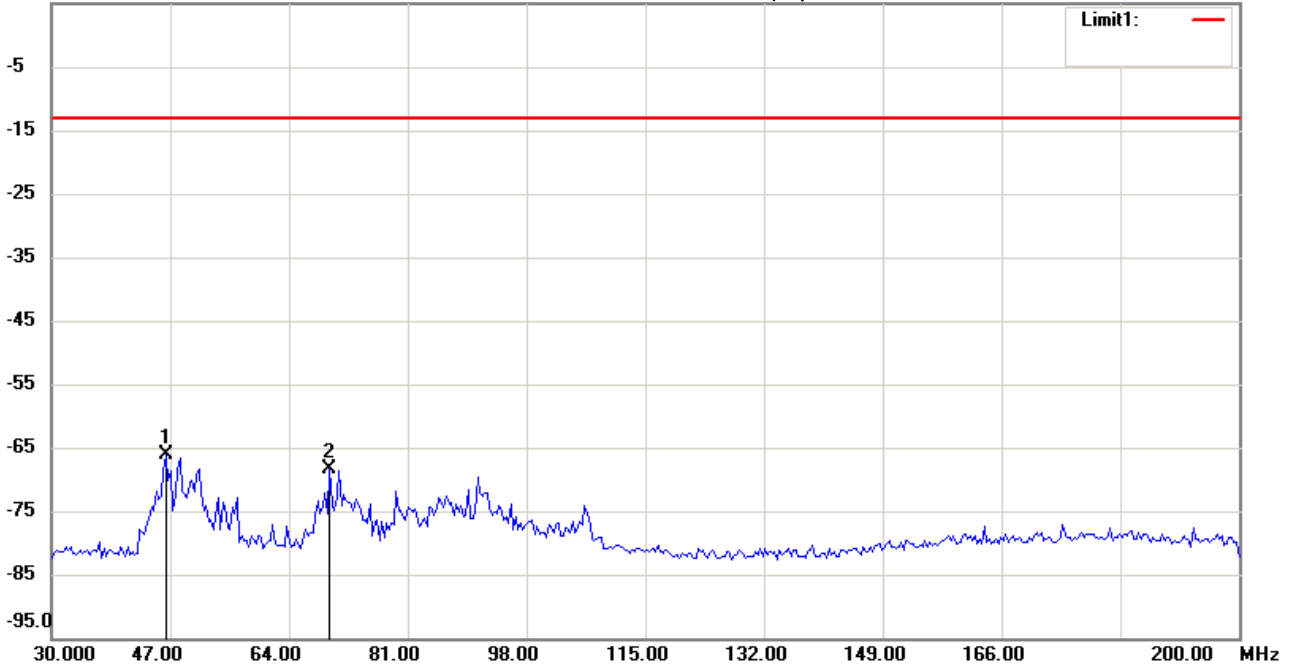

Site : Chamber

Condition : FCC 74.861 spurious emission

Polarization: *Vertical*

EUT : W6M21504-14935

Power : 2.4 Vd.c.

M/N:

Distance: 3m

Test Mode : 470.1MHz

Note :

Mk.	Frequency (MHz)	Reading (dBm)	Detector	Corr. factor (dB)	Result (dBm)	Limit (dBm)	Ant.Pos (cm)	Tab.Pos (deg.)	Margin (dB)	Comment
*	46.3527	-89.57	peak	23.42	-66.15	-13.00	150	93	-53.15	
	69.8597	-92.44	peak	23.97	-68.47	-13.00	150	87	-55.47	



Radiated Emission Measurement

Operator: Spencer

File :2

Data :#1

Date: 2015/4/15

Temperature:27.8 °C

0.0 dBm

Time: 下午 11:12:35

Humidity:63.4 %

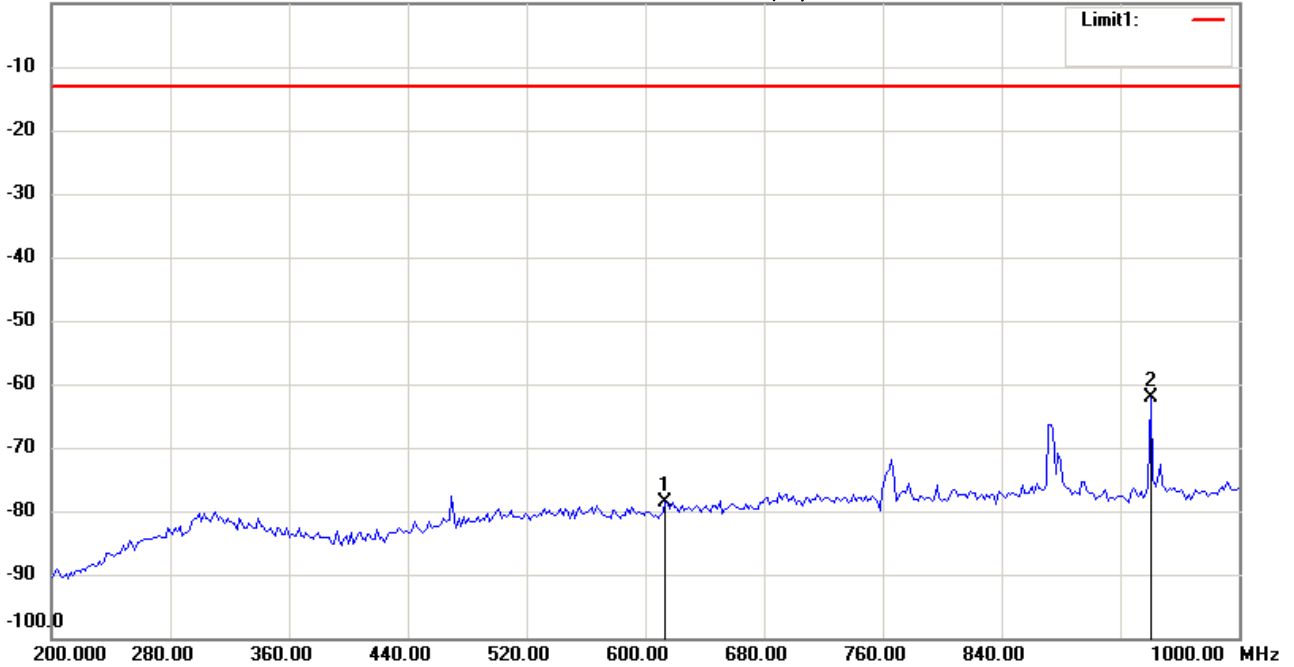

Site : Chamber

Condition : FCC 74.861 spurious emission

Polarization: *Horizontal*

EUT : W6M21504-14935

Power : 2.4 Vd.c.

M/N:

Distance: 3m

Test Mode : 470.1MHz

Note :

Mk.	Frequency (MHz)	Reading (dBm)	Detector	Corr. factor (dB)	Result (dBm)	Limit (dBm)	Ant.Pos (cm)	Tab.Pos (deg.)	Margin (dB)	Comment
	613.6273	-75.19	peak	-3.31	-78.50	-13.00	150	163	-65.50	
*	940.6814	-62.00	peak	-0.23	-62.23	-13.00	150	233	-49.23	



Radiated Emission Measurement

Operator: Spencer

File :2

Data :#2

Date: 2015/4/15

Temperature:27.8 °C

0.0 dBm

Time: 下午 11:10:42

Humidity:63.4 %

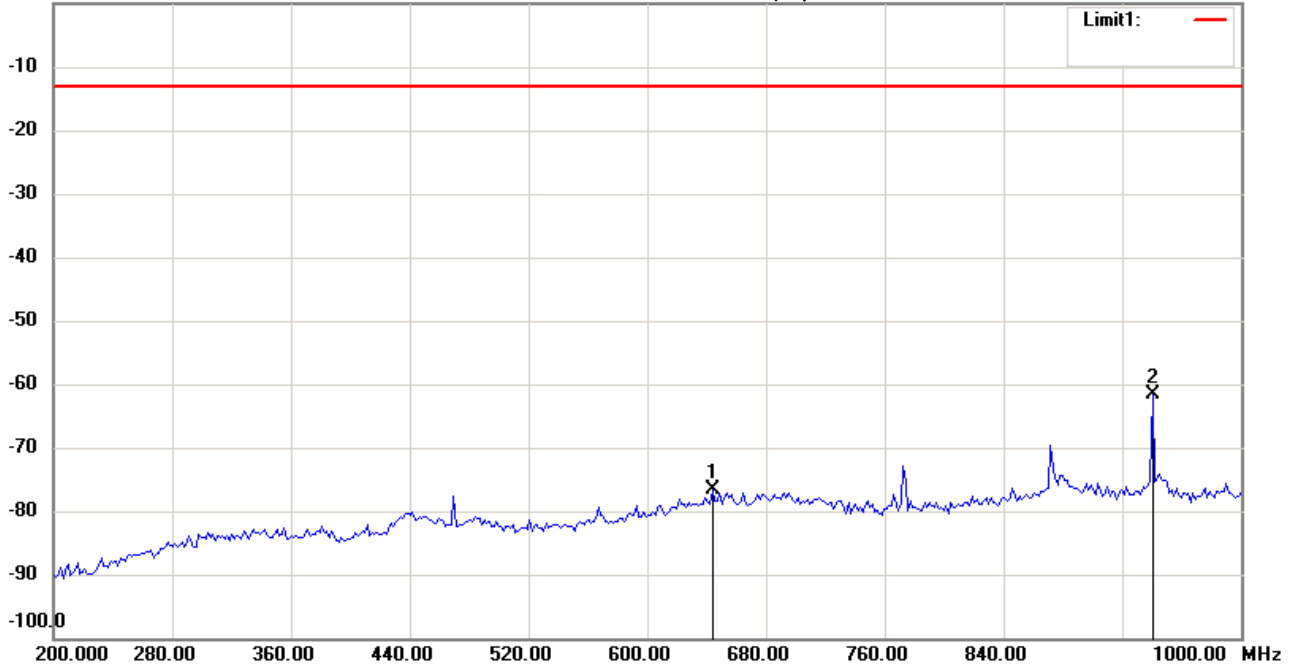

Site : Chamber

Condition : FCC 74.861 spurious emission

Polarization: Vertical

EUT : W6M21504-14935

Power : 2.4 Vd.c.

M/N:

Distance: 3m

Test Mode : 470.1MHz

Note :

Mk.	Frequency (MHz)	Reading (dBm)	Detector	Corr. factor (dB)	Result (dBm)	Limit (dBm)	Ant.Pos (cm)	Tab.Pos (deg.)	Margin (dB)	Comment
	644.0882	-75.31	peak	-1.21	-76.52	-13.00	150	289	-63.52	
*	940.6814	-61.86	peak	0.25	-61.61	-13.00	150	306	-48.61	



Radiated Emission Measurement

Operator: Spencer

File :3

Data :#1

Date: 2015/4/16

Temperature:27.8 °C

0.0 dBm

Time: 上午 12:33:17

Humidity:63.4 %

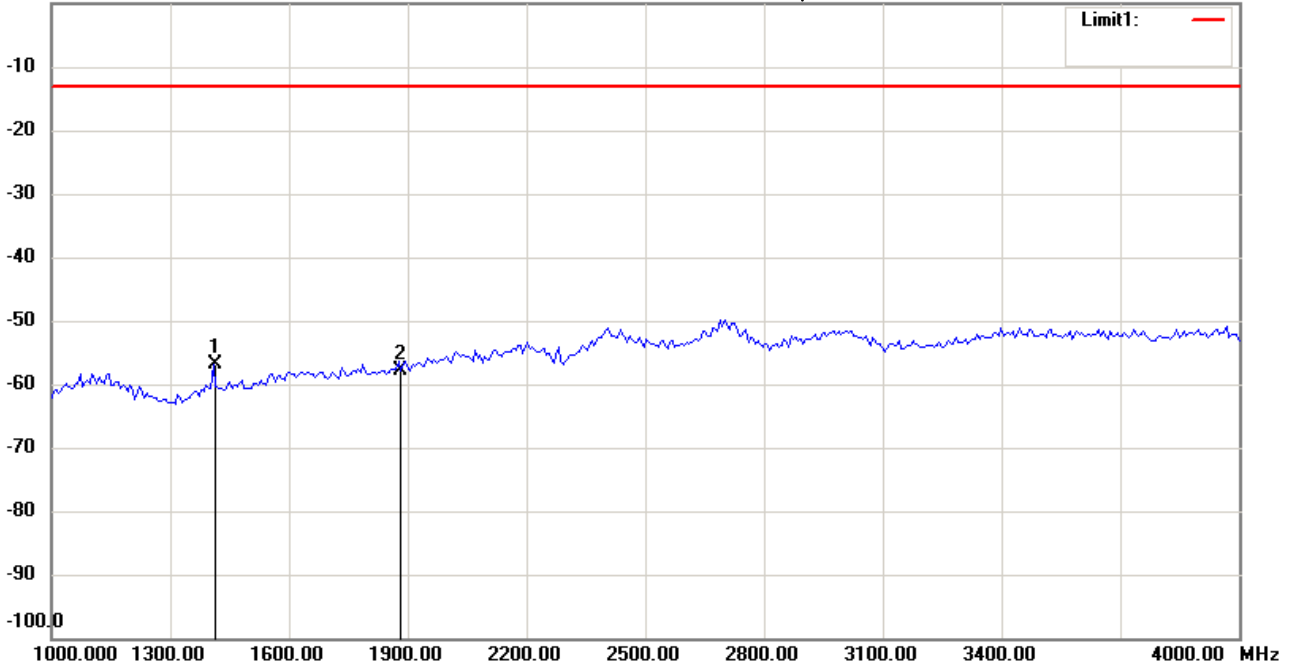

Site : Chamber

Condition : FCC 74.861 spurious emission

Polarization: *Horizontal*

EUT : W6M21504-14935

Power : 2.4 Vd.c.

M/N:

Distance: 3m

Test Mode : 470.1MHz

Note :

Mk.	Frequency (MHz)	Reading (dBm)	Detector	Corr. factor (dB)	Result (dBm)	Limit (dBm)	Ant.Pos (cm)	Tab.Pos (deg.)	Margin (dB)	Comment
*	1408.818	-57.75	peak	0.82	-56.93	-13.00	150	163	-43.93	
	1878.424	-61.49	peak	3.50	-57.99	-13.00	150	225	-44.99	



Radiated Emission Measurement

Operator: Spencer

File :3

Data :#3

Date: 2015/4/16

Temperature:27.8 °C

0.0 dBm

Time: 上午 12:37:27

Humidity:63.4 %

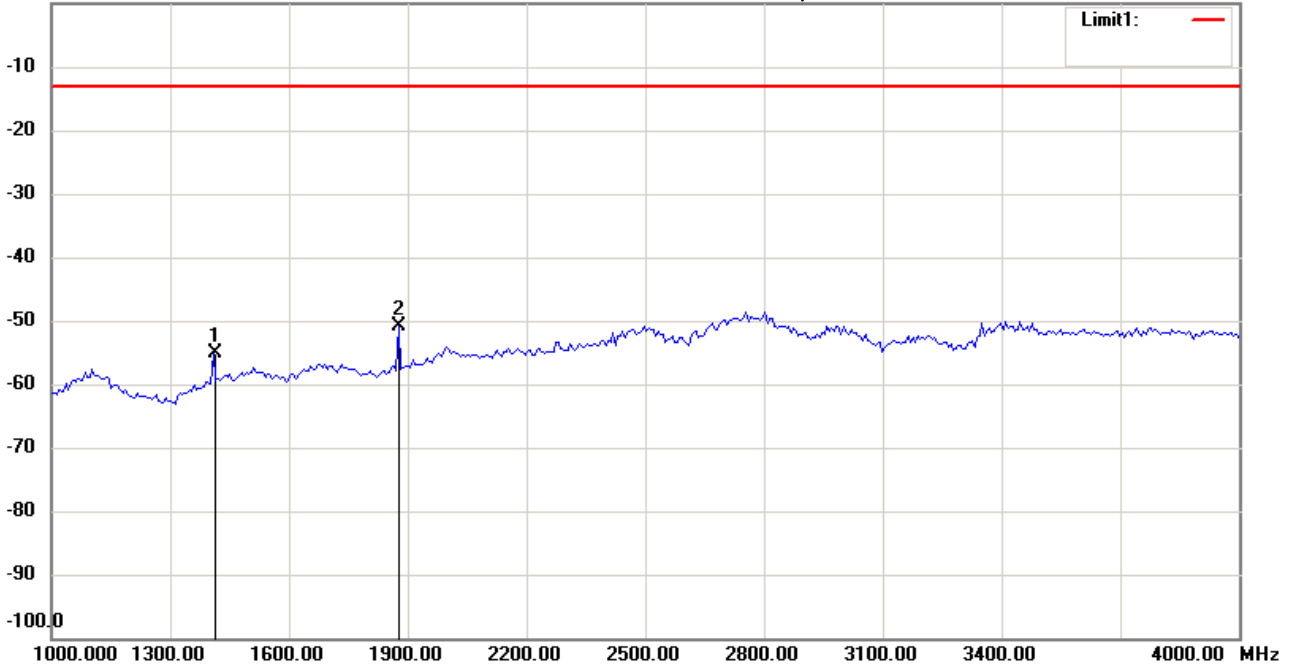

Site : Chamber

Condition : FCC 74.861 spurious emission

Polarization: *Vertical*

EUT : W6M21504-14935

Power : 2.4 Vd.c.

M/N:

Distance: 3m

Test Mode : 470.1MHz

Note :

Mk.	Frequency (MHz)	Reading (dBm)	Detector	Corr. factor (dB)	Result (dBm)	Limit (dBm)	Ant.Pos (cm)	Tab.Pos (deg.)	Margin (dB)	Comment
	1408.818	-56.60	peak	1.60	-55.00	-13.00	150	103	-42.00	
*	1877.755	-54.43	peak	3.45	-50.98	-13.00	150	223	-37.98	



Radiated Emission Measurement

Operator: Spencer

File :3

Data :#2

Date: 2015/4/16

Temperature:27.8 °C

0.0 dBm

Time: 上午 12:35:44

Humidity:63.4 %

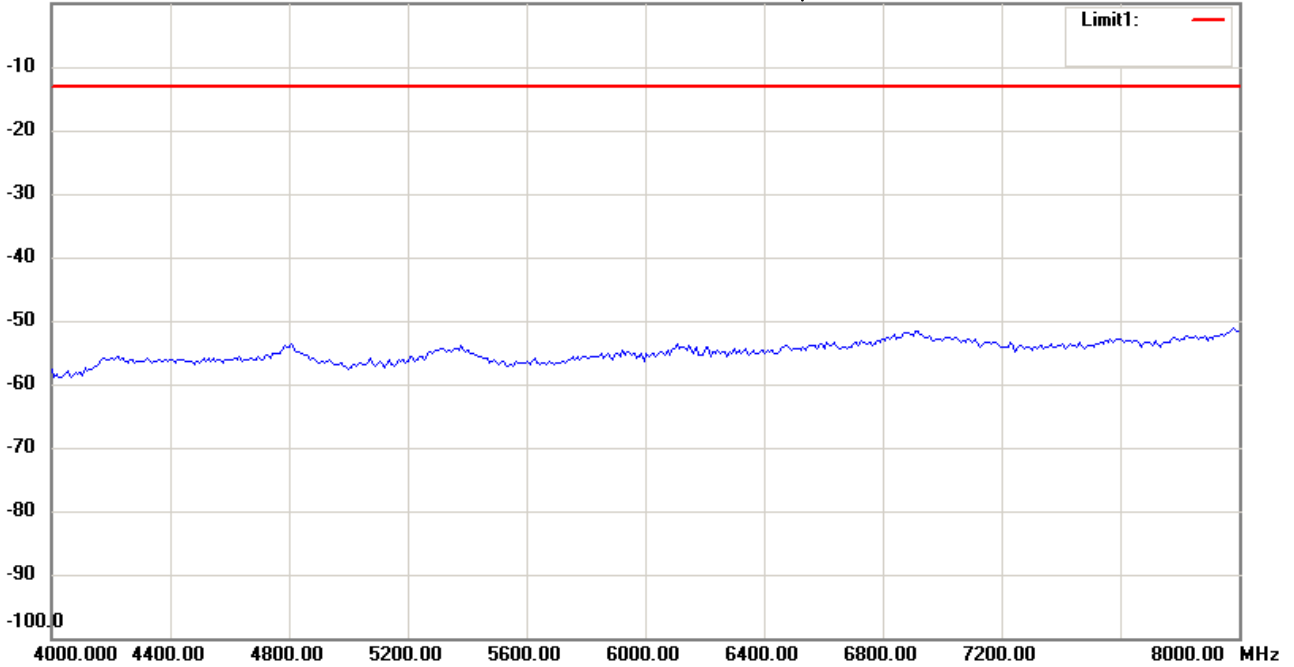

Site : Chamber

Condition : FCC 74.861 spurious emission

Polarization: *Horizontal*

EUT : W6M21504-14935

Power : 2.4 Vd.c.

M/N:

Distance: 3m

Test Mode : 470.1MHz

Note :

Mk.	Frequency (MHz)	Reading (dBm)	Detector	Corr. factor (dB)	Result (dBm)	Limit (dBm)	Ant.Pos (cm)	Tab.Pos (deg.)	Margin (dB)	Comment
-----	-----------------	---------------	----------	-------------------	--------------	-------------	--------------	----------------	-------------	---------



Radiated Emission Measurement

Operator: Spencer

File :3

Data :#4

Date: 2015/4/16

Temperature:27.8 °C

0.0 dBm

Time: 上午 12:39:04

Humidity:63.4 %

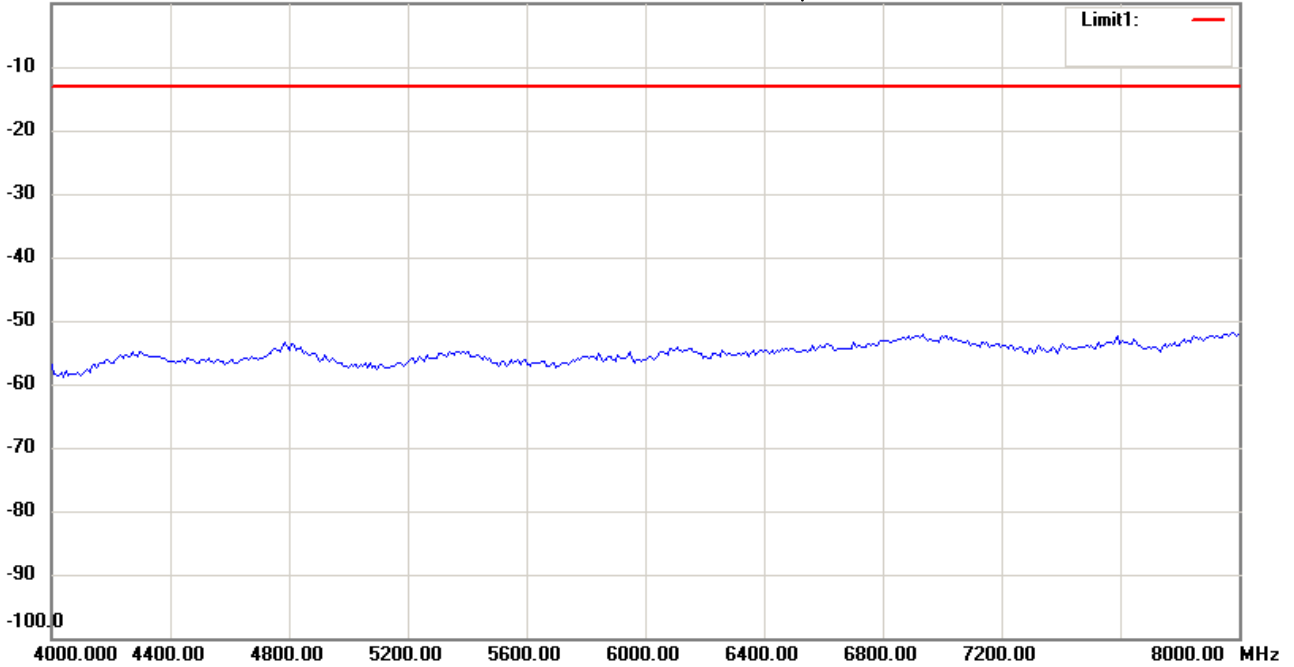

Site : Chamber

Condition : FCC 74.861 spurious emission

Polarization: *Vertical*

EUT : W6M21504-14935

Power : 2.4 Vd.c.

M/N:

Distance: 3m

Test Mode : 470.1MHz

Note :

Mk.	Frequency (MHz)	Reading (dBm)	Detector	Corr. factor (dB)	Result (dBm)	Limit (dBm)	Ant.Pos (cm)	Tab.Pos (deg.)	Margin (dB)	Comment
-----	-----------------	---------------	----------	-------------------	--------------	-------------	--------------	----------------	-------------	---------





Radiated Emission Measurement

Operator: Spencer

File :1

Data :#1

Date: 2015/4/15

Temperature:27.8 °C

5.0 dBm

Time: 下午 09:55:54

Humidity:63.4 %

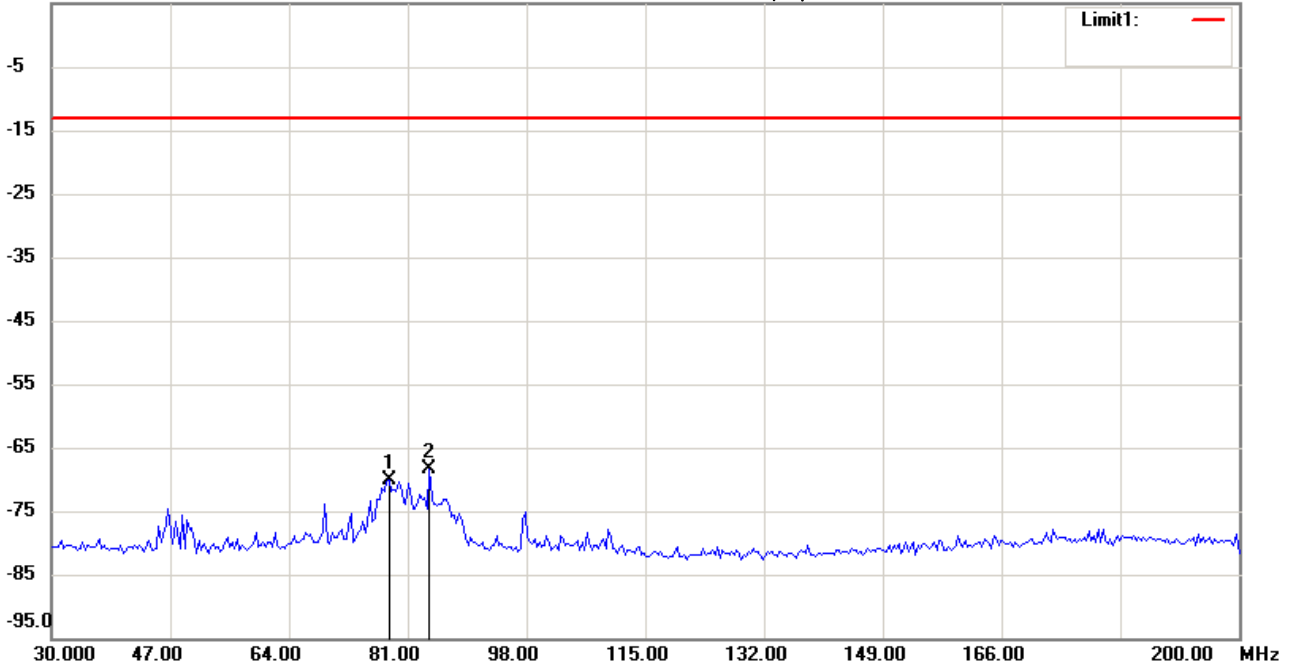

Site : Chamber

Condition : FCC 74.861 spurious emission

Polarization: *Horizontal*

EUT : W6M21504-14935

Power : 2.4 Vd.c.

M/N:

Distance: 3m

Test Mode : 539MHz

Note :

Mk.	Frequency (MHz)	Reading (dBm)	Detector	Corr. factor (dB)	Result (dBm)	Limit (dBm)	Ant.Pos (cm)	Tab.Pos (deg.)	Margin (dB)	Comment
	78.3768	-94.05	peak	23.86	-70.19	-13.00	150	134	-57.19	
*	84.1683	-92.11	peak	23.73	-68.38	-13.00	150	188	-55.38	



Radiated Emission Measurement

Operator: Spencer

File :1

Data :#2

Date: 2015/4/15

Temperature:27.8 °C

5.0 dBm

Time: 下午 09:57:50

Humidity:63.4 %

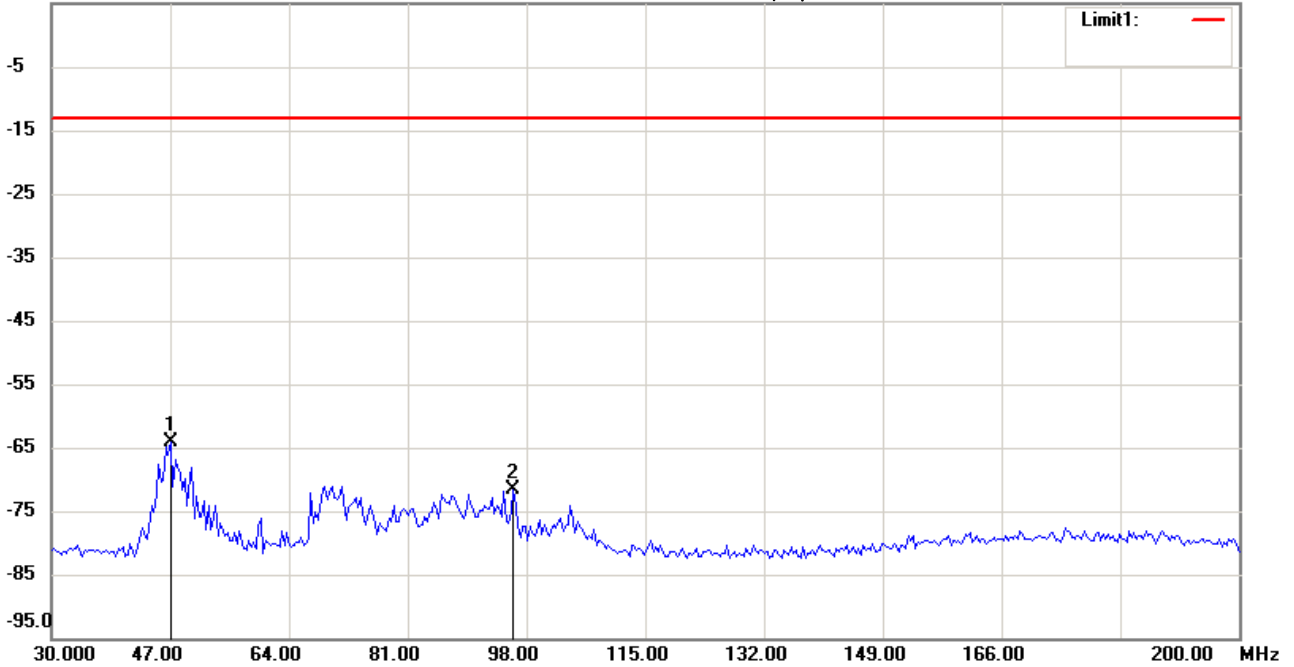

Site : Chamber

Condition : FCC 74.861 spurious emission

Polarization: *Vertical*

EUT : W6M21504-14935

Power : 2.4 Vd.c.

M/N:

Distance: 3m

Test Mode : 539MHz

Note :

Mk.	Frequency (MHz)	Reading (dBm)	Detector	Corr. factor (dB)	Result (dBm)	Limit (dBm)	Ant.Pos (cm)	Tab.Pos (deg.)	Margin (dB)	Comment
*	47.0341	-87.62	peak	23.43	-64.19	-13.00	150	134	-51.19	
	96.0922	-95.67	peak	24.14	-71.53	-13.00	150	200	-58.53	



Radiated Emission Measurement

Operator: Spencer

File :2

Data :#1

Date: 2015/4/15

Temperature:27.8 °C

0.0 dBm

Time: 下午 11:15:44

Humidity:63.4 %

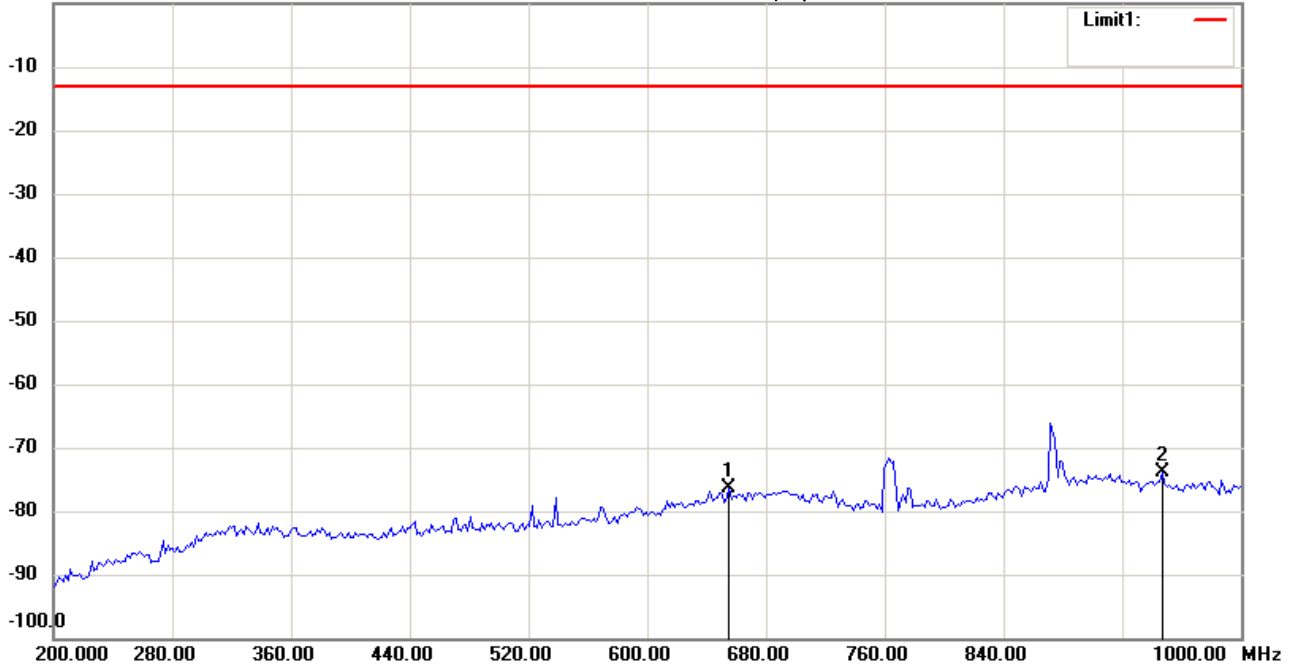

Site : Chamber

Condition : FCC 74.861 spurious emission

Polarization: *Horizontal*

EUT : W6M21504-14935

Power : 2.4 Vd.c.

M/N:

Distance: 3m

Test Mode : 539MHz

Note :

Mk.	Frequency (MHz)	Reading (dBm)	Detector	Corr. factor (dB)	Result (dBm)	Limit (dBm)	Ant.Pos (cm)	Tab.Pos (deg.)	Margin (dB)	Comment
	655.3106	-75.38	peak	-0.87	-76.25	-13.00	150	130	-63.25	
*	947.0942	-73.96	peak	0.07	-73.89	-13.00	150	220	-60.89	



Radiated Emission Measurement

Operator: Spencer

File :2

Data :#2

Date: 2015/4/15

Temperature:27.8 °C

0.0 dBm

Time: 下午 11:17:34

Humidity:63.4 %

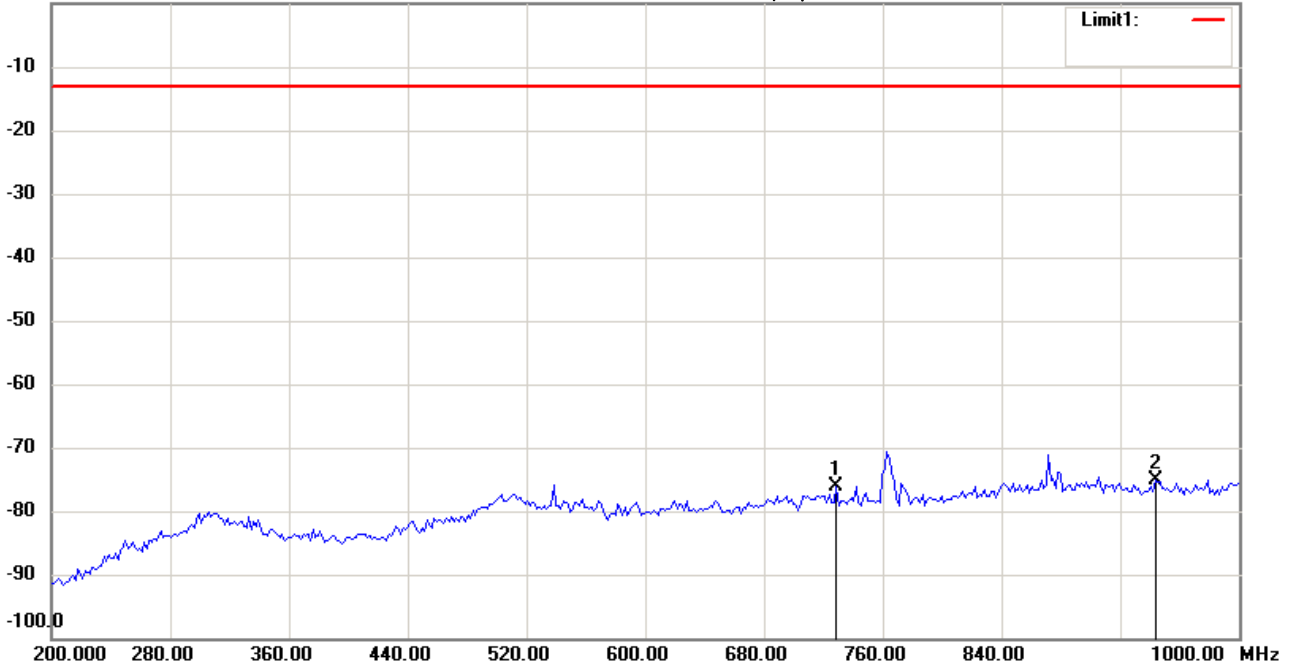

Site : Chamber

Condition : FCC 74.861 spurious emission

Polarization: *Vertical*

EUT : W6M21504-14935

Power : 2.4 Vd.c.

M/N:

Distance: 3m

Test Mode : 539MHz

Note :

Mk.	Frequency (MHz)	Reading (dBm)	Detector	Corr. factor (dB)	Result (dBm)	Limit (dBm)	Ant.Pos (cm)	Tab.Pos (deg.)	Margin (dB)	Comment
	729.0581	-74.74	peak	-1.36	-76.10	-13.00	150	303	-63.10	
*	943.8878	-74.90	peak	-0.28	-75.18	-13.00	150	169	-62.18	



Radiated Emission Measurement

Operator: Spencer

File :3

Data :#1

Date: 2015/4/16

Temperature:27.8 °C

0.0 dBm

Time: 上午 12:21:09

Humidity:63.4 %

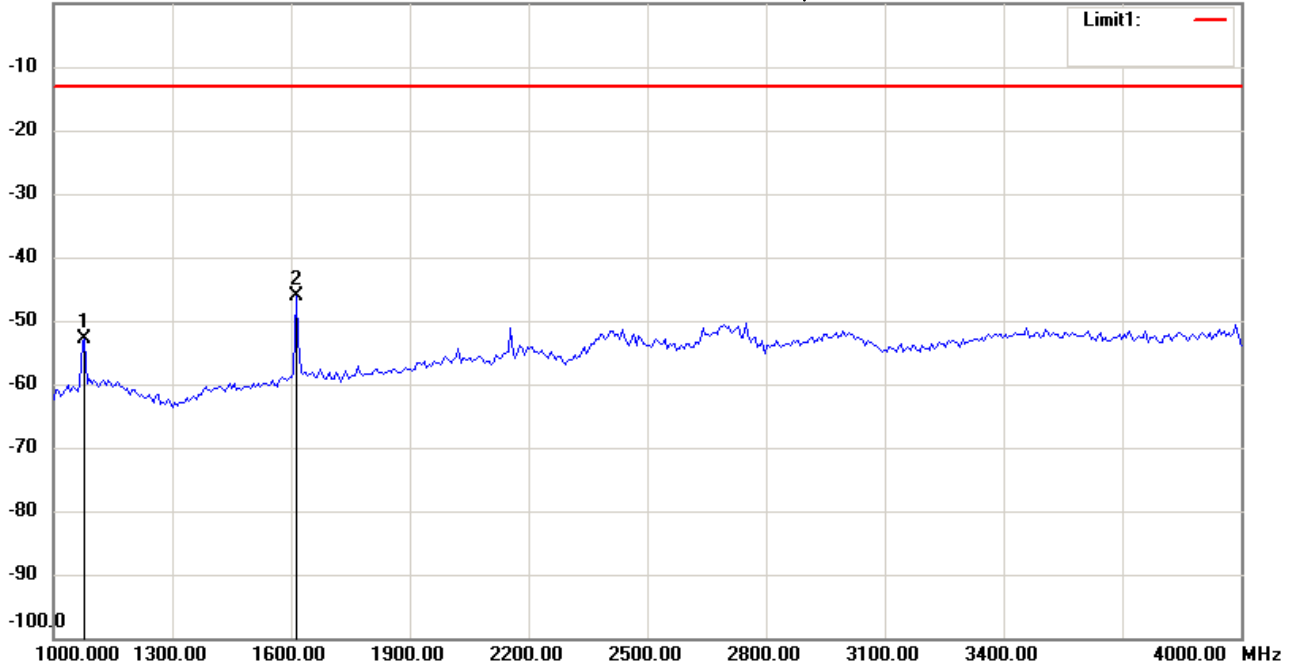

Site : Chamber

Condition : FCC 74.861 spurious emission

Polarization: *Horizontal*

EUT : W6M21504-14935

Power : 2.4 Vd.c.

M/N:

Distance: 3m

Test Mode : 539MHz

Note :

Mk.	Frequency (MHz)	Reading (dBm)	Detector	Corr. factor (dB)	Result (dBm)	Limit (dBm)	Ant.Pos (cm)	Tab.Pos (deg.)	Margin (dB)	Comment
	1078.156	-55.24	peak	2.27	-52.97	-13.00	150	206	-39.97	
*	1613.226	-48.77	peak	2.73	-46.04	-13.00	150	169	-33.04	



Radiated Emission Measurement

Operator: Spencer

File :3

Data :#3

Date: 2015/4/16

Temperature:27.8 °C

0.0 dBm

Time: 上午 12:24:24

Humidity:63.4 %

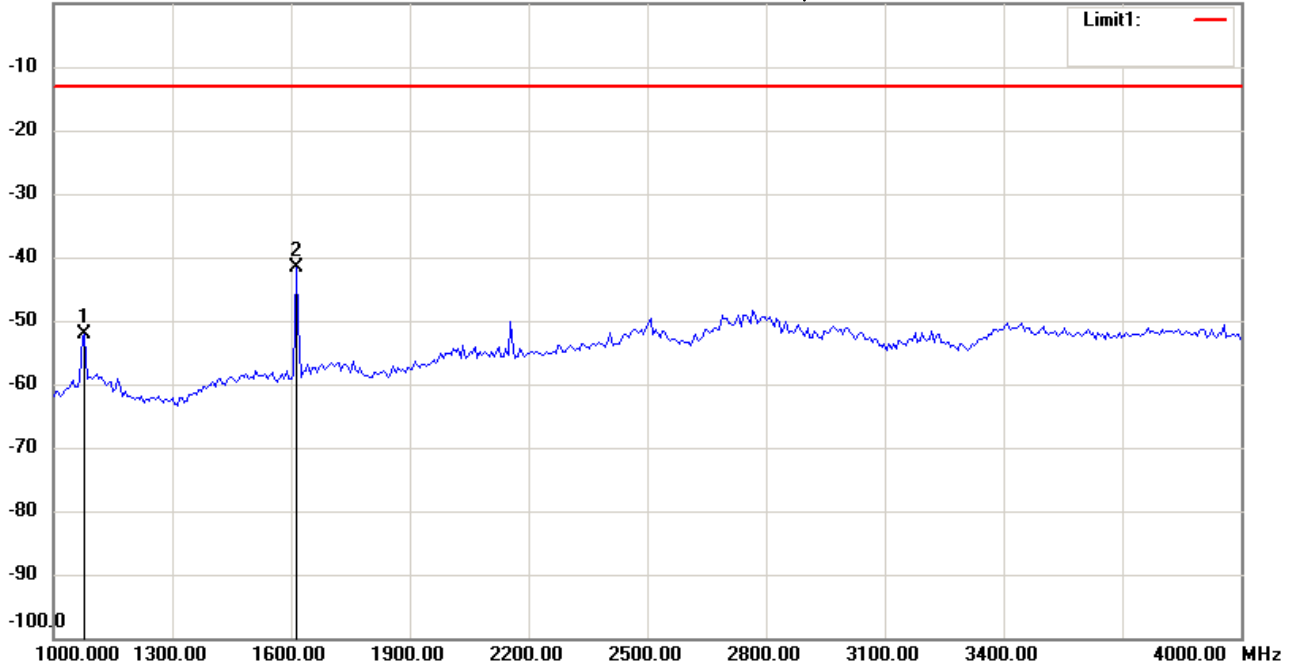

Site : Chamber

Condition : FCC 74.861 spurious emission

Polarization: *Vertical*

EUT : W6M21504-14935

Power : 2.4 Vd.c.

M/N:

Distance: 3m

Test Mode : 539MHz

Note :

Mk.	Frequency (MHz)	Reading (dBm)	Detector	Corr. factor (dB)	Result (dBm)	Limit (dBm)	Ant.Pos (cm)	Tab.Pos (deg.)	Margin (dB)	Comment
	1078.156	-54.90	peak	2.86	-52.04	-13.00	150	136	-39.04	
*	1613.226	-43.89	peak	2.36	-41.53	-13.00	150	299	-28.53	



Radiated Emission Measurement

Operator: Spencer

File :3

Data :#2

Date: 2015/4/16

Temperature:27.8 °C

0.0 dBm

Time: 上午 12:22:44

Humidity:63.4 %

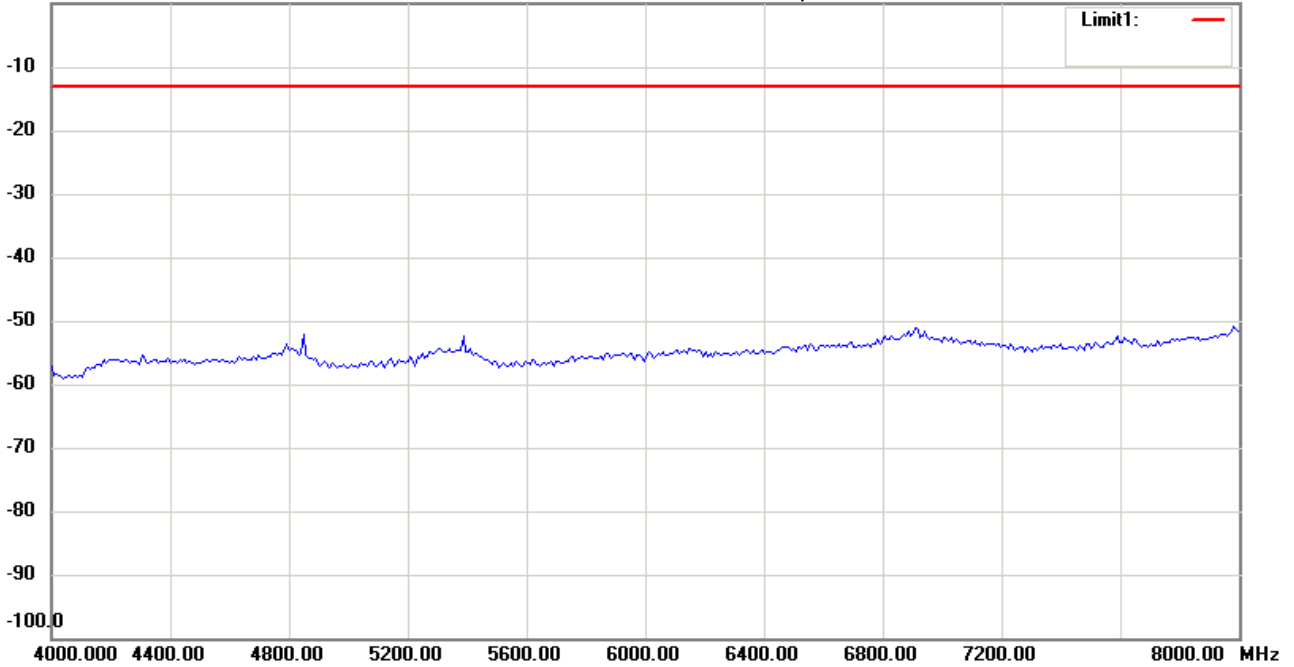

Site : Chamber

Condition : FCC 74.861 spurious emission

Polarization: *Horizontal*

EUT : W6M21504-14935

Power : 2.4 Vd.c.

M/N:

Distance: 3m

Test Mode : 539MHz

Note :

Mk.	Frequency (MHz)	Reading (dBm)	Detector	Corr. factor (dB)	Result (dBm)	Limit (dBm)	Ant.Pos (cm)	Tab.Pos (deg.)	Margin (dB)	Comment
-----	-----------------	---------------	----------	-------------------	--------------	-------------	--------------	----------------	-------------	---------



Radiated Emission Measurement

Operator: Spencer

File :3

Data :#4

Date: 2015/4/16

Temperature:27.8 °C

0.0 dBm

Time: 上午 12:26:46

Humidity:63.4 %

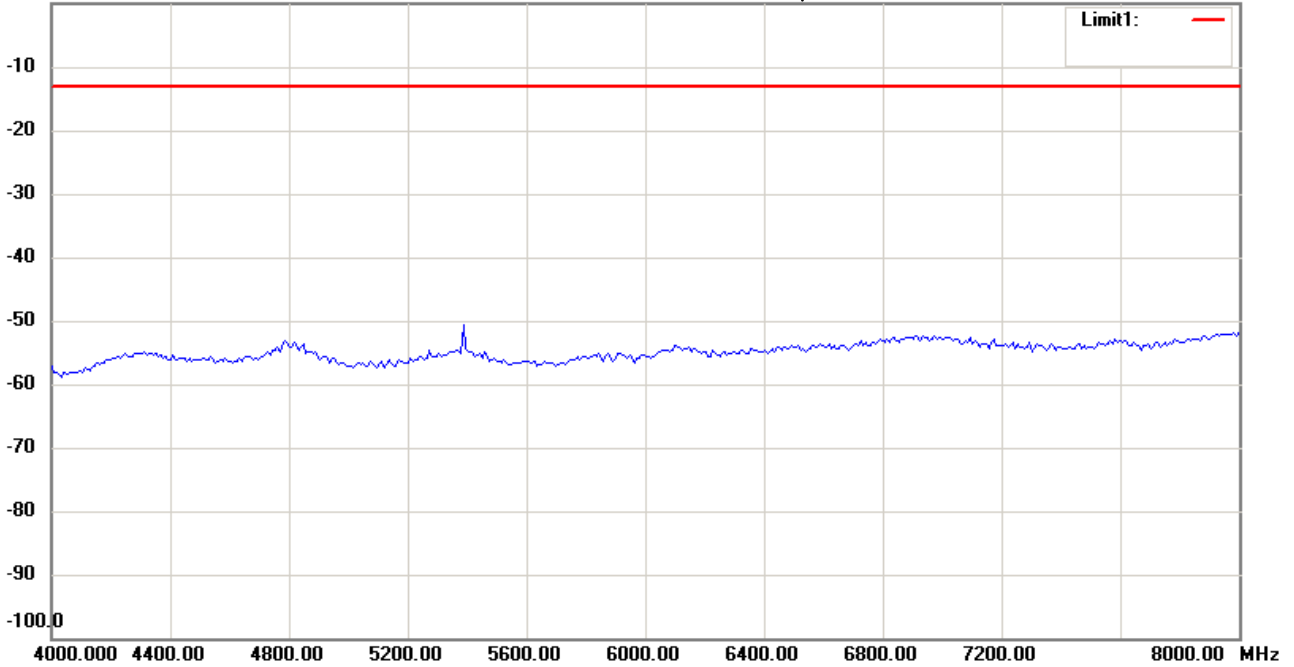

Site : Chamber

Condition : FCC 74.861 spurious emission

Polarization: *Vertical*

EUT : W6M21504-14935

Power : 2.4 Vd.c.

M/N:

Distance: 3m

Test Mode : 539MHz

Note :

Mk.	Frequency (MHz)	Reading (dBm)	Detector	Corr. factor (dB)	Result (dBm)	Limit (dBm)	Ant.Pos (cm)	Tab.Pos (deg.)	Margin (dB)	Comment
-----	-----------------	---------------	----------	-------------------	--------------	-------------	--------------	----------------	-------------	---------





Radiated Emission Measurement

Operator: Spencer

File :1

Data :#1

Date: 2015/4/15

Temperature:27.8 °C

5.0 dBm

Time: 下午 10:00:50

Humidity:63.4 %

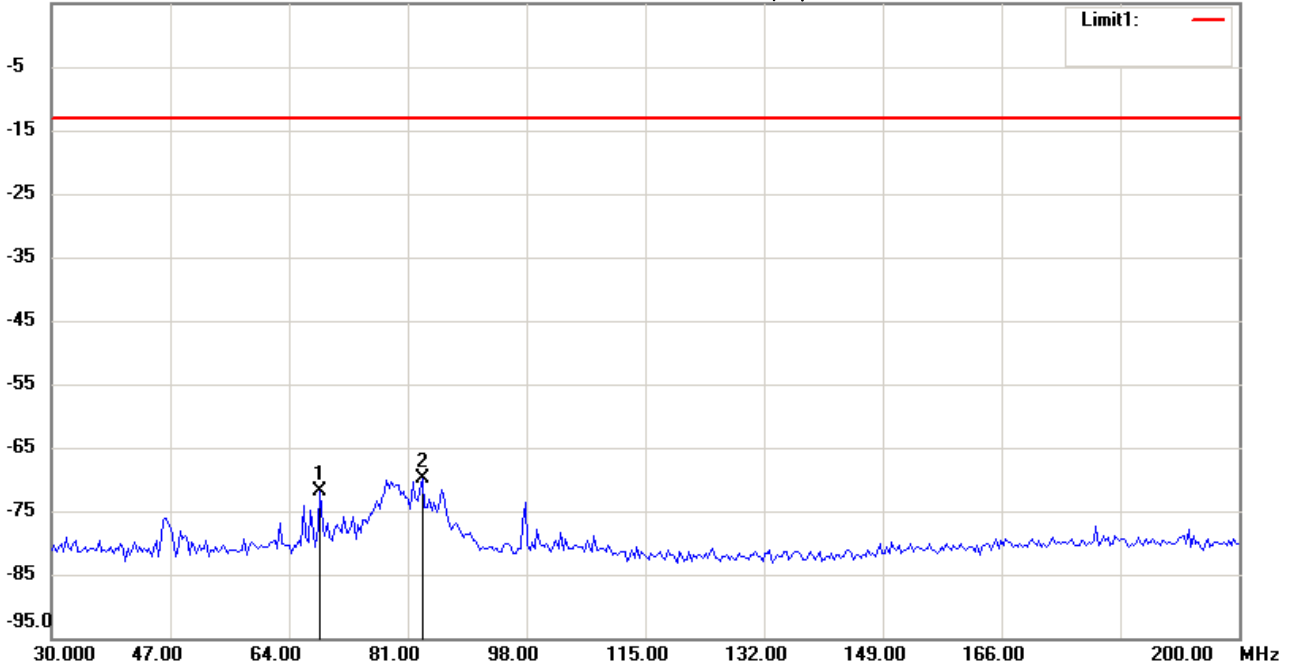

Site : Chamber

Condition : FCC 74.861 spurious emission

Polarization: *Horizontal*

EUT : W6M21504-14935

Power : 2.4 Vd.c.

M/N:

Distance: 3m

Test Mode : 607.9MHz

Note :

Mk.	Frequency (MHz)	Reading (dBm)	Detector	Corr. factor (dB)	Result (dBm)	Limit (dBm)	Ant.Pos (cm)	Tab.Pos (deg.)	Margin (dB)	Comment
	68.4970	-95.88	peak	23.98	-71.90	-13.00	150	320	-58.90	
*	83.1463	-93.69	peak	23.76	-69.93	-13.00	150	164	-56.93	



Radiated Emission Measurement

Operator: Spencer

File :1

Data :#2

Date: 2015/4/15

Temperature:27.8 °C

5.0 dBm

Time: 下午 10:02:27

Humidity:63.4 %

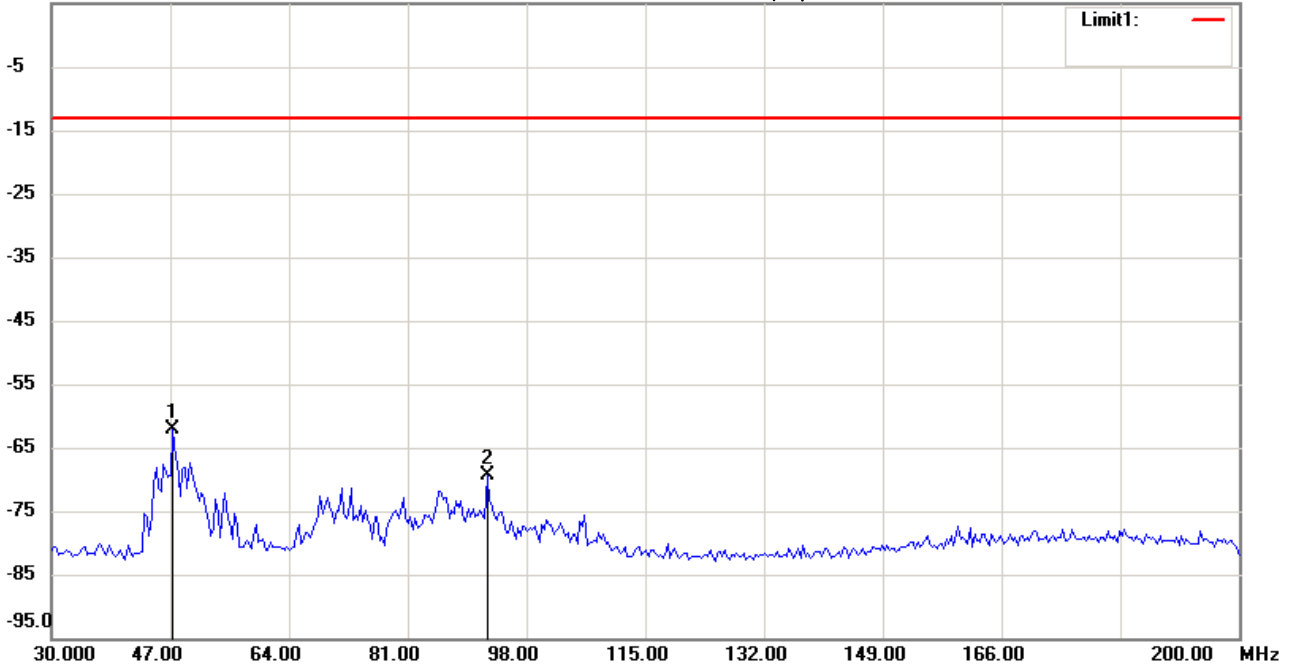

Site : Chamber

Condition : FCC 74.861 spurious emission

Polarization: *Vertical*

EUT : W6M21504-14935

Power : 2.4 Vd.c.

M/N:

Distance: 3m

Test Mode : 607.9MHz

Note :

Mk.	Frequency (MHz)	Reading (dBm)	Detector	Corr. factor (dB)	Result (dBm)	Limit (dBm)	Ant.Pos (cm)	Tab.Pos (deg.)	Margin (dB)	Comment
*	47.3747	-85.50	peak	23.43	-62.07	-13.00	150	147	-49.07	
	92.3447	-93.49	peak	24.00	-69.49	-13.00	150	166	-56.49	



Radiated Emission Measurement

Operator: Spencer

File :2

Data :#1

Date: 2015/4/15

Temperature:27.8 °C

0.0 dBm

Time: 下午 11:20:41

Humidity:63.4 %

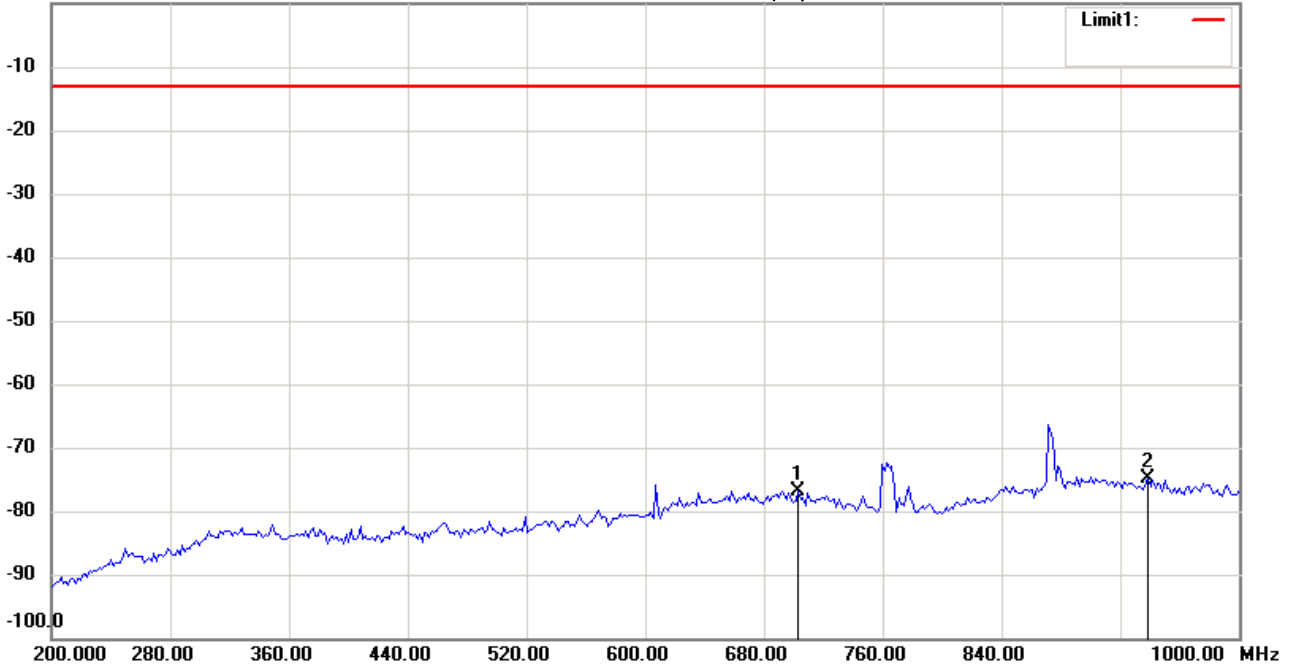

Site : Chamber

Condition : FCC 74.861 spurious emission

Polarization: *Horizontal*

EUT : W6M21504-14935

Power : 2.4 Vd.c.

M/N:

Distance: 3m

Test Mode : 607.9MHz

Note :

Mk.	Frequency (MHz)	Reading (dBm)	Detector	Corr. factor (dB)	Result (dBm)	Limit (dBm)	Ant.Pos (cm)	Tab.Pos (deg.)	Margin (dB)	Comment
	703.4068	-76.07	peak	-0.92	-76.99	-13.00	150	103	-63.99	
*	939.0782	-75.15	peak	0.30	-74.85	-13.00	150	330	-61.85	



Radiated Emission Measurement

Operator: Spencer

File :2

Data :#2

Date: 2015/4/15

Temperature:27.8 °C

0.0 dBm

Time: 下午 11:23:32

Humidity:63.4 %

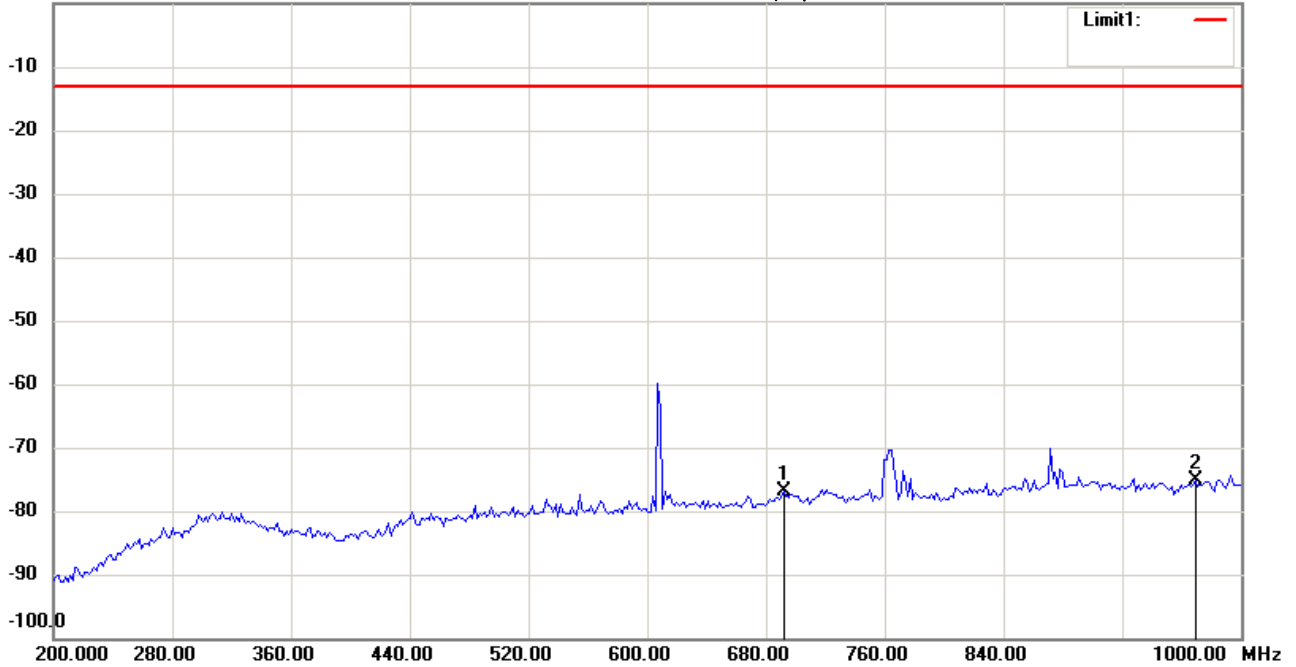

Site : Chamber

Condition : FCC 74.861 spurious emission

Polarization: *Vertical*

EUT : W6M21504-14935

Power : 2.4 Vd.c.

M/N:

Distance: 3m

Test Mode : 607.9MHz

Note :

Mk.	Frequency (MHz)	Reading (dBm)	Detector	Corr. factor (dB)	Result (dBm)	Limit (dBm)	Ant.Pos (cm)	Tab.Pos (deg.)	Margin (dB)	Comment
	692.1844	-75.57	peak	-1.39	-76.96	-13.00	150	106	-63.96	
*	969.5391	-74.83	peak	-0.20	-75.03	-13.00	150	37	-62.03	



Radiated Emission Measurement

Operator: Spencer

File :3

Data :#1

Date: 2015/4/16

Temperature:27.8 °C

0.0 dBm

Time: 上午 12:13:08

Humidity:63.4 %

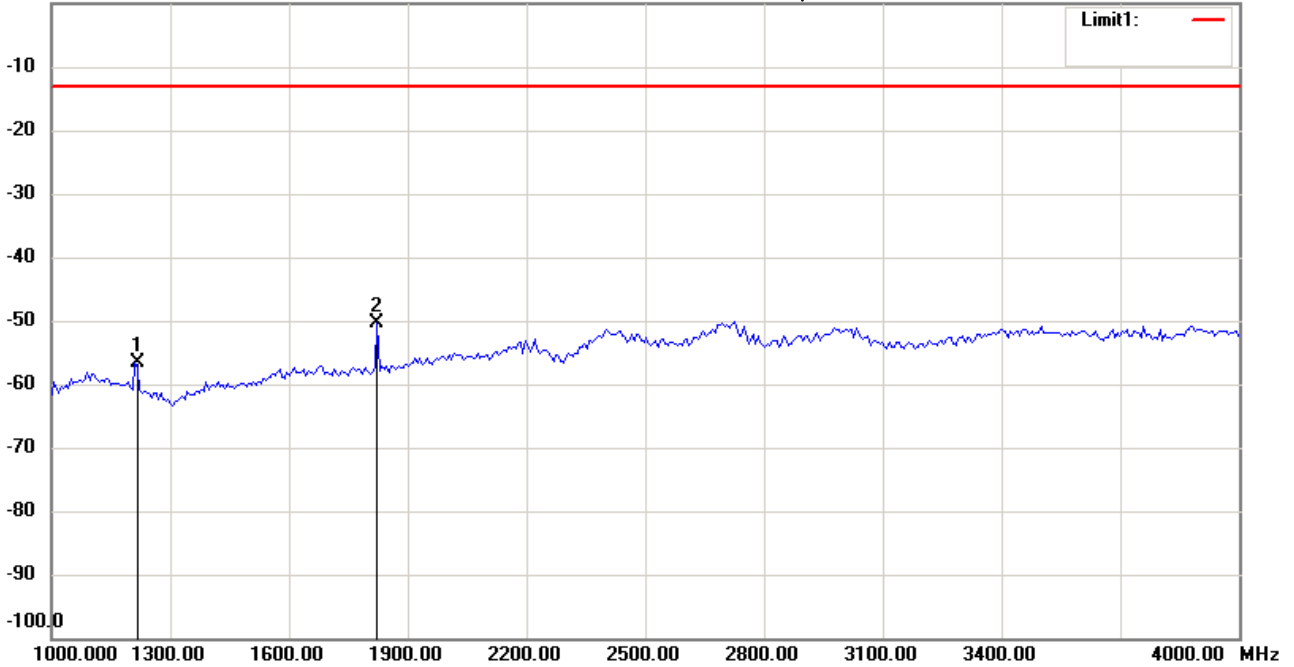

Site : Chamber

Condition : FCC 74.861 spurious emission

Polarization: *Horizontal*

EUT : W6M21504-14935

Power : 2.4 Vd.c.

M/N:

Distance: 3m

Test Mode : 607.9MHz

Note :

Mk.	Frequency (MHz)	Reading (dBm)	Detector	Corr. factor (dB)	Result (dBm)	Limit (dBm)	Ant.Pos (cm)	Tab.Pos (deg.)	Margin (dB)	Comment
	1210.421	-57.41	peak	0.78	-56.63	-13.00	150	209	-43.63	
*	1823.647	-53.26	peak	2.97	-50.29	-13.00	150	163	-37.29	



Radiated Emission Measurement

Operator: Spencer

File :3

Data :#3

Date: 2015/4/16

Temperature:27.8 °C

0.0 dBm

Time: 上午 12:16:38

Humidity:63.4 %

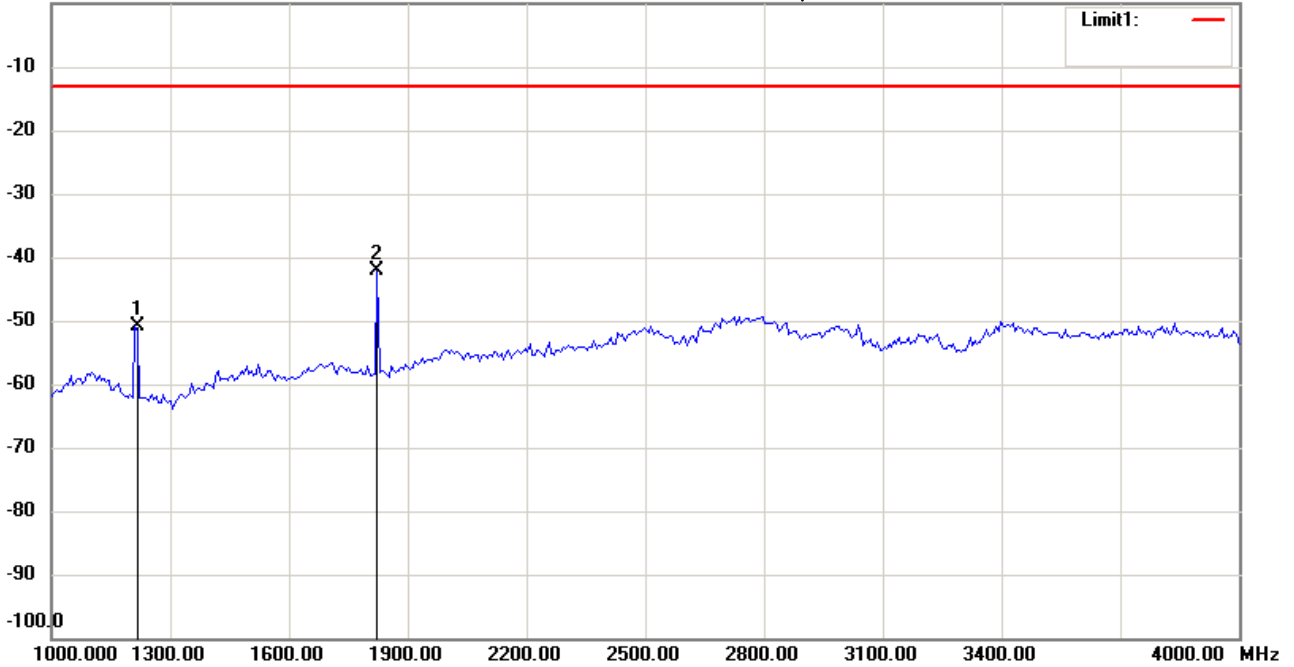

Site : Chamber

Condition : FCC 74.861 spurious emission

Polarization: *Vertical*

EUT : W6M21504-14935

Power : 2.4 Vd.c.

M/N:

Distance: 3m

Test Mode : 607.9MHz

Note :

Mk.	Frequency (MHz)	Reading (dBm)	Detector	Corr. factor (dB)	Result (dBm)	Limit (dBm)	Ant.Pos (cm)	Tab.Pos (deg.)	Margin (dB)	Comment
	1210.421	-50.79	peak	-0.18	-50.97	-13.00	150	201	-37.97	
*	1823.647	-44.93	peak	2.80	-42.13	-13.00	150	148	-29.13	



Radiated Emission Measurement

Operator: Spencer

File :3

Data :#2

Date: 2015/4/16

Temperature:27.8 °C

0.0 dBm

Time: 上午 12:15:12

Humidity:63.4 %

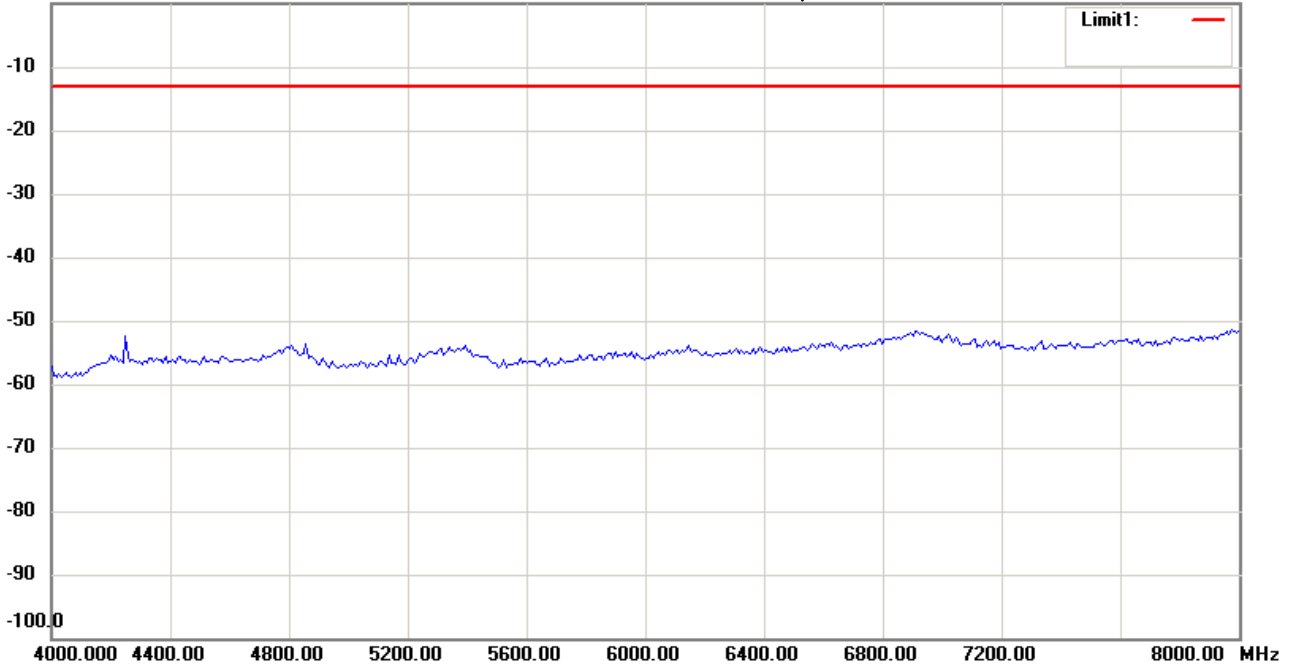

Site : Chamber

Condition : FCC 74.861 spurious emission

Polarization: *Horizontal*

EUT : W6M21504-14935

Power : 2.4 Vd.c.

M/N:

Distance: 3m

Test Mode : 607.9MHz

Note :

Mk.	Frequency (MHz)	Reading (dBm)	Detector	Corr. factor (dB)	Result (dBm)	Limit (dBm)	Ant.Pos (cm)	Tab.Pos (deg.)	Margin (dB)	Comment
-----	-----------------	---------------	----------	-------------------	--------------	-------------	--------------	----------------	-------------	---------



Radiated Emission Measurement

Operator: Spencer

File :3

Data :#4

Date: 2015/4/16

Temperature:27.8 °C

0.0 dBm

Time: 上午 12:17:35

Humidity:63.4 %

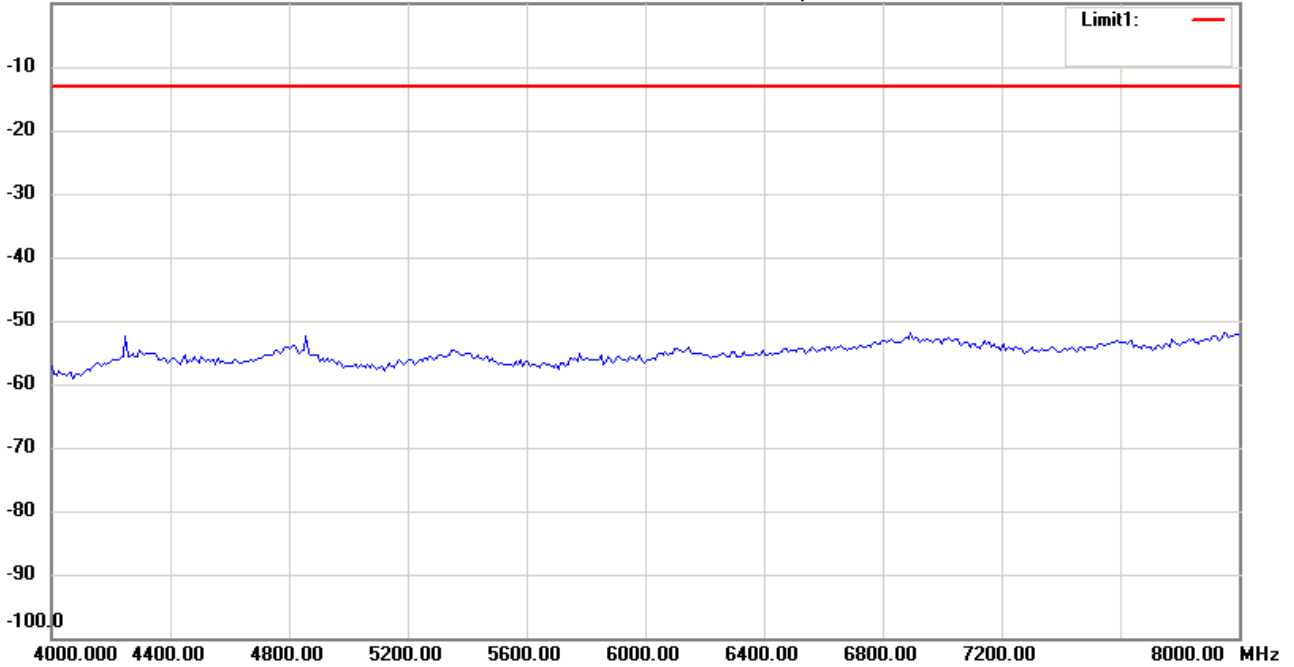

Site : Chamber

Condition : FCC 74.861 spurious emission

Polarization: *Vertical*

EUT : W6M21504-14935

Power : 2.4 Vd.c.

M/N:

Distance: 3m

Test Mode : 607.9MHz

Note :

Mk.	Frequency (MHz)	Reading (dBm)	Detector	Corr. factor (dB)	Result (dBm)	Limit (dBm)	Ant.Pos (cm)	Tab.Pos (deg.)	Margin (dB)	Comment
-----	-----------------	---------------	----------	-------------------	--------------	-------------	--------------	----------------	-------------	---------





Radiated Emission Measurement

Operator: Spencer

File :1

Data :#1

Date: 2015/4/15

Temperature:27.8 °C

5.0 dBm

Time: 下午 10:04:31

Humidity:63.4 %

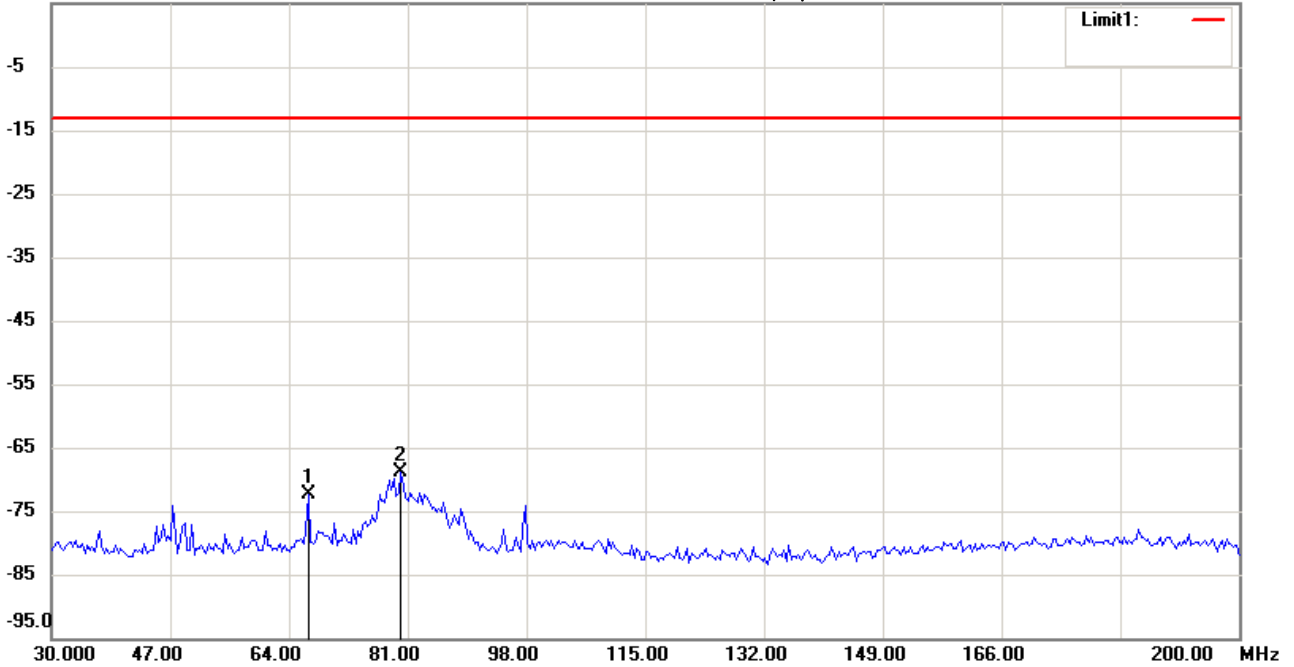

Site : Chamber

Condition : FCC 74.861 spurious emission

Polarization: *Horizontal*

EUT : W6M21504-14935

Power : 2.4 Vd.c.

M/N:

Distance: 3m

Test Mode : 614.1MHz

Note :

Mk.	Frequency (MHz)	Reading (dBm)	Detector	Corr. factor (dB)	Result (dBm)	Limit (dBm)	Ant.Pos (cm)	Tab.Pos (deg.)	Margin (dB)	Comment
	66.7936	-96.33	peak	23.97	-72.36	-13.00	150	130	-59.36	
*	80.0802	-92.81	peak	23.84	-68.97	-13.00	150	288	-55.97	



Radiated Emission Measurement

Operator: Spencer

File :1

Data :#2

Date: 2015/4/15

Temperature:27.8 °C

5.0 dBm

Time: 下午 10:07:23

Humidity:63.4 %

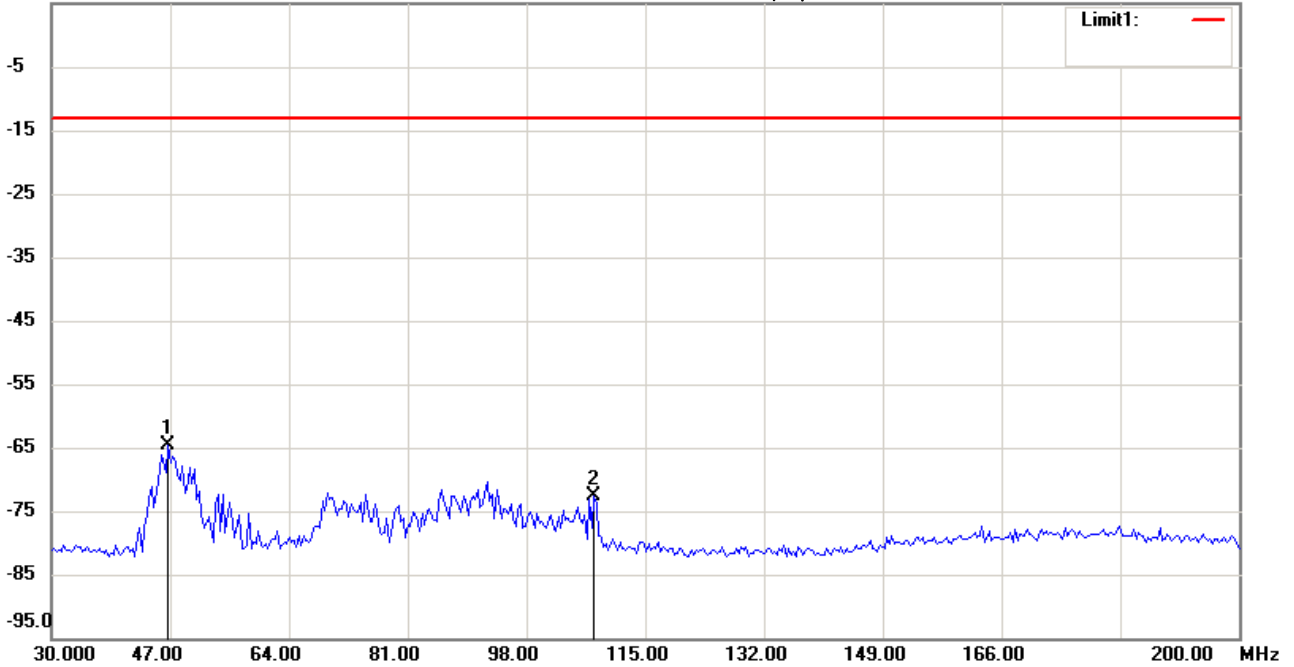

Site : Chamber

Condition : FCC 74.861 spurious emission

Polarization: *Vertical*

EUT : W6M21504-14935

Power : 2.4 Vd.c.

M/N:

Distance: 3m

Test Mode : 614.1MHz

Note :

Mk.	Frequency (MHz)	Reading (dBm)	Detector	Corr. factor (dB)	Result (dBm)	Limit (dBm)	Ant.Pos (cm)	Tab.Pos (deg.)	Margin (dB)	Comment
*	46.6934	-88.00	peak	23.43	-64.57	-13.00	150	93	-51.57	
	107.6754	-96.36	peak	23.69	-72.67	-13.00	150	171	-59.67	



Radiated Emission Measurement

Operator: Spencer

File :2

Data :#1

Date: 2015/4/15

Temperature:27.8 °C

0.0 dBm

Time: 下午 11:26:23

Humidity:63.4 %

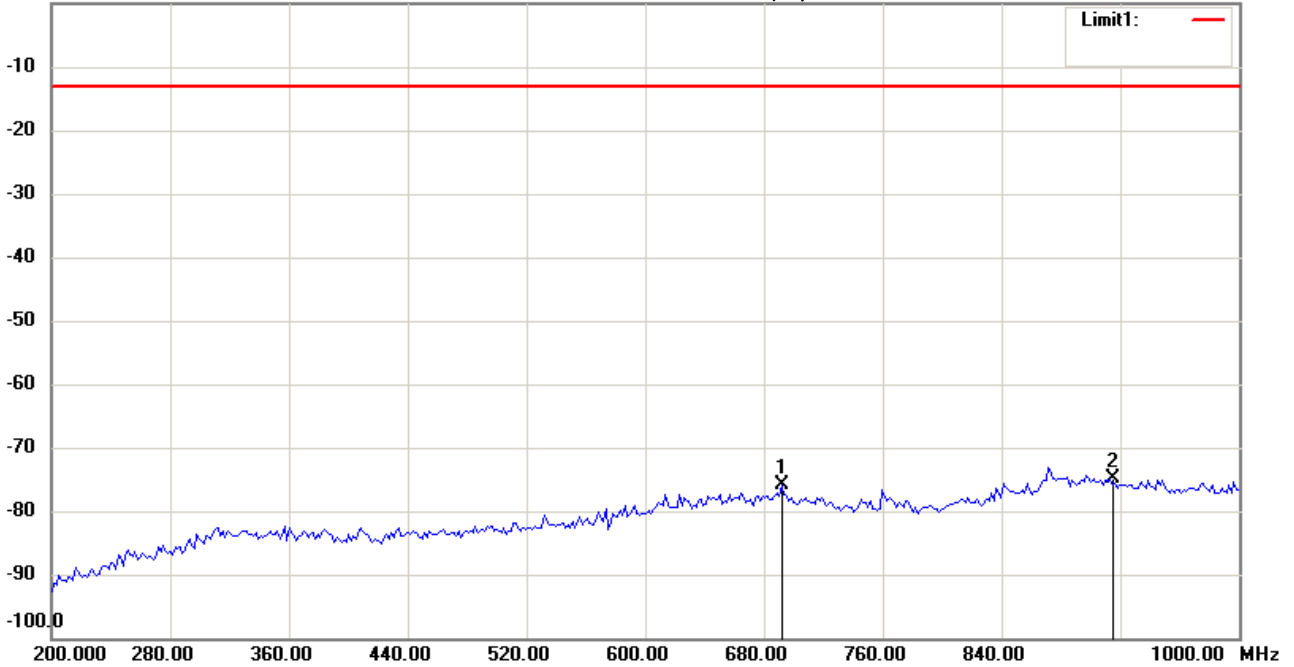

Site : Chamber

Condition : FCC 74.861 spurious emission

Polarization: *Horizontal*

EUT : W6M21504-14935

Power : 2.4 Vd.c.

M/N:

Distance: 3m

Test Mode : 614.1MHz

Note :

Mk.	Frequency (MHz)	Reading (dBm)	Detector	Corr. factor (dB)	Result (dBm)	Limit (dBm)	Ant.Pos (cm)	Tab.Pos (deg.)	Margin (dB)	Comment
	692.1844	-75.15	peak	-0.80	-75.95	-13.00	150	100	-62.95	
*	913.4270	-75.97	peak	1.06	-74.91	-13.00	150	320	-61.91	



Radiated Emission Measurement

Operator: Spencer

File :2

Data :#2

Date: 2015/4/15

Temperature:27.8 °C

0.0 dBm

Time: 下午 11:27:48

Humidity:63.4 %

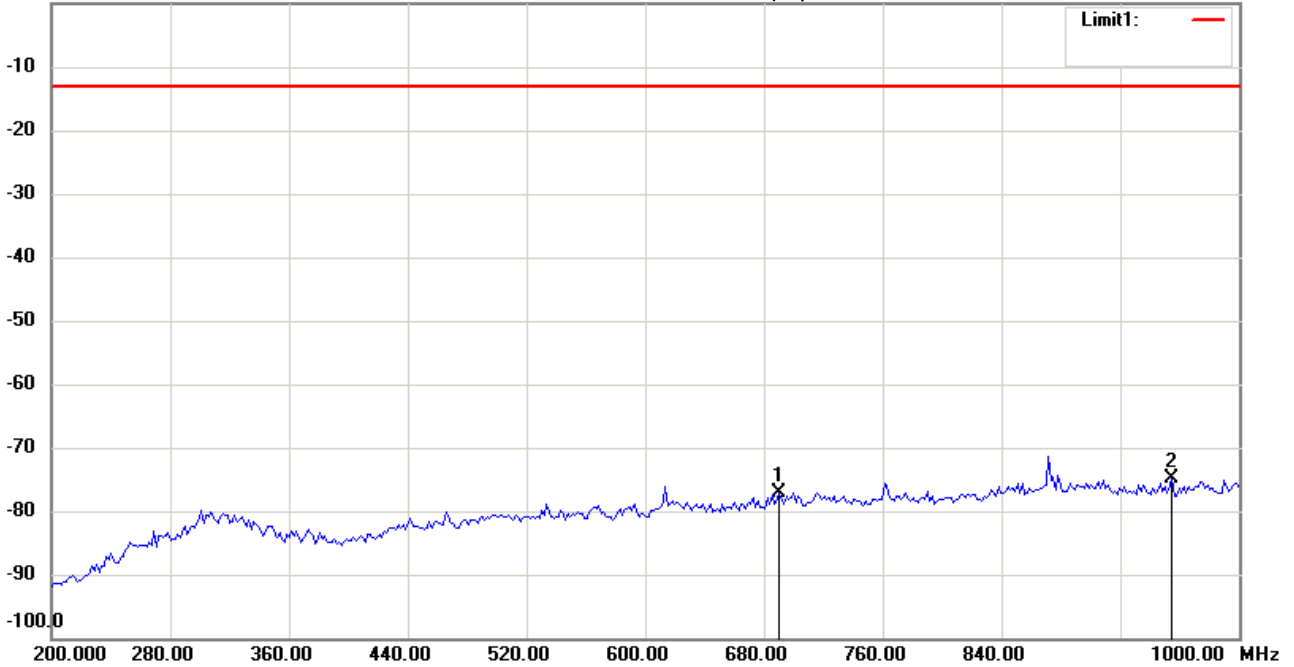

Site : Chamber

Condition : FCC 74.861 spurious emission

Polarization: *Vertical*

EUT : W6M21504-14935

Power : 2.4 Vd.c.

M/N:

Distance: 3m

Test Mode : 614.1MHz

Note :

Mk.	Frequency (MHz)	Reading (dBm)	Detector	Corr. factor (dB)	Result (dBm)	Limit (dBm)	Ant.Pos (cm)	Tab.Pos (deg.)	Margin (dB)	Comment
	690.5812	-75.62	peak	-1.43	-77.05	-13.00	150	305	-64.05	
*	955.1102	-74.49	peak	-0.33	-74.82	-13.00	150	85	-61.82	



Radiated Emission Measurement

Operator: Spencer

File :3

Data :#1

Date: 2015/4/16

Temperature:27.8 °C

0.0 dBm

Time: 上午 12:01:09

Humidity:63.4 %

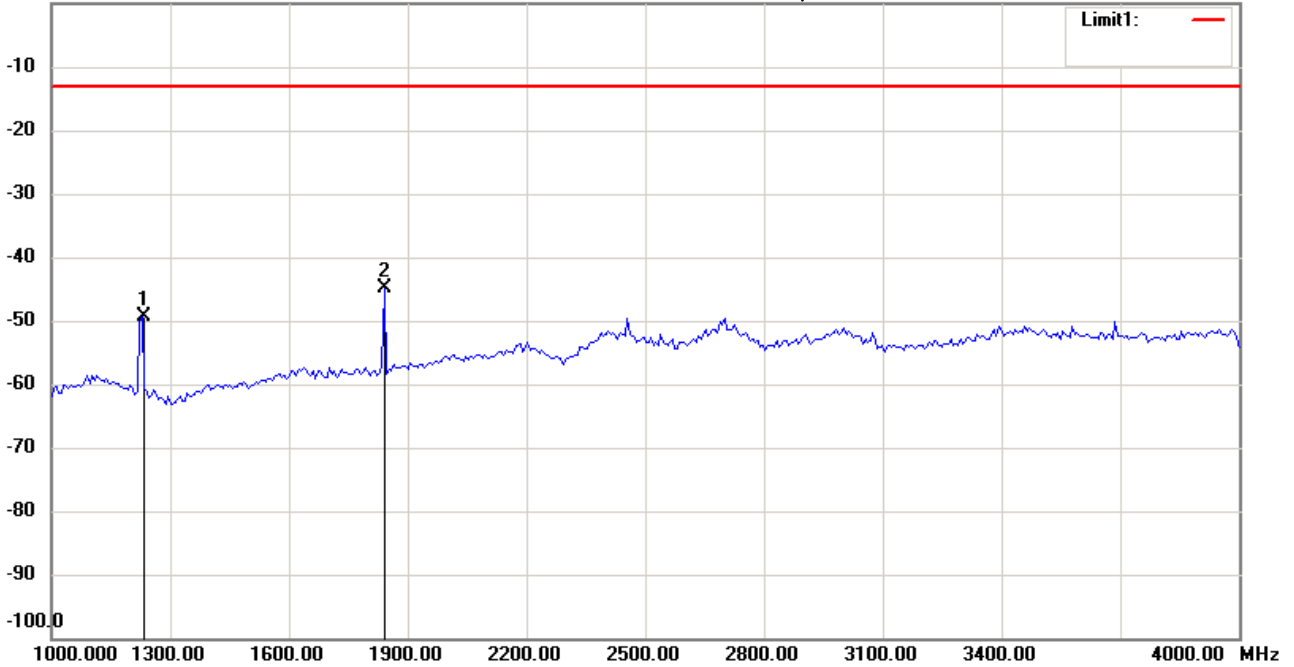

Site : Chamber

Condition : FCC 74.861 spurious emission

Polarization: *Horizontal*

EUT : W6M21504-14935

Power : 2.4 Vd.c.

M/N:

Distance: 3m

Test Mode : 614.1MHz

Note :

Mk.	Frequency (MHz)	Reading (dBm)	Detector	Corr. factor (dB)	Result (dBm)	Limit (dBm)	Ant.Pos (cm)	Tab.Pos (deg.)	Margin (dB)	Comment
	1228.457	-49.77	peak	0.30	-49.47	-13.00	150	120	-36.47	
*	1841.683	-48.14	peak	3.15	-44.99	-13.00	150	96	-31.99	



Radiated Emission Measurement

Operator: Spencer

File :3

Data :#3

Date: 2015/4/16

Temperature:27.8 °C

0.0 dBm

Time: 上午 12:07:06

Humidity:63.4 %

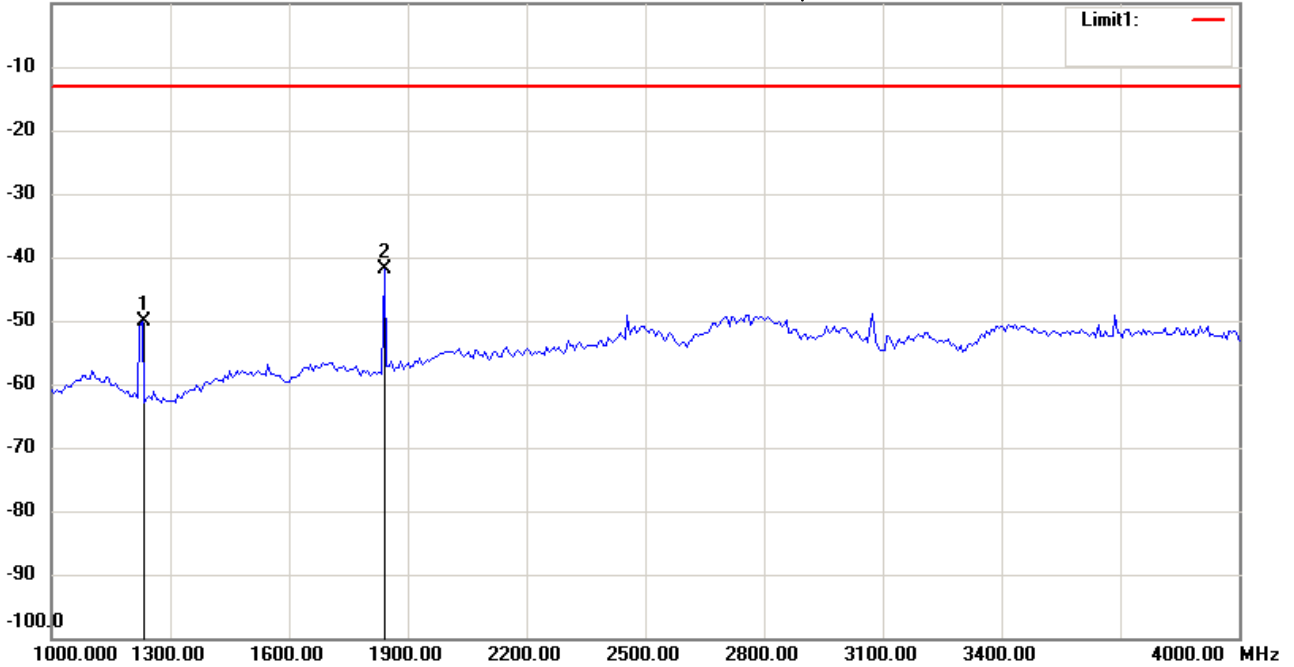

Site : Chamber

Condition : FCC 74.861 spurious emission

Polarization: *Vertical*

EUT : W6M21504-14935

Power : 2.4 Vd.c.

M/N:

Distance: 3m

Test Mode : 614.1MHz

Note :

Mk.	Frequency (MHz)	Reading (dBm)	Detector	Corr. factor (dB)	Result (dBm)	Limit (dBm)	Ant.Pos (cm)	Tab.Pos (deg.)	Margin (dB)	Comment
	1228.457	-49.68	peak	-0.38	-50.06	-13.00	150	106	-37.06	
*	1841.683	-44.98	peak	3.01	-41.97	-13.00	150	93	-28.97	



Radiated Emission Measurement

Operator: Spencer

File :3

Data :#2

Date: 2015/4/16

Temperature:27.8 °C

0.0 dBm

Time: 上午 12:05:09

Humidity:63.4 %

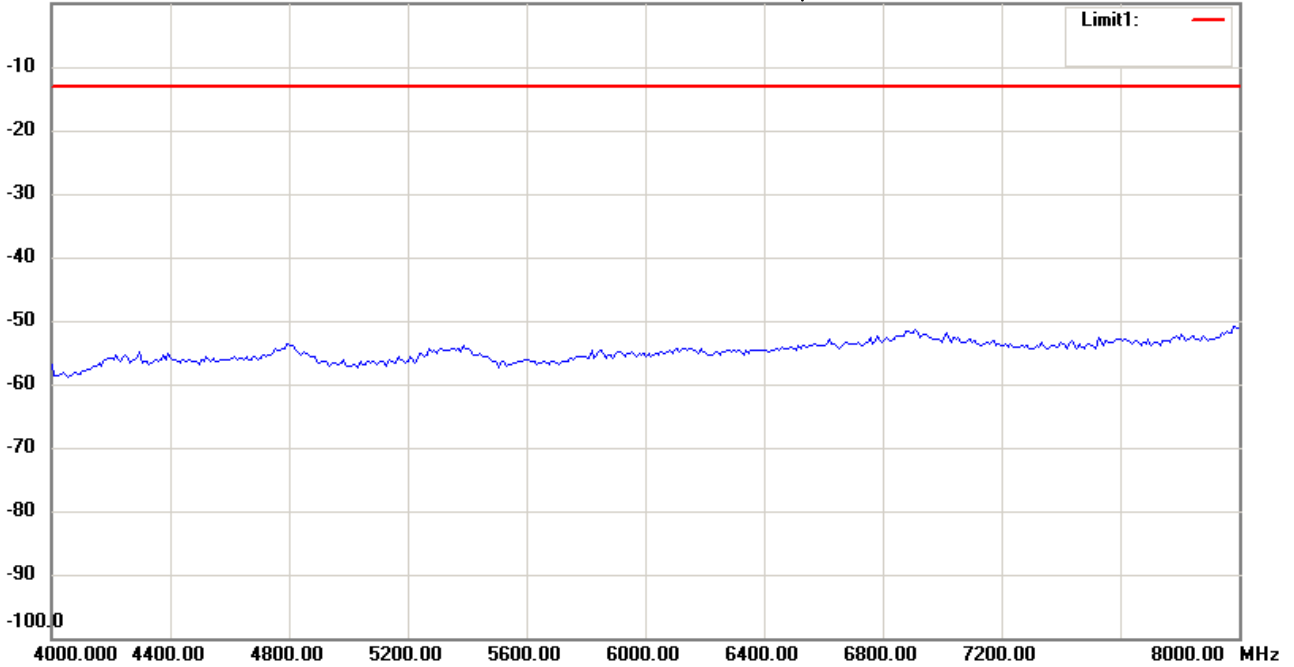

Site : Chamber

Condition : FCC 74.861 spurious emission

Polarization: *Horizontal*

EUT : W6M21504-14935

Power : 2.4 Vd.c.

M/N:

Distance: 3m

Test Mode : 614.1MHz

Note :

Mk.	Frequency (MHz)	Reading (dBm)	Detector	Corr. factor (dB)	Result (dBm)	Limit (dBm)	Ant.Pos (cm)	Tab.Pos (deg.)	Margin (dB)	Comment
-----	-----------------	---------------	----------	-------------------	--------------	-------------	--------------	----------------	-------------	---------



Radiated Emission Measurement

Operator: Spencer

File :3

Data :#4

Date: 2015/4/16

Temperature:27.8 °C

0.0 dBm

Time: 上午 12:08:03

Humidity:63.4 %

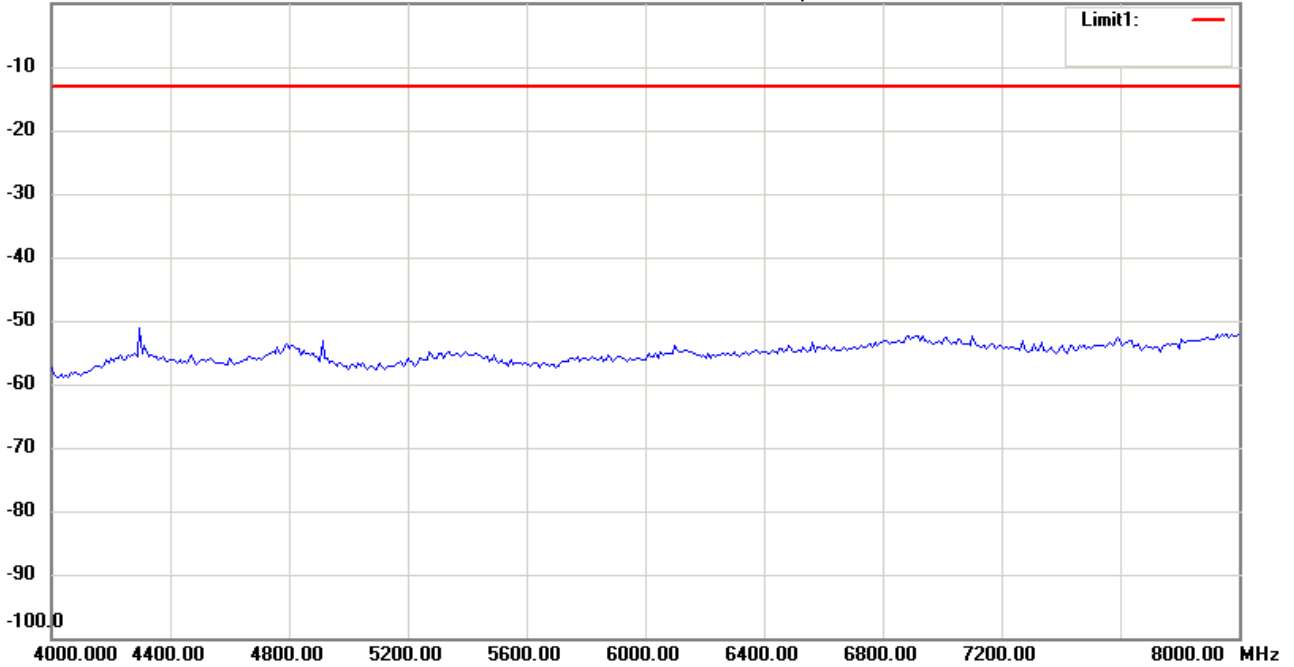

Site : Chamber

Condition : FCC 74.861 spurious emission

Polarization: *Vertical*

EUT : W6M21504-14935

Power : 2.4 Vd.c.

M/N:

Distance: 3m

Test Mode : 614.1MHz

Note :

Mk.	Frequency (MHz)	Reading (dBm)	Detector	Corr. factor (dB)	Result (dBm)	Limit (dBm)	Ant.Pos (cm)	Tab.Pos (deg.)	Margin (dB)	Comment
-----	-----------------	---------------	----------	-------------------	--------------	-------------	--------------	----------------	-------------	---------





Radiated Emission Measurement

Operator: Spencer

File :1

Data :#1

Date: 2015/4/15

Temperature:27.8 °C

5.0 dBm

Time: 下午 10:11:42

Humidity:63.4 %

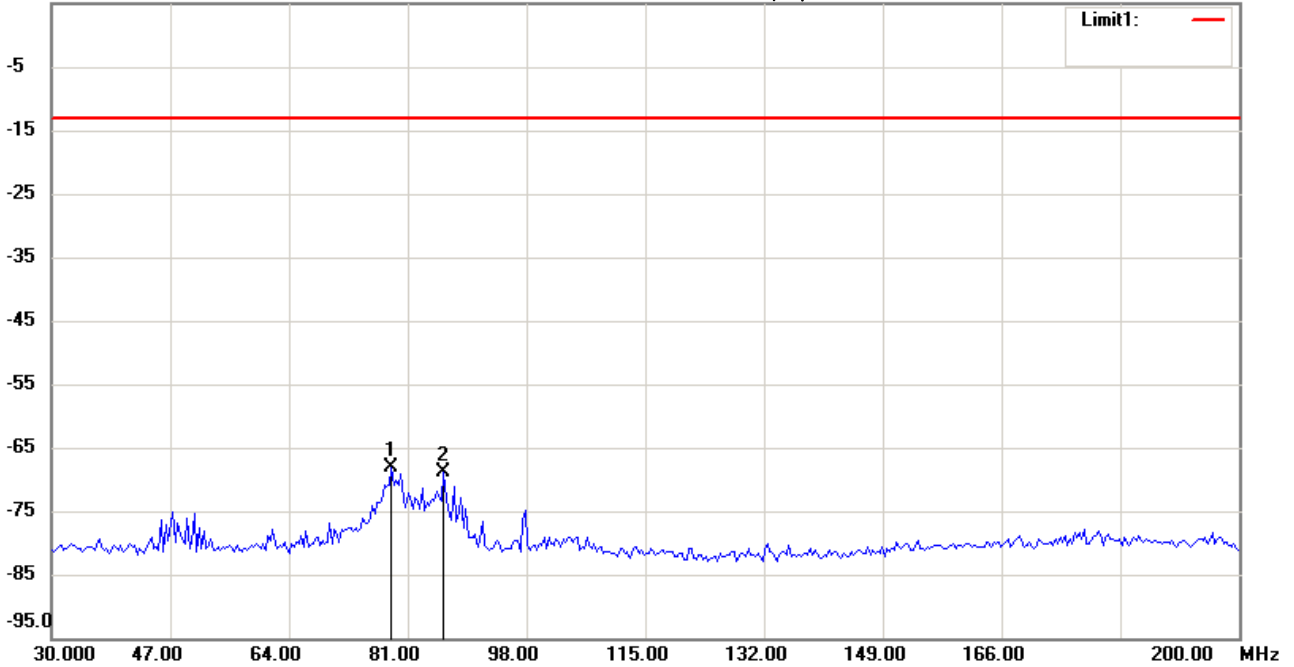

Site : Chamber

Condition : FCC 74.861 spurious emission

Polarization: *Horizontal*

EUT : W6M21504-14935

Power : 2.4 Vd.c.

M/N:

Distance: 3m

Test Mode : 655.95MHz

Note :

Mk.	Frequency (MHz)	Reading (dBm)	Detector	Corr. factor (dB)	Result (dBm)	Limit (dBm)	Ant.Pos (cm)	Tab.Pos (deg.)	Margin (dB)	Comment
*	78.7174	-92.01	peak	23.86	-68.15	-13.00	150	130	-55.15	
	86.2124	-92.56	peak	23.68	-68.88	-13.00	150	245	-55.88	



Radiated Emission Measurement

Operator: Spencer

File :1

Data :#2

Date: 2015/4/15

Temperature:27.8 °C

5.0 dBm

Time: 下午 10:14:02

Humidity:63.4 %

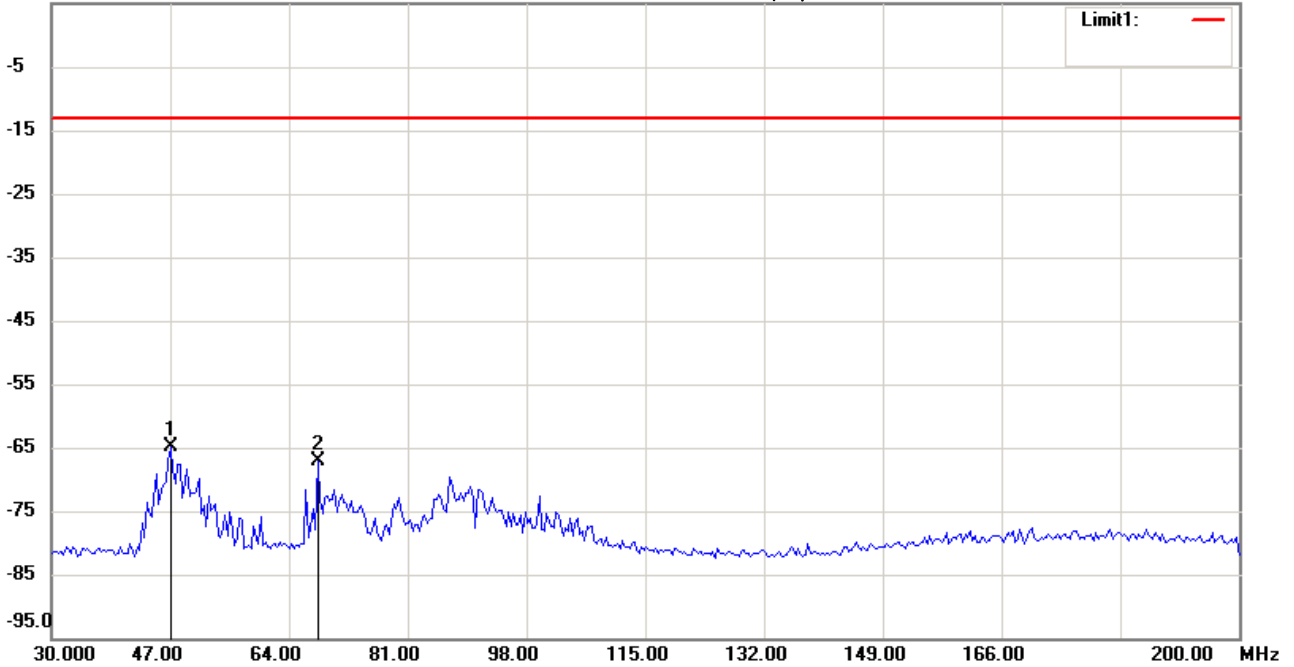

Site : Chamber

Condition : FCC 74.861 spurious emission

Polarization: *Vertical*

EUT : W6M21504-14935

Power : 2.4 Vd.c.

M/N:

Distance: 3m

Test Mode : 655.95MHz

Note :

Mk.	Frequency (MHz)	Reading (dBm)	Detector	Corr. factor (dB)	Result (dBm)	Limit (dBm)	Ant.Pos (cm)	Tab.Pos (deg.)	Margin (dB)	Comment
*	47.0341	-88.18	peak	23.43	-64.75	-13.00	150	127	-51.75	
	68.1563	-91.03	peak	23.99	-67.04	-13.00	150	290	-54.04	



Radiated Emission Measurement

Operator: Spencer

File :2

Data :#1

Date: 2015/4/15

Temperature:27.8 °C

0.0 dBm

Time: 下午 11:30:46

Humidity:63.4 %

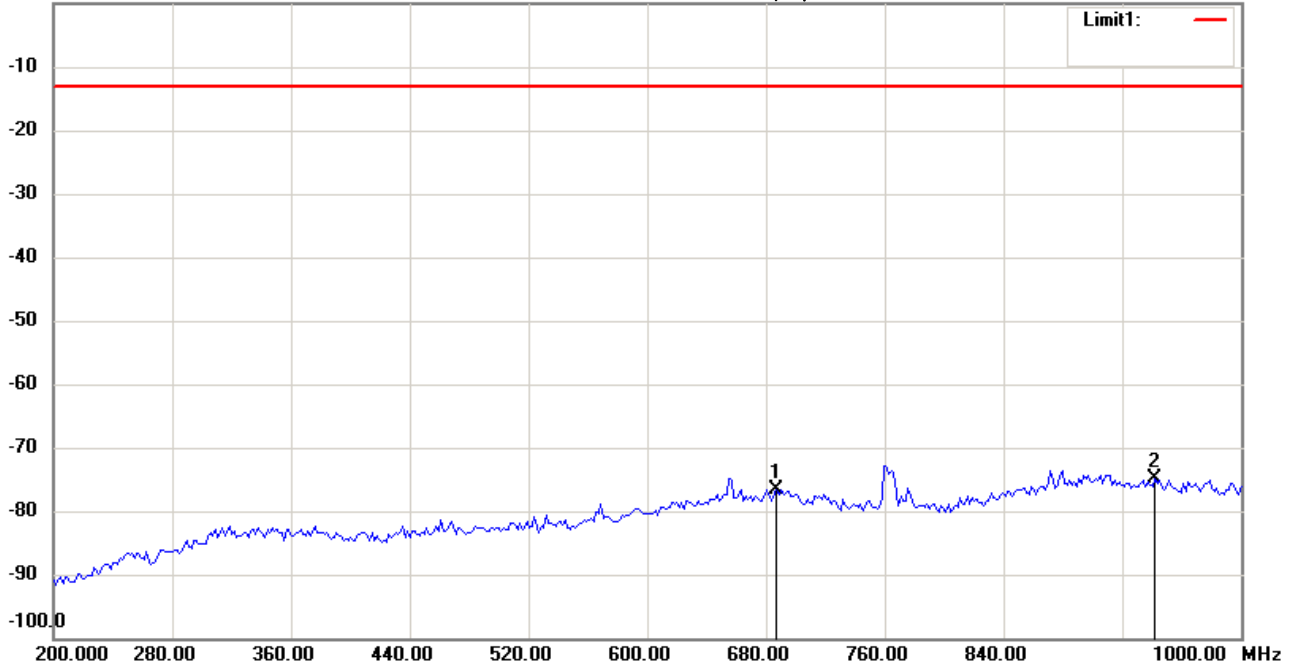

Site : Chamber

Condition : FCC 74.861 spurious emission

Polarization: *Horizontal*

EUT : W6M21504-14935

Power : 2.4 Vd.c.

M/N:

Distance: 3m

Test Mode : 655.95MHz

Note :

Mk.	Frequency (MHz)	Reading (dBm)	Detector	Corr. factor (dB)	Result (dBm)	Limit (dBm)	Ant.Pos (cm)	Tab.Pos (deg.)	Margin (dB)	Comment
	687.3747	-75.71	peak	-0.81	-76.52	-13.00	150	301	-63.52	
*	942.2846	-75.06	peak	0.21	-74.85	-13.00	150	58	-61.85	



Radiated Emission Measurement

Operator: Spencer

File :2

Data :#2

Date: 2015/4/15

Temperature:27.8 °C

0.0 dBm

Time: 下午 11:33:07

Humidity:63.4 %

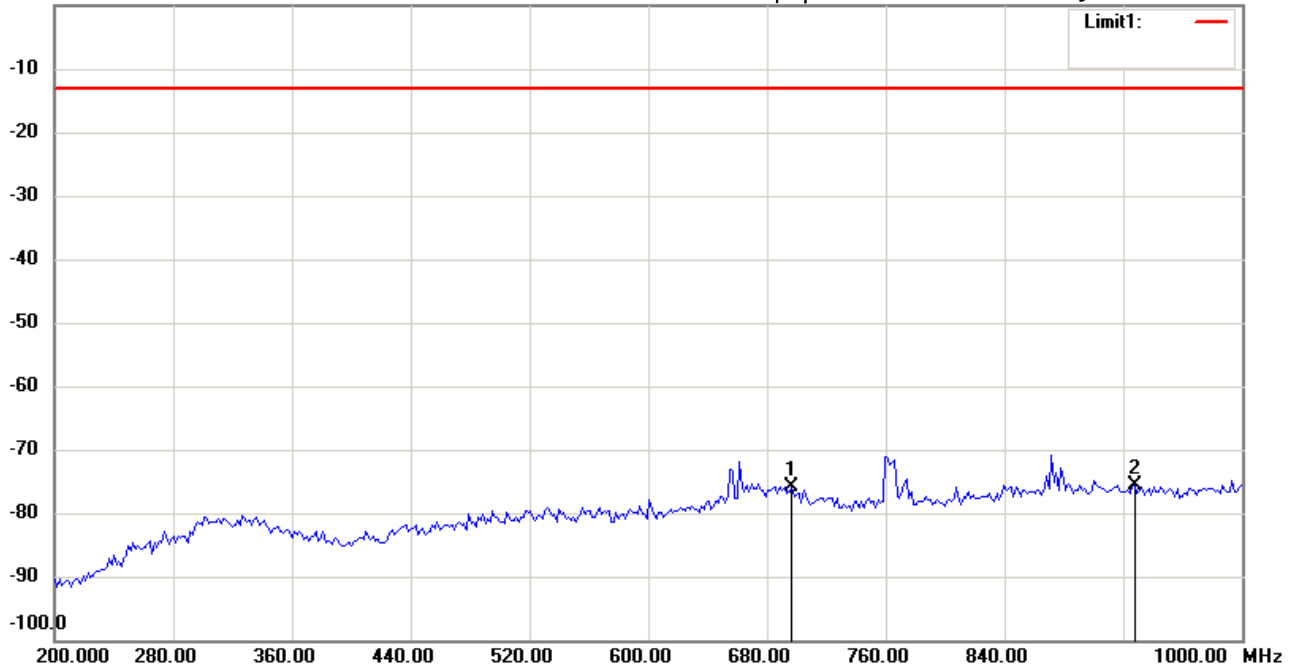

Site : Chamber

Condition : FCC 74.861 spurious emission

Polarization: *Vertical*

EUT : W6M21504-14935

Power : 2.4 Vd.c.

M/N:

Distance: 3m

Test Mode : 655.95MHz

Note :

Mk.	Frequency (MHz)	Reading (dBm)	Detector	Corr. factor (dB)	Result (dBm)	Limit (dBm)	Ant.Pos (cm)	Tab.Pos (deg.)	Margin (dB)	Comment
	696.9940	-74.54	peak	-1.26	-75.80	-13.00	150	200	-62.80	
*	927.8557	-75.46	peak	-0.04	-75.50	-13.00	150	133	-62.50	



Radiated Emission Measurement

Operator: Spencer

File :3

Data :#1

Date: 2015/4/15

Temperature:27.8 °C

0.0 dBm

Time: 下午 11:42:29

Humidity:63.4 %

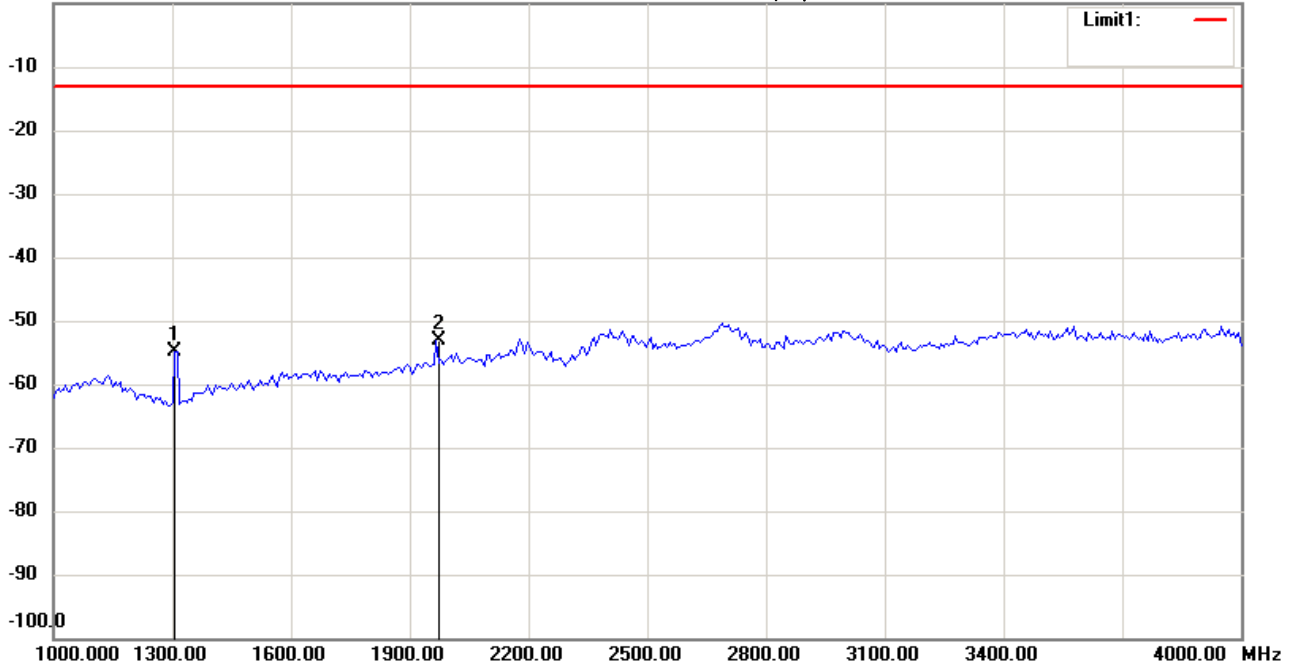

Site : Chamber

Condition : FCC 74.861 spurious emission

Polarization: *Horizontal*

EUT : W6M21504-14935

Power : 2.4 Vd.c.

M/N:

Distance: 3m

Test Mode : 655.95MHz

Note :

Mk.	Frequency (MHz)	Reading (dBm)	Detector	Corr. factor (dB)	Result (dBm)	Limit (dBm)	Ant.Pos (cm)	Tab.Pos (deg.)	Margin (dB)	Comment
	1306.613	-53.40	peak	-1.45	-54.85	-13.00	150	300	-41.85	
*	1967.936	-57.72	peak	4.70	-53.02	-13.00	150	147	-40.02	



Radiated Emission Measurement

Operator: Spencer

File :3

Data :#3

Date: 2015/4/15

Temperature:27.8 °C

0.0 dBm

Time: 下午 11:46:26

Humidity:63.4 %

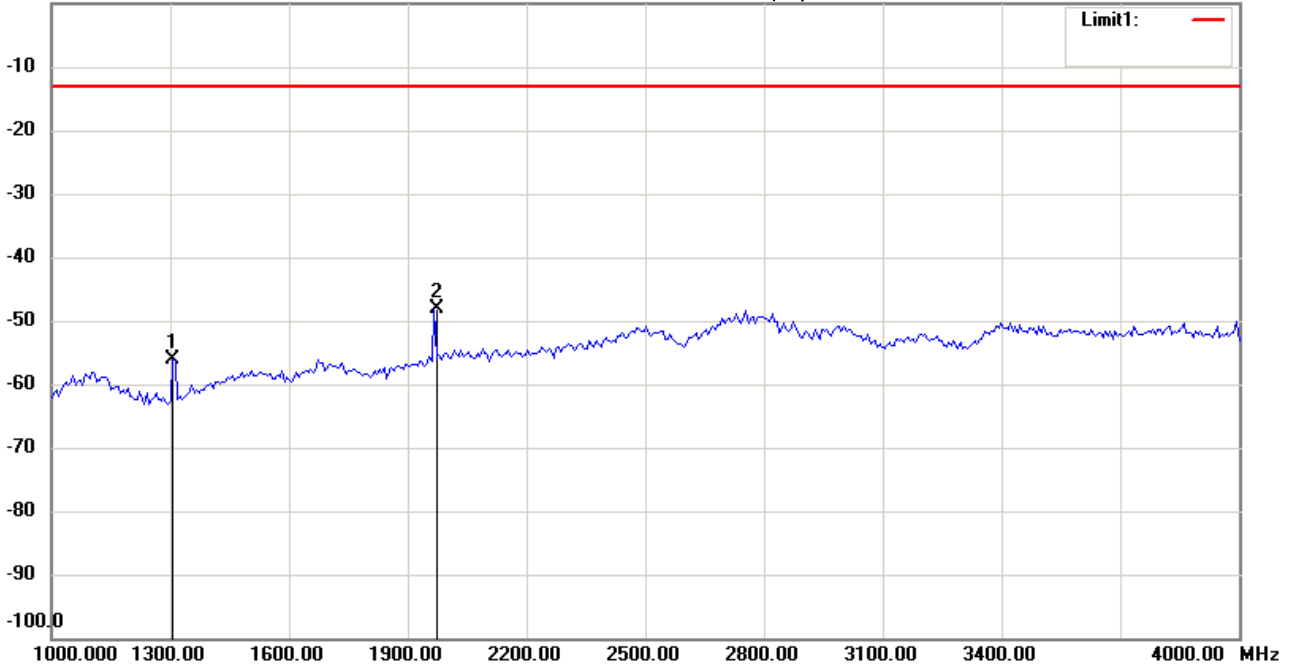

Site : Chamber

Condition : FCC 74.861 spurious emission

Polarization: *Vertical*

EUT : W6M21504-14935

Power : 2.4 Vd.c.

M/N:

Distance: 3m

Test Mode : 655.95MHz

Note :

Mk.	Frequency (MHz)	Reading (dBm)	Detector	Corr. factor (dB)	Result (dBm)	Limit (dBm)	Ant.Pos (cm)	Tab.Pos (deg.)	Margin (dB)	Comment
	1306.613	-55.03	peak	-1.02	-56.05	-13.00	150	205	-43.05	
*	1967.936	-53.57	peak	5.39	-48.18	-13.00	150	141	-35.18	



Radiated Emission Measurement

Operator: Spencer

File :3

Data :#2

Date: 2015/4/15

Temperature:27.8 °C

0.0 dBm

Time: 下午 11:44:29

Humidity:63.4 %

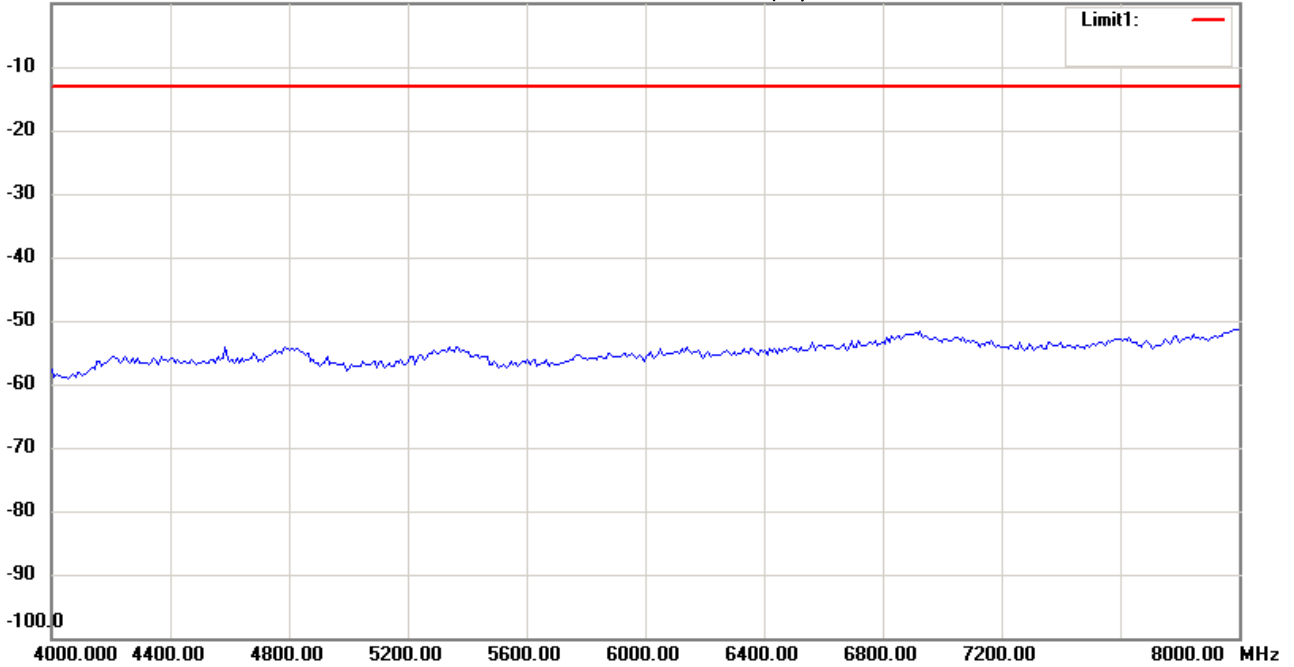

Site : Chamber

Condition : FCC 74.861 spurious emission

Polarization: *Horizontal*

EUT : W6M21504-14935

Power : 2.4 Vd.c.

M/N:

Distance: 3m

Test Mode : 655.95MHz

Note :

Mk.	Frequency (MHz)	Reading (dBm)	Detector	Corr. factor (dB)	Result (dBm)	Limit (dBm)	Ant.Pos (cm)	Tab.Pos (deg.)	Margin (dB)	Comment
-----	-----------------	---------------	----------	-------------------	--------------	-------------	--------------	----------------	-------------	---------



Radiated Emission Measurement

Operator: Spencer

File :3

Data :#4

Date: 2015/4/15

Temperature:27.8 °C

0.0 dBm

Time: 下午 11:48:40

Humidity:63.4 %

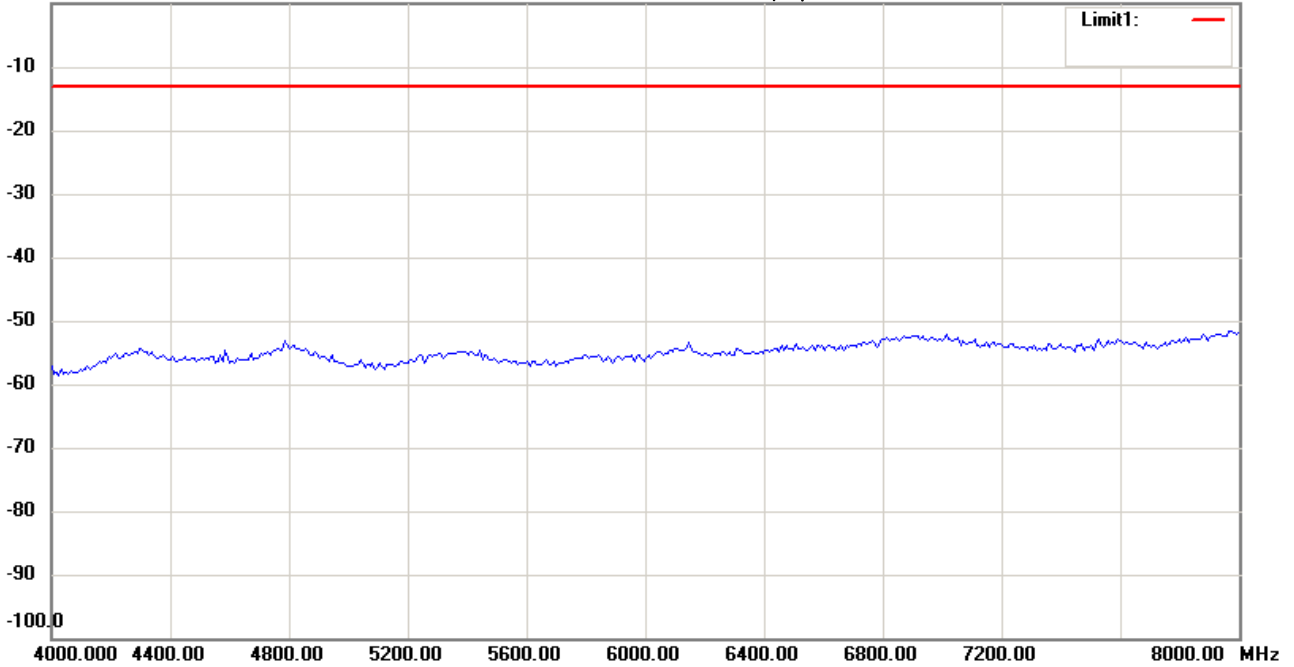

Site : Chamber

Condition : FCC 74.861 spurious emission

Polarization: *Vertical*

EUT : W6M21504-14935

Power : 2.4 Vd.c.

M/N:

Distance: 3m

Test Mode : 655.95MHz

Note :

Mk.	Frequency (MHz)	Reading (dBm)	Detector	Corr. factor (dB)	Result (dBm)	Limit (dBm)	Ant.Pos (cm)	Tab.Pos (deg.)	Margin (dB)	Comment
-----	-----------------	---------------	----------	-------------------	--------------	-------------	--------------	----------------	-------------	---------





Radiated Emission Measurement

Operator: Spencer

File :1

Data :#1

Date: 2015/4/15

Temperature:27.8 °C

5.0 dBm

Time: 下午 10:17:14

Humidity:63.4 %

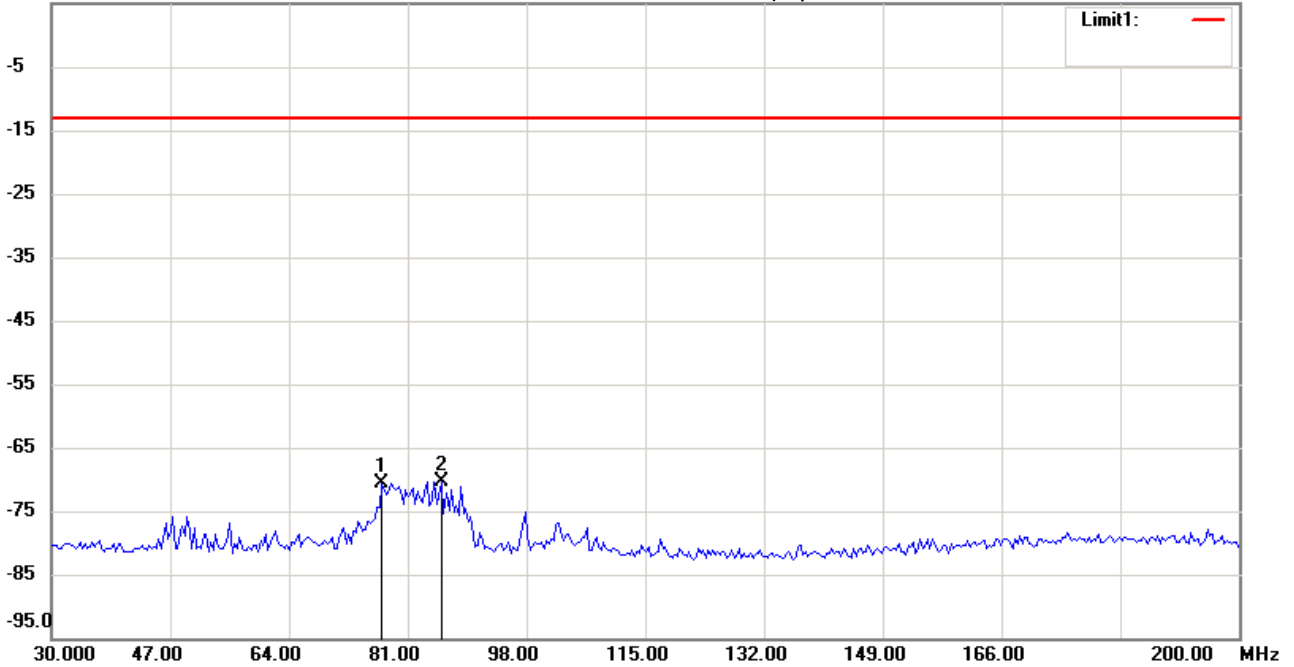

Site : Chamber

Condition : FCC 74.861 spurious emission

Polarization: *Horizontal*

EUT : W6M21504-14935

Power : 2.4 Vd.c.

M/N:

Distance: 3m

Test Mode : 697.8MHz

Note :

Mk.	Frequency (MHz)	Reading (dBm)	Detector	Corr. factor (dB)	Result (dBm)	Limit (dBm)	Ant.Pos (cm)	Tab.Pos (deg.)	Margin (dB)	Comment
	77.3547	-94.59	peak	23.88	-70.71	-13.00	150	125	-57.71	
*	85.8717	-94.06	peak	23.69	-70.37	-13.00	150	333	-57.37	



Radiated Emission Measurement

Operator: Spencer

File :1

Data :#2

Date: 2015/4/15

Temperature:27.8 °C

5.0 dBm

Time: 下午 10:20:11

Humidity:63.4 %

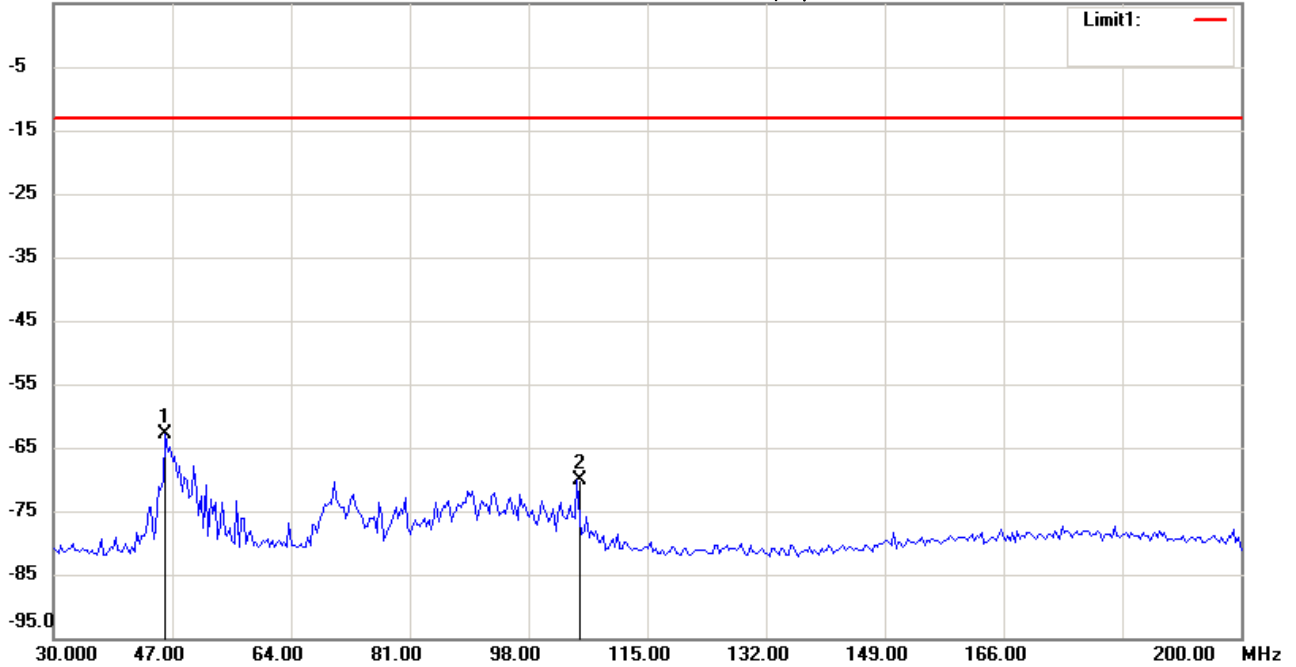

Site : Chamber

Condition : FCC 74.861 spurious emission

Polarization: *Vertical*

EUT : W6M21504-14935

Power : 2.4 Vd.c.

M/N:

Distance: 3m

Test Mode : 697.8MHz

Note :

Mk.	Frequency (MHz)	Reading (dBm)	Detector	Corr. factor (dB)	Result (dBm)	Limit (dBm)	Ant.Pos (cm)	Tab.Pos (deg.)	Margin (dB)	Comment
*	46.0120	-86.37	peak	23.42	-62.95	-13.00	150	134	-49.95	
	104.9500	-94.05	peak	23.90	-70.15	-13.00	150	287	-57.15	



Radiated Emission Measurement

Operator: Spencer

File :2

Data :#1

Date: 2015/4/15

Temperature:27.8 °C

0.0 dBm

Time: 下午 10:29:44

Humidity:63.4 %

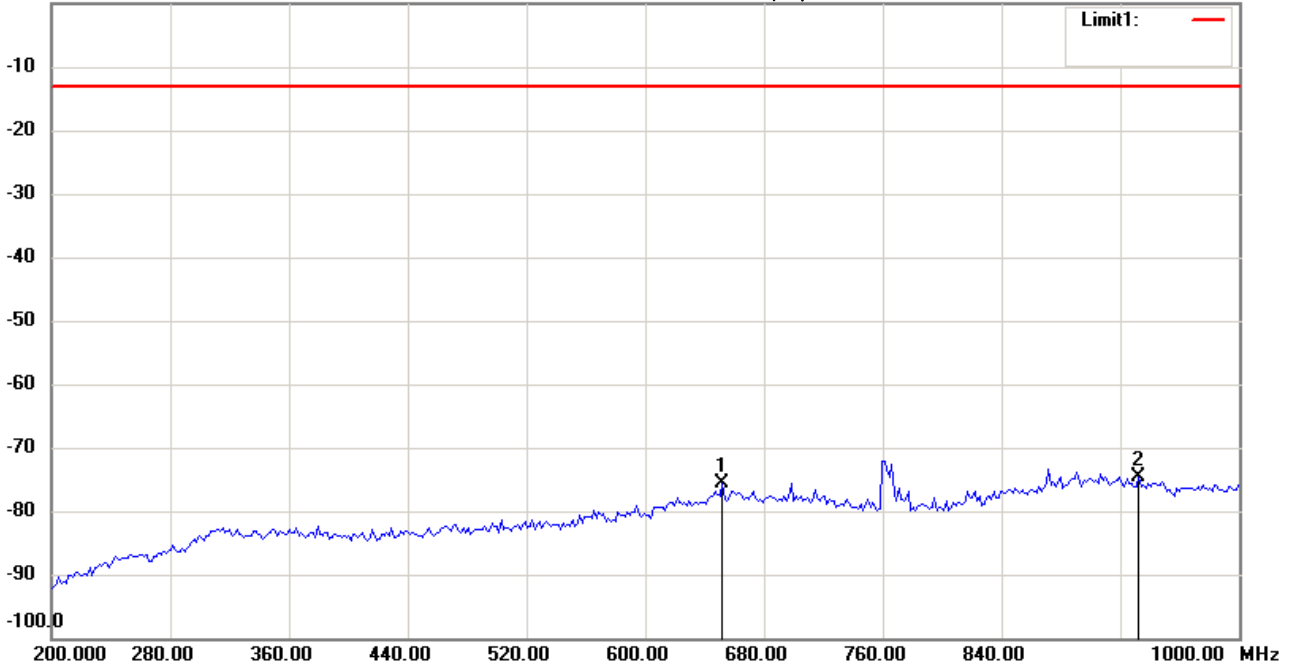

Site : Chamber

Condition : FCC 74.861 spurious emission

Polarization: *Horizontal*

EUT : W6M21504-14935

Power : 2.4 Vd.c.

M/N:

Distance: 3m

Test Mode : 697.8MHz

Note :

Mk.	Frequency (MHz)	Reading (dBm)	Detector	Corr. factor (dB)	Result (dBm)	Limit (dBm)	Ant.Pos (cm)	Tab.Pos (deg.)	Margin (dB)	Comment
	652.1042	-74.73	peak	-0.88	-75.61	-13.00	150	173	-62.61	
*	932.6653	-75.20	peak	0.49	-74.71	-13.00	150	247	-61.71	



Radiated Emission Measurement

Operator: Spencer

File :2

Data :#2

Date: 2015/4/15

Temperature:27.8 °C

0.0 dBm

Time: 下午 10:33:33

Humidity:63.4 %

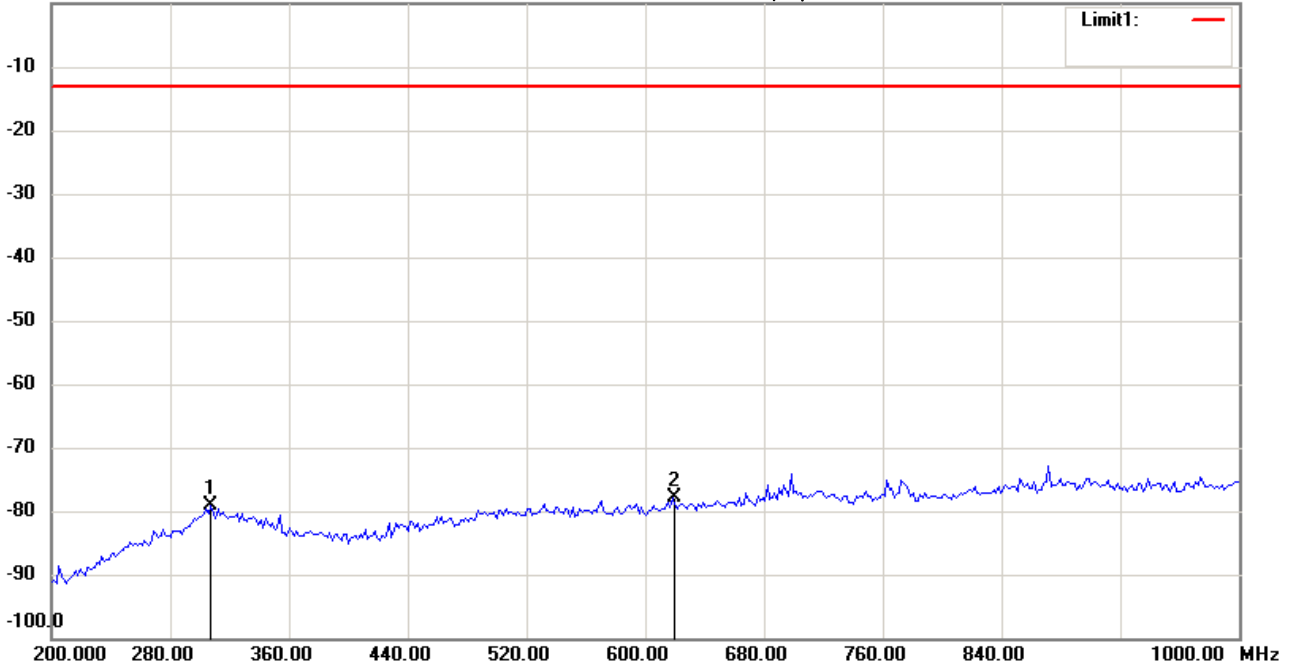

Site : Chamber

Condition : FCC 74.861 spurious emission

Polarization: *Vertical*

EUT : W6M21504-14935

Power : 2.4 Vd.c.

M/N:

Distance: 3m

Test Mode : 697.8MHz

Note :

Mk.	Frequency (MHz)	Reading (dBm)	Detector	Corr. factor (dB)	Result (dBm)	Limit (dBm)	Ant.Pos (cm)	Tab.Pos (deg.)	Margin (dB)	Comment
	307.4148	-73.47	peak	-5.75	-79.22	-13.00	150	176	-66.22	
*	618.4370	-74.60	peak	-3.19	-77.79	-13.00	150	134	-64.79	



Radiated Emission Measurement

Operator: Spencer

File :3

Data :#1

Date: 2015/4/15

Temperature:27.8 °C

0.0 dBm

Time: 下午 11:51:12

Humidity:63.4 %

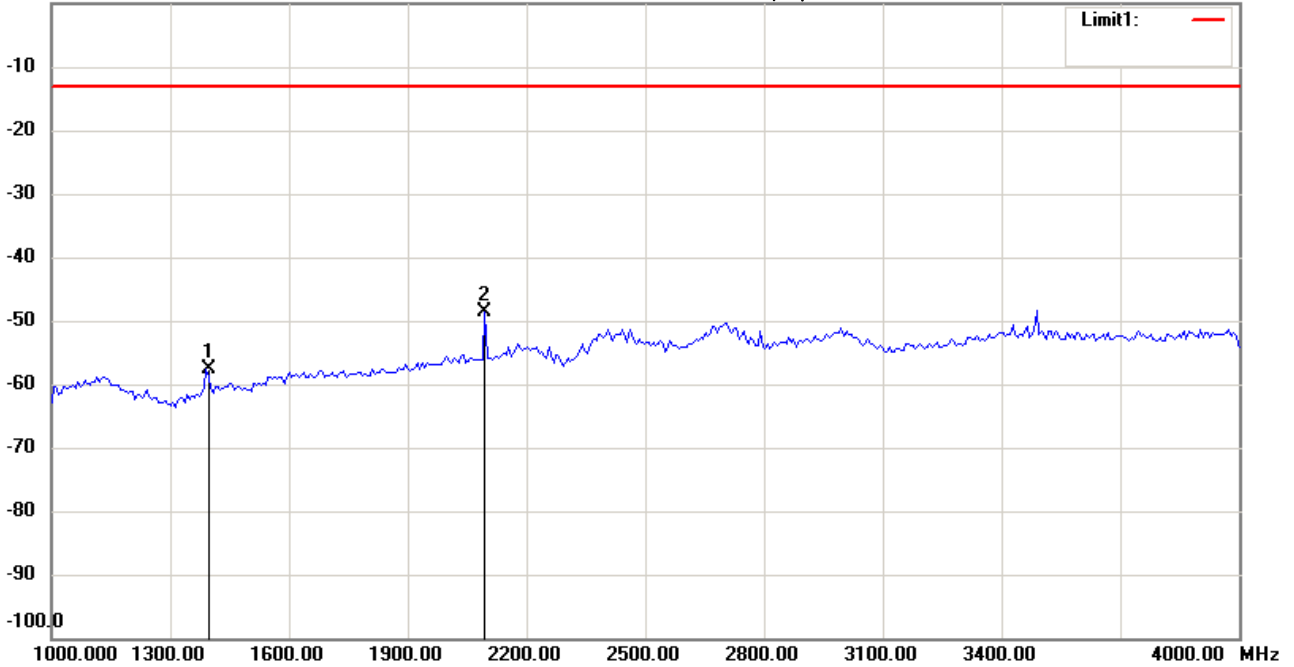

Site : Chamber

Condition : FCC 74.861 spurious emission

Polarization: *Horizontal*

EUT : W6M21504-14935

Power : 2.4 Vd.c.

M/N:

Distance: 3m

Test Mode : 697.8MHz

Note :

Mk.	Frequency (MHz)	Reading (dBm)	Detector	Corr. factor (dB)	Result (dBm)	Limit (dBm)	Ant.Pos (cm)	Tab.Pos (deg.)	Margin (dB)	Comment
	1390.782	-58.31	peak	0.61	-57.70	-13.00	150	206	-44.70	
*	2094.188	-53.93	peak	5.23	-48.70	-13.00	150	33	-35.70	



Radiated Emission Measurement

Operator: Spencer

File :3

Data :#3

Date: 2015/4/15

Temperature:27.8 °C

0.0 dBm

Time: 下午 11:56:00

Humidity:63.4 %

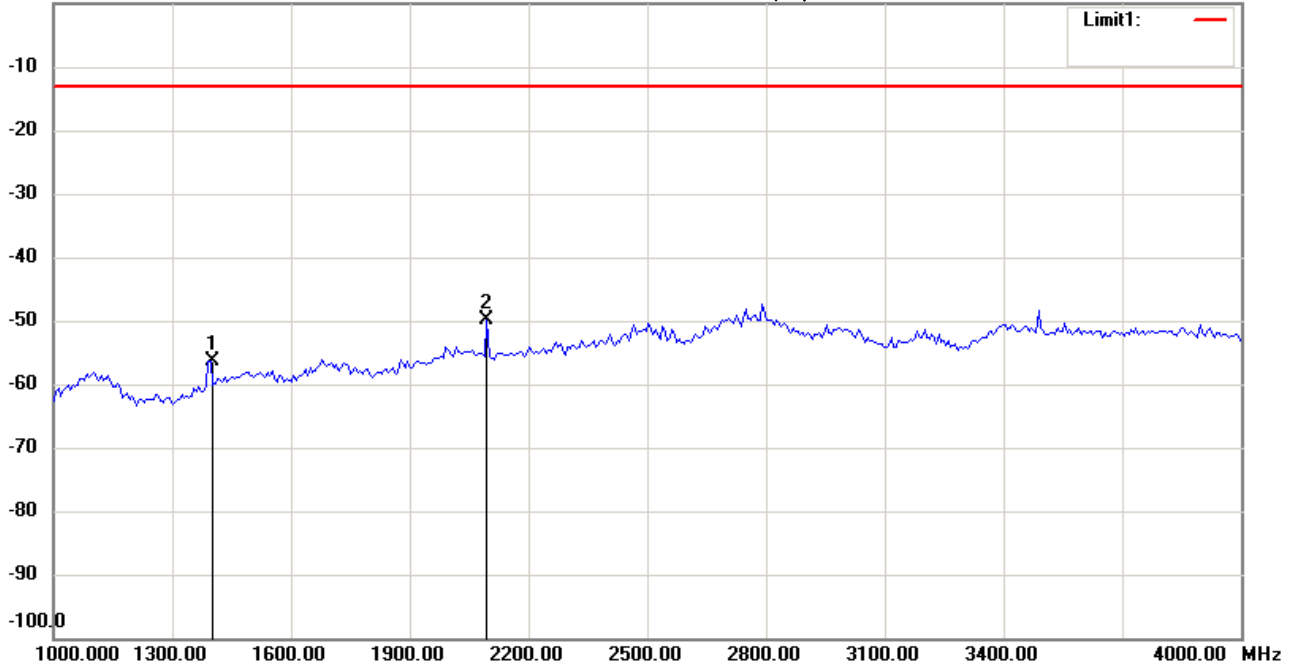

Site : Chamber

Condition : FCC 74.861 spurious emission

Polarization: *Vertical*

EUT : W6M21504-14935

Power : 2.4 Vd.c.

M/N:

Distance: 3m

Test Mode : 697.8MHz

Note :

Mk.	Frequency (MHz)	Reading (dBm)	Detector	Corr. factor (dB)	Result (dBm)	Limit (dBm)	Ant.Pos (cm)	Tab.Pos (deg.)	Margin (dB)	Comment
	1396.794	-57.71	peak	1.39	-56.32	-13.00	150	102	-43.32	
*	2094.188	-55.64	peak	5.79	-49.85	-13.00	150	55	-36.85	



Radiated Emission Measurement

Operator: Spencer

File :3

Data :#2

Date: 2015/4/15

Temperature:27.8 °C

0.0 dBm

Time: 下午 11:53:59

Humidity:63.4 %

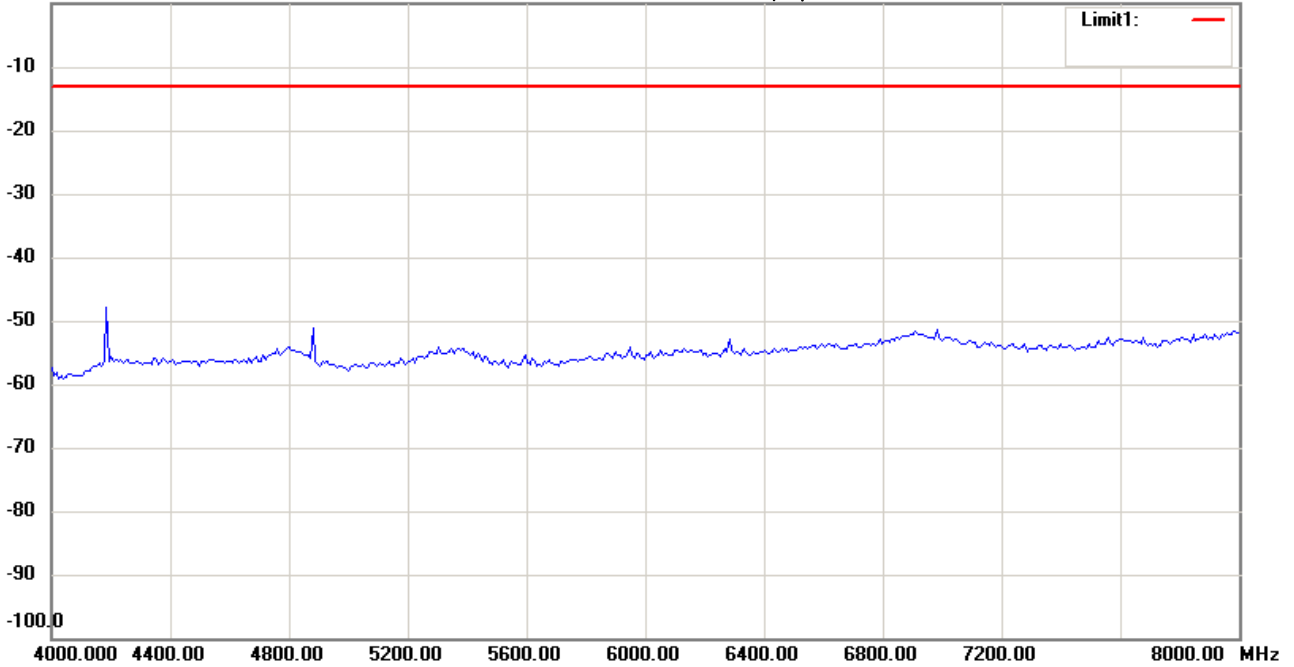

Site : Chamber

Condition : FCC 74.861 spurious emission

Polarization: *Horizontal*

EUT : W6M21504-14935

Power : 2.4 Vd.c.

M/N:

Distance: 3m

Test Mode : 697.8MHz

Note :

Mk.	Frequency (MHz)	Reading (dBm)	Detector	Corr. factor (dB)	Result (dBm)	Limit (dBm)	Ant.Pos (cm)	Tab.Pos (deg.)	Margin (dB)	Comment
-----	-----------------	---------------	----------	-------------------	--------------	-------------	--------------	----------------	-------------	---------



Radiated Emission Measurement

Operator: Spencer

File :3

Data :#4

Date: 2015/4/15

Temperature:27.8 °C

0.0 dBm

Time: 下午 11:57:04

Humidity:63.4 %

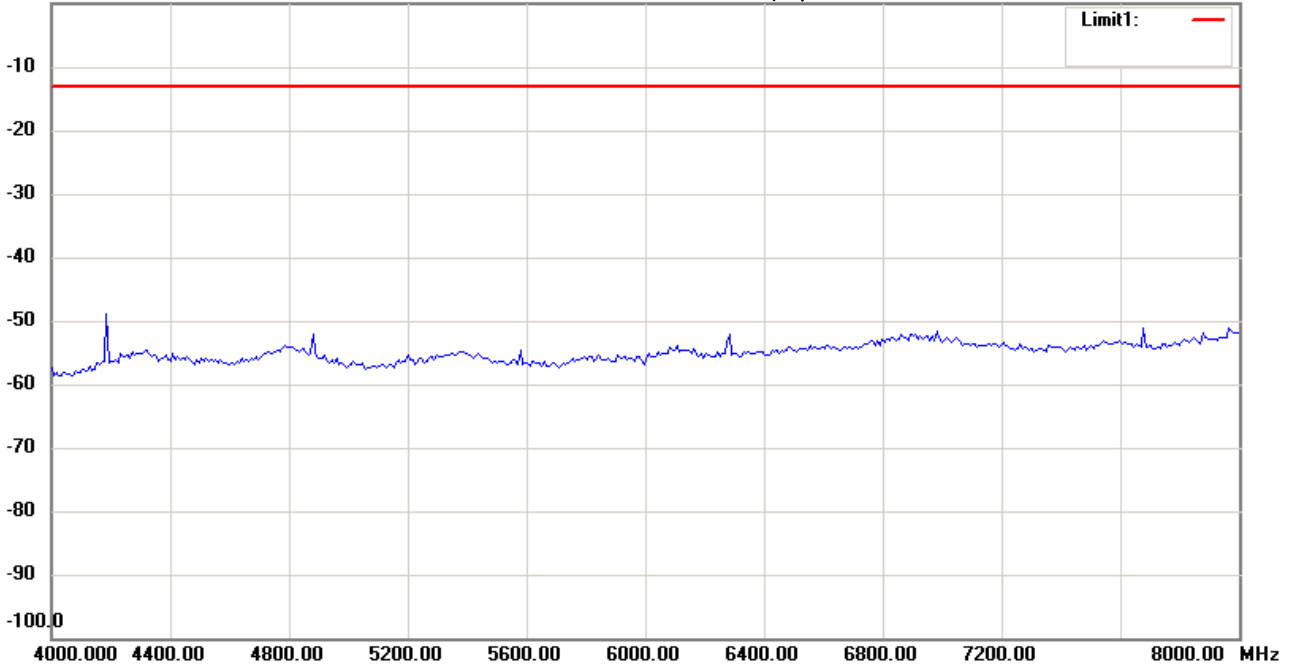

Site : Chamber

Condition : FCC 74.861 spurious emission

Polarization: *Vertical*

EUT : W6M21504-14935

Power : 2.4 Vd.c.

M/N:

Distance: 3m

Test Mode : 697.8MHz

Note :

Mk.	Frequency (MHz)	Reading (dBm)	Detector	Corr. factor (dB)	Result (dBm)	Limit (dBm)	Ant.Pos (cm)	Tab.Pos (deg.)	Margin (dB)	Comment
-----	-----------------	---------------	----------	-------------------	--------------	-------------	--------------	----------------	-------------	---------