

APPLICANT: CHIAYO ELECTRONICS CO., LTD.
FCC ID: CINSM-916

TABLE OF CONTENTS LIST

TEST REPORT CONTAINING:

PAGE	1.....	GENERAL INFORMATION & TECHNICAL DESCRIPTIONS
PAGE	2.....	TECHNICAL DESC. CONT. & RF POWER TEST PROCEDURE
PAGE	3.....	AUDIO FREQUENCY RESPONSE PLOT & MODULATION LIMITING PLOT - 300 Hz
PAGE	4.....	MODULATION LIMITING PLOT - 1000 Hz & 5000 Hz
PAGE	5.....	OCCUPIED BANDWIDTH PLOT
PAGE	6.....	OCCUPIED BANDWIDTH MEASUREMENT & RADIATED EMISSIONS TEST DATA
PAGE	7.....	METHOD OF MEASURING RADIATED SPURIOUS EMISSIONS
PAGE	8.....	FREQUENCY STABILITY TEST DATA
PAGE	9-11.....	EQUIPMENT LIST

EXHIBITS CONTAINING:

EXHIBIT	1.....	FCC ID LABEL SAMPLE & ID LABEL LOCATION
EXHIBIT	2.....	BLOCK DIAGRAM
EXHIBIT	3.....	SCHEMATICS
EXHIBIT	4.....	TUNING PROCEDURE
EXHIBIT	5.....	CIRCUIT DESCRIPTION
EXHIBIT	6.....	USER'S MANUAL
EXHIBIT	7.....	TEST SET UP PHOTOGRAPH
EXHIBIT	8.....	EXTERNAL FRONT PHOTOGRAPHS
EXHIBIT	9.....	INTERNAL PHOTOGRAPHS
EXHIBIT	10.....	PARTS LIST

GENERAL INFORMATION REQUIRED
FOR TYPE ACCEPTANCE

2.1033(c)(1)(2) CHIAYO ELECTRONICS CO., LTD. will manufacture the CINSM-916 in quantity, for use under FCC RULES PART 74.801, LOW POWER AUXILIARY STATIONS.

CHIAYO ELECTRONICS CO., LTD.
30, LANE 27, SEC. 4, JEN AI ROAD
TAIPEI, TAIWAN R.O.C.,

2.1033 TECHNICAL DESCRIPTION

(c)(3) Instruction book. The instruction manual is included as Exhibit 6.

(c)(4) Type of Emission 106K0F3E

Bn = 2M + 2DK
M = 3000
D = 50 kHz(Peak Deviation)
K = 1
Bn = 2(3k) + 2(50k)(1) = 106k

ALLOWED AUTHORIZED BANDWIDTH = 200kHz.
74.861(e)(5)

(c)(5) Frequency Range: Part 74: 614-806 MHz

(c)(6) Power Range and Controls: UNIT has no controls.

(c)(7) Maximum Output Power Rating: .028 Watts

(c)(8) DC Voltages and Current into Final Amplifier:

FINAL AMPLIFIER ONLY
9.0V @ 0.040A

(c)(9) Tune-up procedure. The tune-up procedure is given in Exhibit #4.

(c)(10) Complete Circuit Diagrams: The circuit diagram is included as EXHIBIT # 3. The block diagram is included as EXHIBIT #2.

- 2.1033(c)11) Photo or Drawing of Label and sketch of location:
See EXHIBIT # 1.
- 2.1033(c)12) Photos of Equipment:
See EXHIBIT #'S 8-9.
- (c)(13) Description of all circuitry and devices provided for determining and stabilizing frequency.
- Description of any circuits or devices employed for suppression of spurious radiation, for limiting modulation, and for limiting power.
- This circuitry is described in Exhibit #5.
- Limiting Modulation:
The transmitter audio circuitry is contained in IC101, IC102 and IC103.
- Limiting Power:
There is no provision for limiting power.
- (13) Digital modulation. This unit does not use digital modulation.
- 2.1033(c)(14) The data required by 2.1046 through 2.1057 is submitted below.
- 2.1046 RF power output.

R.F. POWER OUTPUT TEST PROCEDURE

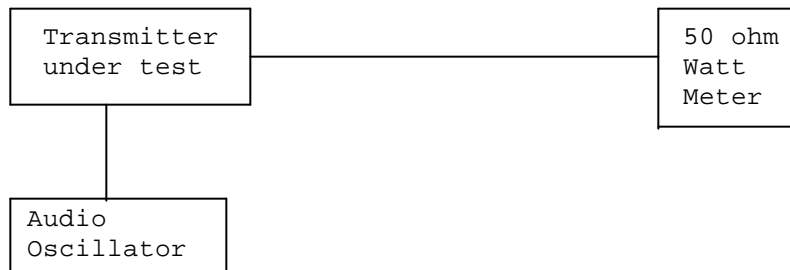

2.1047(a)(b) Modulation characteristics:

AUDIO FREQUENCY RESPONSE

The audio frequency response was measured in accordance with TIA/EIA Specification 603. The audio frequency response curve is shown on the next page.

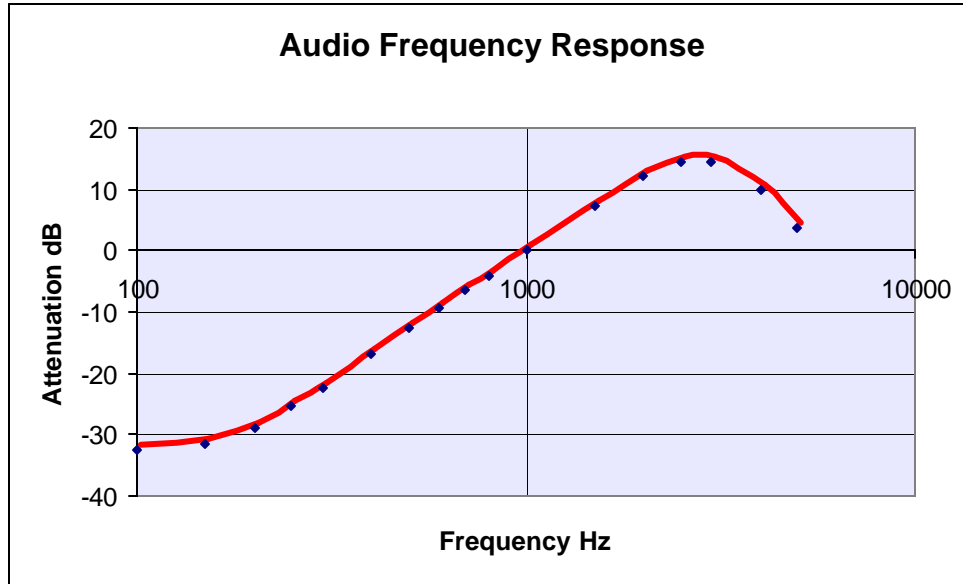

MODULATION LIMITING PLOT - 300 Hz

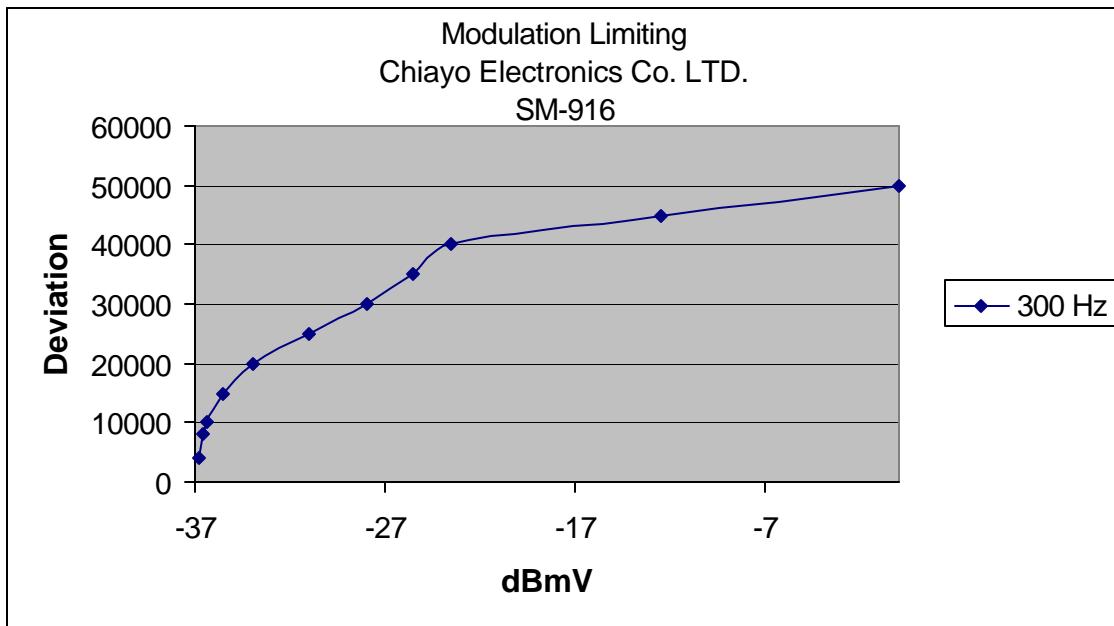

MODULATION LIMITING PLOT - 1000 Hz

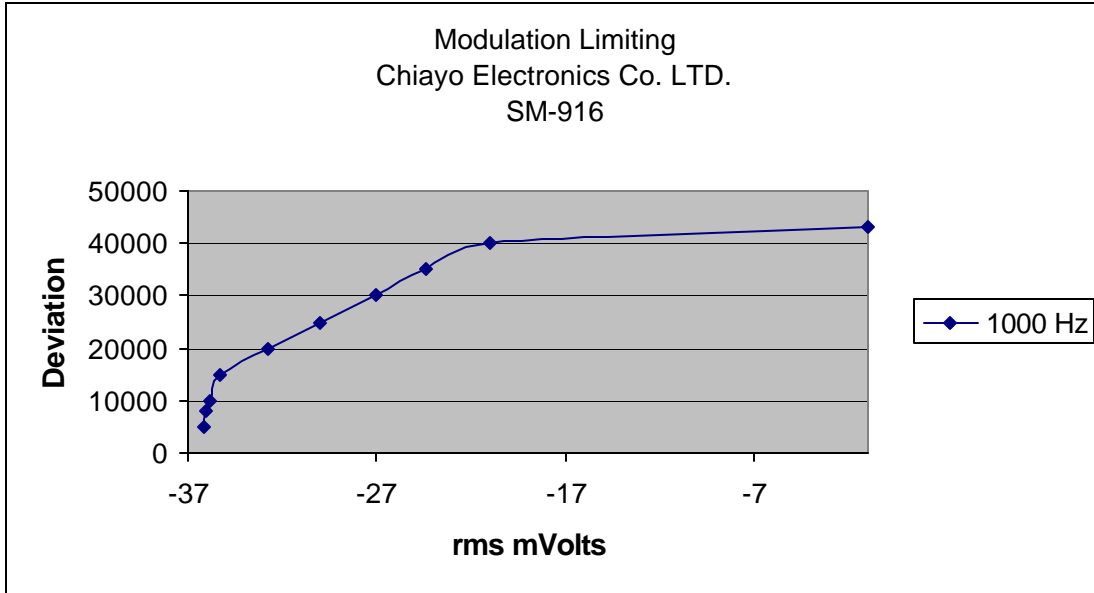

MODULATION LIMITING PLOT - 5000 Hz

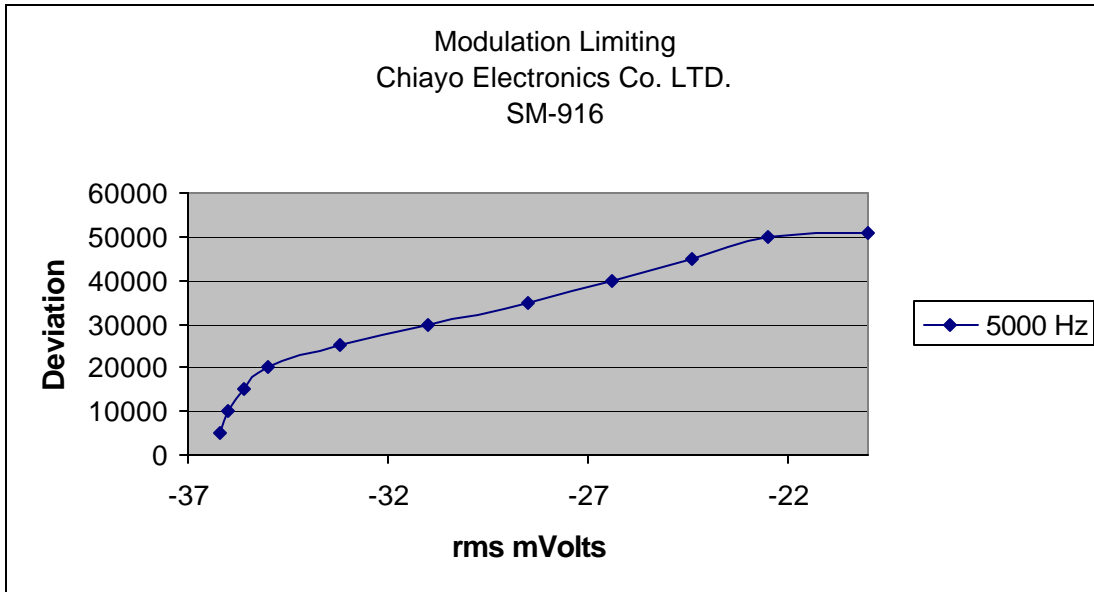

AUDIO LOW PASS FILTER

The audio low pass filter is not required in this unit.

2.1049(c) Occupied Bandwidth:

Data in the plots show that all sidebands between 50 & 100% of the authorized bandwidth are attenuated by at least 25dB. From 100 to 250% of the authorized bandwidth, they are attenuated by at least 35dB. Beyond 250% of the authorized bandwidth, at least $43 + \log(P_o)$ dB. The plot shows the transmitter modulated with 15000 Hz(the highest modulation frequency), adjusted for 50% modulation plus 16 dB. The spectrum analyzer was set with the unmodulated carrier at the top of the screen. The test procedure diagram and occupied bandwidth plots follow.

OCCUPIED BANDWIDTH PLOT

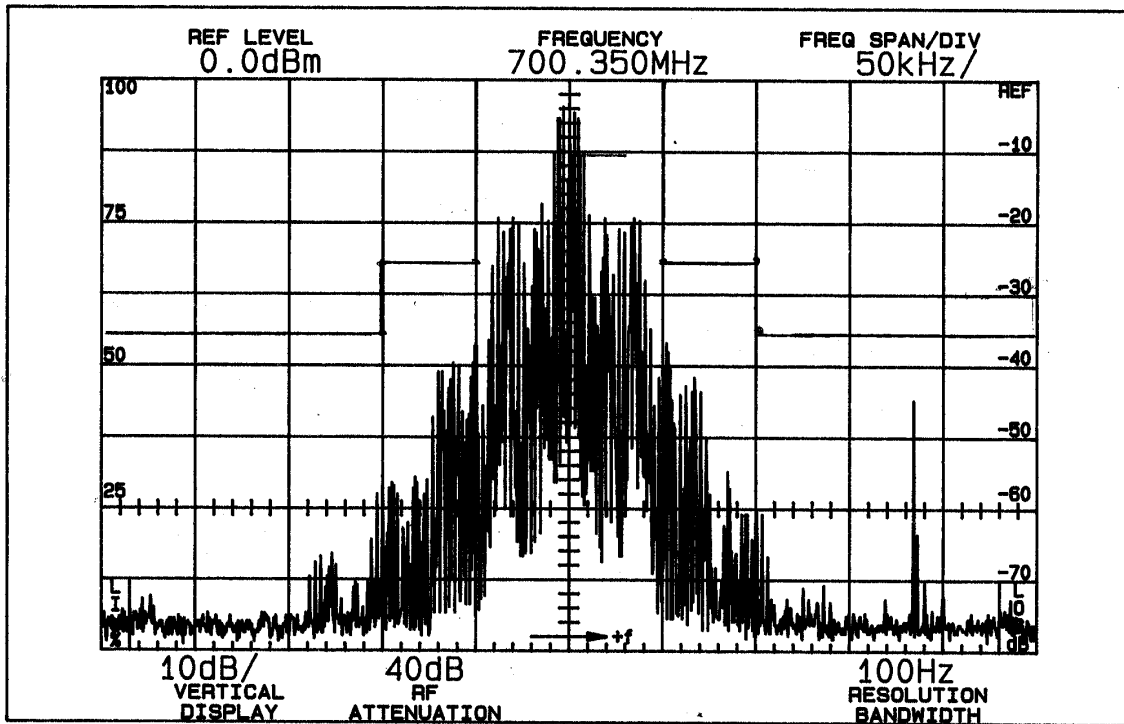

Wireless Microphone transmitter:

Test procedure diagram

OCCUPIED BANDWIDTH MEASUREMENT

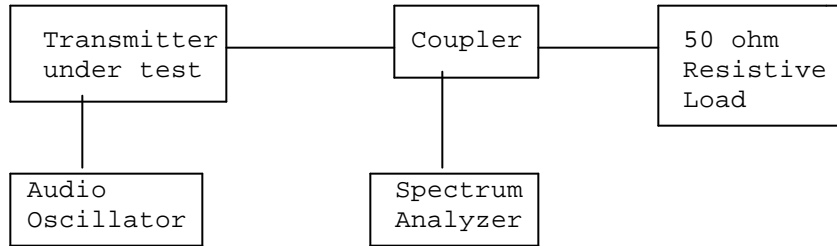

REQUIREMENT: PART 74: 200kHz EMISSION BANDWIDTH

2.1051 Spurious emissions at antenna terminals(conducted):
Not Applicable no antenna connector.

2.1053(a)(b) Field strength of spurious emissions:

NAME OF TEST: RADIATED SPURIOUS EMISSIONS

REQUIREMENTS: Emissions must be 43 +10log(Po) dB below the mean power output of the transmitter.

$$43 + 10 \log(0.028) = 27.47 \text{ dB}$$

TEST DATA:

Emission Frequency MHz	ATTN dBc	dBm
700.36	0	14.5
1,400.72	56	-32
2,101.08	42	-28
2,801.44	45	-31
3,501.80	50	-36
4,202.16	56	-42
4,902.52	62	-48
5,602.88	65	-51
6,303.24	63	-49
7,003.60	59	-45

****The unit was scanned at three places in the band and the worst case scenario is presented.**

METHOD OF MEASUREMENT: The procedure used was TIA/EIA STANDARD 603 substitution method. The spectrum was scanned from 30 to at least the tenth harmonic of the fundamental using a HP model 8566B spectrum analyzer and an appropriate antenna. Measurements were made at the open field test site of TIMCO ENGINEERING INC. located at 849 NW SR 45 Newberry, Florida 32669.

APPLICANT: CHIAYO ELECTRONICS CO., LTD.

FCC ID: CINSM-916

REPORT #: C:\CHIAYOCIN\1284UT2\1284UT2TestReport.doc

Method of Measuring Radiated Spurious Emissions

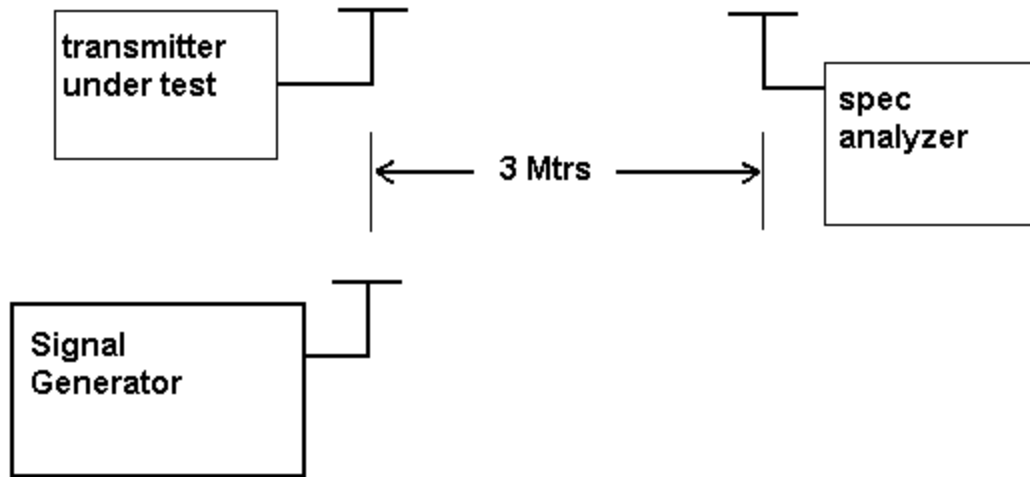

2.1055 Frequency stability:
S74.861(e)(4)

Temperature and voltage tests were performed to verify that the frequency remains within the .0050%,(50 ppm)(74.861 e.4) specification limit.

The test was conducted as follows: The transmitter was placed in the temperature chamber at 25 degrees C and allowed to stabilize for one hour. The transmitter was keyed ON for one minute during which four frequency readings were recorded at 15-second intervals. The worse case number was taken for temperature plotting. The assigned channel frequency was considered to be the reference frequency. The temperature was then reduced to -30 degrees C after which the transmitter was again allowed to stabilize for one hour. The transmitter was keyed ON for one minute, and again frequency readings were noted at 15-second intervals. The worst-case number was recorded for temperature plotting. This procedure was repeated in 10-degree increments up to + 50 degrees C.

MEASUREMENT DATA:

Temperature C	Frequency Mhz	PPM
-29.40	700.354624	3.75
-19.60	700.358249	8.92
-9.50	700.359439	10.62
0.50	700.358677	9.53
9.90	700.356436	6.33
20.10	700.352471	0.67
30.00	700.347657	-6.20
39.80	700.343018	-12.82
<u>50.30</u>	700.338170	-19.75

Battery End Point 8.10 Vdc .10 ppm

RESULTS OF MEASUREMENTS: The above test data indicates that the EUT meets the requirements.

EMC Equipment List

APPLICANT: CHIAYO ELECTRONICS CO., LTD.
FCC ID: CINSM-916
REPORT #: C:\CHIAYOCIN\1284UT2\1284UT2TestReport.doc
Page 8 of 11

	DEVICE	MFGR	MODEL		CAL/CHAR DATE	DUE DATE or STATUS
X	3-Meter OATS	TEI	N/A	N/A	Listed 12/22/99	12/22/02
	3/10-Meter OATS	TEI	N/A	N/A	Listed 3/26/01	3/26/04
	Receiver, Beige Tower Spectrum Analyzer (Tan)	HP	8566B Opt 462	3138A07786 3144A20661	CAL 8/31/01	8/31/03
	RF Preselector (Tan)	HP	85685A	3221A01400	CAL 8/31/01	8/31/03
	Quasi-Peak Adapter (Tan)	HP	85650A	3303A01690	CAL 8/31/01	8/31/03
X	Receiver, Blue Tower Spectrum Analyzer (Blue)	HP	8568B	2928A04729 2848A18049	CHAR 10/22/01	10/22/03
X	RF Preselector (Blue)	HP	85685A	2926A00983	CHAR 10/22/01	10/22/03
X	Quasi-Peak Adapter (Blue)	HP	85650A	2811A01279	CHAR 10/22/01	10/22/03
X	Biconnical Antenna	Electro-Metrics	BIA-25	1171	CAL 4/26/01	4/26/03
	Biconnical Antenna	Eaton	94455-1	1096	CAL 10/1/01	10/1/03
	Biconnical Antenna	Eaton	94455-1	1057	CHAR 3/15/00	3/15/02
	BiconiLog Antenna	EMCO	3143	9409-1043		
X	Log-Periodic Antenna	Electro-Metrics	LPA-25	1122	CAL 10/2/01	10/2/03
	Log-Periodic Antenna	Electro-Metrics	EM-6950	632	CHAR 10/15/01	10/15/03
	Log-Periodic Antenna	Electro-Metrics	LPA-30	409	CHAR 10/16/01	10/16/03
	Dipole Antenna Kit	Electro-Metrics	TDA-30/1-4	152	CAL 3/21/01	3/21/04
	Dipole Antenna Kit	Electro-Metrics	TDA-30/1-4	153	CHAR 11/24/00	11/24/03
	Double-Ridged Horn Antenna	Electro-Metrics	RGA -180	2319	CAL 12/19/01	12/19/03
	Horn Antenna	Electro-Metrics	EM-6961	6246	CAL 3/21/01	3/21/03
	Horn Antenna	ATM	19-443-6R	None	No Cal Required	
	Passive Loop Antenna	EMC Test Systems	EMCO 6512	9706-1211	CHAR 7/10/01	7/10/03
	Line Impedance Stabilization . . .	Electro-Metrics	ANS-25/2	2604	CAL 10/9/01	10/9/03
	Line Impedance Stabilization . . .	Electro-Metrics	EM-7820	2682	CAL 3/16/01	3/16/03
	Termaline Wattmeter	Bird Electronic Corporation	611	16405	CAL 5/25/99	5/25/01

APPLICANT: CHIAYO ELECTRONICS CO., LTD.

FCC ID: CINSM-916

REPORT #: C:\CHIAYOCIN\1284UT2\1284UT2TestReport.doc

	DEVICE	MFGR	MODEL		CAL/CHAR DATE	DUE DATE or STATUS
	Termaline Wattmeter	Bird Electronic Corporation	6104	1926	CAL 12/12/01	12/12/03
	Oscilloscope	Tektronix	2230	300572	CHAR 2/1/01	2/1/03
	Temperature Chamber	Tenney Engineering	TTRC	11717-7	CHAR 1/22/02	1/22/04
	AC Voltmeter	HP	400FL	2213A14499	CAL 10/9/01	10/9/03
	AC Voltmeter	HP	400FL	2213A14261	CHAR 10/15/01	10/15/03
	AC Voltmeter	HP	400FL	2213A14728	CHAR 10/15/01	10/15/03
X	Digital Multimeter	Fluke	77	35053830	CHAR 1/8/02	1/8/04
	Digital Multimeter	Fluke	77	43850817	CHAR 1/8/02	1/8/04
	Digital Multimeter	HP	E2377A	2927J05849	CHAR 1/8/02	1/8/04
	Multimeter	Fluke	FLUKE-77-3	79510405	CAL 9/26/01	9/26/03
	Peak Power Meter	HP	8900C	2131A00545	CHAR 1/26/01	1/26/03
	Digital Thermometer	Fluke	2166A	42032	CAL 1/16/02	1/16/04
	Thermometer	Traulsen	SK-128		CHAR 1/22/02	1/22/04
X	Temp/Humidity gauge	EXTech	44577F	E000901	CHAR 1/22/02	1/22/04
	Frequency Counter	HP	5352B	2632A00165	CAL 11/28/01	11/28/03
	Power Sensor	Agilent Technologies	84811A	2551A02705	CAL 1/26/01	1/26/03
	Service Monitor	IFR	FM/AM 500A	5182	CAL 11/22/00	11/22/02
	Comm. Serv. Monitor	IFR	FM/AM 1200S	6593	CAL 5/12/02	5/12/04
	Signal Generator	HP	8640B	2308A21464	CAL 11/15/01	11/15/03
	Modulation Analyzer	HP	8901A	3435A06868	CAL 9/5/01	9/5/03
	Near Field Probe	HP	HP11940A	2650A02748	CHAR 2/1/01	2/1/03
	BandReject Filter	Lorch Microwave	5BR4-2400/ 60-N	Z1	CHAR 3/2/01	3/2/03
	BandReject Filter	Lorch Microwave	6BR6-2442/ 300-N	Z1	CHAR 3/2/01	3/2/03
	BandReject Filter	Lorch Microwave	5BR4-10525/ 900-S	Z1	CHAR 3/2/01	3/2/03

APPLICANT: CHIAYO ELECTRONICS CO., LTD.

FCC ID: CINSM-916

REPORT #: C:\CHIAYOCIN\1284UT2\1284UT2TestReport.doc

	DEVICE	MFGR	MODEL		CAL/CHAR DATE	DUE DATE or STATUS
	High Pas Filter	Microlab	HA-10N		CHAR 10/4/01	10/4/03
	Audio Oscillator	HP	653A	832-00260	CHAR 3/1/01	3/1/03
	Frequency Counter	HP	5382A	1620A03535	CHAR 3/2/01	3/2/03
	Frequency Counter	HP	5385A	3242A07460	CHAR 12/11/01	12/11/03
	Preamplifier	HP	8449B-H02	3008A00372	CHAR 3/4/01	3/4/03
	Amplifier	HP	11975A	2738A01969	CHAR 3/1/01	3/1/03
	Egg Timer	Unk			CHAR 8/31/01	8/31/03
	Measuring Tape, 20M	Kraftixx	0631-20		CHAR 2/1/02	2/1/04
	Measuring Tape, 7.5M	Kraftixx	7.5M PROFI		2/1/02	2/1/04
	Coaxial Cable #51	Insulated Wire Inc.	NPS 2251-2880	Timco #51	CHAR 1/23/02	1/23/04
	Coaxial Cable #64	Semflex Inc.	60637	Timco #64	CHAR 1/24/02	1/24/04
	Coaxial Cable #65	General Cable Co.	E9917 RG233/U	Timco #65	CHAR 1/23/02	1/23/04
	Coaxial Cable #106	Unknown	Unknown	Timco #106	CHAR 1/23/02	1/23/04