



**ELECTRONIC TECHNOLOGY SYSTEMS  
DR. GENZ GMBH**

# **FCC TEST - REPORT**

**FCC RULES PARTS 74 Subpart H, Section 74.861**

**FCC ID : CINSM-6000**

**Test report no.:**

**W6M20408-5422-C-1**

## TABLE OF CONTENTS

<b>1</b>	<b>GENERAL INFORMATION .....</b>	<b>3</b>
1.1	NOTES .....	3
1.2	TESTING LABORATORY.....	4
1.2.1	<i>Location</i> .....	4
1.2.2	<i>Details of accreditation status</i> .....	4
1.3	DETAILS OF APPROVAL HOLDER.....	4
1.4	APPLICATION DETAILS .....	5
1.5	GENERAL INFORMATION OF TEST ITEM .....	5
	TECHNICAL DATA.....	5
1.6	TEST STANDARDS.....	6
<b>2</b>	<b>TECHNICAL TEST .....</b>	<b>6</b>
2.1	SUMMARY OF TEST RESULTS .....	6
2.2	TEST ENVIRONMENT.....	6
2.3	TEST EQUIPMENT LIST .....	7
2.4	GENERAL TEST PROCEDURE .....	20
<b>3</b>	<b>TEST RESULTS (ENCLOSURE).....</b>	<b>21</b>
<b>4</b>	<b>RF POWER OUTPUT (CONDUCTED) , FCC 2.1046 (A) ; 74.861 (E).....</b>	<b>22</b>
4.1	TEST PROCEDURE .....	22
4.2	TEST RESULTS.....	22
<b>5</b>	<b>RADIATED POWER .....</b>	<b>23</b>
5.1	TEST PROCEDURE.....	23
5.2	TEST RESULTS .....	24
<b>6</b>	<b>MODULATION DEVIATION , FCC 2.1047 (B) ; 74.861(E).....</b>	<b>25</b>
6.1	TEST PROCEDURE .....	25
6.2	TEST RESULTS .....	25
<b>7</b>	<b>AUDIO FREQUENCY RESPONSE , FCC 2.1047 (A) .....</b>	<b>26</b>
7.1	TEST PROCEDURE .....	26
7.2	TEST RESULTS .....	26
<b>8</b>	<b>OCCUPIED BANDWIDTH/EMISSION MASK, FCC 2.1049 (C) ; 74.861 (E)(5).....</b>	<b>27</b>
8.1	TEST PROCEDURE .....	27
8.2	TEST RESULTS.....	27
<b>9</b>	<b>SPURIOUS EMISSIONS AT ANTENNA TERMINALS FCC2.1051 ; 74.861 (E).....</b>	<b>28</b>
9.1	TEST PROCEDURE .....	28
9.2	TEST RESULTS.....	28
9.2	LIMIT .....	29

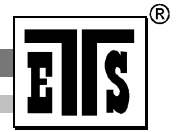

Registration number: W6M20408-5422-C-1  
 FCC ID: CINSM-6000

<b>10</b>	<b>RADIATED SPURIOUS EMISSION , FCC 2.1053 ; 74.861 (E) .....</b>	<b>30</b>
10.1	TEST PROCEDURE .....	30
10.2	TEST RESULTS.....	30
10.3	EXPLANATION OF TEST RESULT .....	32
10.4	LIMITS.....	32
<b>11</b>	<b>LINE CONDUCTED EMISSION , FCC 15.207.....</b>	<b>33</b>
11.1	TEST PROCEDURE .....	33
11.2	TEST RESULTS.....	33
<b>12</b>	<b>FREQUENCY STABILITY VS. TEMPERATURE , FCC 2.1055 , 74.861 (E).....</b>	<b>34</b>
12.1	TEST PROCEDURE .....	34
12.2	TEST RESULTS.....	34
<b>615 MHZ .....</b>		<b>34</b>
<b>13</b>	<b>FREQUENCY STABILITY VS. VOLTAGE , FCC 2.1055 (D) ; 74.861 (E).....</b>	<b>36</b>
13.1	TEST PROCEDURE .....	36
13.2	TEST RESULTS.....	36
<b>APPENDIX .....</b>		<b>37</b>
APPENDIX A .....		38
APPENDIX B .....		39
APPENDIX C .....		42
APPENDIX D.....		43
APPENDIX E .....		44
APPENDIX F .....		45
APPENDIX G.....		46
Appendix H.....		47
APPENDIX I .....		48

Registration number: W6M20408-5422-C-1  
FCC ID: CINSM-6000

## 1 General Information

### 1.1 Notes

The purpose of conformity testing is to increase the probability of adherence to the essential requirements or conformity specifications, as appropriate.

The complexity of the technical specifications, however, means that full and thorough testing is impractical for both technical and economic reasons.

Furthermore, there is no guarantee that a test sample which has Passed all the relevant tests conforms to a specification.

Neither is there any guarantee that such a test sample will interwork with other genuinely open systems.

The existence of the tests nevertheless provides the confidence that the test sample possesses the qualities as maintained and that its performance generally conforms to representative cases of communications equipment.

The test results of this test report relate exclusively to the item tested as specified in 1.5.

The test report may only be reproduced or published in full.

Reproduction or publication of extracts from the report requires the prior written approval of the ELECTRONIC TECHNOLOGY SYSTEMS DR. GENZ GMBH.

### Tester:

06.09.2004

Ralf Schultze



Date

ETS-Lab.

Name

Signature

### Technical responsibility for area of testing:

06.09.2004

N. Kasper



Date

ETS

Name

Signature

Registration number: W6M20408-5422-C-1  
FCC ID: CINSM-6000

## **1.2 Testing laboratory**

### **1.2.1 Location**

ELECTRONIC TECHNOLOGY SYSTEM DR. GENZ GMBH (ETS)  
Storkower Straße 38c  
D-15526 Reichenwalde b. Berlin  
Germany  
Telefon : +49 33631 888 00  
Telefax : +49 33631 888 66

### **1.2.2 Details of accreditation status**

Accredited testing laboratory  
**DAR-REGISTRATION NUMBER:** TTI-P-G 126/96

Accredited Competent Body  
**DAR-REGISTRATION NUMBER:** BPT-ZE-026/96

**FCC FILED TEST LABORATORY** REG. NO. 96970

**BLUETOOTH QUALIFICATION TEST FACILITY (BQTF)**  
ACCREDITED BY: BLUETOOTH QUALIFICATION REVIEW BOARD (BQRF)

**INDUSTRY CANADA FILED TEST LABORATORY** REG. NO. IC 3470

**A2LA ACCREDITED** Certificate Number: 1983-01

## **1.3 Details of approval holder**

Name : CHIAYO ELECTRONICS CO., LTD.  
Street : No.88, Chung Hsiao Street 2  
Town : Chiayi  
Country : Taiwan , R.O.C.  
Telephone : +886-5-271-1000  
Fax : +886-5-276-7611  
  
Contact : Mrs.Teresa Hung  
Telephone : +886-5-271-1000

Registration number: W6M20408-5422-C-1  
 FCC ID: CINSM-6000

#### 1.4 Application details

Date of receipt of application : 18.08.2004  
 Date of receipt of test sample : 20.08.2004  
 Date of test : from 20.08.2004 to 02.09.2004

#### 1.5 General information of Test item

Type of test item : Wireless Microphone Transmitter  
 Model Number : SM-6000  
 Serial number : without  
 Photos : see Annex

#### Technical data

Frequency band :

Frequency(MHz)	TV Band	Used Band
26.100-26.480	<input type="checkbox"/>	<input type="checkbox"/>
54.000-72.000	<input checked="" type="checkbox"/>	<input type="checkbox"/>
76.000-88.000	<input checked="" type="checkbox"/>	<input type="checkbox"/>
161.625-161.775	<input type="checkbox"/>	<input type="checkbox"/>
174.000-216.000	<input checked="" type="checkbox"/>	<input type="checkbox"/>
450.000-451.000	<input type="checkbox"/>	<input type="checkbox"/>
455.000-456.000	<input type="checkbox"/>	<input type="checkbox"/>
470.000-488.000	<input type="checkbox"/>	<input type="checkbox"/>
488.000-494.000	<input checked="" type="checkbox"/>	<input type="checkbox"/>
494.000-608.000	<input checked="" type="checkbox"/>	<input type="checkbox"/>
614.000-806.000	<input checked="" type="checkbox"/>	<input checked="" type="checkbox"/>
944.000-952.000	<input type="checkbox"/>	<input type="checkbox"/>

Frequency ( ch A) : 615 MHz  
 Frequency ( ch B) : 710 MHz  
 Frequency ( ch C) : 805.795 MHz

Antenna Type : 1/4 wire Antenna

Registration number: W6M20408-5422-C-1  
FCC ID: CINSM-6000

Antenna Gain : 0 dBi  
Power supply : 3 VDC (1.5 VDC x 2 Battery)  
Operation modes : Simplex

**Manufacturer:**  
(if applicable)

Name : ./.  
Street : ./.  
Town : ./.  
Country : ./.

**1.6 Test standards**

Technical standard : FCC Part 74 Subpart H , section 74.861  
Additional information : none

**2 Technical test**

**2.1 Summary of test results**

No deviations from the technical specification(s) were ascertained in the course of the tests performed.

**or**

The deviations as specified in 2.5 were ascertained in the course of the tests performed.

**2.2 Test environment**

Temperature : 23 °C  
Relative humidity content : 20 ... 75 %  
Air pressure : 86 ... 103 kPa

Registration number: W6M20408-5422-C-1  
FCC ID: CINSM-6000

### 2.3 Test Equipment List

No.	Test equipment	Type	Manufacturer
ETS 0001	Test receiver	ESHS 10	Rohde & Schwarz
ETS 0002	Test receiver	ESVP	Rohde & Schwarz
ETS 0003	Test receiver	ESVS 10	Rohde & Schwarz
ETS 0004	Spektrum- and Network-Analyzer	FSMS 26	Rohde & Schwarz
ETS 0005	Test receiver	SMV 11	MEB
ETS 0006	Test receiver system	SME 12	MEB
ETS 0008	Antenna	Loop antenna	Siemens
ETS 0009	Antenna	ARA 2	MEB
ETS 0010	Antenna	Loop antenna	MEB
ETS 0011	Antenna	van Veen/ Frame	Rohde & Schwarz
ETS 0012	Antenna	HK 116	Rohde & Schwarz
ETS 0013	Antenna	HL 223	Rohde & Schwarz
ETS 0014	Antenna	HL 025	Rohde & Schwarz
ETS 0015	Antenna	HL 025	Rohde & Schwarz
ETS 0016	Precision antenna kit	VHAP	Schwarzbeck
ETS 0017	Precision antenna kit	UHAP	Schwarzbeck
ETS 0020	Antenna	DP 21	MEB
ETS 0021	Antenna	DP 3	MEB
ETS 0022	Antenna	SAS-200/ 521	A.H. Systeme+D65
ETS 0023	Antenna	DP 1	MEB
ETS 0024	Antenna mast	AF 2	MEB
ETS 0025	Antenna mast	AF 2	MEB
ETS 0026	Tripod		Heinrich Deisel
ETS 0027	Tripod		Heinrich Deisel
ETS 0028	Tripod	STA 2	C. Lorenz AG
ETS 0029	Tripod		Berlebach
ETS 0031	Turn table	DS 412	Heinrich Deisel
ETS 0032	Controllor	HD 050	Heinrich Deisel
ETS 0033	RF generator	SMG	Rohde & Schwarz
ETS 0034	RF generator/ Amplifier	SMLR	Rohde & Schwarz
ETS 0035	RF generator/ Amplifier	SMLM	Rohde & Schwarz
ETS 0038	RF amplifier	150L	Amplifier Research
ETS 0039	Absorbing clamp	MDS 21	Rohde & Schwarz
ETS 0040	Artificial mains	ESH3-Z5	Rohde & Schwarz



Registration number: W6M20408-5422-C-1  
FCC ID: CINSM-6000

No.	Test equipment	Type	Manufacturer
ETS 0041	Artificial mains	ESH3-Z4	Rohde & Schwarz
ETS 0042	Artificial mains	ESH3-Z6	Rohde & Schwarz
ETS 0044	Artificial mains	NNB 111	MEB
ETS 0045	Stripe line	IEC 801-3	ETS
ETS 0046	Power supply	LTS 006	RFT
ETS 0047	Power supply	TG 20/ 1	Statron
ETS 0048	Power supply	TG 20/ 1	Statron
ETS 0049	Power supply	T 102	TPW
ETS 0050	Power supply	T 101b	TPW
ETS 0051	Oscilloscope	TDS 640A	Tektronix
ETS 0052	Audio analyzer	UPA 4	Rohde & Schwarz
ETS 0053	ECAT Controlcentre	CE 40	Keytek/ EMV
ETS 0054	EFT simulator	E 412	Keytek/ EMV
ETS 0055	Modul network coupler	E 4551	Keytek/ EMV
ETS 0056	Blank plug-in		Keytek/ EMV
ETS 0057	Module SURGE with DC coupler	E 501	Keytek/ EMV
ETS 0058	Capacitive coupling clamp	E 502 B	Keytek/ EMV
ETS 0059	Kikusui amplfier	PCR 2000L	Keytek/ EMV
ETS 0060	Xitron power analyzer		Keytek/ EMV
ETS 0061	Power/ Arb (Harm., Ramp)		Keytek/ EMV
ETS 0062	Reference impedance		Keytek/ EMV
ETS 0063	Blank plug-in		Keytek/ EMV
ETS 0064	CDN IEC 1000-4-6		Keytek/ EMV
ETS 0065	ESD-generator minizap		Keytek/ EMV
ETS 0066	EM Injection Clamp		FCC/ EMV
ETS 0067	Calibration Fixture	IEC 801-2031 CF	FCC/ EMV
ETS 0068	CDN IEC 1000-4-6	CDN	FCC/ EMV
ETS 0069	EM Radiation Monitor	EMR-20	Wandel & Goltermann
ETS 0070	PC Transfer set EMR-20	EMR-20	Wandel & Goltermann
ETS 0071	Videocamera system	KMB012	Kocom
ETS 0072	Interphone system	JS-1400	Jiuh Sheng
ETS 0073	Audio noise meter	GSM 2	MKD/ RFT
ETS 0074	RF milivoltmeter	QRV 2	MKD/ RFT
ETS 0075	NF generator	GF 22	Präcitronic
ETS 0076	Feeding bridge A	SBA 1000	ESP
ETS 0077	Audio/ Video Filter set	AV 55020	ETS

Registration number: W6M20408-5422-C-1

FCC ID: CINSM-6000

No.	Test equipment	Type	Manufacturer
ETS 0078	LCR meter	SR 720	SRS
ETS 0079	Functional generator	MX-2020	Maxcom
ETS 0080	EMI Software	ES-K1	Rohde & Schwarz
ETS 0081	EMI Software	ES-K10	Rohde & Schwarz
ETS 0082	PC Novell network system	Novell	Esotronic
ETS 0083	Apple computer sstem	Performa 630	Macintosh
ETS 0084	Processcontroler	PSA 15	Rohde & Schwarz
ETS 0085	Shielded room	SR 1	Frankonia
ETS 0086	Anechoic chamber	AC 1	Frankonia
ETS 0087	Climatic cell	HC 4033	Heraeus
ETS 0088	Colour TV pattern generator	PM 5518-TX VPS	Philips
ETS 0089	Radiocommunication tester	CMS 54	Rohde & Schwarz
ETS 0090	DECT type approval CTR06	TS 8930	Rohde & Schwarz
ETS 0091	RF signal generator	SME 03	Rohde & Schwarz
ETS 0092	DM-Coder	SME-B11	Rohde & Schwarz
ETS 0093	Pulse Modulator	SM-B8	Rohde & Schwarz
ETS 0095	DECT system controller	PSMD	Rohde & Schwarz
ETS 0096	DECT Signalling unit	PSMD-B11	Rohde & Schwarz
ETS 0097	Rack, 19", 36 HU	TS 89RA	Rohde & Schwarz
ETS 0098	System engineering and software	CS 893BE	Rohde & Schwarz
ETS 0099	Extension unit for basic version	TS 8930B	Rohde & Schwarz
ETS 0100	RF signal generator	SME-06	Rohde & Schwarz
ETS 0101	DM-Coder	SME-B11	Rohde & Schwarz
ETS 0102	Pulse modulator	SM-B8	Rohde & Schwarz
ETS 0103	Pulse generator	SM-B4	Rohde & Schwarz
ETS 0105	High power synthesizer/ sweeper	SMP 22 / 02	Rohde & Schwarz
ETS 0106	Frequency extension	SMP-B11	Rohde & Schwarz
ETS 0107	RF attenuator for SMP 22	SMP-B15	Rohde & Schwarz
ETS 0108	DECT protocol tester TBR 22	TS 1220	Rohde & Schwarz
ETS 0109	Process controller	PSM 2	Rohde & Schwarz
ETS 0110	Real time signalling unit	PSMD-B2	Rohde & Schwarz
ETS 0111	PCM Realtime audio interface for PSM	PSMD-B3	Rohde & Schwarz
ETS 0112	Synthesizer Module	PSMD-B4	Rohde & Schwarz
ETS 0113	Keyboard	PSA-Z2	Rohde & Schwarz
ETS 0114	RF step attenuator	RSG	Rohde & Schwarz

Registration number: W6M20408-5422-C-1

FCC ID: CINSM-6000

No.	Test equipment	Type	Manufacturer
ETS 0115	Glide path		Rohde & Schwarz
ETS 0116	RF Millivoltmeter	URV 55	Rohde & Schwarz
ETS 0117	Insertion unit	URV-Z2	Rohde & Schwarz
ETS 0118	Mixer	MFC 1000	Avcom
ETS 0119	Mixer	MFC 2000	Avcom
ETS 0120	RF step attenuator	TRI-50-20	INCO
ETS 0121	Oscilloscope	EO 147A	Serute
ETS 0122	Oscilloscope	5201	Dagatron
ETS 0123	RF step attenuator	RBU	Rohde & Schwarz
ETS 0124	Tripod	STA 2	Rohde & Schwarz
ETS 0126	Uninterruptable power supply	UPS - 1500	Sendon
ETS 0127	Uninterruptable power supply	UPS - 1000 LC	Sendon
ETS 0128	Uninterruptable power supply	UPS - 1000	Sendon
ETS 0129	Uninterruptable power supply	UPS - 500	Sendon
ETS 0130	Uninterruptable power supply	Power saver	Sendon
ETS 0131	Telephone connection box		Systel
ETS 0132	Frequency doubler	TR-0616	EMG
ETS 0133	Probe body	P6015	Tektronix
ETS 0134	Mains filter	MSF	Erika Fiedler
ETS 0135	Measureing switching point	AK 11	RFT
ETS 0136	Attenuator	33-6-34	Weinschel
ETS 0137	Multimeter	YX-360TRA	Mastech
ETS 0138	Multimeter	DT-9410	Diditec
ETS 0139	Multimeter	ST-9202	Standard
ETS 0140	High voltage generator	IP 6Wa	TPW
ETS 0141	Sliding bridge	J 573	RFT
ETS 0142	Impedanz converter	TK 11	RFT
ETS 0143	Impedanz converter	TK 12	RFT
ETS 0146	Aktive RF probe	ESH2-Z2	Rohde & Schwarz
ETS 0147	Probe	TK 103	MEB
ETS 0148	Test TV	21PT4301/00	Philips
ETS 0149	Power divider	ZAPD-21	MCL
ETS 0150	Switcher	HR07-720	Wisi
ETS 0151	Interference pulse generator	NSG 500C	Schaffner
ETS 0152	Simulator for Load-Dump-Impulse	NSG 506C (I)	Schaffner
ETS 0153	Simulator for Load-Dump-Impulse	NSG 506C (II)	Schaffner

Registration number: W6M20408-5422-C-1

FCC ID: CINSM-6000

No.	Test equipment	Type	Manufacturer
ETS 0154	Signalgenerator	SMG	Rohde & Schwarz
ETS 0155	Signalgenerator	SMG	Rohde & Schwarz
ETS 0156	Adjacent channel power meter	NKS	Rohde & Schwarz
ETS 0157	TV and Sat-Signalgenerator	VTG 700	Grundig
ETS 0158	TV and Sat Signalgenerator	VTG 700	Grundig
ETS 0159	Programmable power supply	TOE 8815	Toellner
ETS 0160	Protective wire and isolation tester	PI 6001 D	SPS electronic
ETS 0161	Filter system / consumer electronic		Fiedler
ETS 0162	Acoustic chamber	403-A	IAC
ETS 0163	Test head	BK 4602	Brüel & Kjær
ETS 0164	Simulator ear	BK 4185	Brüel & Kjær
ETS 0165	Simulator mouth	BK 4227	Brüel & Kjær
ETS 0166	Acoustic calibrator	BK 4231	Brüel & Kjær
ETS 0167	Communication Analysis System	CAS TE I	HEAD acoustics
ETS 0168	Acoustical test for DECT	CTR 10	HEAD acoustics
ETS 0169	Measurement - Frontend (analog)	MFE III	HEAD acoustics
ETS 0170	Measurement - Frontend (digital)	MFE IV	HEAD acoustics
ETS 0171	Electronic test cradle	TEH	HEAD acoustics
ETS 0172	Noise generator	HNG III.1	HEAD acoustics
ETS 0173	Speaker	Canton S Pluss	HEAD acoustics
ETS 0174	Measurement - Frontend line interface	MFE V	HEAD acoustics
ETS 0175	Software Line interface (analog)	COPTZV5	HEAD acoustics
ETS 0176	Acoustic volt meter	COP 4	HEAD acoustics
ETS 0177	Feeding bridge B	SBB 1000	ESP
ETS 0178	Open area test side	10m	ETS
ETS 0180	Artificial mains	NNB01/RFZ	RFZ
ETS 0181	Test pin for protective wire	PE 156-i	SPS electronic
ETS 0182	Power supply	MX-9300	Maxcom
ETS 0183	Frequency counter	MX-9300	Maxcom
ETS 0184	Function generator	MX-9300	Maxcom
ETS 0185	Digital multimeter	MX-9300	Maxcom
ETS 0186	Power supply	DF 1730	WJG
ETS 0187	Power supply		TPW/RFT
ETS 0189	Spectrum Analyzer	FSEB	Rohde & Schwarz
ETS 0190	Function generator	MX 2020	Maxcom

Registration number: W6M20408-5422-C-1

FCC ID: CINSM-6000

No.	Test equipment	Type	Manufacturer
ETS 0191	Sweep function generator	7202	Dagatron
ETS 0192	Audio generator	7101	Dagatron
ETS 0193	Vibration table	N1-201-M	Sandbox
ETS 0194	Digital multimeter	PMM 208	Dagatron
ETS 0195	Thermo hygro recorder		Amarell
ETS 0196	Digital thermometer	AK-688	KD
ETS 0197	Digital thermometer		Prima
ETS 0198	Digital thermometer	ad 170th	ama-digit
ETS 0199	Digital thermometer	ad 31th	ama-digit
ETS 0200	Digital thermometer / hygro meter	ad 90h	ama-digit
ETS 0201	Digital thermometer / hygro meter	37950-10	Cole Parmer
ETS 0202	Digital thermometer	ad 15th	ama-digit
ETS 0203	Digital thermometer	Type K	Amarell
ETS 0204	Digital thermometer	ad 20th	ama-digit
ETS 0205	High voltage test generator	HA 3300 D	SPS electronic
ETS 0206	High voltage test accessoires	HVGZ 312	SPS electronic
ETS 0207	Socket-Outlet torque balance	F 37.13	PTL
ETS 0208	Unjointed Finger probe	P 10.05	PTL
ETS 0209	Flixible Finger probe	P 10.01	PTL
ETS 0210	Spring operated impact hammer	P 22.50	PTL
ETS 0211	Metallic ball	F 53.32	PTL
ETS 0212	Hazardous live probe	P 10.06	PTL
ETS 0213	Hazardous live probe	P 10.11	PTL
ETS 0214	Ball pressure test apparatus	T 10.02	PTL
ETS 0215	Glow Wire tester	T 03.14	PTL
ETS 0216	Force indicator 50N	P 10.31	PTL
ETS 0217	Millivolt meter	URV 55	Rohde & Schwarz
ETS 0218	RF probe	URV5-Z7	Rohde & Schwarz
ETS 0219	Power sensor	NRV-Z2	Rohde & Schwarz
ETS 0220	Insertion unit	URV5-Z4	Rohde & Schwarz
ETS 0221	ISDN-S0-Analyzer	K1403	Siemens
ETS 0222	ISDN Protocol Analyser	TE965	Tekelec Teleco.
ETS 0223	GSM/ PCN/ PCS-Simul.	TS8915B	Rohde & Schwarz
ETS 0224	GSM System Simulator	FTA	Rohde & Schwarz
ETS 0225	SIM Simulator		Orga
ETS 0226	SIM Editor		Orga

Registration number: W6M20408-5422-C-1

FCC ID: CINSM-6000

No.	Test equipment	Type	Manufacturer
ETS 0227	Vibration table	TIRA vib	GenRad
ETS 0228	Climatic chamber	VT 4010	Vötsch
ETS 0229	Radio Commun. Tester	CMT 54	Rohde & Schwarz
ETS 0230	Radio Commun. Tester	CMD 65	Rohde & Schwarz
ETS 0231	Testreceiver	ESVS 30	Rohde & Schwarz
ETS 0232	Radiation test source	VSQ 1	MEB
ETS 0233	Direction coupler	RK 100	MEB
ETS 0234	Power meter	NRVD	Rohde & Schwarz
ETS 0235	RF-network-analyser	8752 C	Hewlett Packard
ETS 0236	RF-amplifier	100A100	Amplifier Research
ETS 0237	RF-amplifier	100W1000M1	Amplifier Research
ETS 0238	Field strong meter	FM 2000	Amplifier Research
ETS 0239	Isotr. field probe 40 GHz	FP 2080 Kit	Amplifier Research
ETS 0240	Isotr. field probe 1 GHz	FP 2000 Kit	Amplifier Research
ETS 0241	Pulse Generator	4050	PicoSecond PL
ETS 0242	Harmonics analyser	F 41B	Fluke
ETS 0243	AC-clamp 1000 A	80i 1000s	Fluke
ETS 0244	Burst generator	EFT 200	EM-Test
ETS 0245	Load dump generator	LD 200	EM-Test
ETS 0246	Voltage drop simulator	VDS 200	EM-Test
ETS 0247	Microsecond generator	MPG 200	EM-Test
ETS 0248	Switch unit	AN 200	EM-Test
ETS 0249	Coupling network	CNA 200	EM-Test
ETS 0250	Coupling clamp	ACC	EM-Test
ETS 0252	System controller	PSM 12	Rohde & Schwarz
ETS 0253	Spectrum analyser	FSIQ	Rohde & Schwarz
ETS 0254	RF generator	SMIQ 03	Rohde & Schwarz
ETS 0255	RF generator	SMIQ 03	Rohde & Schwarz
ETS 0256	RF generator	SMP 03	Rohde & Schwarz
ETS 0257	Step attenuator	RSP	Rohde & Schwarz
ETS 0258	Rubidium standard	RSTU	DATUM GmbH
ETS 0259	Power meter	NRVD	Rohde & Schwarz
ETS 0260	Power sensor	NRVD-Z1	Rohde & Schwarz
ETS 0261	Power sensor	NRVD-Z1	Rohde & Schwarz
ETS 0262	Switching unit	SSCU	Rohde & Schwarz
ETS 0263	Signaling unit		Wird

Registration number: W6M20408-5422-C-1

FCC ID: CINSM-6000

No.	Test equipment	Type	Manufacturer
ETS 0264	Spectrum analyser	F 1048	HAMEG
ETS 0265	Loop antenna	HFRA 9150	Schwarzbeck
ETS 0267	RF signal generator	SMT 03	Rohde & Schwarz
ETS 0268	RF signal generator	SMP 02	Rohde & Schwarz
ETS 0270	RF signal generator	SMP 04	Rohde & Schwarz
ETS 0271	Test receiver	ESI 40	Rohde & Schwarz
ETS 0272	RF signal generator	SME 03	Rohde & Schwarz
ETS 0273	RF signal generator	SME 03	Rohde & Schwarz
ETS 0274	RF signal generator	SMY 01	Rohde & Schwarz
ETS 0275	Power sensor	NRV-Z51	Rohde & Schwarz
ETS 0276	Audio analyser	UPL	Rohde & Schwarz
ETS 0277	Power sensor	NRV-Z1	Rohde & Schwarz
ETS 0278	Power sensor	NRV-Z31	Rohde & Schwarz
ETS 0279	Step attenuator	RSP	Rohde & Schwarz
ETS 0280	Power meter	NRVD	Rohde & Schwarz
ETS 0281	Spectrum analyser	FSM	Rohde & Schwarz
ETS 0282	RF bridge	86207 A	Hewlett Packard
ETS 0283	RF bridge	86205 A	Hewlett Packard
ETS 0284	Field probe	11940 A	Hewlett Packard
ETS 0285	Field probe	11941 A	Hewlett Packard
ETS 0286	Limiter	11867 A	Hewlett Packard
ETS 0287	Test receiver	ESHS 10	Rohde & Schwarz
ETS 0288	Artificial mains	ESH2-Z5	Rohde & Schwarz
ETS 0289	Audio generator	TAG 101	Troneer
ETS 0290	Audio generator	TAG 101	Troneer
ETS 0291	Loop antenna	HFH2-Z2	Rohde & Schwarz
ETS 0292	RF generator	SMHU	Rohde & Schwarz
ETS 0293	Artificial mains	NNBM 8125	Schwarzbeck
ETS 0294	Biconical antenna	HK 116	Rohde & Schwarz
ETS 0295	LPD antenna	HL 223	Rohde & Schwarz
ETS 0296	Oscilloscope	TDS 520 A	Tektronix
ETS 0297	Power pulse generator	IGUF 2910	Schwarzbeck
ETS 0298	ICO tester	TS 1232	Rohde & Schwarz
ETS 0299	DECT protocol tester	TS 1220	Rohde & Schwarz
ETS 0300	RF amplifier	75 A 250	Amplifier Research
ETS 0301	Relay switch unit	RSU	Rohde & Schwarz

Registration number: W6M20408-5422-C-1  
FCC ID: CINSM-6000

No.	Test equipment	Type	Manufacturer
ETS 0302	Data line CDN	CM-I/O CD	Keytek
ETS 0303	Telecom line CDN	CM-TEL CD	Keytek
ETS 0304	Test receiver	ESHS 10	Rohde & Schwarz
ETS 0305	Test receiver	ESVS 10	Rohde & Schwarz
ETS 0306	Function generator	HP 33120A	Hewlett Packard
ETS 0307	Commu. Sign. Analyzer	CSA 803 A	Tektronix
ETS 0308	Spectrum analyzer	R 3361A	Advantest
ETS 0309	Anechoic chamber	AC 2	Frankonia
ETS 0310	Anechoic chamber	AC 3	Frankonia
ETS 0311	Anechoic chamber	AC 4	Frankonia
ETS 0312	Climatic chamber	VC 0033	Vötsch
ETS 0313	Power sensor	NRV-Z51	Rohde & Schwarz
ETS 0314	LPD antenna	HL 223	Rohde & Schwarz
ETS 0315	Biconical antenna	HK 116	Rohde & Schwarz
ETS 0316	Switcher	Hr 07-720	WISI
ETS 0317	Switcher	Hr 07-720	WISI
ETS 0318	Dial pulse/ DTMF tester	210	HE
ETS 0319	Opto link	GPIB 140	NI
ETS 0320	Opto link	GPIB 140	NI
ETS 0321	RF Millivoltmeter	URV 55	Rohde & Schwarz
ETS 0322	Insertion unit	URV5-Z4	Rohde & Schwarz
ETS 0323	DECT portable part	Gigaset 1000	SIEMENS
ETS 0324	DECT fix part	Gigaset 1000	SIEMENS
ETS 0325	DECT portable part		Philipps
ETS 0326	DECT fix part		Philipps
ETS 0327	Blue Unit	V 2.0	Nokia
ETS 0328	BT Protocol tester	PTW 60	Rohde & Schwarz
ETS 0330	Spectrum analyser	FSM	Rohde & Schwarz
ETS 0333	turn table	DE 350	Heinrich Deisel
ETS 0334	Controller	HD 100	Heinrich Deisel
ETS 0335	BT Development kit	CASIRA	CSR
ETS 0336	LPD Antenna	HL 223	Rohde & Schwarz
ETS 0337	Professional Power Amplifier	SE-1200	Wharfedale Pro
ETS 0338	Coupling network	KN002	ETS
ETS 0339	Isolating Transformer	KN003	ETS
ETS 0340	Thermometer		Proficell



Registration number: W6M20408-5422-C-1  
FCC ID: CINSM-6000

No.	Test equipment	Type	Manufacturer
ETS 0341	Thermometer		Proficell
ETS 0342	Thermometer		Proficell
ETS 0343	Thermometer		Proficell
ETS 0344	Thermometer		Proficell
ETS 0345	Thermometer		Proficell
ETS 0346	Thermometer		Proficell
ETS 0347	Current Probe	EZ-17	R & S
ETS 0348	RF Millivolt meter	URV 55	R & S
ETS 0349	Insertion unit	URV5-Z4	R & S
ETS 0350	Horn Antenna	BBHA 9120-C	Schwarzbeck
ETS 0351	RF amplifier	DWT-1857	Microwave
ETS 0352			
ETS 0353			
ETS 0354	RF amplifier	DBS-0408N423	Microwave
ETS 0355	high pass	H03G12G3	Microwave
ETS 0356	high pass	H03G12G3	Microwave
ETS 0357	high pass	H08G18G3	Microwave
ETS 0358	RF amplifier	AFD3-010040-15-ln	MITEQ
ETS 0359	RF amplifier	M/N AM-1331	MITEQ
ETS 0360	RF amplifier	DBS-0408N423	Microwave
ETS 0361	RF amplifier	DBS 1826N515	Microwave
ETS 0362	high pass	H03G12G3	Microwave
ETS 0363	high pass	H08G18G3	Microwave
ETS 0364	high pass	H08G18G3	Microwave
ETS 0365	Notch filter 2.4 GHz	WRCT2.40/248	Wain Wright
ETS 0366	high pass	H08G18G3	Microwave
ETS 0367	high pass	H03G12G3	Microwave
ETS 0368	Notch filter 0.5-1 GHz	BN86883	Schomandl
ETS 0369	Notch filter 210-500 MHz	BN86882	Schomandl
ETS 0370	Notch filter 15-90 MHz	BN86880	Schomandl
ETS 0371	Notch filter 85-250 MHz	BN86881	Schomandl
ETS 0372	Direction coupler	RK 100	MEB
ETS 0373	Direction coupler	DC3001	emv
ETS 0374	Insertion Unit	URV 5-Z2	R&S
ETS 0375	RCo Network	8 Ohm	Erika Fiedler
ETS 0376	RCo Network	300 Ohm	Erika Fiedler
ETS 0377	RCo Network	10K Ohm	Erika Fiedler
ETS 0378	RCo Network	10K Ohm	Erika Fiedler
ETS 0379	Abschlusswiderstand	150 Ohm	Erika Fiedler
ETS 0380	Abschlusswiderstand	150 Ohm	Erika Fiedler
ETS 0381	RCi Network	100 Ohm	Erika Fiedler
ETS 0382	RCi Network	2.2K Ohm	Erika Fiedler
ETS 0383	RCi Network	1K Ohm	Erika Fiedler

Registration number: W6M20408-5422-C-1

FCC ID: CINSM-6000

No.	Test equipment	Type	Manufacturer
ETS 0384	RCi Network	22K Ohm	Erika Fiedler
ETS 0385	RCi Network	22K Ohm	Erika Fiedler
ETS 0386	Bandpass 0.5-3kHz	nach EN 55020-D.2	
ETS 0387	Tiefpass 15 kHz	nach EN 55020-D.1	
ETS 0388	Tiefpass 15 kHz	nach EN 55020-D.1	
ETS 0389	Bandpass 0.5-3kHz	nach EN 55020-D.2	
ETS 0390	Netz Filter	Mains Filter 'M'	Erika Fiedler
ETS 0391	Bewertungsnetzwerk	nach EN 55020-B.3	
ETS 0392	Matching Network	MN 50-150Ohm	Erika Fiedler
ETS 0393	Matching Network	MN 50-150Ohm	Erika Fiedler
ETS 0394	RCo Network	Loudspeaker Load 8 Ohm	Erika Fiedler
ETS 0395	RCo Network	Loudspeaker Load 8 Ohm	Erika Fiedler
ETS 0396	RCo Network	Loudspeaker Load 8 Ohm	Erika Fiedler
ETS 0397	RCo Network	Phone Load 300 Ohm	Erika Fiedler
ETS 0398	RCo Network	Phone Load 300 Ohm	Erika Fiedler
ETS 0399	RCo Network	Phone Load 300 Ohm	Erika Fiedler
ETS 0400	RCo Network	Audio Adapter	Erika Fiedler
ETS 0401	RCo Network	Audio Adapter	Erika Fiedler
ETS 0402	Coupling Unit	SR (47K Ohm)	Erika Fiedler
ETS 0403	Coupling Unit	SR (47K Ohm)	Erika Fiedler
ETS 0404	Coupling Unit	SR (47K Ohm)	Erika Fiedler
ETS 0405	Coupling Unit	SR (2.2K Ohm)	Erika Fiedler
ETS 0406	Coupling Unit	SR (22K Ohm)	Erika Fiedler
ETS 0407	Coupling Network	"M"	Erika Fiedler
ETS 0408	Coupling Network	"A"	Erika Fiedler
ETS 0409	Coupling Network	"A"	Erika Fiedler
ETS 0410	Coupling Network	"A"	Erika Fiedler
ETS 0411	Coupling Network	"L"	Erika Fiedler
ETS 0412	Coupling Network	"L"	Erika Fiedler
ETS 0413	Coupling Network	"L"	Erika Fiedler
ETS 0414	A/V adapter	Type 2	Erika Fiedler
ETS 0415	A/V adapter	Type 2	Erika Fiedler
ETS 0416	A/V adapter	Type 2	Erika Fiedler
ETS 0417	A/V adapter	Type 3	Erika Fiedler
ETS 0418	A/V adapter	Type 1	Erika Fiedler
ETS 0419	A/V adapter	Type 1	Erika Fiedler
ETS 0420	Verstärker 0.1-1 GHz	M/N AM-1331	MITEC
ETS 0421	Verstärker 1-4 GHz	AFD3-010040-15-LN	MITEC
ETS 0422	Verstärker 4-8 GHz	DBS-0408N423	Narda

Registration number: W6M20408-5422-C-1

FCC ID: CINSM-6000

No.	Test equipment	Type	Manufacturer
ETS 0423	Verstärker 8-18 GHz	DWT-18057	Narda
ETS 0424	Verstärker 18-26.5 GHz	DBS-1826N515	Narda
ETS 0425	T-Network	ESH 3-Z4	R&S
ETS 0426	CDN	T4 HF	MEB
ETS 0427	Power sensor	NRV-Z6	R&S
ETS 0428	4-WIRE ISN mit B1	ENY41	R&S
ETS 0429	Current Probe Test Jig	SW14 7LY	Chase
ETS 0430	RF signal generator	SML02	R&S
ETS 0431	AC Mains Adaptor	BS5733	Travel Emporium
ETS 0432	RF Verstärkermatrix	RSU-ETS-BT	ETS
ETS 0433	RF Verstärkermatrix	RSU-ETS-CTR6	ETS
ETS 0434	Reserviert Tre	RSU-ETS-GSM	
ETS 0435	HP-Filter	H1G04G01	Microwave
ETS 0436	HP-Filter	H1G04G01	Microwave
ETS 0437	HP-Filter	H0G408G1	Microwave
ETS 0438	HP-Filter	H0G408G1	Microwave
ETS 0439	Reserviert Tre		
ETS 0440	Reserviert Tre		
ETS 0441	Bluetooth Protcol Tester	PTW 60	R & S
ETS 0442	Nokia Tester for Bluetooth 1.1	DTL - 1	Nokia
ETS 0443	IBM BT PC Card	BTPCN101	IBM / Motorola
ETS 0444	Sony BT DUN Modem	BTA- NW 1	Sony
ETS 0445	RF-Attenuattor 6dB	50FH-006-300	JFK
ETS 0446	RF-Attenuattor 30dB	50FH-030-300	JFK
ETS 0447	KFZ-Bordnetznachbildung	LN-KFZ/200	R. Heine Hochfrequenztechn.
ETS 0448	RF Power Amplifier	AR 60S1G3	AR Amplifier Resarch
ETS 0449	Stäubli Robot	RX90B L	Stäubli
ETS 0450	Stäubli Robot Controller	CS/MBs&p	Stäubli
ETS 0451	DASY 4 Measurement Server		Schmidt & Partner
ETS 0452	Control Pendant		Stäubli
ETS 0453	Compaq Computer	Pentium IV 2 GHz	Schmidt & Partner
ETS 0454	Dabu Acquisition Electronis	DAE3V1	Schmidt & Partner
ETS 0455	Dummy Probe		Schmidt & Partner
ETS 0456	Dosimetric E-Field Probe	ET3DV6	Schmidt & Partner
ETS 0457	Dosimetric E-Field Probe	ET3DV6	Schmidt & Partner
ETS 0458	Dosimetric H-Field Probe	H3DV6	Schmidt & Partner
ETS 0459	System Validation Kit	D900V2	Schmidt & Partner
ETS 0460	System Validation Kit	D1800V2	Schmidt & Partner
ETS 0461	System Validation Kit	D1900V2	Schmidt & Partner
ETS 0462	System Validation Kit	D2450V2	Schmidt & Partner
ETS 0463	Probe Alignment Unit	LBV2	Schmidt & Partner
ETS 0464	SAM Twin phantom	V4.0	
ETS 0465	Mounting Device	V 3.1	



Registration number: W6M20408-5422-C-1  
FCC ID: CINSM-6000

No.	Test equipment	Type	Manufacturer
ETS 0466	Directional Coupler	HP 87300B	
ETS 0467	Universal Radio Communication T	CMU 200	R & S
ETS 0468			
ETS 0469	Dielectric Probe Kit	85070C	Agilent
ETS 0470	Amplifier	AM-1300-1103	MITEQ

Registration number: W6M20408-5422-C-1  
FCC ID: CINSM-6000

## 2.4 General Test Procedure

**POWER LINE CONDUCTED INTERFERENCE:** The procedure used was ANSI STANDARD C63.4-2000 using a 50 $\mu$ H LISN (if necessary). Both lines were observed. The bandwidth of the spectrum analyzer was 10 kHz with an appropriate sweep speed.

**RADIATION INTERFERENCE:** The test procedure used was according to ANSI STANDARD C63.4-2000 employing a spectrum analyzer. For investigated frequency is equal to or below 1GHz, the RBW and VBW of the spectrum analyzer was 100 kHz and 100kHz respectively with an appropriate sweep speed. For investigated frequency is above 1GHz, both of RBW and VBW of the spectrum analyzer were 1 MHz with an appropriate sweep speed. The analyzer was calibrated in dB above a microvolt at the output of the antenna. The ambient temperature of the UUT was 23°C with a humidity of 40 %.

The table used for radiated measurements is capable of continuous rotation. The spectrum was scanned from 30 MHz to the frequency specified as follows:

- (1) If the intentional radiator operates below 10 GHz: to the tenth harmonic of the highest fundamental frequency or to 40 GHz, whichever is lower.
- (2) If the intentional radiator operates at or above 10 GHz and below 30 GHz: to the fifth harmonic of the highest fundamental frequency or to 100 GHz, whichever is lower.
- (3) If the intentional radiator operates at or above 30 GHz: to the fifth harmonic of the highest fundamental frequency or to 200 GHz, whichever is lower, unless specified otherwise elsewhere in the rules.
- (4) If the intentional radiator contains a digital device, regardless of whether this digital device controls the functions of the intentional radiator or the digital device is used for additional control or function purposes other than to enable the operation of the intentional radiator, the frequency range shall be investigated up to the range specified in paragraphs (a)(1)-(a)(3) of this section or the range applicable to the digital device, as shown in paragraph (b)(1) of this Section, whichever is the higher frequency range of investigation.

For hand-held devices, a exploratory test was performed with three (3) orthogonal planes to determine the highest emissions.

Measurements were made by ETS Dr. Genz GmbH, Germany at the registered open field test site located at Storkower Str. 38c, 15526 Reichenwalde Germany. The Registration Number: 96970. When an emission was found, the table was rotated to produce the maximum signal strength. At this point, the antenna was raised and lowered from 1m to 4m. The antenna was placed in both the horizontal and vertical planes.

**ANTENNA & GROUND:**

**This unit uses 1/4 wire antenna (see photo).**

Registration number: W6M20408-5422-C-1  
FCC ID: CINSM-6000

### 3 Test results (enclosure)

TEST CASE		Required	Test passed	Test failed
RF Power Output	2.1046 (a); 74.861 (e)(1)	<input checked="" type="checkbox"/>	<input checked="" type="checkbox"/>	<input type="checkbox"/>
Modulation Deviation	2.1047 (b); 74.861 (e)(2)	<input checked="" type="checkbox"/>	<input checked="" type="checkbox"/>	<input type="checkbox"/>
Audio Frequency Response	2.1047 (a)	<input checked="" type="checkbox"/>	<input checked="" type="checkbox"/>	<input type="checkbox"/>
Occupied Bandwidth / Emission Mask	2.1049 (c)(1); 74.861 (e)(5)	<input checked="" type="checkbox"/>	<input checked="" type="checkbox"/>	<input type="checkbox"/>
Spurious Emissions at Antenna Terminals	2.1051 74.861(e)(6)	<input checked="" type="checkbox"/>	<input checked="" type="checkbox"/>	<input type="checkbox"/>
Radiated Spurious Emission	2.1053 74.861(e)(6)	<input checked="" type="checkbox"/>	<input checked="" type="checkbox"/>	<input type="checkbox"/>
Line Conducted Emissions	15.207	<input type="checkbox"/>	<input type="checkbox"/>	<input type="checkbox"/>
Frequency Stability vs. Temperature	2.1055 (b); 74.861(e)(4)	<input checked="" type="checkbox"/>	<input checked="" type="checkbox"/>	<input type="checkbox"/>
Frequency Stability vs. Voltage	2.1055 (a)(1); 74.861 (e)(4)	<input checked="" type="checkbox"/>	<input checked="" type="checkbox"/>	<input type="checkbox"/>

The follows is intended to leave blank.

Registration number: W6M20408-5422-C-1  
FCC ID: CINSM-6000

#### 4 RF Power Output (conducted) , FCC 2.1046 (a) ; 74.861 (e)

##### 4.1 Test procedure

This transmitter output was connected to a calibrated coaxial attenuator, the other end of which was connected to a spectrum analyzer. Transmitter output was derived with the spectrum analyzer in dBm.

The power output at the transmitter antenna port was determined by assign the value of the attenuator to the spectrum analyzer reading.

An HP power meter was also used to measure the RF power.

Tests were performed with an unmodulated carrier at three frequencies (low , middle and high channels ) and on all power levels , which can be set-up on the transmitters.

##### 4.2 Test Results

Frequency Channel	Peak Output Power ( dBm )
615 MHz	-0.36
710 MHz	2.19
805.795 MHz	-0.12

Limits:

LPAS operating in TV bands	
Frequency [MHz]	Conducted output power [ mW ]
54 – 72 76 – 88 174 - 216	50 (17 dBm)
470 – 608 614 - 806	250 (24 dBm)

LPAS operating in other than TV bands	
Conducted power [W]	
	1

Comment : see attached diagrams.

Registration number: W6M20408-5422-C-1  
FCC ID: CINSM-6000

## 5 Radiated Power

### 5.1 Test Procedure

The EUT was positioned on a non-conductive turntable, 0.8m above the ground on an open test site.

The radiated emission at the fundamental frequency was measured at 3m distance with a test antenna and spectrum analyzer.

Worst case emission was recorded with the rotation of the turntable and the raising and lowering of the test antenna.

#### Substitution RF power Measurement at ETS Dr. Genz GmbH

General :

The applied substitution method follows ANSI/TIA/EIA-603, ANSI/TIA/EIA-102.CAAA or the appropriate ETSI rules respectively.

The actual signal generated by the EUT can be determined by means of a substitution measurement in which a known signal source replaces the device to be measured.

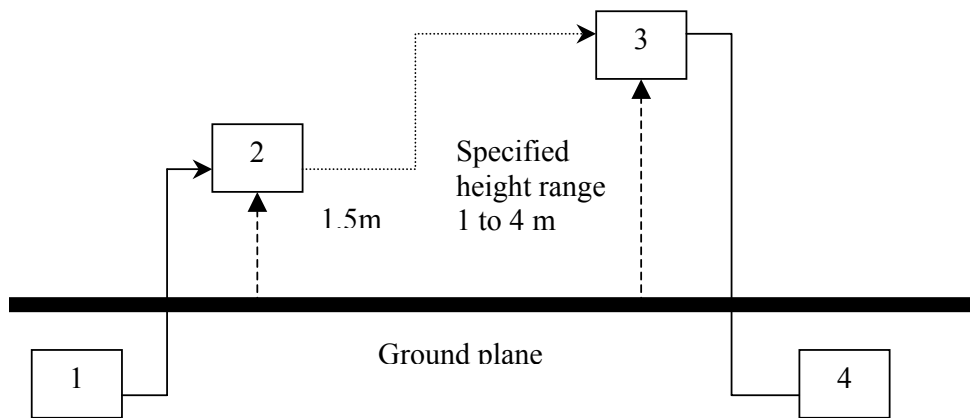

- 1) Signal generator ;
- 2) Substitution antenna ;
- 3) Test antenna ;
- 4) Spectrum analyzer or selective voltmeter.

The substitution antenna replaces the transmitter antenna at the same position and in vertical polarization. The frequency of the signal generator shall be adjusted to the measurement frequency.

The test antenna shall be raised or lowered, if necessary, to ensure that the maximum signal is still received. The input signal to the substitution antenna shall be adjusted in level until an equal or a known related level to that detected from the transmitter is obtained in the measurement receiver.

If a fully anechoic chamber is used as test site in order to provide free space conditions there is no need to change the height of the antenna.



Registration number: W6M20408-5422-C-1  
FCC ID: CINSM-6000

The measurement will be repeated in horizontal position.

**Calibration :**

In order to make this kind of measurement more effective and to avoid subjective measurement faults ETS has installed automatic computer controlled measurement procedures.

With the above described substitution method a test site is calibrated over the full frequency range which is used in suitable frequency steps. For a certain power level on the substitution antenna the received power over the whole frequency range is documented. All necessary antenna gains, cable losses, filter losses and amplifications of preamplifiers are taken in consideration. The summary of this calibration measurement performs a transducer factor that is related to the considered test site and a certain measurement distance. Differences of the radiated power levels of different test samples are determined by internal attenuation of measurement receiver . The proper function of such test site will be maintained by short term plausibility checks and periodical re-calibration.

**Testing :**

Now the test sample will be putted on the table at the defined position and the radiated power will be receiver and documented by the measurement receiver.

On test sites with ground plane the measurement antenna will be lowered and raised to maximum values at significant frequencies.

For peak power measurements the sample is turned by the turntable over 360 degree in order to find the direction with the maximum radiation or to document the max reading with the MAXHOLD function during the rotation.

## 5.2 Test results

Radiated Power ( dBm )	
Channel A	1.59
Channel B	4.91
Channel C	1.36

Comment : see attached diagrams.

Registration number: W6M20408-5422-C-1  
FCC ID: CINSM-6000

## 6 Modulation Deviation , FCC 2.1047 (b) ; 74.861(e)

### 6.1 Test procedure

Modulation limiting is the transmitter circuit's ability to limit the transmitter from producing deviations in excess of rated system deviation.

The audio signal generator is connected to the audio input of the EUT with its full rating.

The modulation response is measured at certain modulation frequencies, related to 1000Hz reference signal. Tests are performed for positive and negative modulation.

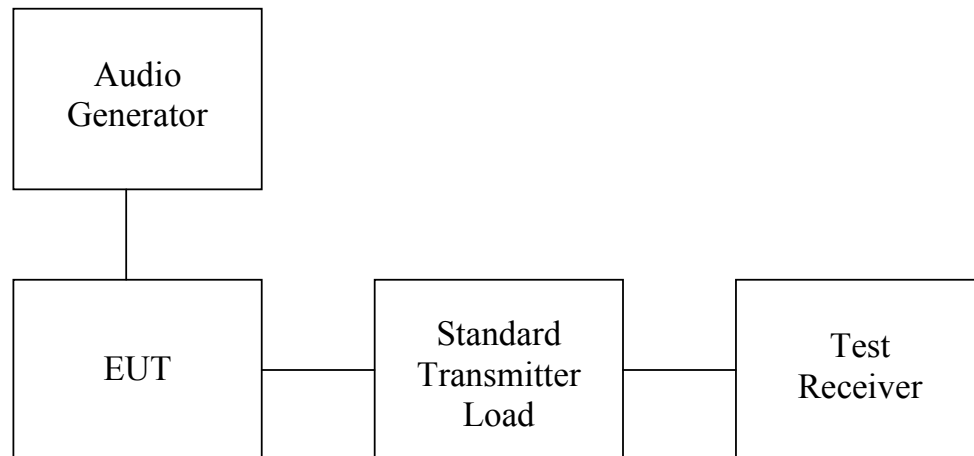

### 6.2 Test results

Limits :  $\pm 75$  kHz

Comment : see attached diagrams.

Registration number: W6M20408-5422-C-1  
FCC ID: CINSM-6000

## 7 Audio frequency response , FCC 2.1047 (a)

### 7.1 Test procedure

The audio frequency response is the degree of closeness to which the frequency deviation of the transmitter follows a prescribed characteristic.

The frequency response of the audio modulation part is measured over a frequency range of 100 Hz to 5000Hz.

For 1000Hz tone reference signal the audio generator level is adjusted to get 20% of the rated system deviation.

The deviations obtained over the frequency range from 100Hz to 5000Hz are recorded and compared with the reference deviation as follows :

$$\text{Audio Frequency Response} = 20 \log [ \text{DEV}_{\text{Freq}} / \text{DEV}_{\text{ref}} ].$$

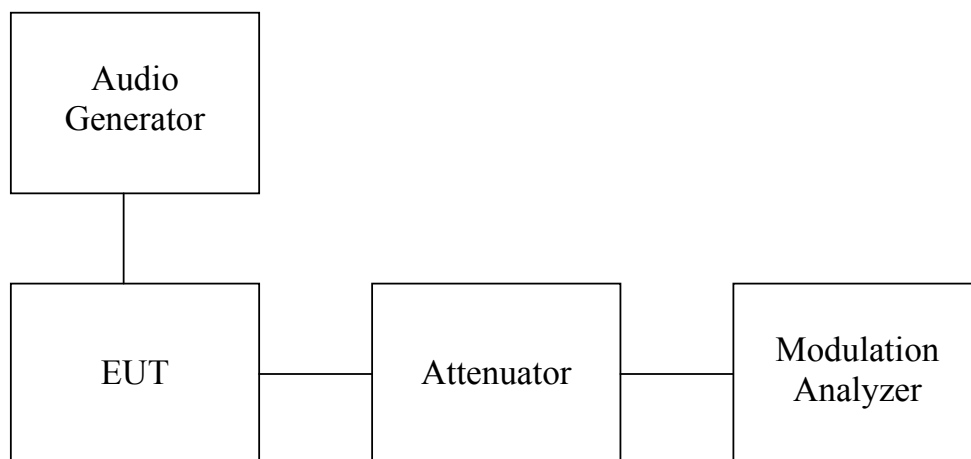

### 7.2 Test results

Comment : see attached diagrams.

Registration number: W6M20408-5422-C-1  
FCC ID: CINSM-6000

## 8 Occupied Bandwidth/Emission Mask, FCC 2.1049 (c) ; 74.861 (e)(5)

The occupied bandwidth, that is the frequency bandwidth such that, below its lower and above its upper frequency limits, the mean powers radiated are each equal to 0.5 percent of the total mean power.

Near the carrier an Emission Mask is defined by the standard.

### 8.1 Test procedure

The RF output of the transceiver was connected to the input of the spectrum analyzer through sufficient attenuation.

Occupied Bandwidth was measured with a occupied bandwidth function of the analyzer.

The near the carrier emissions are measured by normal power measurement function of the analyzer.

### 8.2 Test Results

#### 1000 Hz Modulation

Occupied Channel Bandwidth ( kHz )	
Channel A	58.61723447
Channel B	59.11823647
Channel C	61.12224449

#### 2500 Hz Modulation

Occupied Channel Bandwidth ( kHz )	
Channel A	63.12625251
Channel B	53.60721443
Channel C	55.61122244

Comment : see attached diagram in appendix.

For near the carrier emissions see attached diagrams.

Registration number: W6M20408-5422-C-1  
FCC ID: CINSM-6000

## 9 Spurious Emissions at Antenna Terminals FCC2.1051 ; 74.861 (e)

### 9.1 Test procedure

This transmitter output was connected to a calibrated coaxial attenuator, the other end of which was connected to a spectrum analyzer. Transmitter output was derived with the spectrum analyzer in dBm.

The Spurious Emissions at Antenna Terminals was measured by the spectrum analyzer with a suitable notch filter and high-pass filter.

Tests were performed with an unmodulated carrier at three frequencies (low , middle and high channels ) and on all power levels , which can be set-up on the transmitters.

### 9.2 Test Results

#### Summary table with conducted data of the test plots for Carrier Test Frequency 615 MHz

Frequency Marker Indication [MHz]	Indication Power Level [dBm]	Compliance Limit [dBm]	Margin
615.23046092	9.11	Carrier	
141.40280561	-65.09	-13	52.09
1841.68337	-41.70	-13	28.70
4304.60922	-54.22	-13	41.22
11839.67936	-62.44	-13	49.44

#### Summary table with conducted data of the test plots for Carrier Test Frequency 710 MHz

Frequency Marker Indication [MHz]	Indication Power Level [dBm]	Compliance Limit [dBm]	Margin
709.81963928	0.15	Carrier	
148.21643287	-65.54	-13	52.54
2130.26052	-45.82	-13	32.82
4256.51303	-47.87	-13	34.87
8633.26653	-61.95	-13	48.95

Registration number: W6M20408-5422-C-1  
FCC ID: CINSM-6000

**Summary table with conducted data of the test plots for Carrier Test Frequency 805.795 MHz**

Frequency Marker Indication [MHz]	Indication Power Level [dBm]	Compliance Limit [dBm]	Margin
806.01202405	4.10	Carrier	
145.83166333	-64.75	-13	51.75
1607.21443	-38.20	-13	25.20
4024.04810	-71.61	-13	58.61
11887.77555	-72.60	-13	59.60

## 9.2 Limit

Compliance with § 74.861 requires that any emission be attenuated below the transmitter power at least  $43 + 10 \log_{10} P$  ( P = transmitter power in Watts ).

The compliance limit was calculated as an example per the following table :

Maximum transmitter output power	2.19 dBm
Required attenuation	$43 + 10 \log_{10} 0.00165577W = 15.19 \text{ dB}$
Maximum transmitter output power	2.19 dBm
<u>Required attenuation</u>	<u>15.19 dB</u>
Compliance limit	-13 dBm

Comment : see attached diagrams in appendix.

Registration number: W6M20408-5422-C-1  
FCC ID: CINSM-6000

## 10 Radiated Spurious Emission , FCC 2.1053 ; 74.861 (e)

### 10.1 Test procedure

The EUT was positioned on a non-conductive turntable , 0.8m above the ground plane.

The radiated emission at the fundamental frequency was measured at 3 m distance with a test antenna and spectrum analyzer.

Worst case emission was recorded with the rotation of the turntable and the raising and lowering of the test antenna.

ERP was measured using a substitution method. The EUT was replaced by reference antenna connected to a signal generator.

The test of spurious radiated emission have been carried out with the ESK-Software from Rode & Schwarz. The measurements below 1GHz were performed with a measurement bandwidth of 100kHz, above 1GHz with a bandwidth of 1 MHz.

Spurious emission limits near the carrier are defined by a emission mask. This measurements are done in conducted mode.

### 10.2 Test Results

The measurements of the spurious emission at the upper , center and lower channel.

The measurement diagrams show that all significant spurs are well below the limit line.

**Summary table with radiated data of the test plots for Carrier Test Frequency  
615 MHz**

Spectral Plot	Frequency Marker Indication [MHz]	Indication Power Level [dBm]	External Attn. [dB]	Worst Case Emission Level [dBm]	Compliance Limit [dBm]	Margin
vertical	90.230	-54.12		-54.12	-13	41.12
horizontal	56.914	-57.42		-57.42	-13	44.42
vertical	615.230	-57.15		-57.15	-13	44.15
horizontal	615.230	-47.97		-47.97	-13	34.97
vertical	1228	-32.69		-32.69	-13	19.69
horizontal	1842	-24.45		-24.45	-13	11.45
vertical	4305	-36.62		-36.62	-13	23.62
horizontal	7383	-32.20		-32.20	-13	19.20
vertical	12228	-34.31		-34.31	-13	21.31
horizontal	12098	-34.84		-34.84	-13	21.84

Registration number: W6M20408-5422-C-1  
FCC ID: CINSM-6000

**Summary table with radiated data of the test plots for Carrier Test Frequency  
710 MHz**

Spectral Plot	Frequency Marker Indication [MHz]	Indication Power Level [dBm]	External Attn. [dB]	Worst Case Emission Level [dBm]	Compliance Limit [dBm]	Margin
vertical	94.088	-53.44		-53.44	-13	40.44
horizontal	196.844	-57.30		-57.30	-13	44.30
vertical	709.820	-52.88		-52.88	-13	39.88
horizontal	709.820	-50.19		-50.19	-13	37.19
vertical	3549	-29.15		-29.15	-13	16.15
horizontal	3549	-24.48		-24.48	-13	11.48
vertical	4257	-32.09		-32.09	-13	19.09
horizontal	4257	-28.25		-28.25	-13	15.25
vertical	8511	-33.27		-33.27	-13	20.27
horizontal	8521	-34.41		-34.41	-13	21.41

**Summary table with radiated data of the test plots for Carrier Test Frequency  
805.795 MHz**

Spectral Plot	Frequency Marker Indication [MHz]	Indication Power Level [dBm]	External Attn. [dB]	Worst Case Emission Level [dBm]	Compliance Limit [dBm]	Margin
vertical	94.088	-53.76		-53.76	-13	40.76
horizontal	199.649	-56.80		-56.80	-13	43.80
vertical	810.8221	-53.62		-53.62	-13	43.62
horizontal	810.8221	-48.04		-48.04	-13	35.04
vertical	3555	-49.73		-49.73	-13	36.73
horizontal	1607	-45.11		-45.11	-13	32.11
vertical	7511	-43.18		-43.18	-13	30.18
horizontal	7511	-42.43		-42.43	-13	29.43
vertical	12188	-34.62		-34.62	-13	21.62
horizontal	12980	-35.39		-35.39	-13	22.39



Registration number: W6M20408-5422-C-1  
FCC ID: CINSM-6000

### 10.3 Explanation of test result

The measurements of the spurious emissions at the equipment output terminals were performed pursuant to the test procedure above in order to verify that any emissions are below the limits given by § 74.861 (6).

Calculation of test results :

Such factors like antenna correction , cable loss , external attenuation etc. are already included in the provided measurement results. This is done by using validated test software and calibrated test system according the accreditation requirements.

In the Table being listed the critical peak and average value an exhibit the compliance with the above calculated Limits.

### 10.4 Limits

Compliance with § 74.861 requires that any emission be attenuated below the transmitter power at least  $43 + 10 \log_{10} P$  ( P = transmitter power in Watts ).

The compliance limit was calculated as an example per the following table :

Maximum transmitter output power	4.91 dBm
Required attenuation	$43 + 10 \log_{10} 0.00309742 \text{ W} = 17.91 \text{ dB}$
Maximum transmitter output power	4.91 dBm
<u>Required attenuation</u>	<u>17.91 dB</u>
Compliance limit	-13 dBm

Comment : see attached diagrams in appendix.

Registration number: W6M20408-5422-C-1  
FCC ID: CINSM-6000

## 11 Line Conducted Emission , FCC 15.207

### 11.1 Test procedure

For an intentional radiator which is designed to be connected to the public utility (AC) power line, the radio frequency voltage that is conducted back onto the AC line on any frequency or frequencies within the band 150 kHz to 30 MHz shall not exceed the limits in the table bellows with this provision shall be based on the measurement of the radio frequency voltage between each power line and ground at the power terminals.

This measurement was transact first with instrumentation using an average and peak detector and a 10 kHz bandwidth. If the peak detector achieves a calculated level, the measurement is repeated by an instrumentation using a quasi-peak detector.

### 11.2 Test Results

Frequency	Max. Level (dB $\mu$ V)	
	quasi-peak	average
-- kHz	--	--

#### Limits:

Frequency of Emission (MHz)	Conducted Limit (dB $\mu$ V)	
	Quasi Peak	Average
0.15-0.5	66 to 56	56 to 46
0.5-5	56	46
5-30	60	50

Comment : The is not required the sample is battery used.

Registration number: W6M20408-5422-C-1  
FCC ID: CINSM-6000

## 12 Frequency Stability vs. Temperature , FCC 2.1055 , 74.861 (e)

### 12.1 Test procedure

The equipment under test was connected to an external DC power supply and the RF output was connected to a frequency counter via feed through attenuators. The EUT was placed inside the temperature chamber. The DC leads and RF output cable, exited the chamber through an opening made for that purpose.

After the temperature stabilized the frequency output was recorded from the counter.

### 12.2 Test Results

#### 615 MHz

°C	Frequency Error (kHz)	Frequency Error (ppm)
-30	-8.4	0.001366
-20	-7.8	0.001268
-10	-4.1	0.000667
0	-2.6	0.000423
10	-1.68	0.000273
20	-2.23	0.000363
30	-0.9	0.000146
40	-1.2	0.000195
50	-2.6	0.000423

#### 710 MHz

°C	Frequency Error (kHz)	Frequency Error (ppm)
-30	-11.5	0.001620
-20	-8.41	0.001185
-10	-4.5	0.000634
0	-2.91	0.000410
10	-1.82	0.000256
20	-2.84	0.000400
30	-3.1	0.000437
40	-2.6	0.000366
50	-3.6	0.000507

Registration number: W6M20408-5422-C-1  
FCC ID: CINSM-6000

**805.795 MHz**

°C	Frequency Error (kHz)	Frequency Error (ppm)
-30	-13.66	0.001695
-20	-9.31	0.001155
-10	-4.79	0.000594
0	-2.36	0.000293
10	-1.97	0.000244
20	-2.19	0.000272
30	-3.26	0.000405
40	-2.93	0.000364
50	-4.22	0.000524

Limit :  $\pm 0.005\%$

Registration number: W6M20408-5422-C-1  
FCC ID: CINSM-6000

### 13 Frequency Stability vs. Voltage , FCC 2.1055 (d) ; 74.861 (e)

#### 13.1 Test procedure

An external variable DC power supply was connected to the battery terminals of the equipment under test.

For hand carried , battery powered equipment primary supply voltage was reduced to the battery operating end point as specified by the manufacturer. The output frequency was recorded for each battery voltage.

#### 13.2 Test Results

Frequency in MHz	Frequency Error (kHz)	Frequency Error (ppm)
615	-3.48	-0.000566
710	-2.18	-0.000307
805.795	-2.35	-0.000292

Limit :  $\pm 0.005\%$

Registration number: W6M20408-5422-C-1  
FCC ID: CINSM-6000

## Appendix

- A RF Power Output
- B Audio frequency response
- C Occupied Bandwidth / Emission Mask
- D Spurious Emissions at Antenna Terminals
- E Radiation Spurious Emission
- F Line Conducted Emissions
- G Frequency Stability vs. Temperature
- H Frequency Stability vs. Voltage
- I Pictures

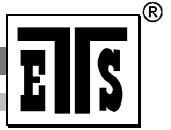

Registration number: W6M20408-5422-C-1  
FCC ID: CINSM-6000

## **Appendix A**

### RF Power Output

**Transmitter carrier power under normal conditions**

**in according to FCC Part 74.861**

EUT: Wireless Microphone Transmitter  
MODEL NO.: SM-6000 Low Channel  
Approval Holder: CHLAYO ELECTRONICS CO., LTD.  
Test Site / Operator: ETS / Sander Huang  
Temperature/Voltage: Temp.: 23°C/ Unom.: 3VDC (1.5 VDC x 2 battery)  
Test Specification: 74.861  
Comment 1: Dist.: 3m, Ant.: HL 223  
Freq:614.998MHz Pmax:1.16dBm RBW: 100 kHz

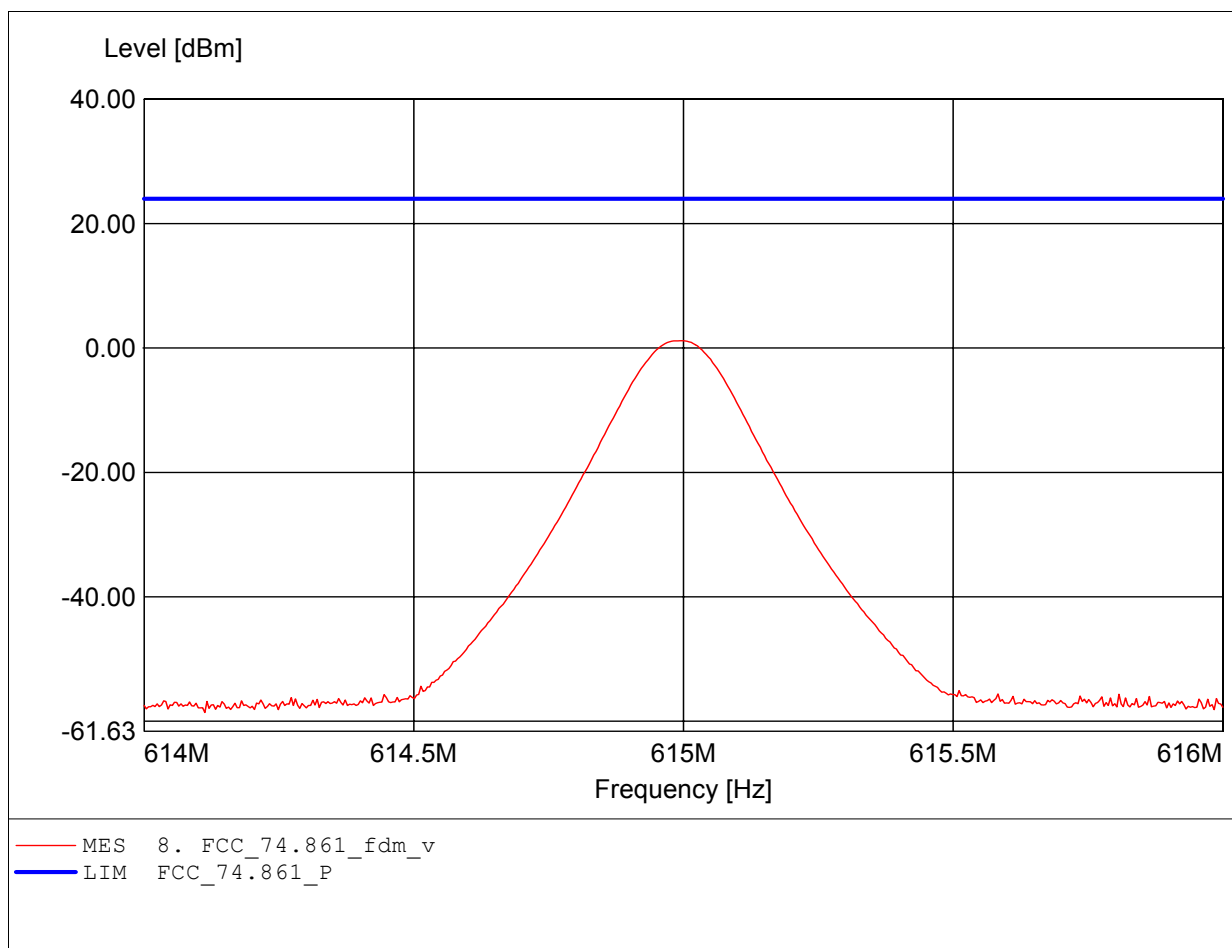



**Transmitter carrier power under normal conditions**

**in according to FCC Part 74.861**

EUT: Wireless Microphone Transmitter  
MODEL NO.: SM-6000 Low Channel  
Approval Holder: CHIAYO ELECTRONICS.,LTD.  
Test Site / Operator: ETS / Sander Huang  
Temperature/Voltage: Temp.: 23°C/ Unom.: 3VDC (1.5VDC x 2 battery)  
Test Specification: 74.861  
Comment 1: Dist.: 3m, Ant.: HL 223  
Freq:614.994MHz Pmax:1.59dBm RBW: 100 kHz

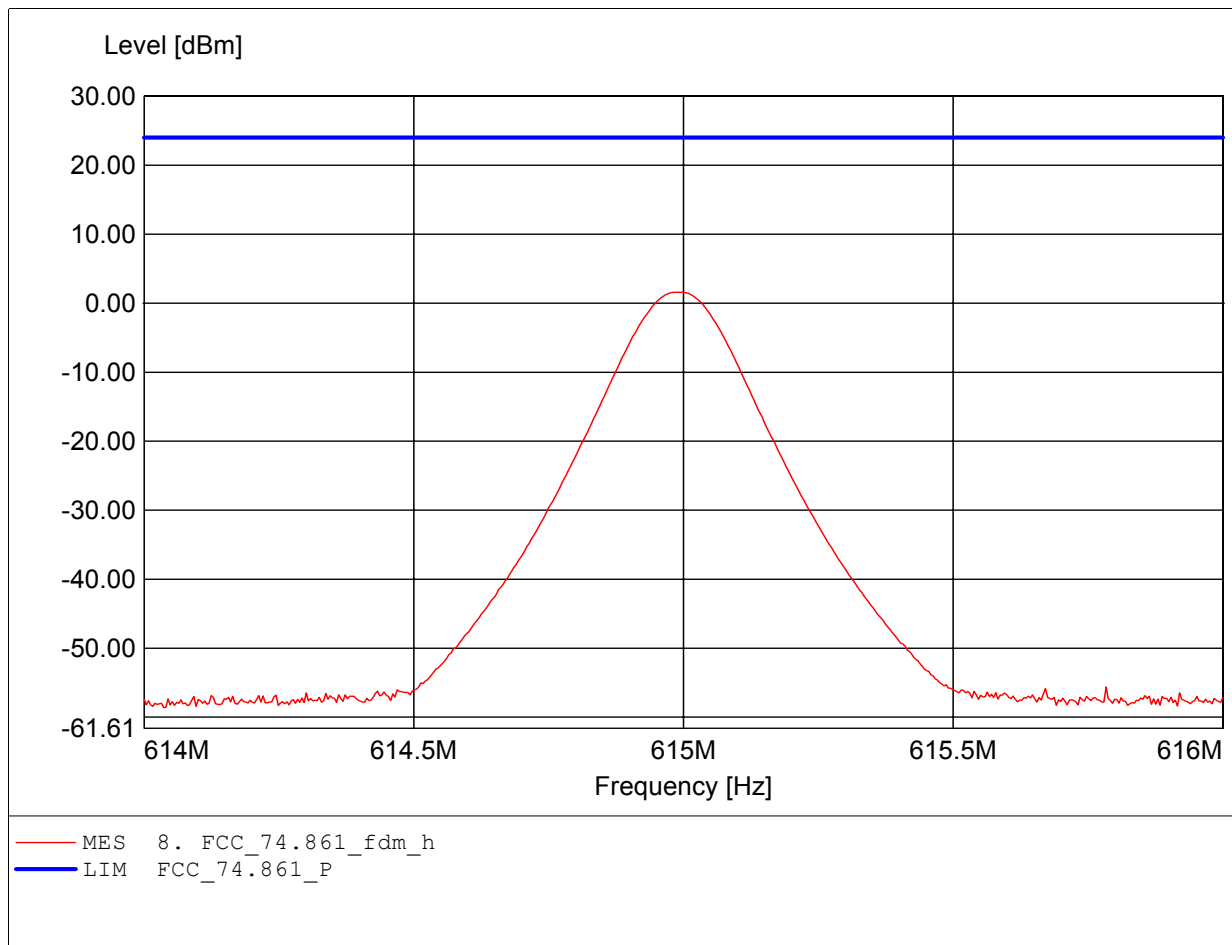

**Transmitter carrier power under normal conditions**

**in according to FCC Part 74.861**

EUT: Wireless Microphone Transmitter  
MODEL NO.: SM-6000 Middle Channel  
Approval Holder: CHIAYO ELECTRONICS.,LTD.  
Test Site / Operator: ETS / Sander Huang  
Temperature/Voltage: Temp.: 23°C/ Unom.: 3VDC (1.5VDC x 2 battery)  
Test Specification: 74.861  
Comment 1: Dist.: 3m, Ant.: HL 223  
Freq:709.994MHz Pmax:4.60dBm RBW: 100 kHz

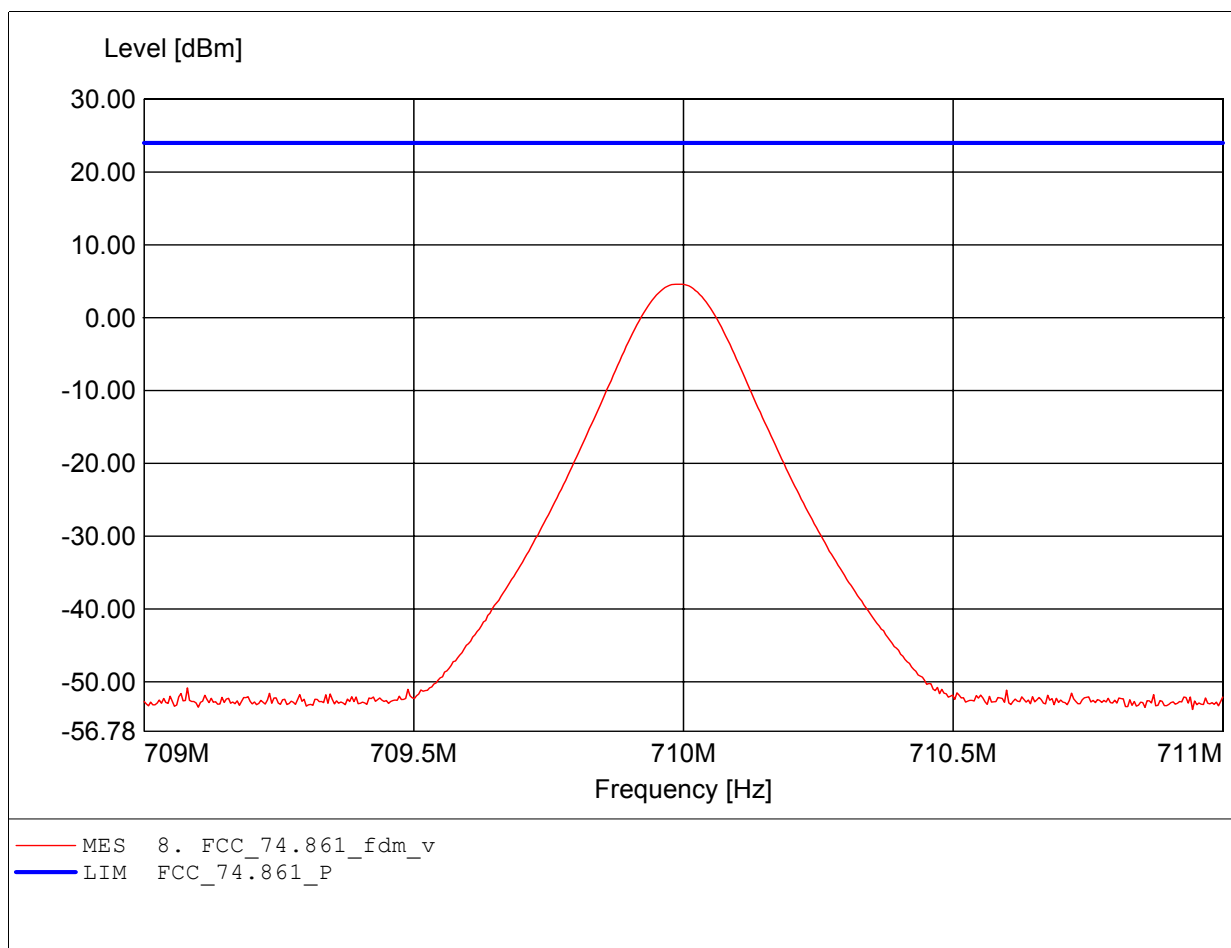

**Transmitter carrier power under normal conditions**

**in according to FCC Part 74.861**

EUT: Wireless Microphone Transmitter  
MODEL NO.: SM-6000 Middle Channel  
Approval Holder: CHIAYO ELECTRONICS.,LTD.  
Test Site / Operator: ETS / Sander Huang  
Temperature/Voltage: Temp.: 23°C/ Unom.: 3VDC (1.5VDC x 2 battery)  
Test Specification: 74.861  
Comment 1: Dist.: 3m, Ant.: HL 223  
Freq:709.986MHz Pmax:4.91dBm RBW: 100 kHz

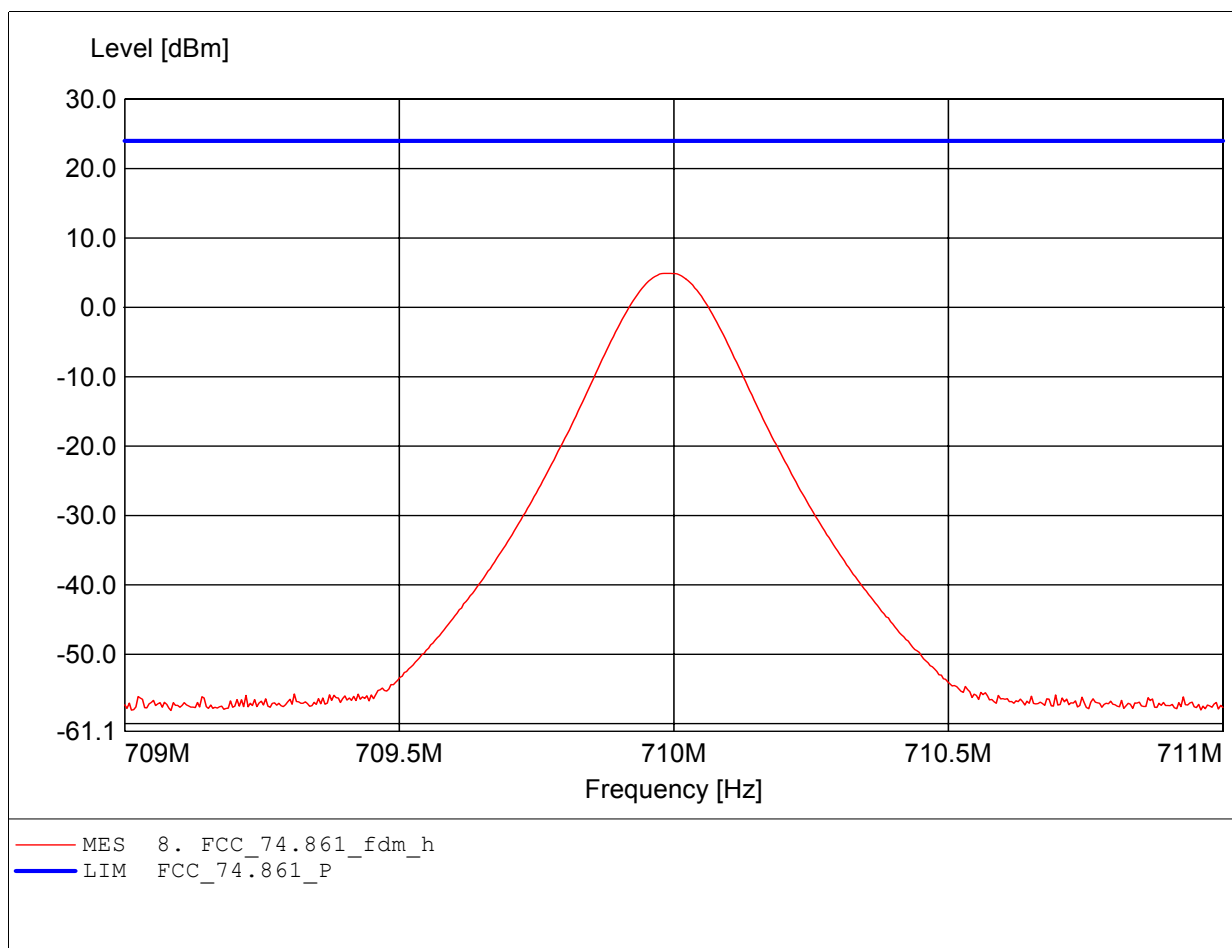

**Transmitter carrier power under normal conditions**

**in according to FCC Part 74.861**

EUT: Wireless Microphone Transmitter  
MODEL NO.: SM-6000 High Channel  
Approval Holder: CHIAYO ELECTRONICS.,LTD.  
Test Site / Operator: ETS / Sander Huang  
Temperature/Voltage: Temp.: 23°C/ Unom.: 3VDC (1.5VDC x 2 battery)  
Test Specification: 74.861  
Comment 1: Dist.: 3m, Ant.: HL 223  
Freq:805.738MHz Pmax:1.36dBm RBW: 100 kHz

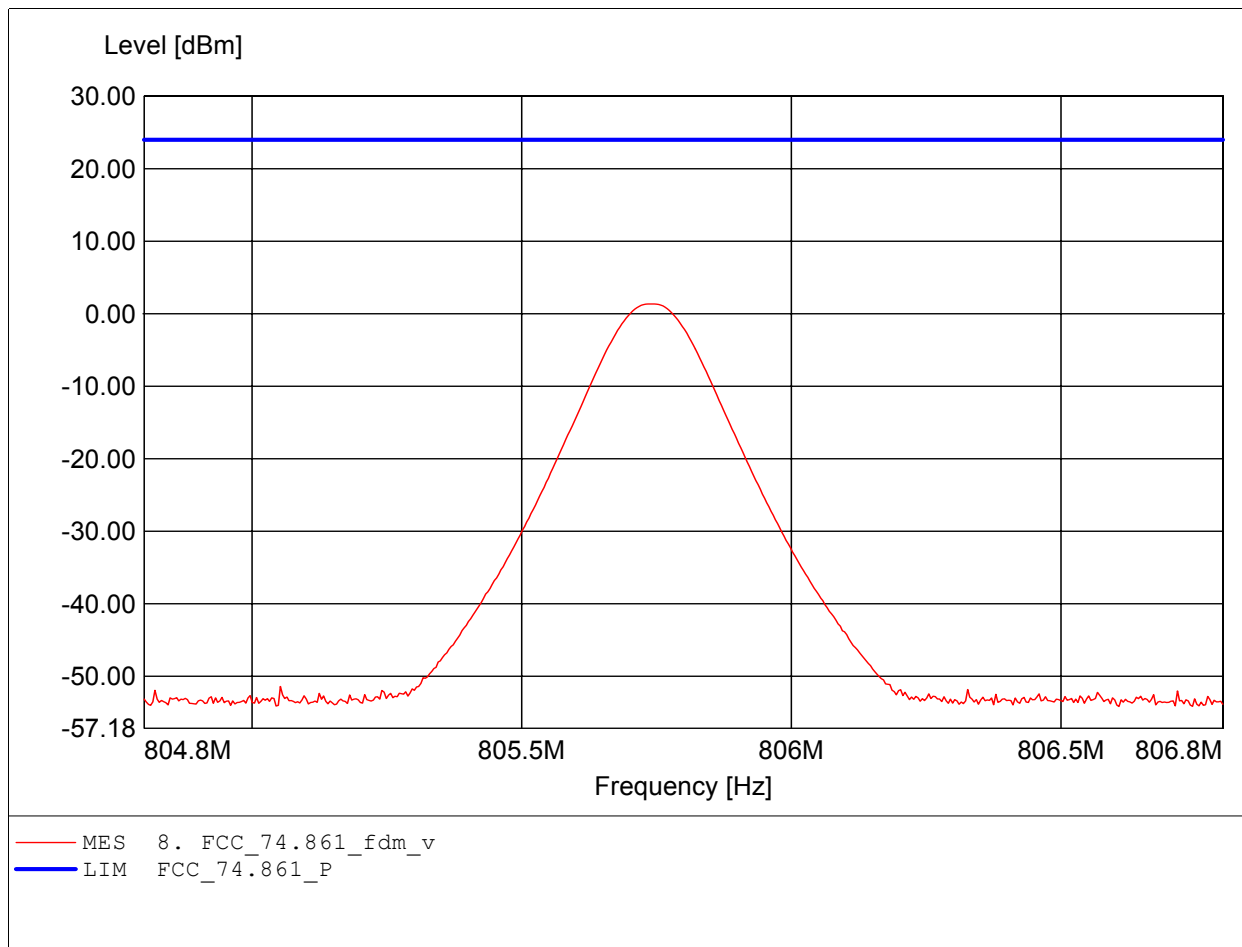

**Transmitter carrier power under normal conditions**

**in according to FCC Part 74.861**

EUT: Wireless Microphone Transmitter  
MODEL NO.: SM-6000 High Channel  
Approval Holder: CHIAYO ELECTRONICS.,LTD.  
Test Site / Operator: ETS / Sander Huang  
Temperature/Voltage: Temp.: 23°C/ Unom.: 3VDC (1.5VDC x 2 battery)  
Test Specification: 74.861  
Comment 1: Dist.: 3m, Ant.: HL 223  
Freq:805.738MHz Pmax:0.90dBm RBW: 100 kHz

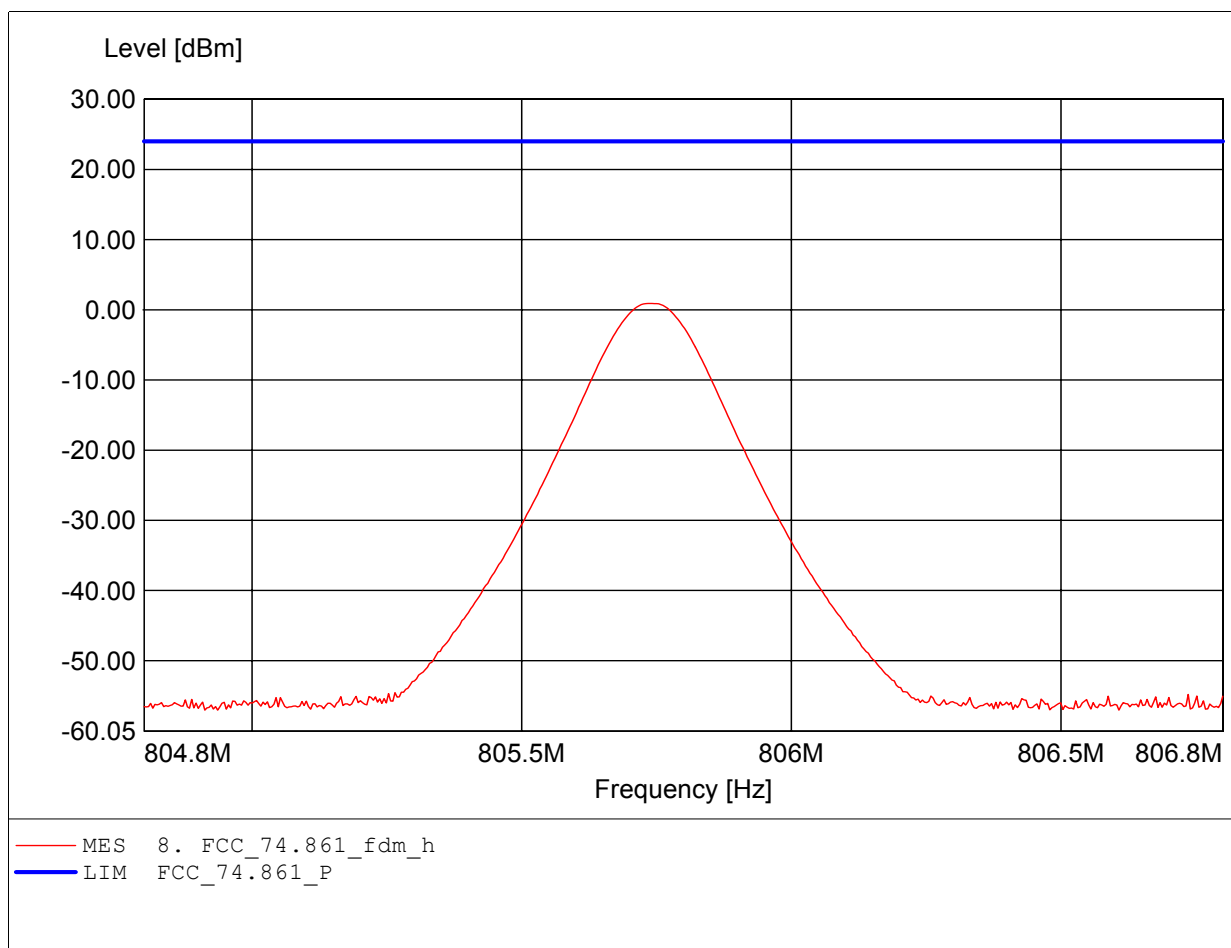



Marker 1 [T1]

RBW 100 kHz RF Att 30 dB

Ref Lvl -0.36 dBm

VBW 100 kHz

10 dBm 615.00200401 MHz

SWT 1 s Unit dBm

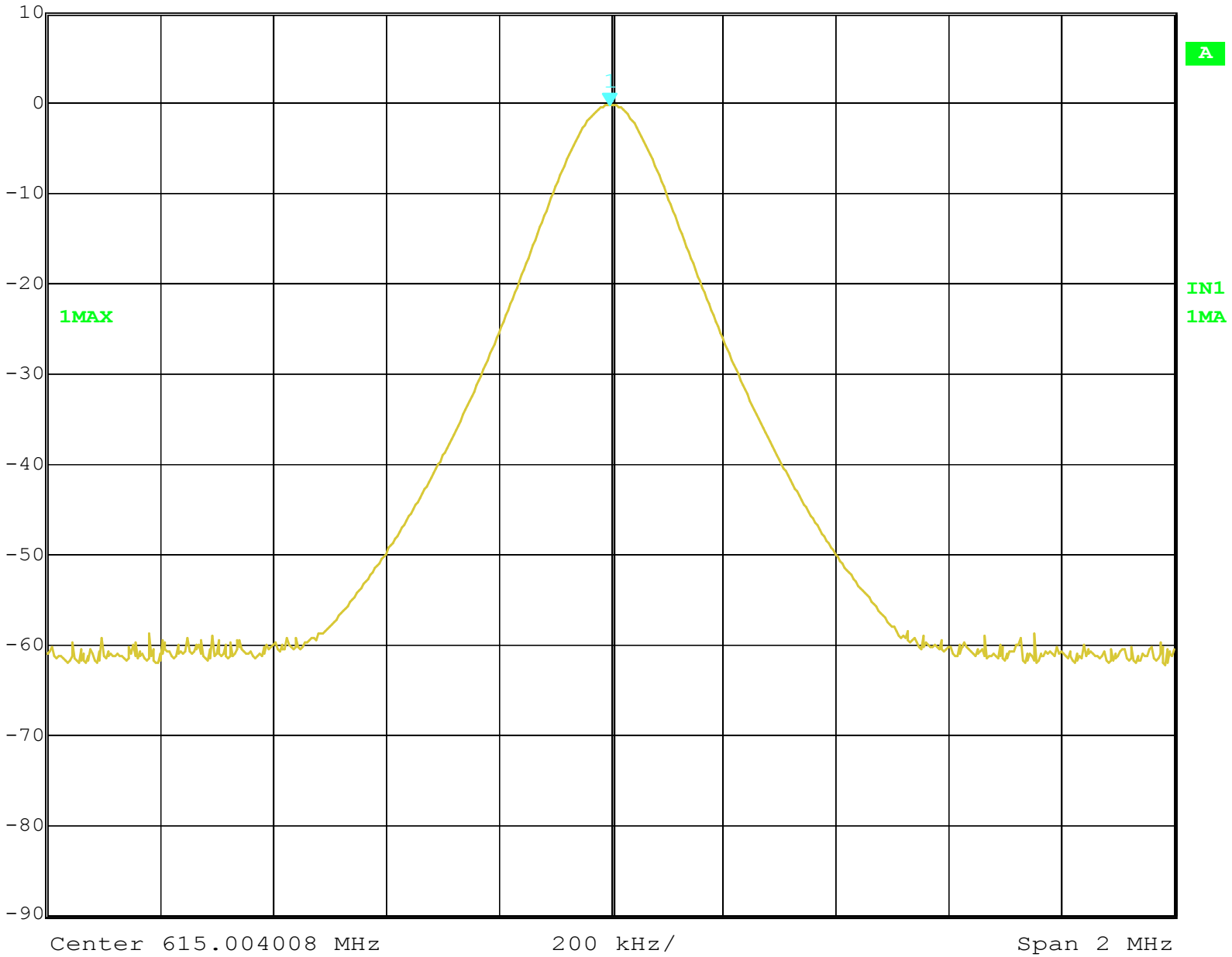

Title: MAX PEAK POWER

Date: 29.AUG.2004 17:12:58



Marker 1 [T1]

RBW 100 kHz RF Att 30 dB

Ref Lvl 2.19 dBm

VBW 100 kHz

10 dBm 710.00200401 MHz

SWT 1 s Unit dBm

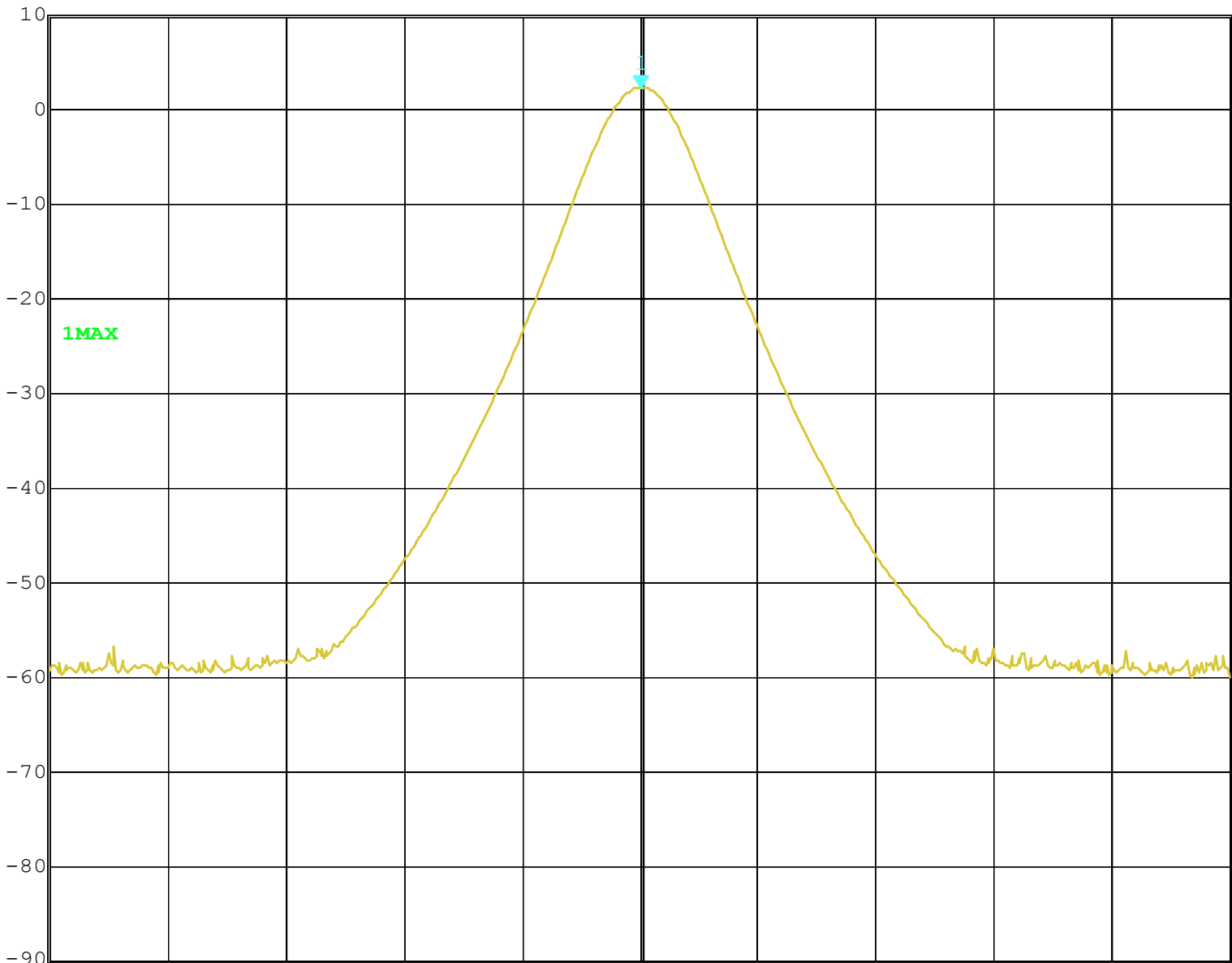

Center 710 MHz

200 kHz/

Span 2 MHz

Title: MAX PEAK POWER

Date: 29.AUG.2004 17:09:06



Marker 1 [T1]

RBW 100 kHz RF Att 30 dB

Ref Lvl -0.12 dBm

VBW 100 kHz

10 dBm 805.79599198 MHz

SWT 1 s Unit dBm

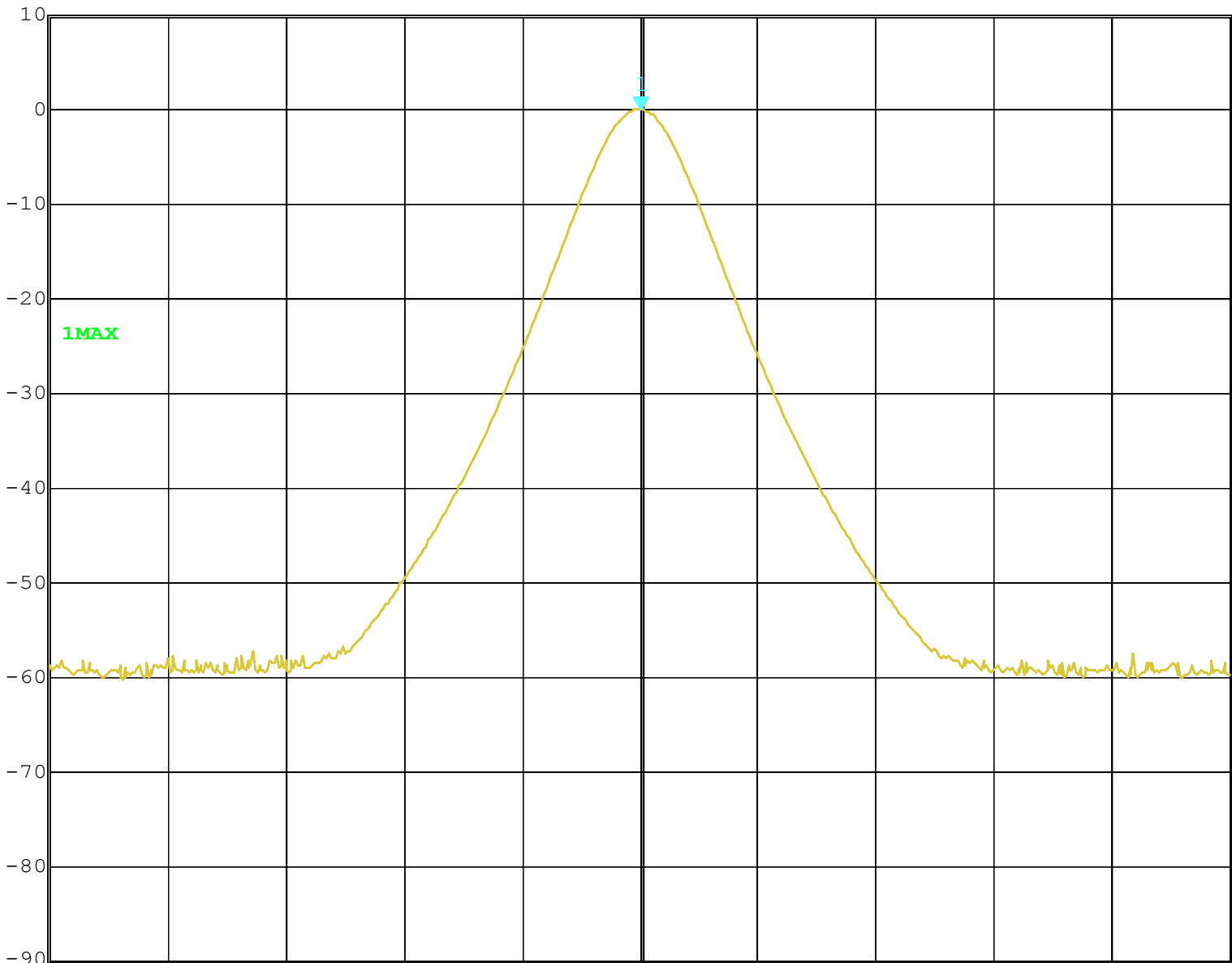

Center 805.795992 MHz

200 kHz/

Span 2 MHz

Title: MAX PEAK POWER

Date: 29.AUG.2004 17:15:06



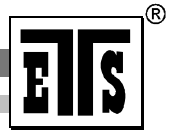

Registration number: W6M20408-5422-C-1  
FCC ID: CINSM-6000

## **Appendix B**

Audio frequency response

Registration number: W6M20408-5422-C-1  
 FCC ID: CINSM-6000

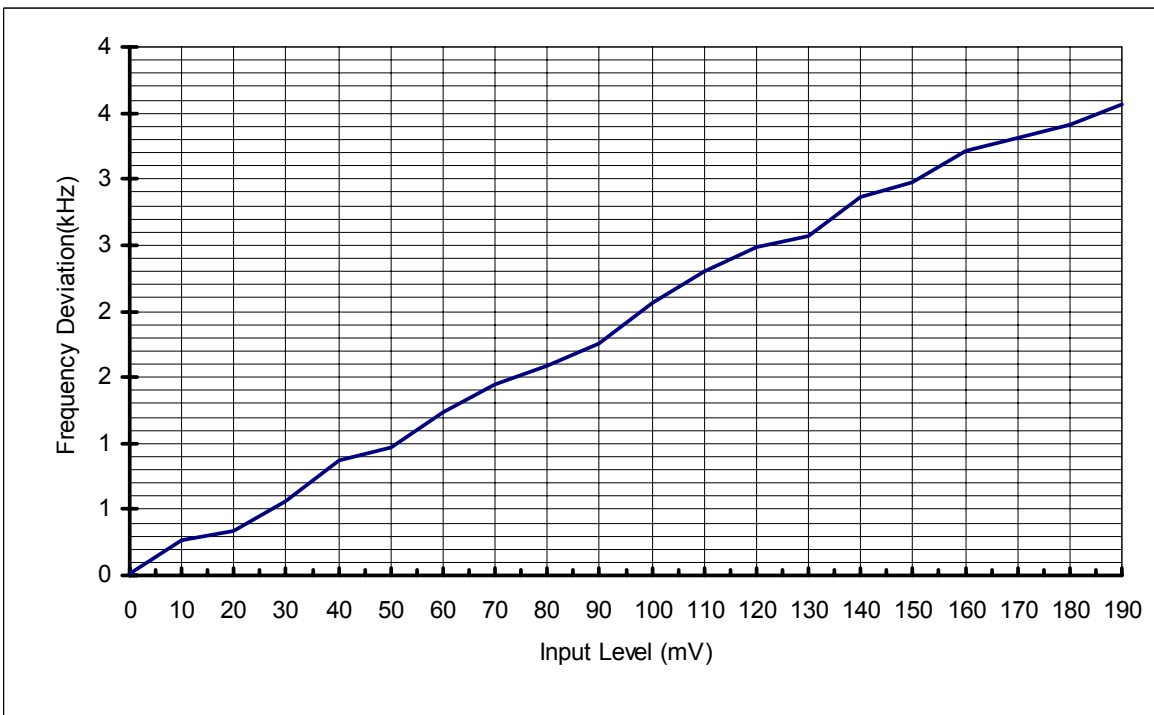
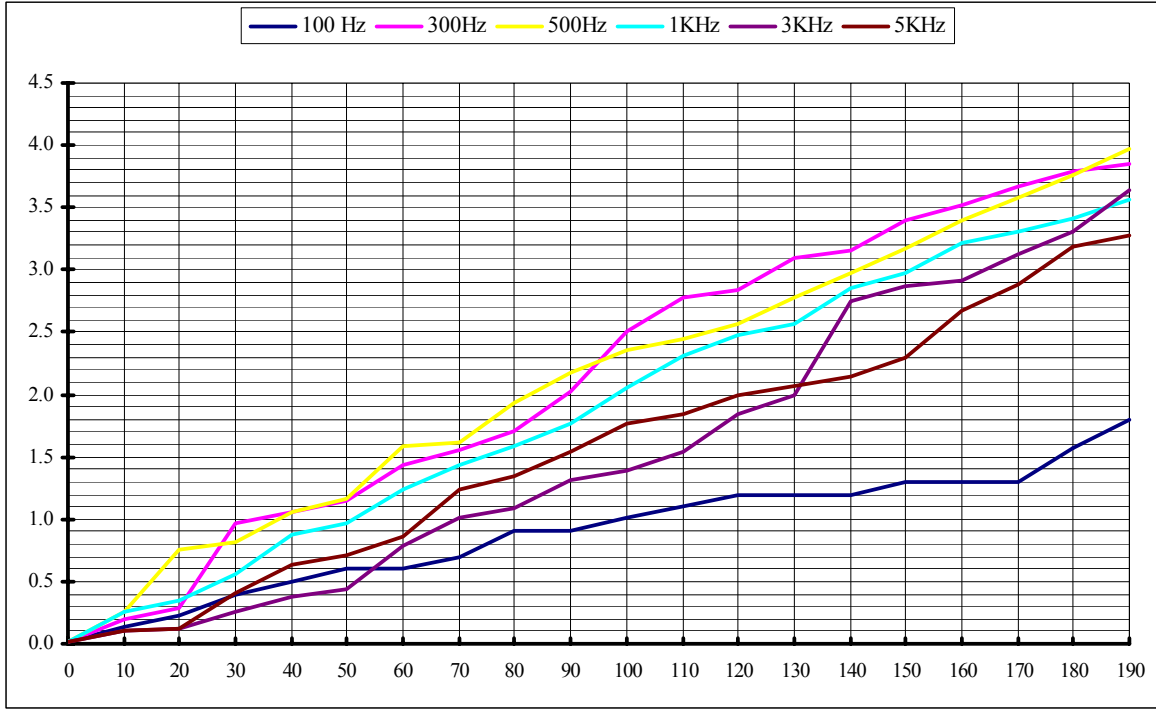

Registration number: W6M20408-5422-C-1  
FCC ID: CINSM-6000

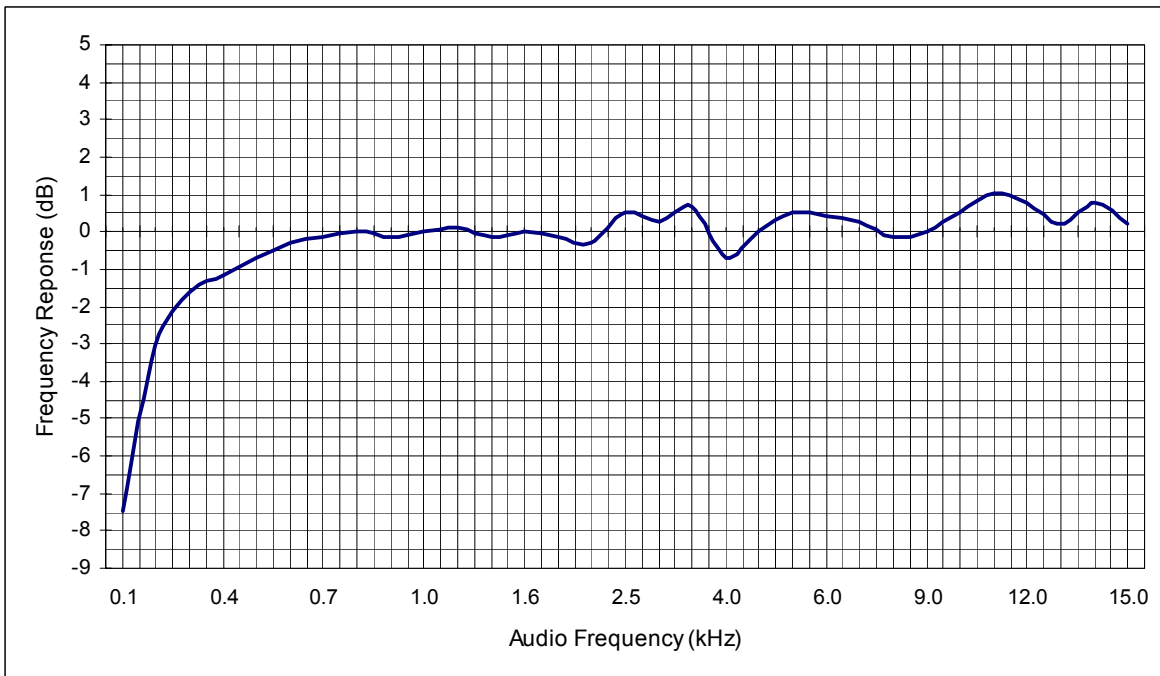
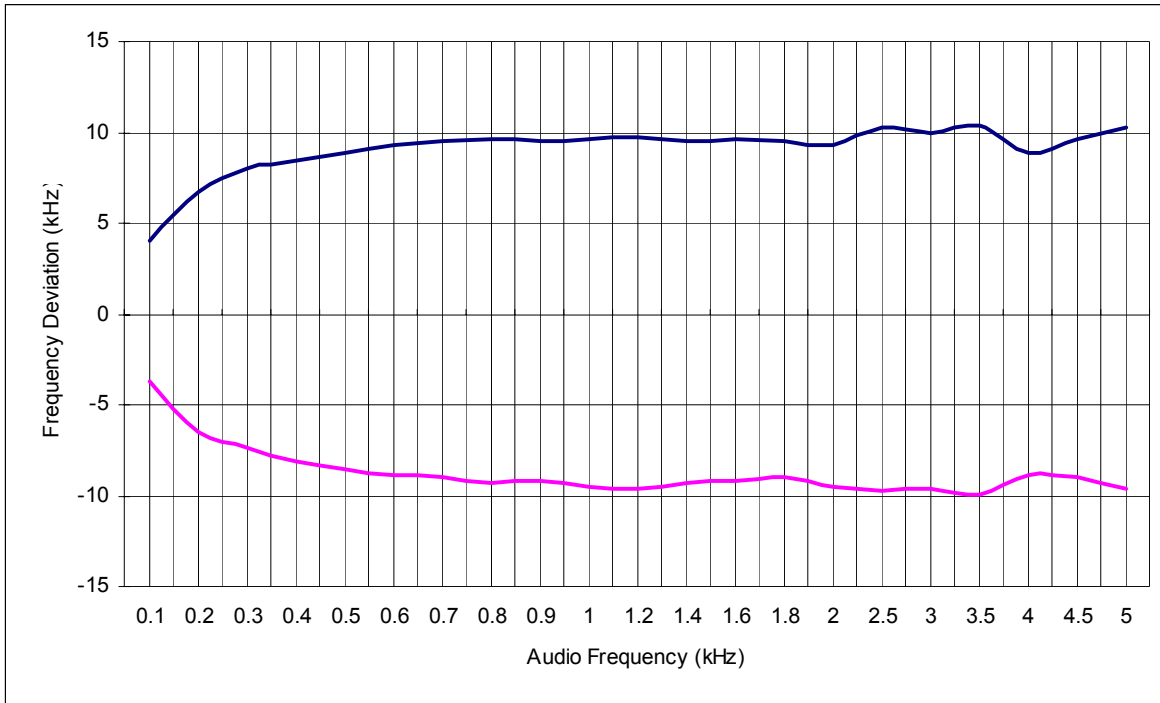

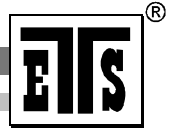

Registration number: W6M20408-5422-C-1  
FCC ID: CINSM-6000

## **Appendix C**

### Occupied Bandwidth / Emission Mask



Marker 1 [T1] RBW 3 kHz RF Att 40 dB  
 Ref Lvl 74.43 dBμV VBW 3 kHz  
 107 dBμV 614.99747198 MHz SWT 500 ms Unit dBμV

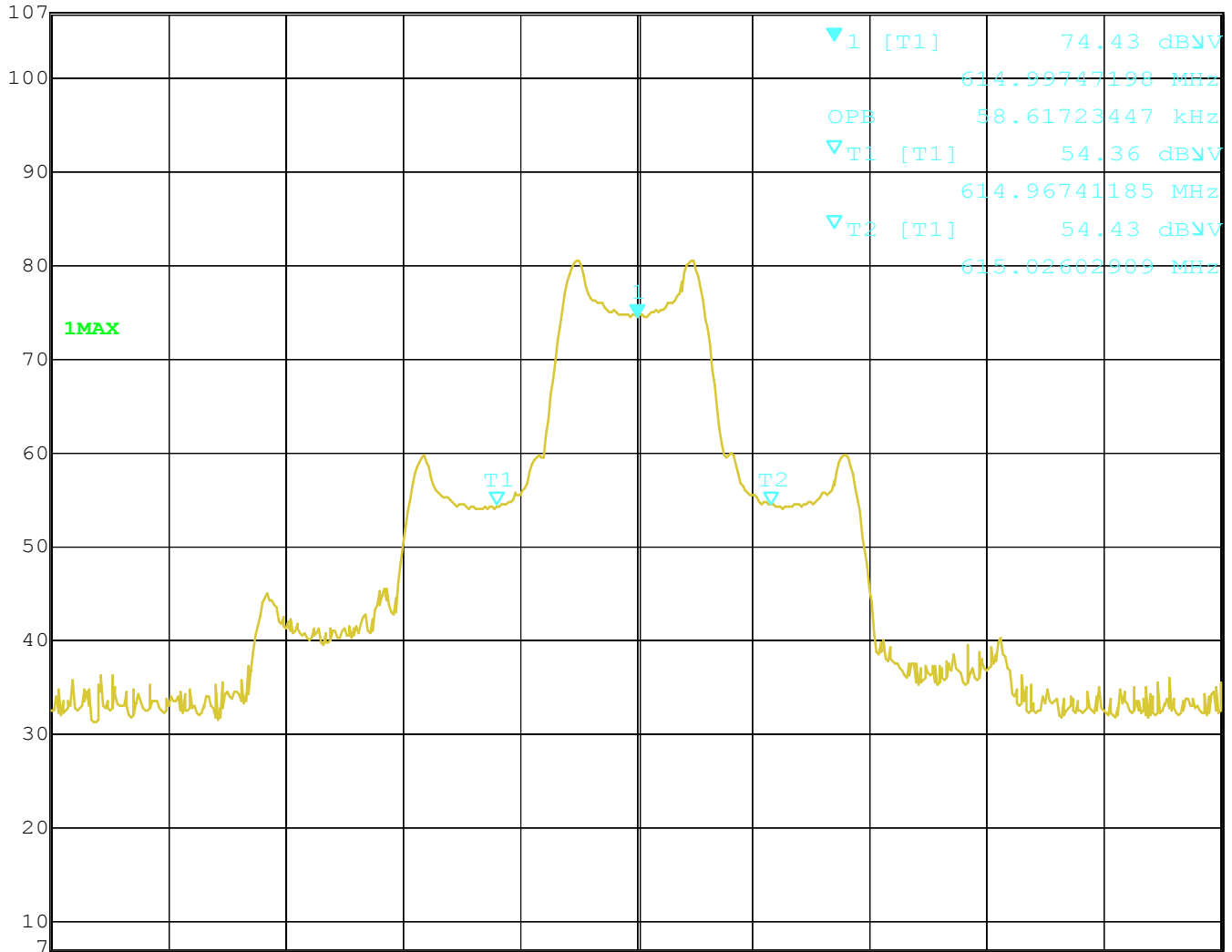

Center 614.9972215 MHz 25 kHz/ Span 250 kHz

Title: MODULATION WITH 1000HZ  
 Date: 16.AUG.2004 15:39:22



Marker 1 [T1] RBW 3 kHz RF Att 20 dB  
Ref Lvl -46.12 dBm VBW 3 kHz  
-10 dBm 710.00150000 MHz SWT 500 ms Unit dBm

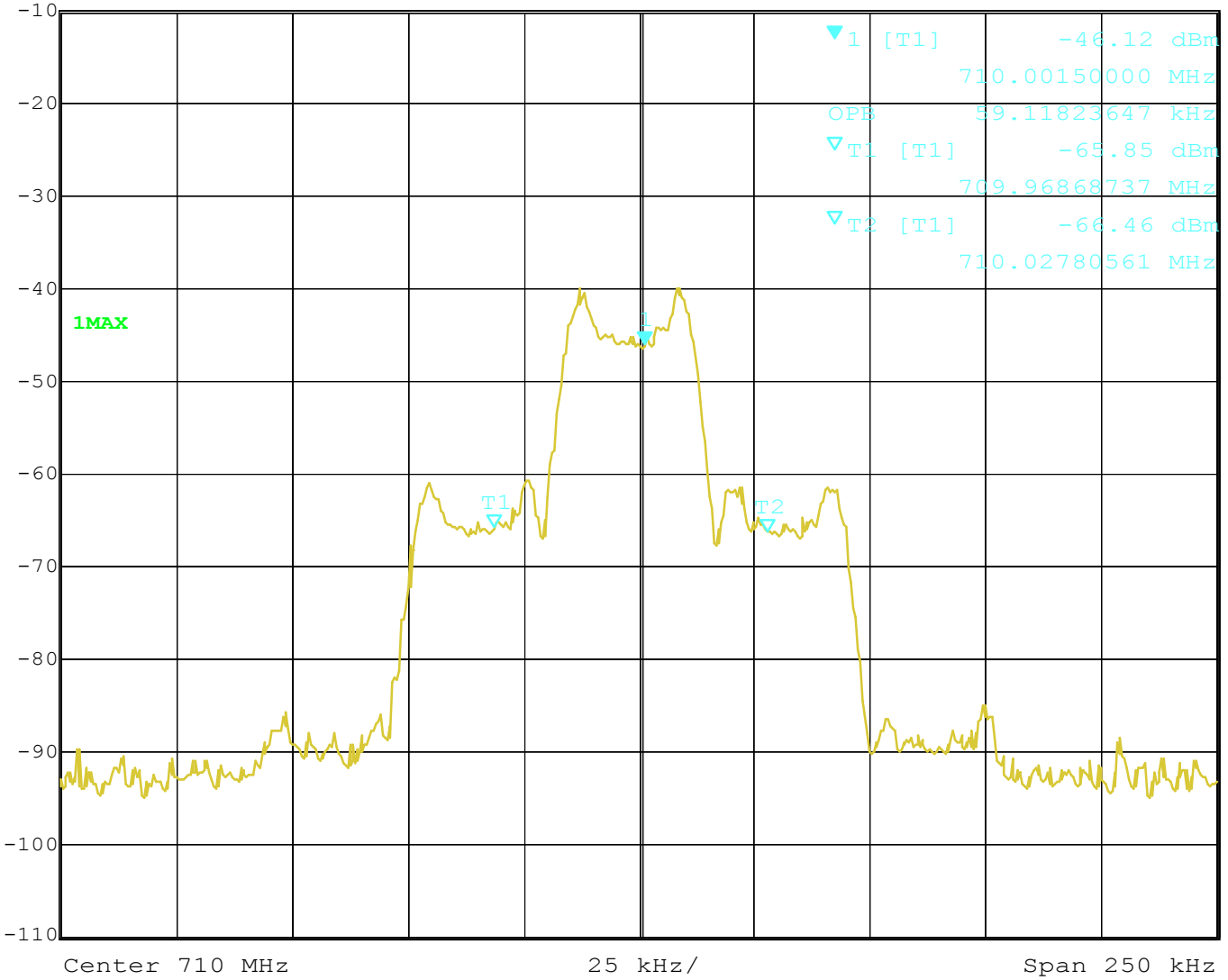

Title: MODULATION WITH 1000HZ  
Date: 24.AUG.2004 15:14:16



Marker 1 [T1] RBW 3 kHz RF Att 30 dB  
Ref Lvl -37.01 dBm VBW 3 kHz  
0 dBm 805.75025050 MHz SWT 500 ms Unit dBm

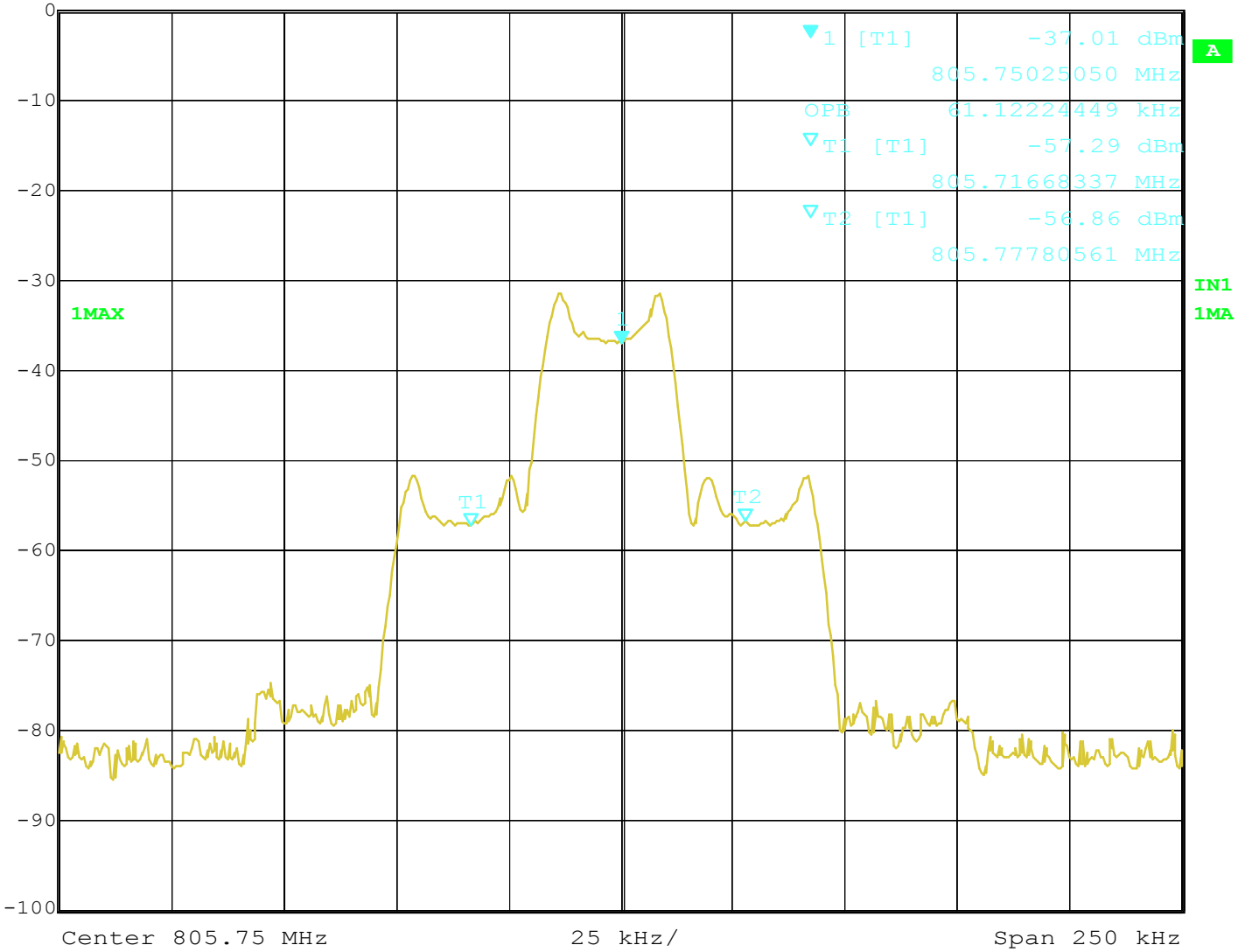

Title: MODULATION WITH 1000HZ  
Date: 24.AUG.2004 15:28:43



Marker 1 [T1] RBW 3 kHz RF Att 40 dB  
 Ref Lvl 69.83 dBμV VBW 3 kHz  
 107 dBμV 614.99747198 MHz SWT 500 ms Unit dBμV

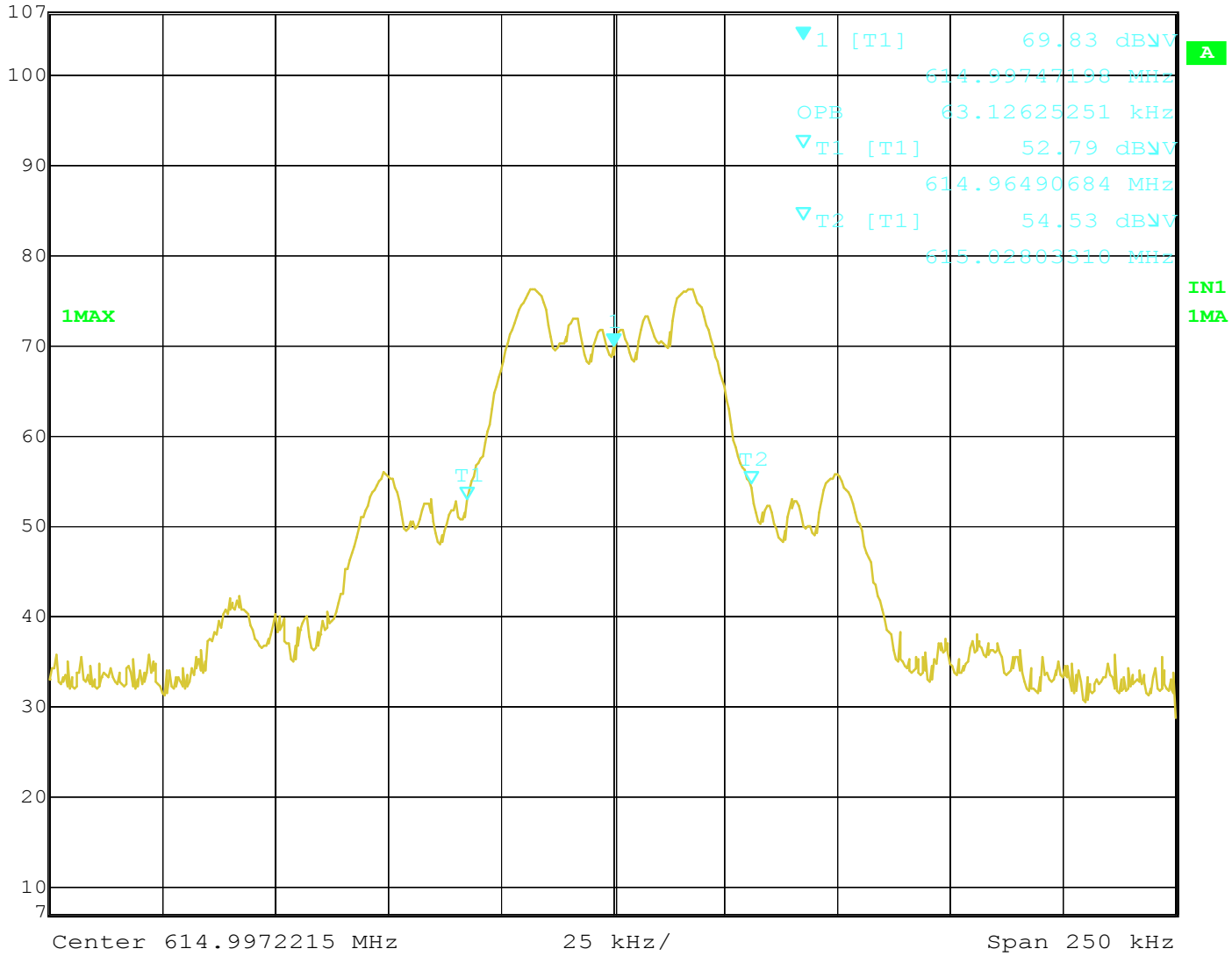

Title: MODULATION WITH 2500HZ  
 Date: 16.AUG.2004 15:41:57





Marker 1 [T1] RBW 3 kHz RF Att 20 dB  
 Ref Lvl -45.85 dBm VBW 3 kHz  
 -10 dBm 710.00150000 MHz SWT 500 ms Unit dBm

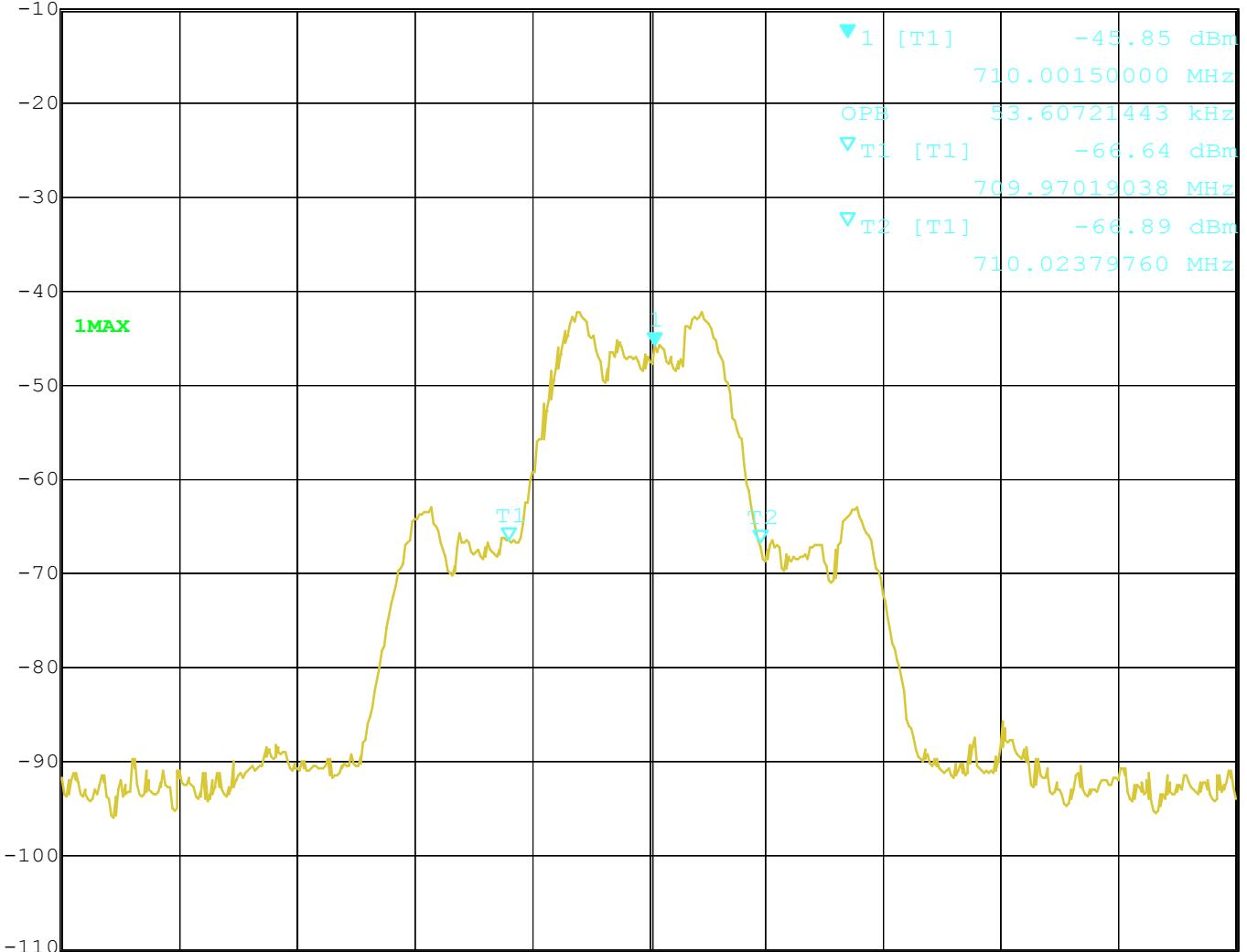

Center 710 MHz 25 kHz/ Span 250 kHz

Title: MODULATION WITH 2500HZ  
 Date: 24.AUG.2004 15:15:06



Marker 1 [T1] RBW 3 kHz RF Att 30 dB  
Ref Lvl -31.08 dBm VBW 3 kHz  
0 dBm 805.75025050 MHz SWT 500 ms Unit dBm

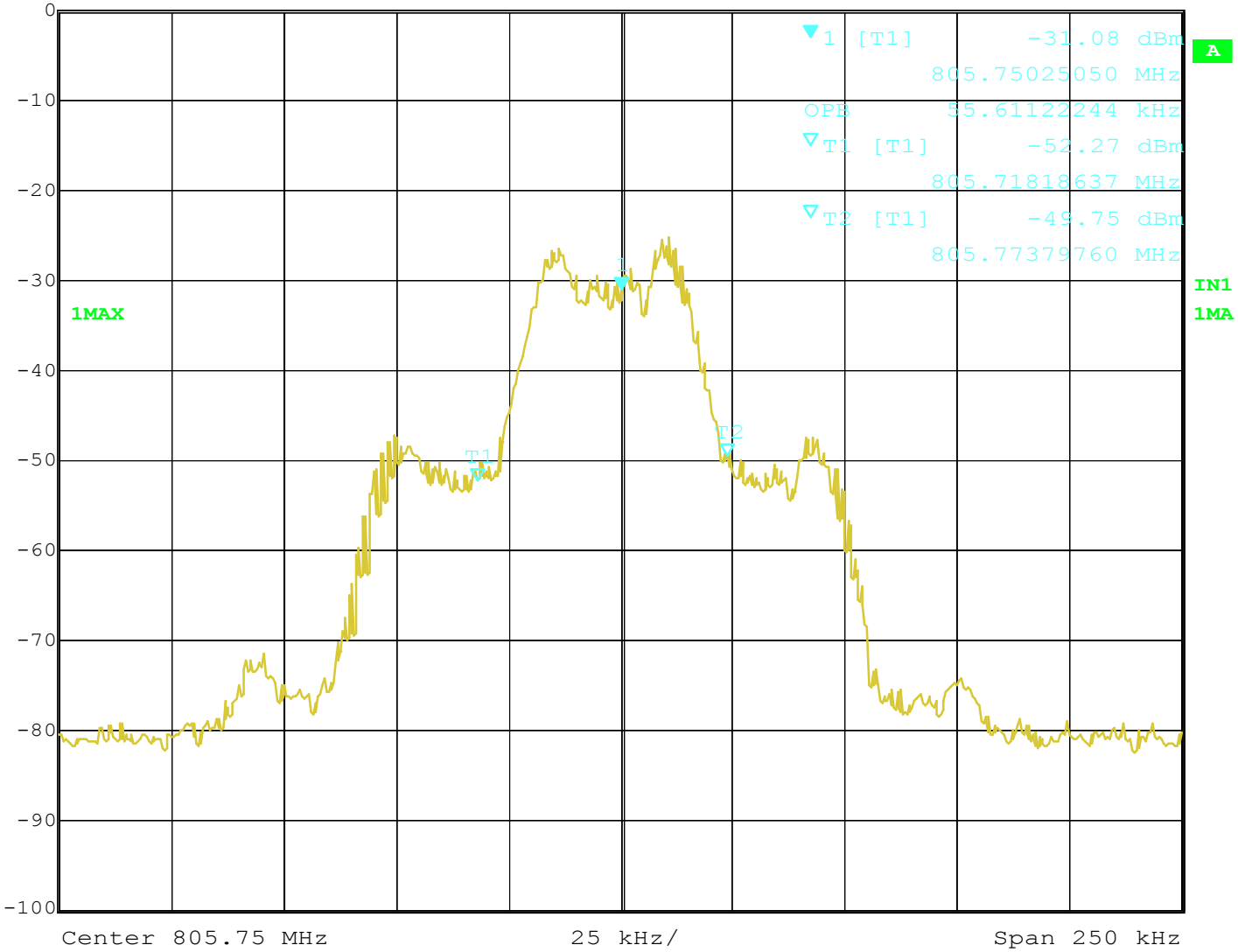

Title: MODULATION WITH 2500HZ  
Date: 24.AUG.2004 15:26:17



Marker 1 [T1]

RBW 1 kHz RF Att 40 dB

Ref Lvl -6.76 dBm

VBW 1 kHz

10 dBm 614.99699399 MHz

SWT 5 s Unit dBm

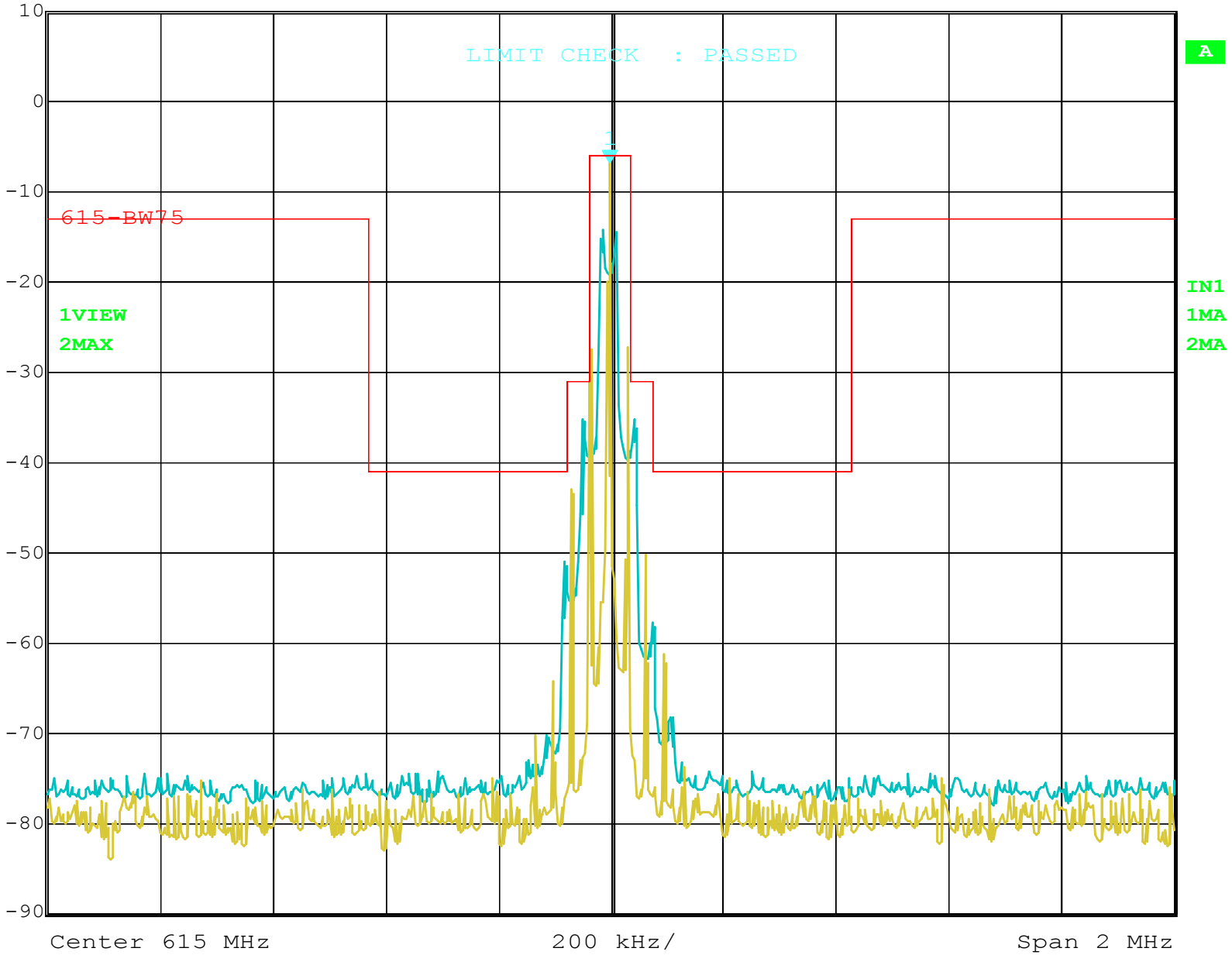

Title: Emission Mask

Date: 24.AUG.2004 10:28:07



Marker 1 [T1]

RBW 1 kHz RF Att 20 dB

Ref Lvl -0.36 dBm

VBW 1 kHz

0 dBm 709.99799599 MHz

SWT 5 s

Unit dBm

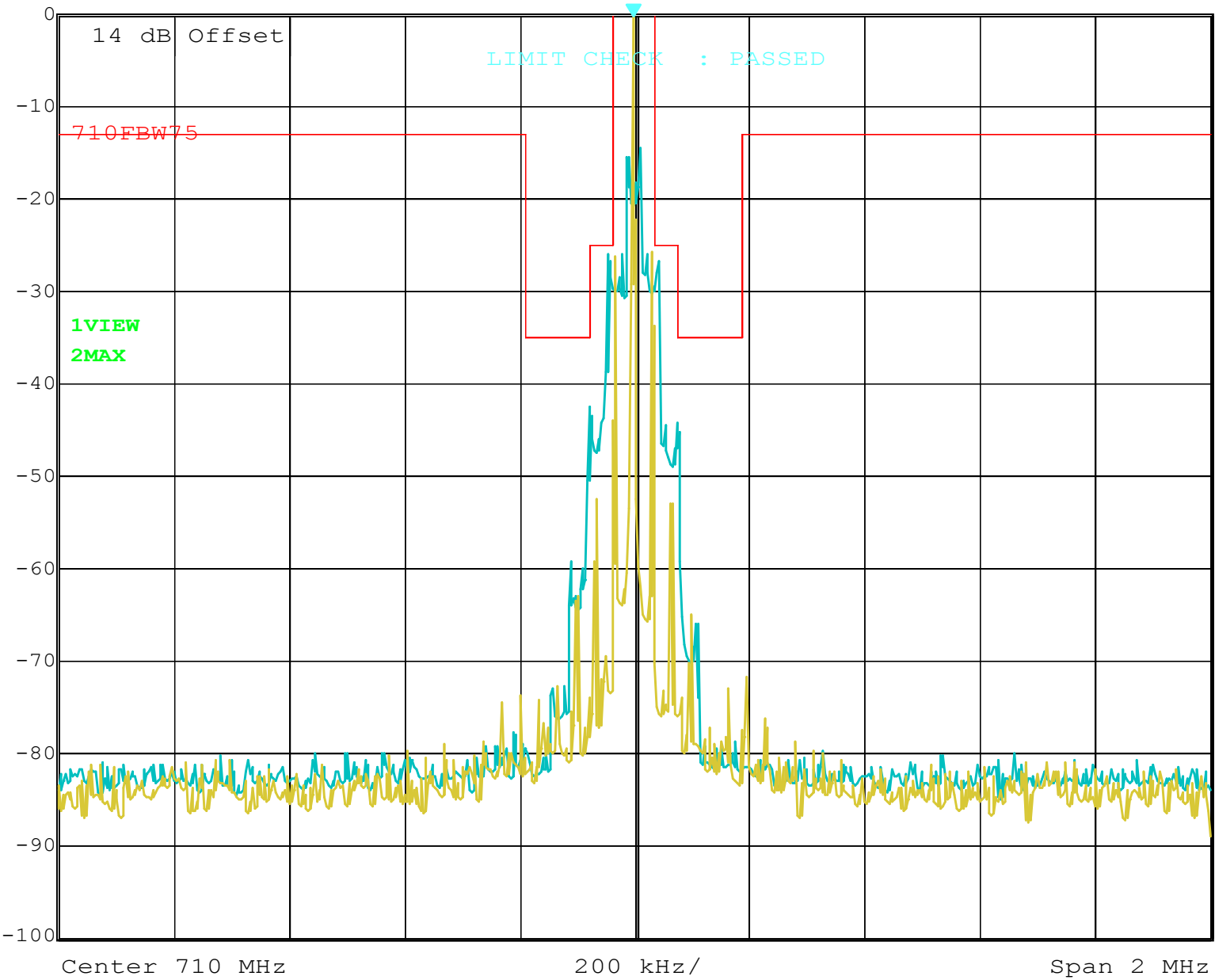

Date: 25.AUG.2004 14:54:19



Marker 1 [T1]

RBW 1 kHz RF Att 40 dB

Ref Lvl -8.90 dBm

VBW 1 kHz

10 dBm 805.74609218 MHz

SWT 5 s Unit dBm



Title: Emission Mask

Date: 24.AUG.2004 11:13:48

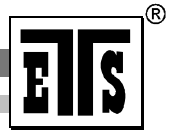

Registration number: W6M20408-5422-C-1  
FCC ID: CINSM-6000

## **Appendix D**

### Spurious Emissions at Antenna Terminals



Marker 1 [T1]

RBW 100 kHz RF Att 10 dB

Ref Lvl -65.09 dBm

VBW 100 kHz

13 dBm 141.40280561 MHz

SWT 2 s Unit dBm

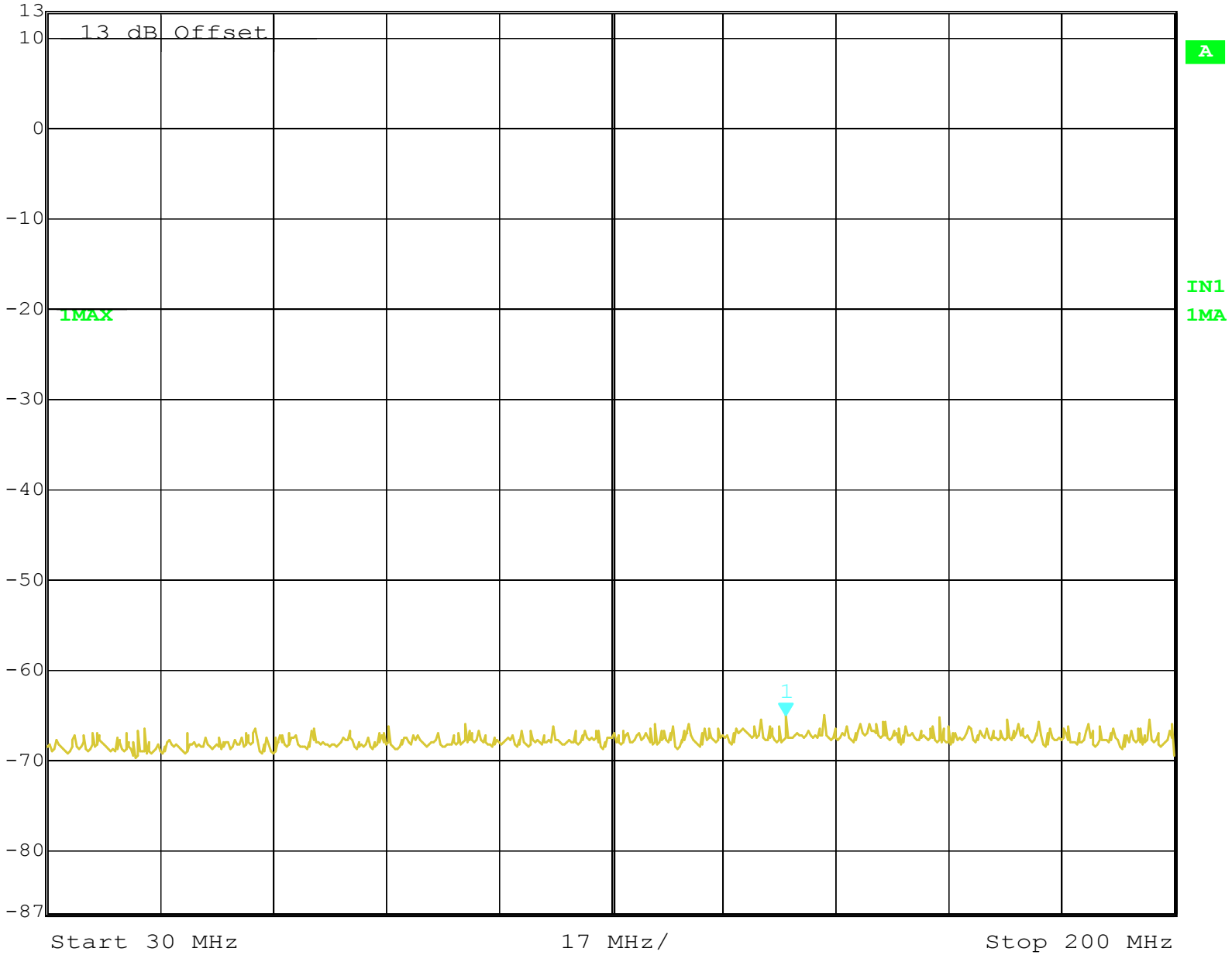

Title: conducted spurious emission

Date: 24.AUG.2004 13:00:04



Marker 1 [T1]

RBW 100 kHz RF Att 10 dB

Ref Lvl 9.11 dBm

VBW 100 kHz

13 dBm 615.23046092 MHz

SWT 2 s Unit dBm

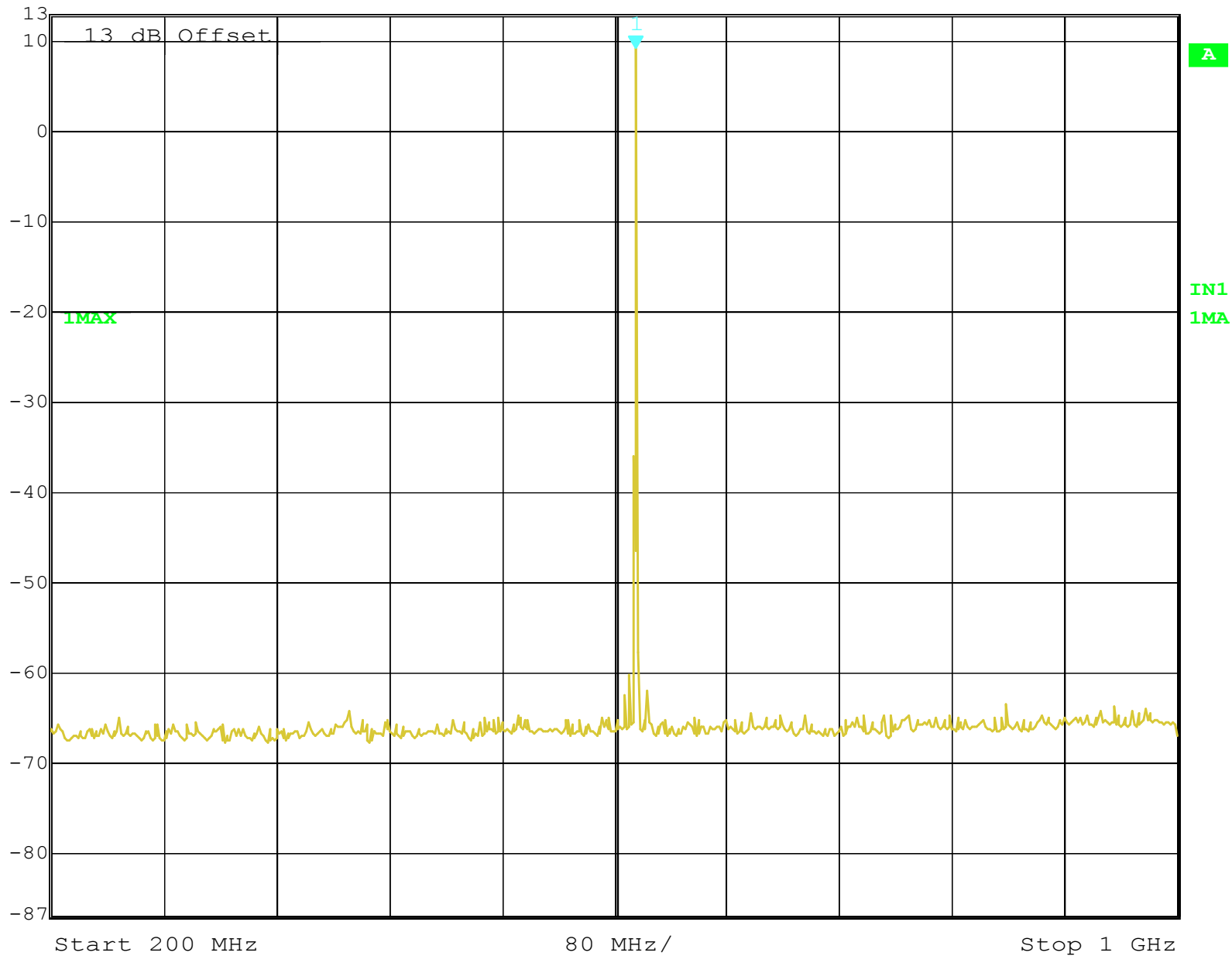

Title: conducted spurious emission

Date: 24.AUG.2004 12:59:29





Marker 1 [T1]

RBW 100 kHz RF Att 10 dB

Ref Lvl -41.70 dBm

VBW 100 kHz

13 dBm 1.84168337 GHz

SWT 2 s Unit dBm

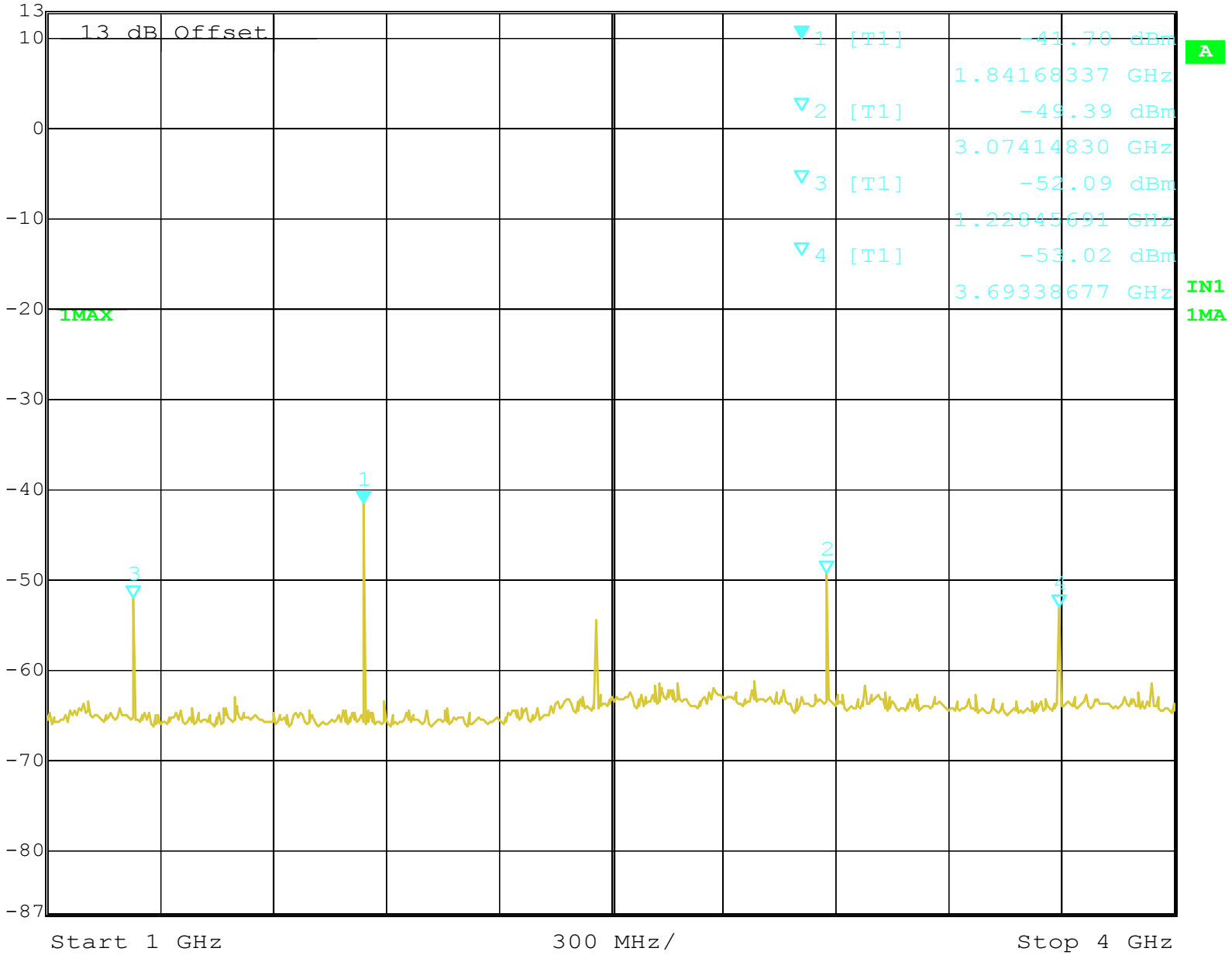

Start 1 GHz

300 MHz/

Stop 4 GHz

Title: conducted spurious emission

Date: 24.AUG.2004 12:58:39



Marker 1 [T1]

RBW 100 kHz RF Att 10 dB

Ref Lvl -54.22 dBm

VBW 100 kHz

13 dBm 4.30460922 GHz

SWT 2 s

Unit dBm

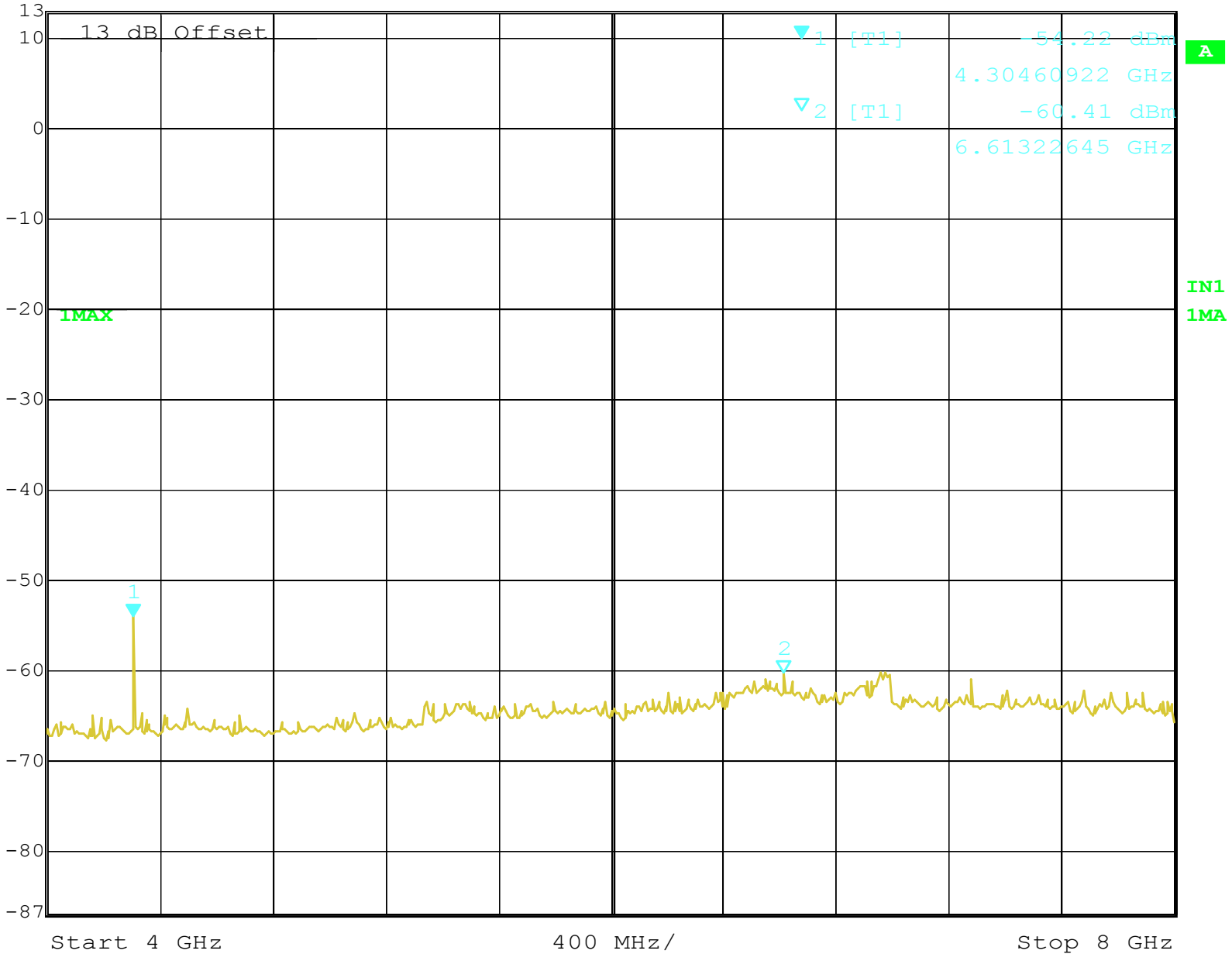

Title: conducted spurious emission

Date: 24.AUG.2004 12:57:52



Marker 1 [T1]

RBW 100 kHz RF Att 10 dB

Ref Lvl -62.44 dBm

VBW 100 kHz

13 dBm 11.83967936 GHz

SWT 2 s Unit dBm

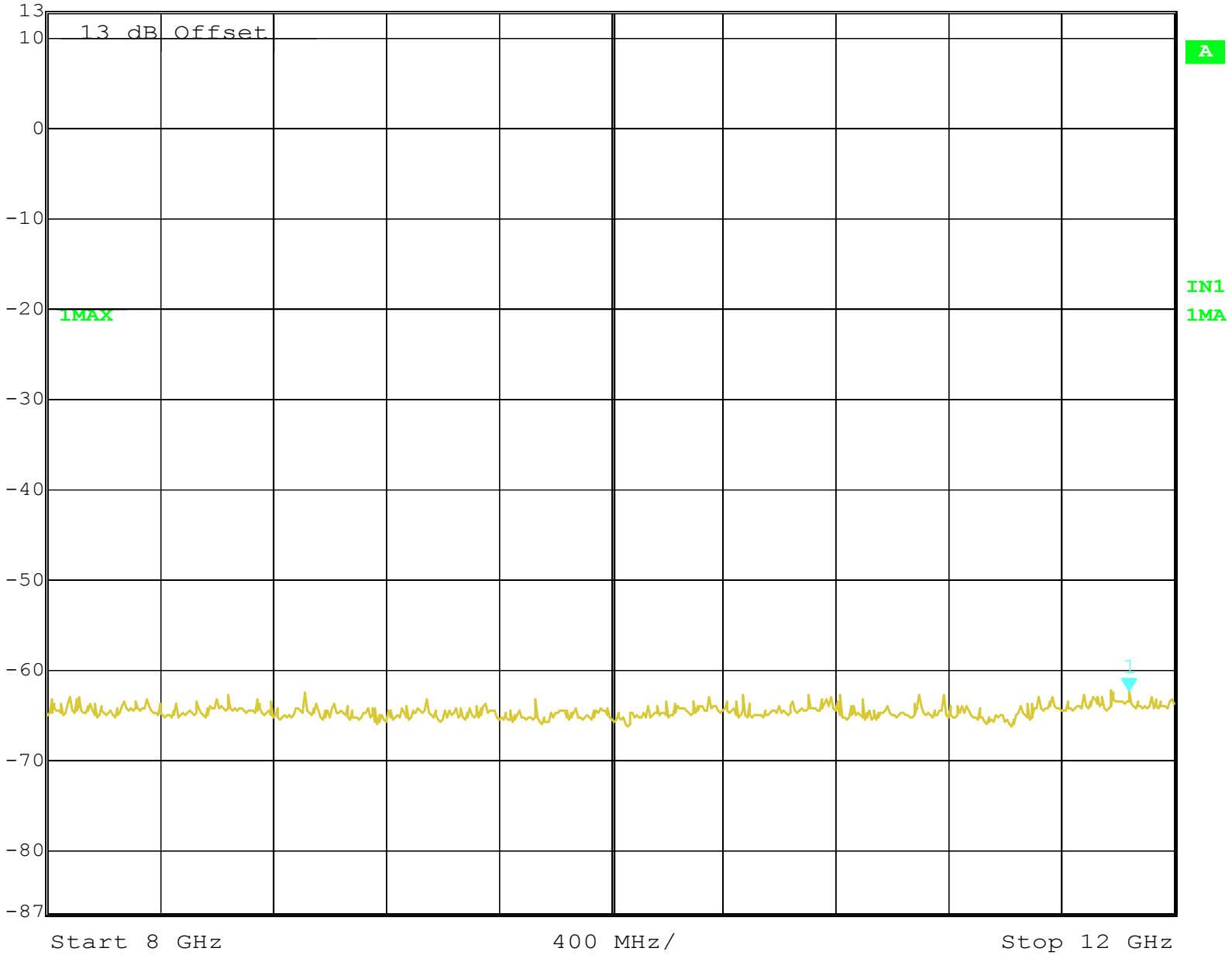

Title: conducted spurious emission

Date: 24.AUG.2004 12:57:12



Marker 1 [T1]

RBW 100 kHz RF Att 10 dB

Ref Lvl -65.54 dBm

VBW 100 kHz

13 dBm 148.21643287 MHz

SWT 2 s Unit dBm

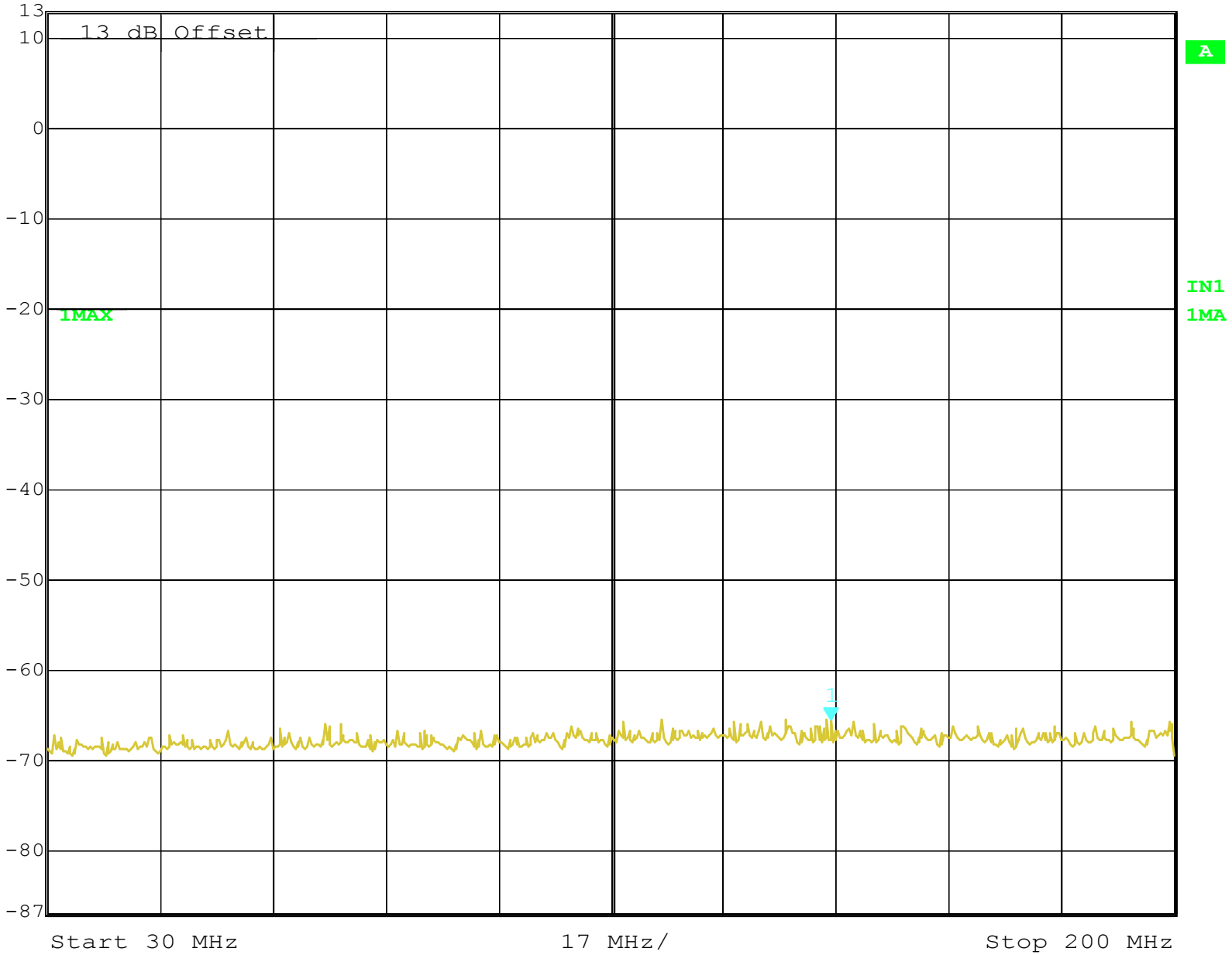

Title: conducted spurious emission  
Date: 24.AUG.2004 12:52:14



Marker 1 [T1]

RBW 100 kHz RF Att 10 dB

Ref Lvl 0.15 dBm

VBW 100 kHz

13 dBm 709.81963928 MHz

SWT 2 s Unit dBm

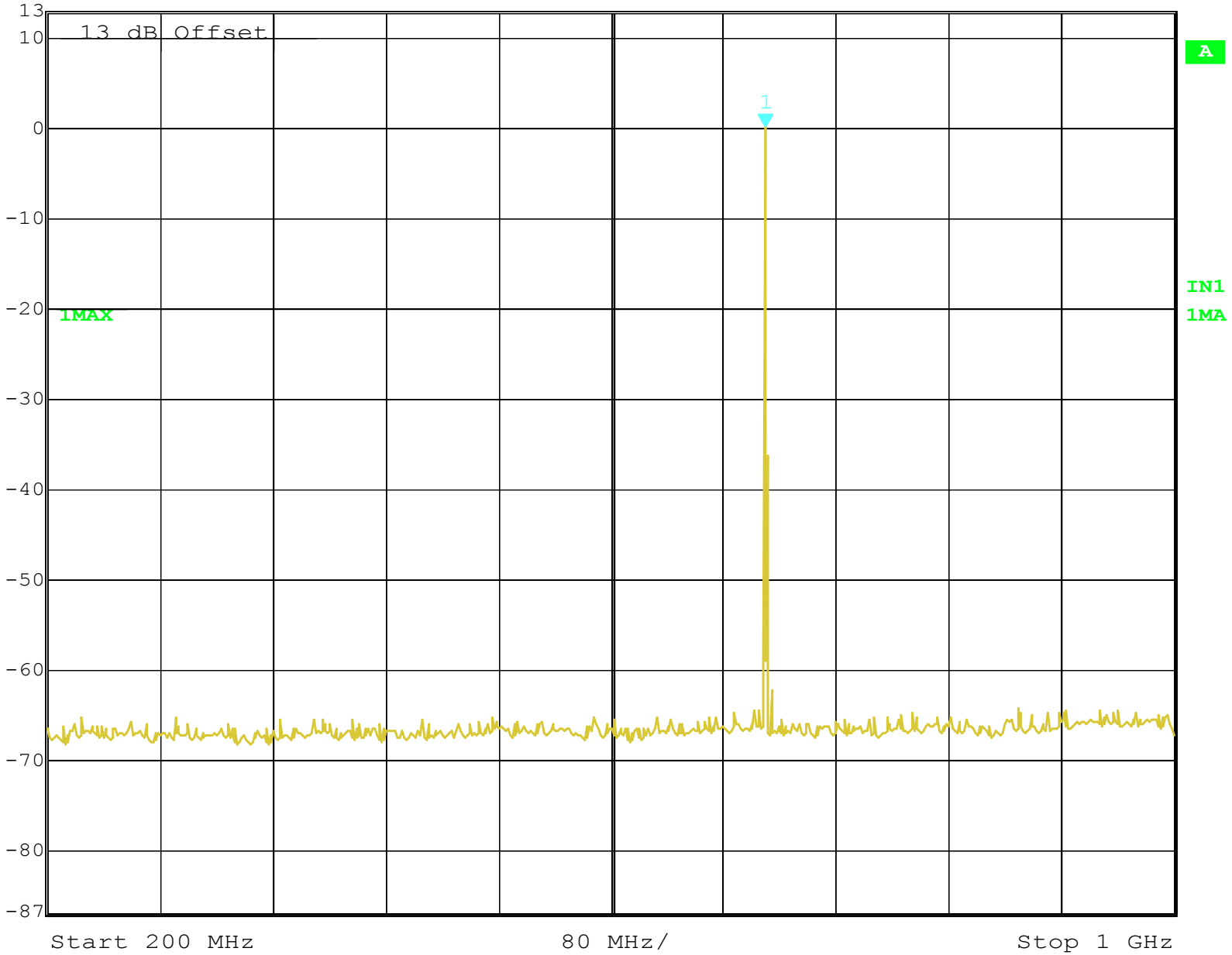

Title: conducted spurious emission

Date: 24.AUG.2004 12:52:47



Marker 4 [T1]

RBW 100 kHz RF Att 10 dB

Ref Lvl -45.82 dBm

VBW 100 kHz

13 dBm 2.13026052 GHz

SWT 2 s Unit dBm

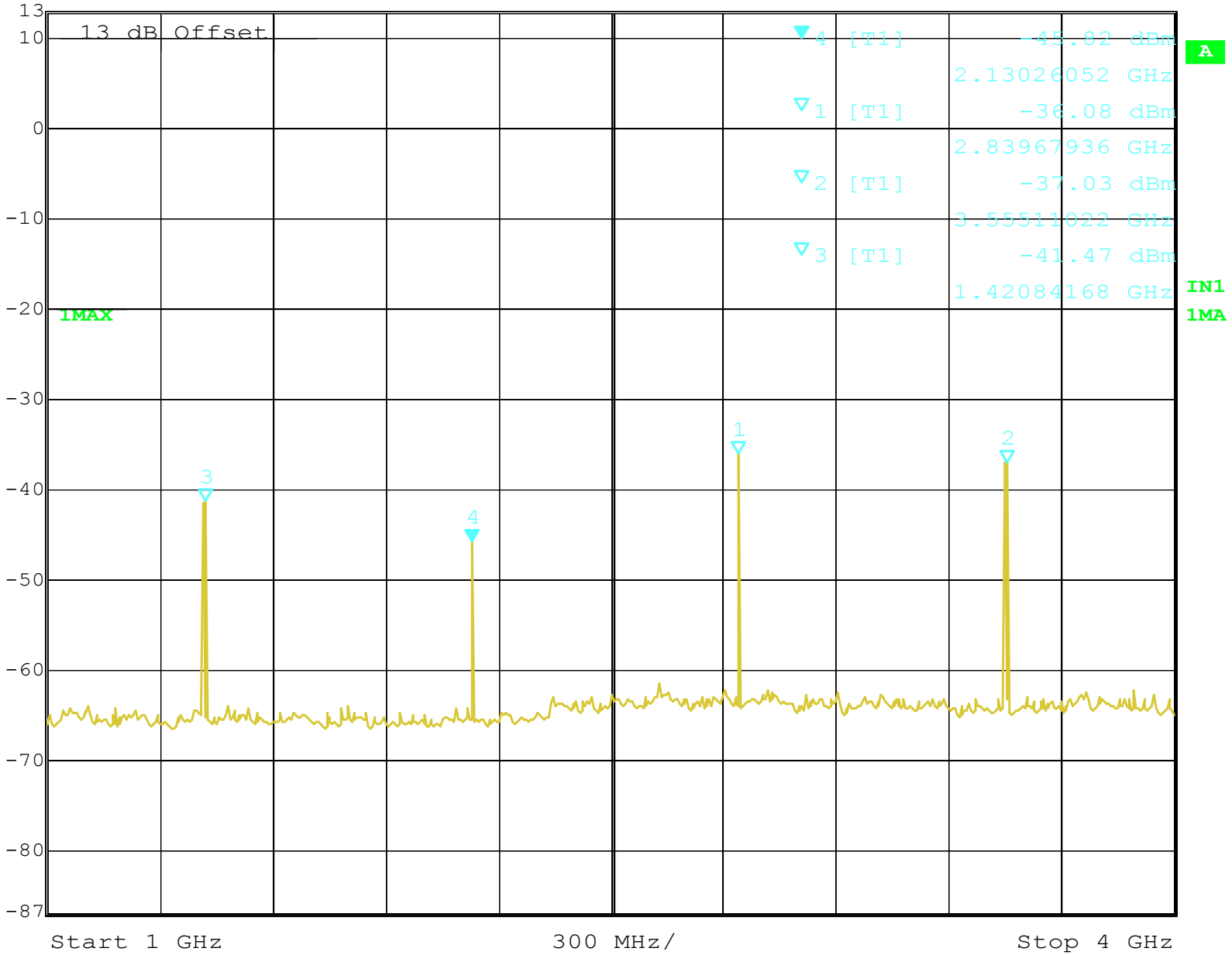

Title: conducted spurious emission

Date: 24.AUG.2004 12:53:31



Marker 1 [T1]

RBW 100 kHz RF Att 10 dB

Ref Lvl -47.87 dBm

VBW 100 kHz

13 dBm 4.25651303 GHz

SWT 2 s Unit dBm

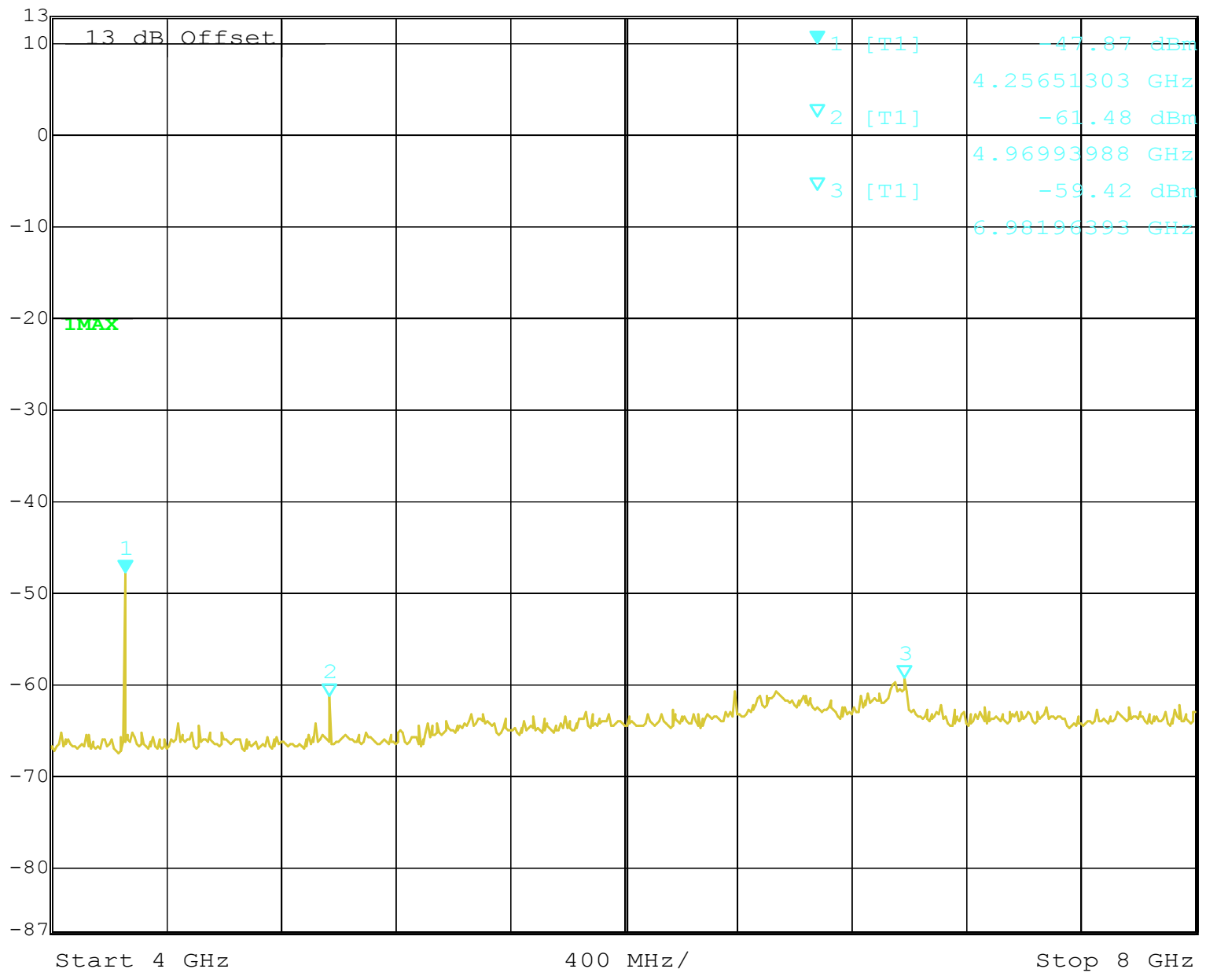

Title: conducted spurious emission  
Date: 24.AUG.2004 12:54:26



Marker 1 [T1]

RBW 100 kHz RF Att 10 dB

Ref Lvl -61.95 dBm

VBW 100 kHz

13 dBm 8.63326653 GHz

SWT 2 s Unit dBm

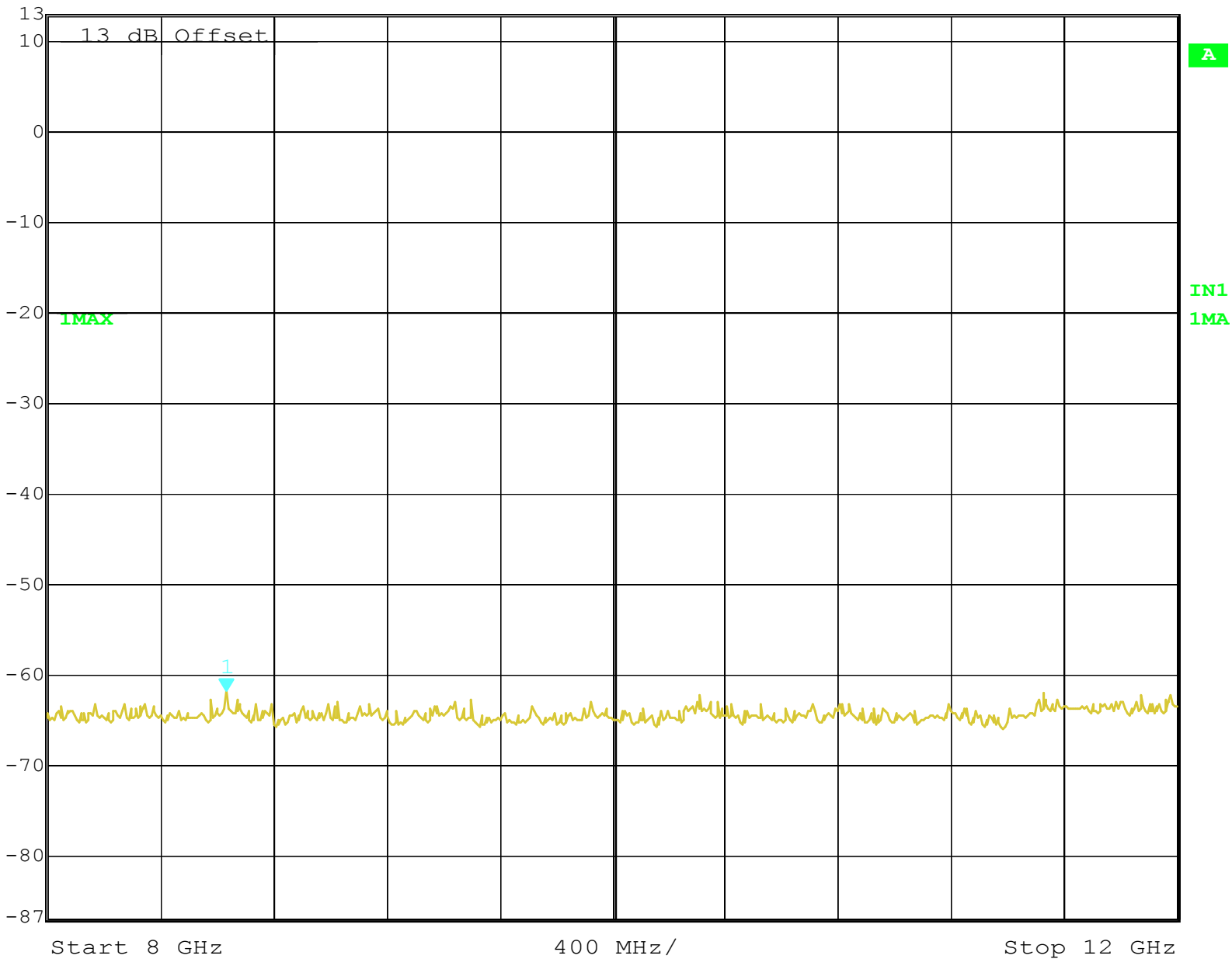

Title: conducted spurious emission

Date: 24.AUG.2004 12:54:59





Marker 1 [T1]

RBW 100 kHz RF Att 10 dB

Ref Lvl -64.75 dBm

VBW 100 kHz

13 dBm 145.83166333 MHz

SWT 2 s Unit dBm

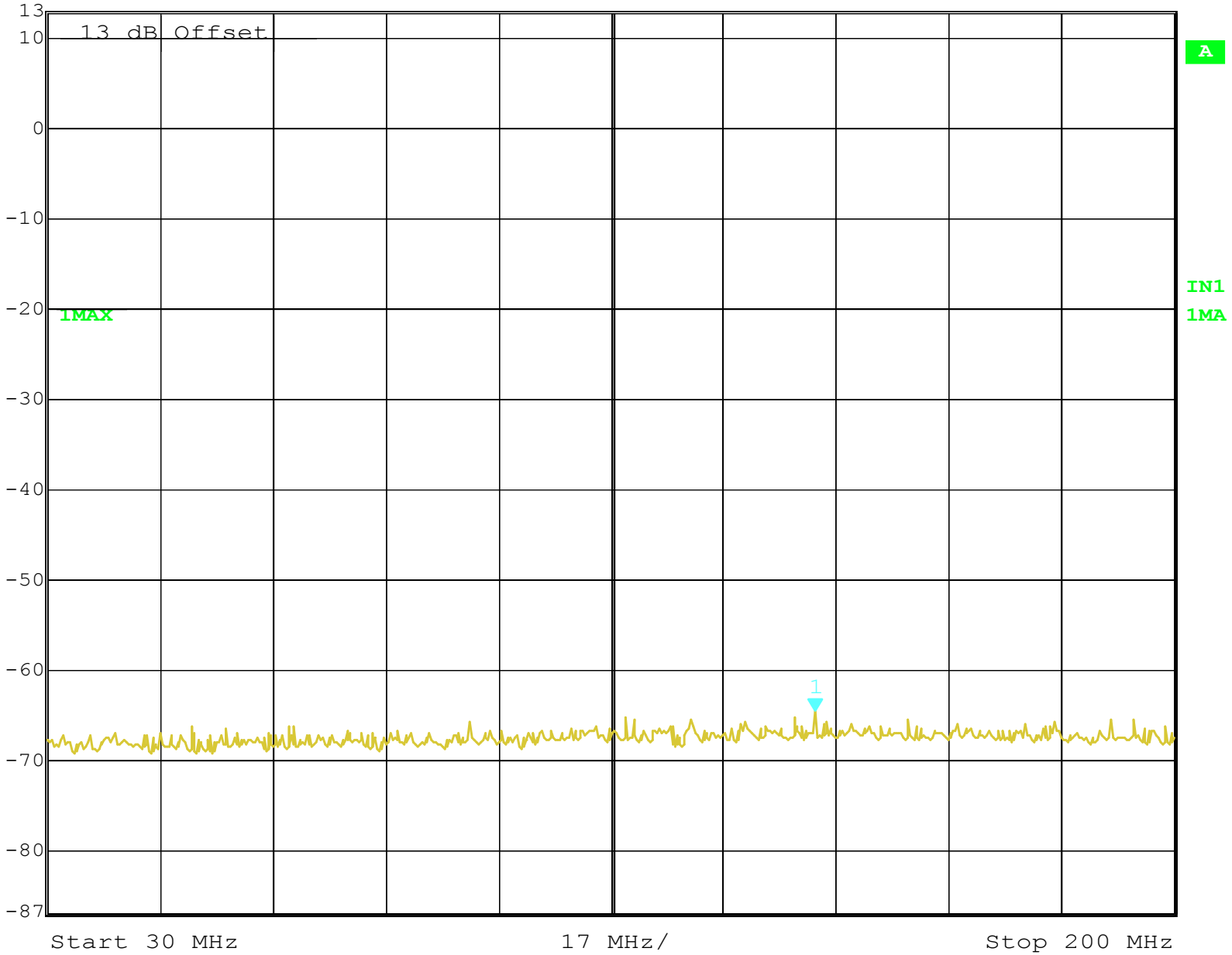

Title: conducted spurious emission

Date: 24.AUG.2004 12:49:13



Marker 1 [T1]

RBW 100 kHz RF Att 10 dB

Ref Lvl 4.10 dBm

VBW 100 kHz

13 dBm 806.01202405 MHz

SWT 2 s

Unit dBm

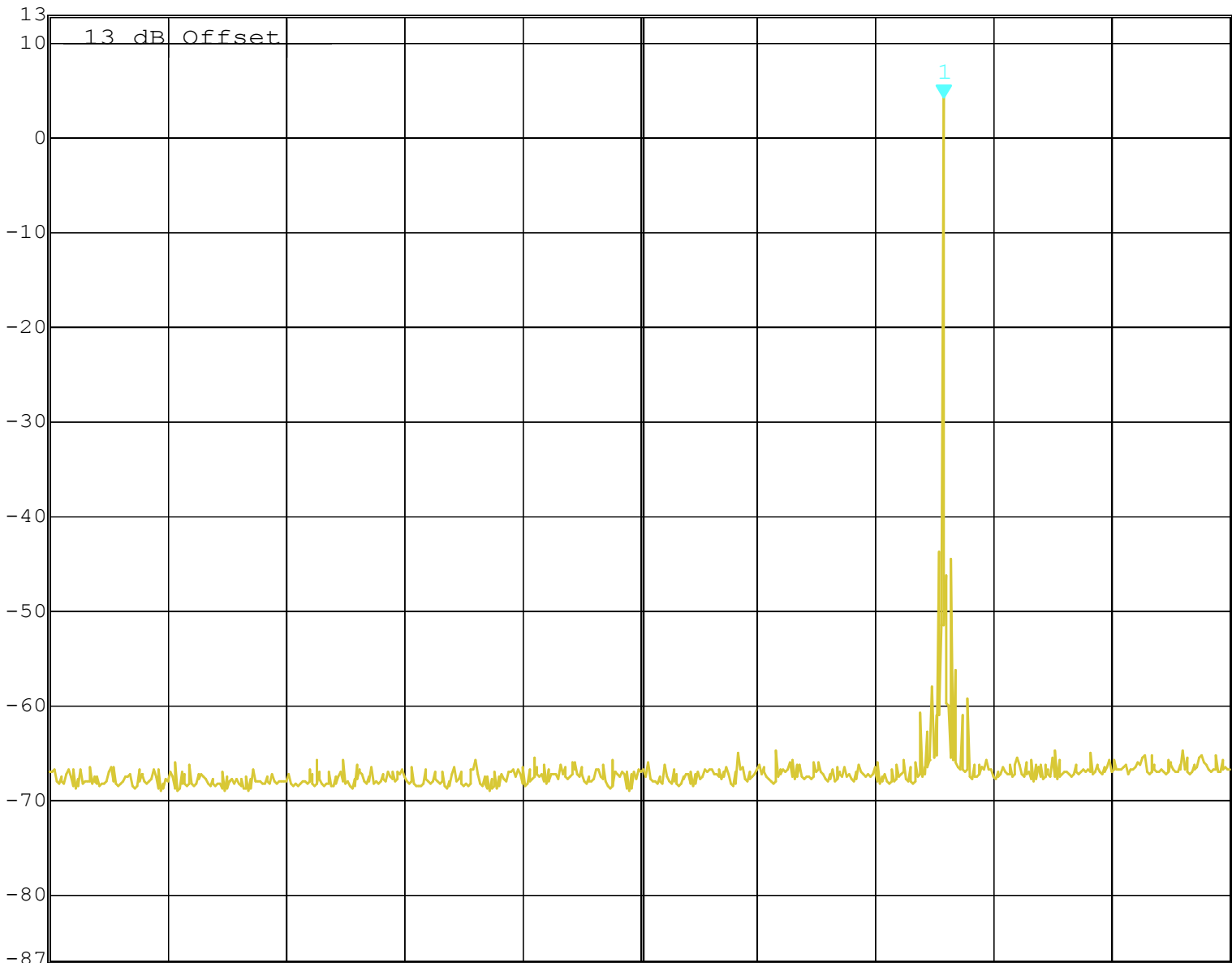

A

IN1  
1MA

Start 200 MHz

80 MHz/

Stop 1 GHz

Title: conducted spurious emission

Date: 24.AUG.2004 12:48:38



Marker 1 [T1]

RBW 100 kHz RF Att 0 dB

Ref Lvl -38.20 dBm

VBW 100 kHz

3 dBm 1.60721443 GHz

SWT 2 s Unit dBm

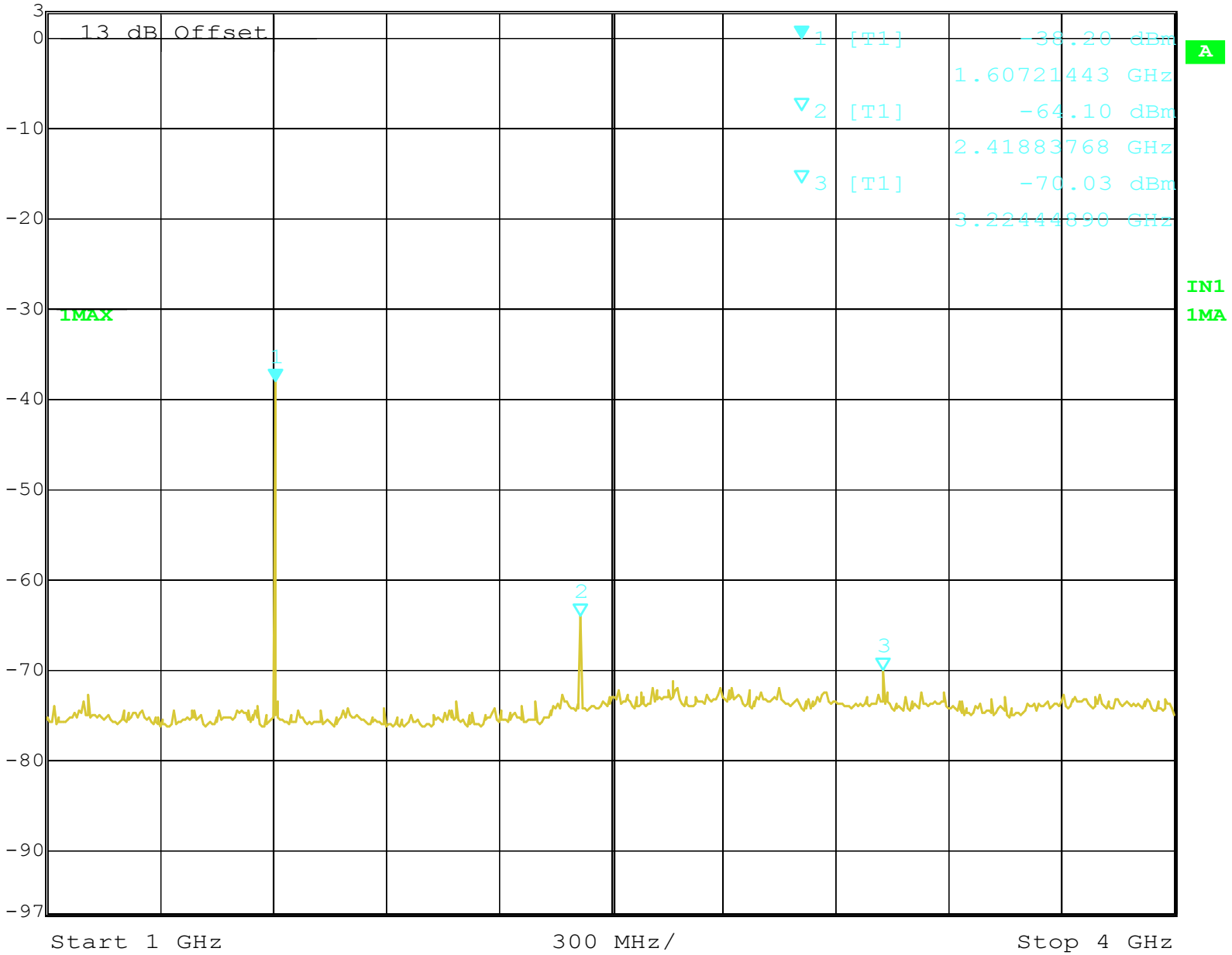

Title: conducted spurious emission

Date: 24.AUG.2004 12:47:50



Marker 1 [T1]

RBW 100 kHz RF Att 0 dB

Ref Lvl -71.61 dBm

VBW 100 kHz

3 dBm 4.02404810 GHz

SWT 2 s Unit dBm

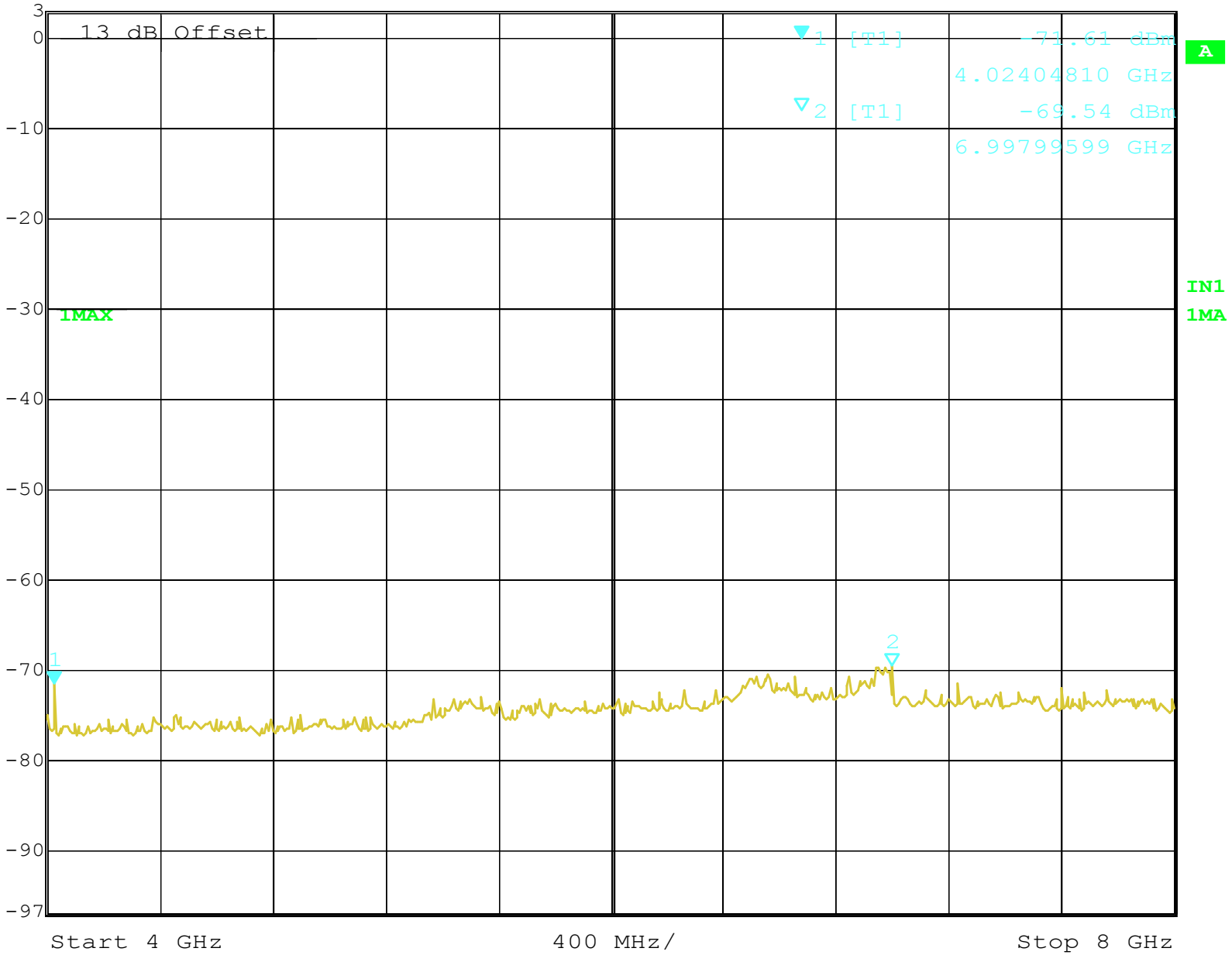

Start 4 GHz

400 MHz/

Stop 8 GHz

Title: conducted spurious emission

Date: 24.AUG.2004 12:47:04



Marker 1 [T1]

RBW 100 kHz RF Att 0 dB

Ref Lvl -72.60 dBm

VBW 100 kHz

3 dBm 11.88777555 GHz

SWT 2 s Unit dBm

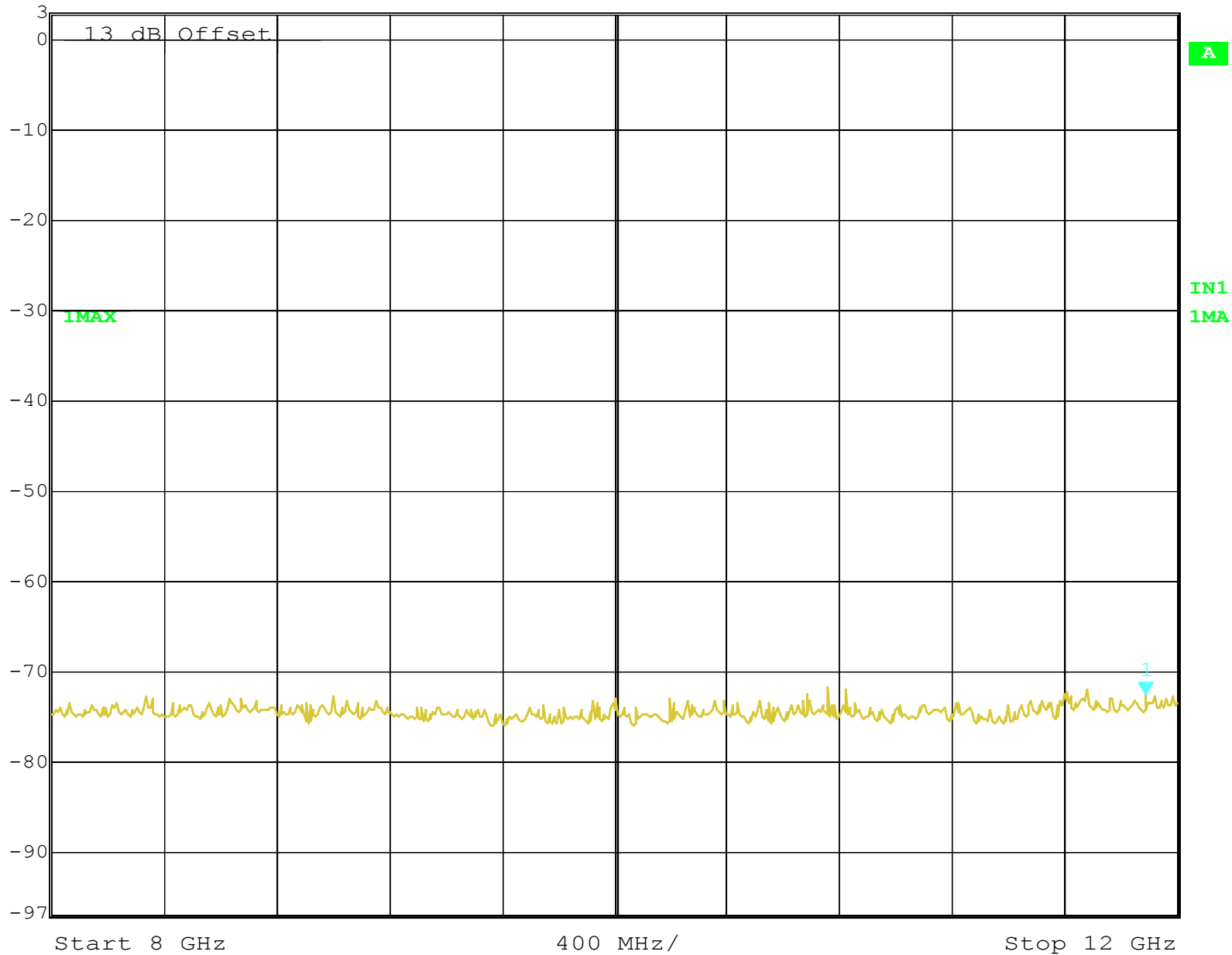

Title: conducted spurious emission

Date: 24.AUG.2004 12:46:13

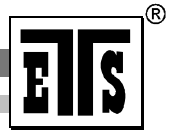

Registration number: W6M20408-5422-C-1  
FCC ID: CINSM-6000

## **Appendix E**

### Radiation Spurious Emission

**Spurious emissions under normal conditions**

**in according to FCC Part 74.861**

EUT: Wireless Microphone Transmitter  
MODEL NO.: SM-6000 Low Channel  
Approval Holder: CHIAYO ELECTRONICS.,LTD.  
Test Site / Operator: ETS / Sander Huang  
Temperature/Voltage: Temp.: 23°C/ Unom.: 3VDC (1.5VDC x 2 battery)  
Test Specification: 74.861  
Comment 1: Dist.: 3m, Ant.: HK 116  
Freq:90.230MHz Pmax:-54.12dBm RBW: 100 kHz

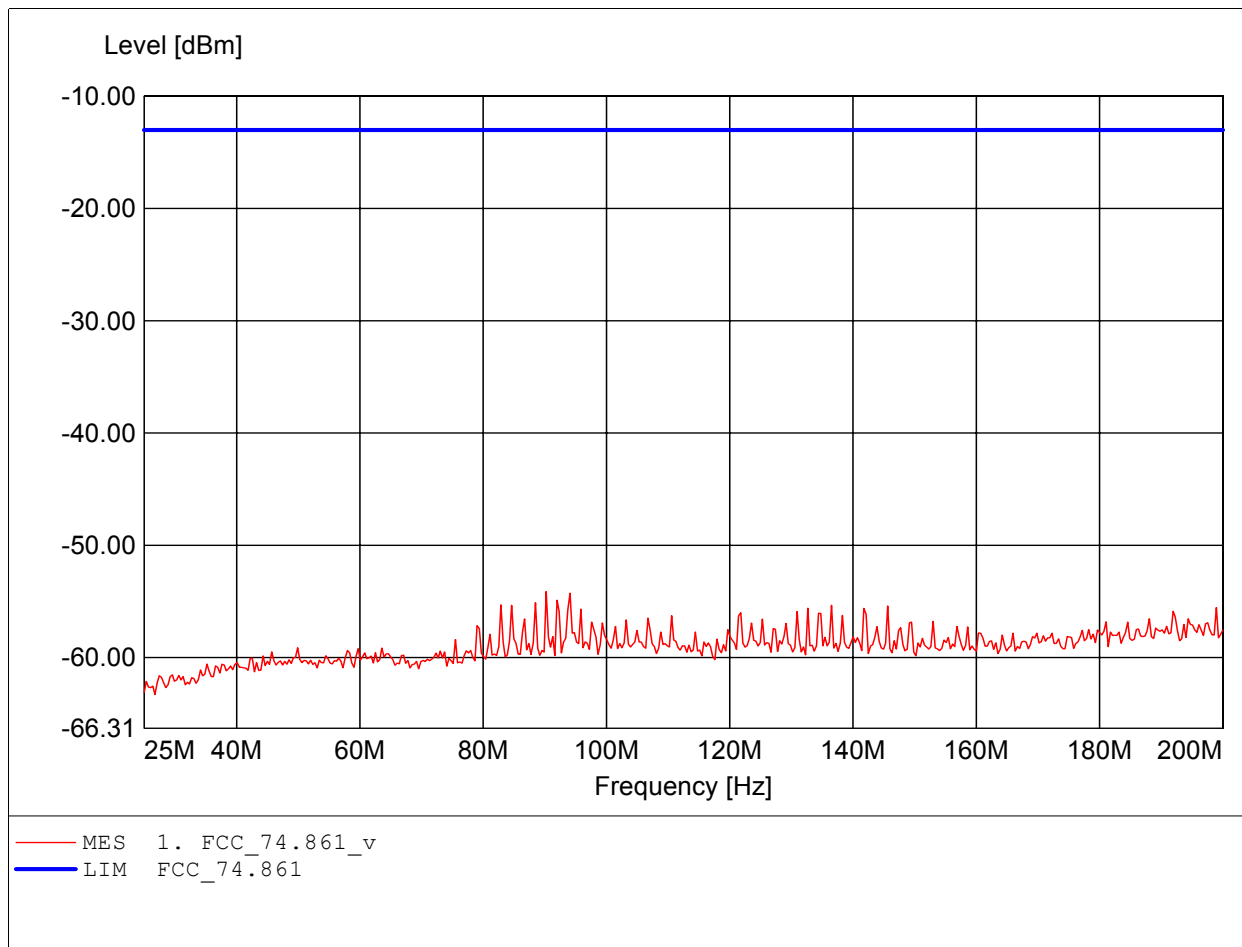

**Spurious emissions under normal conditions**

**in according to FCC Part 74.861**

EUT: Wireless Microphone Transmitter  
MODEL NO.: SM-6000 Low Channel  
Approval Holder: CHIAYO ELECTRONICS.,LTD.  
Test Site / Operator: ETS / Sander Huang  
Temperature/Voltage: Temp.: 23°C/ Unom.: 3VDC (1.5VDC x 2 battery)  
Test Specification: 74.861  
Comment 1: Dist.: 3m, Ant.: HK 116  
Freq:56.914MHz Pmax:-57.42dBm RBW: 100 kHz

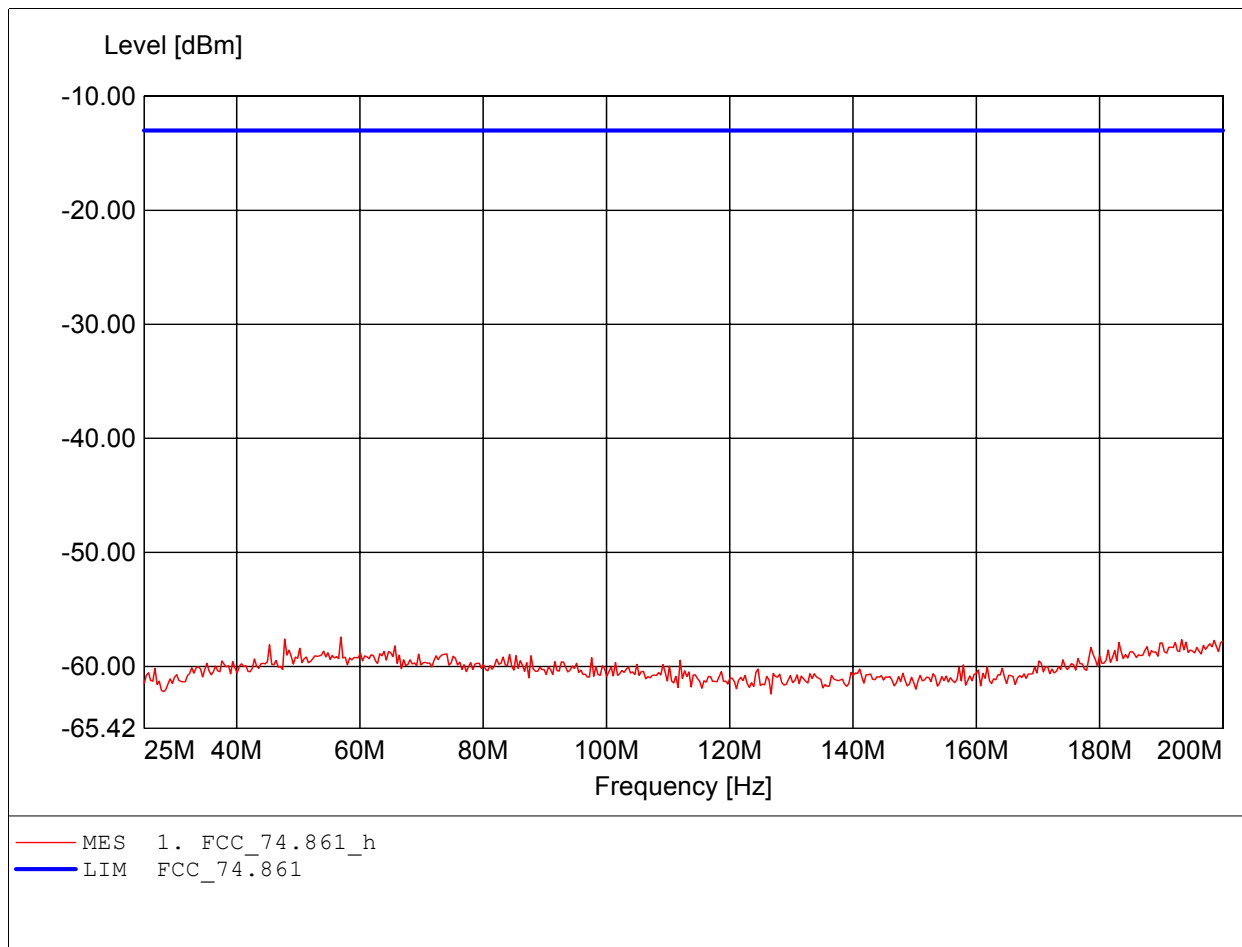



**Spurious emissions under normal conditions**

**in according to FCC Part 74.861**

EUT: Wireless Microphone Transmitter  
MODEL NO.: SM-6000 Low Channel  
Approval Holder: CHIAYO ELECTRONICS.,LTD.  
Test Site / Operator: ETS / Sander Huang  
Temperature/Voltage: Temp.: 23°C/ Unom.: 3VDC (1.5VDC x 2 battery)  
Test Specification: 74.861  
Comment 1: Dist.: 3m, Ant.: HL 223, ampl.: 0.1-1GHz  
Freq:615.230MHz Pmax:-57.15dBm RBW: 100 kHz

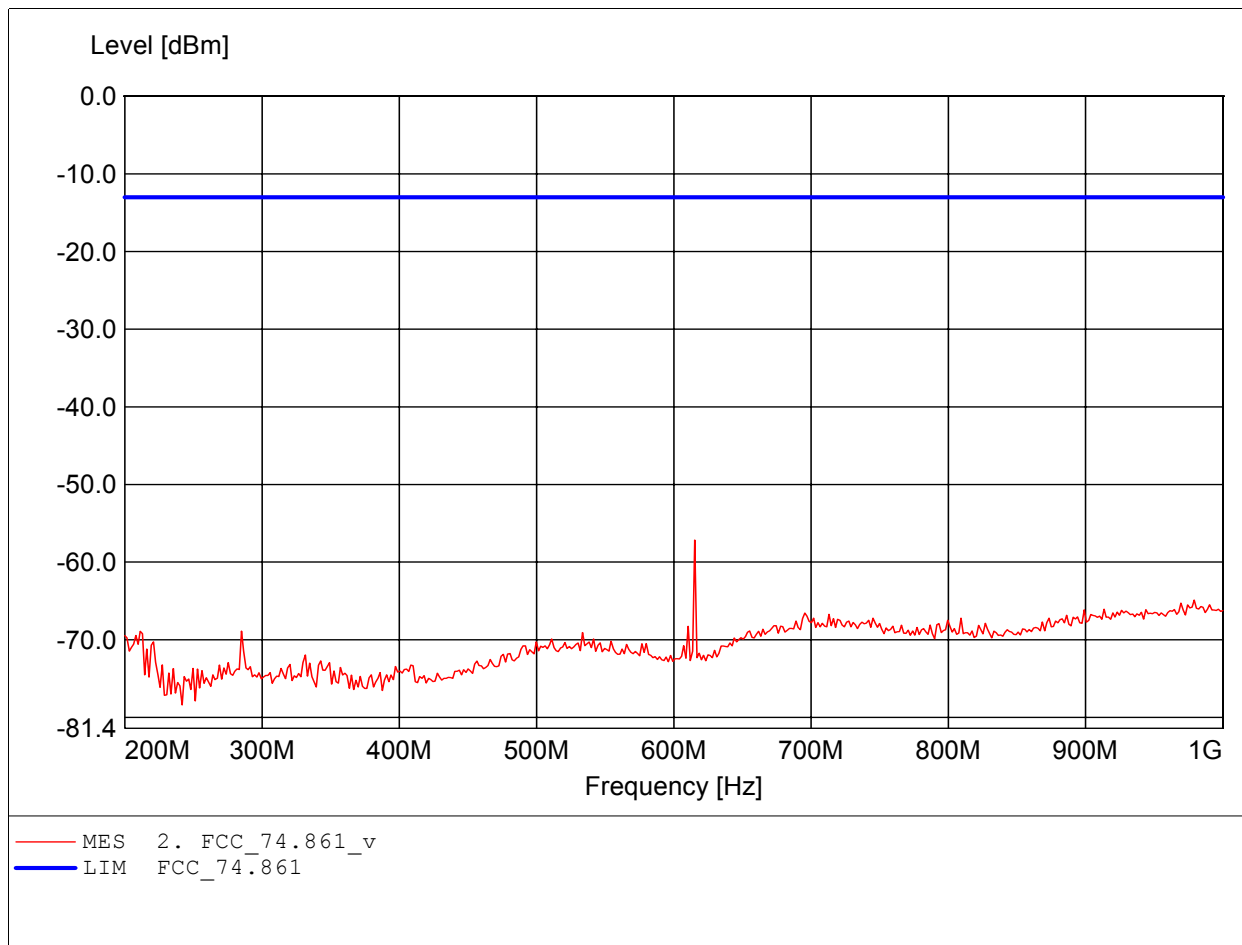

**Spurious emissions under normal conditions**

**in according to FCC Part 74.861**

EUT: Wireless Microphone Transmitter  
MODEL NO.: SM-6000 Low Channel  
Approval Holder: CHIAYO ELECTRONICS.,LTD.  
Test Site / Operator: ETS / Sander Huang  
Temperature/Voltage: Temp.: 23°C/ Unom.: 3VDC (1.5VDC x 2 battery)  
Test Specification: 74.861  
Comment 1: Dist.: 3m, Ant.: HL 223, ampl.: 0.1-1GHz  
Freq:615.230MHz Pmax:-47.97dBm RBW: 100 kHz

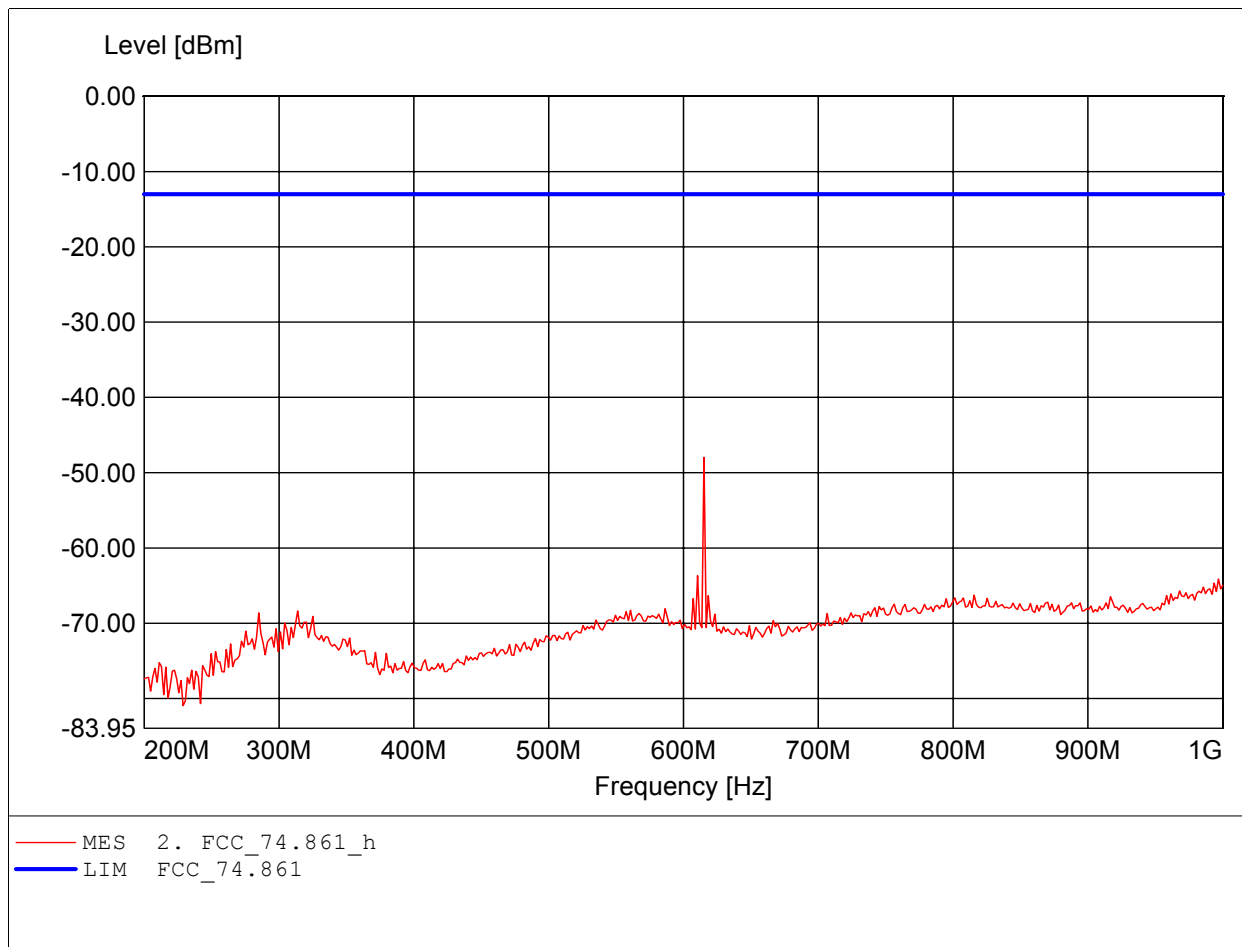

**Spurious emissions under normal conditions**

**in according to FCC Part 74.861**

EUT: Wireless Microphone Transmitter  
MODEL NO.: SM-6000 Low Channel  
Approval Holder: CHIAYO ELECTRONICS.,LTD.  
Test Site / Operator: ETS / Sander Huang  
Temperature/Voltage: Temp.: 23°C/ Unom.: 3VDC (1.5VDC x 2 battery)  
Test Specification: 74.861  
Comment 1: Dist.: 3m, Ant.: HL 025, ampl.: 1-4GHz  
Freq:1.228GHz Pmax:-32.69dBm RBW: 1 MHz

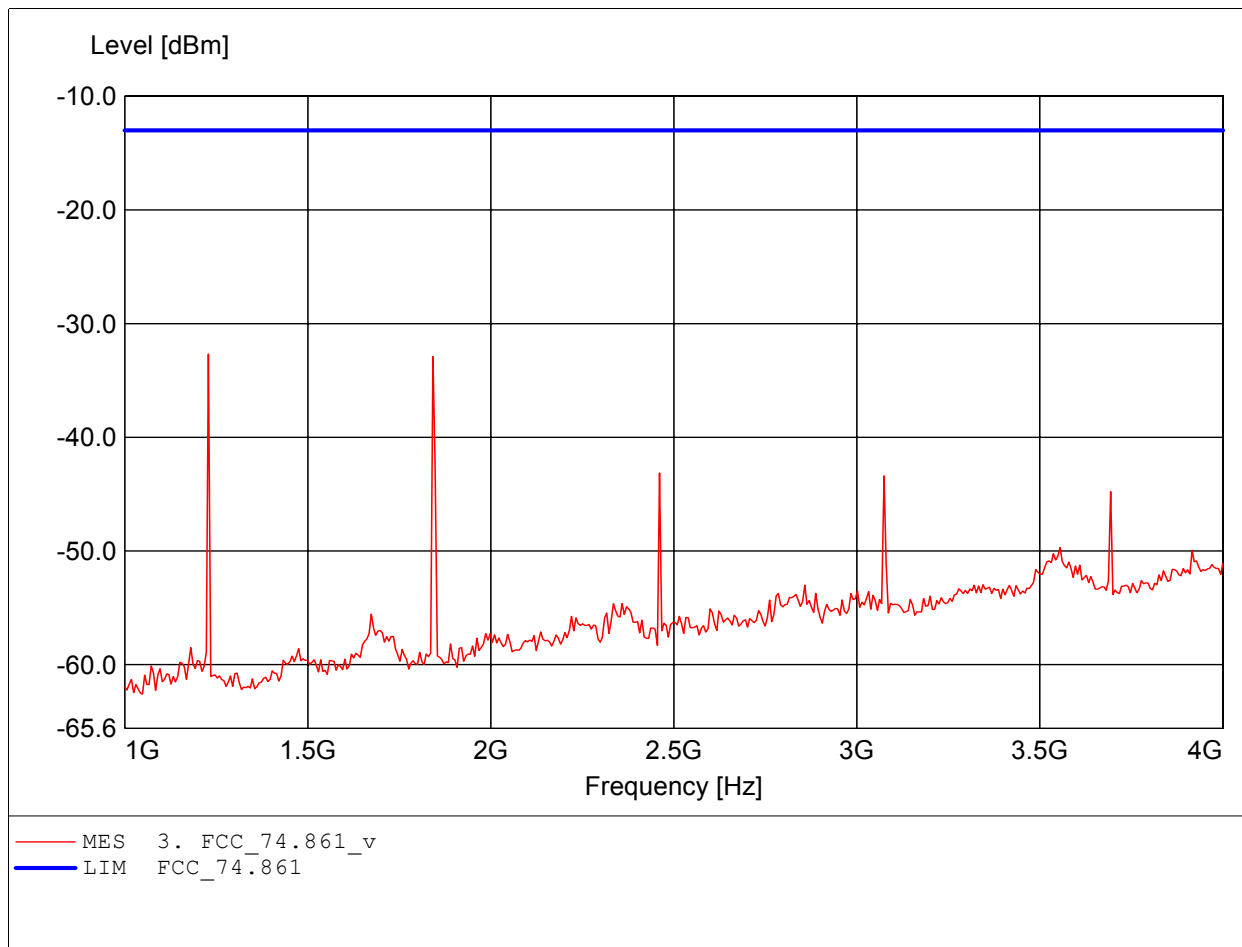

**Spurious emissions under normal conditions**

**in according to FCC Part 74.861**

EUT: Wireless Microphone Transmitter  
MODEL NO.: SM-6000 Low Channel  
Approval Holder: CHIAYO ELECTRONICS.,LTD.  
Test Site / Operator: ETS / Sander Huang  
Temperature/Voltage: Temp.: 23°C/ Unom.: 3VDC (1.5VDC x 2 battery)  
Test Specification: 74.861  
Comment 1: Dist.: 3m, Ant.: HL 025, ampl.: 1-4GHz  
Freq:1.842GHz Pmax:-24.45dBm RBW: 1 MHz

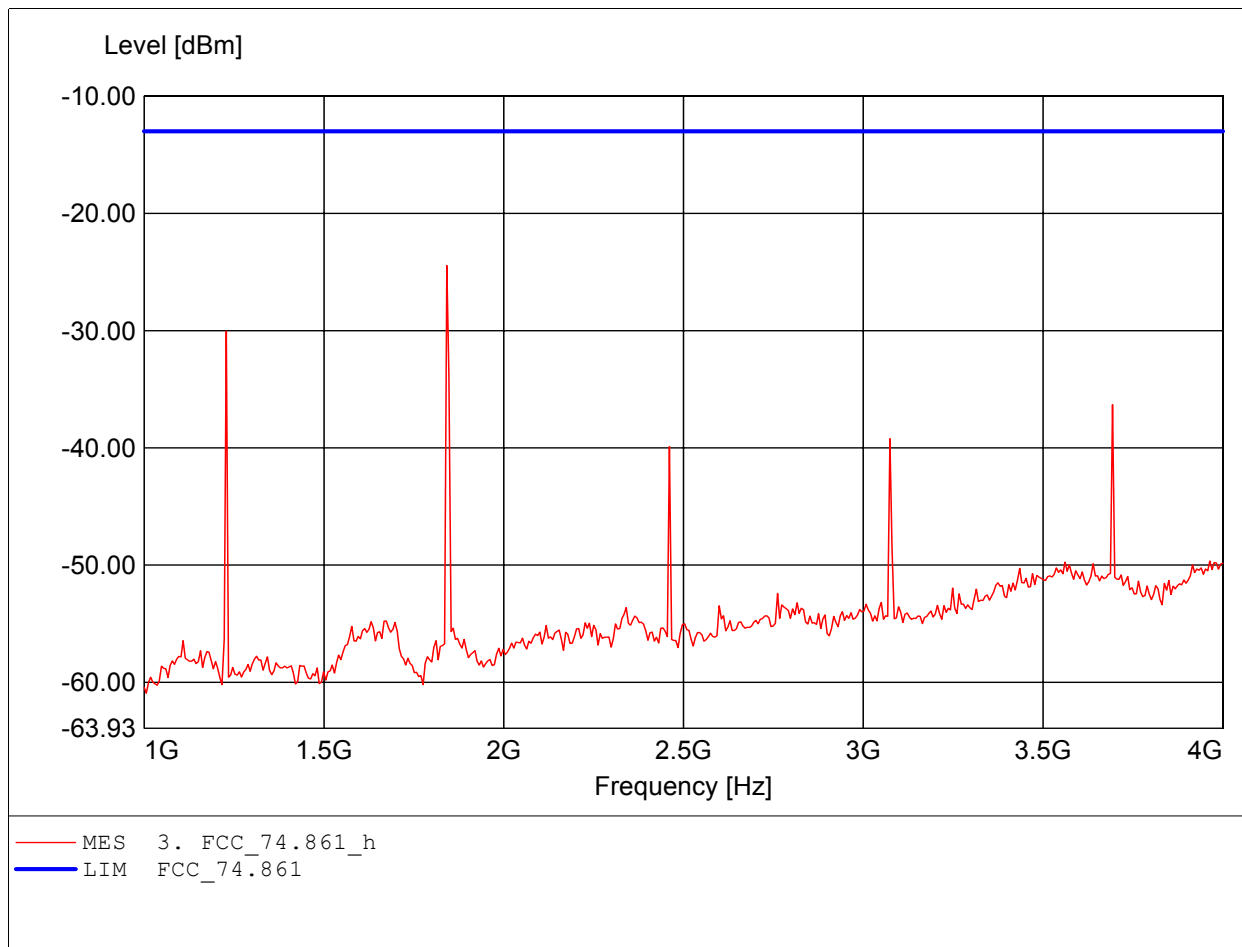

**Spurious emissions under normal conditions**

**in according to FCC Part 74.861**

EUT: Wireless Microphone Transmitter  
MODEL NO.: SM-6000 Low Channel  
Approval Holder: CHIAYO ELECTRONICS.,LTD.  
Test Site / Operator: ETS / Sander Huang  
Temperature/Voltage: Temp.: 23°C/ Unom.: 3VDC (1.5VDC x 2 battery)  
Test Specification: 74.861  
Comment 1: Dist.: 1m, Ant.: HL 025, ampl.: 4-8GHz  
Freq:4.305GHz Pmax:-36.62dBm RBW: 1 MHz

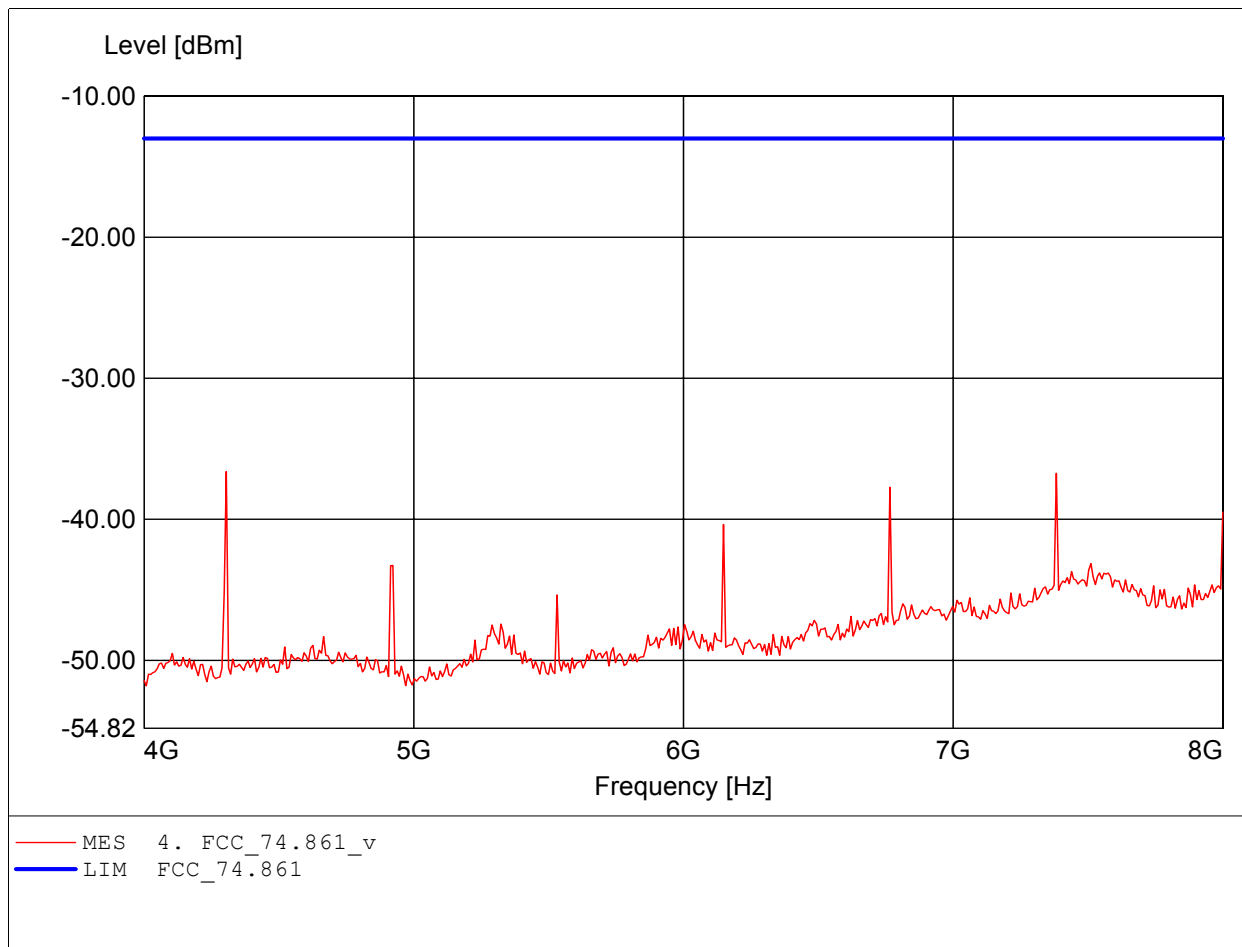

**Spurious emissions under normal conditions**

**in according to FCC Part 74.861**

EUT: Wireless Microphone Transmitter  
MODEL NO.: SM-6000 Low Channel  
Approval Holder: CHIAYO ELECTRONICS.,LTD.  
Test Site / Operator: ETS / Sander Huang  
Temperature/Voltage: Temp.: 23°C/ Unom.: 3VDC (1.5VDC x 2 battery)  
Test Specification: 74.861  
Comment 1: Dist.: 1m, Ant.: HL 025, ampl.: 4-8GHz  
Freq:7.383GHz Pmax:-32.20dBm RBW: 1 MHz

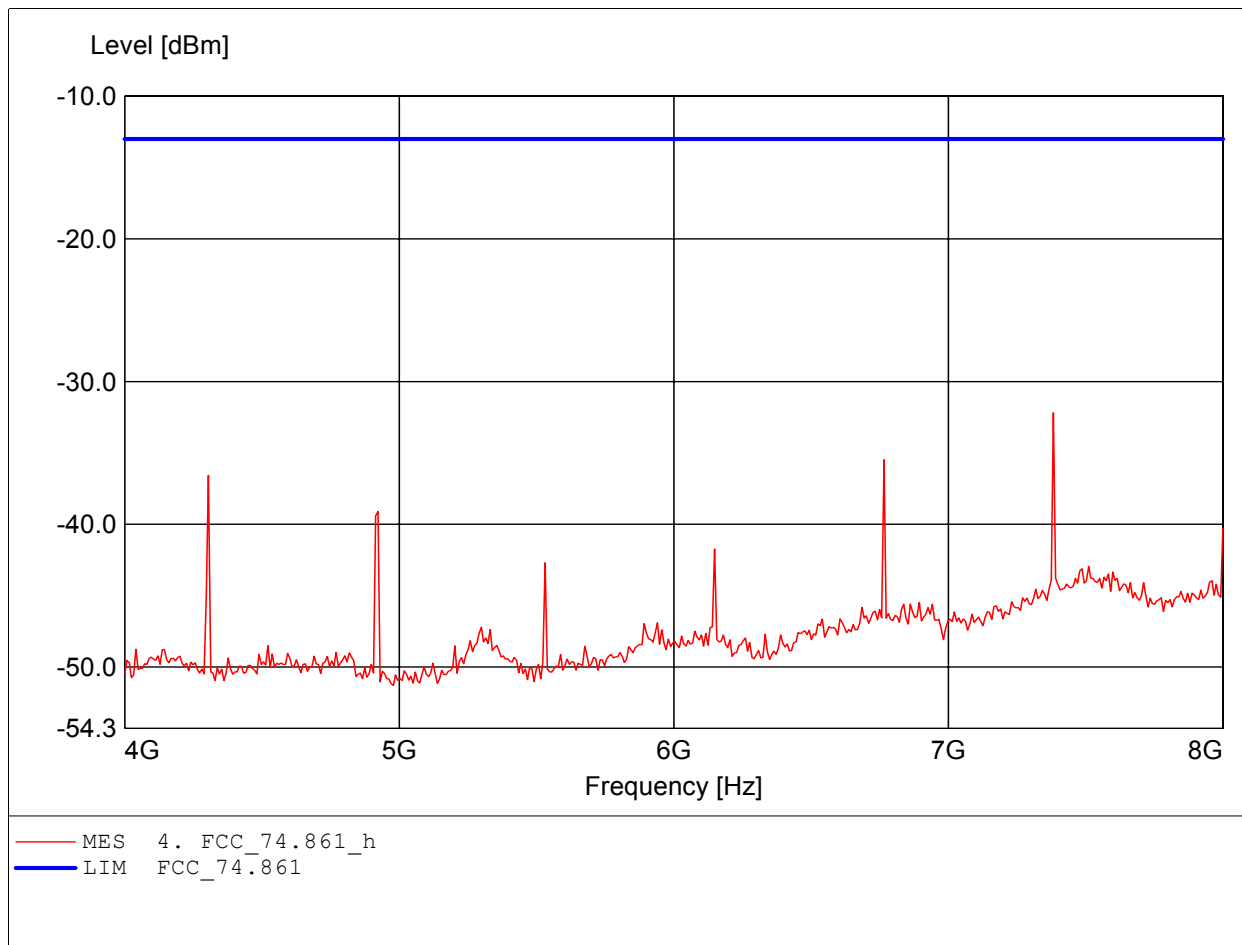

**Spurious emissions under normal conditions**

**in according to FCC Part 74.861**

EUT: Wireless Microphone Transmitter  
MODEL NO.: SM-6000 Low Channel  
Approval Holder: CHIAYO ELECTRONICS.,LTD.  
Test Site / Operator: ETS / Sander Huang  
Temperature/Voltage: Temp.: 23°C/ Unom.: 3VDC (1.5VDC x 2 battery)  
Test Specification: 74.861  
Comment 1: Dist.: 1m, Ant.: HL 025, ampl.: 8-18GHz  
Freq:12.228GHz Pmax:-34.31dBm RBW: 1 MHz

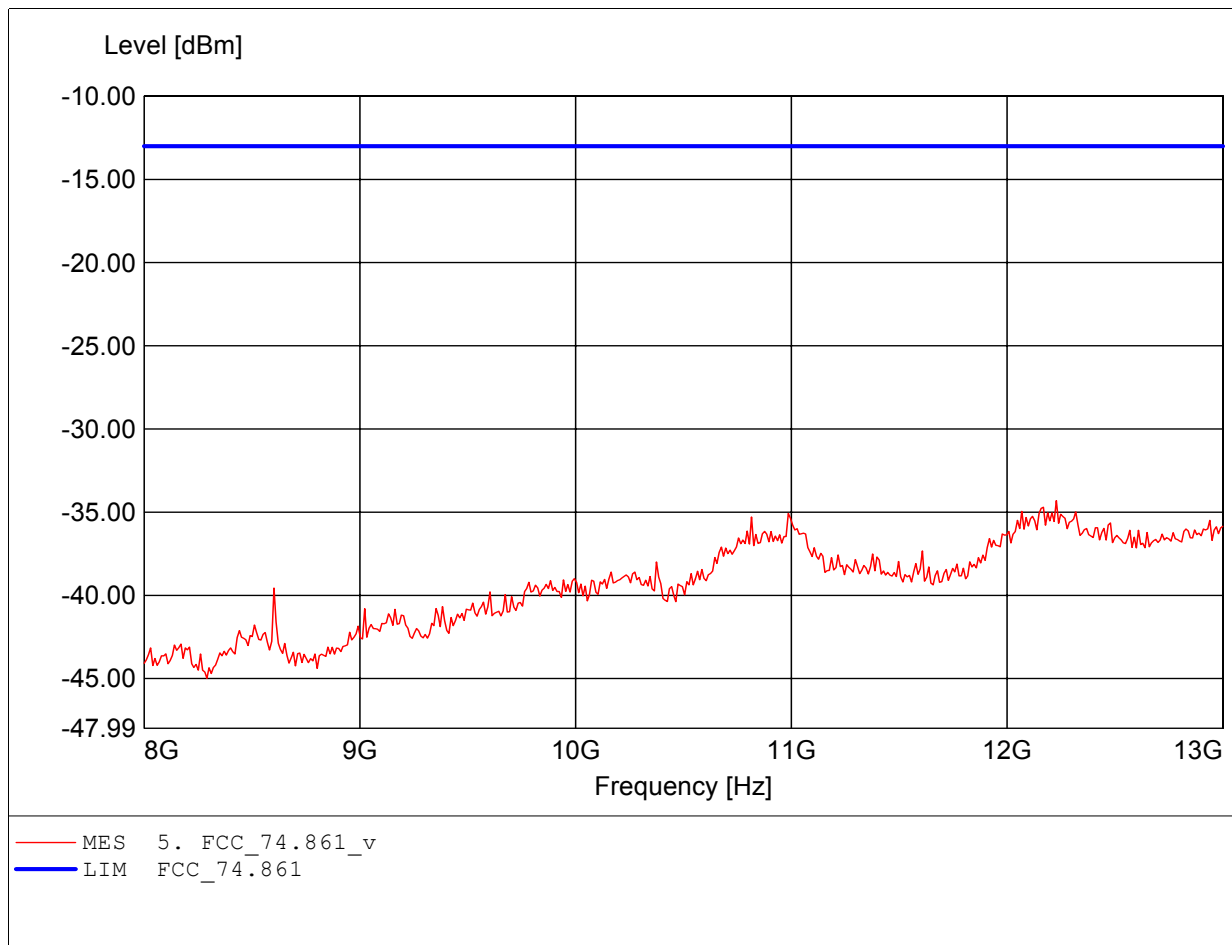

**Spurious emissions under normal conditions**

**in according to FCC Part 74.861**

EUT: Wireless Microphone Transmitter  
MODEL NO.: SM-6000 Low Channel  
Approval Holder: CHIAYO ELECTRONICS.,LTD.  
Test Site / Operator: ETS / Sander Huang  
Temperature/Voltage: Temp.: 23°C/ Unom.: 3VDC (1.5VDC x 2 battery)  
Test Specification: 74.861  
Comment 1: Dist.: 1m, Ant.: HL 025, ampl.: 8-18GHz  
Freq:12.098GHz Pmax:-34.84dBm RBW: 1 MHz

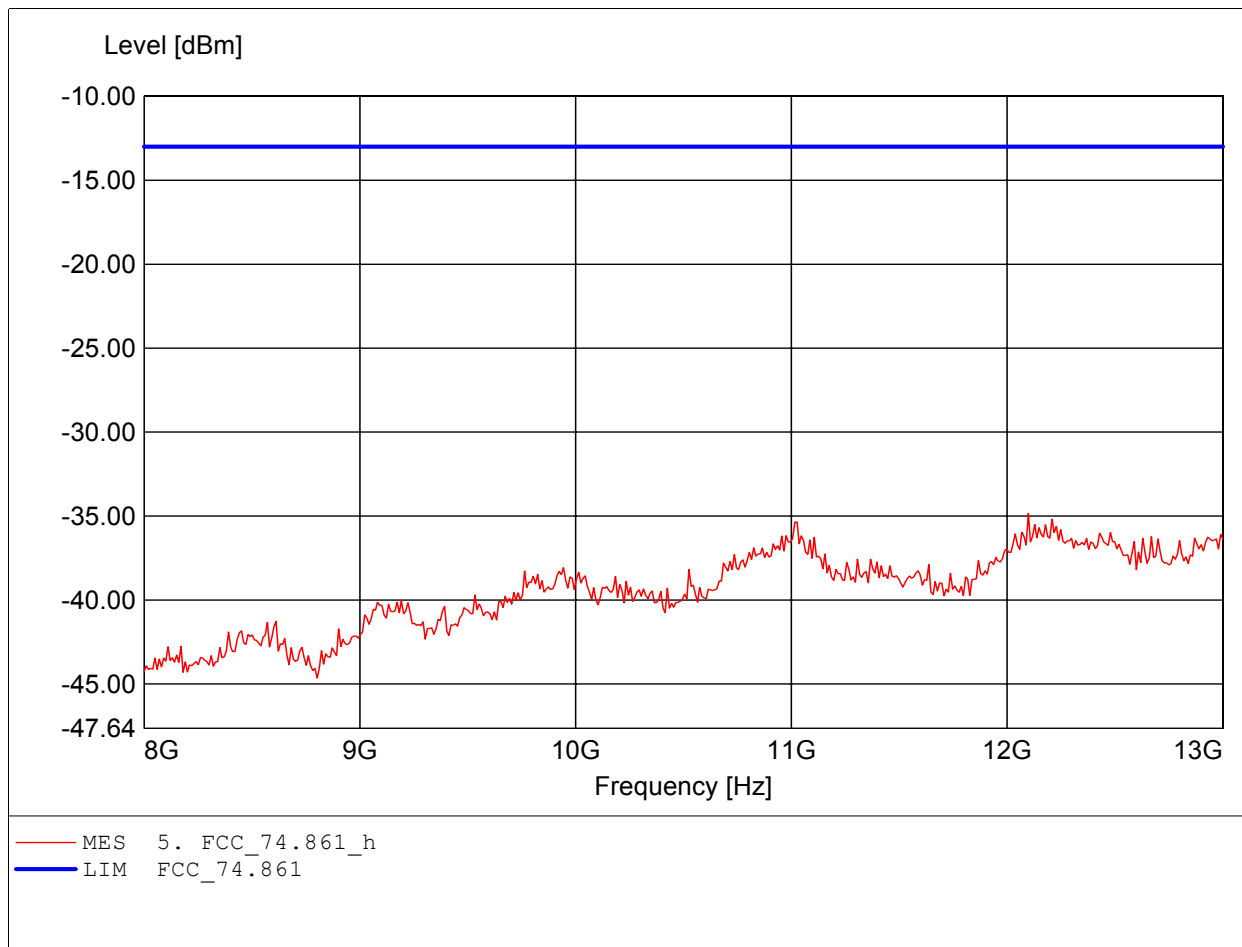



**Spurious emissions under normal conditions**

**in according to FCC Part 74.861**

EUT: Wireless Microphone Transmitter  
MODEL NO.: SM-6000 Middle Channel  
Approval Holder: CHIAYO ELECTRONICS.,LTD.  
Test Site / Operator: ETS / Sander Huang  
Temperature/Voltage: Temp.: 23°C/ Unom.: 3VDC (1.5VDC x 2 battery)  
Test Specification: 74.861  
Comment 1: Dist.: 3m, Ant.: HK 116  
Freq:94.088MHz Pmax:-53.44dBm RBW: 100 kHz

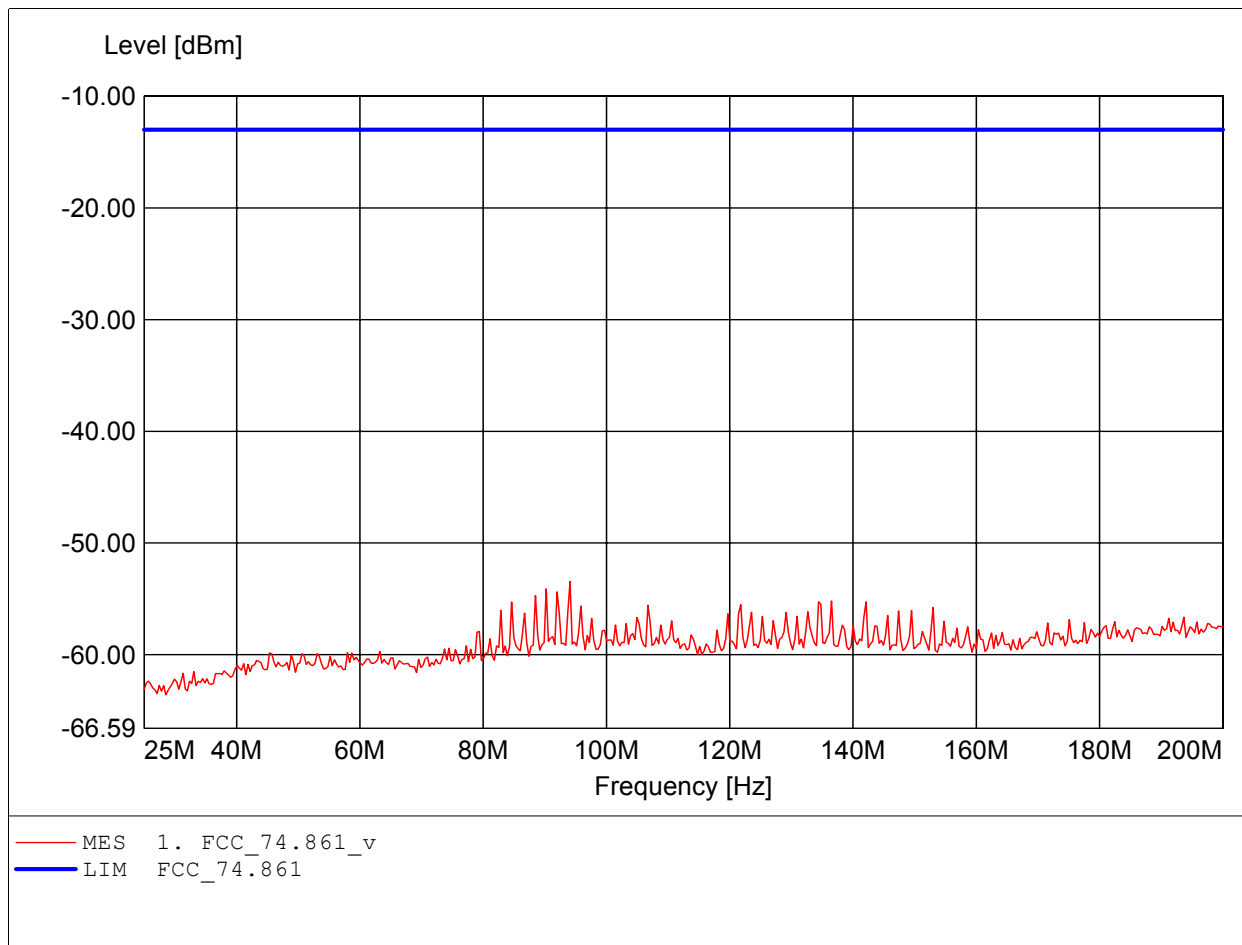

**Spurious emissions under normal conditions**

**in according to FCC Part 74.861**

EUT: Wireless Microphone Transmitter  
MODEL NO.: SM-6000 Middle Channel  
Approval Holder: CHIAYO ELECTRONICS.,LTD.  
Test Site / Operator: ETS / Sander Huang  
Temperature/Voltage: Temp.: 23°C/ Unom.: 3VDC (1.5VDC x 2 battery)  
Test Specification: 74.861  
Comment 1: Dist.: 3m, Ant.: HK 116  
Freq:196.844MHz Pmax:-57.30dBm RBW: 100 kHz

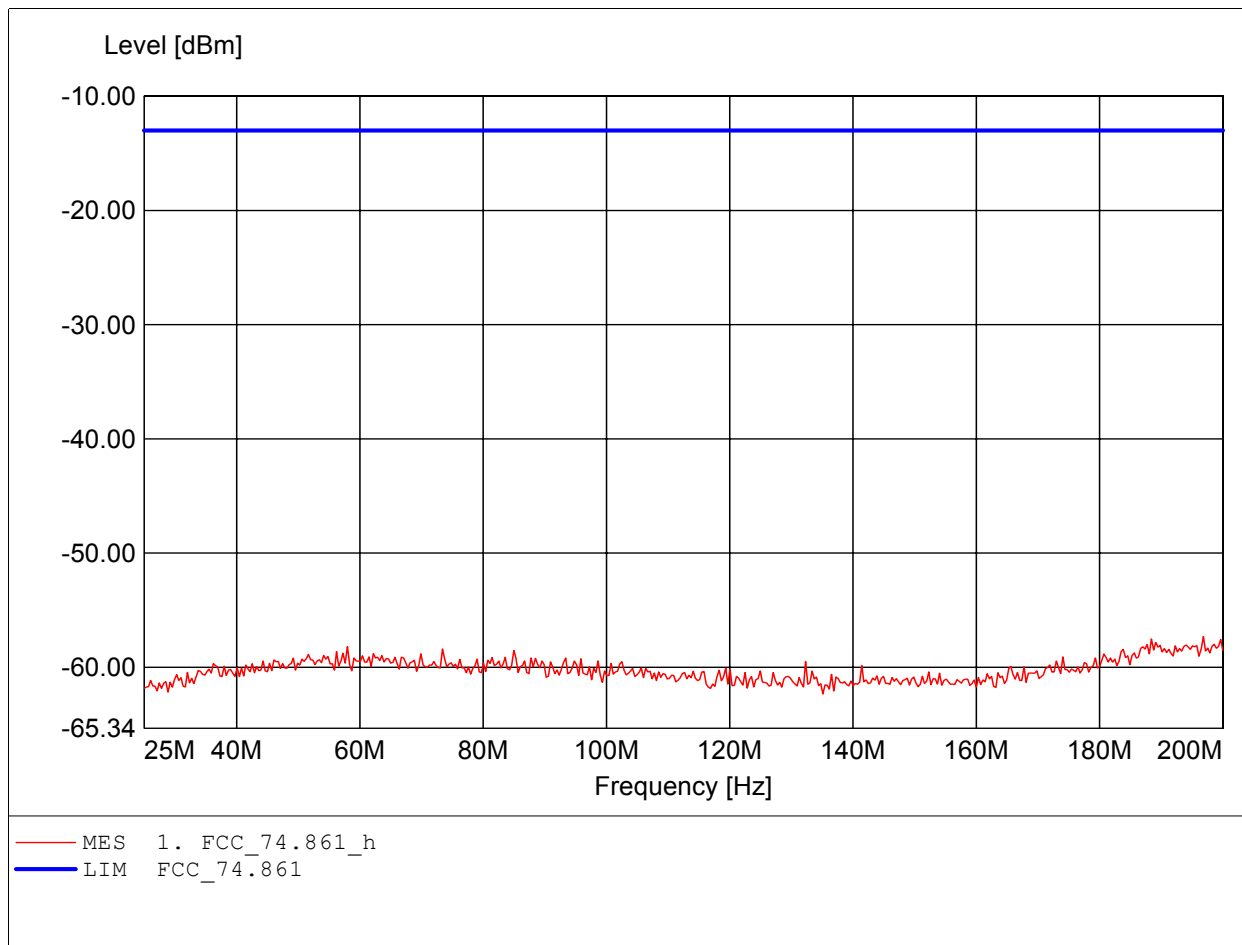

**Spurious emissions under normal conditions**

**in according to FCC Part 74.861**

EUT: Wireless Microphone Transmitter  
MODEL NO.: SM-6000 Middle Channel  
Approval Holder: CHIAYO ELECTRONICS.,LTD.  
Test Site / Operator: ETS / Sander Huang  
Temperature/Voltage: Temp.: 23°C/ Unom.: 3VDC (1.5VDC x 2 battery)  
Test Specification: 74.861  
Comment 1: Dist.: 3m, Ant.: HL 223, ampl.: 0.1-1GHz  
Freq:709.820MHz Pmax:-52.88dBm RBW: 100 kHz

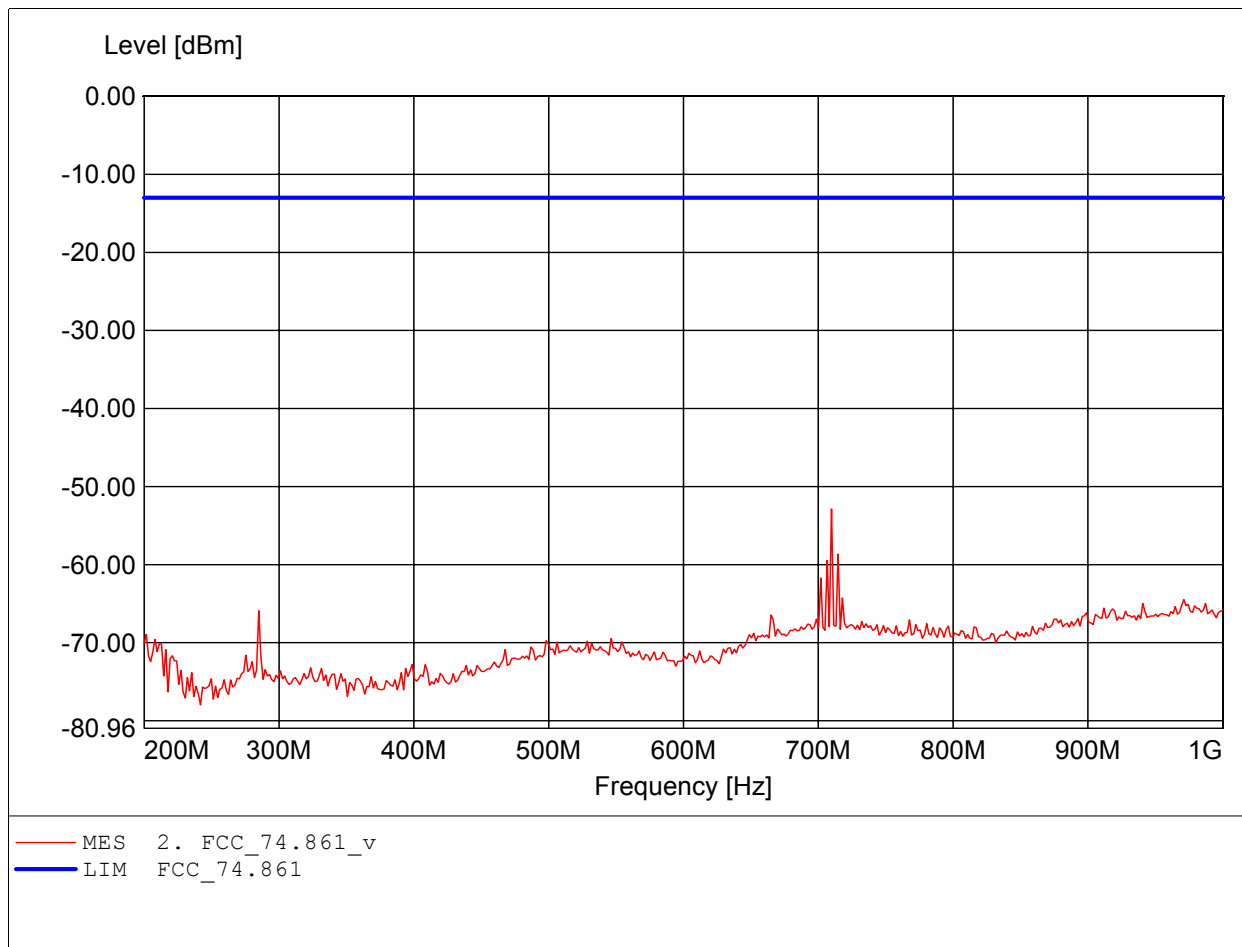

**Spurious emissions under normal conditions**

**in according to FCC Part 74.861**

EUT: Wireless Microphone Transmitter  
MODEL NO.: SM-6000 Middle Channel  
Approval Holder: CHIAYO ELECTRONICS.,LTD.  
Test Site / Operator: ETS / Sander Huang  
Temperature/Voltage: Temp.: 23°C/ Unom.: 3VDC (1.5VDC x 2 battery)  
Test Specification: 74.861  
Comment 1: Dist.: 3m, Ant.: HL 223, ampl.: 0.1-1GHz  
Freq:709.820MHz Pmax:-50.19dBm RBW: 100 kHz

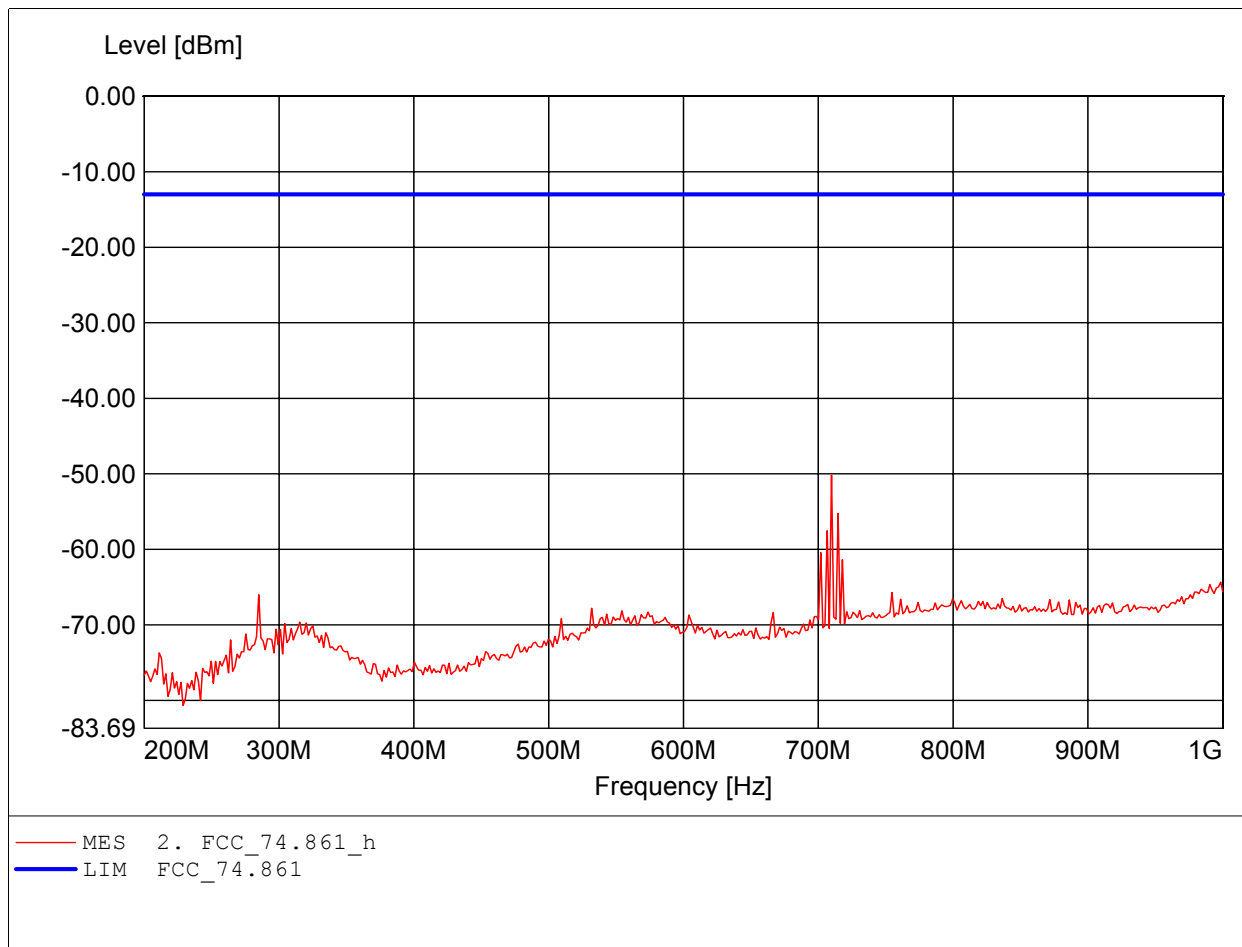

**Spurious emissions under normal conditions**

**in according to FCC Part 74.861**

EUT: Wireless Microphone Transmitter  
MODEL NO.: SM-6000 Middle Channel  
Approval Holder: CHIAYO ELECTRONICS.,LTD.  
Test Site / Operator: ETS / Sander Huang  
Temperature/Voltage: Temp.: 23°C/ Unom.: 3VDC (1.5VDC x 2 battery)  
Test Specification: 74.861  
Comment 1: Dist.: 3m, Ant.: HL 025, ampl.: 1-4GHz  
Freq:3.549GHz Pmax:-29.15dBm RBW: 1 MHz

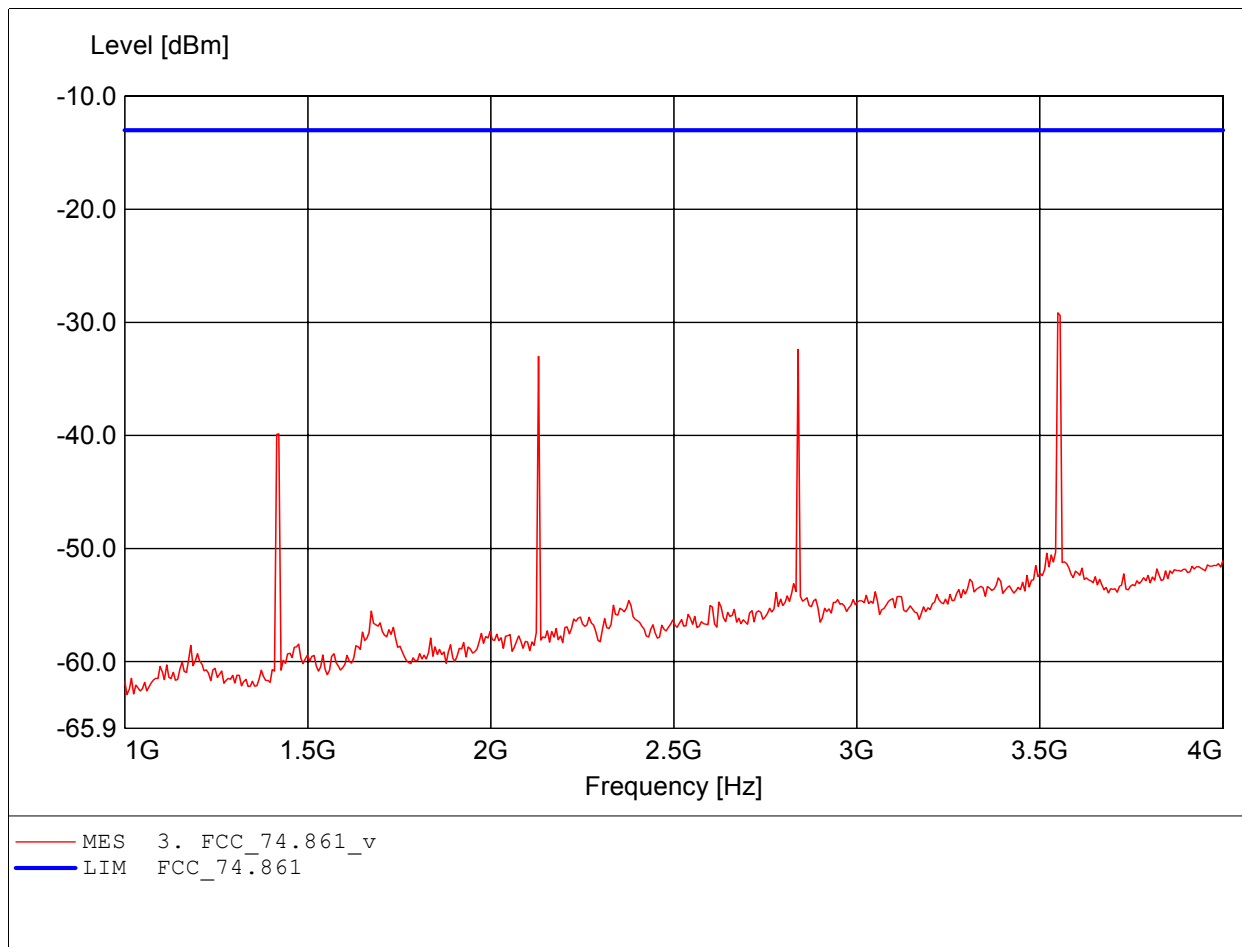

**Spurious emissions under normal conditions**

**in according to FCC Part 74.861**

EUT: Wireless Microphone Transmitter  
MODEL NO.: SM-6000 Middle Channel  
Approval Holder: CHIAYO ELECTRONICS.,LTD.  
Test Site / Operator: ETS / Sander Huang  
Temperature/Voltage: Temp.: 23°C/ Unom.: 3VDC (1.5VDC x 2 battery)  
Test Specification: 74.861  
Comment 1: Dist.: 3m, Ant.: HL 025, ampl.: 1-4GHz  
Freq:3.549GHz Pmax:-24.48dBm RBW: 1 MHz

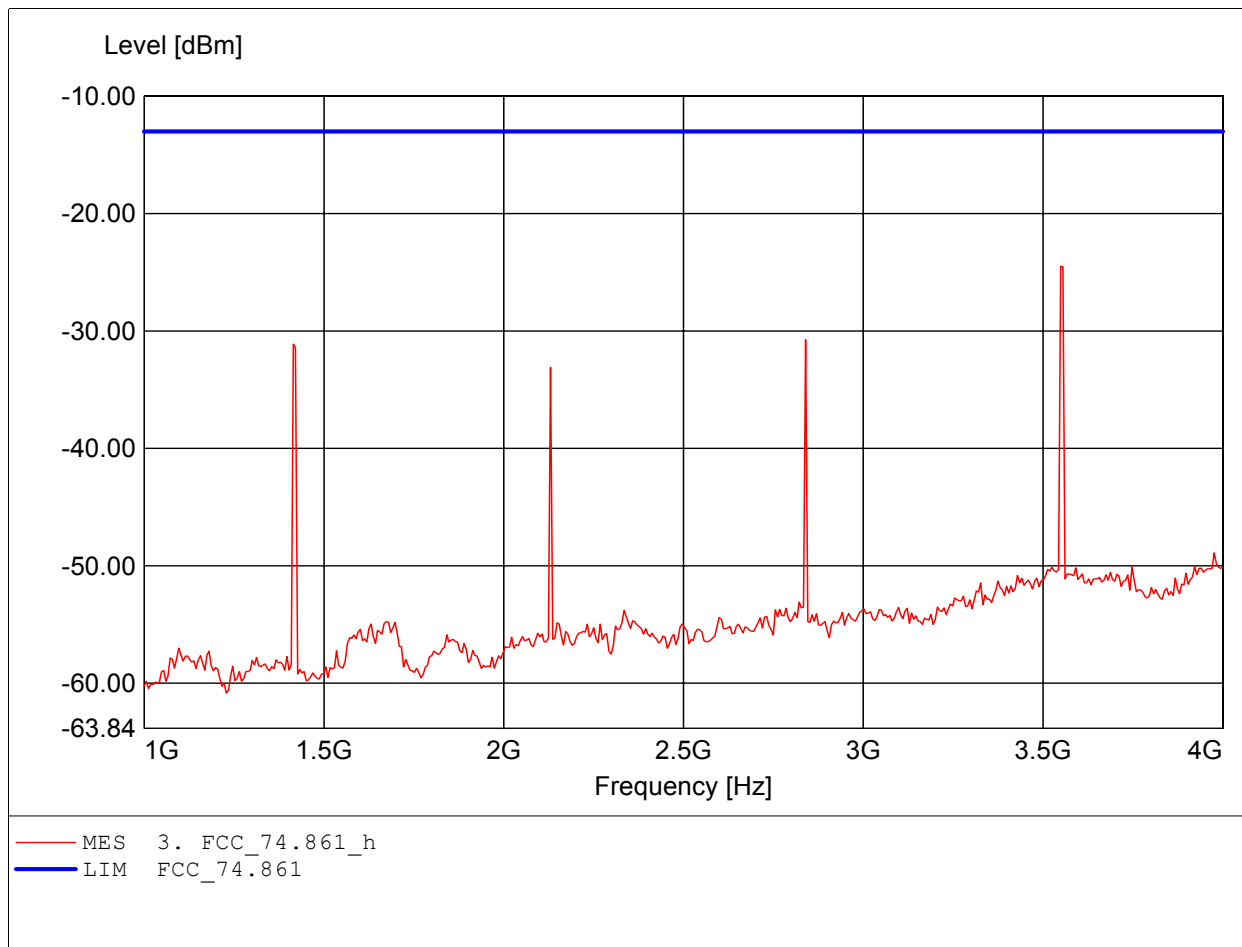

**Spurious emissions under normal conditions**

**in according to FCC Part 74.861**

EUT: Wireless Microphone Transmitter  
MODEL NO.: SM-6000 Middle Channel  
Approval Holder: CHIAYO ELECTRONICS.,LTD.  
Test Site / Operator: ETS / Sander Huang  
Temperature/Voltage: Temp.: 23°C/ Unom.: 3VDC (1.5VDC x 2 battery)  
Test Specification: 74.861  
Comment 1: Dist.: 1m, Ant.: HL 025, ampl.: 4-8GHz  
Freq:4.257GHz Pmax:-32.09dBm RBW: 1 MHz

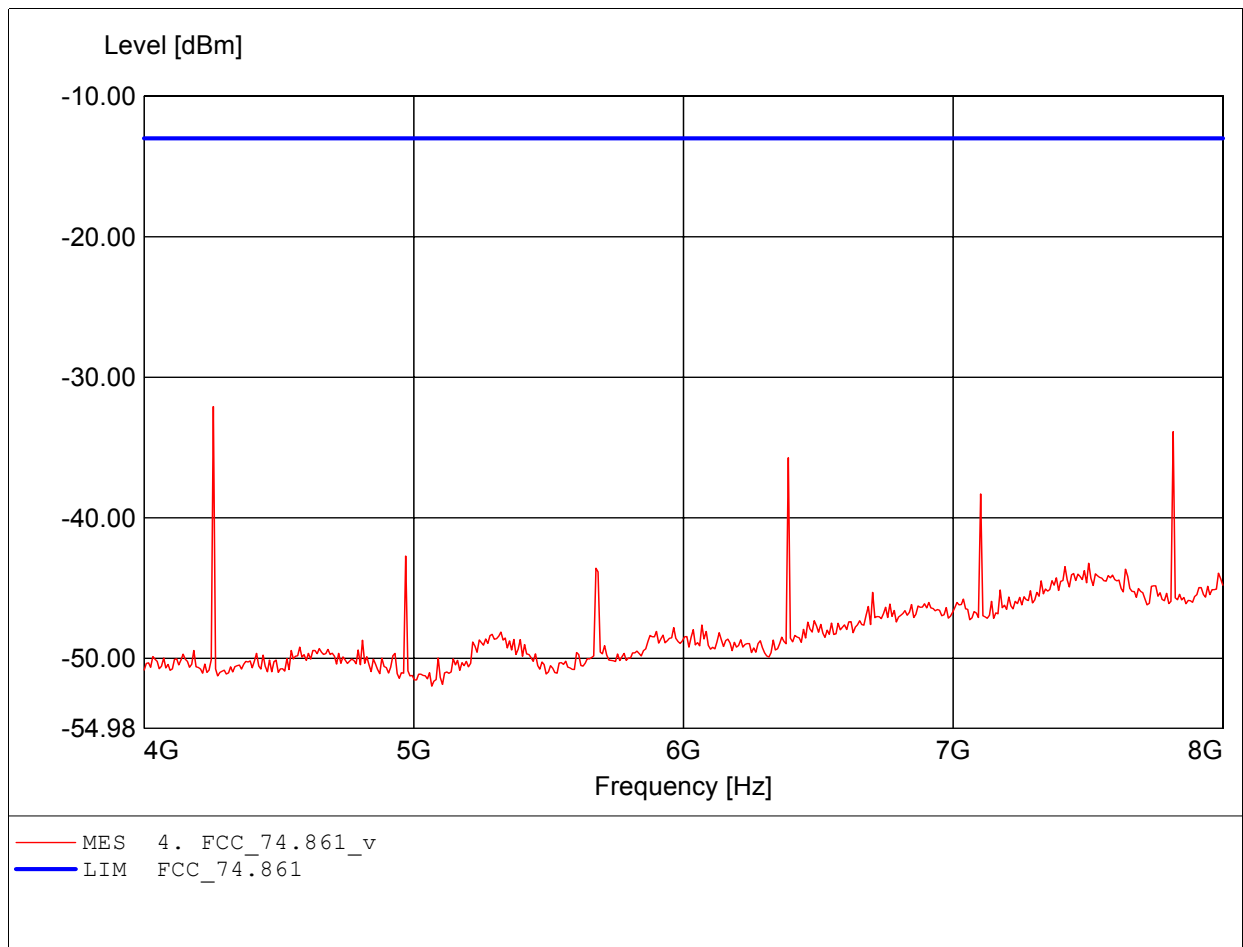

**Spurious emissions under normal conditions**

**in according to FCC Part 74.861**

EUT: Wireless Microphone Transmitter  
MODEL NO.: SM-6000 Middle Channel  
Approval Holder: CHIAYO ELECTRONICS.,LTD.  
Test Site / Operator: ETS / Sander Huang  
Temperature/Voltage: Temp.: 23°C/ Unom.: 3VDC (1.5VDC x 2 battery)  
Test Specification: 74.861  
Comment 1: Dist.: 1m, Ant.: HL 025, ampl.: 4-8GHz  
Freq:4.257GHz Pmax:-28.25dBm RBW: 1 MHz

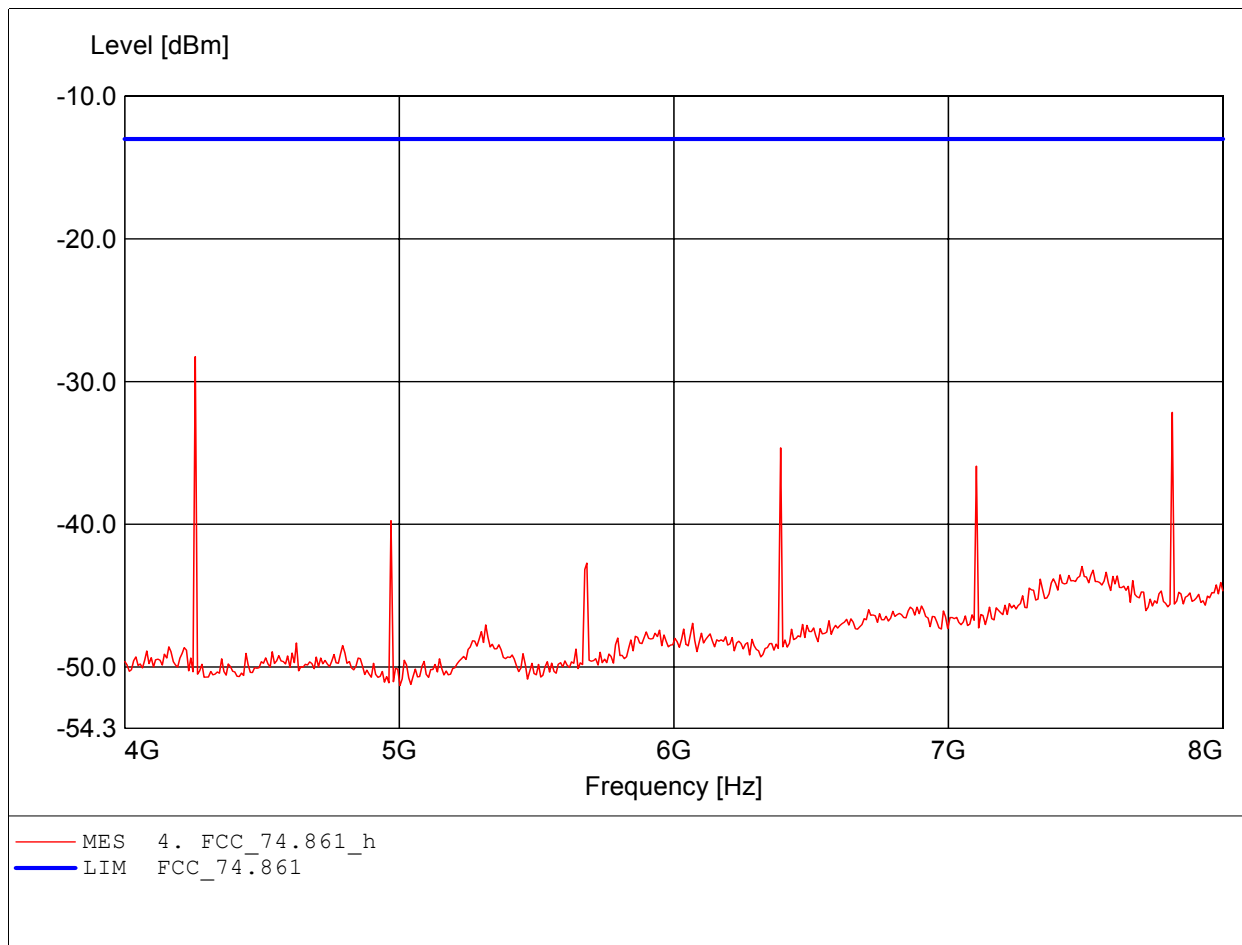



**Spurious emissions under normal conditions**

**in according to FCC Part 74.861**

EUT: Wireless Microphone Transmitter  
MODEL NO.: SM-6000 Middle Channel  
Approval Holder: CHIAYO ELECTRONICS.,LTD.  
Test Site / Operator: ETS / Sander Huang  
Temperature/Voltage: Temp.: 23°C/ Unom.: 3VDC (1.5VDC x 2 battery)  
Test Specification: 74.861  
Comment 1: Dist.: 1m, Ant.: HL 025, ampl.: 8-18GHz  
Freq:8.511GHz Pmax:-33.27dBm RBW: 1 MHz

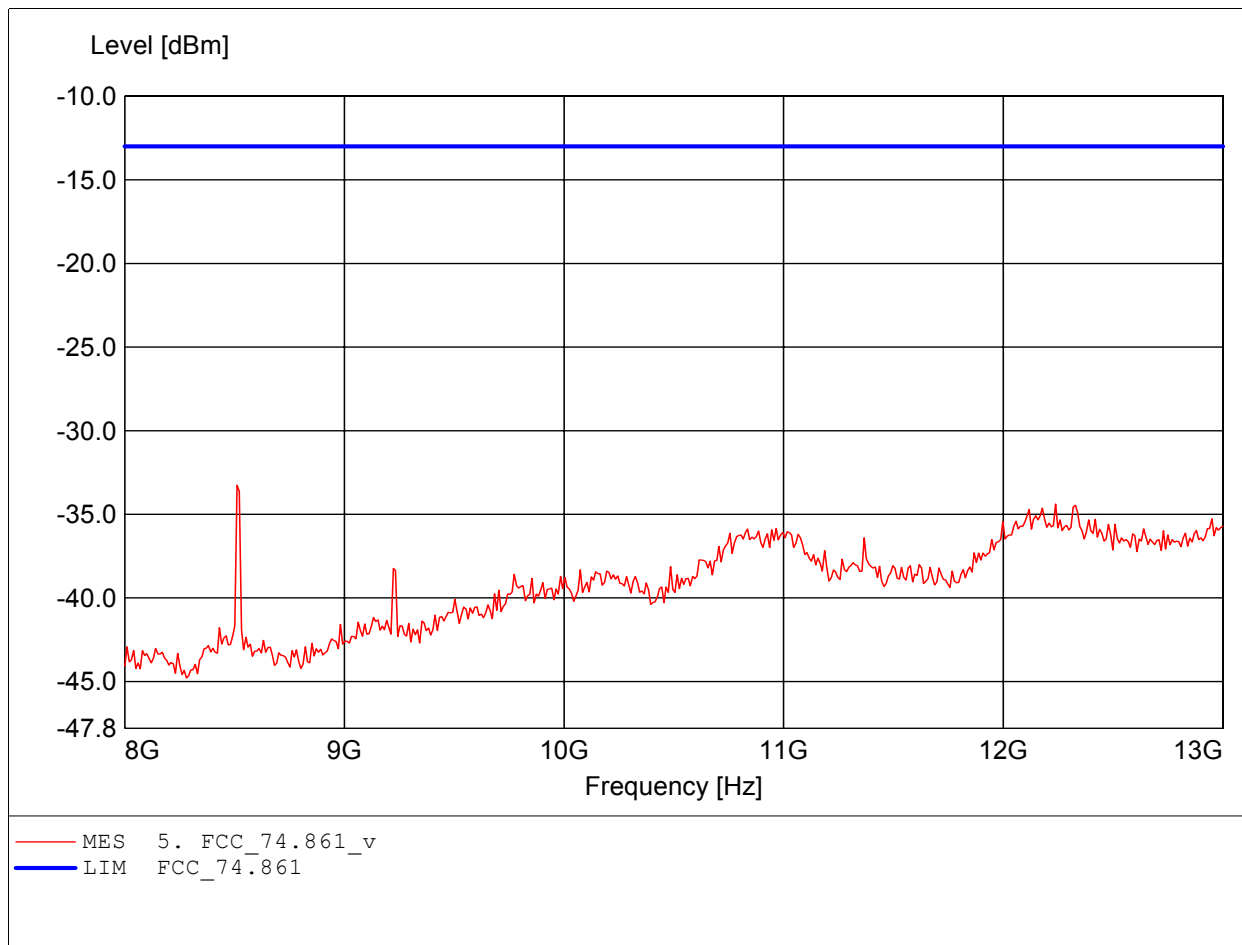

**Spurious emissions under normal conditions**

**in according to FCC Part 74.861**

EUT: Wireless Microphone Transmitter  
MODEL NO.: SM-6000 Middle Channel  
Approval Holder: CHIAYO ELECTRONICS.,LTD.  
Test Site / Operator: ETS / Sander Huang  
Temperature/Voltage: Temp.: 23°C/ Unom.: 3VDC (1.5VDC x 2 battery)  
Test Specification: 74.861  
Comment 1: Dist.: 1m, Ant.: HL 025, ampl.: 8-18GHz  
Freq:8.521GHz Pmax:-34.41dBm RBW: 1 MHz

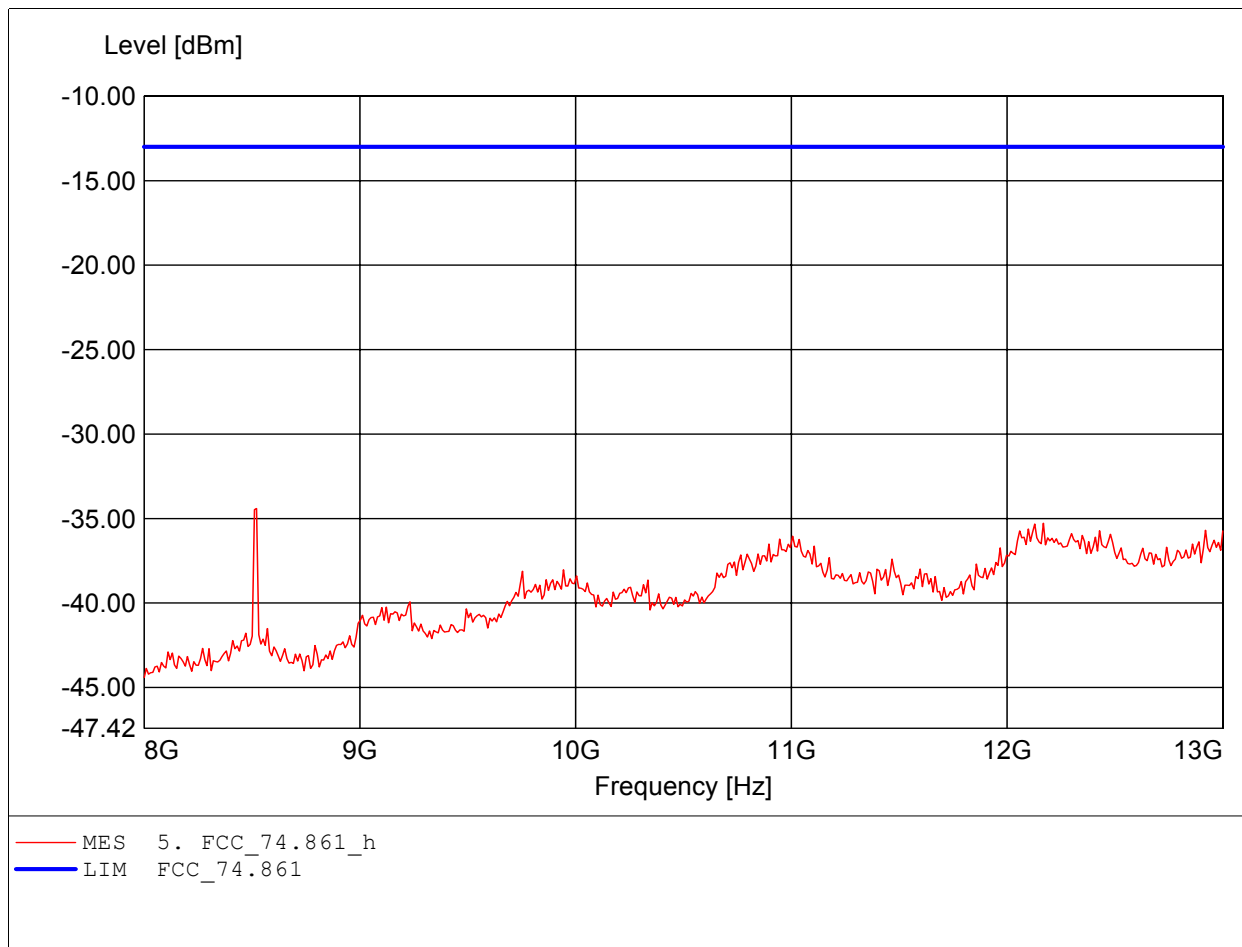

**Spurious emissions under normal conditions**

**in according to FCC Part 74.861**

EUT: Wireless Microphone Transmitter  
MODEL NO.: SM-6000 High Channel  
Approval Holder: CHIAYO ELECTRONICS.,LTD.  
Test Site / Operator: ETS / Sander Huang  
Temperature/Voltage: Temp.: 23°C/ Unom.: 3VDC (1.5VDC x 2 battery)  
Test Specification: 74.861  
Comment 1: Dist.: 3m, Ant.: HK 116  
Freq:94.088MHz Pmax:-53.76dBm RBW: 100 kHz

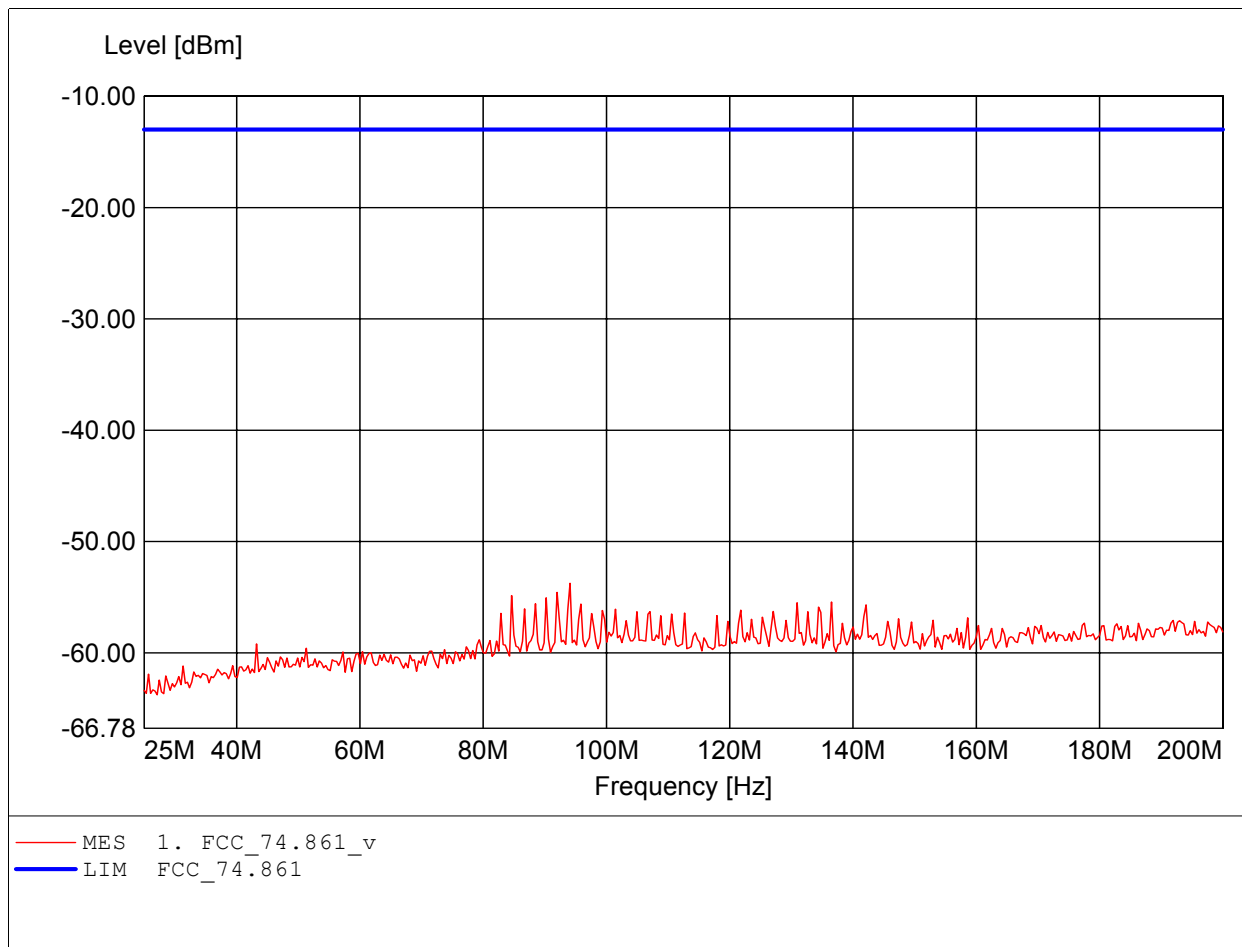

**Spurious emissions under normal conditions**

**in according to FCC Part 74.861**

EUT: Wireless Microphone Transmitter  
MODEL NO.: SM-6000 High Channel  
Approval Holder: CHIAYO ELECTRONICS.,LTD.  
Test Site / Operator: ETS / Sander Huang  
Temperature/Voltage: Temp.: 23°C/ Unom.: 3VDC (1.5VDC x 2 battery)  
Test Specification: 74.861  
Comment 1: Dist.: 3m, Ant.: HK 116  
Freq:199.649MHz Pmax:-56.80dBm RBW: 100 kHz

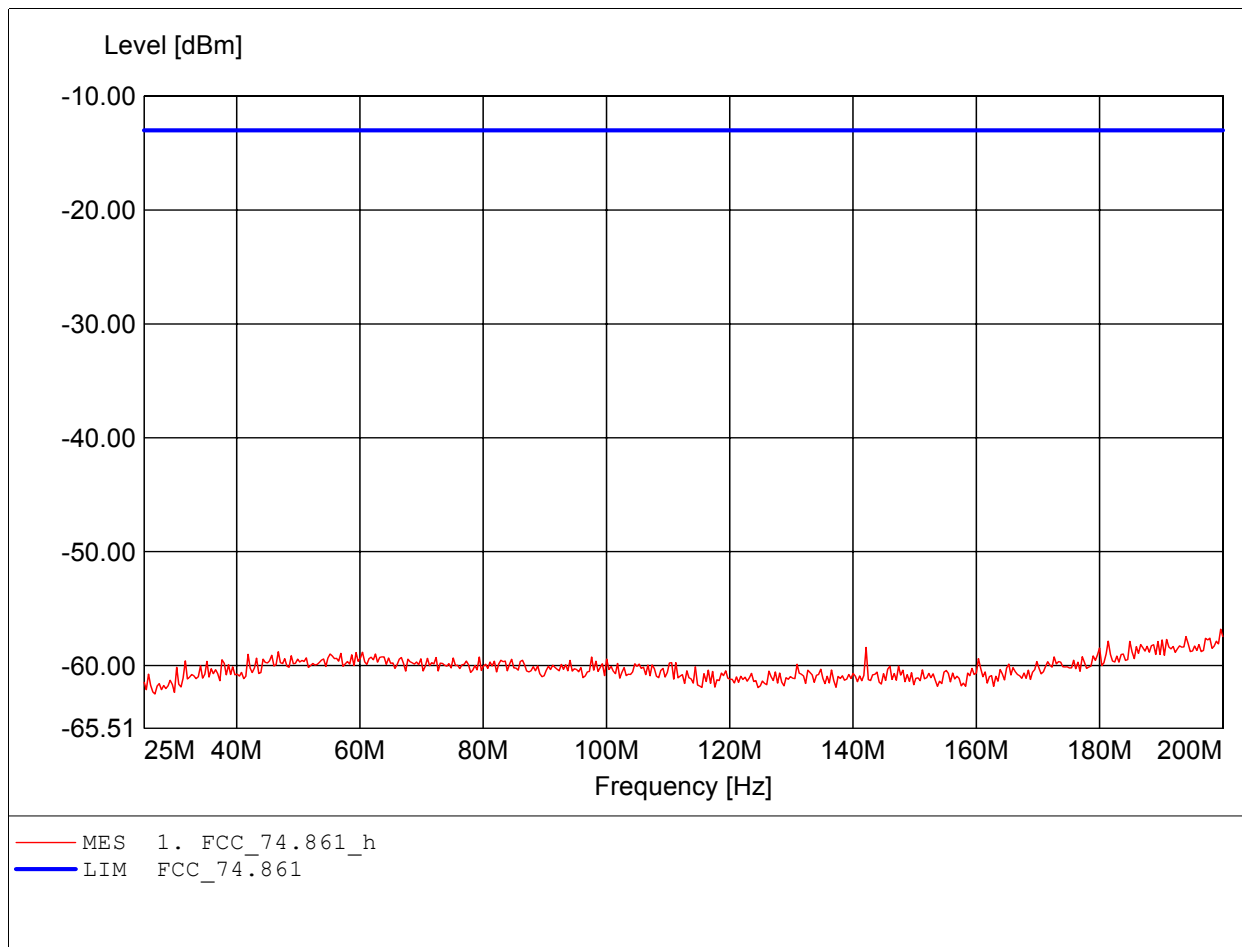

**Spurious emissions under normal conditions**

**in according to FCC Part 74.861**

EUT: Wireless Microphone Transmitter  
MODEL NO.: SM-6000 High Channel  
Approval Holder: CHIAYO ELECTRONICS.,LTD.  
Test Site / Operator: ETS / Sander Huang  
Temperature/Voltage: Temp.: 23°C/ Unom.: 3VDC (1.5VDC x 2 battery)  
Test Specification: 74.861  
Comment 1: Dist.: 3m, Ant.: HL 223, ampl.: 0.1-1GHz  
Freq:810.822MHz Pmax:-53.62dBm RBW: 100 kHz

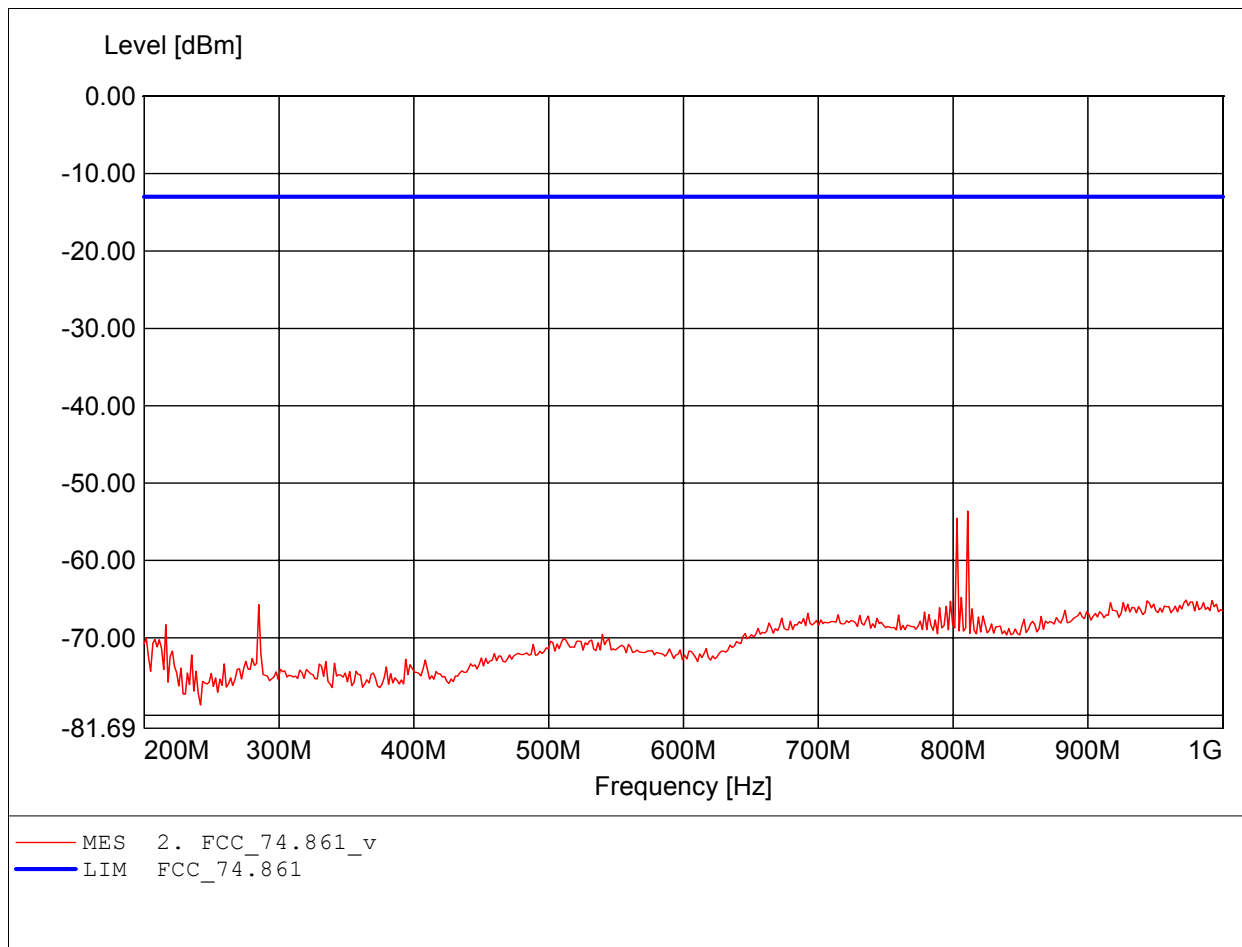

**Spurious emissions under normal conditions**

**in according to FCC Part 74.861**

EUT: Wireless Microphone Transmitter  
MODEL NO.: SM-6000 High Channel  
Approval Holder: CHIAYO ELECTRONICS.,LTD.  
Test Site / Operator: ETS / Sander Huang  
Temperature/Voltage: Temp.: 23°C/ Unom.: 3VDC (1.5VDC x 2 battery)  
Test Specification: 74.861  
Comment 1: Dist.: 3m, Ant.: HL 223, ampl.: 0.1-1GHz  
Freq:810.822MHz Pmax:-48.04dBm RBW: 100 kHz

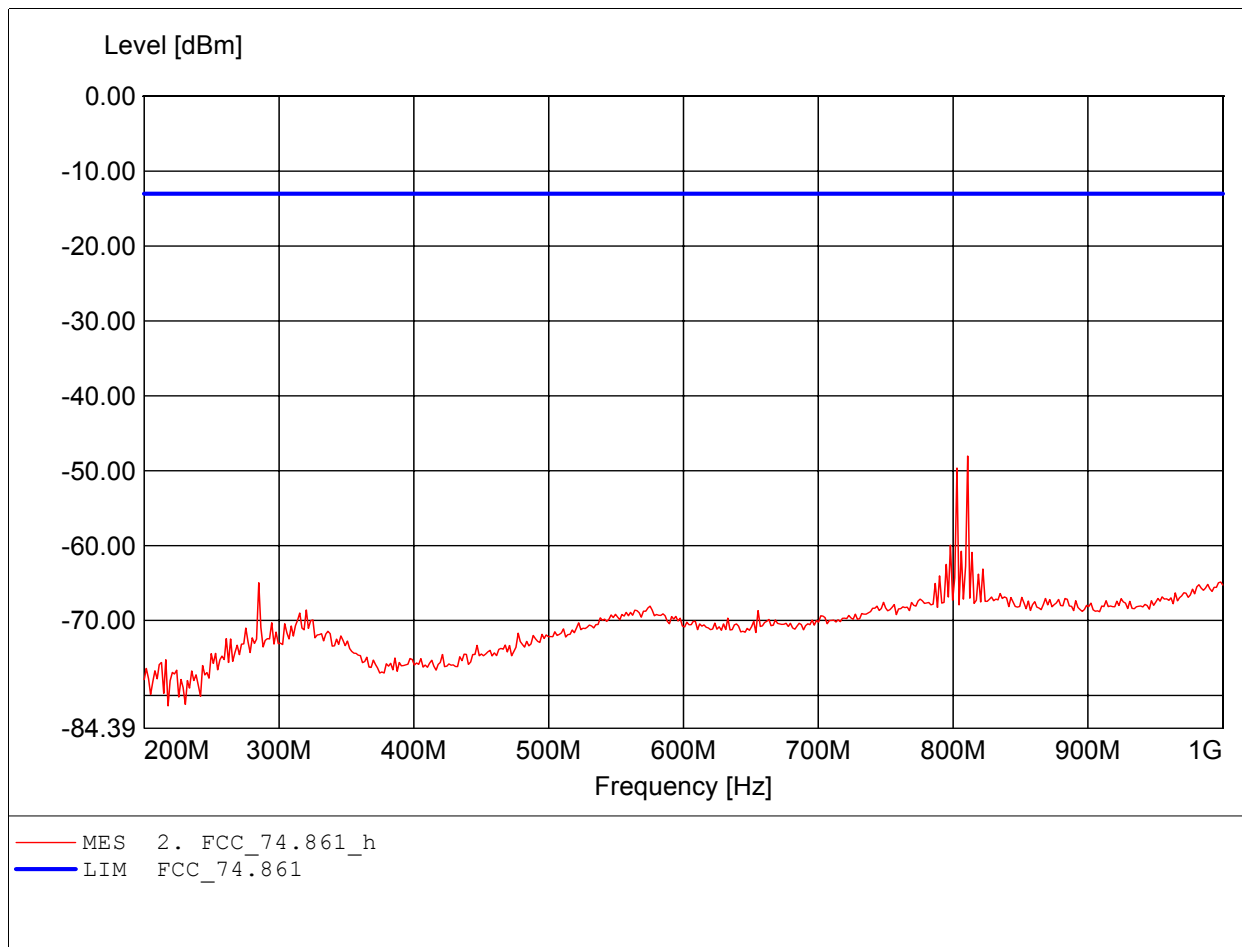

**Spurious emissions under normal conditions**

**in according to FCC Part 74.861**

EUT: Wireless Microphone Transmitter  
MODEL NO.: SM-6000 High Channel  
Approval Holder: CHIAYO ELECTRONICS.,LTD.  
Test Site / Operator: ETS / Sander Huang  
Temperature/Voltage: Temp.: 23°C/ Unom.: 3VDC (1.5VDC x 2 battery)  
Test Specification: 74.861  
Comment 1: Dist.: 3m, Ant.: HL 025, ampl.: 1-4GHz  
Freq:3.555GHz Pmax:-49.73dBm RBW: 1 MHz

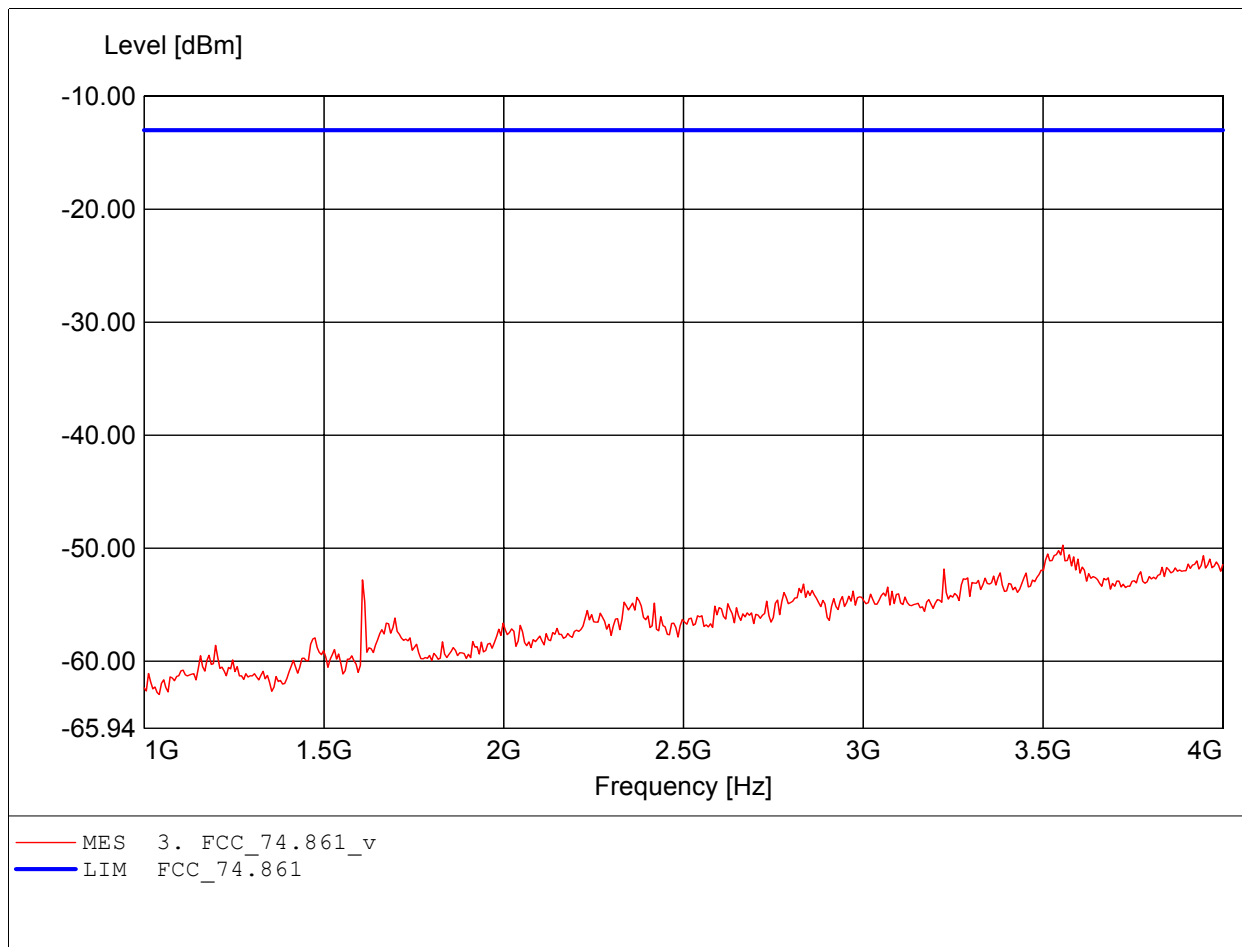

**Spurious emissions under normal conditions**

**in according to FCC Part 74.861**

EUT: Wireless Microphone Transmitter  
MODEL NO.: SM-6000 High Channel  
Approval Holder: CHIAYO ELECTRONICS.,LTD.  
Test Site / Operator: ETS / Sander Huang  
Temperature/Voltage: Temp.: 23°C/ Unom.: 3VDC (1.5VDC x 2 battery)  
Test Specification: 74.861  
Comment 1: Dist.: 3m, Ant.: HL 025, ampl.: 1-4GHz  
Freq:1.607GHz Pmax:-45.11dBm RBW: 1 MHz

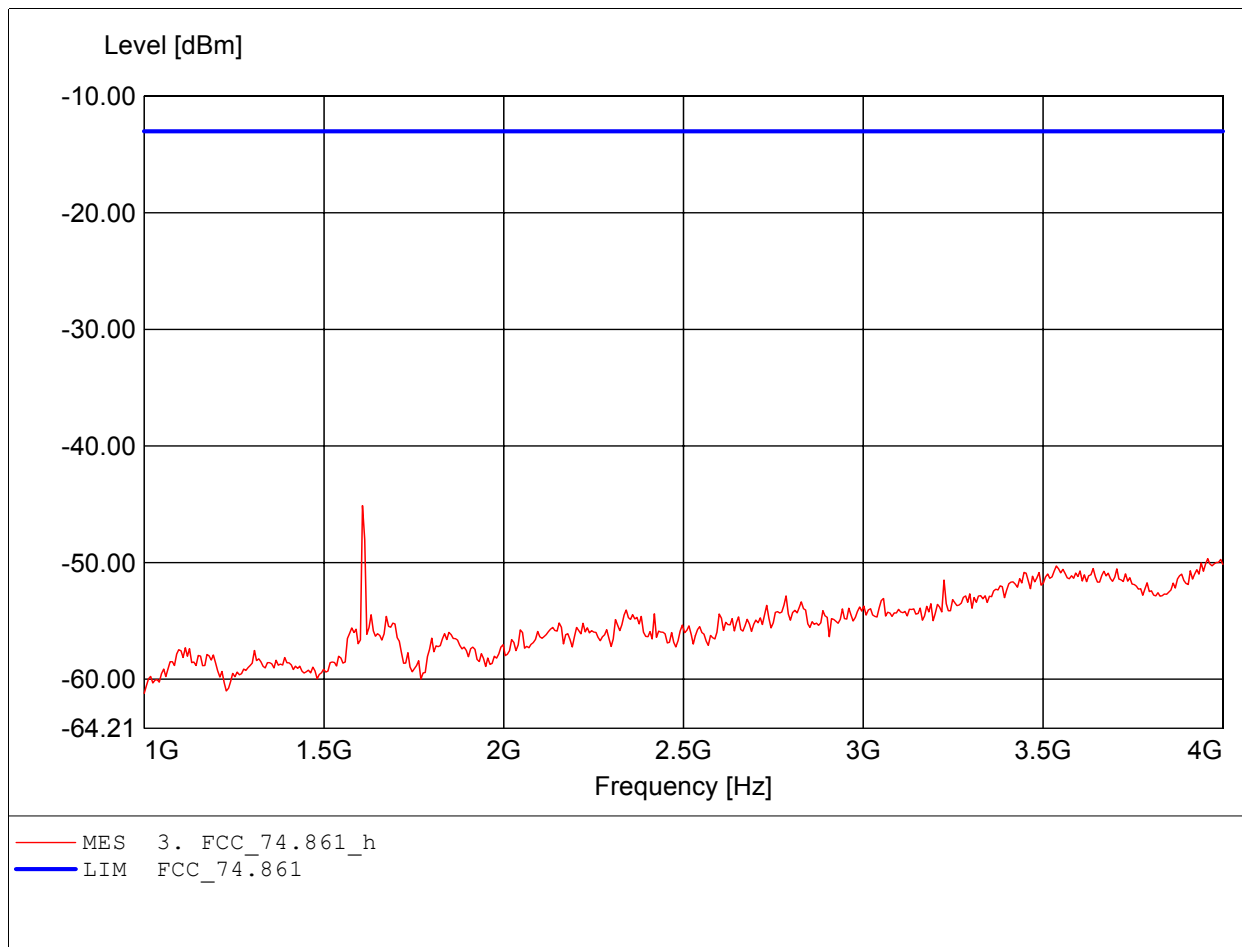



**Spurious emissions under normal conditions**

**in according to FCC Part 74.861**

EUT: Wireless Microphone Transmitter  
MODEL NO.: SM-6000 High Channel  
Approval Holder: CHIAYO ELECTRONICS.,LTD.  
Test Site / Operator: ETS / Sander Huang  
Temperature/Voltage: Temp.: 23°C/ Unom.: 3VDC (1.5VDC x 2 battery)  
Test Specification: 74.861  
Comment 1: Dist.: 1m, Ant.: HL 025, ampl.: 4-8GHz  
Freq:7.511GHz Pmax:-43.18dBm RBW: 1 MHz

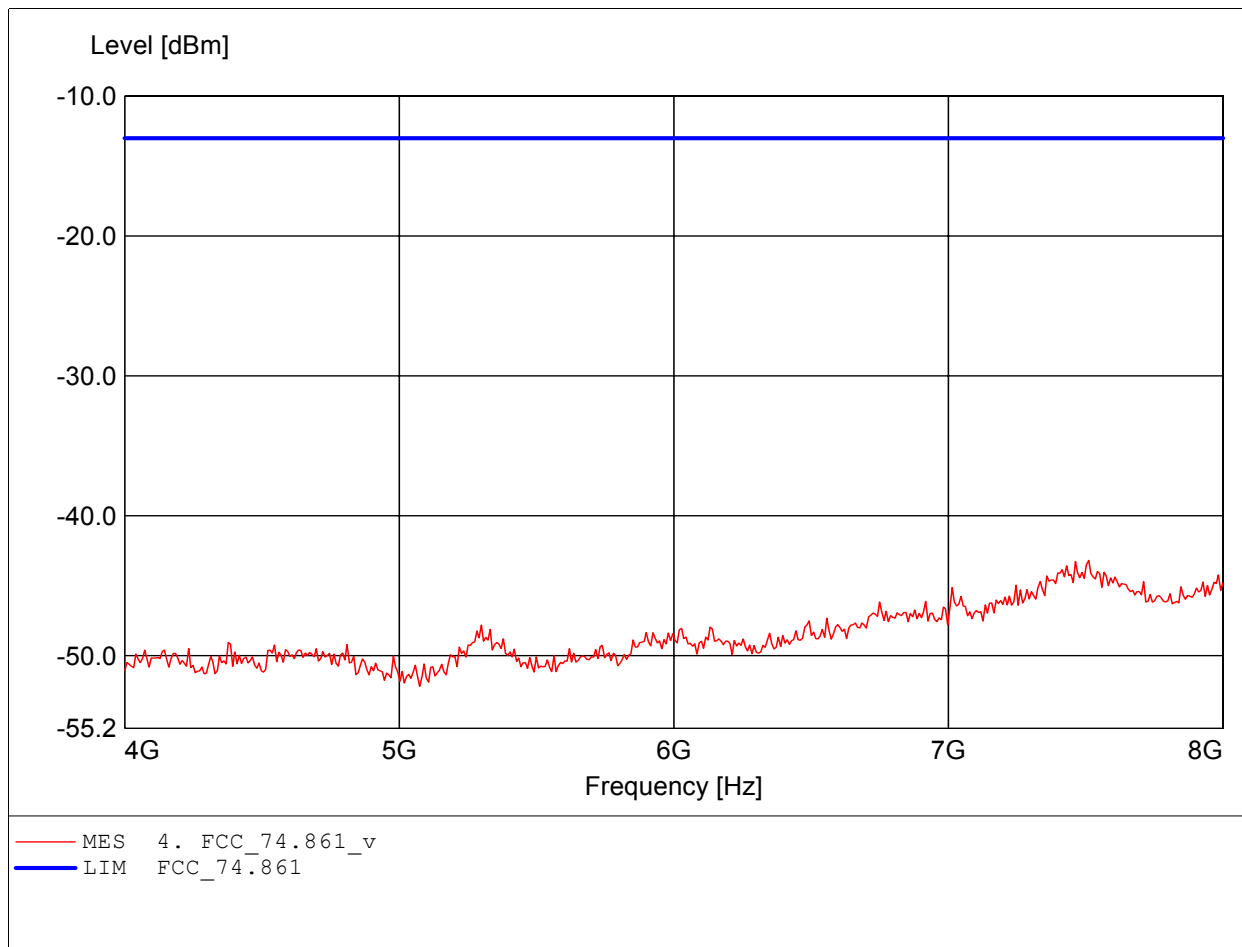

**Spurious emissions under normal conditions**

**in according to FCC Part 74.861**

EUT: Wireless Microphone Transmitter  
MODEL NO.: SM-6000 High Channel  
Approval Holder: CHIAYO ELECTRONICS.,LTD.  
Test Site / Operator: ETS / Sander Huang  
Temperature/Voltage: Temp.: 23°C/ Unom.: 3VDC (1.5VDC x 2 battery)  
Test Specification: 74.861  
Comment 1: Dist.: 1m, Ant.: HL 025, ampl.: 4-8GHz  
Freq:7.511GHz Pmax:-42.43dBm RBW: 1 MHz

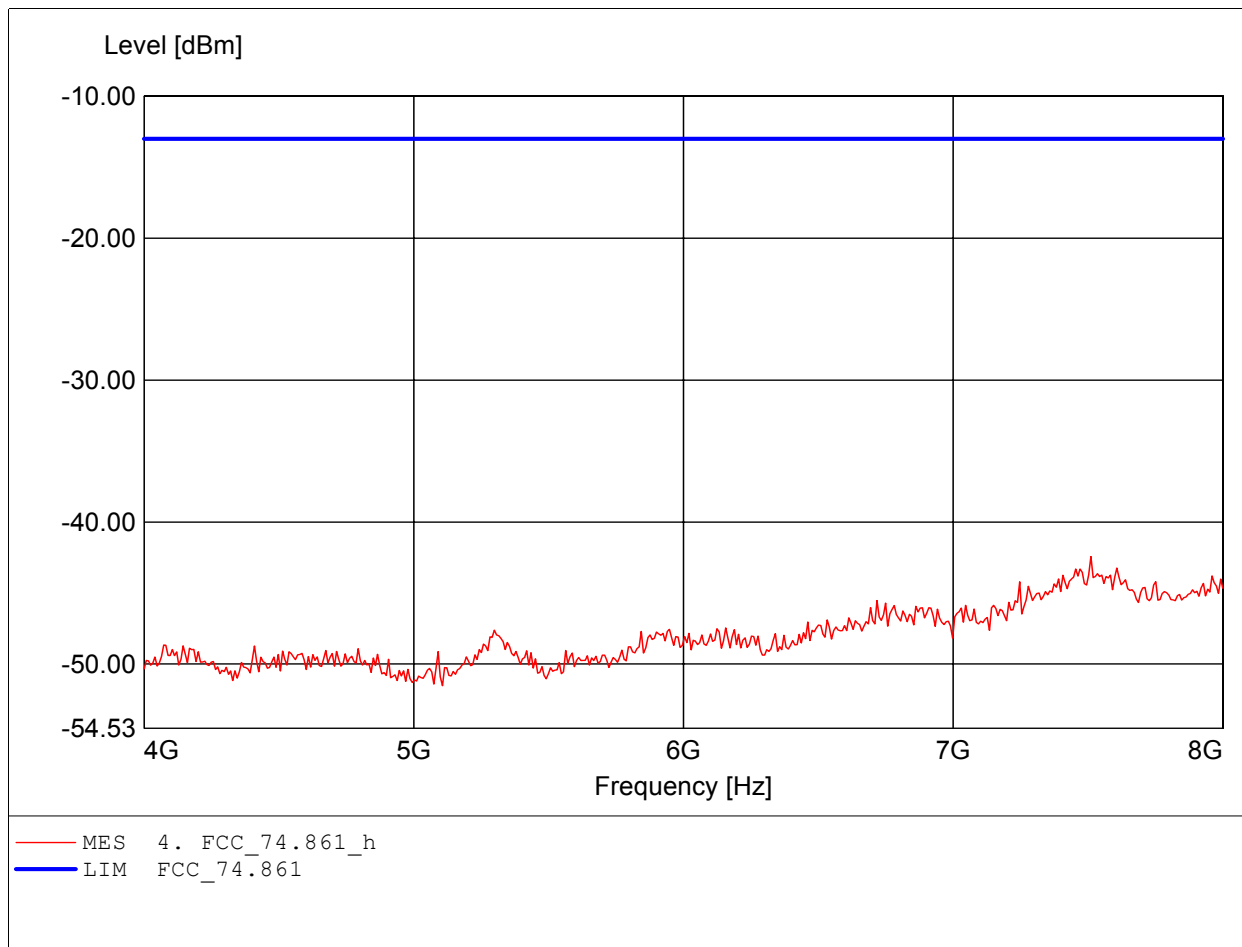

**Spurious emissions under normal conditions**

**in according to FCC Part 74.861**

EUT: Wireless Microphone Transmitter  
MODEL NO.: SM-6000 High Channel  
Approval Holder: CHIAYO ELECTRONICS.,LTD.  
Test Site / Operator: ETS / Sander Huang  
Temperature/Voltage: Temp.: 23°C/ Unom.: 3VDC (1.5VDC x 2 battery)  
Test Specification: 74.861  
Comment 1: Dist.: 1m, Ant.: HL 025, ampl.: 8-18GHz  
Freq:12.188GHz Pmax:-34.62dBm RBW: 1 MHz

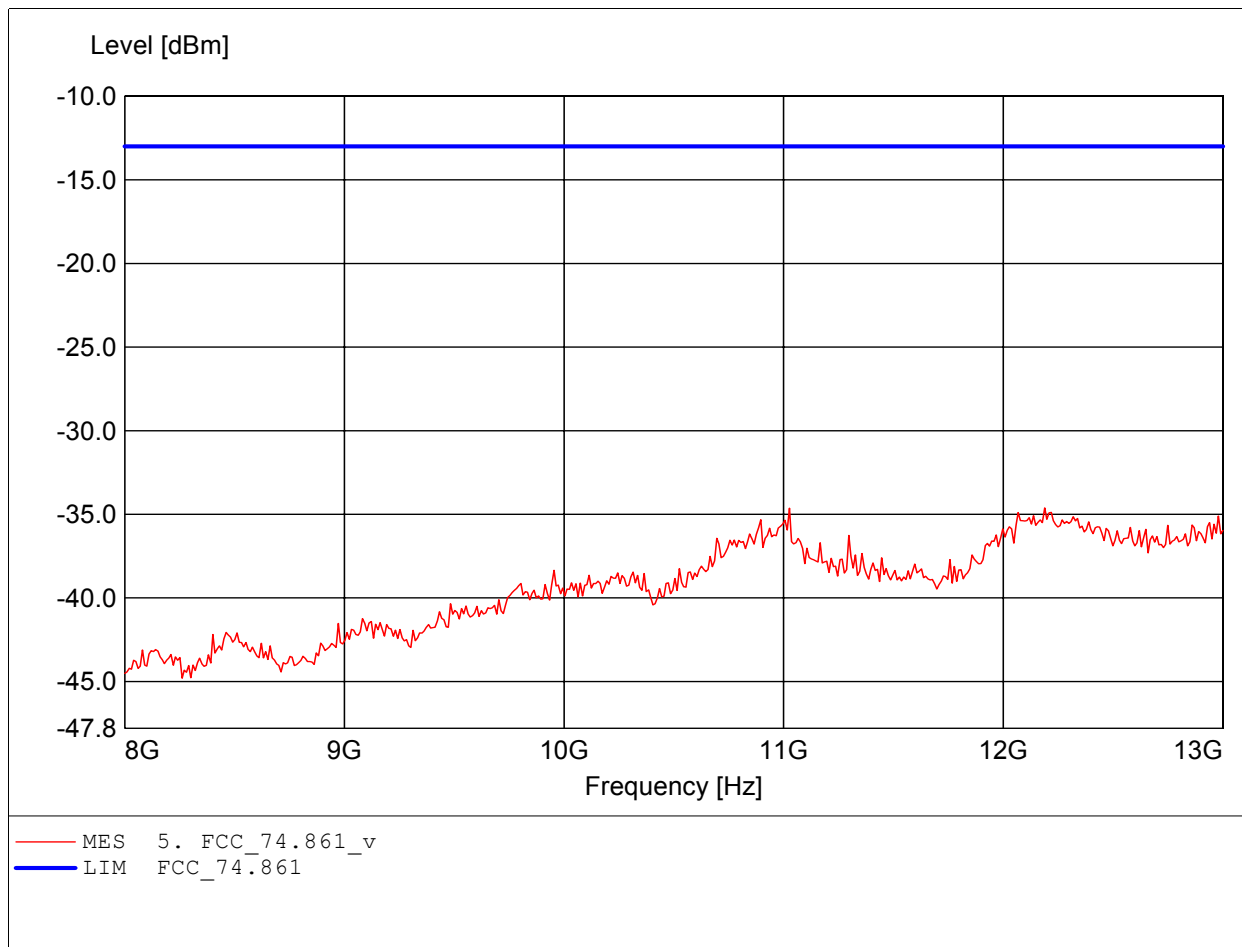

**Spurious emissions under normal conditions**

**in according to FCC Part 74.861**

EUT: Wireless Microphone Transmitter  
MODEL NO.: SM-6000 High Channel  
Approval Holder: CHIAYO ELECTRONICS.,LTD.  
Test Site / Operator: ETS / Sander Huang  
Temperature/Voltage: Temp.: 23°C/ Unom.: 3VDC (1.5VDC x 2 battery)  
Test Specification: 74.861  
Comment 1: Dist.: 1m, Ant.: HL 025, ampl.: 8-18GHz  
Freq:12.980GHz Pmax:-35.39dBm RBW: 1 MHz

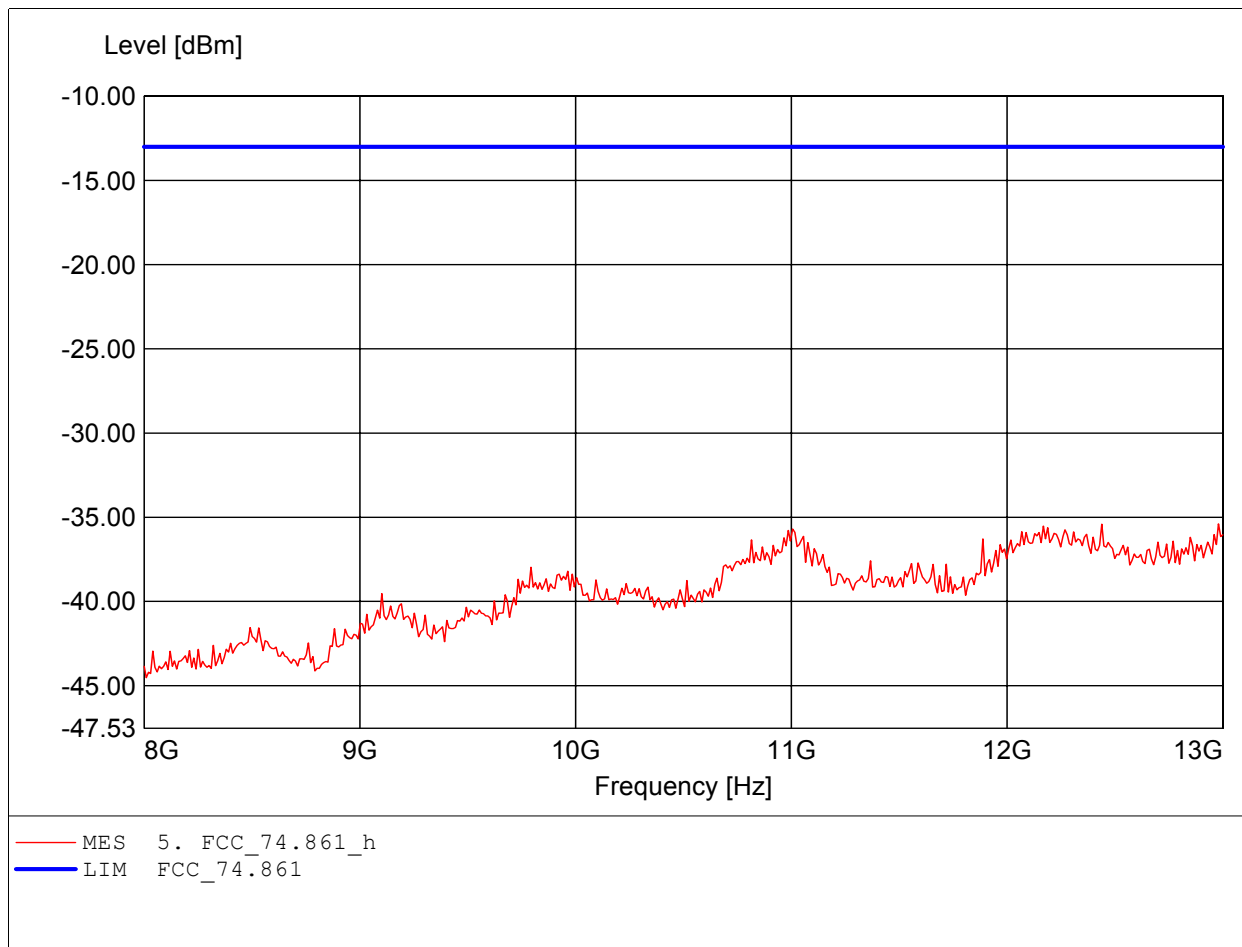



Registration number: W6M20408-5422-C-1  
FCC ID: CINSM-6000

## **Appendix F**

### Line Conducted Emissions

This is not required the sample is battery used.

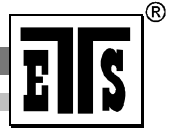

Registration number: W6M20408-5422-C-1  
FCC ID: CINSM-6000

## **Appendix G**

### Frequency Stability vs. Temperature

No diagrams  
Refer to point 12.2

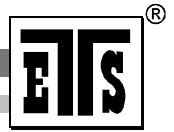

Registration number: W6M20408-5422-C-1  
FCC ID: CINSM-6000

Appendix H

## Frequency Stability vs. Voltage

No diagrams  
Refer to point 13.2

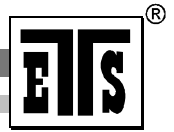

Registration number: W6M20408-5422-C-1  
FCC ID: CINSM-6000

## **Appendix I**

## Pictures



Registration number: W6M20408-5422-C-1  
FCC ID: CINSM-6000

External



Registration number: W6M20408-5422-C-1  
FCC ID: CINSM-6000

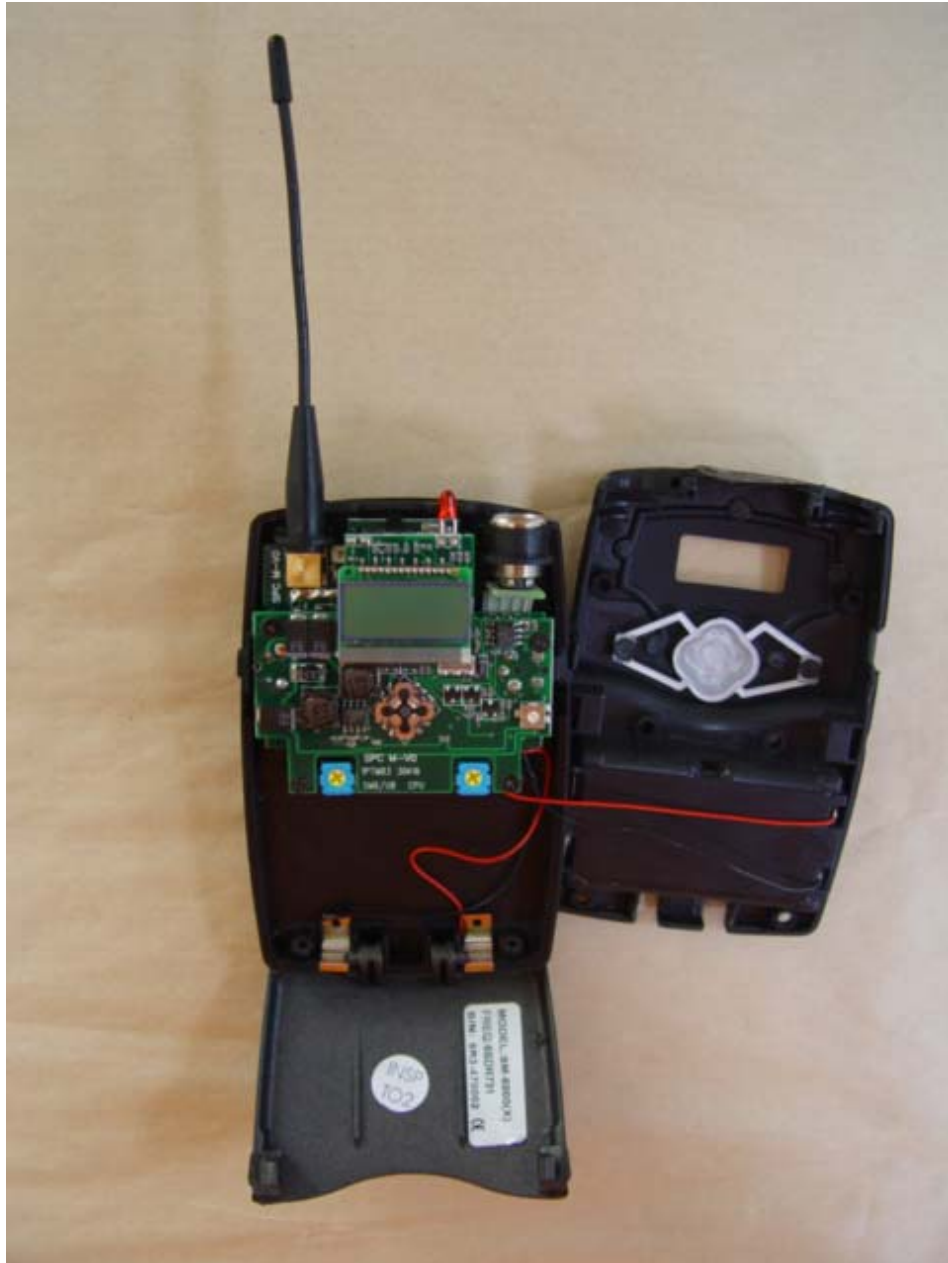

Registration number: W6M20408-5422-C-1  
FCC ID: CINSM-6000



Registration number: W6M20408-5422-C-1  
FCC ID: CINSM-6000



Registration number: W6M20408-5422-C-1  
FCC ID: CINSM-6000



Registration number: W6M20408-5422-C-1  
FCC ID: CINSM-6000



Registration number: W6M20408-5422-C-1  
FCC ID: CINSM-6000



Registration number: W6M20408-5422-C-1  
FCC ID: CINSM-6000





Registration number: W6M20408-5422-C-1  
FCC ID: CINSM-6000



Registration number: W6M20408-5422-C-1  
FCC ID: CINSM-6000



Registration number: W6M20408-5422-C-1  
FCC ID: CINSM-6000

### Internal Photo

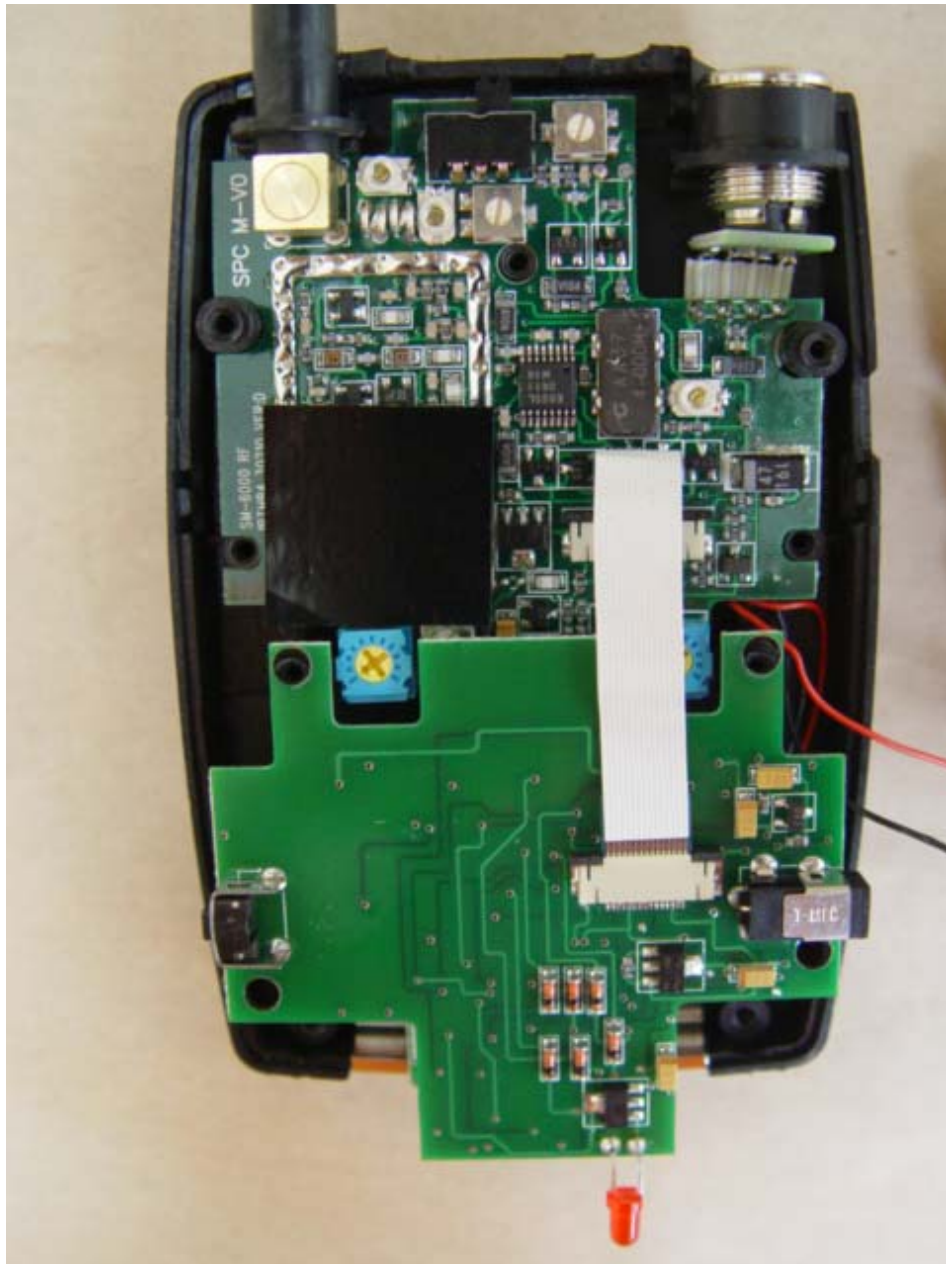

Registration number: W6M20408-5422-C-1  
FCC ID: CINSM-6000

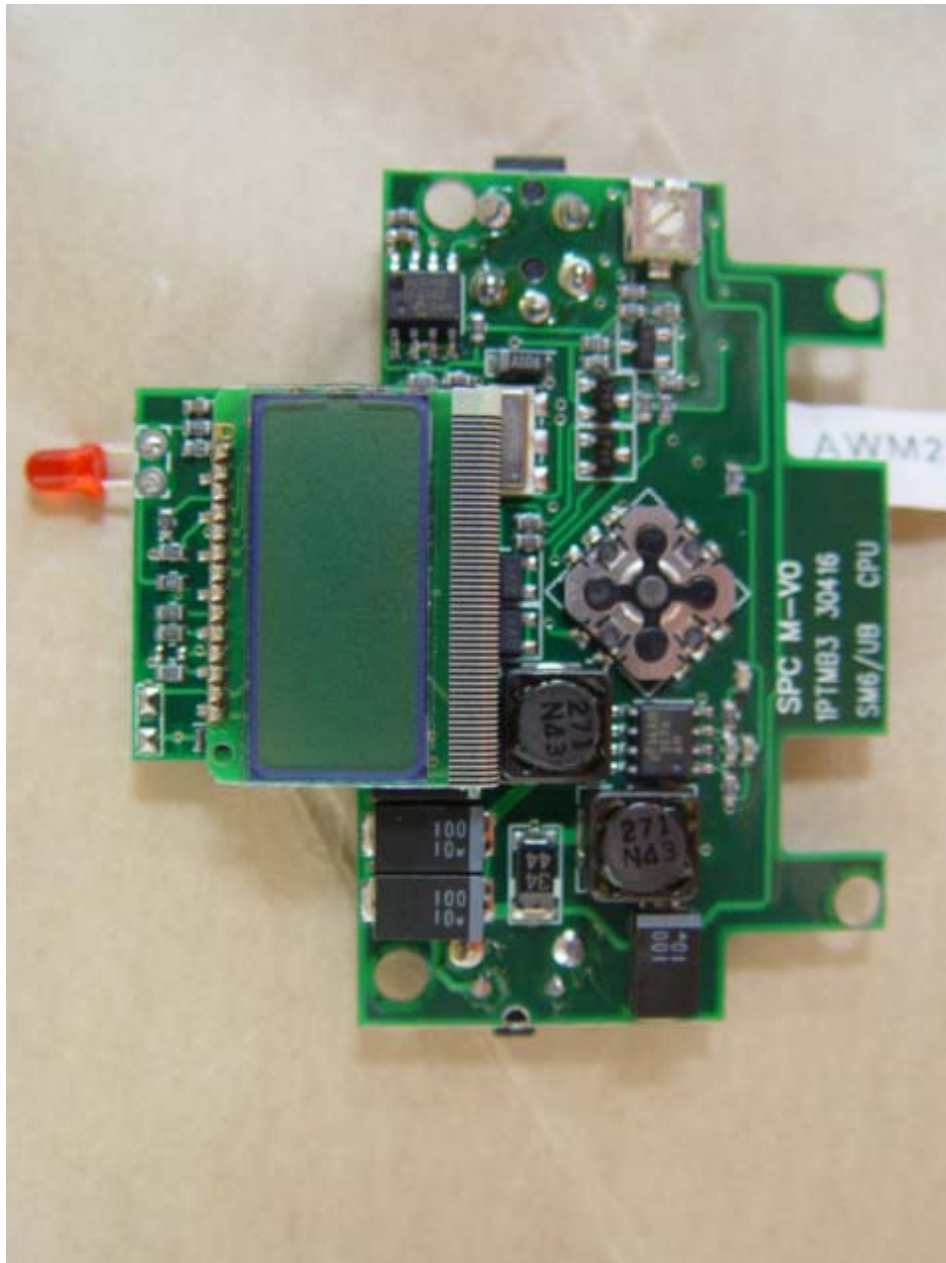

Registration number: W6M20408-5422-C-1  
FCC ID: CINSM-6000

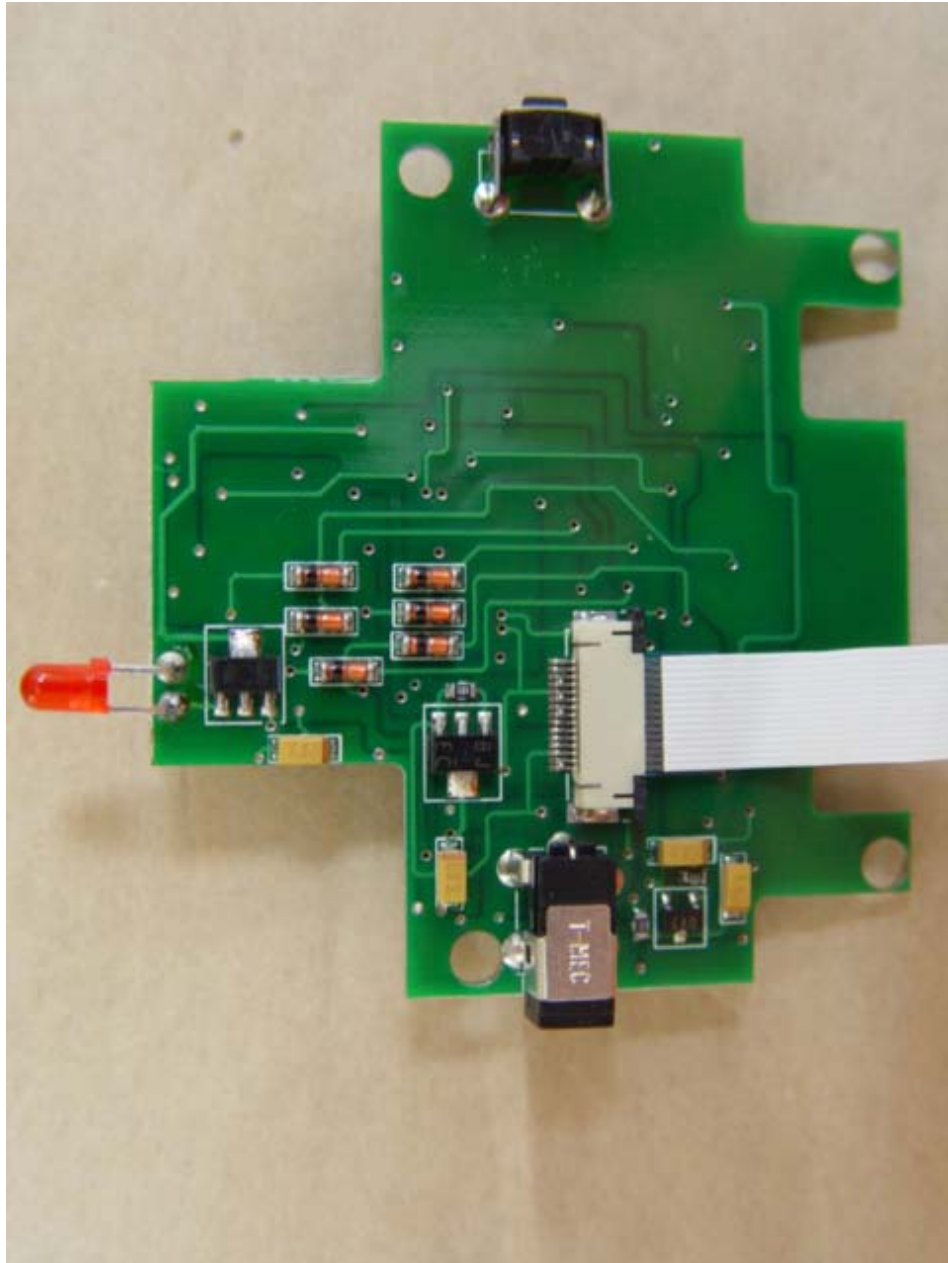

Registration number: W6M20408-5422-C-1  
FCC ID: CINSM-6000



Registration number: W6M20408-5422-C-1  
FCC ID: CINSM-6000

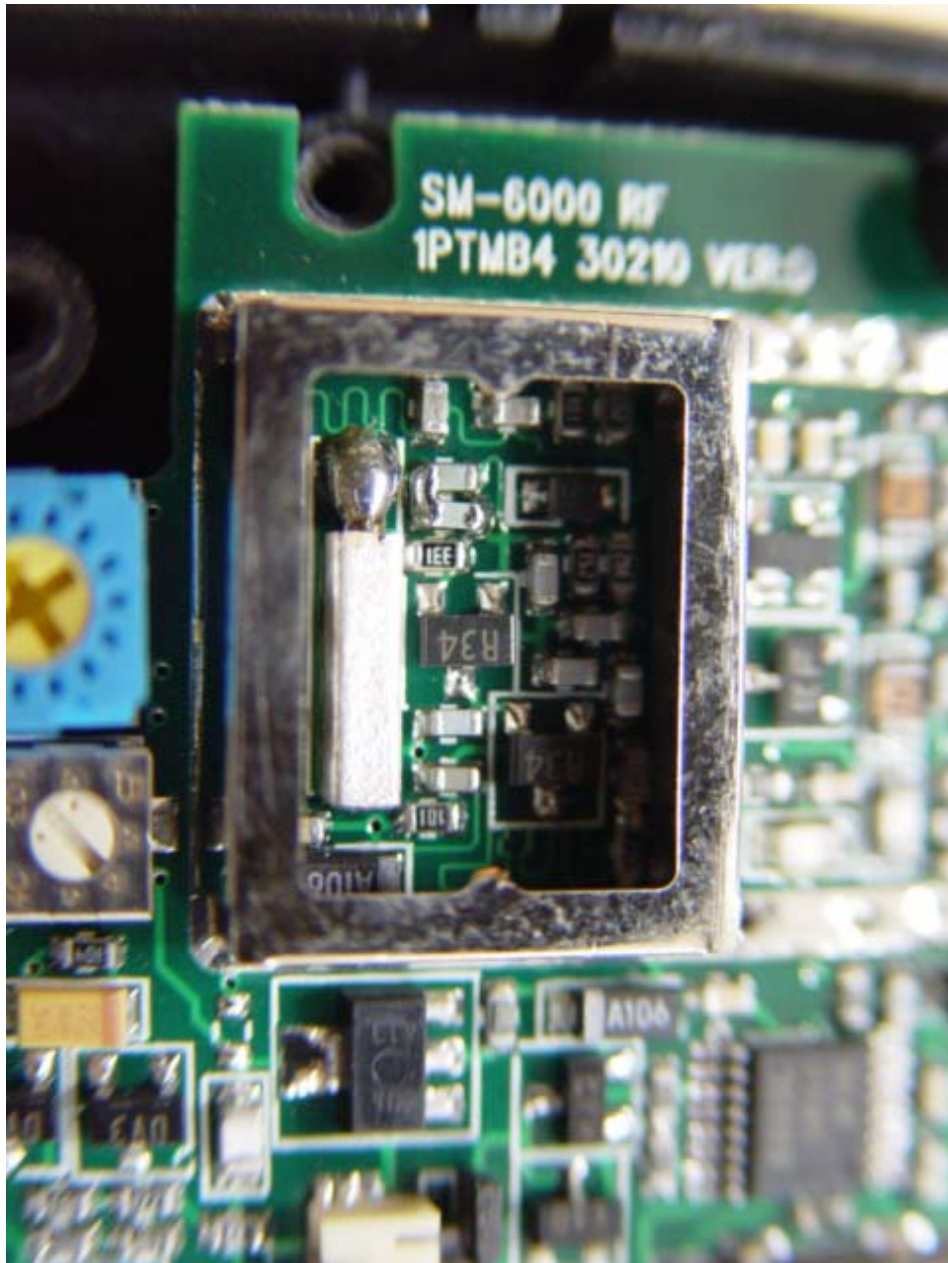

Registration number: W6M20408-5422-C-1  
FCC ID: CINSM-6000

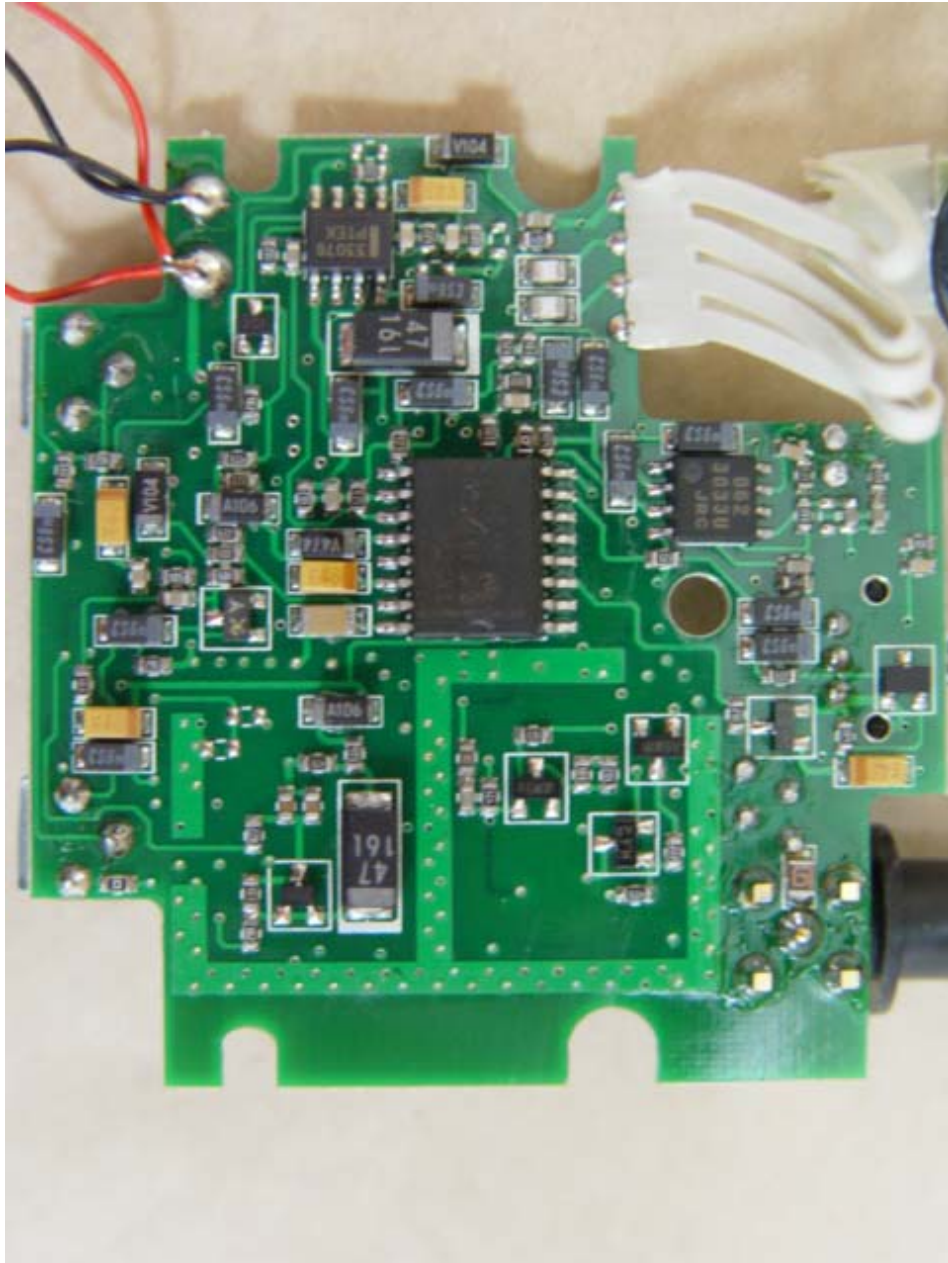



Registration number: W6M20408-5422-C-1  
FCC ID: CINSM-6000

## Set Up Photo

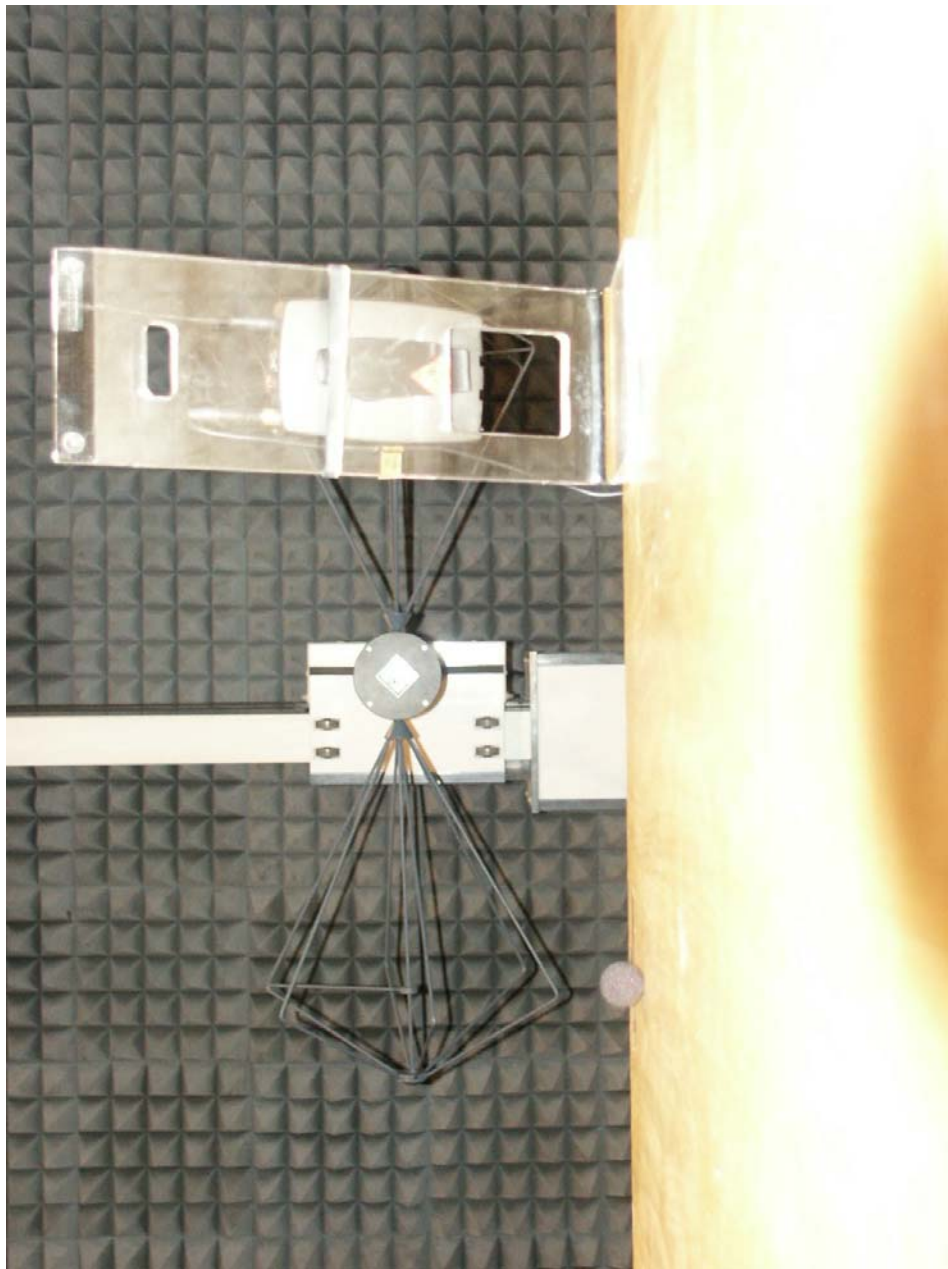

Registration number: W6M20408-5422-C-1  
FCC ID: CINSM-6000

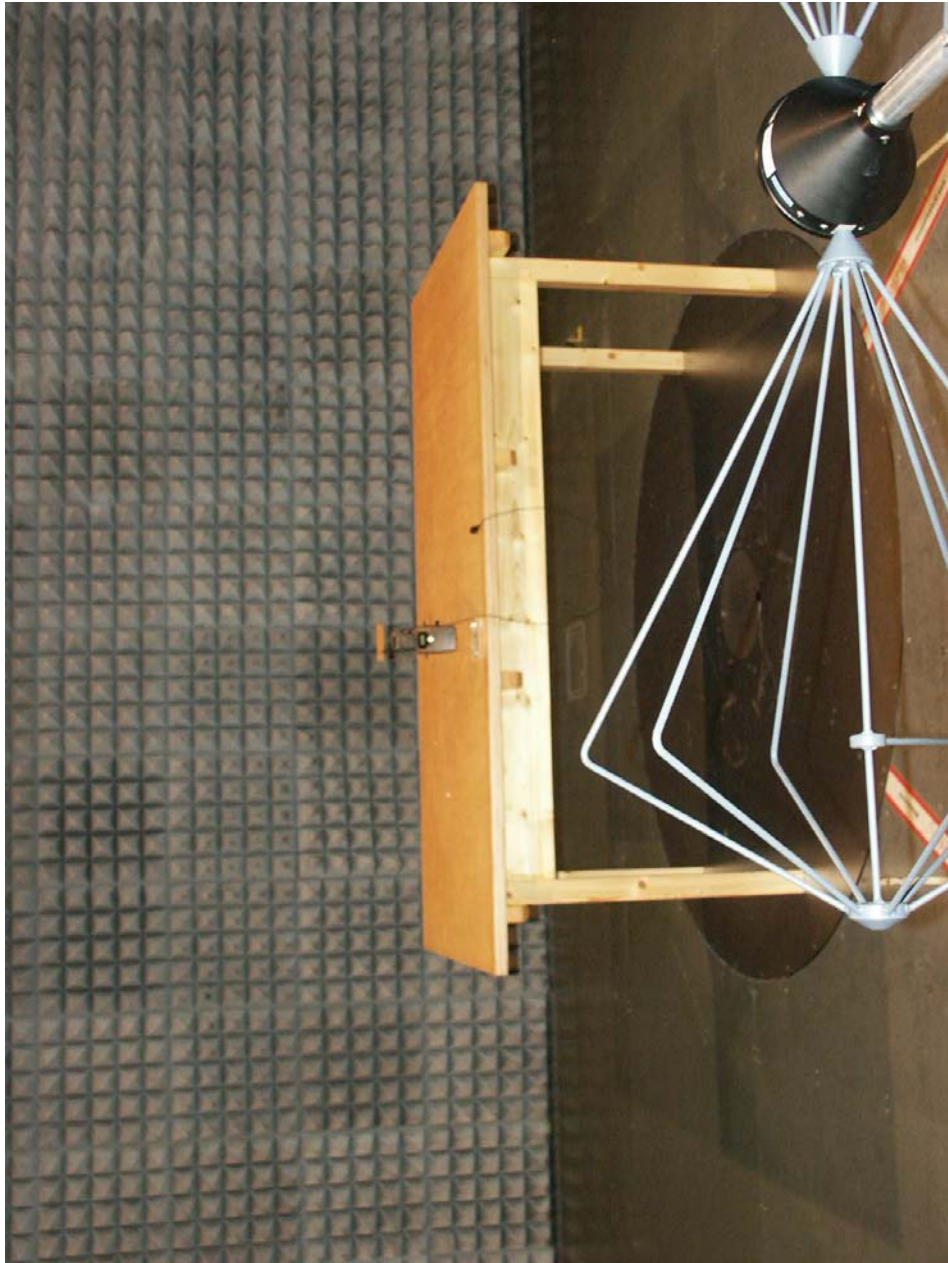

Registration number: W6M20408-5422-C-1  
FCC ID: CINSM-6000

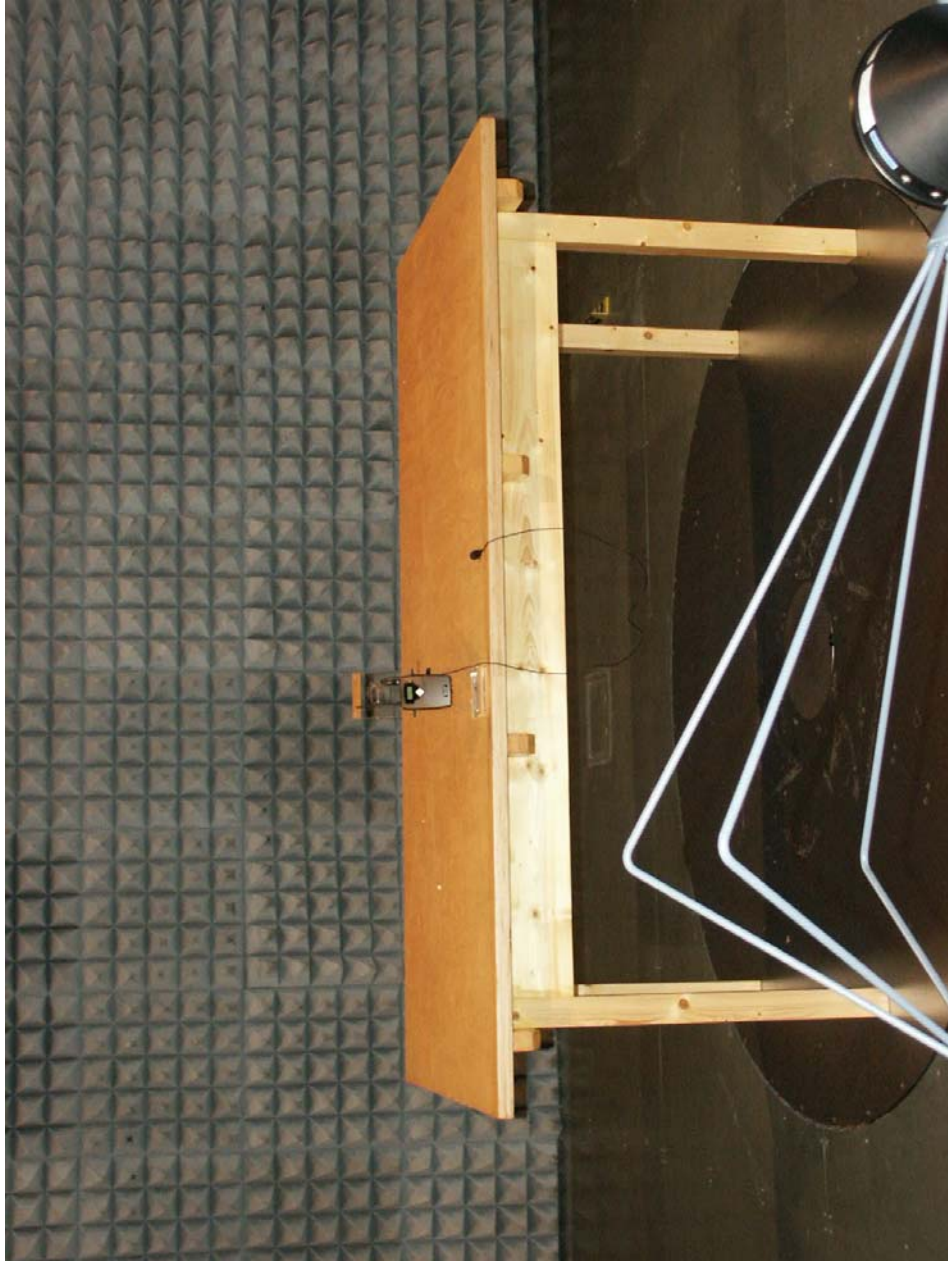

Registration number: W6M20408-5422-C-1  
FCC ID: CINSM-6000

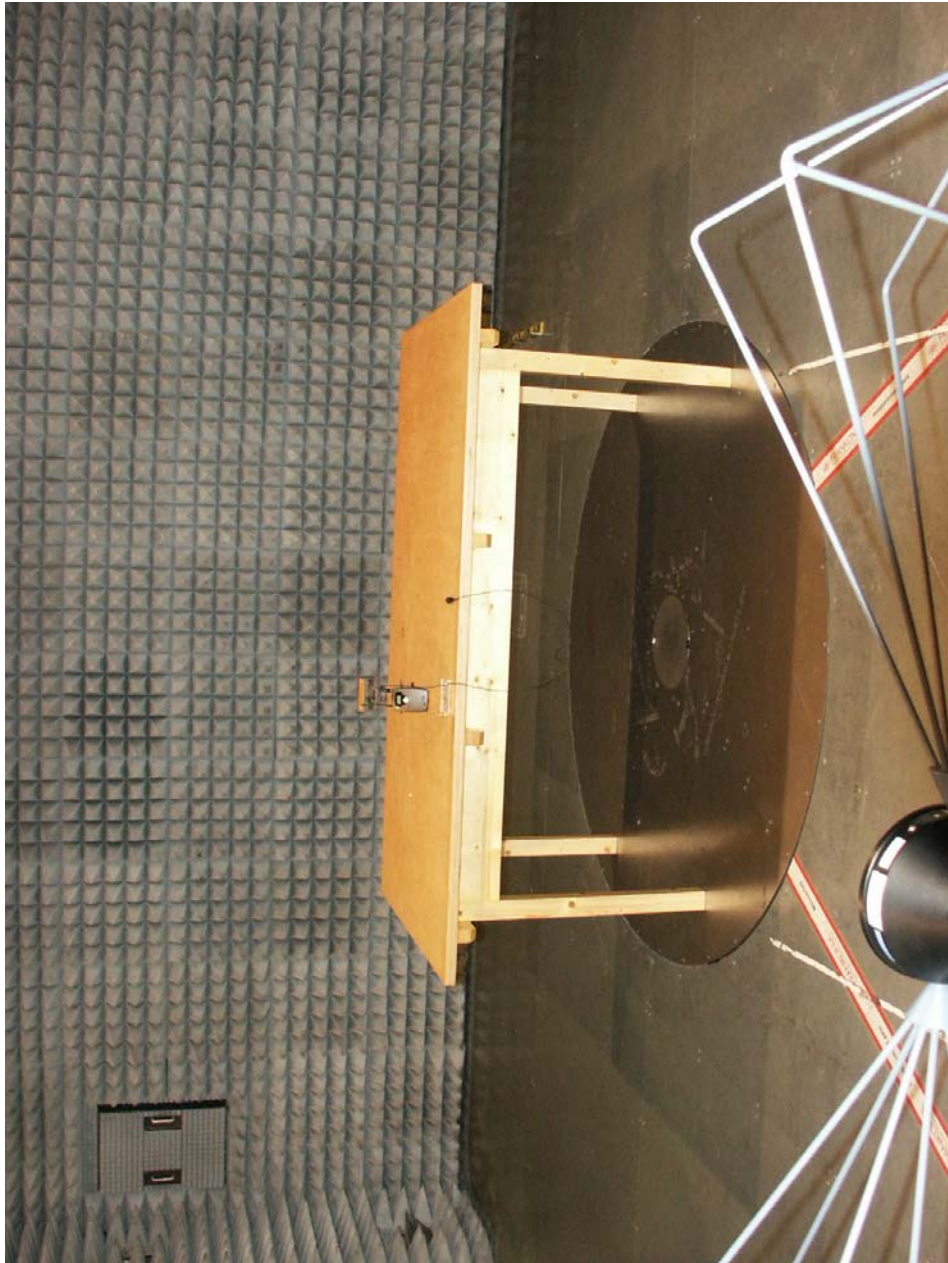

Registration number: W6M20408-5422-C-1  
FCC ID: CINSM-6000

