

label

← 47mm →



28mm

**FCC ID:CHQ9787TB4**    **MODEL: UC9787TB**  
**IC:2968A-9787TB4**

This device complies with part 15 of the FCC rules. Operation is subject to the following two conditions:  
(1) This device may not cause harmful interference and  
(2) This device must accept any interference received, including interference that may cause undesired operation.

**MADE IN CHINA**

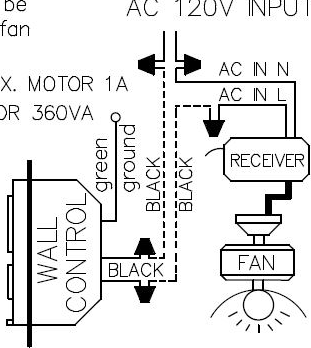
This control is to be used only with a fan speed control.  
120V AC/60Hz, MAX. MOTOR 1A  
MAX. LIGHT 360W OR 360VA



0320    C

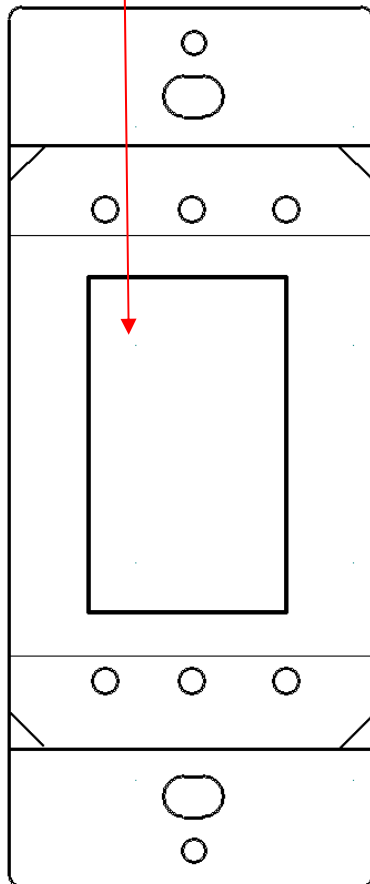

label

← 47mm →

28mm

**FCC ID:CHQ9787TB4**    **MODEL: UC9787TB1**  
**IC:2968A-9787TB4**

This device complies with part 15 of the FCC rules. Operation is subject to the following two conditions:  
(1) This device may not cause harmful interference and  
(2) This device must accept any interference received, including interference that may cause undesired operation.

**MADE IN CHINA**

This control is to be used only with a fan speed control.  
120V AC/60Hz, MAX. MOTOR 1A  
MAX. LIGHT 360W OR 360VA

**UL** LISTED  
FAN SPEED CONTROL  
8F36  
E161552

**WALL CONTROL**

AC 120V INPUT  
AC IN N  
AC IN L  
RECEIVER  
FAN

green  
ground  
BLACK  
BLACK

0320    C

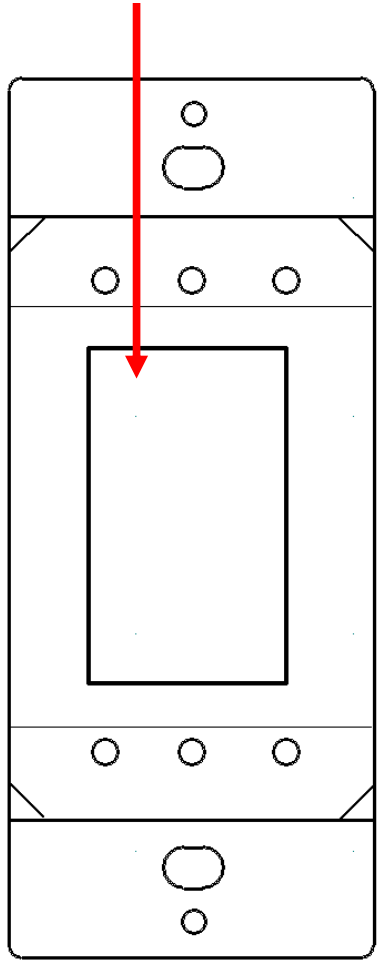

label

22\*28mm

**MODEL UC9787TBD**  
**FCC ID : CHQ9787TB4**  
**IC : 2968A-9787TB4**

This device complies with  
part 15 of the FCC rules.  
Operation is subject to the  
following two conditions:

- (1) This device may not cause  
harmful interference and
- (2) This device must accept  
any interference received,  
including interference that  
may cause undesired operation.

YYMM

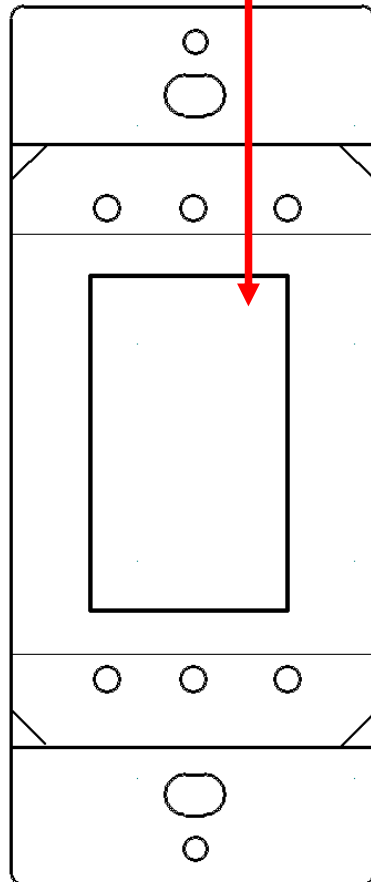

label

22\*28mm

**MODEL UC9787TBD1**  
**FCC ID : CHQ9787TB4**  
**IC : 2968A-9787TB4**

This device complies with part 15 of the FCC rules. Operation is subject to the following two conditions:  
(1)This device may not cause harmful interference and  
(2)This device must accept any interference received, including interference that may cause undesired operation.

YYMM

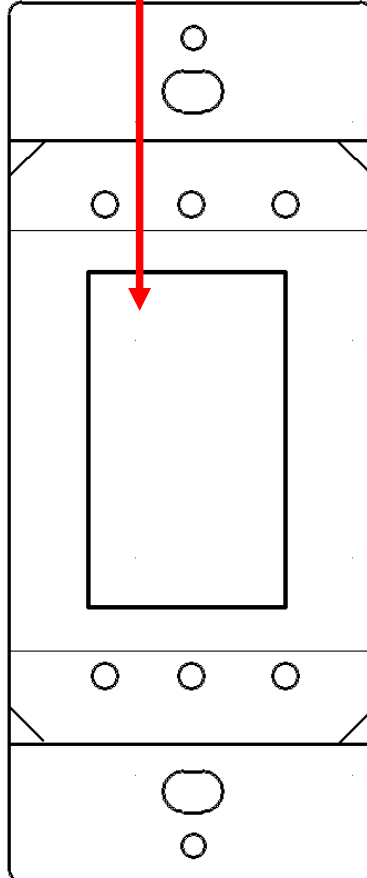

label

← 47mm →

28mm

**FCC ID:CHQ9787TB4**    **MODEL: UC9787TBG**  
**IC:2968A-9787TB4**

This device complies with part 15 of the FCC rules. Operation is subject to the following two conditions:  
(1) This device may not cause harmful interference and  
(2) This device must accept any interference received, including interference that may cause undesired operation.

**MADE IN CHINA**

This control is to be used only with a fan speed control.  
120V AC/60Hz, MAX. MOTOR 1A  
MAX. LIGHT 360W OR 360VA

**UL** LISTED  
FAN SPEED CONTROL  
8F36  
E161552

**WALL CONTROL**

AC 120V INPUT  
AC IN N  
AC IN L  
RECEIVER  
FAN

green  
ground  
BLACK  
BLACK

0320    C

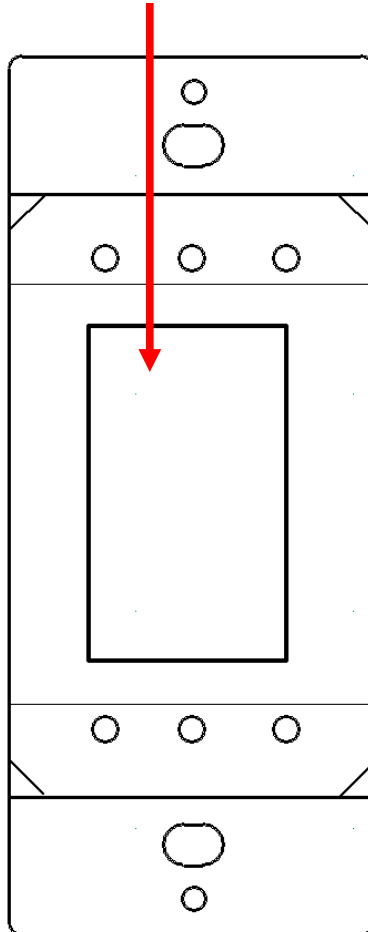

label

← 47mm →

28mm

**FCC ID:CHQ9787TB4**    **MODEL: UC9787TBG1**  
**IC:2968A-9787TB4**

This device complies with part 15 of the FCC rules. Operation is subject to the following two conditions:  
(1) This device may not cause harmful interference and  
(2) This device must accept any interference received, including interference that may cause undesired operation.

**MADE IN CHINA**

This control is to be used only with a fan speed control.  
120V AC/60Hz, MAX. MOTOR 1A  
MAX. LIGHT 360W OR 360VA

**UL** LISTED  
FAN SPEED CONTROL  
8F36  
E161552

**WALL CONTROL**

AC 120V INPUT  
AC IN N  
AC IN L  
RECEIVER  
FAN

green  
ground  
BLACK  
BLACK

0320    C

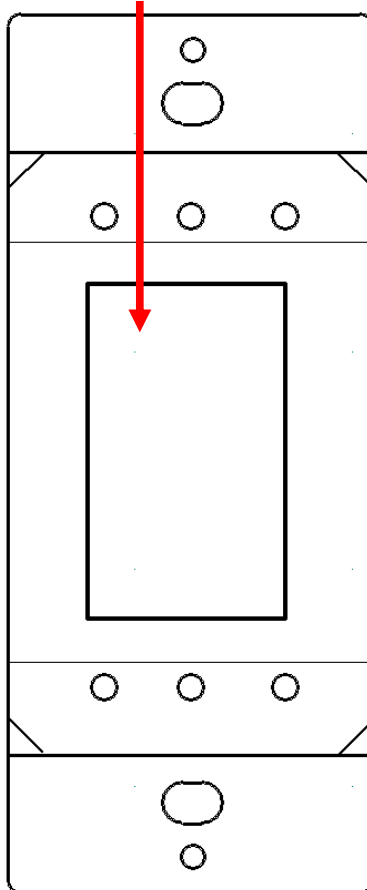

label

22\*28mm

**MODEL UC9787TBGD**  
**FCC ID : CHQ9787TB4**  
**IC : 2968A-9787TB4**

This device complies with part 15 of the FCC rules. Operation is subject to the following two conditions:  
(1) This device may not cause harmful interference and  
(2) This device must accept any interference received, including interference that may cause undesired operation.

YYMM

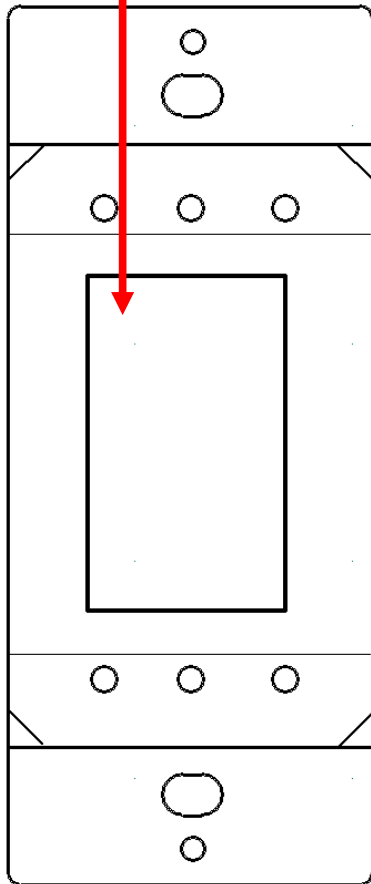

label

22\*28mm

**MODEL : UC9787TBGD1**  
**FCC ID : CHQ9787TB4**  
**IC : 2968A-9787TB4**

This device complies with part 15 of the FCC rules. Operation is subject to the following two conditions:  
(1)This device may not cause harmful interference and  
(2)This device must accept any interference received, including interference that may cause undesired operation.

YYMM

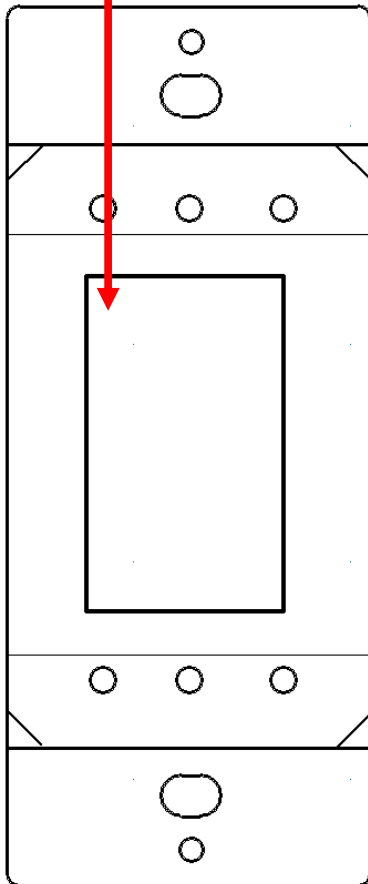



label

28mm

47mm

FCC ID:CHQ9787TB4  
IC:2968A-9787TB4

This device complies with part 15 of the FCC rules. Operation is subject to the following two conditions:

- (1) This device may not cause harmful interference and
- (2) This device must accept any interference received, including interference that may cause undesired operation.

MADE IN CHINA

MODEL: UC9787TBGK

This control is to be used only with a fan speed control.

120V AC/60Hz, MAX. MOTOR 1A  
MAX. LIGHT 360W OR 360VA

 **UL** <sup>®</sup> **US**  
**LISTED**  
FAN SPEED CONTROL  
8F36  
E161552

AC 120V INPUT

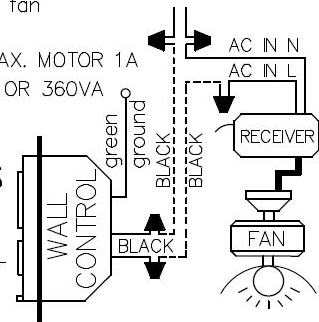

0320

C

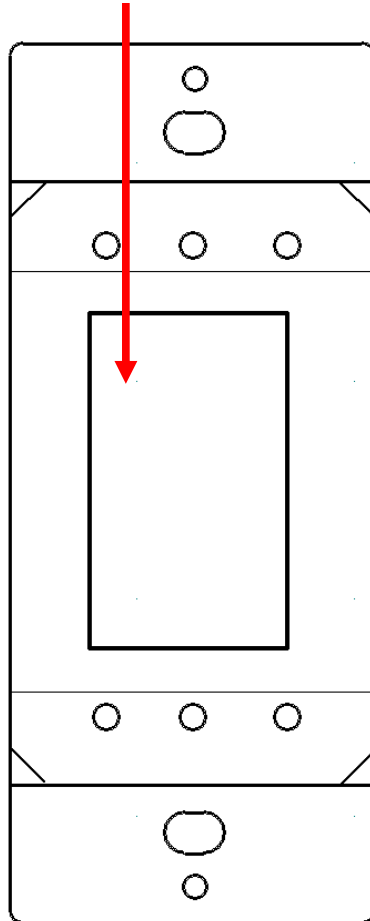

label

← 47mm →

28mm

**FCC ID:CHQ9787TB4**    **MODEL: UC9787TBGK1**  
**IC:2968A-9787TB4**

This device complies with part 15 of the FCC rules. Operation is subject to the following two conditions:  
(1) This device may not cause harmful interference and  
(2) This device must accept any interference received, including interference that may cause undesired operation.

**MADE IN CHINA**

This control is to be used only with a fan speed control.  
120V AC/60Hz, MAX. MOTOR 1A  
MAX. LIGHT 360W OR 360VA

**UL** LISTED  
FAN SPEED CONTROL  
8F36  
E161552

**WALL CONTROL**

AC 120V INPUT  
AC IN N  
AC IN L  
RECEIVER  
FAN

green  
ground  
BLACK  
BLACK

0320    C

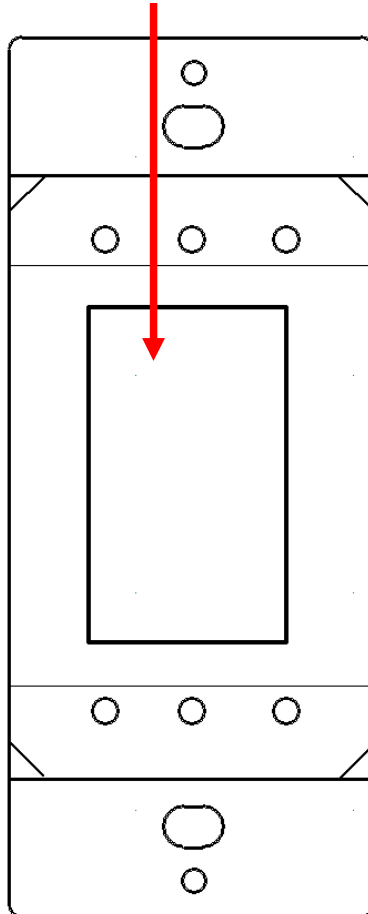

label

22\*28mm

**MODEL : UC9787TBGKD**  
**FCC ID : CHQ9787TB4**  
**IC : 2968A-9787TB4**

This device complies with part 15 of the FCC rules. Operation is subject to the following two conditions:  
(1) This device may not cause harmful interference and  
(2) This device must accept any interference received, including interference that may cause undesired operation.

YYMM

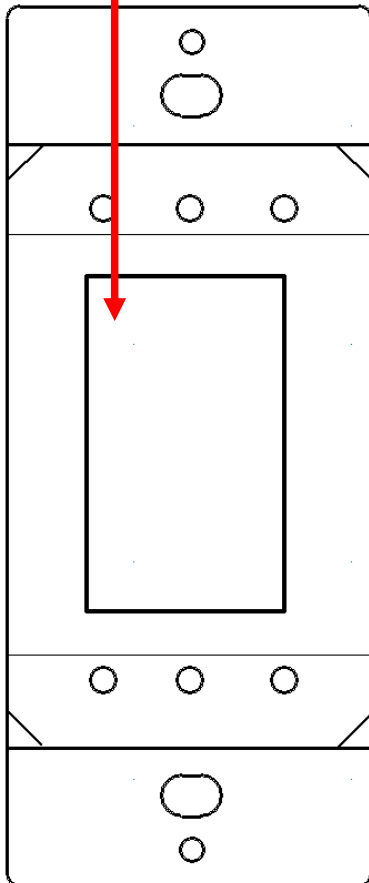

label

22\*28mm

**MODEL : UC9787TBGKD1**

**FCC ID : CHQ9787TB4**

**IC : 2968A-9787TB4**

This device complies with  
part 15 of the FCC rules.

Operation is subject to the  
following two conditions:

(1)This device may not cause  
harmful interference and

(2)This device must accept  
any interference received,  
Including interference that  
may cause undesired operation.

YYMM

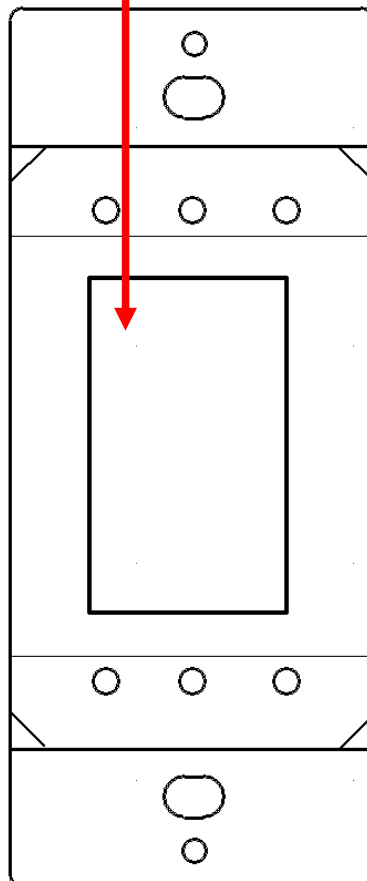

label

← 47mm →

28mm

**FCC ID:CHQ9787TB4**    **MODEL: UC9787TBK**  
**IC:2968A-9787TB4**

This device complies with part 15 of the FCC rules. Operation is subject to the following two conditions:  
(1) This device may not cause harmful interference and  
(2) This device must accept any interference received, including interference that may cause undesired operation.

**MADE IN CHINA**

This control is to be used only with a fan speed control.  
120V AC/60Hz, MAX. MOTOR 1A  
MAX. LIGHT 360W OR 360VA

**UL** LISTED  
FAN SPEED CONTROL  
8F36  
E161552

**WALL CONTROL**

AC 120V INPUT  
AC IN N  
AC IN L  
RECEIVER  
FAN

green  
ground  
BLACK  
BLACK

0320    C

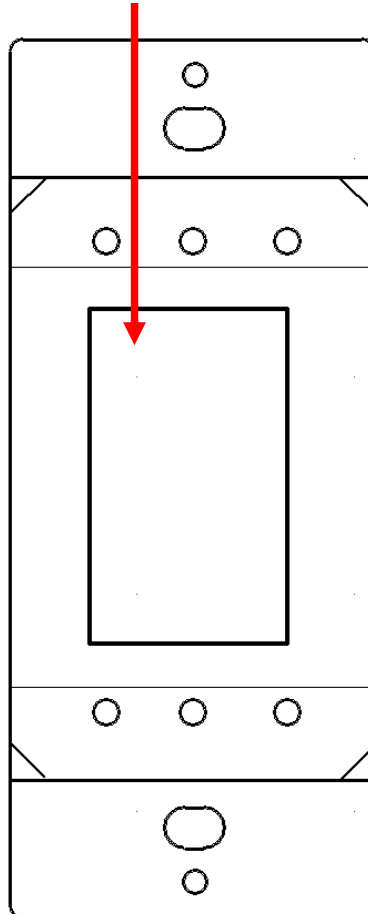

label

← 47mm →

28mm

**FCC ID:CHQ9787TB4**    **MODEL: UC9787TBK1**  
**IC:2968A-9787TB4**

This device complies with part 15 of the FCC rules. Operation is subject to the following two conditions:  
(1) This device may not cause harmful interference and  
(2) This device must accept any interference received, including interference that may cause undesired operation.

**MADE IN CHINA**

This control is to be used only with a fan speed control.  
120V AC/60Hz, MAX. MOTOR 1A  
MAX. LIGHT 360W OR 360VA

**UL** LISTED  
FAN SPEED CONTROL  
8F36  
E161552

**WALL CONTROL**

AC 120V INPUT  
AC IN N  
AC IN L  
RECEIVER  
FAN

green  
ground  
BLACK  
BLACK

0320    C

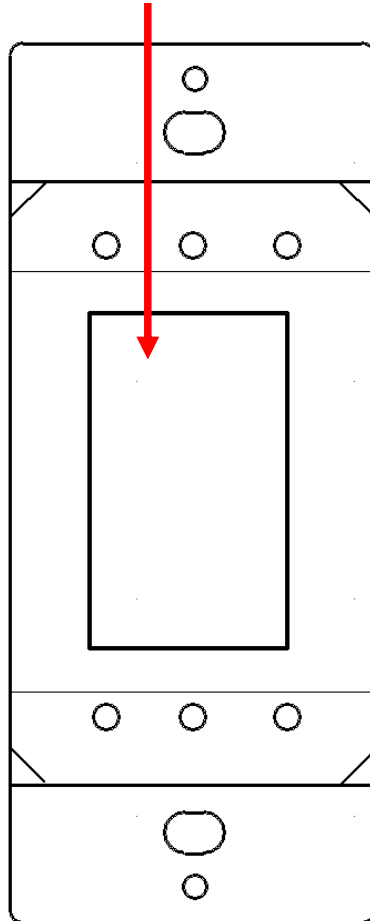

label

22\*28mm

**MODEL : UC9787TBKD**  
**FCC ID : CHQ9787TB4**  
**IC : 2968A-9787TB4**

This device complies with part 15 of the FCC rules. Operation is subject to the following two conditions:  
(1) This device may not cause harmful interference and  
(2) This device must accept any interference received, including interference that may cause undesired operation.

YYMM

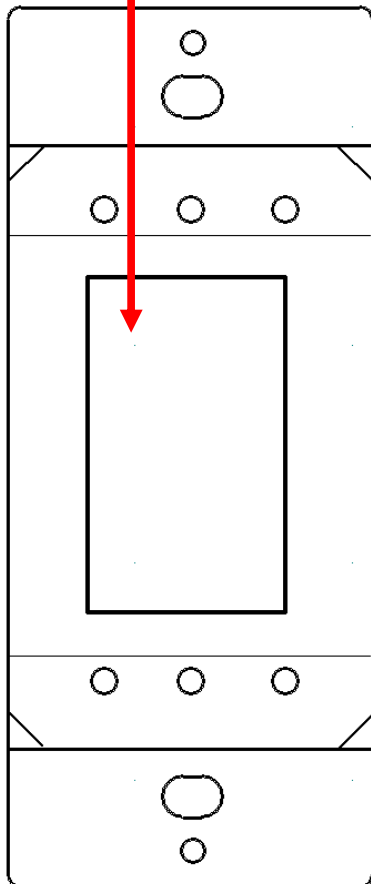

label

22\*28mm

**MODEL : UC9787TBKD1**  
**FCC ID : CHQ9787TB4**  
**IC : 2968A-9787TB4**

This device complies with part 15 of the FCC rules. Operation is subject to the following two conditions:  
(1)This device may not cause harmful interference and  
(2)This device must accept any interference received, including interference that may cause undesired operation.

YYMM

