

label

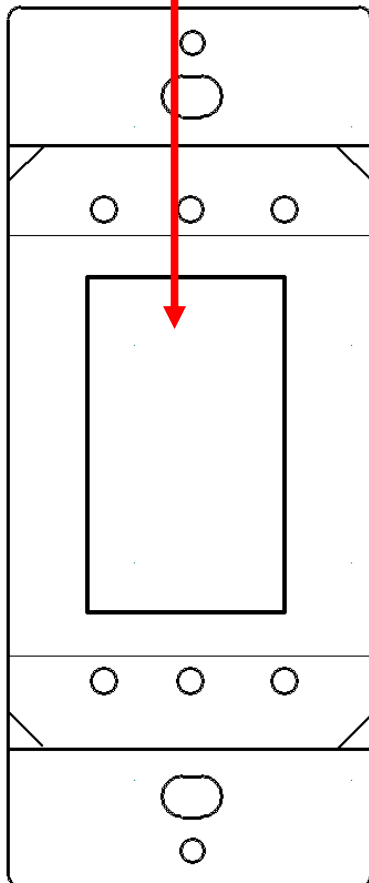
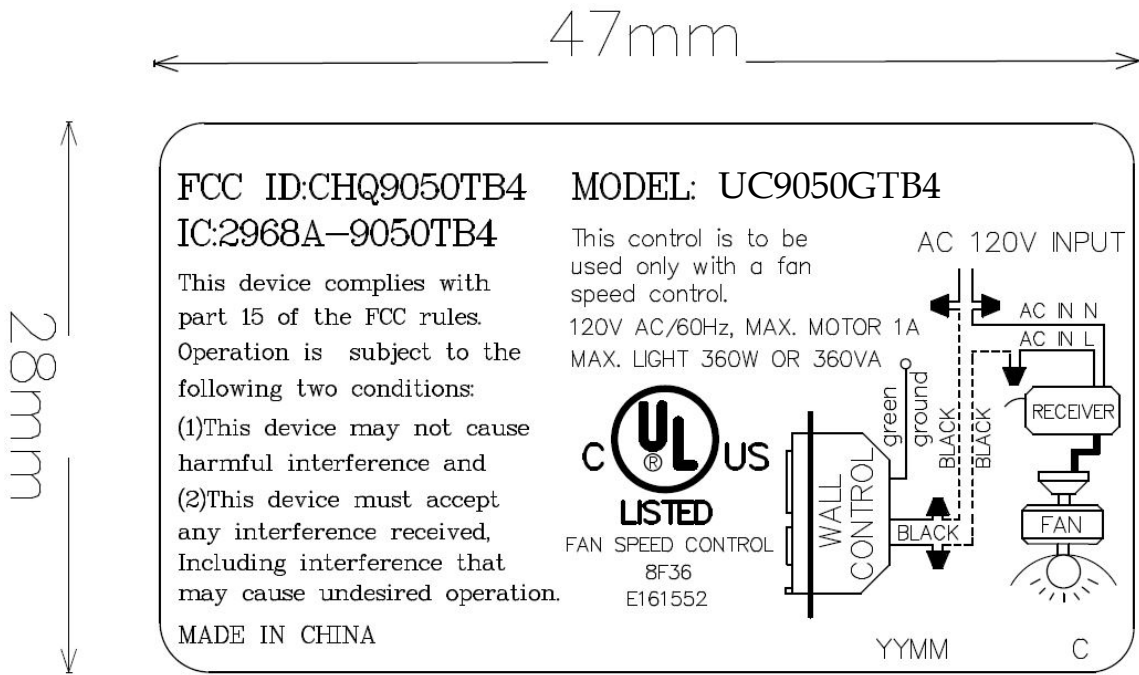

label

22*28mm

MODEL : UC9050GTBD4
FCC ID : CHQ9050TB4
IC : 2968A-9050TB4

This device complies with
part 15 of the FCC rules.
Operation is subject to the
following two conditions:
(1)This device may not cause
harmful interference and
(2)This device must accept
any interference received,
Including interference that
may cause undesired operation.

YYMM

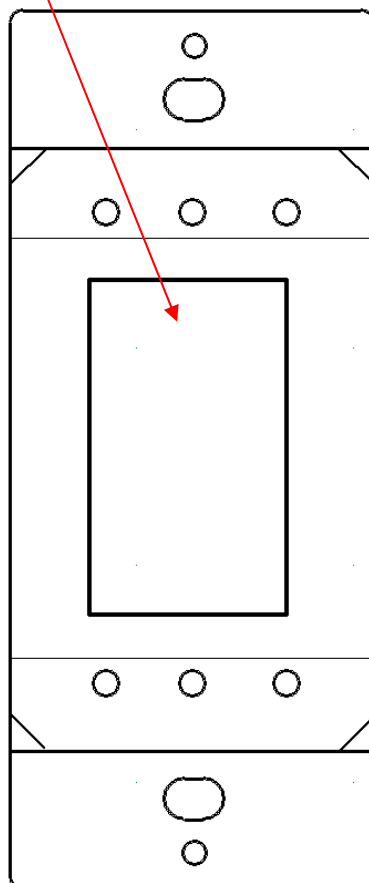

label

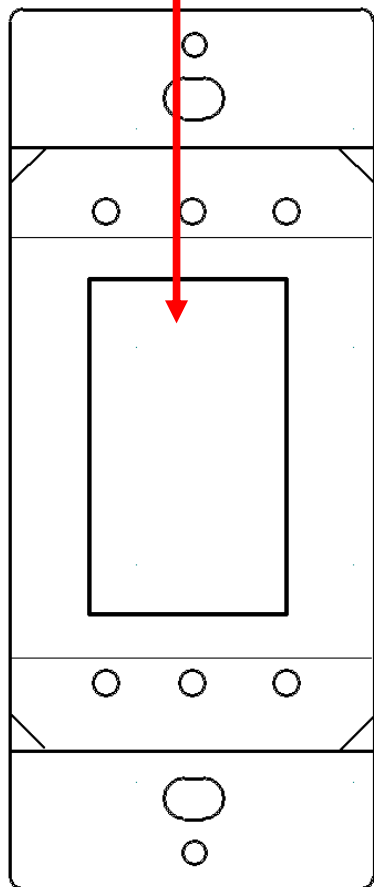
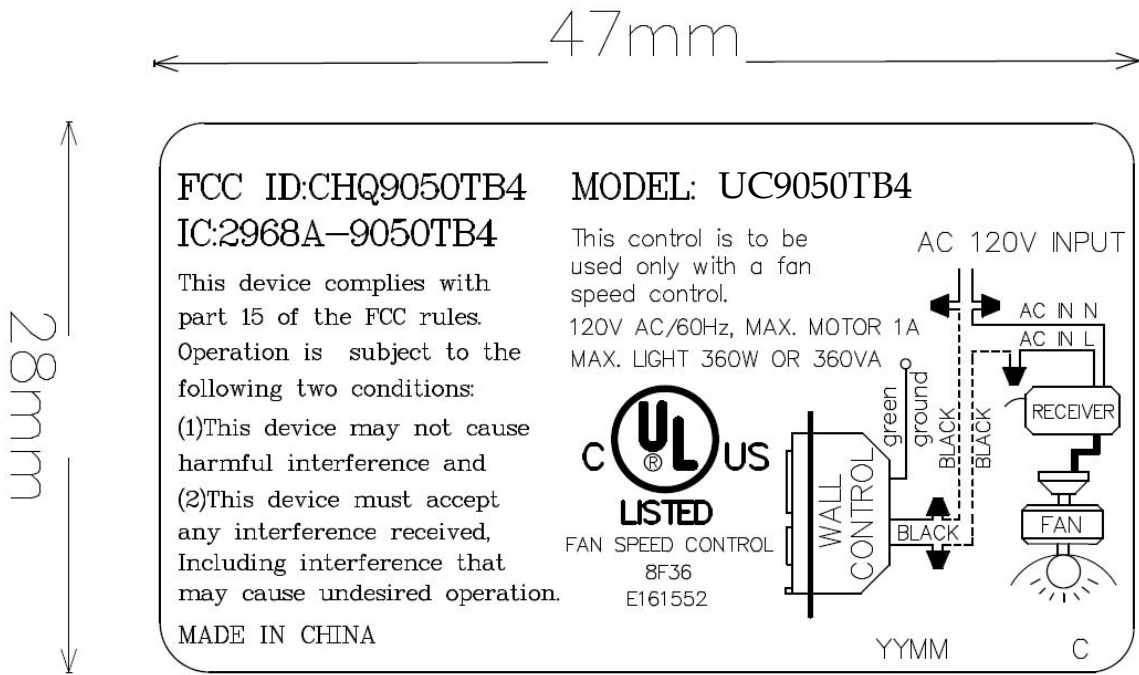

label

22*28mm

MODEL : UC9050TBD4
FCC ID : CHQ9050TB4
IC : 2968A-9050TB4

This device complies with
part 15 of the FCC rules.
Operation is subject to the
following two conditions:
(1)This device may not cause
harmful interference and
(2)This device must accept
any interference received,
Including interference that
may cause undesired operation.

YYMM

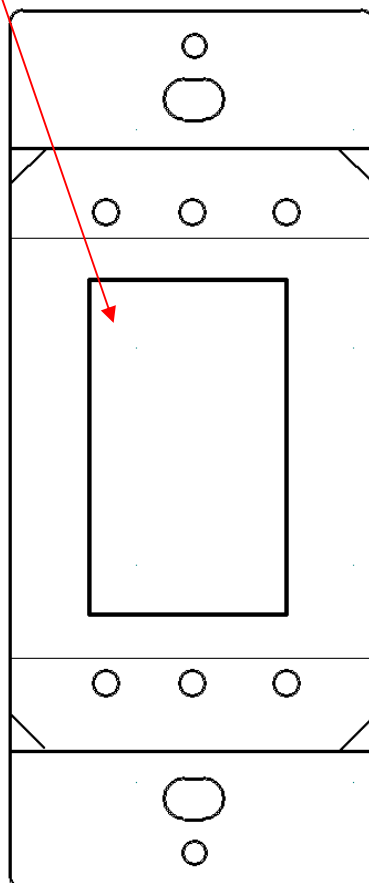

label

47mm

28mm

FCC ID:CHQ9050TB4
IC:2968A-9050TB4

MODEL: UC9051GTB4

This device complies with part 15 of the FCC rules. Operation is subject to the following two conditions:

- (1) This device may not cause harmful interference and
- (2) This device must accept any interference received, including interference that may cause undesired operation.

MADE IN CHINA

This control is to be used only with a fan speed control.
120V AC/60Hz, MAX. MOTOR 1A
MAX. LIGHT 360W OR 360VA



AC 120V INPUT

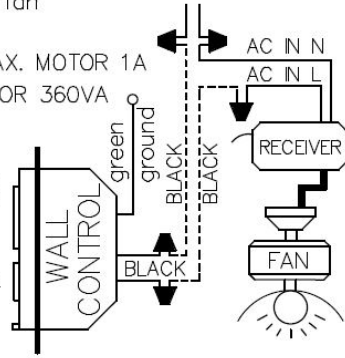

YYMM

C

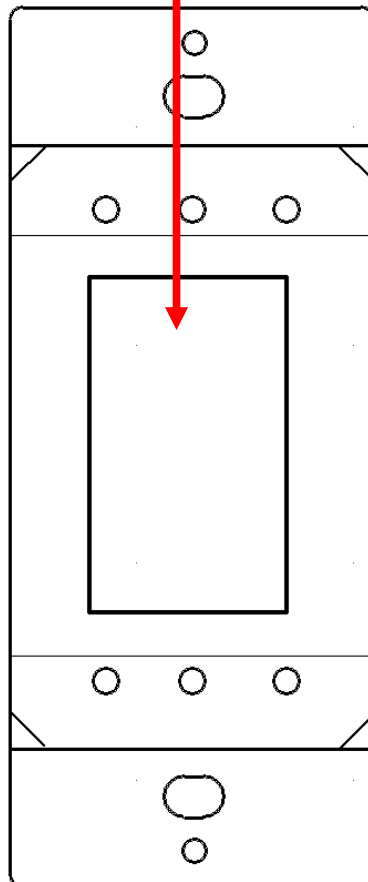

label

22*28mm

MODEL : UC9051GTBD4
FCC ID : CHQ9050TB4
IC : 2968A-9050TB4

This device complies with
part 15 of the FCC rules.
Operation is subject to the
following two conditions:
(1)This device may not cause
harmful interference and
(2)This device must accept
any interference received,
Including interference that
may cause undesired operation.

YYMM

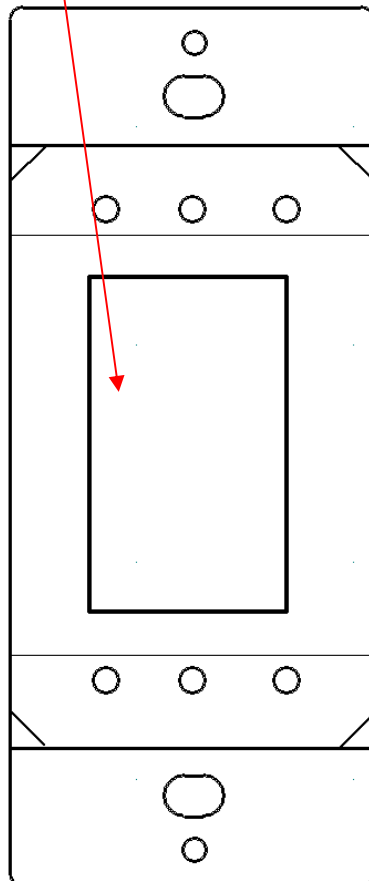

label

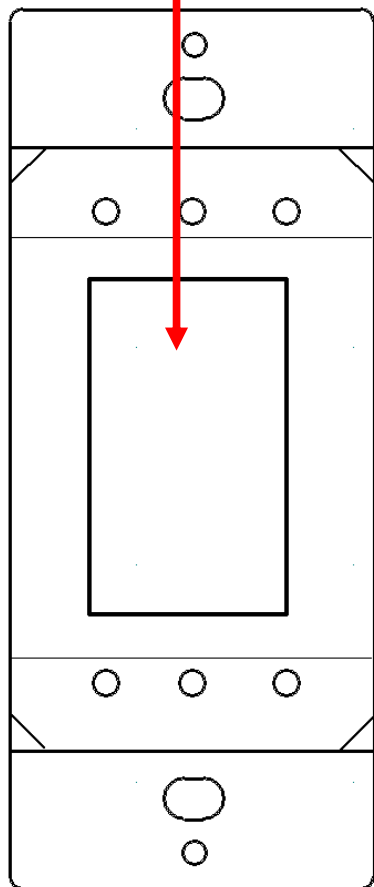
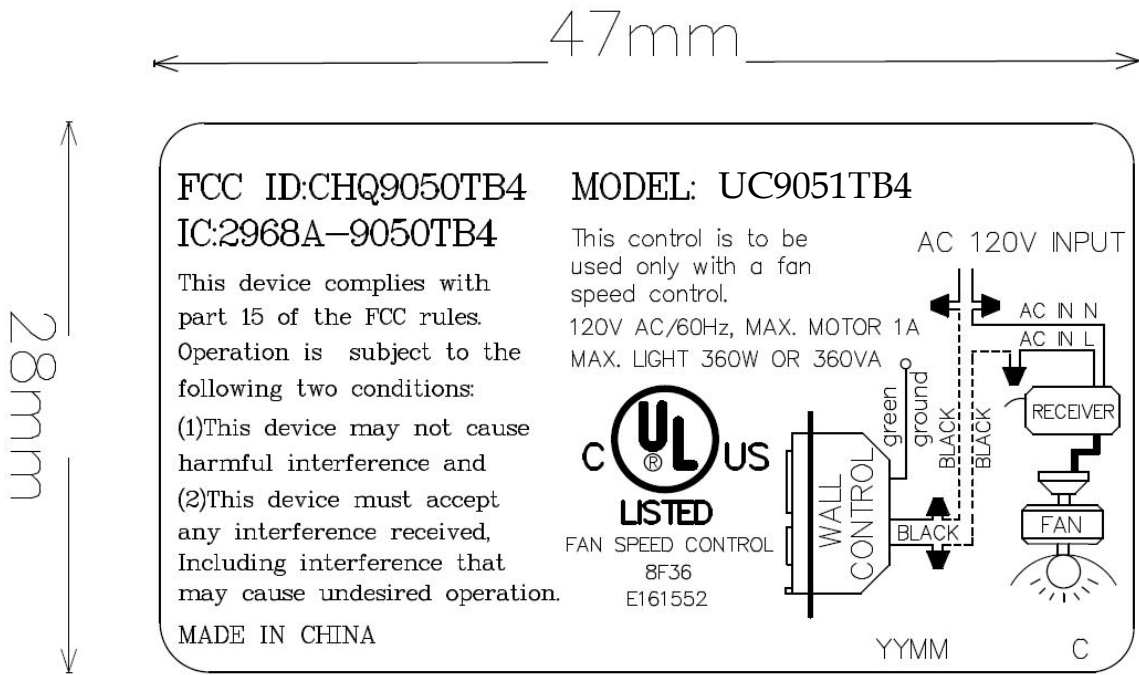

label

22*28mm

MODEL : UC9051TBD4
FCC ID : CHQ9050TB4
IC : 2968A-9050TB4

This device complies with
part 15 of the FCC rules.
Operation is subject to the
following two conditions:
(1)This device may not cause
harmful interference and
(2)This device must accept
any interference received,
Including interference that
may cause undesired operation.

YYMM

