



MEASUREMENT REPORT

FCC ID : CHQ7260T3
IC : 2968A-7260T3
APPLICANT : RHINE ELECTRONIC CO., LTD.
Application Type : Certification
Product : Transmitter
Model No. : UC7260T3
Brand Name : RHINE
FCC Classification : FCC Part 15 Security/Remote Control Transmitter (DSC)
FCC Rule Part(s) : Part 15.231(b)
ISED Standard : RSS 210 Issue 10
Test Procedure(s) : ANSI C63.10-2013
Received Date : October 13, 2022
Test Date : October 14, 2022~ October 18, 2022
Tested By : *Fran Chen*
(Fran Chen)
Reviewed By : *Paddy Chen*
(Paddy Chen)
Approved By : *Chenz Ker*
(Chenz Ker)



The test results only relate to the tested sample.

This equipment has been shown to be capable of compliance with the applicable technical standards as indicated in the measurement report and was tested in accordance with the measurement procedures specified in ANSI C63.10-2013. Test results reported herein relate only to the item(s) tested.

The test report shall not be reproduced except in full without the written approval of MRT Technology (Taiwan) Co., Ltd.

Revision History

Report No.	Version	Description	Issue Date	Note
2210TW5401-U1	1.0	Original Report	2022-11-02	

CONTENTS

Description	Page
1. INTRODUCTION	6
1.1. Scope	6
1.2. MRT Test Location	6
2. PRODUCT INFORMATION	7
2.1. Equipment Description.....	7
2.2. Test Standards	7
2.3. Test Methodology	7
2.4. EUT Setup and Test Mode	8
3. ANTENNA REQUIREMENTS.....	9
4. TEST EQUIPMENT CALIBRATION DATE	10
5. MEASUREMENT UNCERTAINTY.....	11
6. TEST RESULT	12
6.1. Summary	12
6.2. Radiated Emissions	13
6.2.1. Standard Applicable	13
6.2.2. Test Procedure.....	13
6.2.3. Test Setup.....	14
6.2.4. Test Results	15
6.3. 20dB Bandwidth / 99% Bandwidth	21
6.3.1. Standard Applicable	21
6.3.2. Test Procedure.....	21
6.3.3. Test Setup.....	21
6.3.4. Test Result.....	22
6.4. Transmission Time.....	23
6.4.1. Standard Applicable	23
6.4.2. Test Procedure.....	23
6.4.3. Test Setup.....	23
6.4.4. Test Result.....	24
6.5. Duty Cycle	25
6.5.1. Standard Applicable	25
6.5.2. Test Procedure.....	25
6.5.3. Test Setup.....	25
6.5.4. Test Result.....	26
6.6. AC Conducted Emissions Measurement.....	28



6.6.1.	Test Limit	28
6.6.2.	Test Setup.....	28
6.6.3.	Test Result.....	29
7.	CONCLUSION.....	30

§2.1033 General Information

Applicant	RHINE ELECTRONIC CO., LTD.
Applicant Address	No. 29, Fong Li Road, Tan-Zi Dist, Taichung City 42754, Taiwan, R.O.C.
Manufacturer	1. RHINE ELECTRONIC CO., LTD 2. KAM SHING ELECTRONIC CO., LTD
Manufacturer Address	1. No.29, Fengli Rd., Tanzi Dist., Taichung City 427, Taiwan (R.O.C.) 2. THE YOUTH INDUSTRIAL ADMINISTRATION PARK, CHENJIANG TOWN, HUICHENG DISTRICT, HUIZHOU CITY, GUANGDONG, CHINA
Test Site	MRT Technology (Taiwan) Co., Ltd
Test Site Address	No. 38, Fuxing Second Rd., Guishan Dist., Taoyuan City 333, Taiwan (R.O.C)
MRT Registration No.	291082
Test Device Serial No.	#1-1 <input type="checkbox"/> Production <input checked="" type="checkbox"/> Pre-Production <input type="checkbox"/> Engineering
FCC Classification	FCC Part 15 Security/Remote Control Transmitter(DSC)

Test Facility / Accreditations

1. MRT facility is a FCC registered (Reg. No. 291082) test facility with the site description report on file and is designated by the FCC as an Accredited Test Firm.
2. MRT facility is an IC registered (MRT Reg. No. 21723) test laboratory with the site description on file at Industry Canada.
3. MRT Lab is accredited to ISO 17025 by the Taiwan Accreditation Foundation (TAF Cert. No. 3261) in EMC, Telecommunications and Radio testing for FCC (Designation Number: TW3261), Industry Taiwan, EU and TELEC Rules.

1. INTRODUCTION

1.1. Scope

Measurement and determination of electromagnetic emissions (EMC) of radio frequency devices including intentional and/or unintentional radiators for compliance with the technical rules and regulations of the Federal Communications Commission and the Industry Canada Certification and Engineering Bureau.

1.2. MRT Test Location

The map below shows the location of the MRT LABORATORY, its proximity to the Taoyuan City. These measurement tests were conducted at the MRT Technology (Taiwan) Co., Ltd. Facility located at No.38, Fuxing 2nd Rd., Guishan Dist., Taoyuan City 33377, Taiwan (R.O.C).

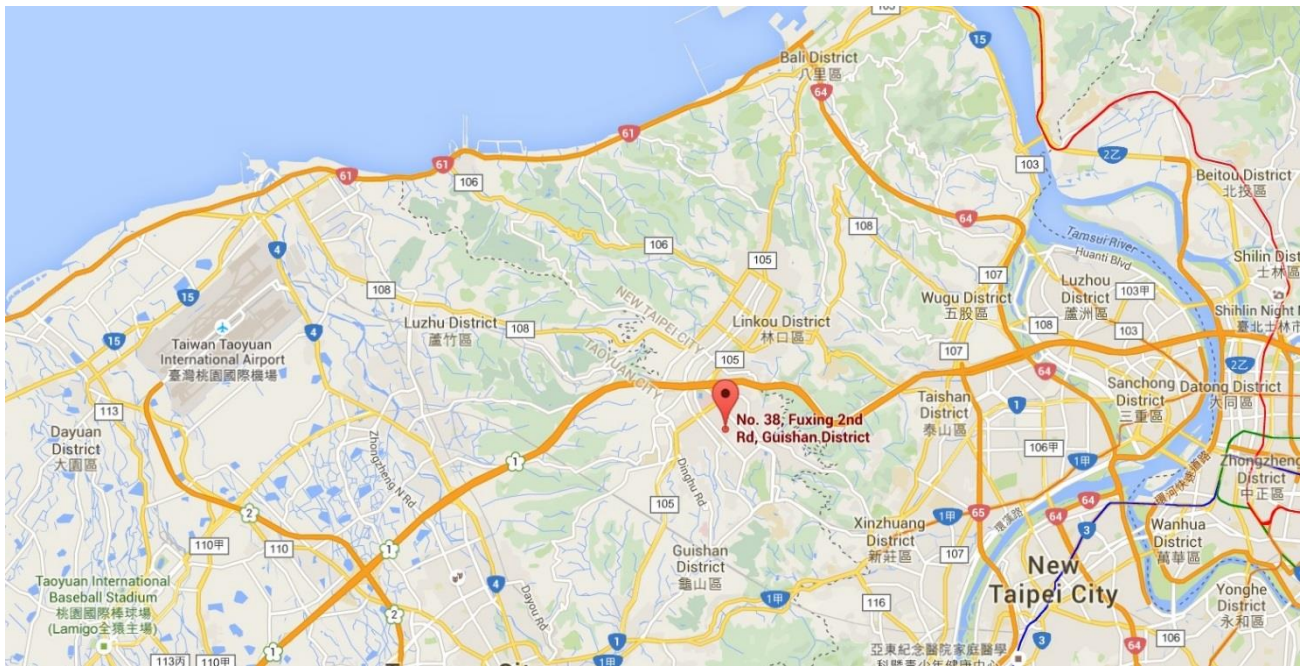

2. PRODUCT INFORMATION

2.1. Equipment Description

Product Name	Transmitter
Model No.	UC7260T3
Frequency Range	303.875 MHz
Type of modulation	ASK
Antenna Type	Integral Antenna

2.2. Test Standards

The following report is prepared on behalf of the **RHINE ELECTRONIC CO., LTD.** in accordance with FCC Part 15, Subpart C, and section 15.231, 15.203, 15.205 and 15.209 of the Federal Communication Commission rules/ IC RSS-Gen 8.8,8.9,8.10 and RSS-210 AnnexA

Maintenance of compliance is the responsibility of the manufacturer. Any modification of the product, which results in lowering the emission/immunity, should be checked to ensure compliance has been maintained.

2.3. Test Methodology

The measurement procedures described in the American National Standard for Testing Unlicensed Wireless Devices (ANSI C63.10-2013).

Deviation from measurement procedure.....None

2.4. EUT Setup and Test Mode

The EUT was operated at continuous transmitting mode that was for the purpose of the measurements. All testing shall be performed under maximum output power condition, and to measure its highest possible emissions level, more detailed description as follows:

Test Mode	
Mode 1	Transmitting by 303.875MHz

3. ANTENNA REQUIREMENTS

Excerpt from §15.203 of the FCC Rules/Regulations:

“An intentional radiator antenna shall be designed to ensure that no antenna other than that furnished by the responsible party can be used with the device. The use of a permanently attached antenna or of an antenna that uses a unique coupling to the intentional radiator shall be considered sufficient to comply with the provisions of this section.”

- The antenna of the **Transmitter** is permanently attached.
- There are no provisions for connection to an external antenna.

Conclusion:

The Transmitter unit complies with the requirement of §15.203.

4. TEST EQUIPMENT CALIBRATION DATE

Conducted Emissions – SR2

Instrument	Manufacturer	Type No.	Asset No.	Cali. Interval	Cali. Due Date
Two-Line V-Network	R&S	ENV216	MRTTWA00019	1 year	2023/3/7
Cable	Rosnol	N1C50-RG400-B 1C50-500CM	MRTTWE00013	1 year	2023/6/19
EMI Test Receiver	R&S	ESR3	MRTTWA00009	1 year	2023/3/9

Radiated Emissions – AC2

Instrument	Manufacturer	Type No.	Asset No.	Cali. Interval	Cali. Due Date
Broadband TRILOG Antenna	SCHWARZBECK	VULB 9162	MRTTWA00001	1 year	2022/11/4
EMI Test Receiver	R&S	ESR3	MRTTWA00009	1 year	2023/3/9
Signal Analyzer	R&S	FSVA3044	MRTTWA00092	1 year	2023/6/23
Active Loop Antenna	Schwarzbeck	FMZB 1519B	MRTTWA00002	1 year	2023/5/24
Broadband Hornantenna	RFSPIN	DRH18-E	MRTTWA00087	1 year	2023/5/10
Breitband Hornantenna	Schwarzbeck	BBHA 9170	MRTTWA00004	1 year	2023/3/29
Broadband Preamplifier	EMC Instruments corporation	EMC118A45SE	MRTTWA00088	1 year	2023/5/9
Broadband Preamplifier	SCHWARZBECK	BBV 9718	MRTTWA00005	1 year	2023/3/30
Cable	HUBERSUHNER	SF106	MRTTWE00034	1 year	2023/6/27

Conducted Test Equipment – SR5

Instrument	Manufacturer	Type No.	Asset No.	Cali. Interval	Cali. Due Date
EXA Signal Analyzer	KEYSIGHT	N9010A	MRTTWA00012	1 year	2023/10/5
EXA Signal Analyzer	KEYSIGHT	N9010B	MRTTWA00074	1 year	2023/7/19
USB Wideband Power Sensor	KEYSIGHT	U2021XA	MRTTWA00015	1 year	2023/3/16

Test Software

Software	Version	Function
e3	9.160520a	EMI Test Software
EMI	V3	EMI Test Software

5. MEASUREMENT UNCERTAINTY

Where relevant, the following test uncertainty levels have been estimated for tests performed on the EUT as specified in CISPR 16-4-2. This uncertainty represents an expanded uncertainty expressed at approximately the 95% confidence level using a coverage factor of $k = 2$.

AC Conducted Emission Measurement – SR2
Measuring Uncertainty for a Level of Confidence of 95% ($U=2Uc(y)$): 150kHz~30MHz: $\pm 2.42\text{dB}$
Conducted Measurement– SR1
Measuring Uncertainty for a Level of Confidence of 95% ($U=2Uc(y)$): $\pm 1.3\text{dB}$
Radiated Emission Measurement – AC1
Measuring Uncertainty for a Level of Confidence of 95% ($U=2Uc(y)$): Horizontal: 9K~30MHz: $\pm 4.14\text{dB}$ 30MHz~1GHz: $\pm 4.22\text{dB}$ 1GHz~40GHz: $\pm 4.05\text{dB}$ Vertical: 9K~30MHz: $\pm 4.14\text{dB}$ 30MHz~1GHz: $\pm 3.37\text{dB}$ 1GHz~40GHz: $\pm 4.08\text{dB}$

6. TEST RESULT

6.1. Summary

Company Name: **RHINE ELECTRONIC CO., LTD.**

FCC/IC Part Section(s)	Test Description	Test Condition	Test Result
15.203	ANTENNA REQUIREMENTS	--	Pass
15.205,15.209,15.231(b)/ RSS Gen 8.9,8.10 RSS-210 Annex A	Radiated Spurious Emissions	Radiated	Pass
15.231(c)/ RSS-210 Annex A.1.3	20dB Bandwidth / 99% Bandwidth		Pass
15.231(a)/ RSS-210 Annex A.1.1(a)	Transmission Time		Pass
15.231(a)/ RSS-210 Annex A.1.1(a)	Duty Cycle		Pass
15.207 / RSS Gen 8.8	AC Conducted Emissions 150kHz - 30MHz		Line Conducted

Notes:

- 1) Determining compliance is based on the test results met the regulation limits or requirements declared by clients, and the test results don't take into account the value of measurement uncertainty.
- 2) All modes of operation and data rates were investigated. The test results shown in the following sections represent the worst case emissions.
- 3) The analyzer plots shown in this section were all taken with a correction table loaded into the analyzer. The correction table was used to account for the losses of the cables and attenuators used as part of the system to connect the EUT to the analyzer at all frequencies of interest.
- 4) The radiation measurements are performed in X, Y, Z axis positioning. Only the worst case is shown in the report.
- 5) The EUT Power by Battery, so do not need to test Conducted Emissions.

6.2. Radiated Emissions

6.2.1. Standard Applicable

According to §15.231(b), the field strength of emissions from intentional radiators operated under this section shall not exceed the following:

Fundamental frequency (MHz)	Field strength of fundamental (microvolts/meter)	Field strength of spurious emissions (microvolts/meter)
40.66-40.70	2,250	225
70-130	1,250	125
130-174	1,250 to 3,750	125 to 375
174-260	3,750	375
260-470	13,750 to 12,500	1375 to 1,250
Above 470	12,500	1,250

The limits on the field strength of the spurious emissions in the above table are based on the fundamental frequency of the intentional radiator. Spurious emissions shall be attenuated to the average (or, alternatively, CISPR quasi-peak) limits shown in this table or to the general limits shown in §15.209, whichever limit permits a higher field strength.

The emission limit in this paragraph is based on measurement instrumentation employing an average detector. The provisions in §15.35 for limiting peak emissions apply. Spurious Radiated Emissions measurements start below or at the lowest crystal frequency.

Compliance with the provisions of §15.205 shall be demonstrated using the measurement instrumentation specified in that section.

6.2.2. Test Procedure

The setup of EUT is according with per ANSI C63.10-2013 measurement procedure. The specification used was with the FCC Part 15.231(b) and FCC Part 15.209 Limit / RSS-Gen 8.9 and RSS-210 Annex A.1.2.

6.2.3. Test Setup

The setup of EUT is according with per ANSI C63.10-2013 measurement procedure. The specification used was with the FCC Part 15.231(b) and FCC Part 15.209 Limit/ RSS-Gen 8.9 and RSS-210 Annex A.1.2.

30MHz ~ 1GHz Test Setup:

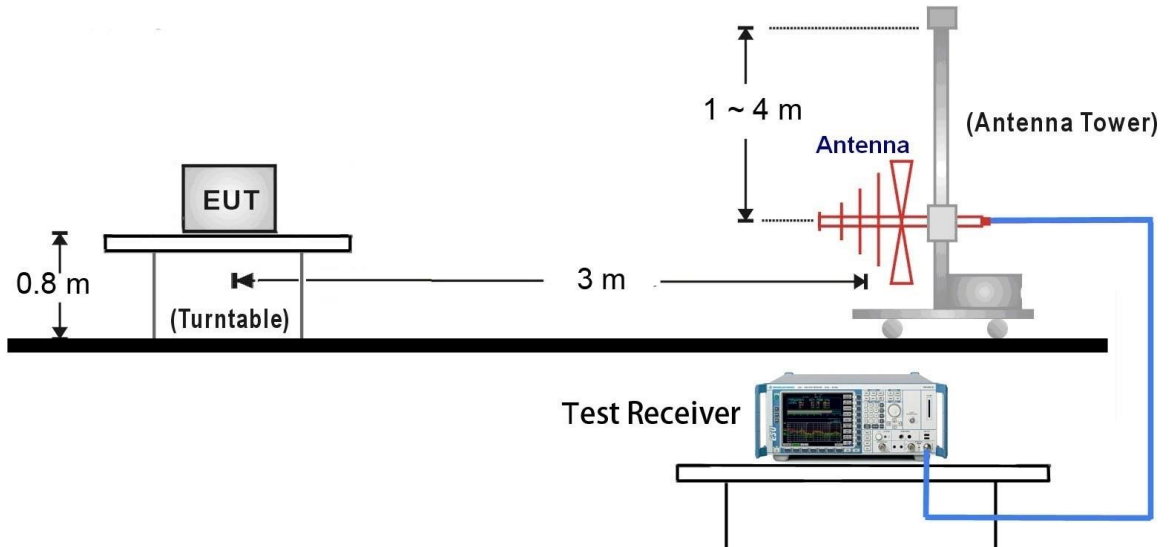

1GHz ~ 5GHz Test Setup:

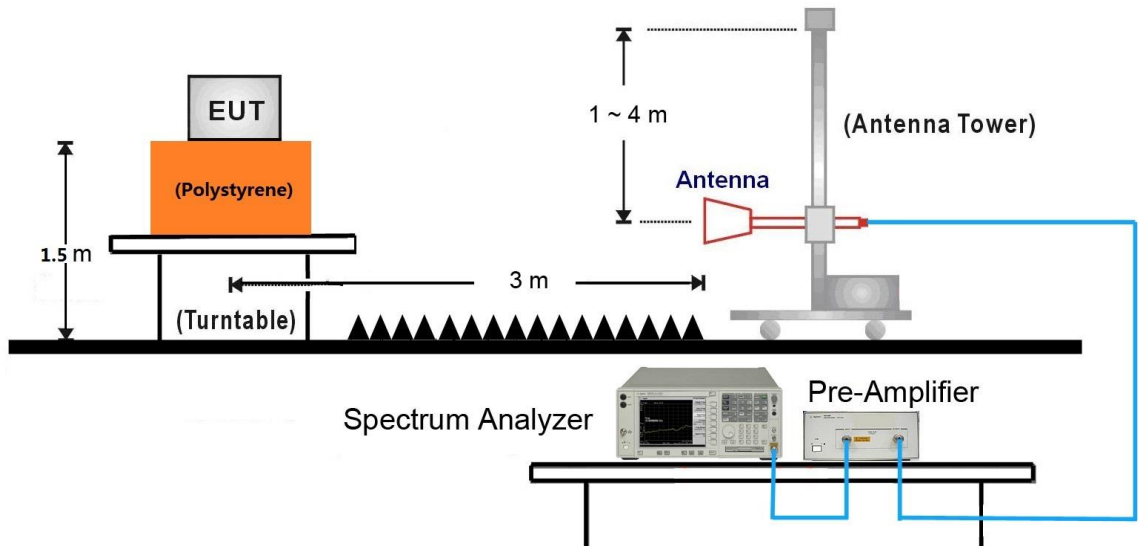

6.2.4. Test Results

EUT	Transmitter	Date of Test	2022-10-18
Factor	VULB 9162	Temp. / Humidity	25°C /65%
Polarity	Horizontal	Site / Test Engineer	AC2 / Ares
Test Mode	TX-303.88MHz	Test Voltage	By Battery

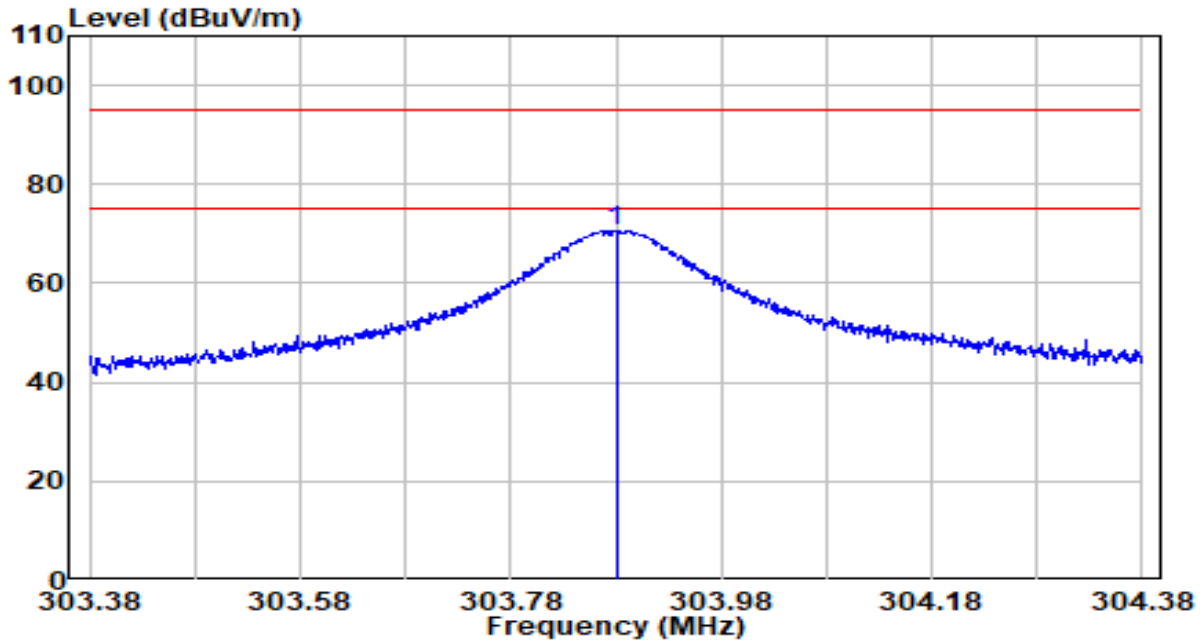

No	Frequency (MHz)	Reading (dBuV)	C.F (dB/m)	Measurement (dBuV/m)	Margin (dB)	Limit (dBuV/m)	Height (cm)	Angle (deg)	Remark (QP/PK/AV)	
1	*	303.880	49.28	21.48	70.77	-24.17	94.94	100	180	Peak

Note:

1. " *", means this data is the worst emission level.
2. C.F (Correction Factor) = Antenna Factor (dB)+ Cable Loss (dB).
3. Measurement (dBuV/m) = Reading(dBuV) + C.F (Correction Factor).
4. The emission levels of other frequencies are very lower than the limit and not show in test report.

EUT	Transmitter	Date of Test	2022-10-18
Factor	VULB 9162	Temp. / Humidity	25°C /65%
Polarity	Vertical	Site / Test Engineer	AC2 / Ares
Test Mode	TX-303.88MHz	Test Voltage	By Battery

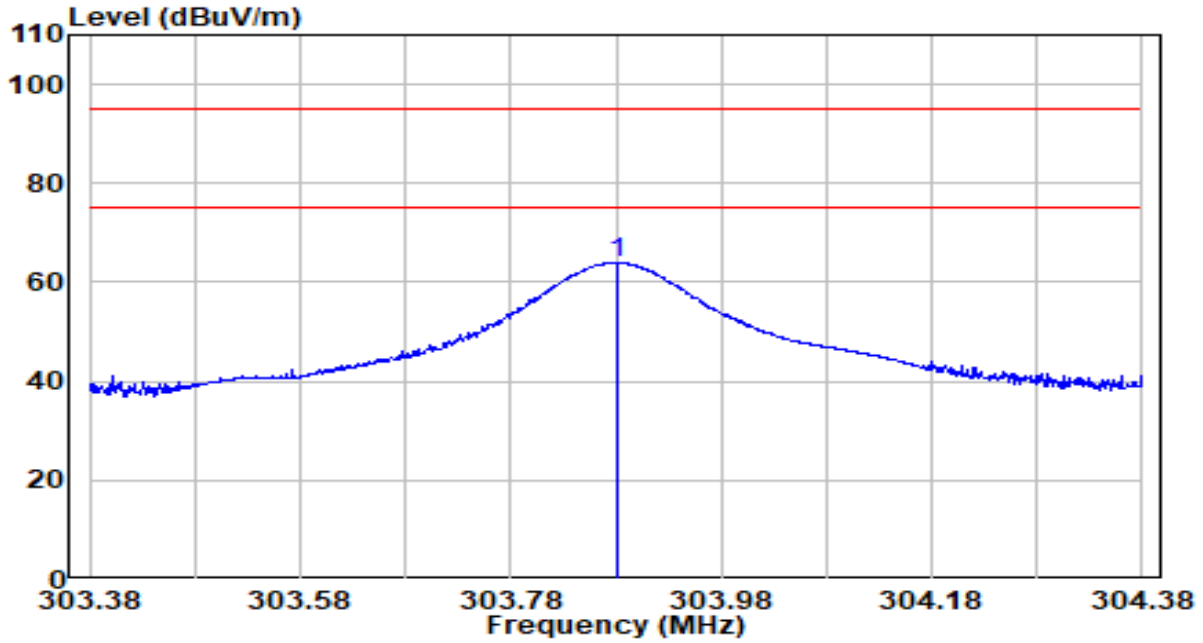

No	Frequency (MHz)	Reading (dBuV)	C.F (dB/m)	Measurement (dBuV/m)	Margin (dB)	Limit (dBuV/m)	Height (cm)	Angle (deg)	Remark (QP/PK/AV)	
1	*	303.882	42.51	21.48	64.00	-30.94	94.94	280	270	Peak

Note:

1. " *", means this data is the worst emission level.
2. C.F (Correction Factor) = Antenna Factor (dB)+ Cable Loss (dB).
3. Measurement (dBuV/m) = Reading(dBuV) + C.F (Correction Factor).
4. The emission levels of other frequencies are very lower than the limit and not show in test report.

EUT	Transmitter	Date of Test	2022-10-18
Factor	VULB 9162	Temp. / Humidity	25°C /65%
Polarity	Horizontal	Site / Test Engineer	AC2 / Ares
Test Mode	TX-303.88MHz	Test Voltage	By Battery

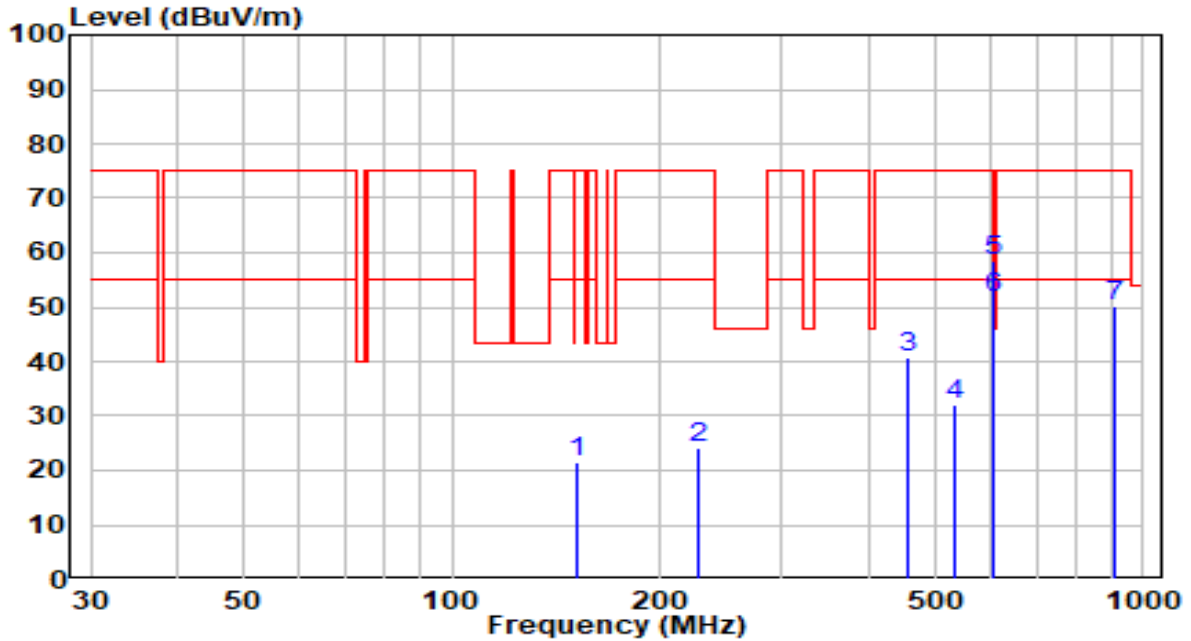

No	Frequency (MHz)	Reading (dBuV)	C.F (dB/m)	Measurement (dBuV/m)	Margin (dB)	Limit (dBuV/m)	Height (cm)	Angle (deg)	Remark (QP/PK/AV)
1	151.250	5.73	15.84	21.56	-53.37	74.93	200	265	Peak
2	227.880	4.34	19.63	23.97	-50.96	74.93	150	70	Peak
3	455.830	16.17	24.58	40.75	-34.18	74.93	200	280	Peak
4	531.490	5.75	26.15	31.90	-43.03	74.93	150	115	Peak
5 *	607.760	30.80	27.77	58.57	-16.36	74.93	150	275	Peak
6 *	607.760	N/A	N/A	51.68	-3.25	54.93	150	275	Average
7	911.730	18.65	31.64	50.28	-24.65	74.93	150	105	Peak

Note:

1. " *", means this data is the worst emission level.
2. C.F (Correction Factor) = Antenna Factor (dB)+ Cable Loss (dB).
3. Measurement (dBuV/m) = Reading(dBuV) + C.F (Correction Factor).
4. The emission levels of other frequencies are very lower than the limit and not show in test report.
5. Average factor (20Log(1/Duty Cycle)) is 6.89dB,
6. Average Measurement = Peak Measurement - Average factor.

EUT	Transmitter	Date of Test	2022-10-18
Factor	VULB 9162	Temp. / Humidity	25°C /65%
Polarity	Vertical	Site / Test Engineer	AC2 / Ares
Test Mode	TX-303.88MHz	Test Voltage	By Battery

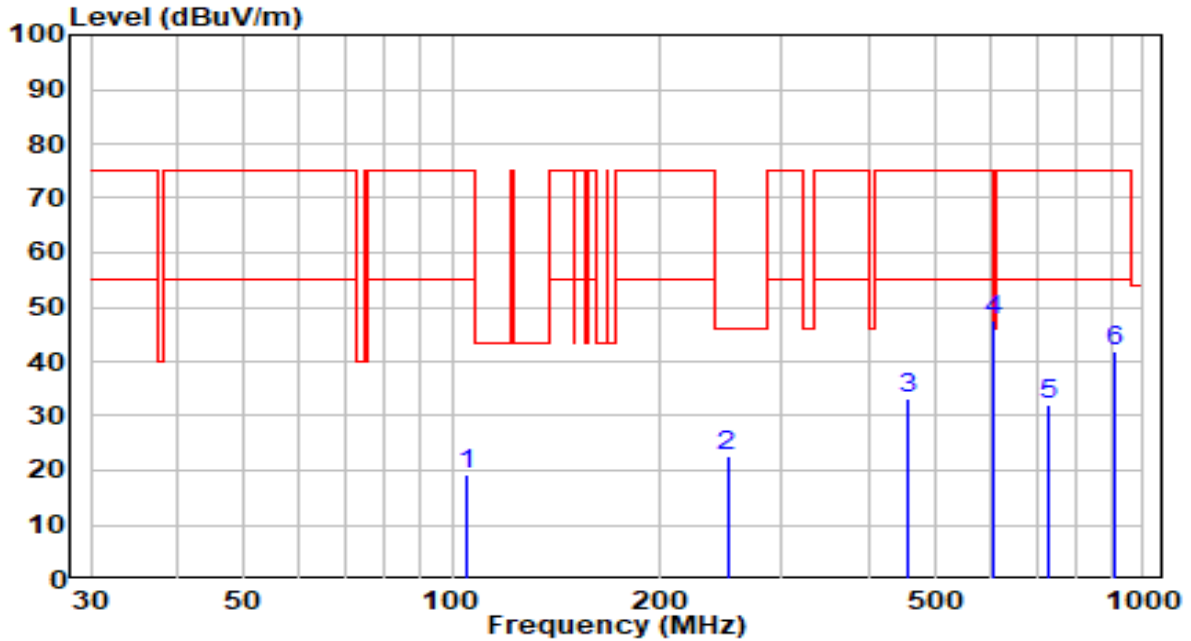

No	Frequency (MHz)	Reading (dBuV)	C.F (dB/m)	Measurement (dBuV/m)	Margin (dB)	Limit (dBuV/m)	Height (cm)	Angle (deg)	Remark (QP/PK/AV)
1	104.690	-0.03	19.10	19.07	-55.86	74.93	150	255	Peak
2	* 250.190	1.72	20.83	22.55	-23.45	46.00	100	275	Peak
3	455.830	8.69	24.58	33.27	-41.66	74.93	200	360	Peak
4	607.760	19.72	27.77	47.49	-27.44	74.93	150	190	Peak
5	731.310	2.89	29.35	32.24	-42.69	74.93	200	245	Peak
6	911.730	10.14	31.64	41.78	-33.15	74.93	150	180	Peak

Note:

- " *", means this data is the worst emission level.
- C.F (Correction Factor) = Antenna Factor (dB)+ Cable Loss (dB).
- Measurement (dBuV/m) = Reading(dBuV) + C.F (Correction Factor).
- The emission levels of other frequencies are very lower than the limit and not show in test report.

EUT	Transmitter	Date of Test	2022-10-18
Factor	DRH18-E	Temp. / Humidity	25°C /65%
Polarity	Horizontal	Site / Test Engineer	AC2 / Ares
Test Mode	TX-303.88MHz	Test Voltage	By Battery

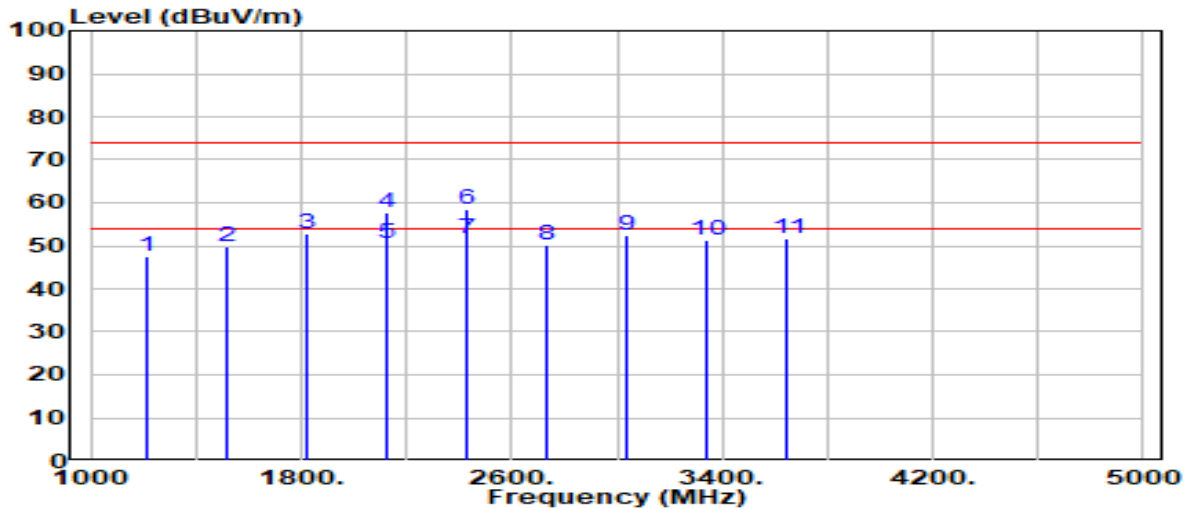

No	Frequency (MHz)	Reading (dBuV)	C.F (dB/m)	Measurement (dBuV/m)	Margin (dB)	Limit (dBuV/m)	Height (cm)	Angle (deg)	Remark (QP/PK/AV)
1	1215.294	55.06	-7.46	47.61	-26.39	74.00	150	360	Peak
2	1519.294	56.79	-7.03	49.76	-24.24	74.00	150	360	Peak
3	1823.294	59.73	-6.77	52.96	-21.04	74.00	150	360	Peak
4	2127.294	62.92	-5.29	57.63	-16.37	74.00	150	360	Peak
5	2127.294	N/A	N/A	50.74	-3.26	54.00	150	360	Average
6	* 2431.059	63.36	-4.92	58.44	-15.56	74.00	150	360	Peak
7	* 2431.059	N/A	N/A	51.55	-2.45	54.00	150	360	Average
8	2735.059	53.89	-3.83	50.07	-23.93	74.00	150	360	Peak
9	3038.823	55.37	-3.07	52.30	-21.70	74.00	150	360	Peak
10	3342.353	54.36	-2.86	51.51	-22.49	74.00	150	360	Peak
11	3646.118	53.68	-1.87	51.82	-22.18	74.00	150	360	Peak

Note:

1. " *", means this data is the worst emission level.
2. C.F (Correction Factor) = Antenna Factor (dB)+ Cable Loss (dB) – Preamplifier(dB).
3. Measurement (dBuV/m) = Reading(dBuV) + C.F (Correction Factor).
4. The emission levels of other frequencies are very lower than the limit and not show in test report.
5. Average factor (20Log(1/Duty Cycle)) is 6.89dB.
6. Average Measurement = Peak Measurement - Average factor.

EUT	Transmitter	Date of Test	2022-10-18
Factor	DRH18-E	Temp. / Humidity	25°C /65%
Polarity	Vertical	Site / Test Engineer	AC2 / Ares
Test Mode	TX-303.88MHz	Test Voltage	By Battery

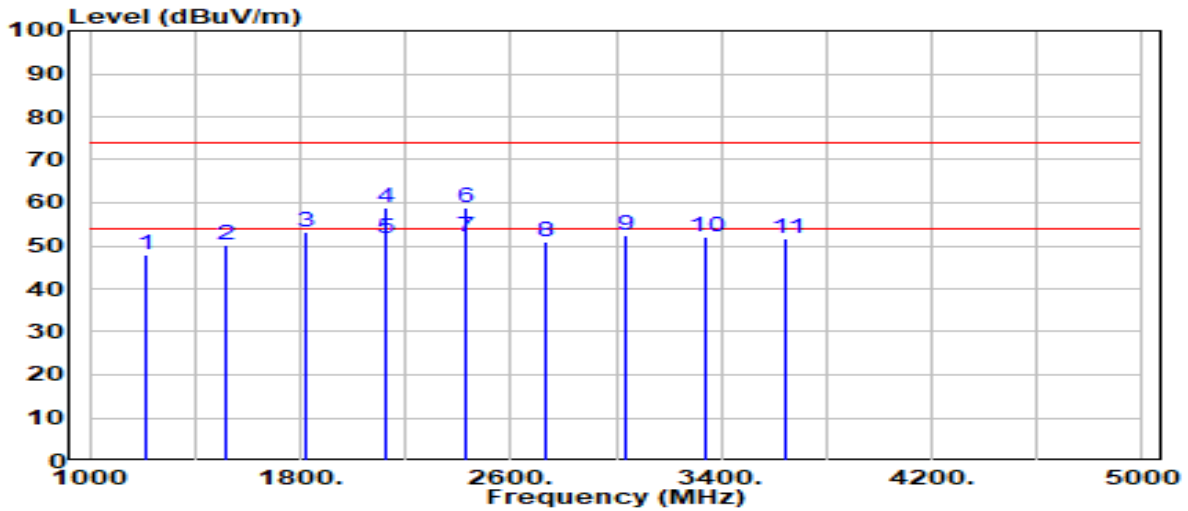

No	Frequency (MHz)	Reading (dBUV)	C.F (dB/m)	Measurement (dBUV/m)	Margin (dB)	Limit (dBUV/m)	Height (cm)	Angle (deg)	Remark (QP/PK/AV)
1	1215.059	55.40	-7.46	47.95	-26.05	74.00	150	360	Peak
2	1519.059	57.36	-7.03	50.33	-23.67	74.00	150	360	Peak
3	1823.294	60.10	-6.77	53.33	-20.67	74.00	150	360	Peak
4	2127.529	64.03	-5.29	58.75	-15.25	74.00	150	360	Peak
5	2127.529	N/A	N/A	51.86	-2.14	54.00	150	360	Average
6 *	2431.059	63.82	-4.92	58.91	-15.09	74.00	150	360	Peak
7 *	2431.059	N/A	N/A	52.02	-1.98	54.00	150	360	Average
8	2735.059	54.73	-3.83	50.91	-23.09	74.00	150	360	Peak
9	3039.765	55.58	-3.07	52.51	-21.49	74.00	150	360	Peak
10	3343.059	54.83	-2.86	51.97	-22.03	74.00	150	360	Peak
11	3646.118	53.68	-1.87	51.82	-22.18	74.00	150	360	Peak

Note:

1. " *", means this data is the worst emission level.
2. C.F (Correction Factor) = Antenna Factor (dB)+ Cable Loss (dB) – Preamplifier(dB).
3. Measurement (dBUV/m) = Reading(dBUV) + C.F (Correction Factor).
4. The emission levels of other frequencies are very lower than the limit and not show in test report.
5. Average factor (20Log(1/Duty Cycle)) is 6.89dB.
6. Average Measurement = Peak Measurement - Average factor.

6.3. 20dB Bandwidth / 99% Bandwidth

6.3.1. Standard Applicable

According to FCC Part 15.231(c), the bandwidth of the emission shall be no wider than 0.25% of the center frequency for devices operating above 70MHz and below 900MHz. Bandwidth is determined at the points 20 dB down from the modulated carrier.

6.3.2. Test Procedure

With the EUT's antenna attached, the EUT's 20dB Bandwidth power was received by the test antenna, which was connected to the spectrum analyzer with the START, and STOP frequencies set to the EUT's operation band.

6.3.3. Test Setup

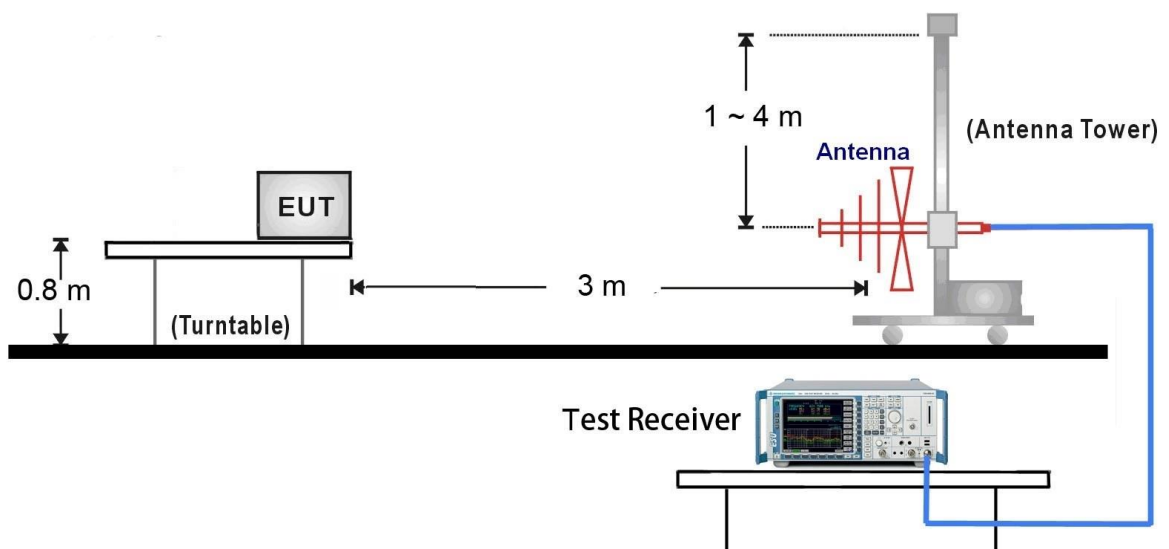

6.3.4. Test Result

Test Frequency (MHz)	Modulation Type	20dB Bandwidth (KHz)	99% Bandwidth (KHz)	Limit (KHz)	Result
303.88	ASK	9.9	32.567	≤ 759.7	Pass

Limit = Fundamental Frequency * 0.25%, 303.88 MHz * 0.25% = 0.7597MHz
 0.7597MHz * 1000= 759.7KHz



6.4. Transmission Time

6.4.1. Standard Applicable

According to FCC 15.231(a)(1), A manually operated transmitter shall employ a switch that will automatically deactivate the transmitter within not more than 5 seconds of being released.

6.4.2. Test Procedure

With the EUT's antenna attached, the EUT's output signal was received by the test antenna, which was connected to the spectrum analyzer. Set the center frequency to 434MHz, then set the spectrum analyzer to Zero Span for the release time reading. During the testing, the switch was released then the EUT automatically deactivated.

6.4.3. Test Setup

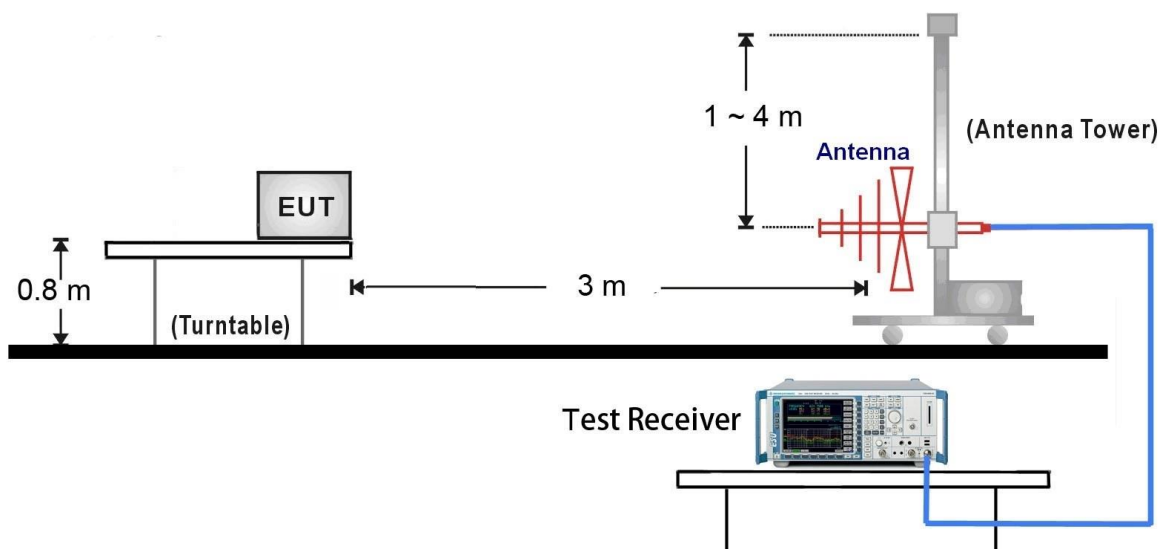

6.4.4. Test Result

Test Item	Frequency (MHz)	Measurement (s)	Limit (s)	Result
Transmission Time (T_{on})	303.88	1.52	< 5	Pass



6.5. Duty Cycle

6.5.1. Standard Applicable

According to FCC Part 15.231(b) and 15.35(c), for pulse operation transmitter, the averaging pulsed emissions are calculated by peak value of measured emission plus duty cycle factor.

6.5.2. Test Procedure

With the EUT's antenna attached, the EUT's output signal was received by the test antenna, which was connected to the spectrum analyzer. Set the center frequency to 434MHz, then set the spectrum analyzer to Zero Span for the release time reading. During the testing, the switch was released then the EUT automatically deactivated.

6.5.3. Test Setup

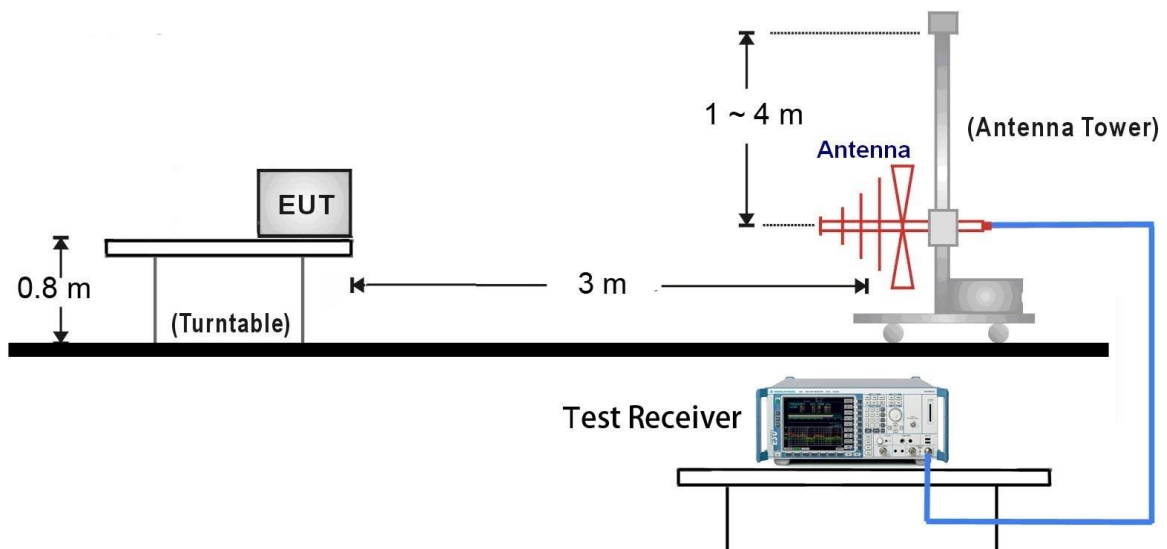

6.5.4. Test Result

Modulation Type	Total Time (T _{on}) (ms)	The duration of one cycle (ms)	Duty Cycle (ms)	Average Factor (dB)
ASK	19.9	44.00	0.45	6.89

Note 1: Duty Cycle = Total Time (T_{on}) / (T_{on} + T_{off}).

(Long 700us*19)+(Median 450us*10)+(Short 350us*6) =19900us, 19900us / 1000 = 19.9ms

Note 2: Average Factor = 20*Log*(1/Duty Cycle).

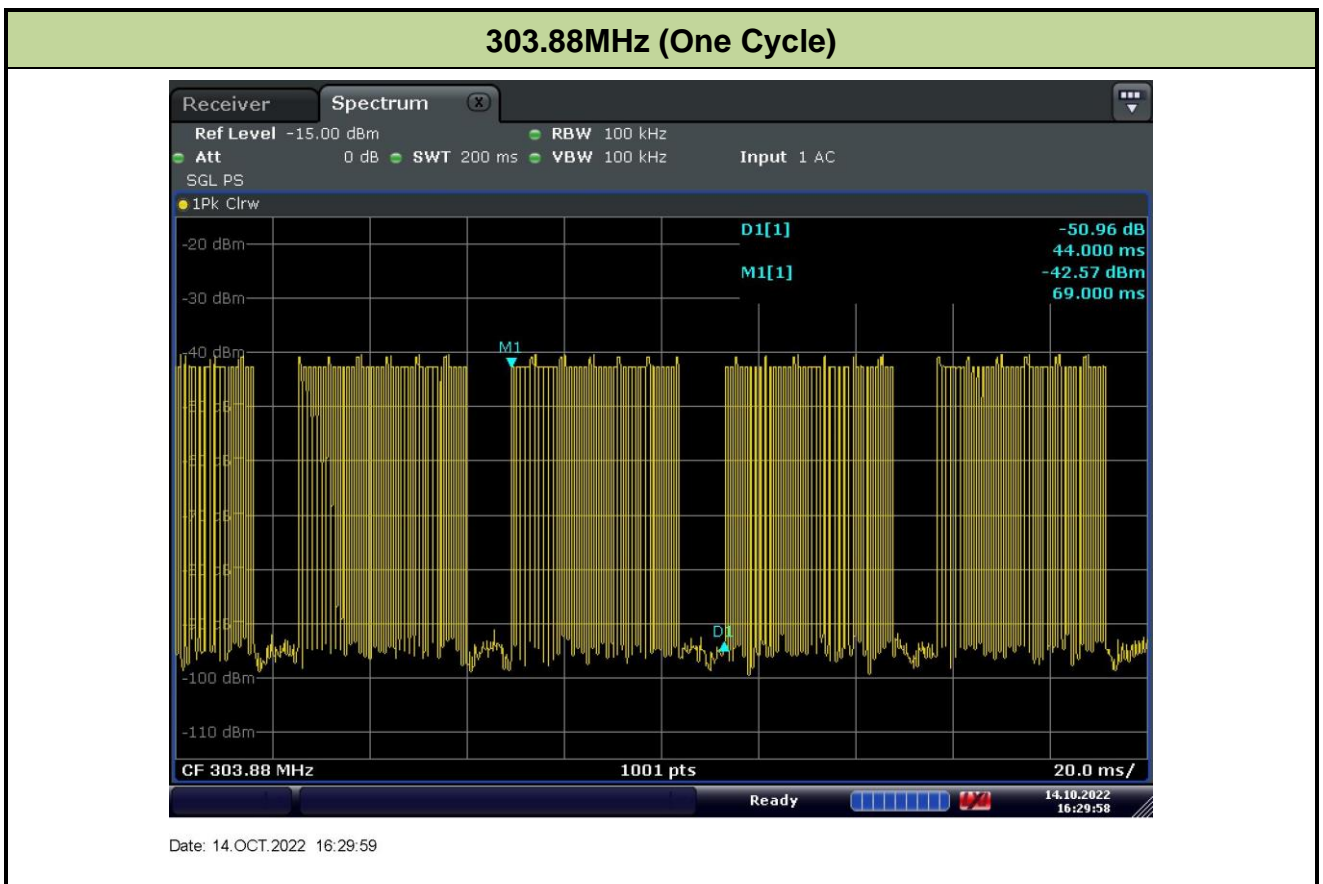

303.88MHz (T_{on}-Long)

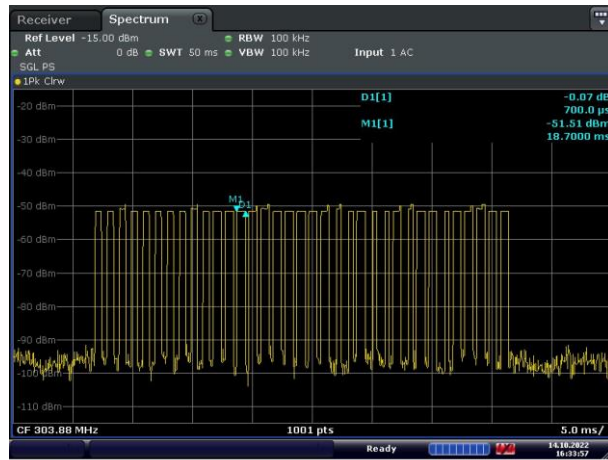

Date: 14.OCT.2022 16:33:57

303.88MHz (T_{on}-Middle)

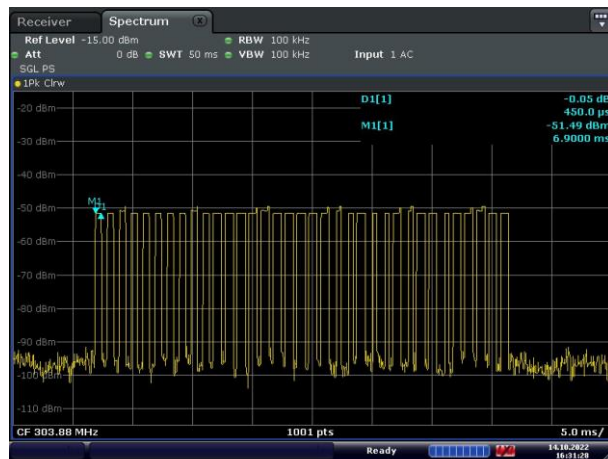

Date: 14.OCT.2022 16:31:29

303.88MHz (T_{on}-Short)

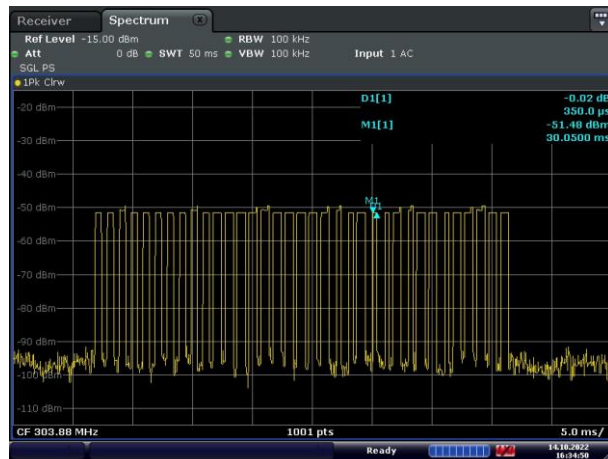

Date: 14.OCT.2022 16:34:50

6.6. AC Conducted Emissions Measurement

6.6.1. Test Limit

FCC Part 15 Subpart C Paragraph 15.207 / RSS-Gen Limits		
Frequency (MHz)	QP (dB μ V)	Average (dB μ V)
0.15 - 0.50	66 - 56	56 - 46
0.50 - 5.0	56	46
5.0 - 30	60	50

Note 1: The lower limit shall apply at the transition frequencies.

Note 2: The limit decreases linearly with the logarithm of the frequency in the range 0.15MHz to 0.5MHz.

6.6.2. Test Setup

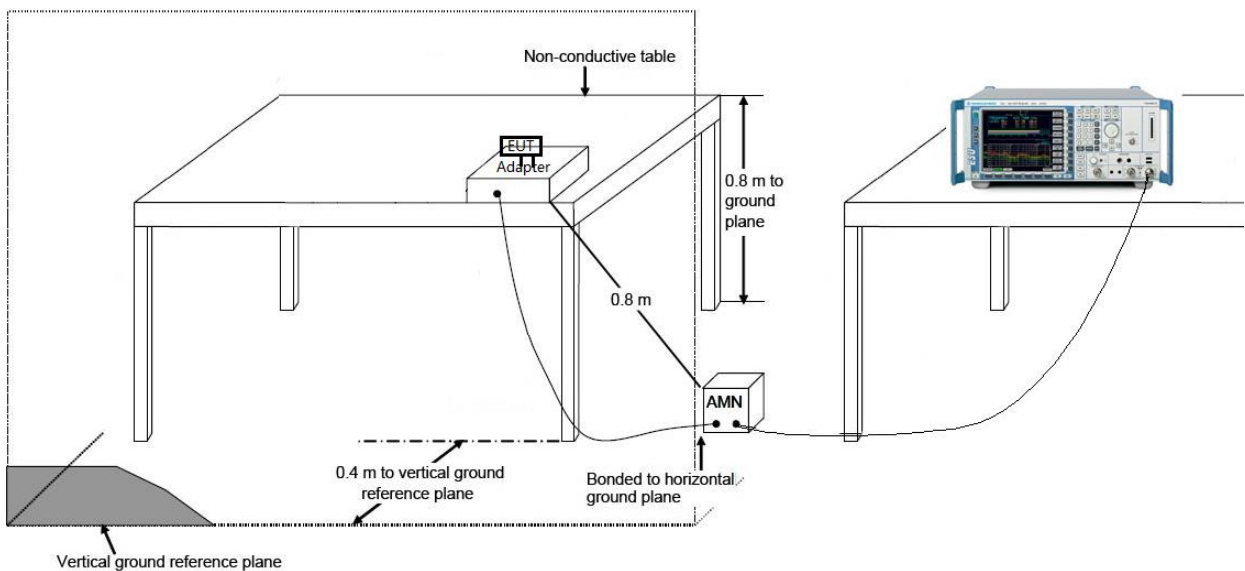

6.6.3. Test Result

Note: The EUT Power by Battery, so do not need to test Conducted Emissions.

7. CONCLUSION

The data collected relate only the item(s) tested and show that the **Transmitter** is in compliance with FCC Rules/ IC RSS 210 Annex A1.1.

————— The End —————