

FCC PART 15
EMI MEASUREMENT AND TEST REPORT

For
WESTELL Technologies Inc.

750 North Commons Drive
Aurora, IL 60504

FCC ID: CH8327WXX-6

2004-02-09

This Report Concerns: <input checked="" type="checkbox"/> Original Report	Equipment Type: 802.11b/g Wireless ADSL 4-port Ethernet/USB Router
Test Engineer: Ming Jing /	
Report No.: R04011910	
Test Date: 2004-01-24	
Reviewed By: Ling Zhang /	
Prepared By: Bay Area Compliance Laboratory Corporation (BACL) 230 Commercial Street Sunnyvale, CA 94085 Tel: (408) 732-9162 Fax: (408) 732 9164	

Note: This test report is specially limited to the above client company and product model only. It may not be duplicated without prior written consent of Bay Area Compliance Laboratory Corporation. This report **must not** be used by the client to claim product endorsement by NVLAP or any agency of the U.S. Government.

TABLE OF CONTENTS

GENERAL INFORMATION.....4

 PRODUCT DESCRIPTION FOR EQUIPMENT UNDER TEST (EUT)4

 OBJECTIVE4

 RELATED SUBMITTAL(S)/GRANT(S).....4

 TEST METHODOLOGY4

 TEST FACILITY4

 SUPPORT EQUIPMENT LIST AND DETAILS5

 EXTERNAL I/O CABLING LIST AND DETAILS5

SYSTEM TEST CONFIGURATION.....6

 JUSTIFICATION6

 EUT EXERCISE SOFTWARE6

 SPECIAL ACCESSORIES.....6

 SCHEMATICS / BLOCK DIAGRAM6

 EQUIPMENT MODIFICATIONS6

 CONFIGURATION OF TEST SYSTEM7

 TEST SETUP BLOCK DIAGRAM.....7

SUMMARY OF TEST RESULTS8

§15.203 - ANTENNA REQUIREMENT.....9

 STANDARD APPLICABLE9

§15.207(A) - CONDUCTED EMISSIONS.....10

 MEASUREMENT UNCERTAINTY10

 EUT SETUP.....10

 SPECTRUM ANALYZER SETUP.....10

 TEST EQUIPMENT LIST AND DETAILS.....10

 TEST PROCEDURE10

 SUMMARY OF TEST RESULTS11

 CONDUCTED EMISSIONS TEST DATA11

 PLOT OF CONDUCTED EMISSIONS TEST DATA11

§15.209(A) - SPURIOUS EMISSION14

 STANDARD APPLICABLE14

 MEASUREMENT PROCEDURE.....14

 EQUIPMENT LISTS14

 MEASUREMENT RESULT15

§15.209(F) - SPURIOUS RADIATED EMISSION.....22

 MEASUREMENT UNCERTAINTY22

 EUT SETUP.....23

 SPECTRUM ANALYZER SETUP23

 TEST EQUIPMENT LIST AND DETAILS.....23

 TEST PROCEDURE24

 CORRECTED AMPLITUDE & MARGIN CALCULATION24

 SUMMARY OF TEST RESULTS24

 RADIATED EMISSION TEST RESULT FOR 802.11B.....25

 RADIATED EMISSION TEST RESULT FOR 802.11G27

§15.247(A)(2) – 6 DB BANDWIDTH29

 STANDARD APPLICABLE29

 MEASUREMENT PROCEDURE.....29

 EQUIPMENT LISTS29

 MEASUREMENT RESULT29

§15.247(B)(3) - PEAK OUTPUT POWER MEASUREMENT.....33

 STANDARD APPLICABLE33

 MEASUREMENT PROCEDURE.....33

 EQUIPMENT LISTS33

MEASUREMENT RESULT	33
§15.247(C) - 100 KHZ BANDWIDTH OF BAND EDGES	37
STANDARD APPLICABLE	37
MEASUREMENT PROCEDURE.....	37
EQUIPMENT LISTS	37
MEASURE RESULTS.....	37
§15.247(D) - POWER SPECTRAL DENSITY	42
STANDARD APPLICABLE	42
MEASUREMENT PROCEDURE.....	42
EQUIPMENT LISTS	42
MEASUREMENT RESULTS.....	43

GENERAL INFORMATION

Product Description for Equipment Under Test (EUT)

The *WESTELL Technologies Inc.* 's, model: *A90-327WXX-06*, or the "EUT" as referred to in this report is an 802.11b/g Wireless ADSL 4-port Ethernet/USB Router which is measured approximately 8.1"L x 6.8"W x 7.5"H.

The EUT utilized the Aztech power adapter, M/N: SY-0901.

** The test data gathered are from a production sample, S/N: 00300A10540C, provided by the manufacturer.*

Objective

This type approval report is prepared on behalf of *WESTELL Technologies Inc.* in accordance with Part 2, Subpart J, Part 15, Subparts A, B and C of the Federal Communication Commissions rules.

The objective is to determine compliance with FCC rules for Output Power, Antenna Requirements, 6 dB Bandwidth, power spectral density, 100 kHz Bandwidth of Band Edges Measurement, Out of Band Emission, Spurious Emission, Conducted and Spurious Radiated Emission.

Related Submittal(s)/Grant(s)

No Related Submittals.

Test Methodology

All measurements contained in this report were conducted with ANSI C63.4-2001, American National Standard for Methods of Measurement of Radio-Noise Emissions from Low-Voltage Electrical and Electronic Equipment in the range of 9 kHz to 40 GHz.

All radiated and conducted emissions measurement was performed at Bay Area Compliance Laboratory, Corp. The radiated testing was performed at an antenna-to-EUT distance of 3 meters.

Test Facility

The Open Area Test site used by BACL to collect radiated and conducted emission measurement data is located in the back parking lot of the building at 230 Commercial Street, Sunnyvale, California, USA.

Test site at BACL has been fully described in reports submitted to the Federal Communication Commission (FCC) and Voluntary Control Council for Interference (VCCI). The details of these reports has been found to be in compliance with the requirements of Section 2.948 of the FCC Rules on February 11 and December 10, 1997 and Article 8 of the VCCI regulations on December 25, 1997. The facility also complies with the radiated and AC line conducted test site criteria set forth in ANSI C63.4-2001.

The Federal Communications Commission and Voluntary Control Council for Interference has the reports on file and is listed under FCC file 31040/SIT 1300F2 and VCCI Registration No.: C-1298 and R-1234. The test site has been approved by the FCC and VCCI for public use and is listed in the FCC Public Access Link (PAL) database.

Additionally, BACL is a National Institute of Standards and Technology (NIST) accredited laboratory, under the National Voluntary Laboratory Accredited Program (Lab Code 200167-0). The scope of the accreditation covers the FCC Method – 47 CFR Part – Digital Devices, CISPER 22: 1997: Electromagnetic Interference – Limits and Methods of Measurement of Information Technology Equipment test methods.

Support Equipment List and Details

Manufacturer	Description	Model	Serial Number	FCC ID
Wien Sonic	Monitor	G655	N/A	N/A
HP	Computer	6745C	N/A	N/A
Dell	Keyboard	N/A	CN-09C487-38840-22R-1274	N/A
Dell	Mouse	N/A	8783844-7	N/A
HP	Printer	Thinkjet 2225C+	N/A	N/A
Everex	Modem	Evercom 24E	N/A	N/A

External I/O Cabling List and Details

Cable Description	Length (M)	Port/From	To
Shielded KB Cable	1.6	KB Port / PC	Keyboard
Shielded Cable	1.5	Mouse Port/ PC	Mouse
RJ 15 Cable	1.5	DSL Port / EUT	EVEREX Modem
Shielded Printer Cable	2	Parallel / PC	HP Printer
Shielded Video Cable	1.8	VGA / PC	Monitor
Ethernet Cable	1.0	Ethernet Port / PC	RJ45 Port / EUT

SYSTEM TEST CONFIGURATION

Justification

The host system was configured for testing according to ANSI C63.4-2001.

The EUT was tested in the normal (native) operating mode to represent *worst*-case results during the final qualification test.

EUT Exercise Software

The EUT exercise program used during radiated and conducted testing was designed to exercise the system components. The test software, provided by the customer, is started the Windows terminal program under the Windows 98/2000/ME/XP operating system.

Once loaded, set the Tx channel to low, mid and high for testing.

Special Accessories

As shown in following test block diagram, all interface cables used for compliance testing are shielded. The host PC and the peripherals featured shielded metal connectors.

Schematics / Block Diagram

Please refer to Appendix A.

Equipment Modifications

No modifications were made to the EUT.

Configuration of Test System

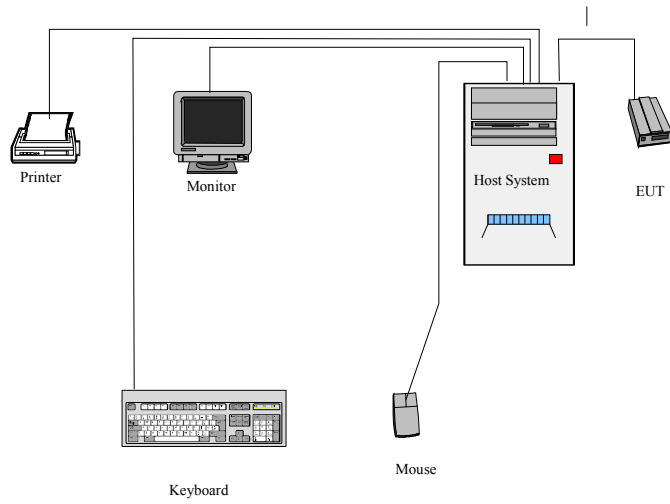

Test Setup Block Diagram

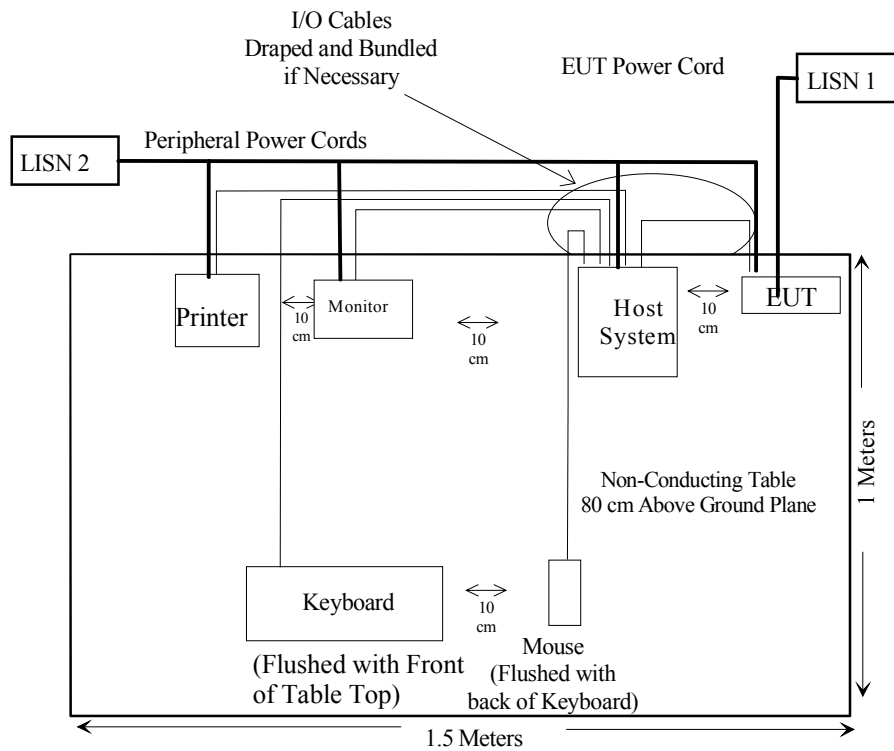

SUMMARY OF TEST RESULTS

Results reported relate only to the product tested, serial number: 00300A10540C.

FCC RULES	DESCRIPTION OF TEST	RESULT
§2.1091	RF Exposure	Pass
§15.203	Antenna Requirement	Pass
§ 15.207 (a)	Conducted Emissions	Pass
§15.209 (a)	Spurious Emission	Pass
§15.247 (a)(2)	6 dB Bandwidth	Pass
§15.247 (b)(3)	Maximum Peak Output Power	Pass
§ 15.247 (c)	100 kHz Bandwidth of Frequency Band Edge	Pass
§15.247 (d)	Peak Power Spectral Density	Pass
§15.205	Restricted Band	Pass

§15.203 - ANTENNA REQUIREMENT

Standard Applicable

According to § 15.203, an intentional radiator shall be designed to ensure that no antenna other than that furnished by the responsible party shall be used with the device.

And according to § 15.247 (b) (4), if transmitting antennas of directional gain greater than 6 dBi are used the power shall be reduced by the amount in dB that the directional gain of the antenna exceeds 6 dBi.

Refer to statement below for compliance.

“The antenna for this device is a unique antenna which has a reversed SMA connector. Please refer to the antenna specification for details”.

§15.207(a) - CONDUCTED EMISSIONS

Measurement Uncertainty

All measurements involve certain levels of uncertainties. The factors contributing to uncertainties are spectrum analyzer, cable loss, and LISN.

Based on NIS 81, The Treatment of Uncertainty in EMC Measurements, the best estimate of the uncertainty of any conducted emissions measurement at BACL is ± 2.4 dB.

EUT Setup

The measurement was performed in the shield room, using the same setup per ANSI C63.4-2001 measurement procedure. The specification used was FCC 15 Subpart B limits.

The spacing between the peripherals was 10 centimeters.

External I/O cables were draped along the edge of the test table and bundle when necessary.

Spectrum Analyzer Setup

The EMI test receiver was set to investigate the spectrum from 150 kHz to 30Mhz.

Test Equipment List and Details

Manufacturer	Description	Model	Serial Number	Cal. Date
Rohde & Schwarz	Artificial LISN	ESH2-Z5	871884/039	2003-03-28
Rohde & Schwarz	EMI Test Receiver	ESCS30	100176	2003-05-06

* **Statement of Traceability:** BACL Corp. certifies that all calibrations have been performed in accordance to NVLAP requirements, traceable to the NIST.

Test Procedure

During the conducted emission test, the power cord of the host system was connected to the auxiliary outlet of the first LISN.

Maximizing procedure was performed on the six (6) highest emissions of each modes tested to ensure EUT is compliant with all installation combination.

All data was recorded in the peak detection mode. Quasi-peak readings were only performed when an emission was found to be marginal (within -4 dB μ V of specification limits). Quasi-peak readings are distinguished with a "Qp".

Summary of Test Results

According to the recorded data in following table, the EUT complies with the FCC Conducted margin for a Class B device, with the *worst* margin reading of:

-10.9 dB at 0.150 in the Neutral mode

Environmental Conditions

Temperature:	12° C
Relative Humidity:	48%
ATM Pressure:	1100 mbar

Conducted Emissions Test Data

LINE CONDUCTED EMISSIONS				FCC PART 15 CLASS B	
Frequency MHz	Amplitude dBμV	Detector Qp/Ave/Peak	Phase Line/Neutral	Limit dBμV	Margin dB
0.150	55.1	QP	Neutral	66	-10.9
9.300	38.5	AVG	Neutral	50	-11.5
0.150	54.3	QP	Line	66	-11.7
8.100	37.6	AVG	Line	50	-12.4
7.100	47.2	QP	Neutral	60	-12.8
6.300	44.7	QP	Line	60	-15.3
1.760	31.3	QP	Neutral	56	-24.7
2.040	25.9	QP	Line	56	-30.1
0.150	24.9	AVG	Line	56	-31.1
0.150	24.7	AVG	Neutral	56	-31.3
1.740	13.9	AVG	Neutral	46	-32.1
2.050	8.0	AVG	Line	46	-38.0

Plot of Conducted Emissions Test Data

Plot(s) of Conducted Emissions Test Data is presented hereinafter as reference.

Bay Area Compliance Laboratory Corp
 CISPR CLASS B

25. Jan 04 14:31

EUT: DBL800EH
 Manuf: AZ Tech
 Op Cond: Normal
 Operator: Ming
 Comment: N
 File name: NMBAS500.RES

Scan Settings (3 Ranges)

Frequencies			Receiver Settings				
Start	Stop	Step	IF BW	Detector	M-Time	Atten	Preamp
150k	1M	5k	9k	QP+AV	20ms	10dB LN	OFF
1M	5M	10k	9k	QP+AV	1ms	10dB LN	OFF
5M	30M	100k	9k	QP+AV	1ms	10dB LN	OFF

Final Measurement: x QP / + AV
 Meas Time: 1 s
 Subranges: 28
 Acc Margin: 6dB

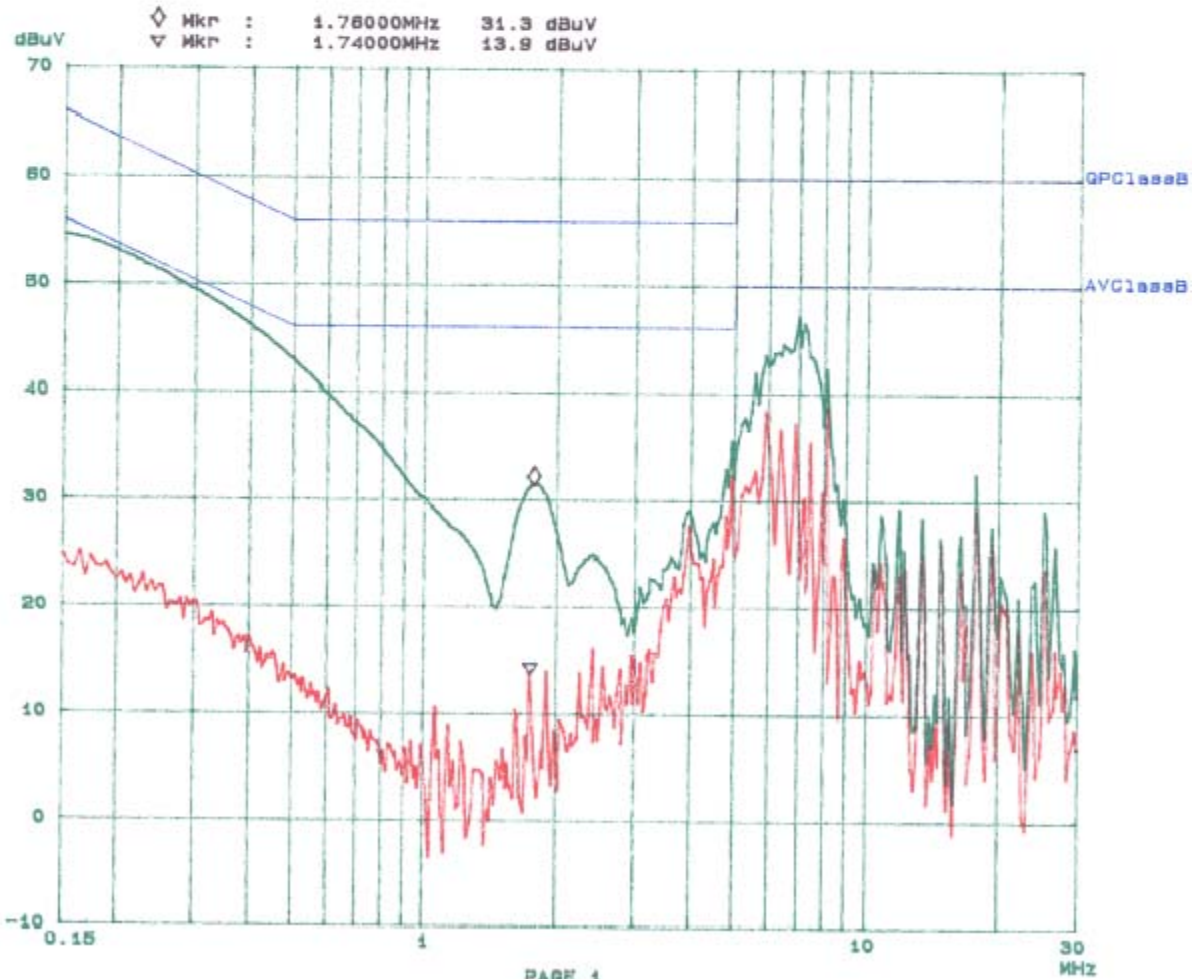

Bay Area Compliance Laboratory Corp
CISPR CLASS B

25. Jan 04 14:55

EUT: DSL600EW
Manuf: AZ Tech
Op Cond: Normal
Operator: Ming
Comment: L
File name: NMBAS500.RES

Scan Settings (3 Ranges)

Frequencies			Receiver Settings				
Start	Stop	Step	IF BW	Detector	M-Time	Atten	Preamp
150k	1M	5k	9k	QP+AV	20ms	10dBLN	OFF
1M	5M	10k	9k	QP+AV	1ms	10dBLN	OFF
5M	30M	100k	9k	QP+AV	1ms	10dBLN	OFF

Final Measurement: x GP / + AV
Meas Time: 1 s
Subranges: 25
Acc Margin: 6dB

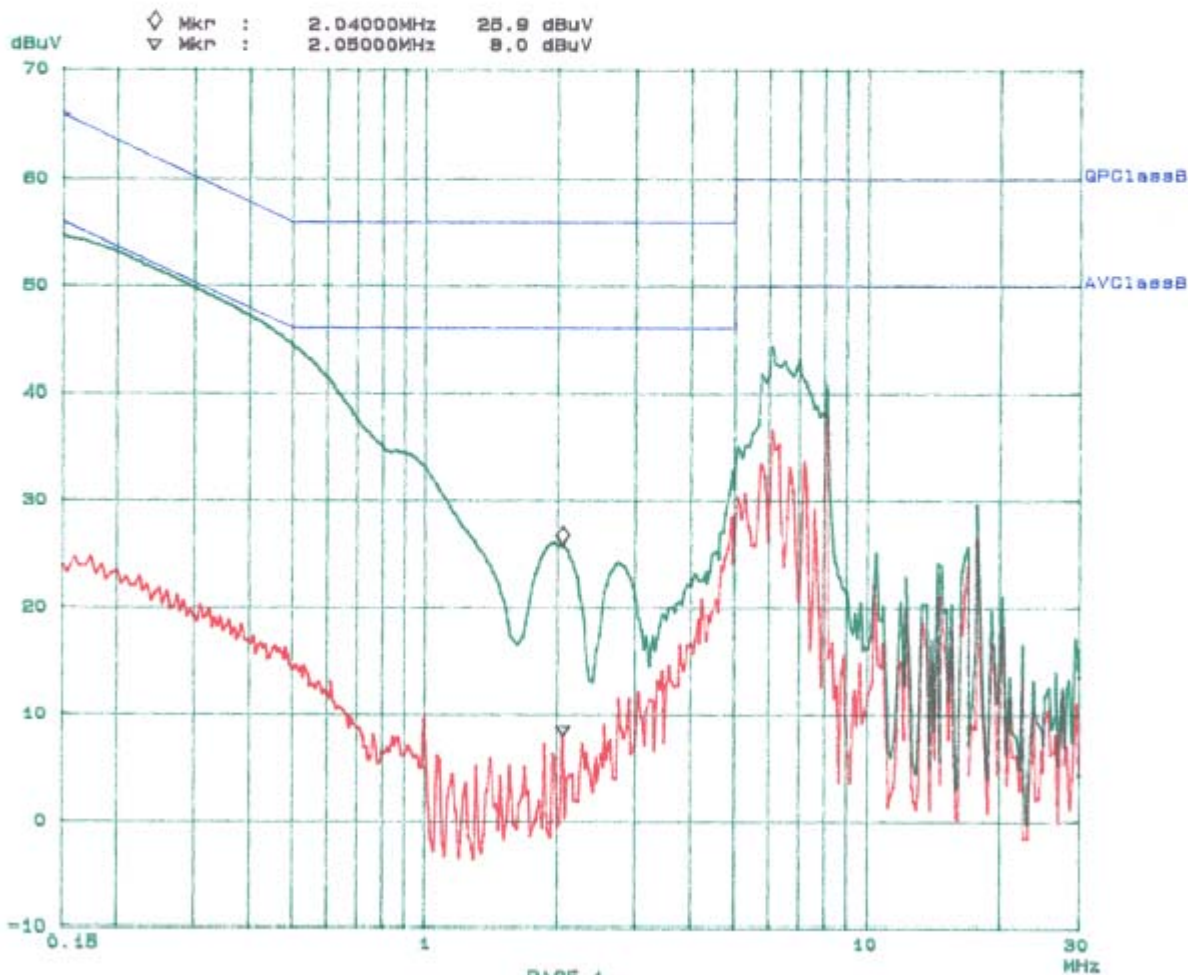

Handwritten signature and date: 2004-01-29

§15.209(a) - SPURIOUS EMISSION

Standard Applicable

According to §15.209 (a), except as provided elsewhere in the subpart of 15.209, the emissions from an intentional radiator shall not exceed the field strength levels specified in the following table:

Frequency (MHz)	Measurement Field strength (microvolts/meter)	distance (meters)
0.009-0.490.....	2400/F(kHz)	300
0.490-1.705.....	24000/F(kHz)	30
1.705-30.0.....	30	30
30-88.....	100 **	3
88-216.....	150 **	3
216-960.....	200 **	3
Above 960.....	500	3

** Except as provided in paragraph (g), fundamental emissions from intentional radiators operating under this section shall not be located in the frequency bands 54-72 MHz, 76-88 MHz, 174-216 MHz or 470-806 MHz. However, operation within these frequency bands is permitted under other sections of this part, e.g., §§ 15.231 and 15.241

Measurement Procedure

1. Check the calibration of the measuring instrument (SA) using either an internal calibrator or a known signal from an external generator.
2. Position the EUT on a bench without connection to measurement instrument. Turn on the EUT and connect its antenna terminal to measurement instrument via a low loss cable. Then set it to any one measured frequency within its operating range, and make sure the instrument is operated in its linear range.
3. Set the SA on Max-Hold Mode, and then keep the EUT in transmitting mode. Record all the signals from each channel until each one has been recorded.
4. Set the SA on View mode and then plot the result on SA screen.
5. Repeat above procedures until all frequencies measured were complete.

Equipment Lists

Manufacturer	Model No.	Description	Calibration Date
HP	8565EC	Spectrum Analyzer	2003-06-30

Measurement Result

Please refer to following pages for plots of spurious emission.

Environmental Conditions

Temperature:	12° C
Relative Humidity:	48%
ATM Pressure:	1100 mbar

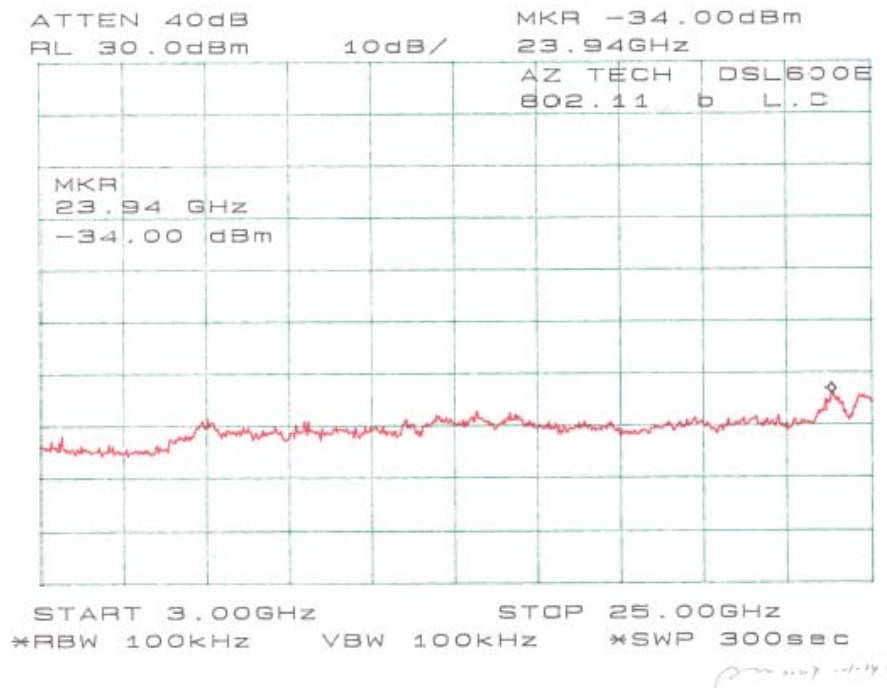
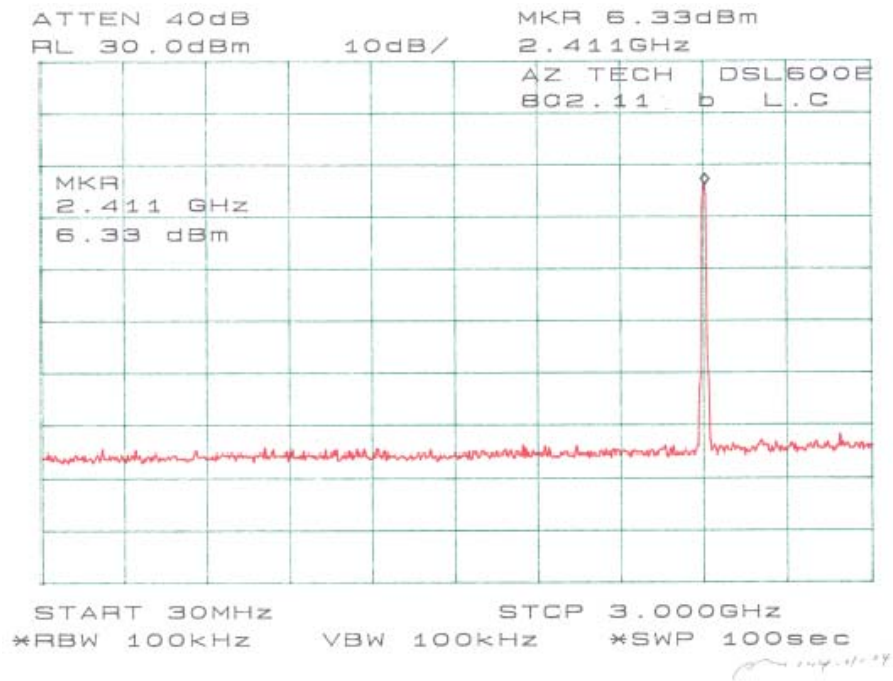

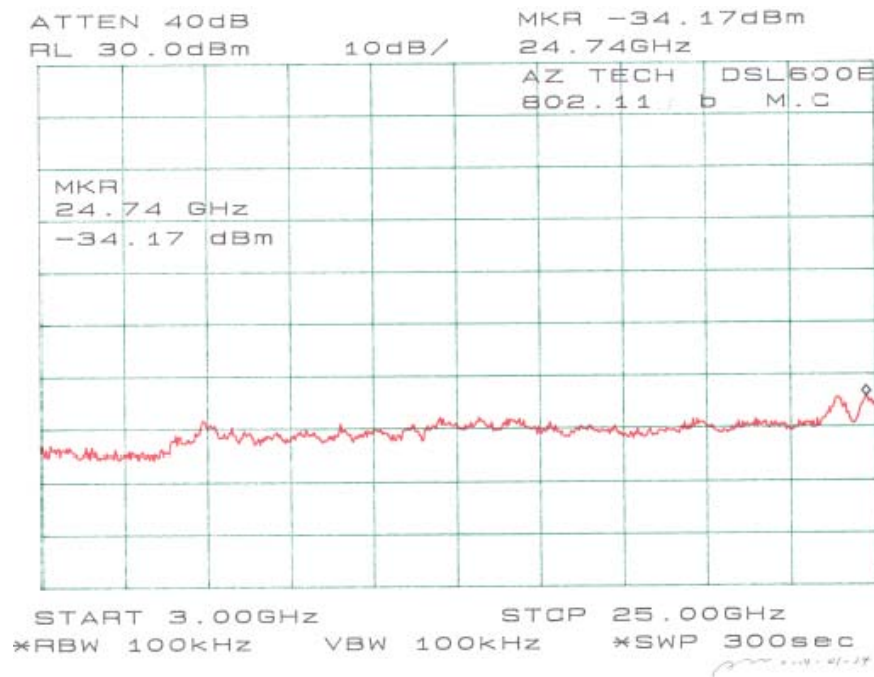
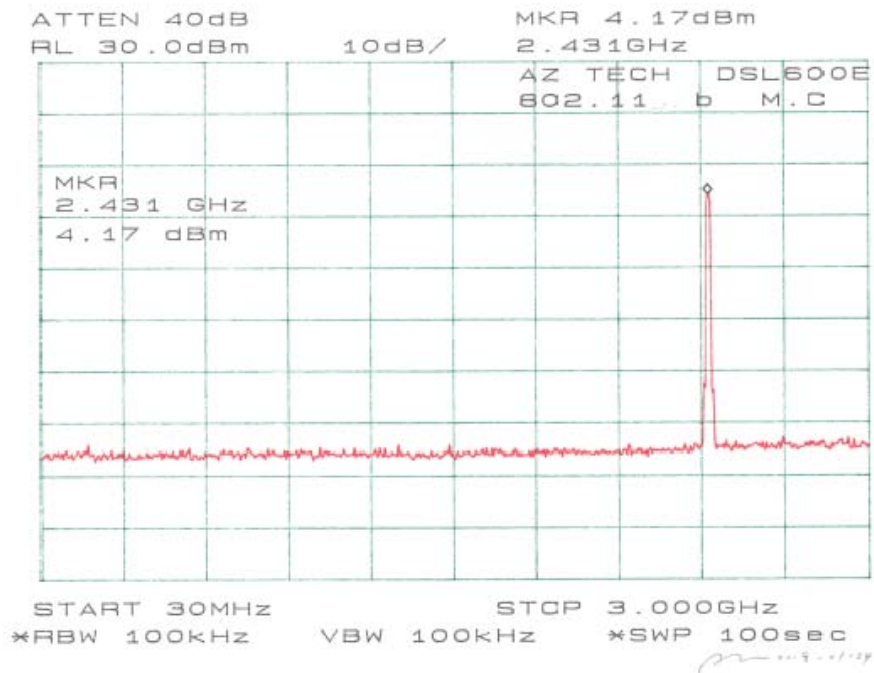

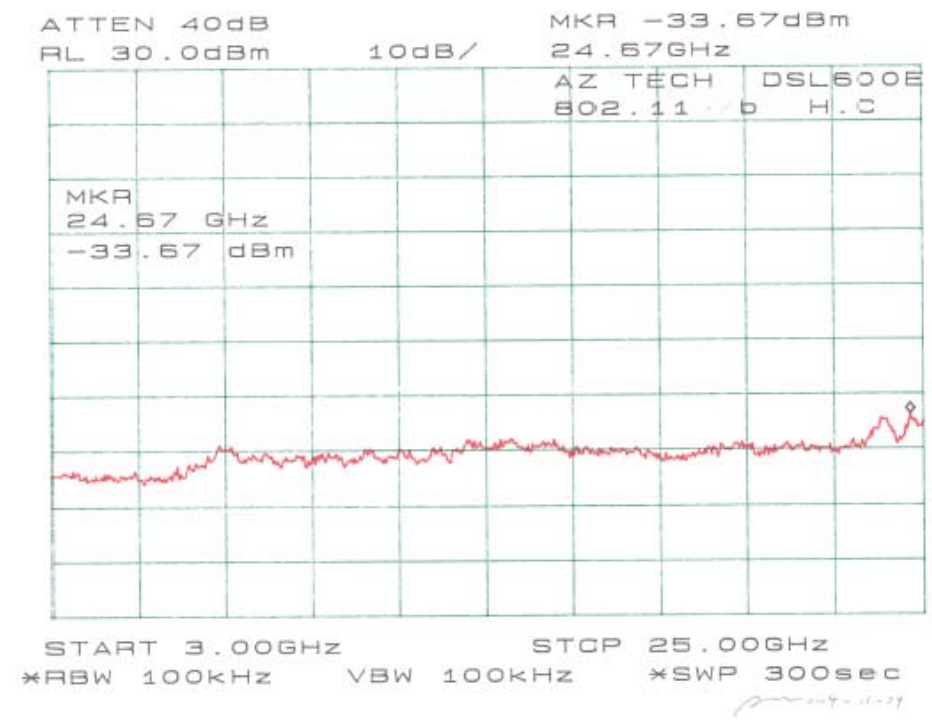
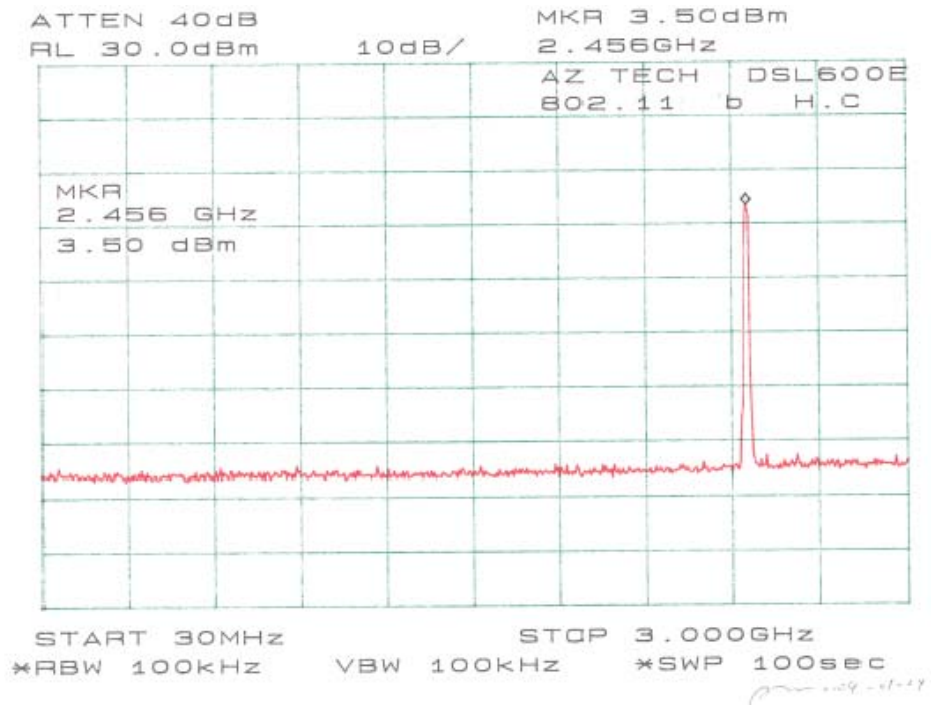

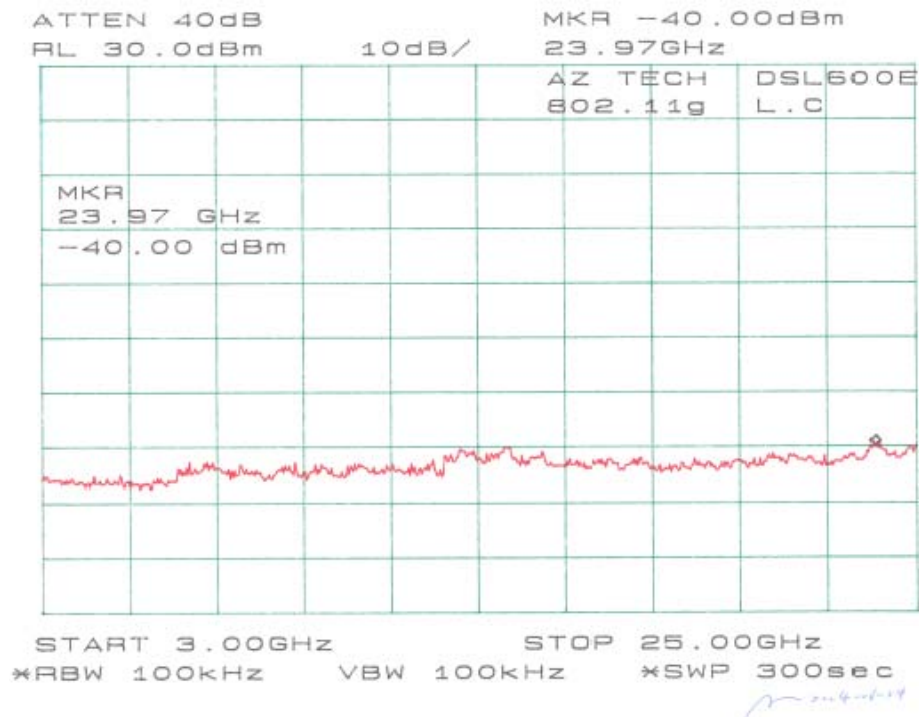
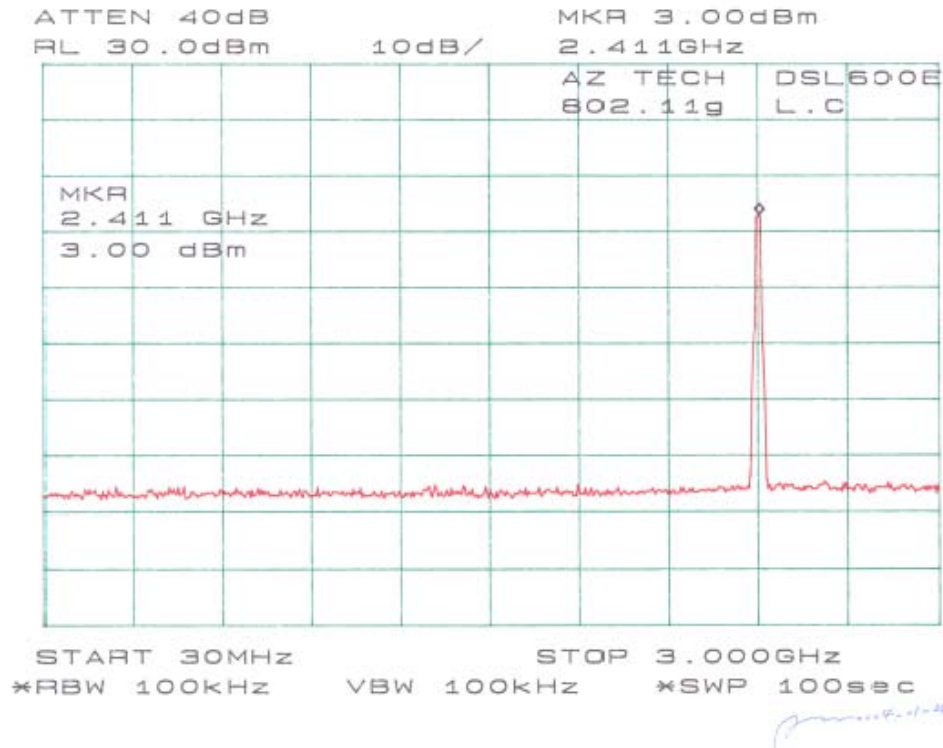

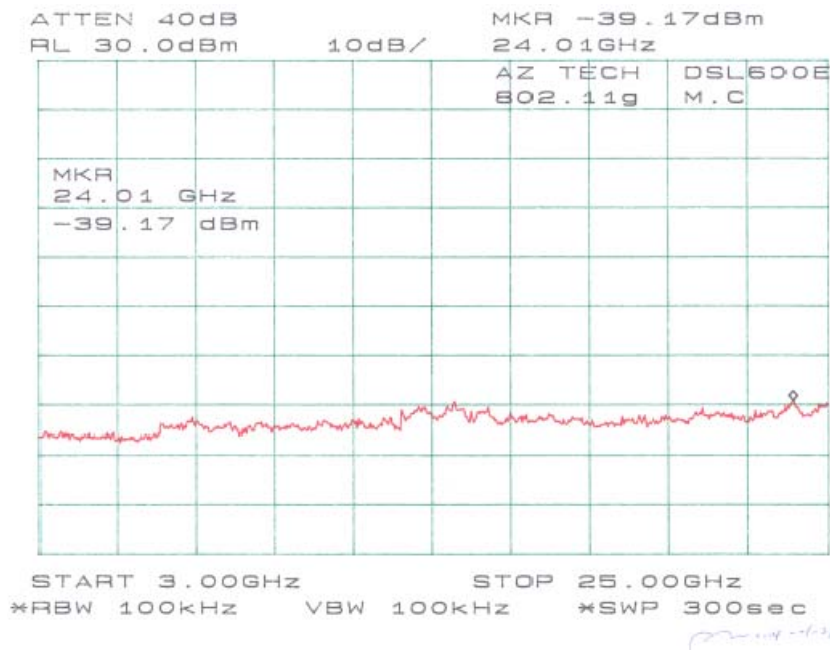
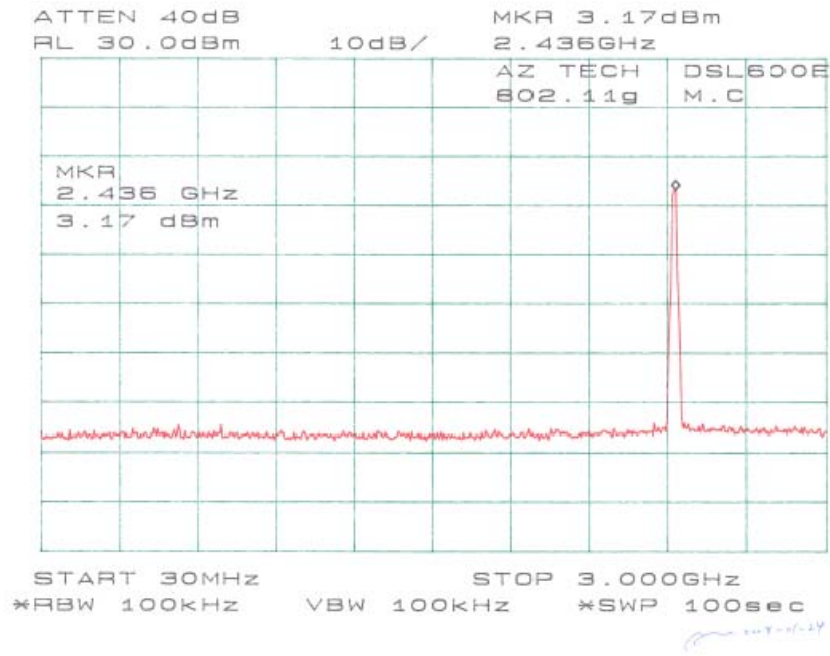

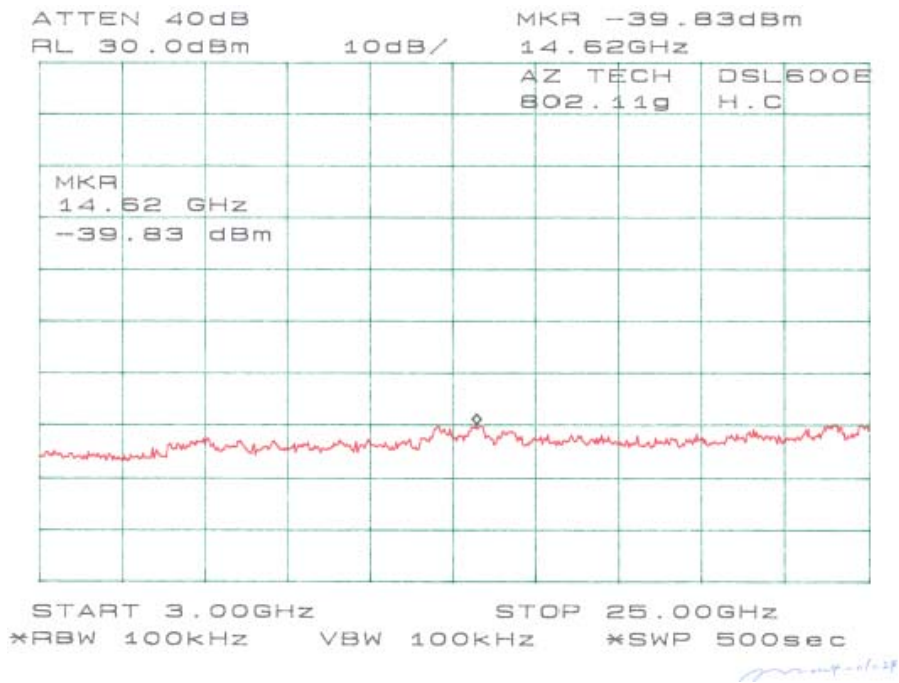
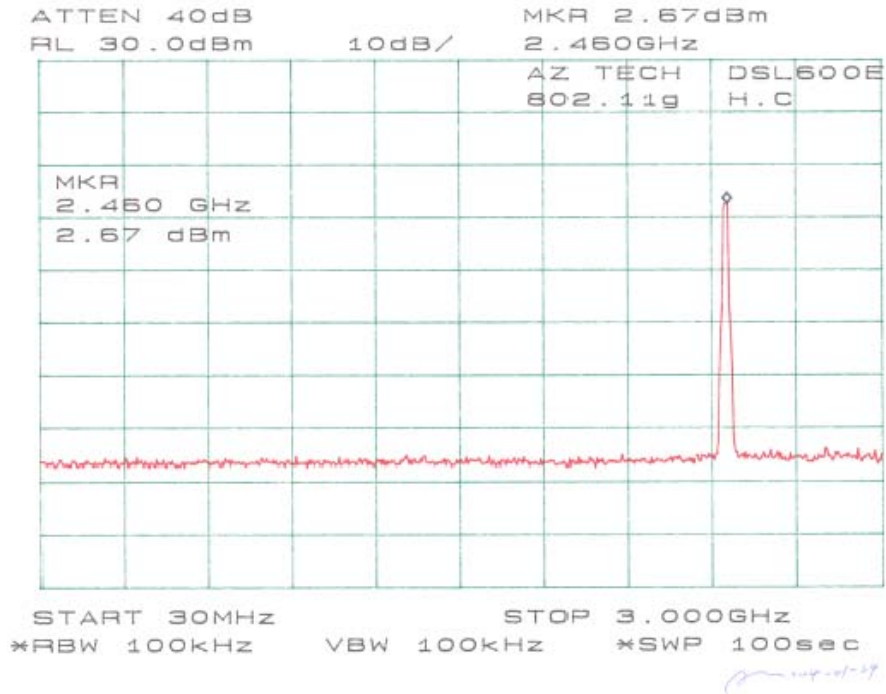

§15.209(f) - SPURIOUS RADIATED EMISSION

Measurement Uncertainty

All measurements involve certain levels of uncertainties. The factors contributing to uncertainties are spectrum analyzer, cable loss, antenna factor calibration, antenna directivity, antenna factor variation with height, antenna phase center variation, antenna factor frequency interpolation, measurement distance variation, site imperfections, mismatch (average), and system repeatability.

Based on NIS 81, The Treatment of Uncertainty in EMC Measurements, the best estimate of the uncertainty of a radiation emissions measurement at BAEL is ± 4.0 dB.

According to §15.205, except as shown in paragraph (d) of this section, only spurious emissions are permitted in any of the frequency bands listed below:

MHz	MHz	MHz	GHz
0.090 – 0.110	16.42 – 16.423	399.9 – 410	4.5 – 5.15
¹ 0.495 – 0.505	16.69475 – 16.69525	608 – 614	5.35 – 5.46
2.1735 – 2.1905	16.80425 – 16.80475	960 – 1240	7.25 – 7.75
4.125 – 4.128	25.5 – 25.67	1300 – 1427	8.025 – 8.5
4.17725 – 4.17775	37.5 – 38.25	1435 – 1626.5	9.0 – 9.2
4.20725 – 4.20775	73 – 74.6	1645.5 – 1646.5	9.3 – 9.5
6.215 – 6.218	74.8 – 75.2	1660 – 1710	10.6 – 12.7
6.26775 – 6.26825	108 – 121.94	1718.8 – 1722.2	13.25 – 13.4
6.31175 – 6.31225	123 – 138	2200 – 2300	14.47 – 14.5
8.291 – 8.294	149.9 – 150.05	2310 – 2390	15.35 – 16.2
8.362 – 8.366	156.52475 – 156.52525	2483.5 – 2500	17.7 – 21.4
8.37625 – 8.38675	156.7 – 156.9	2655 – 2900	22.01 – 23.12
8.41425 – 8.41475	162.0125 – 167.17	3260 – 3267	23.6 – 24.0
12.29 – 12.293	167.72 – 173.2	3332 – 3339	31.2 – 31.8
12.51975 – 12.57725	240 – 285	3345.8 – 3358	36.43 – 36.5
13.36 – 13.41	322 – 335.4	3600 – 4400	(²)

¹ Until February 1, 1999, this restricted band shall be 0.490-0.510MHz

² Above 38.6

Except as provided in paragraph (d) and (e), the filed strength of emissions appearing within these frequency bands shall not exceed the limits shown in Section 15.209. At frequencies equal to or less than 1000MHz, compliance with the limits in Section 15.209 shall be demonstrated using measurement instrumentation employing a CISPR quasi-peak detector. Above 1000MHz, compliance with the emission limits in Section 15.209 shall be demonstrated based on the average value of the measured emissions. The provisions in Section 15.35 apply to these measurements.

According to §15.209, the device shall meet radiated emission general requirements.

Except for Class A device, the filed strength of radiated emissions from unintentional radiators at a distance of 3 meters shall not exceed the following values:

Frequency of Emission (MHz)	Field Strength (Microvolts/meter)	dB (dB μ V/meter)
30 - 88	100	40
88 - 216	150	43.5
216 - 960	200	46
Above 960	500	54

EUT Setup

The radiated emission tests were performed in the open area 3-meter test site, using the setup accordance with the ANSI C63.4-2001. The specification used was the FCC 15.209 limits.

The spacing between the peripherals was 10 centimeters.

External I/O cables were draped along the edge of the test table and bundle when necessary.

Spectrum Analyzer Setup

According to FCC Rules, 47 CFR, Section 15.33, the frequency was investigated from 30 to 2500 MHz.

During the radiated emission test, the spectrum analyzer was set with the following configurations:

<u>Frequency Range</u>	<u>RBW</u>	<u>Video B/W</u>
Below 30MHz	10kHz	10kHz
30 – 1000MHz	100kHz	100kHz
Above 1000MHz	1MHz	1MHz

Test Equipment List and Details

Manufacturer	Description	Model	Serial Number	Cal. Date
HP	Spectrum Analyzer	8568B	2601A02165	2003-07-03
HP	Amplifier	8447E	2944A10187	2003-09-23
HP	Quasi-Peak Adapter	85650A	3019A05393	2003-06-13
EMCO	Biconical Antenna	3110B	9309-1165	2003-10-11
EMCO	Log Periodic Antenna	3146	2101	2003-10-11

* **Statement of Traceability:** BACL Corp. certifies that all calibrations have been performed in accordance to NVLAP requirements, traceable to the NIST.

Test Procedure

For the radiated emissions test, the EUT, and all support equipment power cords was connected to the AC floor outlet.

Maximizing procedure was performed on the highest emissions to ensure that the EUT complied with all installation combinations.

All data was recorded in the peak detection mode. Quasi-peak readings performed only when an emission was found to be marginal (within -4 dB μ V of specification limits), and are distinguished with a "Qp" in the data table.

Corrected Amplitude & Margin Calculation

The Corrected Amplitude is calculated by adding the Antenna Factor and Cable Factor, and subtracting the Amplifier Gain from the Amplitude reading. The basic equation is as follows:

$$\text{Corr. Ampl.} = \text{Indicated Reading} + \text{Antenna Factor} + \text{Cable Factor} - \text{Amplifier Gain}$$

The "**Margin**" column of the following data tables indicates the degree of compliance with the applicable limit. For example, a margin of -7dB μ V means the emission is 7dB μ V below the maximum limit for Class B. The equation for margin calculation is as follows:

$$\text{Margin} = \text{Corr. Ampl.} - \text{FCC 15.209 Limit}$$

Summary of Test Results

According to the data in section 12.7, the EUT complied with the FCC Title 47, Part 15, Subpart C, section 15.205, 15.207 and 15.247, and had the worst margin of:

Environmental Conditions

Temperature:	12° C
Relative Humidity:	48%
ATM Pressure:	1100 mbar

802.11b data:

- 5.6 dB at 2390.00 MHz in the **Vertical** polarization, Low Channel
- 9.5 dB at 4874.00 MHz in the **Vertical** polarization, Middle Channel
- 9.8 dB at 4924.00 MHz in the **Vertical** polarization, High Channel
- 10.1 dB at 77.28 MHz in the **Horizontal** polarization, Unwanted Emission

802.11g data:

- 4.3 dB at 2390.00 MHz in the **Vertical** polarization, Low Channel
- 8.5 dB at 1250.00 MHz in the **Vertical** polarization, Middle Channel
- 9.9 dB at 4924.00 MHz in the **Vertical** polarization, High Channel
- 10.3 dB at 77.28 MHz in the **Horizontal** polarization, Unwanted Emission

Radiated Emission Test Result for 802.11b

INDICATED			TABLE	ANTENNA		CORRECTION FACTOR			CORRECTED AMPLITUDE	FCC 15 SUBPART C	
Frequency	Ampl.	Comments	Angle	Height	Polar	Antenna	Cable	Amp.	Corr. Ampl.	Limit	Margin
MHz	dBμV/m		Degree	Meter	H/V	dBμV/m	DB	DB	dBμV/m	dBμV/m	dB
Low Channel, 1-25GHz											
2412.00	111.2	Fund/Peak	90	1.8	v	28.1	3.4	35.2	107.5		
2412.00	97.7	Fund/Peak	90	1.5	h	28.1	3.4	35.2	94.0		
2412.00	106.4	Fund/Ave	90	1.8	v	28.1	3.4	35.2	102.7		
2412.00	93.1	Fund/Ave	90	1.5	h	28.1	3.4	35.2	89.4		
2390.00	52.1	Ave	270	1.5	v	28.1	3.4	35.1	48.5	54	-5.6
4824.00	40.3	Ave	30	1.8	v	32.5	4.9	33.0	44.7	54	-9.3
4824.00	38.2	Ave	110	1.5	h	32.5	4.9	33.0	42.6	54	-11.4
2390.00	45.2	Ave	310	1.5	h	28.1	3.4	35.1	41.6	54	-12.5
2390.00	56.7	Peak	270	1.5	v	28.1	3.4	35.1	53.1	74	-21.0
4824.00	44.9	Peak	30	1.8	v	32.5	4.9	33.0	49.3	74	-24.7
4824.00	42.5	Peak	110	1.5	h	32.5	4.9	33.0	46.9	74	-27.1
2390.00	49.3	Peak	310	1.5	h	28.1	3.4	35.1	45.7	74	-28.4
Middle Channel, 1-25GHz											
2437.00	109.6	Fund/Peak	30	1.8	v	28.1	3.4	35.2	105.9		
2437.00	97.5	Fund/Peak	230	1.2	h	28.1	3.4	35.2	93.8		
2437.00	105.3	Fund/Ave	30	1.8	v	28.1	3.4	35.2	101.6		
2437.00	93.2	Fund/Ave	230	1.2	h	28.1	3.4	35.2	89.5		
4874.00	40.1	Ave	90	1.5	v	32.5	4.9	33.0	44.5	54	-9.5
1250.00	52.1	Ave	0	1.2	v	23.7	4.2	36.1	43.9	54	-10.1
4874.00	37.9	Ave	15	1.2	h	32.5	4.9	33.0	42.3	54	-11.7
1250.00	49.8	Ave	180	1.5	h	23.7	4.2	36.1	41.6	54	-12.4
4874.00	44.6	Peak	90	1.5	v	32.5	4.9	33.0	49.0	74	-25.0
4874.00	42.3	Peak	15	1.2	h	32.5	4.9	33.0	46.7	74	-27.3
1250.00	54.6	Peak	0	1.2	v	23.7	4.2	36.1	46.4	74	-27.6
1250.00	52.3	Peak	180	1.5	h	23.7	4.2	36.1	44.1	74	-29.9

High Channel, 1-25GHz											
2462.00	109.1	Fund/Peak	270	1.6	v	28.1	3.4	35.2	105.4		
2462.00	97.2	Fund/Peak	210	1.5	h	28.1	3.4	35.2	93.5		
2462.00	104.5	Fund/Ave	270	1.6	v	28.1	3.4	35.2	100.8		
2462.00	92.6	Fund/Ave	210	1.5	h	28.1	3.4	35.2	88.9		
4924.00	39.8	Ave	60	1.2	v	32.5	4.9	33.0	44.2	54	-9.8
1784.50	52.3	Ave	230	1.6	v	25.3	2.6	36.1	44.1	54	-9.9
4924.00	37.6	Ave	30	1.5	h	32.5	4.9	33.0	42.0	54	-12.0
1784.50	46.8	Ave	290	1.8	h	25.3	2.6	36.1	38.6	54	-15.4
4924.00	44.3	Peak	60	1.2	v	32.5	4.9	33.0	48.7	74	-25.3
1784.50	56.8	Peak	230	1.6	v	25.3	2.6	36.1	48.6	74	-25.4
4924.00	42.1	Peak	30	1.5	h	32.5	4.9	33.0	46.5	74	-27.5
1784.50	51.2	Peak	290	1.8	h	25.3	2.6	36.1	43.0	74	-31.0

Frequency MHz	Indicated		Table Height Meter	Antenna		Correction Factor			FCC 15 Subpart B	
	Ampl. dBμV/m	Direction Degree		Polar H/V	Antenna dBμV/m	Cable Loss dBμV/m	Amp. dB	Corr. Ampl. dBμV/m	Limit dBμV/m	Margin dB
77.28	48.1	180	1.5	h	9.4	1.2	28.7	29.9	40	-10.1
480.53	42.2	310	1.8	v	18.3	3.1	28.7	34.9	46	-11.1
172.82	45.6	90	1.5	v	13.0	1.9	28.5	32.0	43.5	-11.5
129.33	46.7	15	1.2	h	11.9	1.6	28.5	31.6	43.5	-11.9
210.95	43.4	130	1.6	h	11.9	2.2	28.2	29.3	43.5	-14.2
227.01	40.5	270	1.2	v	11.8	2.2	28.2	26.3	46	-19.7

FUND = Fundamental
 AVG = average

Radiated Emission Test Result for 802.11g

INDICATED			TABLE	ANTENNA		CORRECTION FACTOR			CORRECTED AMPLITUDE	FCC 15 SUBPART C	
Frequency	Ampl.	Comments	Angle	Height	Polar	Antenna	Cable	Amp.	Corr. Ampl.	Limit	Margin
MHz	dBμV/m		Degree	Meter	H/V	dBμV/m	DB	DB	dBμV/m	dBμV/m	dB
Low Channel, 1-25GHz											
2412.00	111.3	Fund/Peak	60	1.6	v	28.1	3.4	35.2	107.6		
2412.00	97.6	Fund/Peak	90	1.5	h	28.1	3.4	35.2	93.9		
2412.00	106.5	Fund/Ave	60	1.6	v	28.1	3.4	35.2	102.8		
2412.00	93.2	Fund/Ave	90	1.5	h	28.1	3.4	35.2	89.5		
2390.00	53.4	Ave	290	1.5	v	28.1	3.4	35.1	49.8	54	-4.3
4824.00	40.2	Ave	180	1.8	v	32.5	4.9	33.0	44.6	54	-9.4
4824.00	38.1	Ave	110	1.5	h	32.5	4.9	33.0	42.5	54	-11.5
2390.00	45.6	Ave	310	1.2	h	28.1	3.4	35.1	42.0	54	-12.1
2390.00	57.1	Peak	290	1.5	v	28.1	3.4	35.1	53.5	74	-20.6
4824.00	44.8	Peak	180	1.8	v	32.5	4.9	33.0	49.2	74	-24.8
4824.00	42.6	Peak	110	1.5	h	32.5	4.9	33.0	47.0	74	-27.0
2390.00	49.8	Peak	310	1.2	h	28.1	3.4	35.1	46.2	74	-27.9
Middle Channel, 1-25GHz											
2437.00	109.7	Fund/Peak	0	1.6	v	28.1	3.4	35.2	106.0		
2437.00	97.6	Fund/Peak	90	1.2	h	28.1	3.4	35.2	93.9		
2437.00	105.5	Fund/Ave	0	1.6	v	28.1	3.4	35.2	101.8		
2437.00	93.4	Fund/Ave	90	1.2	h	28.1	3.4	35.2	89.7		
1250.00	53.7	Ave	0	1.2	v	23.7	4.2	36.1	45.5	54	-8.5
4874.00	40.2	Ave	310	1.5	v	32.5	4.9	33.0	44.6	54	-9.4
4874.00	37.8	Ave	60	1.2	h	32.5	4.9	33.0	42.2	54	-11.8
1250.00	49.9	Ave	180	1.5	h	23.7	4.2	36.1	41.7	54	-12.3
4874.00	44.7	Peak	310	1.5	v	32.5	4.9	33.0	49.1	74	-24.9
1250.00	55.9	Peak	15	1.2	v	23.7	4.2	36.1	47.7	74	-26.3
4874.00	42.5	Peak	60	1.2	h	32.5	4.9	33.0	46.9	74	-27.1
1250.00	53.1	Peak	180	1.5	h	23.7	4.2	36.1	44.9	74	-29.1

High Channel, 1-25GHz											
2462.00	109.3	Fund/Peak	290	1.6	v	28.1	3.4	35.2	105.6		
2462.00	97.1	Fund/Peak	210	1.5	h	28.1	3.4	35.2	93.4		
2462.00	104.6	Fund/Ave	290	1.6	v	28.1	3.4	35.2	100.9		
2462.00	92.5	Fund/Ave	210	1.5	h	28.1	3.4	35.2	88.8		
4924.00	39.7	Ave	110	1.2	v	32.5	4.9	33.0	44.1	54	-9.9
1784.50	52.3	Ave	230	1.6	v	25.3	2.6	36.1	44.1	54	-9.9
4924.00	37.5	Ave	30	1.5	h	32.5	4.9	33.0	41.9	54	-12.1
1784.50	46.7	Ave	290	1.8	h	25.3	2.6	36.1	38.5	54	-15.5
4924.00	44.2	Peak	110	1.2	v	32.5	4.9	33.0	48.6	74	-25.4
1784.50	56.6	Peak	210	1.6	v	25.3	2.6	36.1	48.4	74	-25.6
4924.00	42.3	Peak	30	1.5	h	32.5	4.9	33.0	46.7	74	-27.3
1784.50	51.1	Peak	270	1.5	h	25.3	2.6	36.1	42.9	74	-31.1

Frequency MHz	Indicated		Table Height Meter	Antenna		Correction Factor			FCC 15 Subpart B	
	Ampl. dBμV/m	Direction Degree		Polar H/V	Antenna dBμV/m	Cable Loss dBμV/m	Amp. dB	Corr. Ampl. dBμV/m	Limit dBμV/m	Margin dB
77.28	47.9	160	1.2	h	9.4	1.2	28.7	29.7	40	-10.3
129.33	46.5	0	1.5	h	11.9	1.6	28.5	31.4	43.5	-12.1
172.82	45.1	110	1.5	v	13.0	1.9	28.5	31.5	43.5	-12.0
210.95	43.6	90	1.6	h	11.9	2.2	28.2	29.5	43.5	-14.0
227.01	40.3	290	1.2	v	11.8	2.2	28.2	26.1	46	-19.9
480.53	42.1	330	1.8	v	18.3	3.1	28.7	34.8	46	-11.2

FUND = Fundamental
 AVG = average

§15.247(a)(2) – 6 DB BANDWIDTH

Standard Applicable

According to §15.247(a)(2), for digital modulation techniques, the minimum 6dB bandwidth shall be at least 500 kHz.

Measurement Procedure

1. Check the calibration of the measuring instrument using either an internal calibrator or a known signal from an external generator.
2. Position the EUT without connection to measurement instrument. Turn on the EUT and connect it to measurement instrument. Then set it to any one convenient frequency within its operating range. Set a reference level on the measuring instrument equal to the highest peak value.
3. Measure the frequency difference of two frequencies that were attenuated 6 dB from the reference level. Record the frequency difference as the emission bandwidth. (6 dB bandwidth for DTS)
4. Repeat above procedures until all frequencies measured were complete.

Equipment Lists

Manufacturer	Model No.	Description	Calibration Date
HP	8565EC	Spectrum Analyzer	2003-06-30

Measurement Result

Environmental Conditions

Temperature:	12° C
Relative Humidity:	48%
ATM Pressure:	1100 mbar

Test Result for 802.11b (15.247)

Channel	Frequency (MHz)	Measured (MHz)	Measured (kHz)	Standard (kHz)	Result
Low	2412	11.17	11170	≥ 500	Pass
Mid	2437	11.83	11830	≥ 500	Pass
High	2462	11.75	11750	≥ 500	Pass

Test Result for 802.11g (15.247)

Channel	Frequency (MHz)	Measured (MHz)	Measured (kHz)	Standard (kHz)	Result
Low	2412	16.08	16080	≥ 500	Pass
Mid	2437	16.08	16080	≥ 500	Pass
High	2462	16.33	16330	≥ 500	Pass

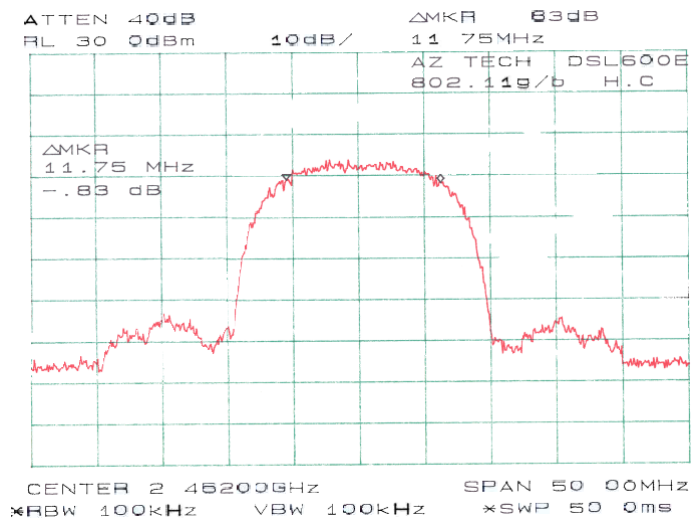
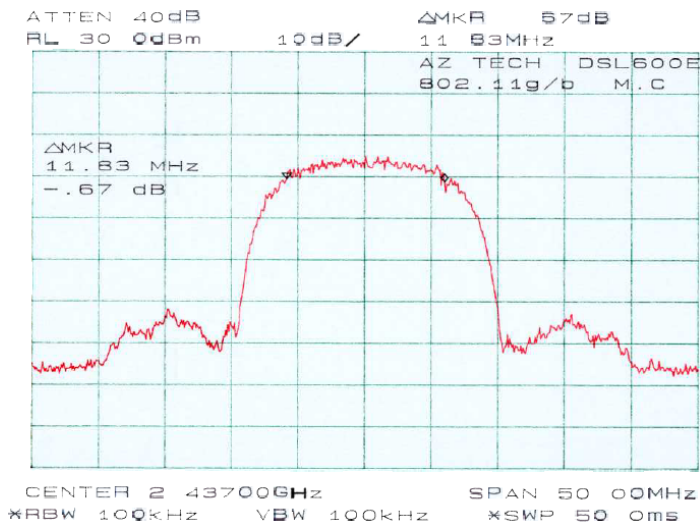
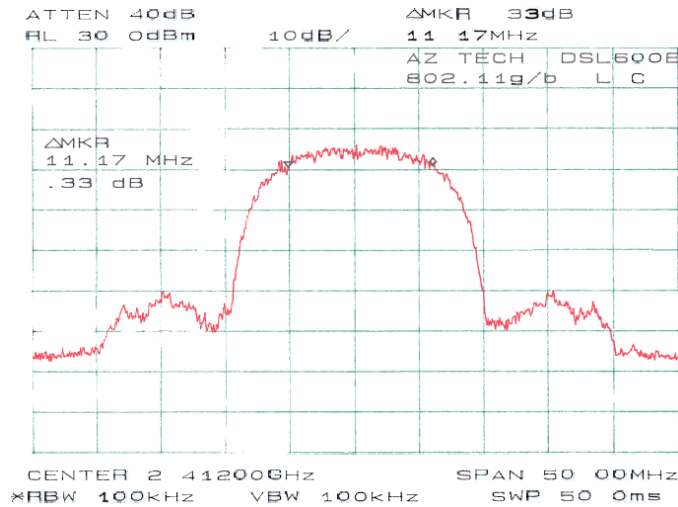

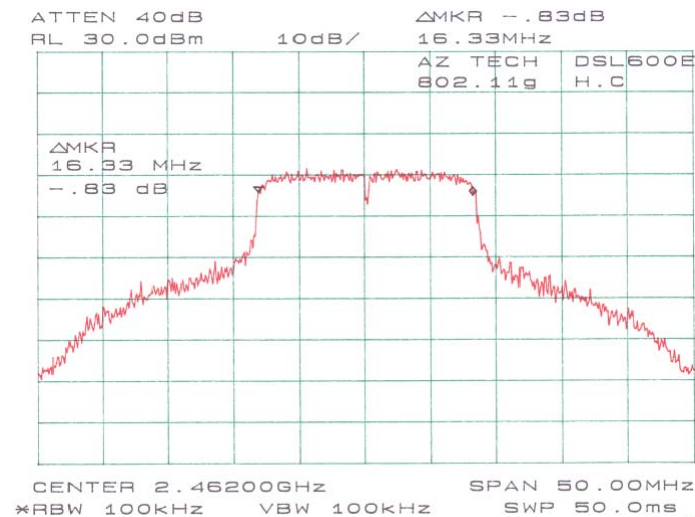
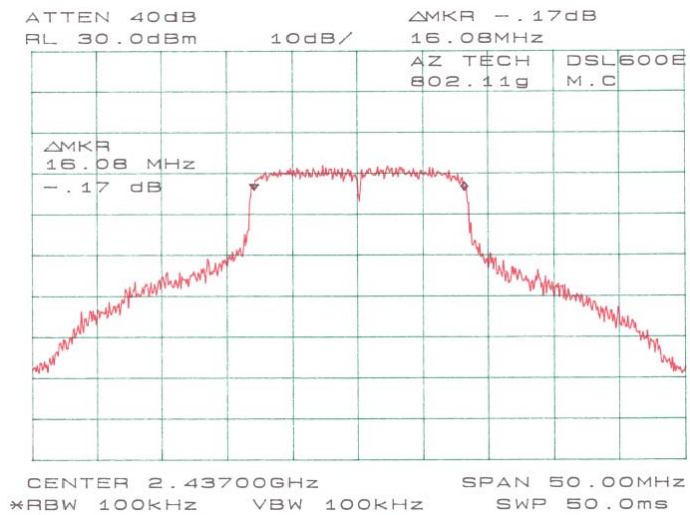
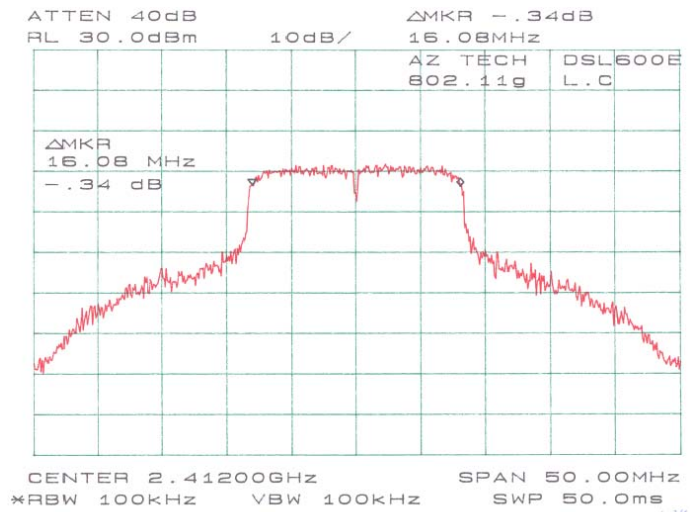

§15.247(b)(3) - PEAK OUTPUT POWER MEASUREMENT

Standard Applicable

According to §15.247(b) (3), for systems using digital modulation in 2400-2483.5 MHz: 1 Watt

Measurement Procedure

1. Place the EUT on a bench and set it in transmitting mode.
2. Remove the antenna from the EUT and then connect a low loss RF cable from the antenna port to a spectrum analyzer.
3. Add a correction factor to the display.

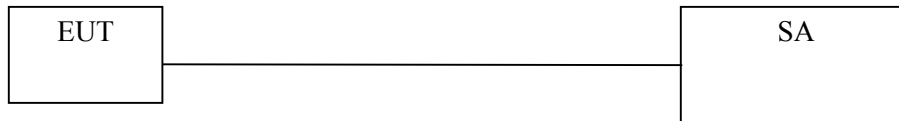

Equipment Lists

Manufacturer	Model No.	Description	Calibration Date
HP	8565EC	Spectrum Analyzer	2003-06-30

Measurement Result

Environmental Conditions

Temperature:	12° C
Relative Humidity:	48%
ATM Pressure:	1100 mbar

Output Power (15.247) for 802.11b

Channel	Frequency (MHz)	RF Power (dBm)	Correction Factor (dB)	Corrected RF Power (dBm)	Corrected RF Power (W)	Limit
Low (Ch1)	2412	10.67	7.6	18.27	0.067	1W (30dBm)
Mid (Ch7)	2437	10.50	7.6	18.10	0.065	1W (30dBm)
High (Ch11)	2462	10.17	7.6	17.77	0.060	1W (30dBm)

Note: Correction Factor = $10\log(BW_{6dB}/RBW) = 10\log(11.5/2) = 7.6$ dB

Output Power (15.247) for 802.11g

Channel	Frequency (MHz)	RF Power (dBm)	Correction Factor (dB)	Corrected RF Power (dBm)	Corrected RF Power (W)	Limit
Low (Ch1)	2412	9.17	9.03	18.20	0.066	1W (30dBm)
Mid (Ch7)	2437	9.00	9.03	18.03	0.064	1W (30dBm)
High (Ch11)	2462	8.83	9.03	17.86	0.061	1W (30dBm)

Note: Correction Factor = $10\log(BW_{6dB}/RBW) = 10\log(16/2) = 9.03$ dB

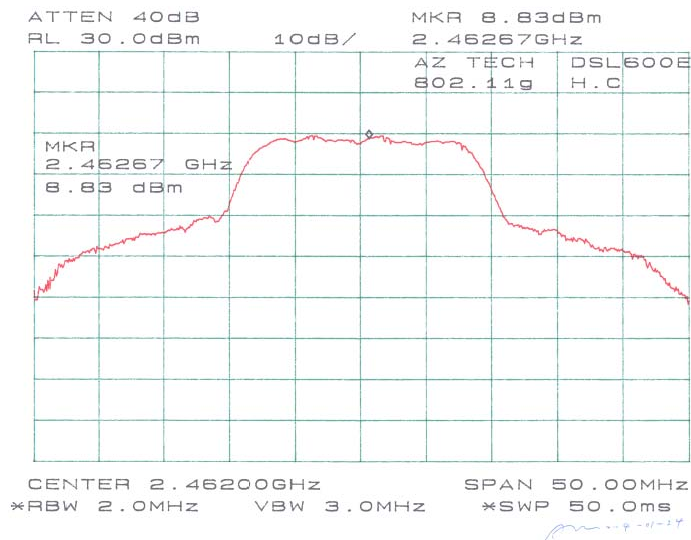
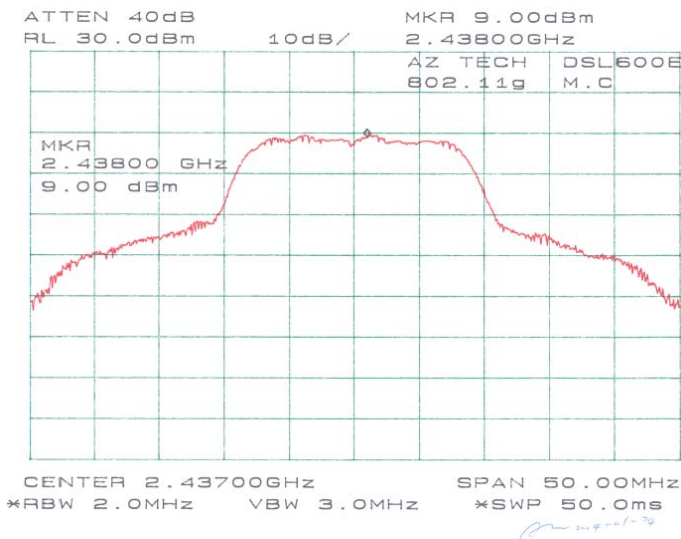
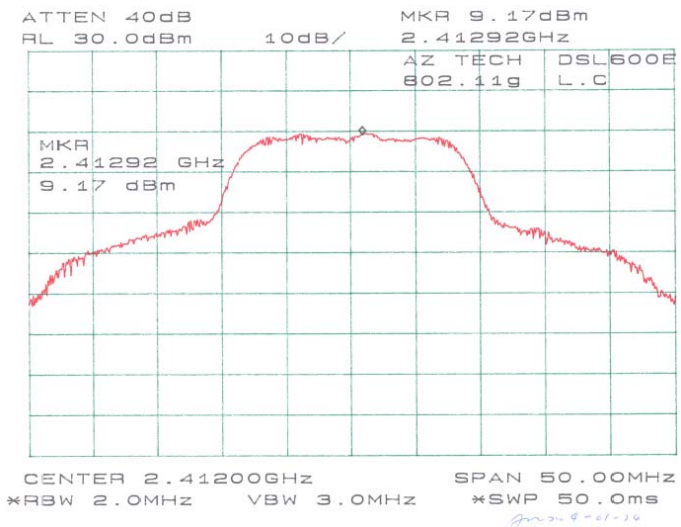

§15.247(c) - 100 KHZ BANDWIDTH OF BAND EDGES

Standard Applicable

According to §15.247(c), in *any* 100 kHz bandwidth outside the frequency bands in which the spread spectrum intentional radiator is operating, the radio frequency power that is produced by the intentional radiator shall be at least 20 dB below that in the 100 kHz bandwidth within the band that contains the highest level of the desired power, based on either an RF conducted or a radiated measurement. In addition, radiated emissions which fall in the restricted bands, as defined in §15.205(a), must also comply with the radiated emission limits specified in §15.209(a) see §15.205(c).

Measurement Procedure

1. Check the calibration of the measuring instrument using either an internal calibrator or a known signal from an external generator.
2. Position the EUT without connection to measurement instrument. Turn on the EUT and connect its antenna terminal to measurement instrument via a low loss cable. Then set it to any one measured frequency within its operating range, and make sure the instrument is operated in its linear range.
3. Set both RBW and VBW of spectrum analyzer to 100 kHz with a convenient frequency span including 100kHz bandwidth from band edge.
4. Measure the highest amplitude appearing on spectral display and set it as a reference level. Plot the graph with marking the highest point and edge frequency.
5. Repeat above procedures until all measured frequencies were complete.

Equipment Lists

Manufacturer	Model No.	Description	Calibration Date
HP	8565EC	Spectrum Analyzer	2003-06-30

Measure Results

Environmental Conditions

Temperature:	12° C
Relative Humidity:	48%
ATM Pressure:	1100 mbar

Please refer to following pages for plots of band edge.

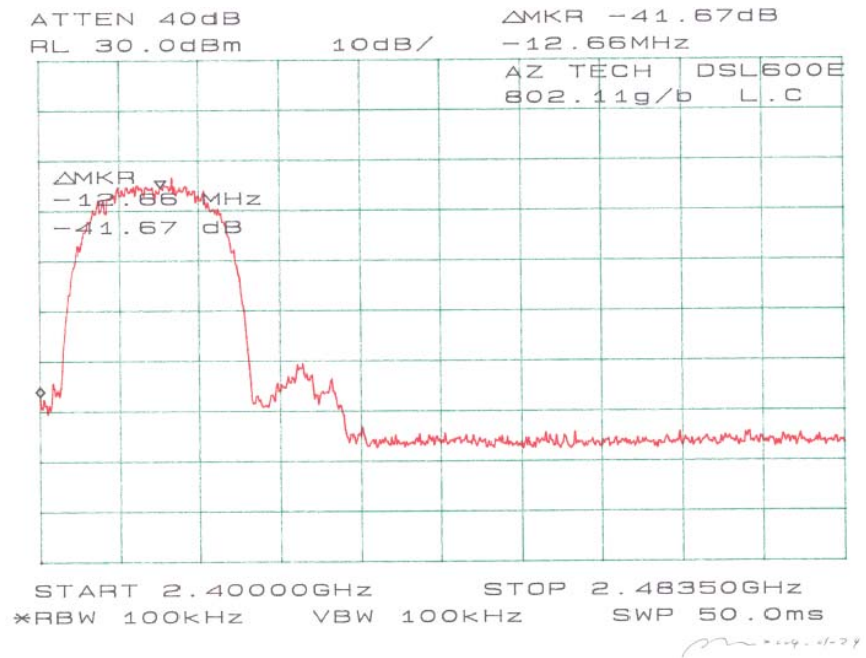
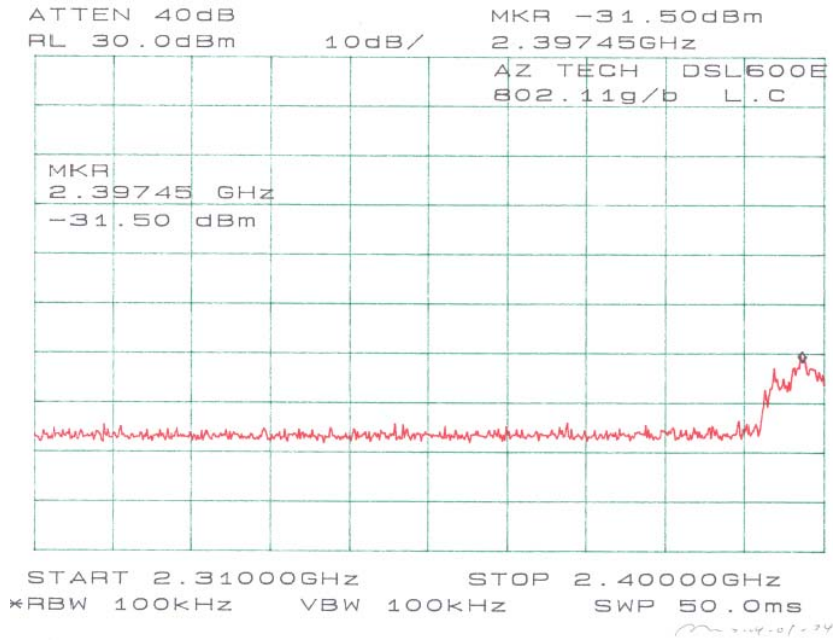

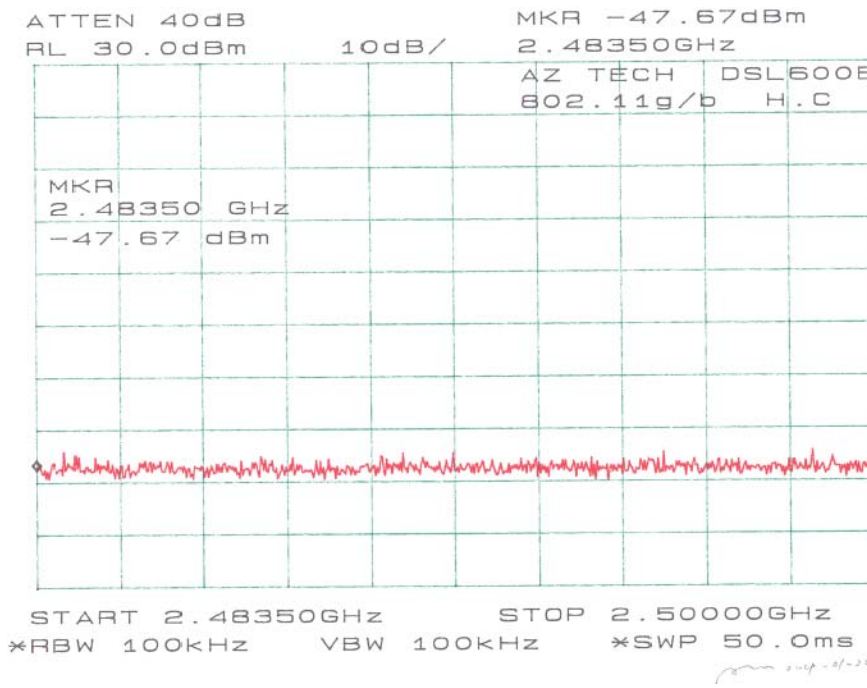
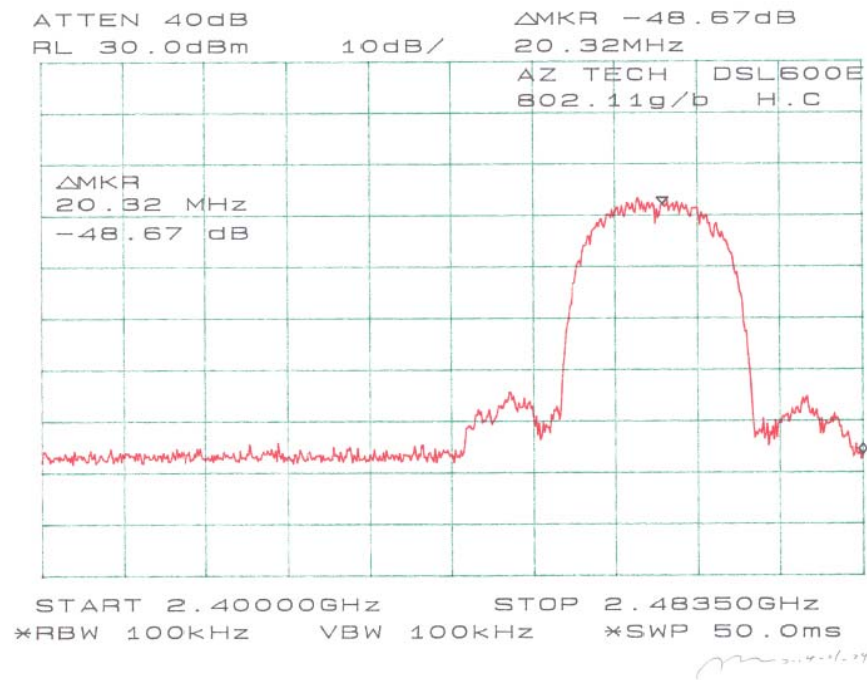

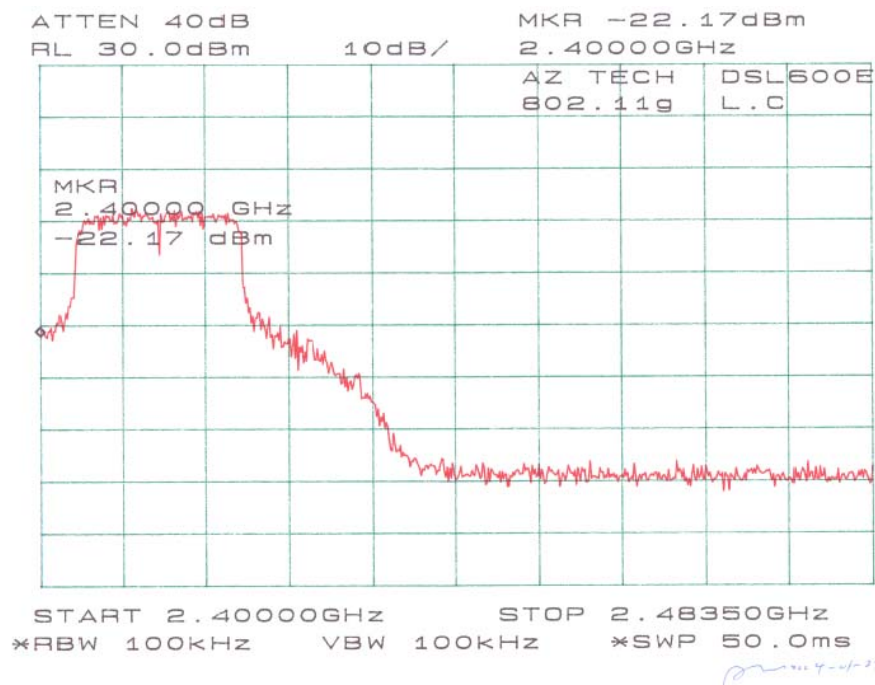
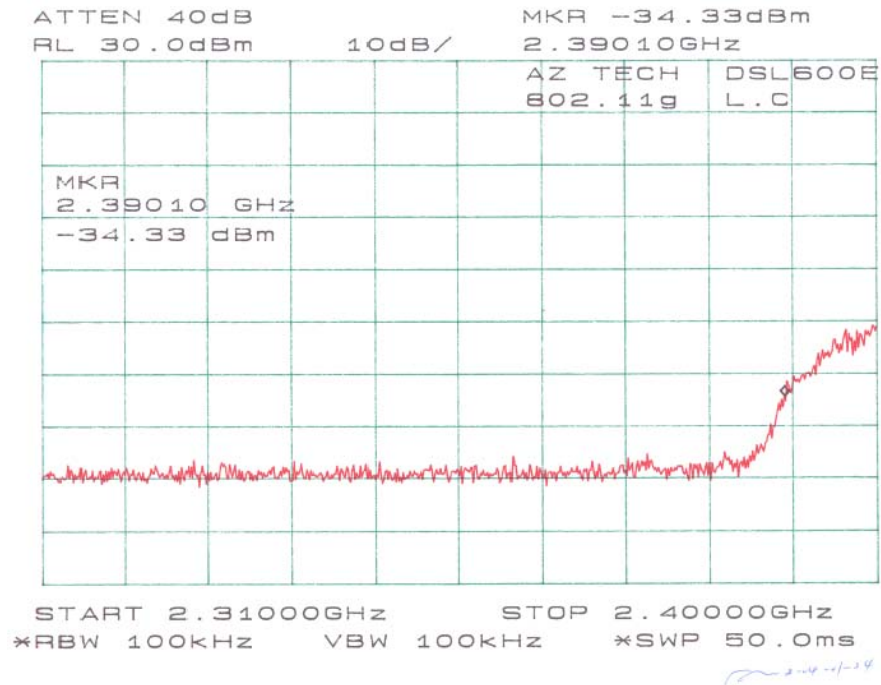

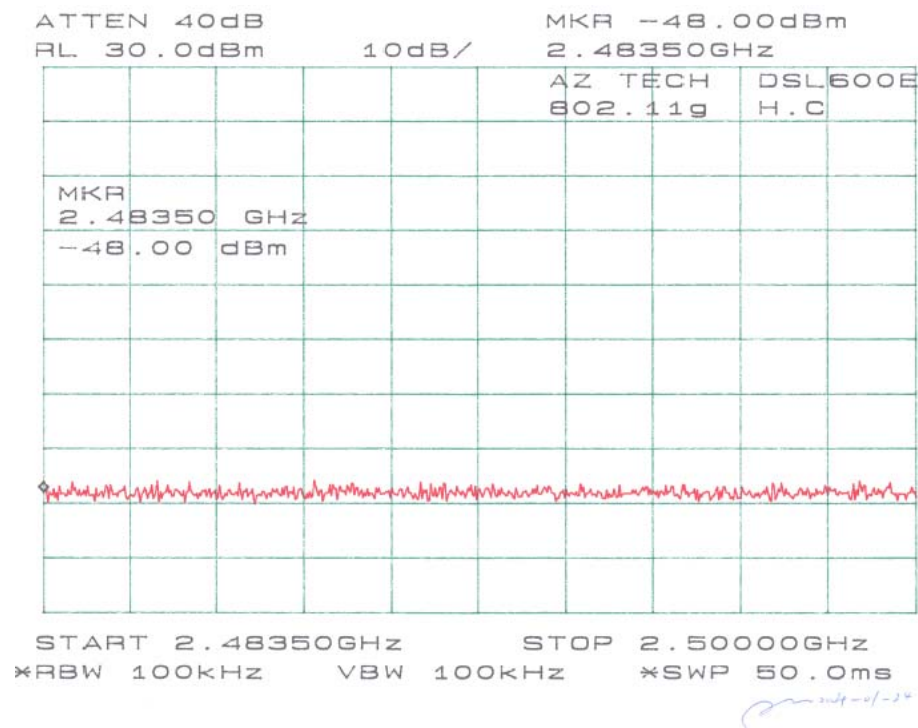
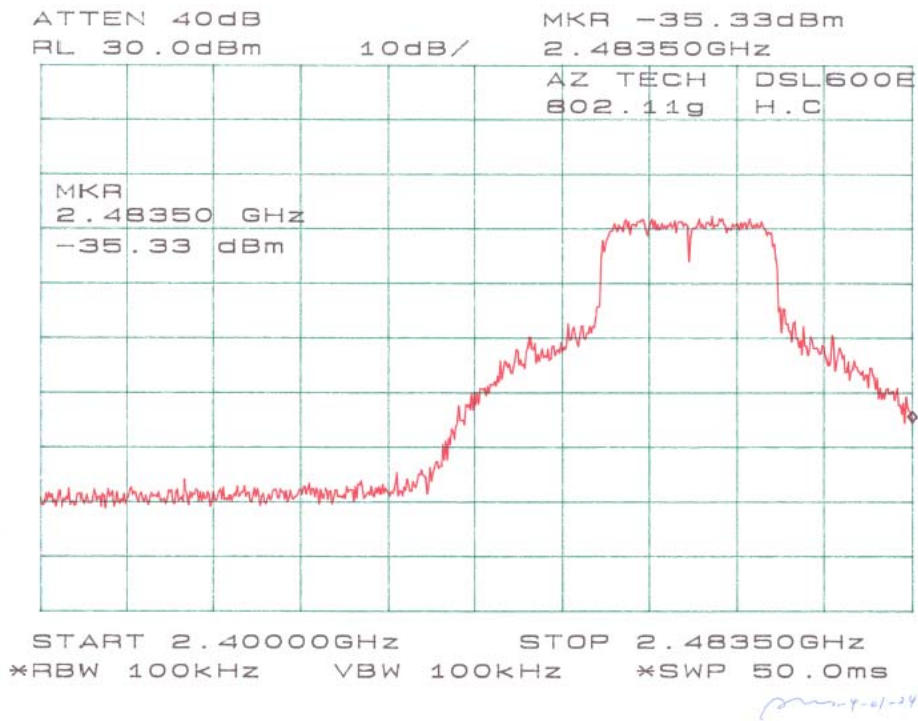

§15.247(d) - POWER SPECTRAL DENSITY

Standard Applicable

According to §15.247 (d), for direct sequence systems, the peak power spectral density conducted from the intentional radiator to the antenna shall not be greater than 8 dBm in any 3 kHz band during any time interval of continuous transmission.

Measurement Procedure

1. Check the calibration of the measuring instrument using either an internal calibrator or a known signal from an external generator.
2. Position the EUT was set without connection to measurement instrument. Turn on the EUT and connect its antenna terminal to measurement instrument via a low loss cable. Then set it to any one measured frequency within its operating range, and make sure the instrument is operated in its linear range.
3. Adjust the center frequency of SA on any frequency be measured and set SA to 6MHz span mode. And then, set RBW and VBW of spectrum analyzer to proper value. (DTS)
4. Adjust the center frequency of SA on any frequency be measured and set SA to 50MHz span mode. And then, set RBW and VBW of spectrum analyzer to proper value. (UNII)
5. Repeat above procedures until all frequencies measured were complete.

Equipment Lists

Manufacturer	Model No.	Description	Calibration Date
HP	8565EC	Spectrum Analyzer	2003-01-22

Measurement Results**Environmental Conditions**

Temperature:	12° C
Relative Humidity:	48%
ATM Pressure:	1100 mbar

Test Result for 802.11b (15.247)

Channel	Frequency (MHz)	Peak Power Spectral Density (dBm)	Standard (dBm)	Result
Low	2412	-11.00	≤ 8	Pass
Mid	2437	-11.50	≤ 8	Pass
High	2462	-12.00	≤ 8	Pass

Test Result for 802.11g (15.247)

Channel	Frequency (MHz)	Peak Power Spectral Density (dBm)	Standard (dBm)	Result
Low	2412	-13.00	≤ 8	Pass
Mid	2437	-12.67	≤ 8	Pass
High	2462	-12.83	≤ 8	Pass

