

Label information Anti Pilferage System, FCC ID: CGDXQ

All system units carry the label below: The label size is 50mm (w) x 30 mm. The label is affixed next to the NCC4 FCC label (see second label).

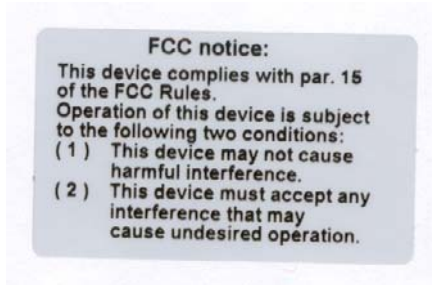

System unit NCC4 uses label below: The label size is 50mm (w) x 30 mm (h). The font size of the FCC ID is 8pt. The label is affixed on the side of the metal encasing. Page 2 of this document shows a drawing with the location indicated.

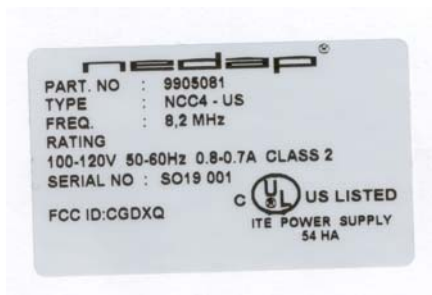

Antenna devices use label label below. The label size is 50mm (w) x 50 mm (h). The font size of the FCC ID is 8pt. The label is affixed on the side of antennas. Pages 3,4 and 5 of this document show drawings of the respective antenna with the label location indicated.

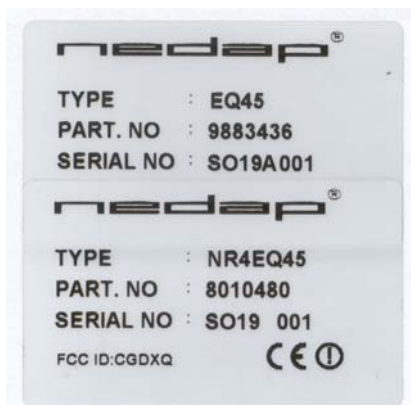

AANZICHT ZONDER DEKSEL ⑤ EN SLOT ⑥

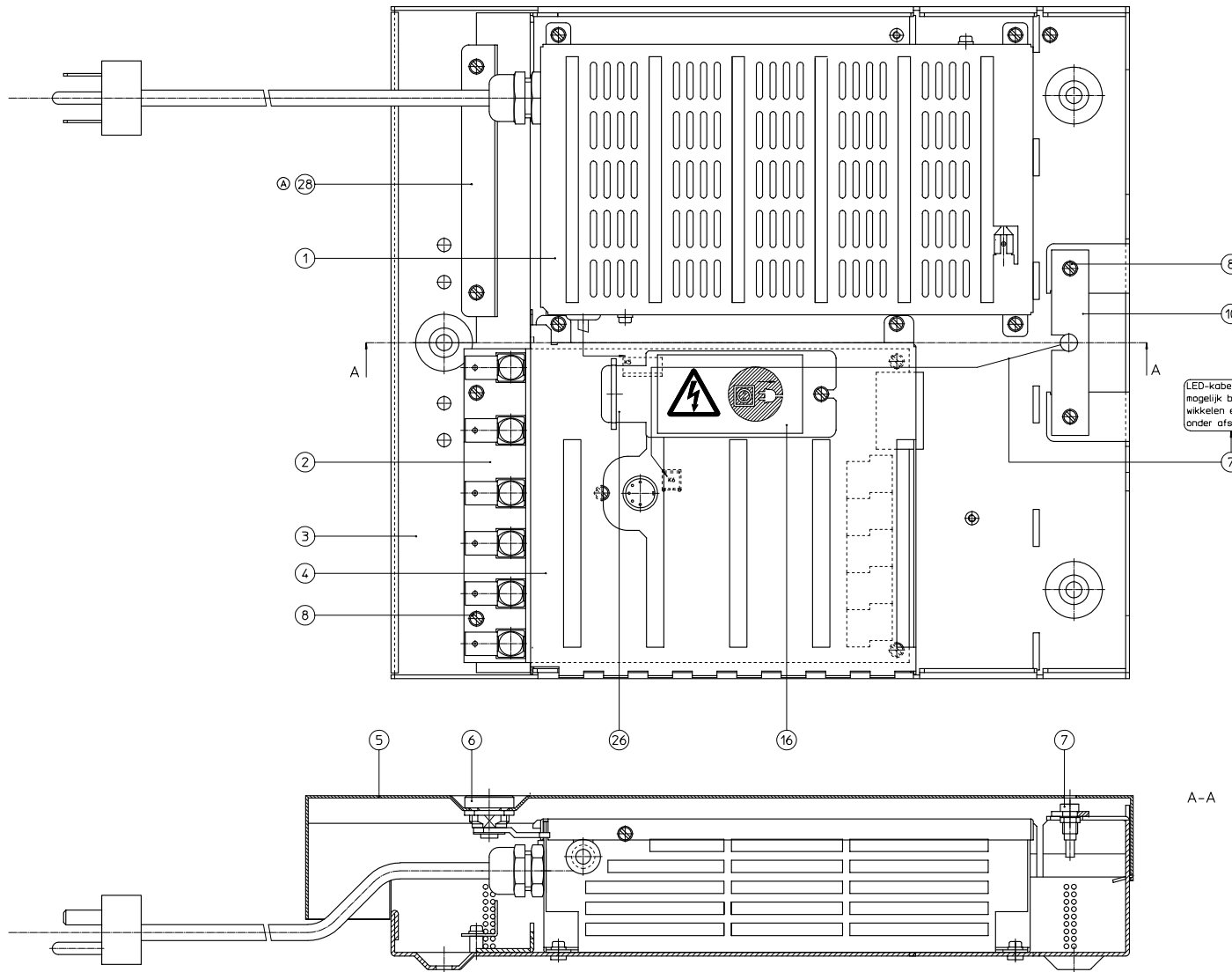

LED-kabel van pos 7 zoveel mogelijk bij elkaar wikkelen en fixeren onder afscherming pos 26

A-A

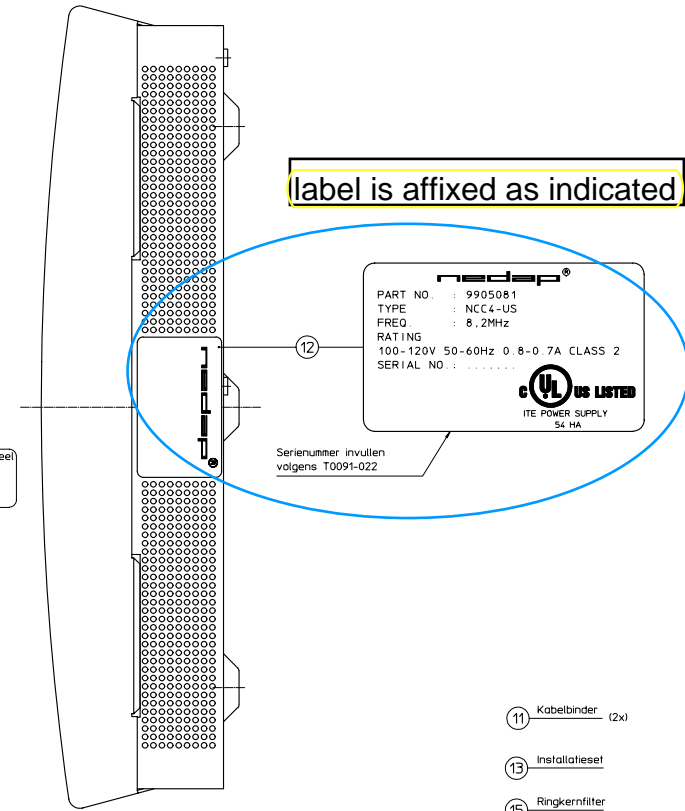

label is affixed as indicated

nedap
 PART NO. : 9905081
 TYPE : NCC4-US
 FREQ : 8,2MHz
 RATING : 100-120V 50-60Hz 0,8-0,7A CLASS 2
 SERIAL NO. :
UL US LISTED
 ITE POWER SUPPLY
 54 HA

Serienummer invullen volgens T0091-022

- ⑪ Kabelbinder (2x)
- ⑬ Installatieset
- ⑮ Ringkernfilter
- ⑰ Ferrieltkern
- ⑲ Verpakking
- ⑳
- ㉑
- ㉒
- ㉓
- ㉔
- ㉕

| | | | | | |
|--|-------|----------|-------------------------------|------------------|------------------------------------|
| | E | | | | |
| | D | | | | |
| | C | | | | |
| | B | | | | |
| 10015 | A | 20040702 | Pos 28 en 2x pos 8 toegevoegd | | RZ |
| Wijz. Nr. | Index | Datum | Omschrijving | | Get. |
| | | | Ruimte: ISO 1302 in µm | Maatleenheid: mm | Ontw: RZ d.d. 20031218 |
| | | | TOLERANTIE: Lineair | | Schaal: 1:1 Get: RZ d.d. 20040407 |
| | | | (tenzij anders vermeld) | Hoek | Formaat: A 1 Get: RZ d.d. 20040407 |
| | | | ISO A | | te Hogere niveau |
| OST VOEDING-STURING 8,2MHz US | | | | | Nr.: T1078-171 |
| Dit document is het eigendom van de NV Nederlandse Apparatenfabriek - NEDAP - en mag zonder toestemming niet aan derden ter inzage worden gegeven of worden gecopieerd. Auteursrecht voorbehouden volgens de wet | | | | | Blad: 10.01 Van: 1 |
| | | | | | Artikelnummer: 9905081 |

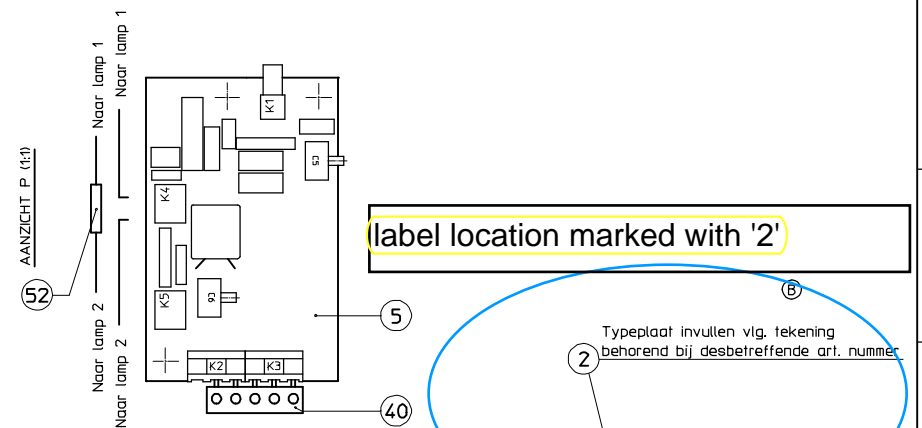
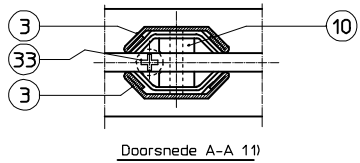

label location marked with '2'

Typeplaat invullen vlg. tekening behorend bij desbetreffende art. nummer

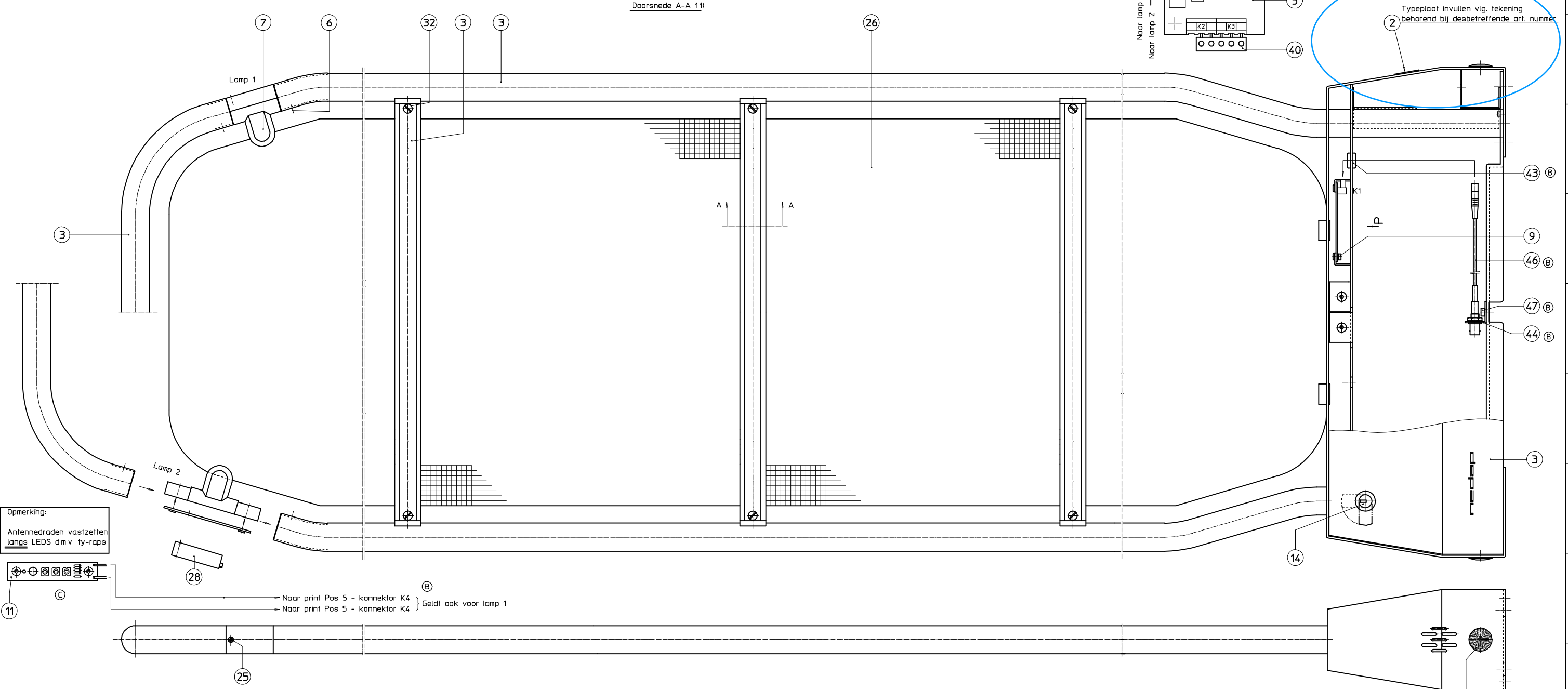

Opmerking:
Antennedraden vastzetten langs LEDS dmv ty-raps

Naar print Pos 5 - konektor K4 } Geldt ook voor lamp 1
Naar print Pos 5 - konektor K4

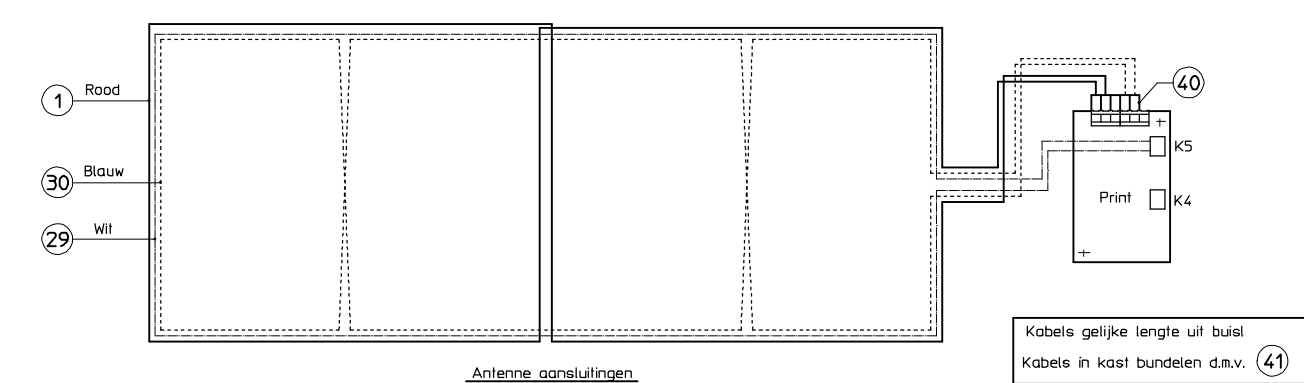

- Los meeleveren: (15) Installatieset
- Los meeleveren: (38) Onverpakt
- Verpakking: (17)(18)(19)(20)(21)

Steutets van (14) verpakken in (42)
en op antennebuis plakken

| | | | | |
|--|-------|---|---|--|
| | E | | | |
| | D | | | |
| 9839 | C | 021023 | Lampprint vervangen door LED print | |
| 7556 | B | 960329 | Pos 46 1/m 51 toegevo. PMS opgehaagd; Aanpassing aan details | |
| 7409 | A | 960102 | Vervallen, 2x Pos 9, Pos 8, Pos 22, Pos 24, Pos 46 | |
| Wijz. Nr. | Index | Datum | Omschrijving wijziging | Get. |
| 1077-372-10 01 | | | Ruwh: ISO 1302 in µm Maateenheid: mm Ontw: JH d.d. 950905 | |
| GROENLO HOLLAND | ISO A | TOLERANTIE: Lineair fenzij anders vermeld: | Schaal 1 2 Formaat: A 1 | Get. JH d.d. 950905 Gec. JH d.d. 950911 |
| ZUIL E450ID/L | | | | 1e Hogere niveau: Nr. T1077-372 |
| Dit document is het eigendom van de NV. Nederlandse Apparatenfabriek - NEDAP - en mag zonder toestemming niet aan derden ter inzage worden gegeven of worden gecopieerd. Auteursrecht voorbehouden volgens de wet. | | | | Blad: 10.01 Van: 1 Artikelnummer: ----- |

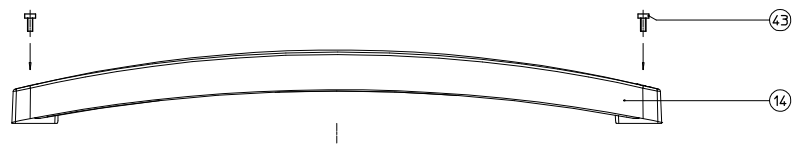
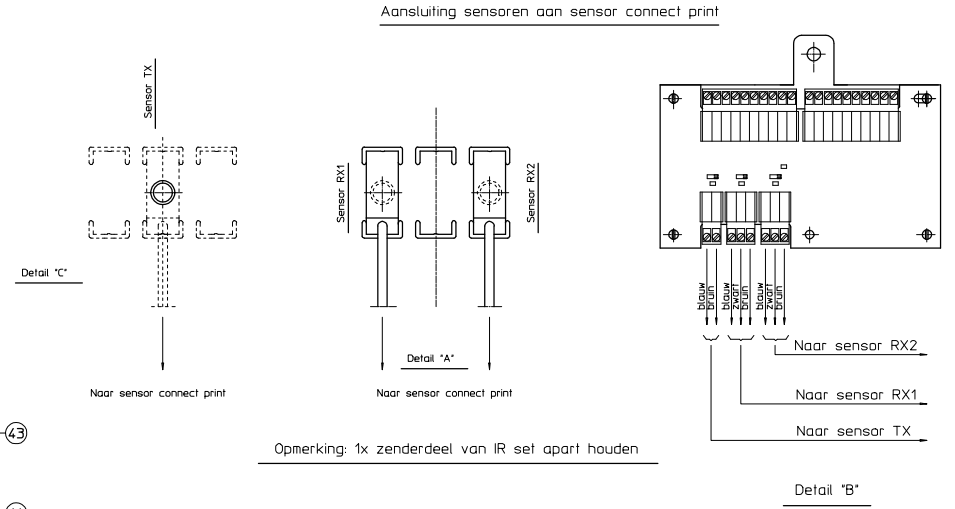
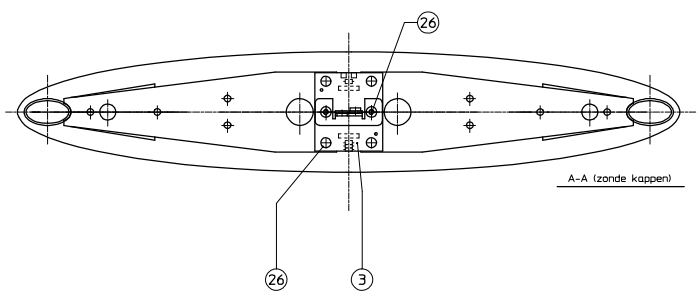

Let op! Geboorde kap op juiste plaats t.o.v unit monteren

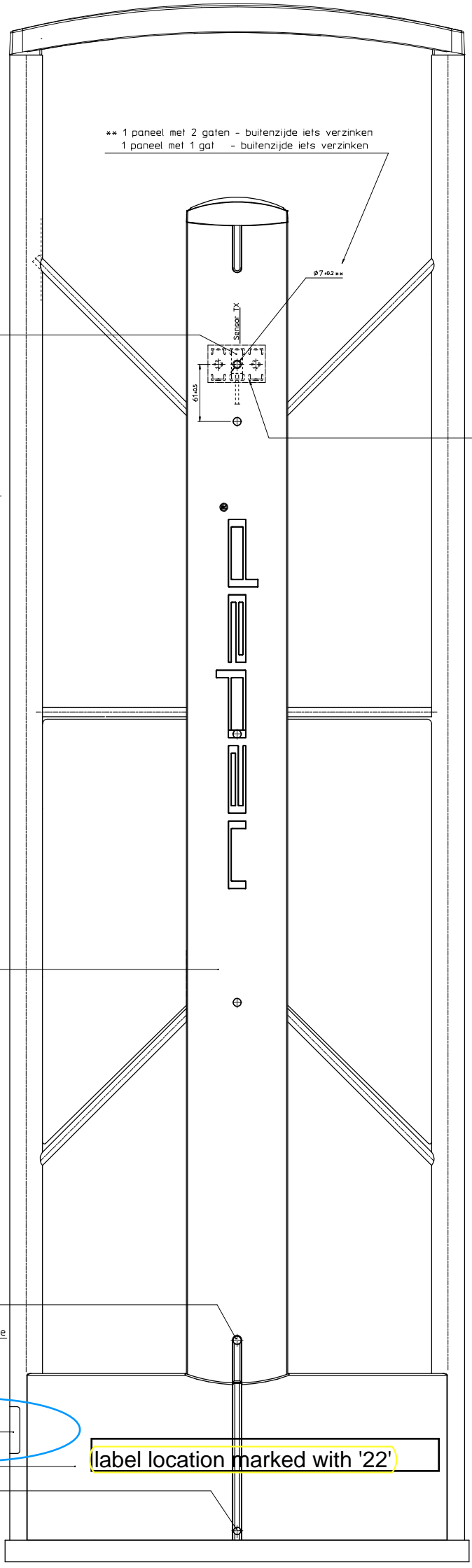
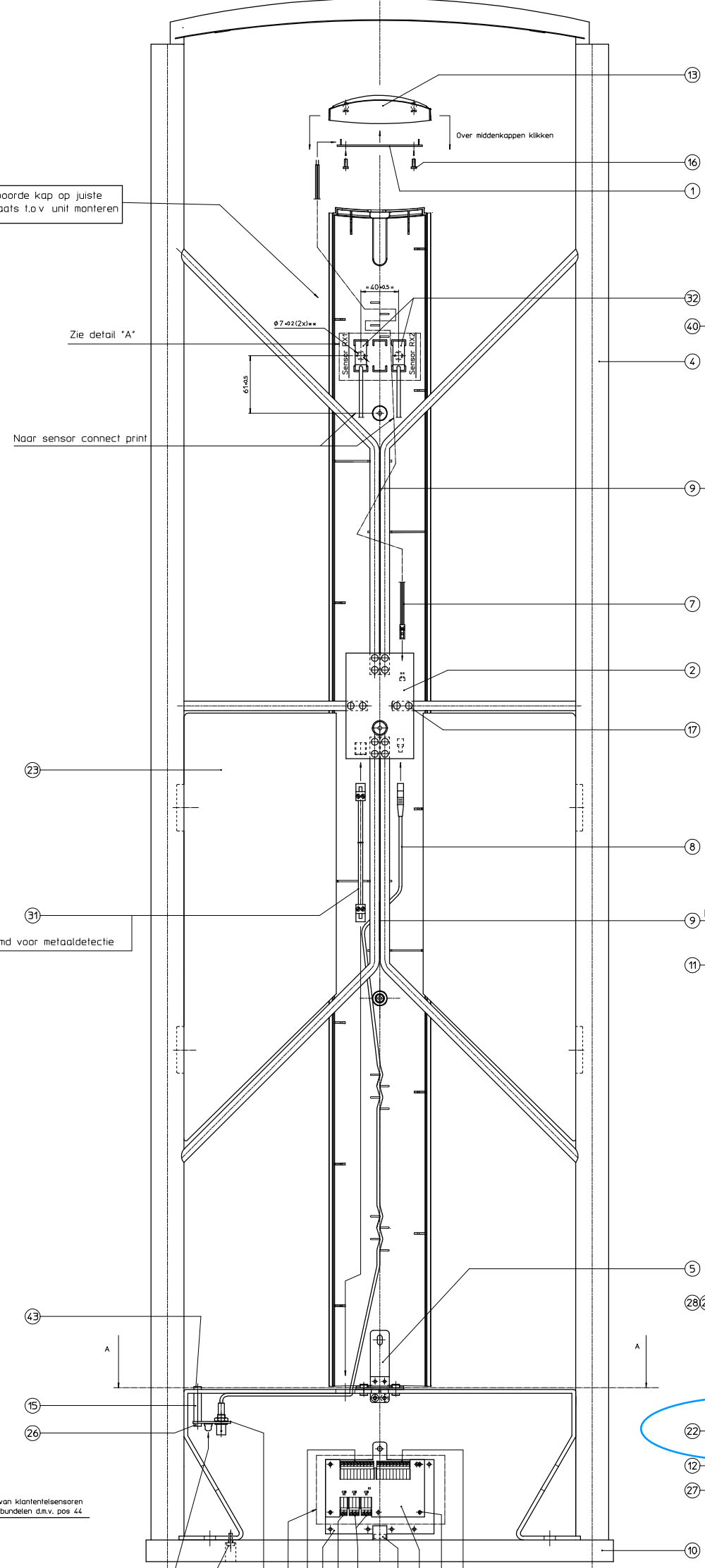

Los meeleveren

Verpakking

| | | | | | |
|--|-------|-------|--------------|------------------------|---|
| E | | | | | |
| D | | | | | |
| C | | | | | |
| B | | | | | |
| A | 9818 | A | 020403 | Pos 41 + 42 toegevoegd | Get: - |
| Wijz. Nr. | Index | Datum | Omschrijving | | |
| 1078-720-10.01 | | | | Ruwh: ISO 1902 in µm | Maatleenheid: mm Dntw: JH d.d. 011203 |
| TOLERANTIE: | | | Lineair | Schaal: 1: 2 | Get: JH d.d. 011203 |
| Groenlo Holland | | | Hoek | Formaat: A 0 | d.d.: - |
| | | | vermeld | ISO 9001 | te hogere niveau |
| ZUIL EQ45 - CC-RX/TX | | | | | Nr.: T1078-720 |
| Dit document is het eigendom van de N.V. Nederlandse Apparatenfabriek - NEDAP - en mag zonder toestemming niet aan derden ter inzage worden gegeven of worden gecopieerd. Auteursrecht voorbehouden volgens de wet | | | | | Blad: 10.01 Van: 1 |
| | | | | | Artikelnummer: |

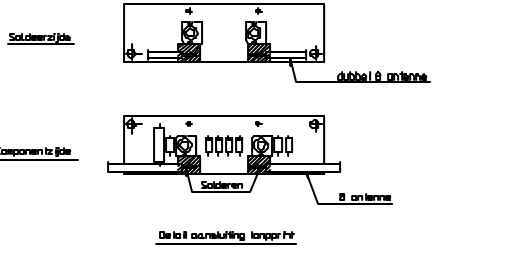

Alle RV3 delen na montage behandelen met ³⁰

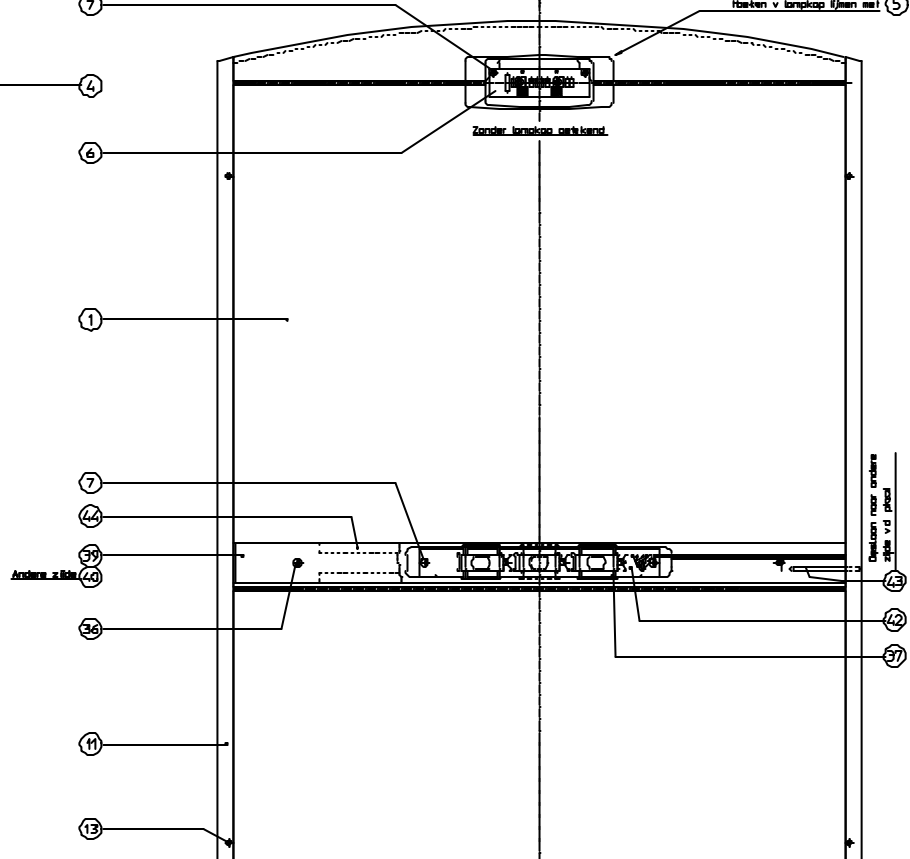
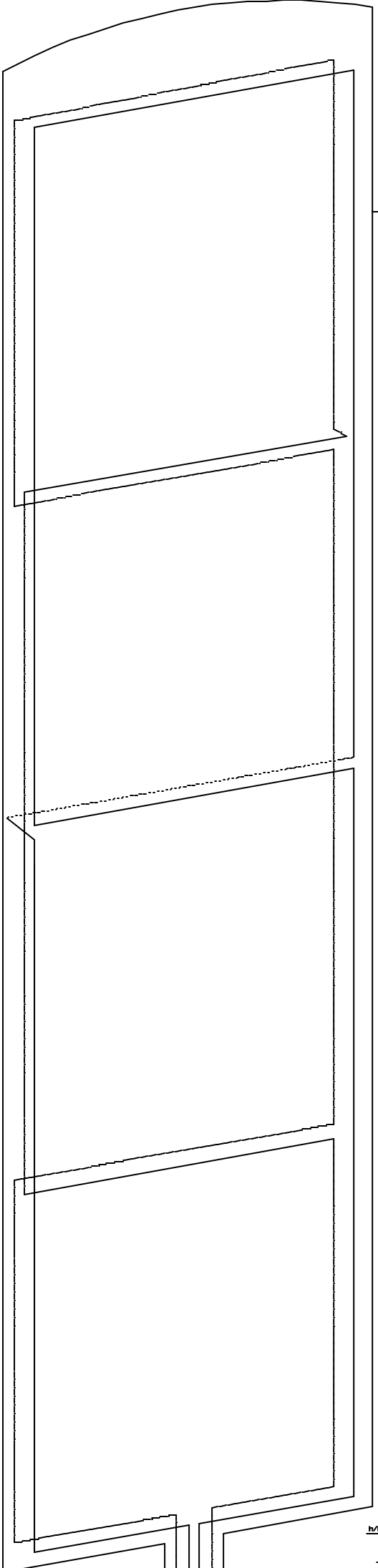
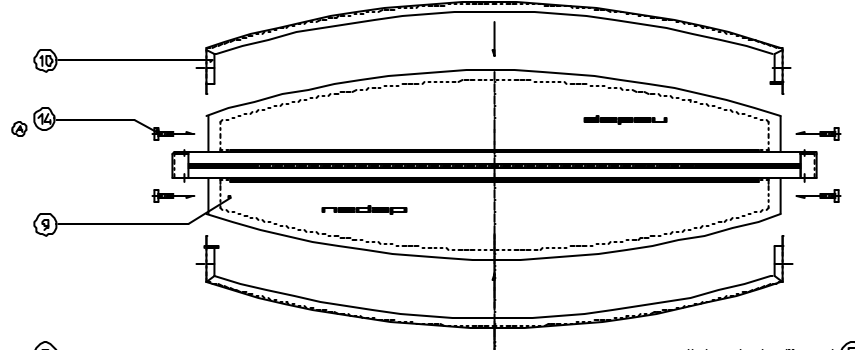

label location as indicated

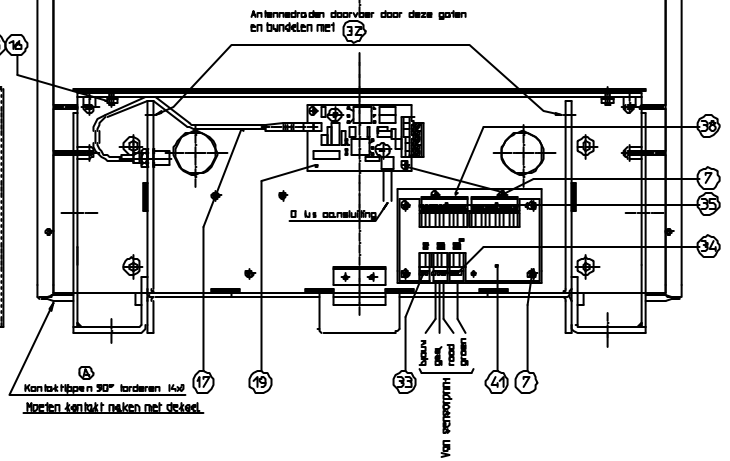
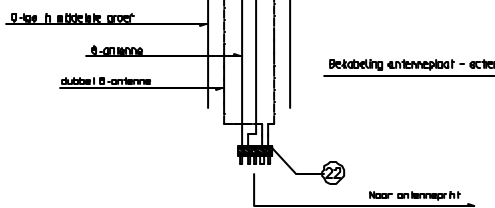
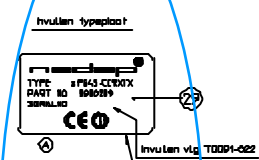

Los mee te leveren: 2x Ringklemmer ²⁰
1x Helelootbeest ²¹
1x Waaiingsvoorzicht ²⁶

Verpakking ^{23 27 28 31}

| | | | | | |
|--|--|--|--|--|--|
| E | | | | | |
| D | | | | | |
| C | | | | | |
| B | | | | | |
| A | | | | | |
| <p>9998 A 03425 de bevestigingswijze voor de bevestigingsarmen de 1e</p> <p>V.N. N. Inzet Dabur Omschrijvingen</p> <p>078-448-001 Rijk B0 1982 h en Maken de rijk JH d.d. 02114</p> <p>DORLAND HOLLAND</p> | | | | | |
| <p>ZUL PG45 - CCRXTX</p> <p>Nr T1078-940</p> | | | | | |