

| | | | | |
|--|--|---|-----------------------------|--|
| Prüfbericht-Nr.: <i>Test Report No.:</i> | 50157347 001 | Auftrags-Nr.: <i>Order No.:</i> | 114078743 | Seite 1 von 43 <i>Page 1 of 43</i> |
| Kunden-Referenz-Nr.: <i>Client Reference No.:</i> | N/A | Auftragsdatum: <i>Order date:</i> | 13-Jun-2018 | |
| Auftraggeber: <i>Client:</i> | N.V. Nederlandsche Apparatenfabriek "Nedap" , Parallelweg 2, 7141 DC Groenlo, The Netherlands | | | |
| Prüfgegenstand: <i>Test item:</i> | Lumen iL33 | | | |
| Bezeichnung / Typ-Nr.: <i>Identification / Type No.:</i> | ASSY T325R RF+RFID, ASSY T325R RF+MD+RFID | | | |
| Auftrags-Inhalt: <i>Order content:</i> | FCC/IC Test report | | | |
| Prüfgrundlage: <i>Test specification:</i> | FCC 47CFR Part 15: Subpart C Section 15.247 RSS-247 (02-2017) | | | |
| Wareneingangsdatum: <i>Date of receipt:</i> | 4-Jul-2018 | | | |
| Prüfmuster-Nr.: <i>Test sample No.:</i> | A000769422-005, A000769422-006 | | | |
| Prüfzeitraum: <i>Testing period:</i> | 9-Jul-2018 - 17-Jul-2018 | | | |
| Ort der Prüfung: <i>Place of testing:</i> | EMC Laboratory Taipei | | | |
| Prüflaboratorium: <i>Testing laboratory:</i> | TUV Rheinland Taiwan Ltd. | | | |
| Prüfergebnis*: <i>Test result*:</i> | Pass | | | |
| geprüft von / tested by: | | kontrolliert von / reviewed by: | | |
| 2018-08-17 Ryan W. T. Chen / Project Manager | | 2018-08-17 Rene Charton/Expert | | |
| Datum <i>Date</i> | Name / Stellung <i>Name / Position</i> | Unterschrift <i>Signature</i> | Datum <i>Date</i> | Name / Stellung <i>Name / Position</i> |
| | | | | Unterschrift <i>Signature</i> |
| Sonstiges / Other: | | | | |
| Zustand des Prüfgegenstandes bei Anlieferung: <i>Condition of the test item at delivery:</i> | | Prüfmuster vollständig und unbeschädigt <i>Test item complete and undamaged</i> | | |
| * Legende: 1 = sehr gut 2 = gut 3 = befriedigend 4 = ausreichend 5 = mangelhaft P(ass) = entspricht o.g. Prüfgrundlage(n) F(ail) = entspricht nicht o.g. Prüfgrundlage(n) N/A = nicht anwendbar N/T = nicht getestet | | | | |
| Legend: 1 = very good 2 = good 3 = satisfactory 4 = sufficient 5 = poor P(ass) = passed a.m. test specification(s) F(ail) = failed a.m. test specification(s) N/A = not applicable N/T = not tested | | | | |
| Dieser Prüfbericht bezieht sich nur auf das o.g. Prüfmuster und darf ohne Genehmigung der Prüfstelle nicht auszugsweise vervielfältigt werden. Dieser Bericht berechtigt nicht zur Verwendung eines Prüfzeichens. <i>This test report only relates to the a. m. test sample. Without permission of the test center this test report is not permitted to be duplicated in extracts. This test report does not entitle to carry any test mark.</i> | | | | |

TEST SUMMARY

5.1.1 ANTENNA REQUIREMENT*RESULT: Passed***5.1.2 PEAK OUTPUT POWER***RESULT: Passed***5.1.3 20dB BANDWIDTH***RESULT: Passed***5.1.4 99% BANDWIDTH***RESULT: Passed***5.1.5 CONDUCTED SPURIOUS EMISSIONS AND FREQUENCY BAND EDGE MEASURED IN 100kHz BANDWIDTH***RESULT: Passed***5.1.6 SPURIOUS EMISSION***RESULT: Passed***5.1.7 FREQUENCY SEPARATION***RESULT: Passed***5.1.8 NUMBER OF HOPPING CHANNELS***RESULT: Passed***5.1.9 TIME OF OCCUPANCY***RESULT: Passed***5.2.1 MAINS CONDUCTED EMISSIONS***RESULT: Passed***6.1.1 ELECTROMAGNETIC FIELDS***RESULT: Passed*

Contents

| | | |
|--------------|---|-----------|
| 1. | GENERAL REMARKS | 5 |
| 1.1 | COMPLEMENTARY MATERIALS | 5 |
| 2. | TEST SITES | 6 |
| 2.1 | TEST FACILITIES | 6 |
| 2.2 | LIST OF TEST AND MEASUREMENT INSTRUMENTS..... | 7 |
| 2.3 | TRACEABILITY | 8 |
| 2.4 | CALIBRATION | 8 |
| 2.5 | MEASUREMENT UNCERTAINTY | 8 |
| 3. | GENERAL PRODUCT INFORMATION | 9 |
| 3.1 | PRODUCT FUNCTION AND INTENDED USE..... | 9 |
| 3.2 | SYSTEM DETAILS AND RATINGS | 10 |
| 3.3 | INDEPENDENT OPERATION MODES | 11 |
| 3.4 | NOISE GENERATING AND NOISE SUPPRESSING PARTS | 11 |
| 3.5 | SUBMITTED DOCUMENTS | 11 |
| 4. | TEST SET-UP AND OPERATION MODES | 12 |
| 4.1 | PRINCIPLE OF CONFIGURATION SELECTION..... | 12 |
| 4.2 | TEST OPERATION AND TEST SOFTWARE..... | 12 |
| 4.3 | SPECIAL ACCESSORIES AND AUXILIARY EQUIPMENT | 12 |
| 4.4 | COUNTERMEASURES TO ACHIEVE EMC COMPLIANCE..... | 13 |
| 4.5 | TEST SETUP DIAGRAM..... | 13 |
| 5. | TEST RESULTS | 15 |
| 5.1 | TRANSMITTER REQUIREMENT & TEST SUITES | 15 |
| 5.1.1 | <i>Antenna Requirement.....</i> | <i>15</i> |
| 5.1.2 | <i>Peak Output Power.....</i> | <i>16</i> |
| 5.1.3 | <i>20dB Bandwidth.....</i> | <i>19</i> |
| 5.1.4 | <i>99% Bandwidth.....</i> | <i>22</i> |
| 5.1.5 | <i>Conducted spurious emissions and Frequency Band Edge measured in 100kHz Bandwidth.....</i> | <i>24</i> |
| 5.1.6 | <i>Spurious Emission.....</i> | <i>29</i> |
| 5.1.7 | <i>Frequency Separation.....</i> | <i>30</i> |
| 5.1.8 | <i>Number of Hopping Channels.....</i> | <i>32</i> |
| 5.1.9 | <i>Time of Occupancy.....</i> | <i>34</i> |
| 5.2 | MAINS EMISSIONS | 36 |
| 5.2.1 | <i>Mains Conducted Emissions.....</i> | <i>36</i> |
| 6. | SAFETY HUMAN EXPOSURE | 37 |

| | | |
|------------|--|-----------|
| 6.1 | RADIO FREQUENCY EXPOSURE COMPLIANCE | 37 |
| 6.1.1 | <i>Electromagnetic Fields.....</i> | <i>37</i> |
| 7. | PHOTOGRAPHS OF THE TEST SET-UP | 39 |
| 8. | LIST OF TABLES | 43 |
| 9. | LIST OF PHOTOGRAPHS | 43 |

1. General Remarks

1.1 Complementary Materials

All attachments are integral parts of this test report. This applies especially to the following appendix:

- Appendix P: Photo Documentation**
(File Name: 50157347APPENDIX P)
Appendix D: Test Result of Radiated Emissions
(File Name: 50157347APPENDIX D)

Test Specifications

The following standards were applied

Table 1: Applied Standard and Test Levels

| Radio |
|---|
| FCC CFR47 Part 15: Subpart C Section 15.247 RSS-247 Issue 2 Feb 2017 RSS-Gen, Issue 4, November 2014 ANSI C63.10:2013 NCC Low-power Radio-frequency Devices Technical Regulations LP0002(2016)(105年6月28日) |

2. Test Sites

2.1 Test Facilities

TUV Rheinland Taiwan Ltd.

11F. No.758, Sec. 4, Bade Rd., Songshan Dist.
Taipei City 105
Taiwan (R.O.C.)

FCC Registration No.: 340738
IC Canada Registration No.: 9465A-1
TAF Accredited NCC Test Lab. No.:0759

TAF ISO17025 Certification effective period: 2016-Jul-1st to 2019-Jun-30th



Testing Laboratory
0759

2.2 List of Test and Measurement Instruments

Table 2: List of Test and Measurement Equipment

| Kind of Equipment | Manufacturer | Type | S/N | Last Calibration | Next Calibration |
|-------------------------------|----------------|-----------|-------------|------------------|------------------|
| Test Software | Farad | EZ_EMCC | Ver. TUV3A1 | N/A | N/A |
| EMI Test Receiver | R&S | ESR 7 | 101549 | 2017/11/10 | 2018/11/10 |
| Spectrum Analyzer | R&S | FSV 40 | 100921 | 2018/05/02 | 2019/05/02 |
| EXA Signal Analyzer | KEYSIGHT | N9010A | MY52221334 | 2018/02/05 | 2019/02/04 |
| Preamplifier (30MHz -1GHz) | HP | 8447F | 2805A03335 | 2017/08/14 | 2018/08/14 |
| Preamplifier (18 GHz -40 GHz) | COM-POWER | PAM-840 | 461257 | 2018/01/18 | 2019/01/18 |
| Pre-Amplifier (1GHz~18GHz) | EM Electronics | EM01G18G | 60558 | 2017/11/21 | 2018/11/21 |
| Bilog Antenna | TESEQ | CBL6111D | 29804 | 2017/08/18 | 2018/08/18 |
| Horn Antenna | ETS-Lindgren | 3117 | 201918 | 2017/08/18 | 2018/08/18 |
| Horn Antenna (18GHz~40GHz) | COM-POWER | AH-840 | 101029 | 2017/11/28 | 2018/11/28 |
| Loop Antenna | Schwarzbeck | FMZB 1513 | 1513-076 | 2018/06/14 | 2019/06/14 |
| EMI Test Receiver | R&S | ESR 7 | 101549 | 2017/11/10 | 2018/11/10 |

2.3 Traceability

All measurement equipment calibrations are traceable to NML(Taiwan)/NIST(USA) or where calibration is performed outside Taiwan, to equivalent nationally recognized standards organizations.

2.4 Calibration

Equipment requiring calibration is calibrated periodically in a suitably accredited Calibration Lab. Additionally all equipment is verified for proper performance on a regular basis using in house standards or comparisons.

2.5 Measurement Uncertainty

The estimated combined standard uncertainty for radiated emissions and conducted emissions measurements:.

Table 3: Emission Measurement Uncertainty

| Parameter | Uncertainty |
|-------------------------------|------------------------|
| Radio Frequency | $\pm 1 \times 10^{-7}$ |
| RF power, conducted | ± 1.5 dB |
| RF power density, conducted | ± 3 dB |
| spurious emissions, conducted | ± 3 dB |
| all emissions, radiated | ± 6 dB |
| Temperature | ± 1 °C |
| Humidity | ± 5 % |
| DC and low frequency voltages | ± 3 % |

3. General Product Information

3.1 Product Function and Intended Use

The EUT is an Electronic Article Surveillance System. There are 2 models with different features implemented. The fully featured version model ASSY T325R RF+MD+RFID incorporates an UHF RFID reader, a Tag detector working in the 7-8 MHz Band and a metal detector that works at a frequency around 125 kHz.

The alternative version model ASSY T325R RF+RFID does not have the 125 kHz current generator and field sensing module for the metal detector installed, but the antenna system is the same for both versions.

This test report relates to the 902-928MHz UHF portion of the device.
Tests were performed on model ASSY T325R RF+MD+RFID.

For details refer to the User Guide, Data Sheet and Circuit Diagram.

3.2 System Details and Ratings

Table 4: Basic Information of EUT

| Item | EUT information | |
|-----------------------------|---|------------------------|
| Kind of Equipment/Test Item | Lumen iL33 | |
| Type Identification | ASSY T325R RF+RFID, ASSY T325R RF+MD+RFID | |
| | with metal detector | without metal detector |
| FCC ID | CGDT325RRFMDID | CGDT325RRFID |
| Canada ID | 1444A-T325RRFMDID | 1444A-T325RRFID |
| HVIN | ASSY T325R RF+MD+RFID | ASSY T325R RF+RFID |

Table 5: Technical Specification of EUT

| Technical Specification | Value |
|-------------------------|---------------------------|
| Operating Frequency | 902.75 MHz ... 927.25 MHz |
| Channel Spacing | 500 kHz |
| Channel number | 50 |
| Operation Voltage | 120V (PoE adapter) |
| Modulation | Hopping |
| Antenna gain | 4.1dBi |

3.3 Independent Operation Modes

The basic operation modes are:

- A. Transmitting
 - 1. Low channel
 - 2. Middle channel
 - 3. High channel
- B. Receiving

3.4 Noise Generating and Noise Suppressing Parts

Refer to the Circuit Diagram.

3.5 Submitted Documents

- Circuit Diagram
- Instruction Manual
- Rating Label
- Technical Description

4. Test Set-up and Operation Modes

4.1 Principle of Configuration Selection

The equipment under test (EUT) was configured to measure its maximum power level. The test modes were adapted accordingly in reference to the instructions for use.

4.2 Test Operation and Test Software

Test operation refers to test setup in chapter 4. All testing were performed according to the procedures in ANSI C63.10: 2013.

The samples were used as follows:

Conducted: A000769422-006

Radiation: A000769422-005, A000769422-006

Full test was applied on all test modes, but only worst case was shown.

4.3 Special Accessories and Auxiliary Equipment

The product has been tested together with the following additional accessories:

| Kind of Equipment | Manufacturer | Model Name | S/N |
|-------------------|--------------|------------|-----|
| -- | -- | -- | -- |

4.4 Countermeasures to achieve EMC Compliance

The test sample which has been tested containing the noise suppression parts as in the Photo Appendix and the Test Setup Photos. No additional measures were employed to achieve compliance.

4.5 Test Setup Diagram

Diagram of Measurement Configuration for Radiation Test

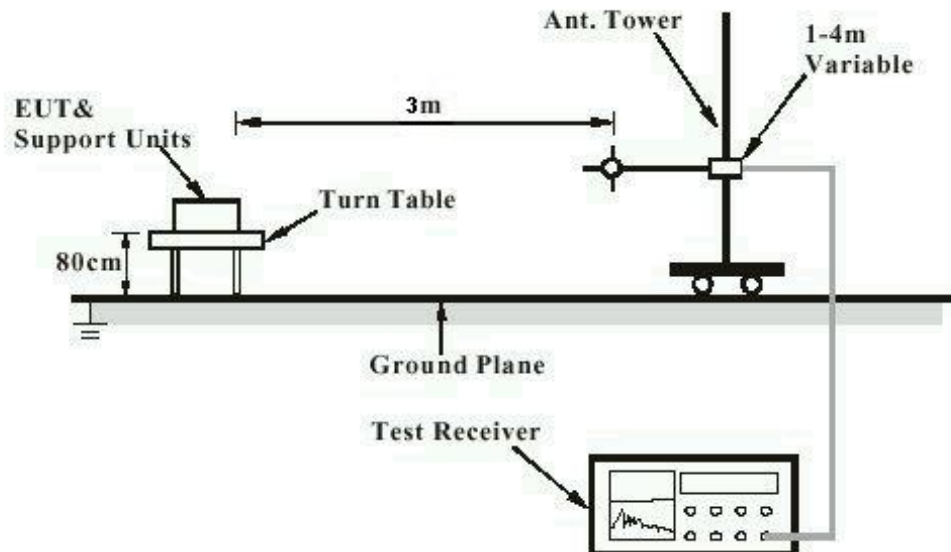

Note: Measurements above 1 GHz are done with a table height of 1.5m

Diagram of Measurement Equipment Configuration for Mains Conduction Measurement

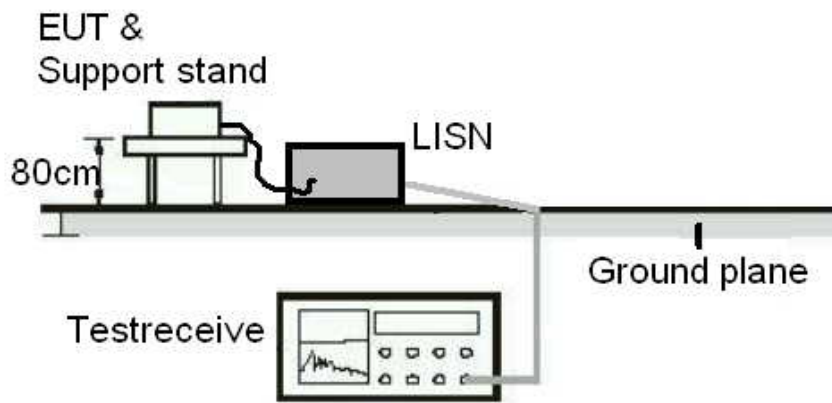
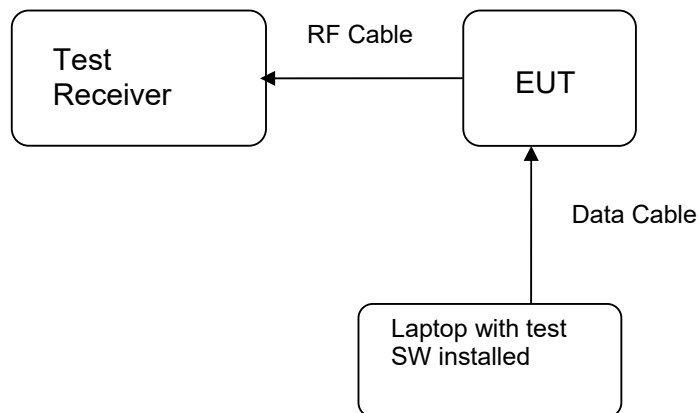

Diagram of Measurement Equipment Configuration for Conducted Transmitter Measurement



5. Test Results

5.1 Transmitter Requirement & Test Suites

5.1.1 Antenna Requirement

RESULT: **Passed**

| | | |
|---------------|---|--|
| Test standard | : | LP0002(2011): 2.2, 3.10.1, (3) FCC Part 15.247(b)(4), Part 15.203 and RSS- Gen 8.3 |
| Requirement | : | use of approved antennas only with directional gains that do not exceed 6 dBi |

According to the manufacturer declaration, the EUT has an antenna with a directional gain of 4.1dBi dBi.

The antenna and the Transmitter Circuit are one unit with no possibility of replacement with a non-approved antenna by the end-user. Therefore, the EUT is considered to comply with this provision.

Refer to EUT photo for details.

5.1.2 Peak Output Power

RESULT:
Passed

Test standard : FCC Part 15.247(b)(1),
 RSS-247 5.4(2)
 LP0002(2011): 3.10.1, (2)
 Basic standard : ANSI C63.10:2013
 LP0002(2011) Appendix II
 Kind of test site : Shielded room

Test setup

Test Channel : Low/ Middle/ High
 Operation Mode : A

 Ambient temperature : 22-26 °C
 Relative humidity : 50-65 %
 Atmospheric pressure : 100-103 kPa

Table 6: Test result of Peak Output

| Channel | Channel Frequency | Peak Output Power | | Limit |
|----------------|-------------------|-------------------|--------|-------|
| | (MHz) | (dBm) | (W) | (W) |
| Low Channel | 902.75 MHz | 29.92 | 0.9817 | 1 |
| Middle Channel | 915.25 MHz | 29.57 | 0.9057 | 1 |
| High Channel | 927.25 MHz | 29.50 | 0.8913 | 1 |

Test Plot of Peak Output Power, Low Channel

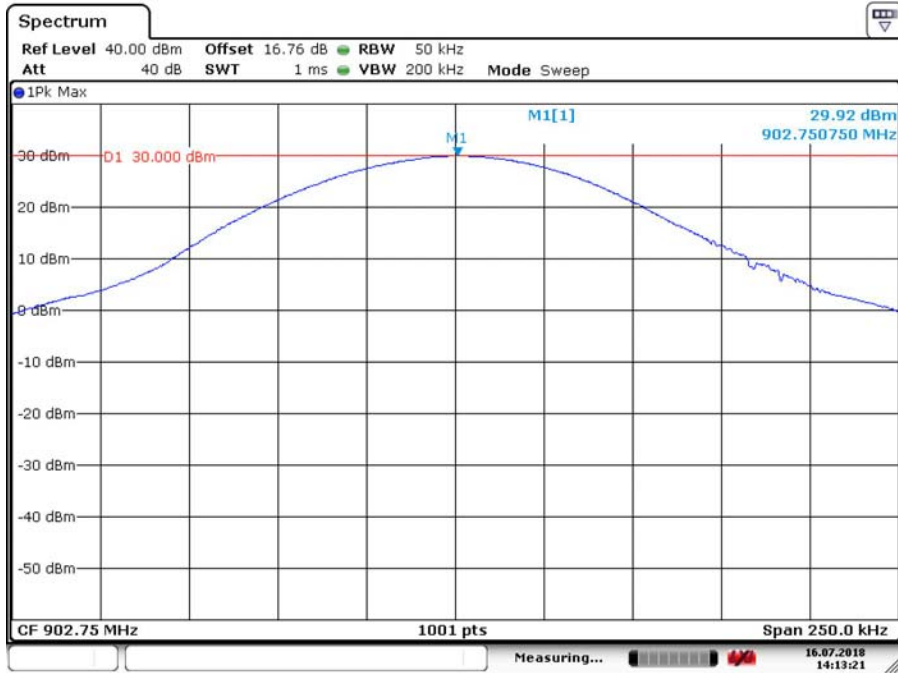

Date: 16.JUL.2018 14:13:21

Middle Channel

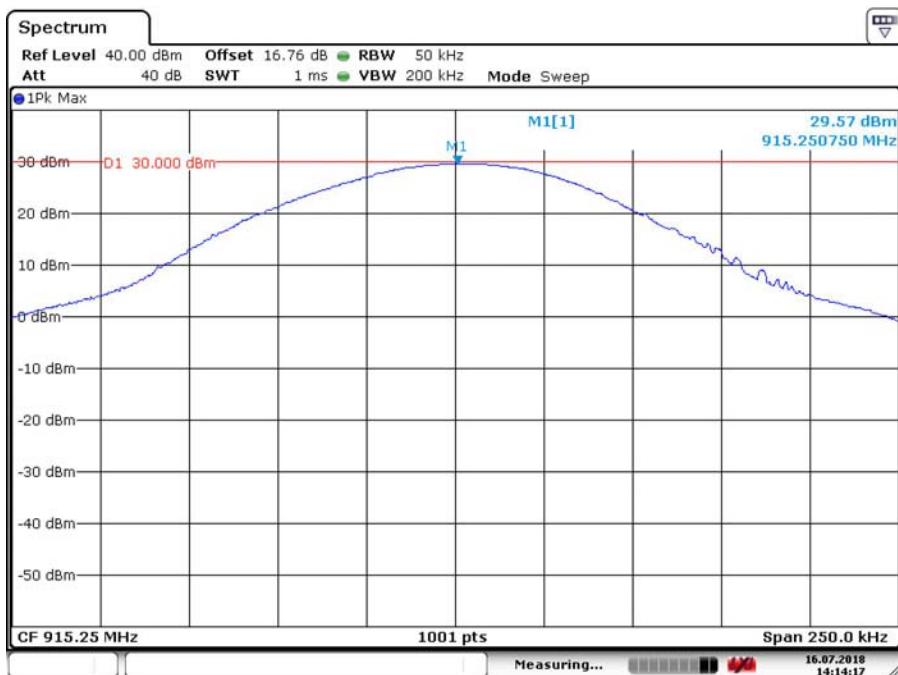

Date: 16.JUL.2018 14:14:18

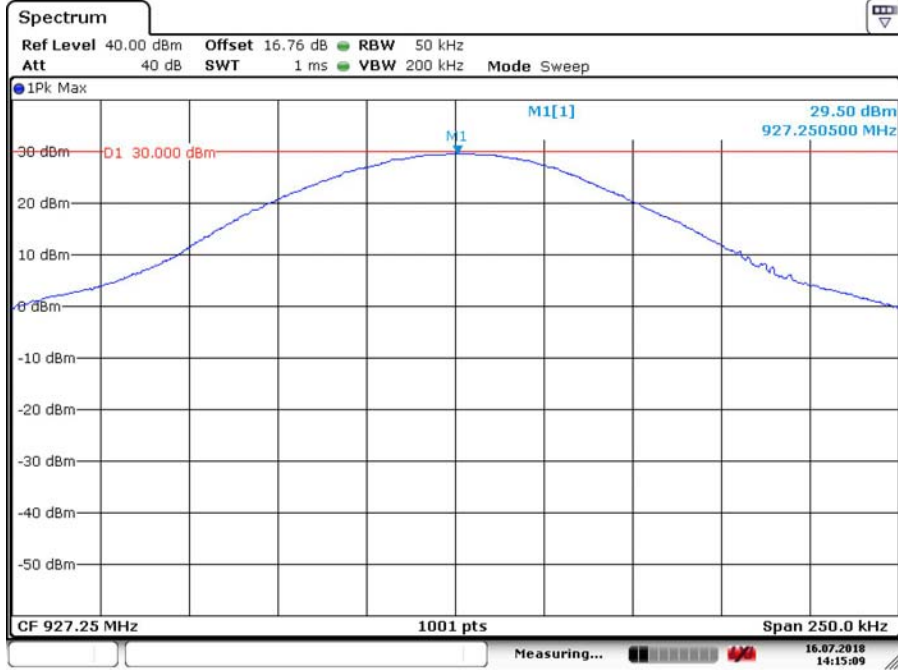
High Channel

Date: 16. JUL. 2018 14:15:09

5.1.3 20dB Bandwidth

RESULT:
Passed

Test standard : FCC Part 15.247(a)(1),
 RSS-247 5.1(1)
 LP0002(2011): 3.10.1, (6.1.1)
 Basic standard : ANSI C63.10:2013
 LP0002(2011) Appendix II
 Kind of test site : Shielded room

Test setup

Test Channel : Low/ Middle/ High
 Operation Mode : A
 Ambient temperature : 22-26°C
 Relative humidity : 50-65%
 Atmospheric pressure : 100-103kPa

Table 7: Test result of 20dB Bandwidth,

| Channel | Channel Frequency (MHz) | 20dB Bandwidth (kHz) | Limit (kHz) | Result |
|--------------|-------------------------|----------------------|-------------|--------|
| Low Channel | 902.75 MHz | 44.20 | < 500 | Pass |
| Mid Channel | 915.25 MHz | 43.66 | < 500 | Pass |
| High Channel | 927.25 MHz | 44.51 | < 500 | Pass |

Test Plot of 20dB Bandwidth

Low Channel

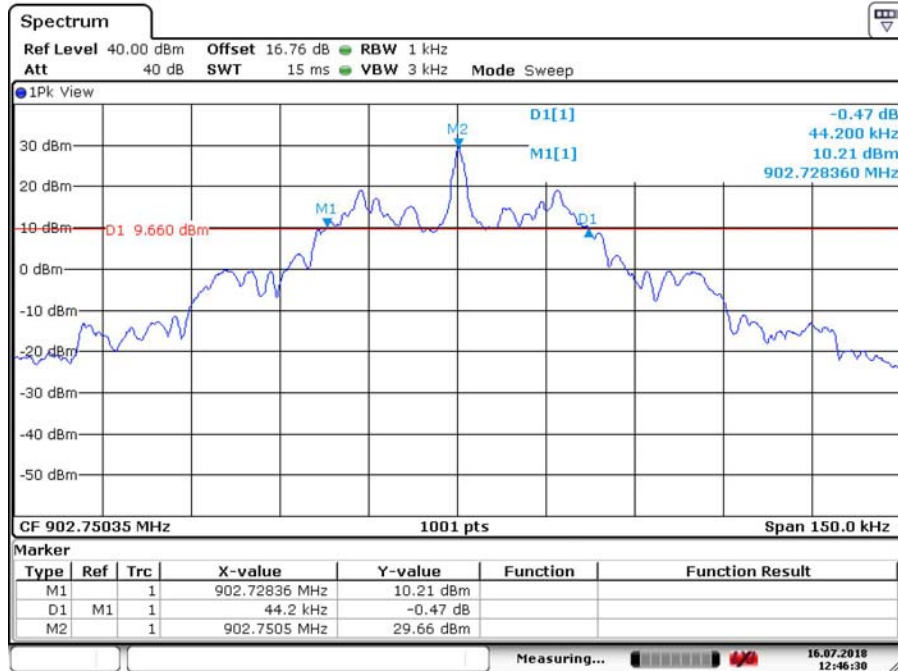

Date: 16. JUL 2018 12:46:30

Middle Channel

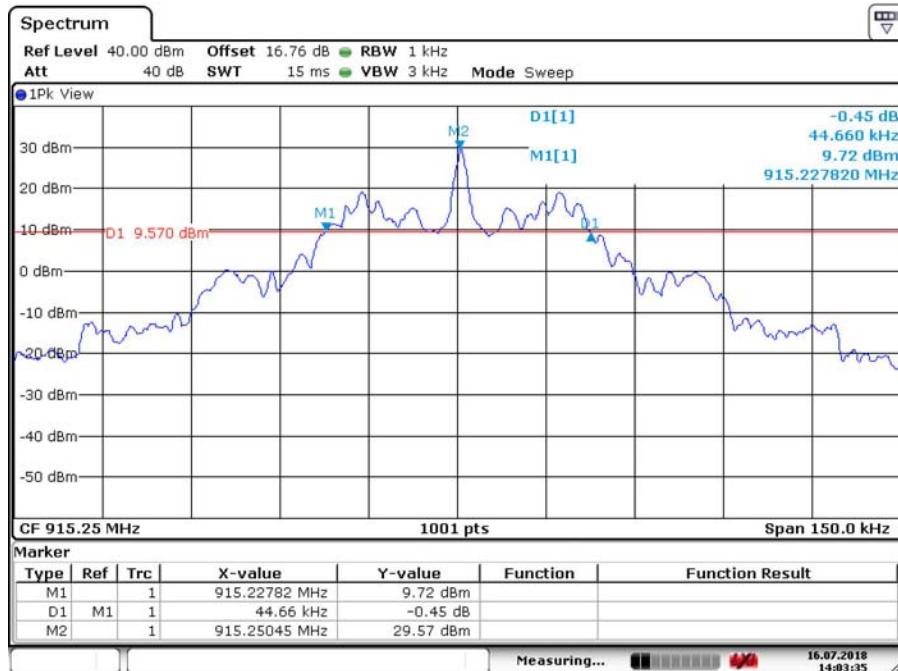

Date: 16. JUL 2018 14:03:35

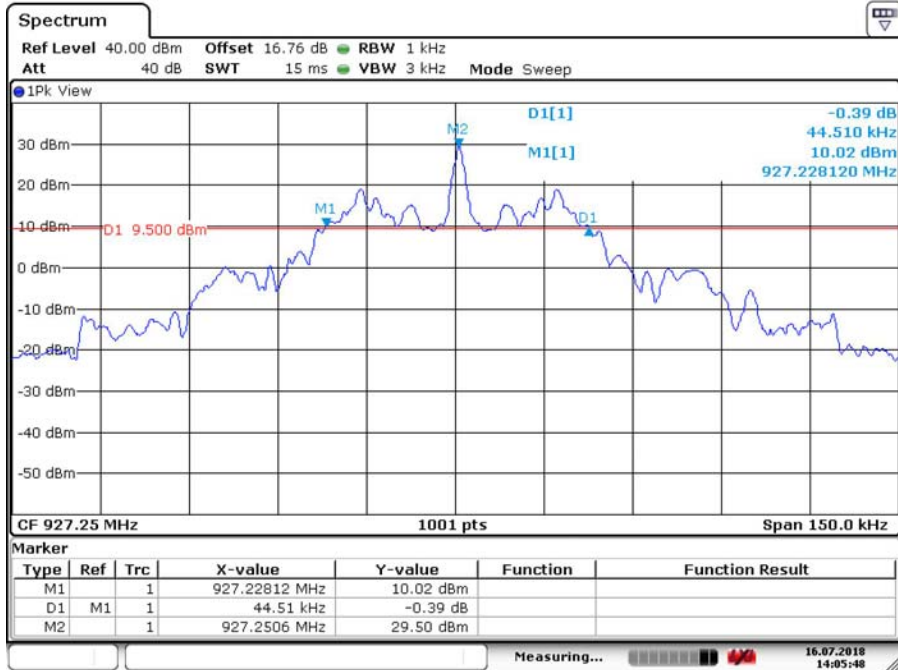
High Channel

Date: 16.JUL.2018 14:05:48

5.1.4 99% Bandwidth**RESULT:****Passed**

Test standard : RSS-Gen, Issue 4, November 2014
Basic standard : ANSI C63.10:2013
Kind of test site : Shielded room

Test setup

Test Channel : Low/ Middle/ High
Operation Mode : A

Ambient temperature : 22-26°C
Relative humidity : 50-65%
Atmospheric pressure : 100-103 kPa

Table 8: Test result of 99% Bandwidth, GFSK modulation

| Channel | Channel Frequency (MHz) | 99% Bandwidth (kHz) |
|-------------|-------------------------|---------------------|
| Mid Channel | 915.25 | 55.44 |

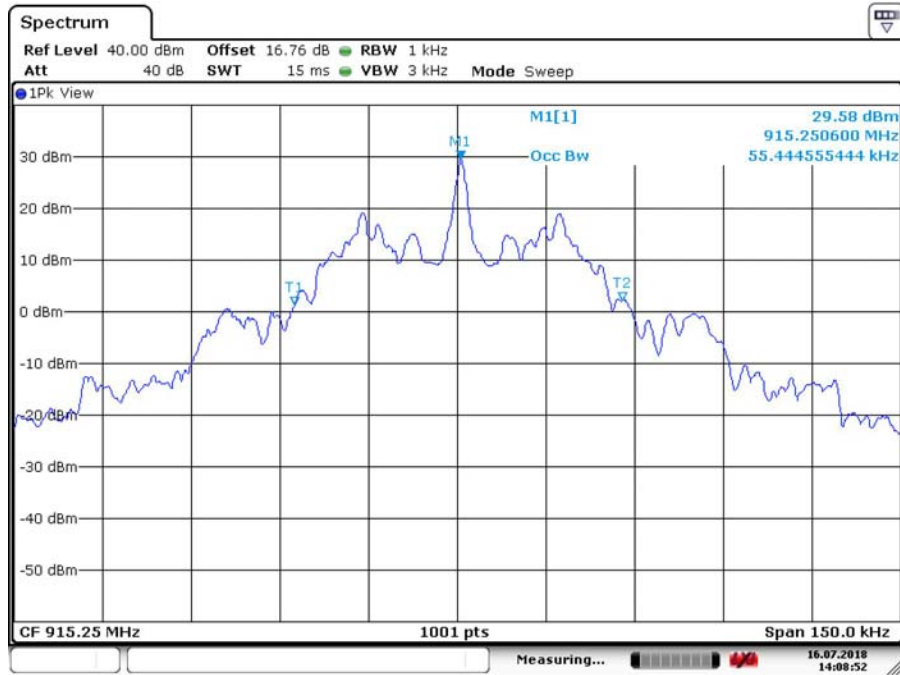
**Test Plot of 99% Bandwidth,
 Middle Channel**

Date: 16. JUL. 2018 14:08:52

5.1.5 Conducted spurious emissions and Frequency Band Edge measured in 100kHz Bandwidth

RESULT: **Passed**

| | | |
|-------------------|---|---|
| Test standard | : | FCC part 15.247(d), RSS-247 5.5 LP0002(2011): 3.10.1, (5) |
| Basic standard | : | ANSI C63.10:2013 LP0002(2011) Appendix II |
| Limit | : | 20dB (below that in the 100kHz bandwidth within the band that contains the highest level of the desired power) |
| Kind of test site | : | Shielded room |

Test setup

| | | |
|----------------------|---|-------------------|
| Test Channel | : | Low/ Middle/ High |
| Operation Mode | : | A |
| Ambient temperature | : | 22-26°C |
| Relative humidity | : | 50-65% |
| Atmospheric pressure | : | 100-103 kPa |

All emissions are more than 20dB below fundamental, details refer to following test plot, and compliance is achieved as well.

Due to the small size of the product and that there are no inductive components of significant size, 9kHz to 30MHz frequency range is not tested based on technical judgment.

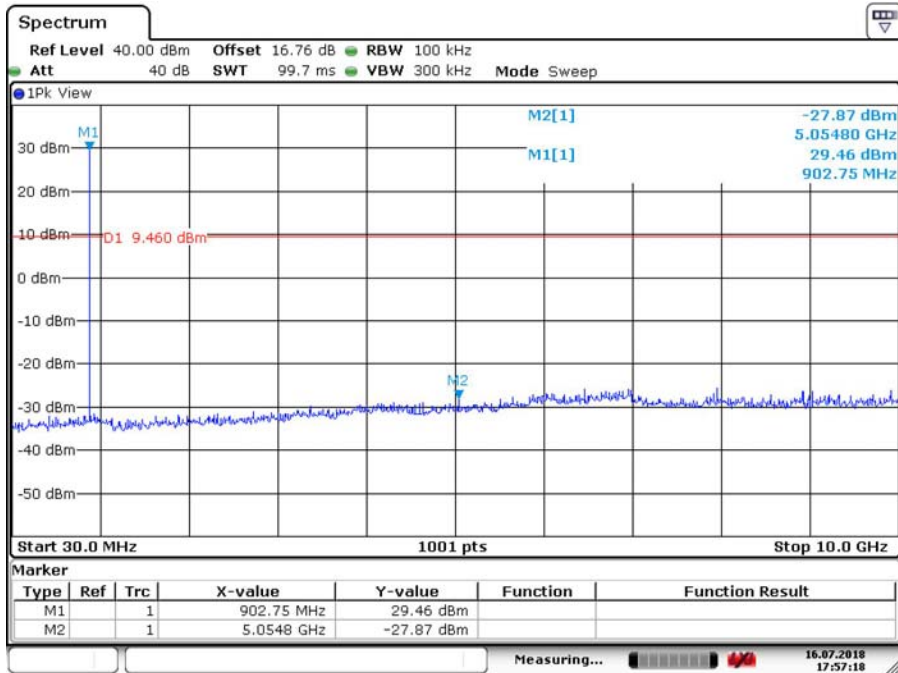
**Test Plot of 100kHz Conducted Emissions,
 Low Channel**

Date: 16. JUL. 2018 17:57:18

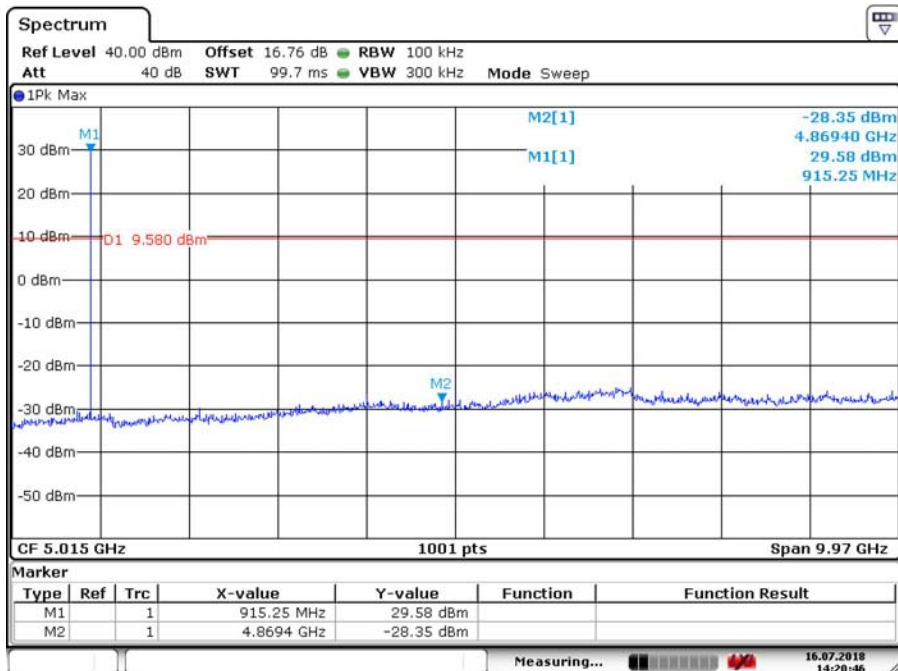
Middle Channel

Date: 16. JUL. 2018 14:20:46

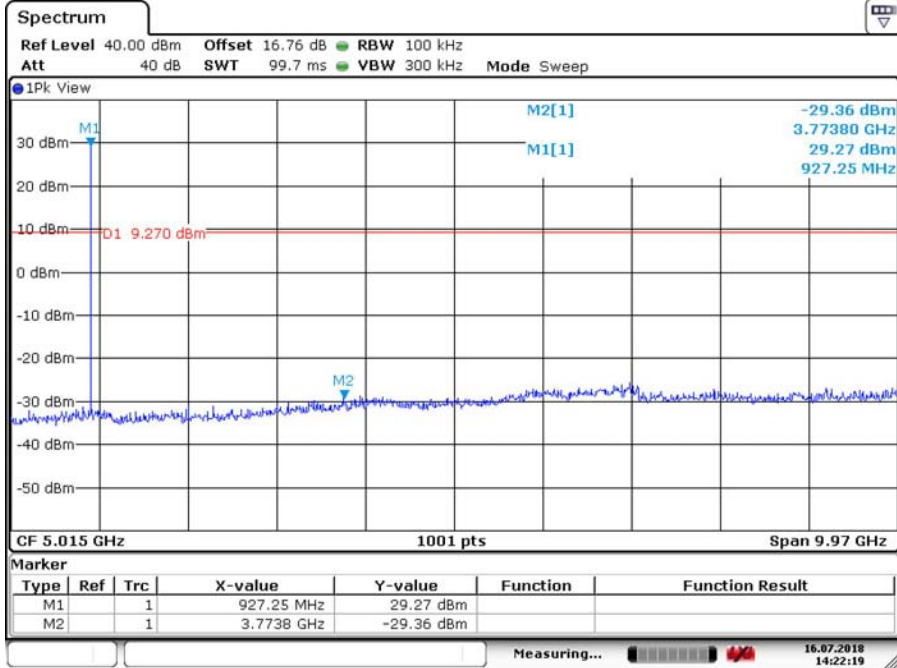
High Channel

Date: 16.JUL.2018 14:22:19

Test Plot of 100kHz Bandwidth of Frequency Band Edge

Low Channel

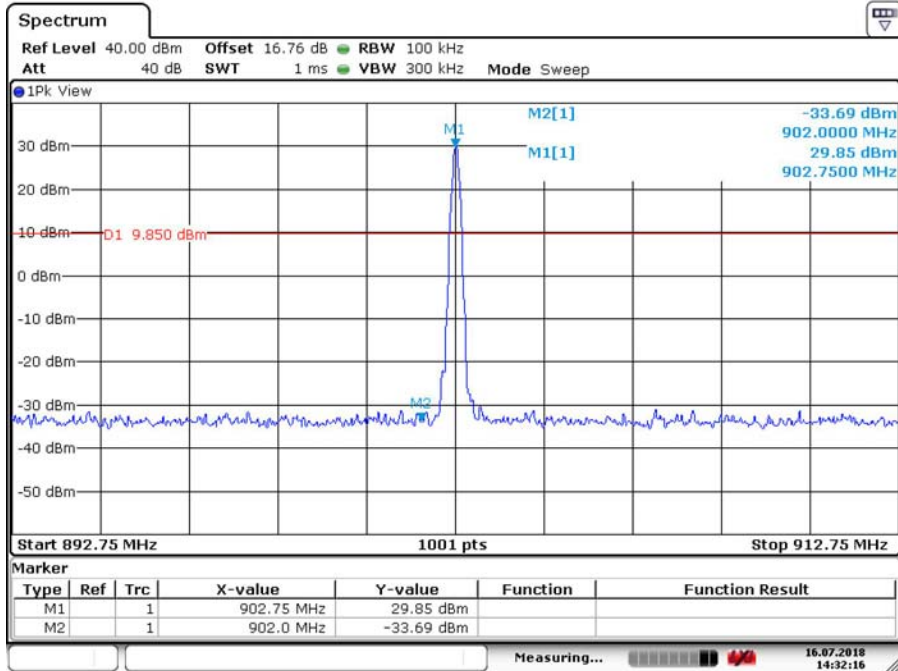

Date: 16. JUL. 2018 14:32:17

High Channel

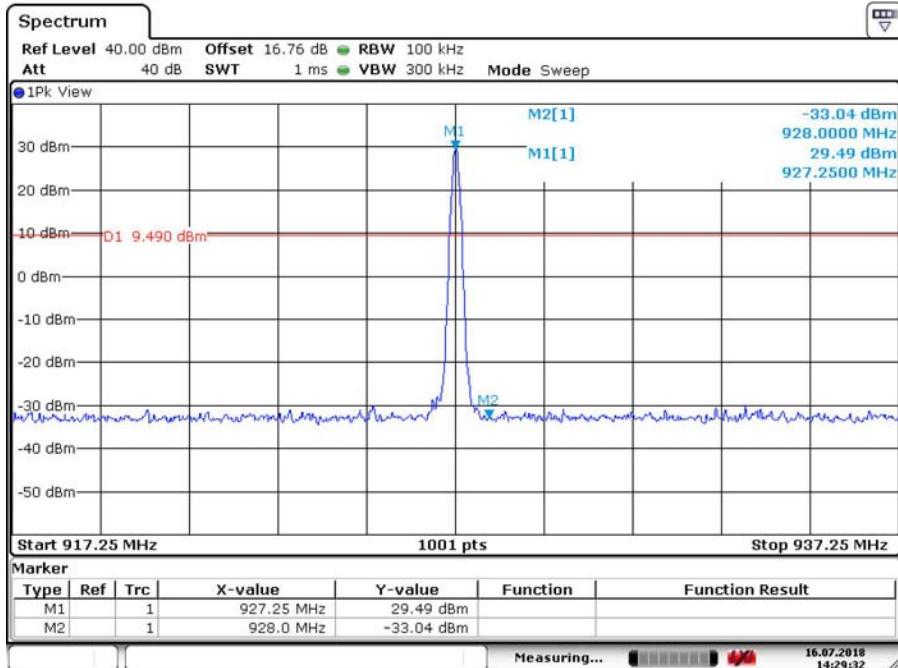

Date: 16. JUL. 2018 14:29:32

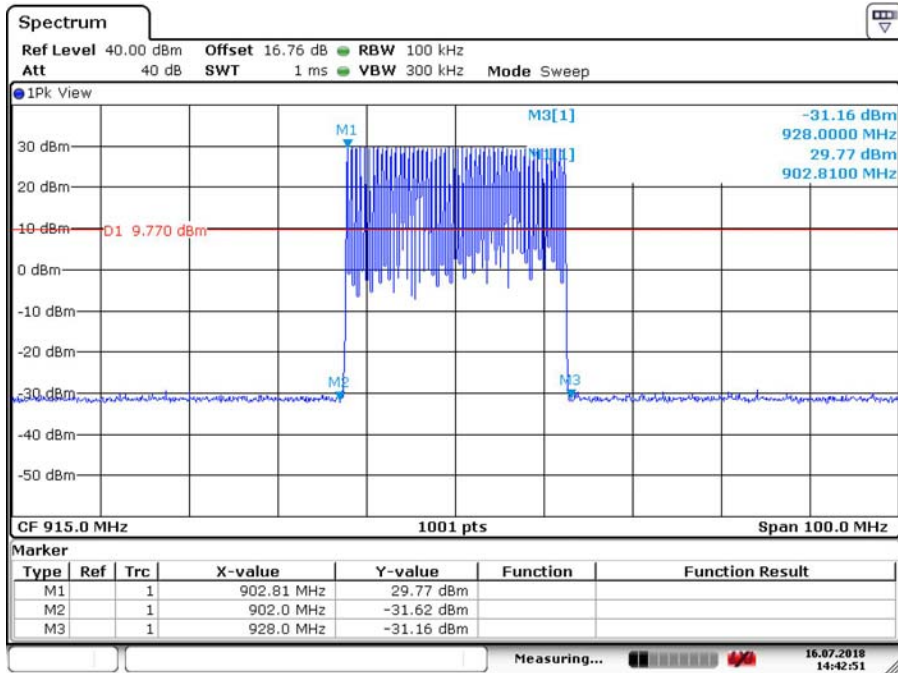
Hopping On

Date: 16.JUL.2018 14:42:51

5.1.6 Spurious Emission

RESULT:**Passed**

| | | |
|-------------------|---|--|
| Test standard | : | FCC part 15.247(d), FCC 15.205, FCC 15.209, RSS-247 5.5 and RSS-Gen 8.9 LP0002(2011): 3.10.1, (5) |
| Basic standard | : | ANSI C63.10: 2013 |
| Limits | : | Radiated emissions which fall in the restricted bands, as defined in FCC 15.205(a) and RSS-Gen i4, 8.9 (Table 6), must comply with the radiated emission limits specified in FCC 15.209(a) and RSS-Gen i4, 8.9 (Table 4 and 5). Emission radiated outside the specified frequency bands must comply with the -20dBc emission limits specified in FCC 15.247 and RSS-247 5.5 |
| Kind of test site | : | 3m Semi-Anechoic Chamber |

Test setup

| | | |
|----------------|---|-------------------|
| Test Channel | : | Low/ Middle/ High |
| Operation Mode | : | A |

Remark: Testing was carried out within frequency range 30MHz to the tenth harmonic. For details refer to Appendix D. The Radiated Emissions testing was performed in the X, Y and Z axis orientation. The worst-case Axis orientation is recorded in this test report.

5.1.7 Frequency Separation

RESULT: **Passed**

Test standard : FCC part 15.247(a)(1)
 RSS-210 A8.1(b)
 LP0002(2011): 3.10.1, (6.1.1)

Basic standard : ANSI C63.10:2013
 LP0002(2011) Appendix II

Limit : $\geq 25\text{kHz}$ or $2/3$ of 20dB bandwidth, whichever is greater

Test setup

Test Channel : Low/ Middle/ High
 Operation Mode : A
 Ambient temperature : 24°C
 Relative humidity : 53%

Table 9: Test result of Frequency Separation

| Channel | Channel Frequency (MHz) | Measured Channel Separation (MHz) | Limit (kHz) | Result |
|----------------------|-------------------------|-----------------------------------|-----------------------|--------|
| Record Channel | 914.75 | 0.5 | $\geq 115\text{ kHz}$ | Pass |
| Record Channel adj 1 | 915.25 | | | |
| Record Channel adj 2 | 915.75 | | | |

Test Plot of Frequency Separation

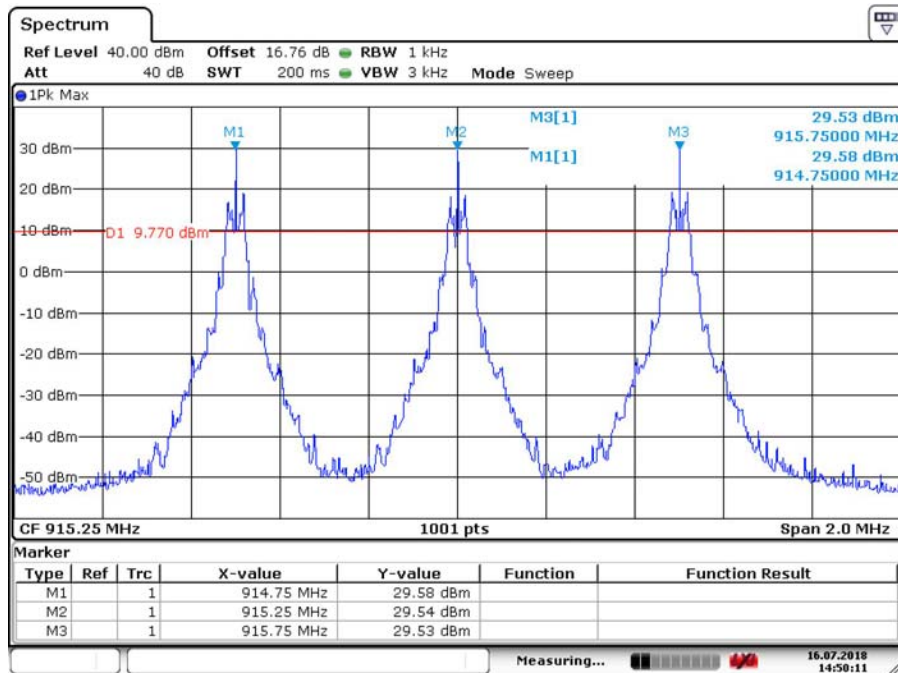

Date: 16.JUL.2018 14:50:11

5.1.8 Number of Hopping Channels

RESULT: **Passed**

Test standard : FCC part 15.247(a)(1)(iii)
 RSS-247 5.1(5)
 LP0002(2011): 3.10.1, (6.1.2)

Basic standard : ANSI C63.10:2013
 LP0002(2011) Appendix II

Test setup

Test Channel : Hopping On
 Operation Mode : A

Ambient temperature : 22-26°C
 Relative humidity : 50-65%
 Atmospheric pressure : 100-103 kPa

Table 10: Test result of Number of hopping frequency

| Frequency Range | Measured Number of Hopping Channel | Limit | Result |
|-----------------|------------------------------------|-------|--------|
| 902 to 928 MHz | 50 | ≥50 | Pass |

Test Plot of Number of hopping frequencies

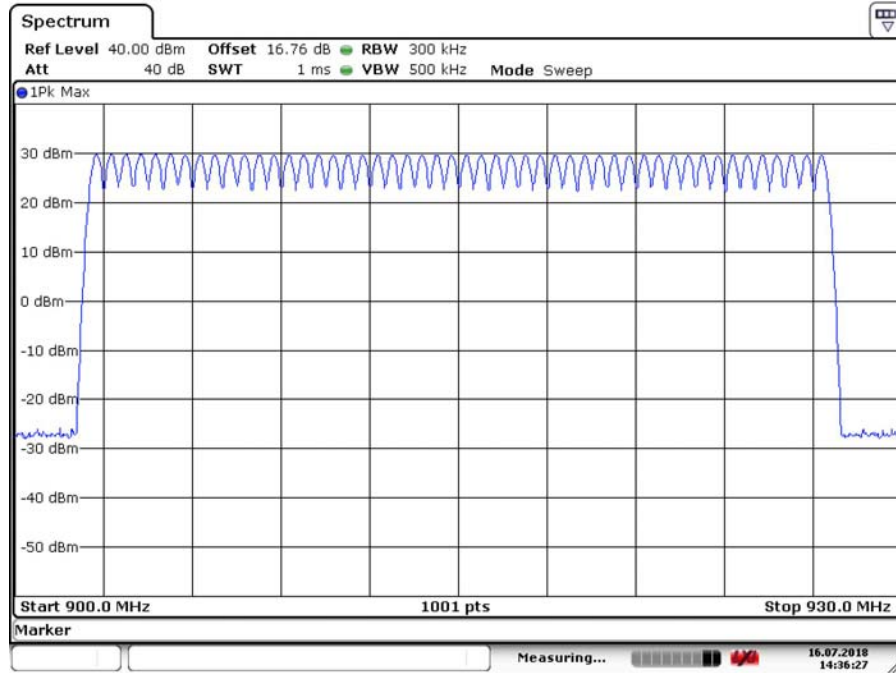

Date: 16.JUL.2018 14:36:27

5.1.9 Time of Occupancy

RESULT:**Passed**

| | | |
|-------------------|---|---|
| Test standard | : | FCC part 15.247(a)(1)(iii) RSS-247 5.1(5) LP0002(2011): 3.10.1, (6.1.2) |
| Basic standard | : | ANSI C63.10:2013 LP0002(2011) Appendix II |
| Limits | : | 0.4s |
| Kind of test site | : | Shield room |

Test setup

| | | |
|----------------------|---|-------------------|
| Test Channel | : | Low/ Middle/ High |
| Operation Mode | : | A |
| Ambient temperature | : | 22-26°C |
| Relative humidity | : | 50-65% |
| Atmospheric pressure | : | 100-103 kPa |

Table 11: Test result of Time of Occupancy

Frequency hopping systems operating in the 902–928 MHz band:
if the 20 dB bandwidth of the hopping channel is less than 250 kHz,
- then the system shall use at least 50 hopping frequencies and
- the average time of occupancy on any frequency shall not be greater than 0.4 seconds within a 20 second period.

Number of hopping channels: 50

 $109.38\text{ms} + 96.6\text{ms} = 206\text{ms} < 400\text{ms}$

Test Plot of Time of Occupancy

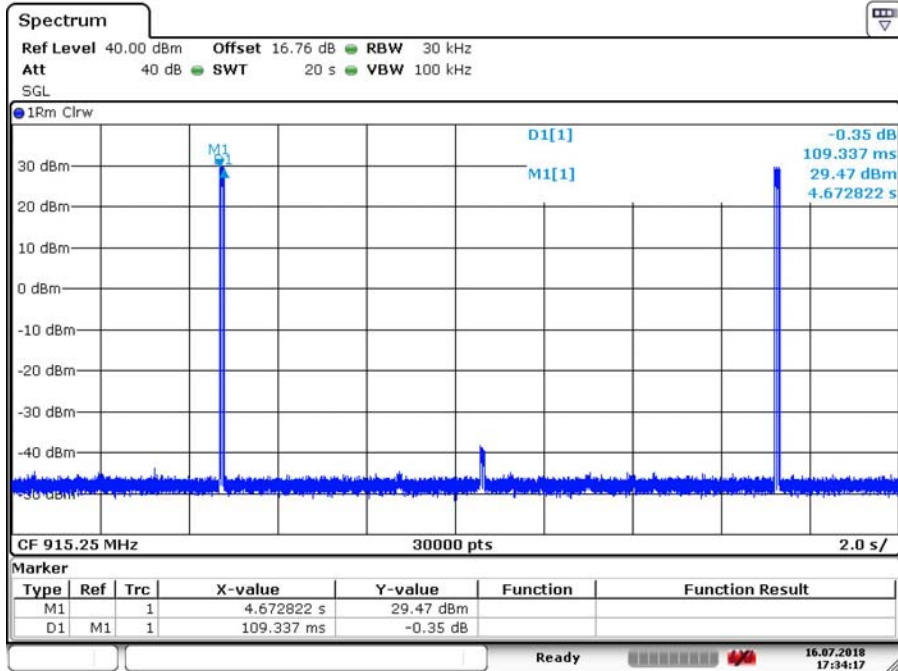

Date: 16. JUL.2018 17:34:17

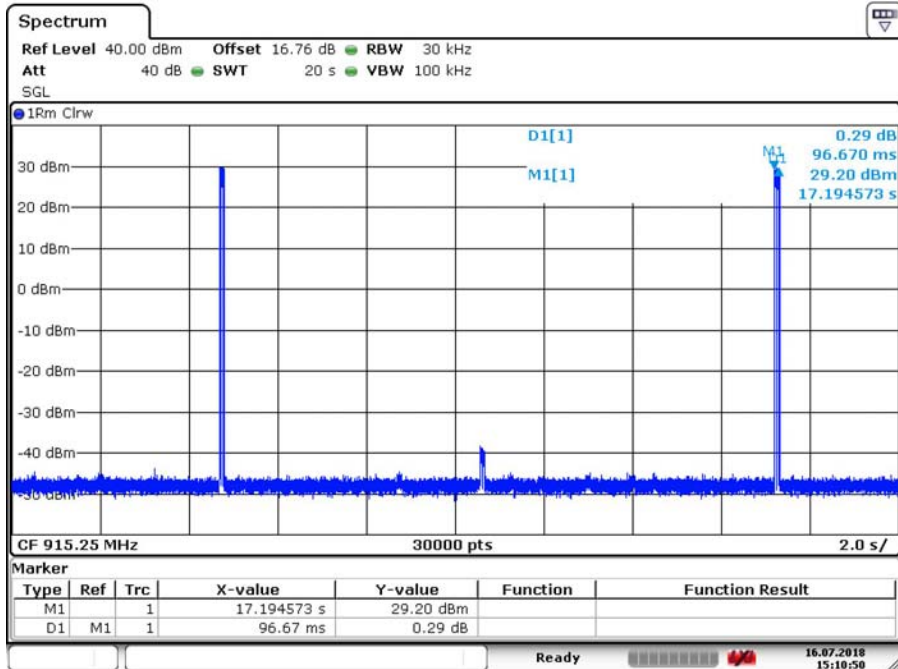

Date: 16. JUL.2018 15:10:50

5.2 Mains Emissions

5.2.1 Mains Conducted Emissions

RESULT:**Passed**

Test standard : FCC Part 15.207
FCC Part 15.107
RSS-Gen 7.2.4
LP0002: 8.8

Limits : Mains Conducted emissions as defined in
above test standards must comply with the
mains conducted emission limits specified

Kind of test site : Shielded Room

Test setup

Test Channel : Middle
Operation mode : A

Remark: For details refer to Appendix D.

6. Safety Human exposure

6.1 Radio Frequency Exposure Compliance

6.1.1 Electromagnetic Fields

RESULT:
Passed

Test standard : FCC KDB Publication 447498 D01 v05
 RSS-102 issue 5, Table 4

The EUT will maintain a 20 cm distance to all persons.

Maximum Exposure FCC:

| | |
|------------------------|--------------------------|
| Power to Antenna (mW) | 982 mW |
| Power to Antenna (dBm) | 29.9 dBm |
| Antenna Gain | 4.1 dBi |
| Power+Ant Gain | 2524.1 mW |
| Distance | 20 cm |
| S= | 0.502 mW/cm ² |

Limit FCC: 0.61 mW/cm²

FCC:

0.3-1.34 MHz (100) mW/cm²
 1.34-30 MHz (180/f²) mW/cm²
 30-300 MHz 0.2 mW/cm²
 300-1500 MHz f/1500 mW/cm²
 1500-100,000 MHz 1.0 mW/cm²

Maximum Exposure Canada:

| | |
|------------------------|--------------------------|
| Power to Antenna (mW) | 982 mW |
| Power to Antenna (dBm) | 29.9 dBm |
| Antenna Gain | 4.1 dBi |
| Power+Ant Gain | 2524.1 mW |
| Distance | 29 cm |
| S= | 0.239 mW/cm ² |

Limit Canada: 0.274 mW/cm²

Canada:

| | |
|---------------|--|
| 10-20 MHz | 0.2 mW/cm ² |
| 20-48 MHz | (0.8944/f ^{0.5}) mW/cm ² |
| 48-300 MHz | 0.129 mW/cm ² |
| 300-6000 MHz | (0.002619*f ^{0.6834}) mW/cm ² |
| 6000-15000MHz | 1.0 mW/cm ² |

7. Photographs of the Test Set-Up

Photograph 1: Set-up for Radiated Emissions (Front View)

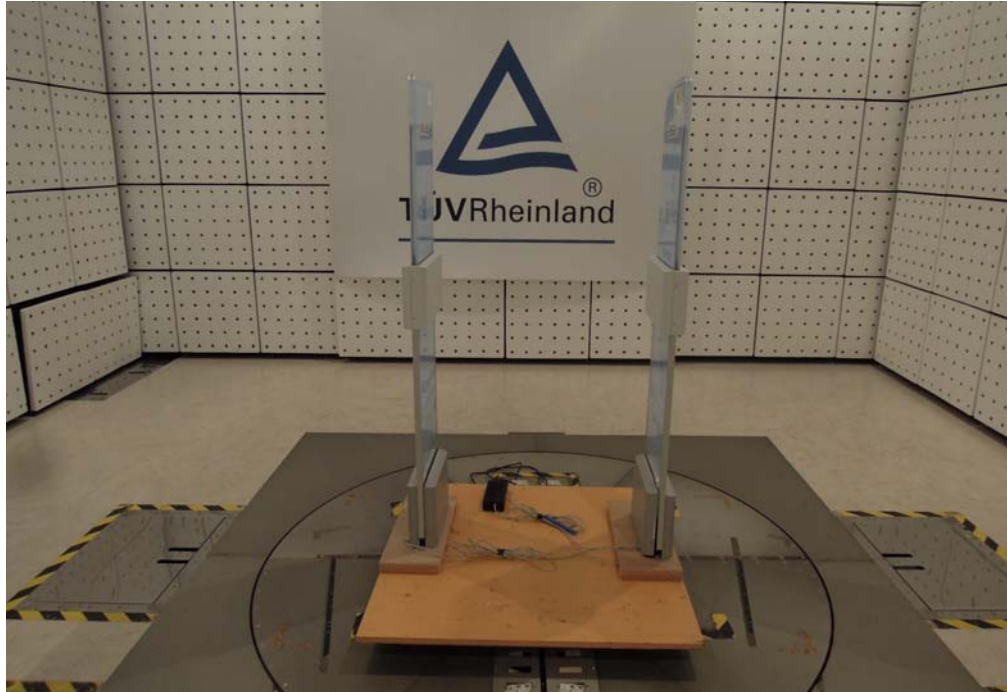

Photograph 2: Set-up for Radiated Emissions (Back View 1)

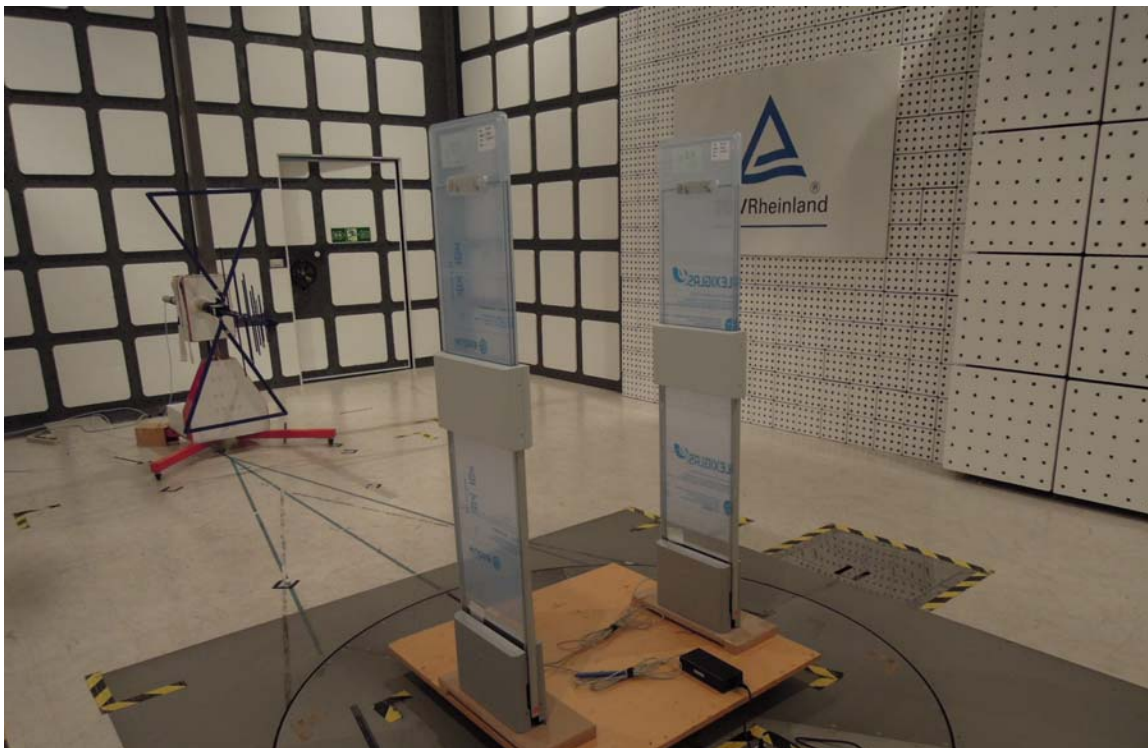
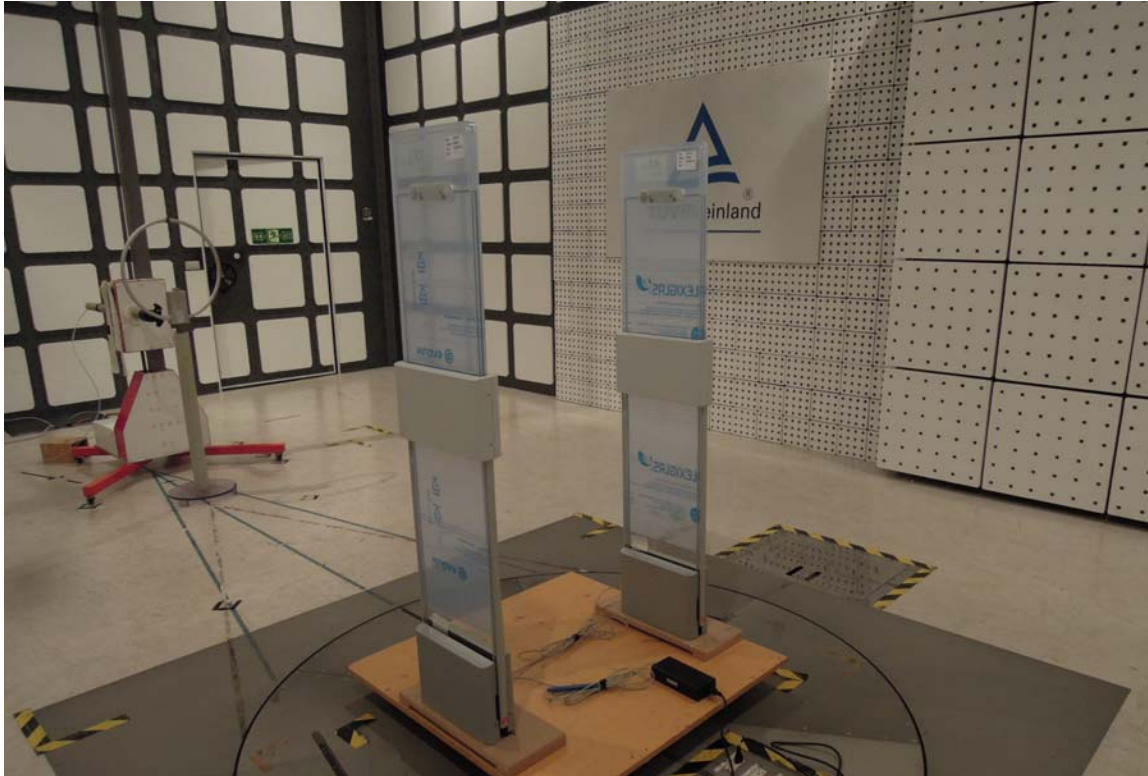

Photograph 3: Set-up for Radiated Emissions (Back View 2)

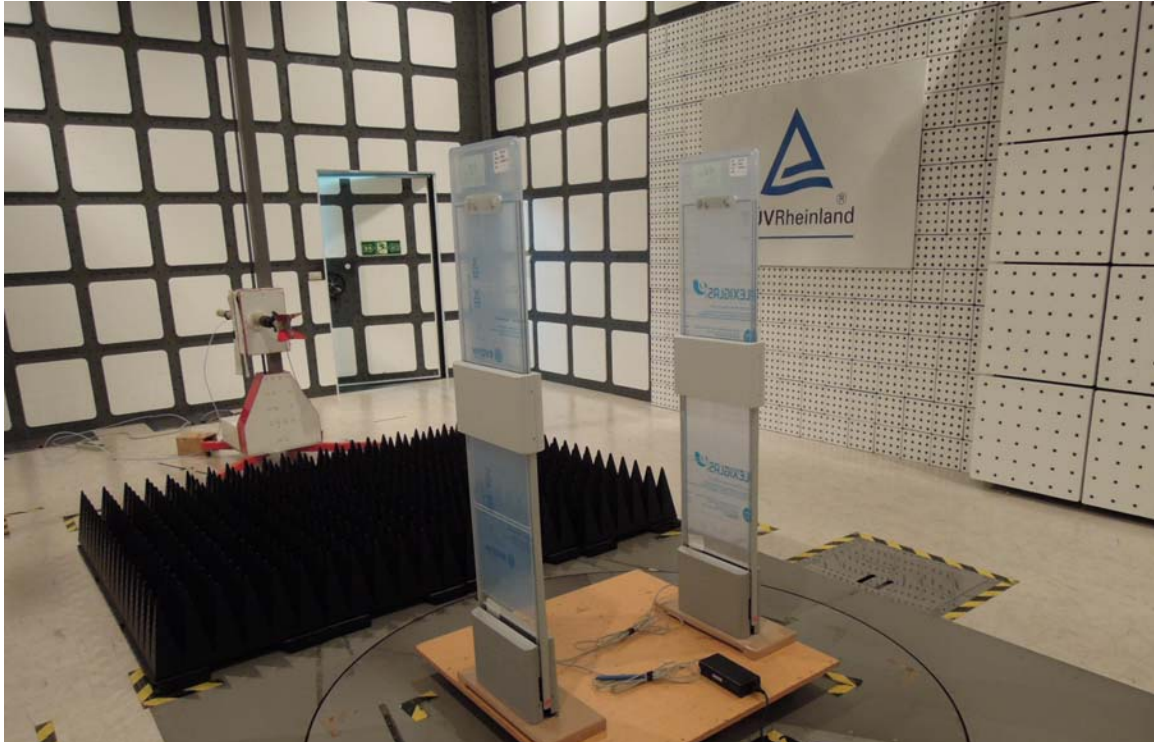

Photograph 4: Set-up for for Mains Conducted testing Back



Photograph 5: Set-up for for Mains Conducted testing Front



8. List of Tables

| | |
|---|----|
| Table 1: Applied Standard and Test Levels | 5 |
| Table 2: List of Test and Measurement Equipment..... | 7 |
| Table 3: Emission Measurement Uncertainty..... | 8 |
| Table 4: Basic Information of EUT | 10 |
| Table 5: Technical Specification of EUT | 10 |
| Table 6: Test result of Peak Output | 16 |
| Table 7: Test result of 20dB Bandwidth, | 19 |
| Table 8: Test result of 99% Bandwidth, GFSK modulation..... | 22 |
| Table 9: Test result of Frequency Separation | 30 |
| Table 10: Test result of Number of hopping frequency | 32 |
| Table 11: Test result of Time of Occupancy..... | 34 |

9. List of Photographs

| | |
|--|----|
| Photograph 1: Set-up for Radiated Emissions (Front View) | 39 |
| Photograph 2: Set-up for Radiated Emissions (Back View 1) | 40 |
| Photograph 3: Set-up for Radiated Emissions (Back View 2) | 41 |
| Photograph 4: Set-up for for Mains Conducted testing Back..... | 42 |
| Photograph 5: Set-up for for Mains Conducted testing Front | 42 |