



SETUP PHOTOS EXHIBIT

Report Number : R13916296-EP2

Applicant : Ademco Inc.
251 Little Falls Dr.
Wilmington, DE 19808, U.S.A

Model : ADTZWMX

FCC ID : CFS8DLWFZWX

IC : 573F-WFZWX

EUT Description : Radio Module

Test Standard(s) : FCC 47 CFR PART 15 SUBPART C: 2021
ISED RSS-247 ISSUE 2: 2017
ISED RSS-GEN ISSUE 5 + A2: 2021

Date Of Issue:

2021-10-15

Prepared by:

UL LLC

12 Laboratory Dr.

Research Triangle Park, NC 27709 U.S.A.

TEL: (919) 549-1400



REPORT REVISION HISTORY

Rev.	Issue Date	Revisions	Revised By
V1	2021-08-31	Initial Issue	Niklas Haydon
V2	2021-10-15	Updated with conducted setup	Niklas Haydon

TABLE OF CONTENTS

REPORT REVISION HISTORY	2
TABLE OF CONTENTS.....	3
1. SETUP DIAGRAM.....	4
2. SETUP PHOTOS.....	5
END OF PHOTOS EXHIBIT.....	12

1. SETUP DIAGRAM

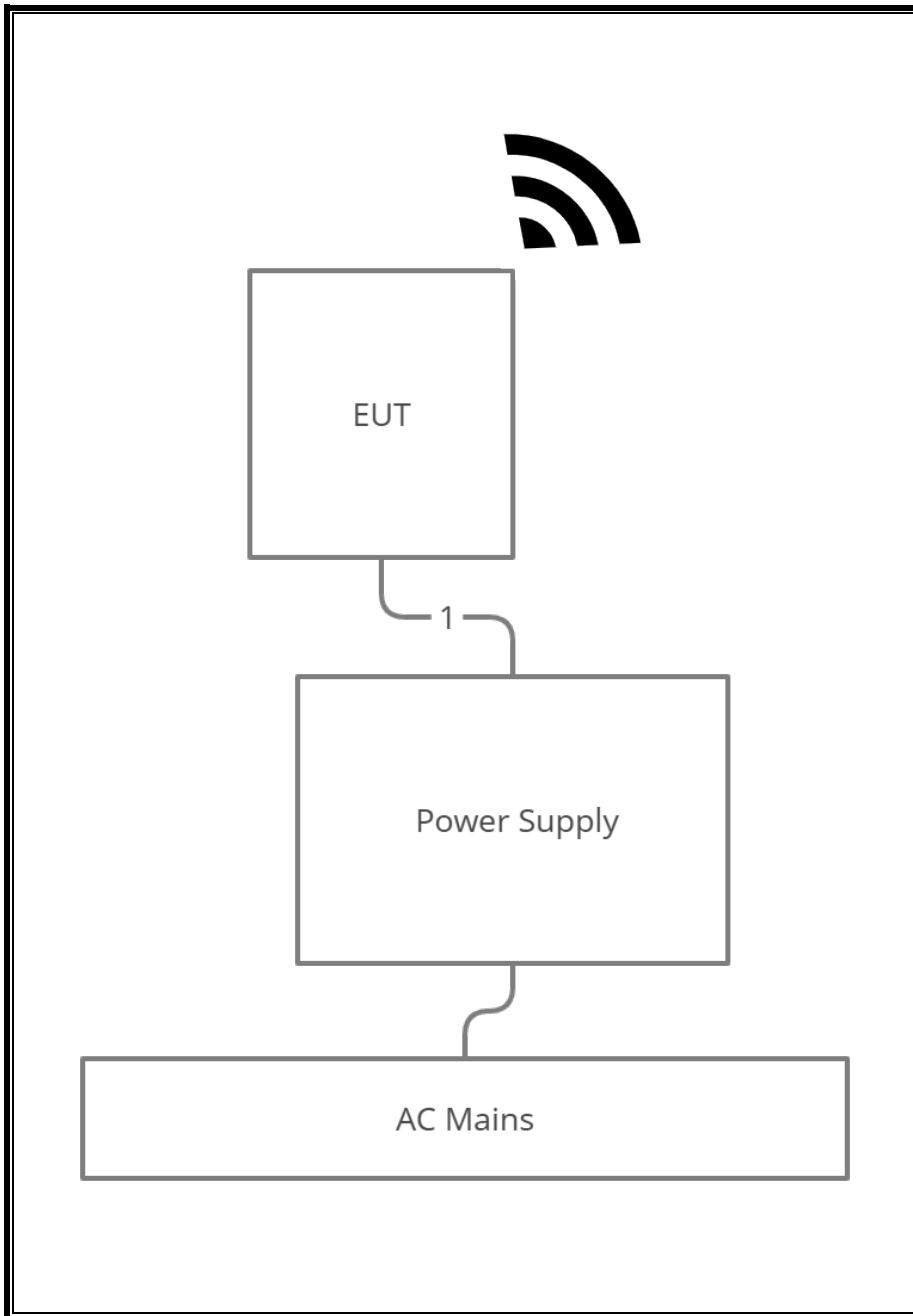

2. SETUP PHOTOS

CONDUCTED RF MEASUREMENT SETUP

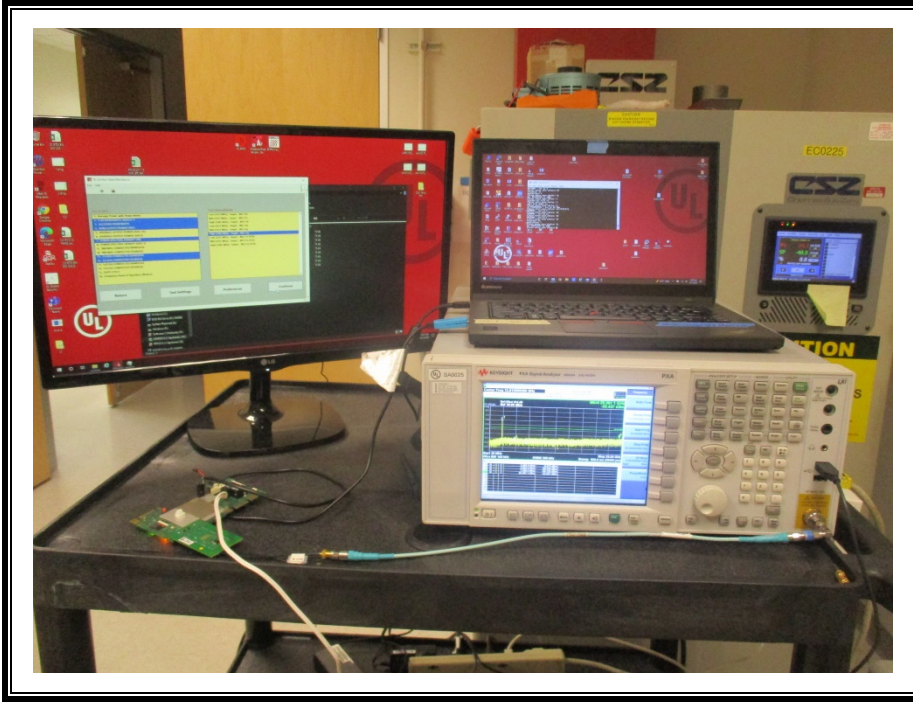

RADIATED RF MEASUREMENT SETUP

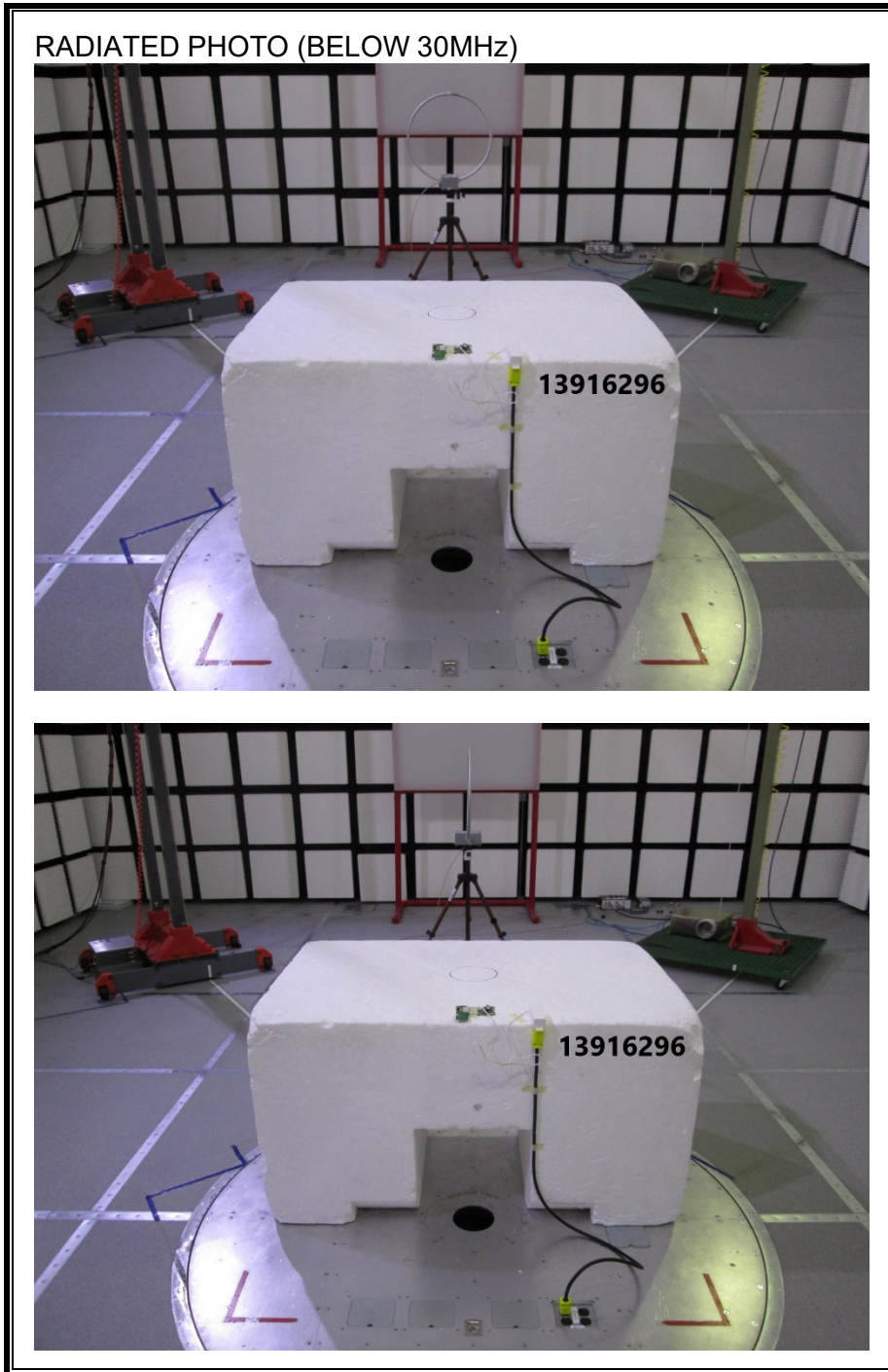

RADIATED PHOTO (BELOW 30MHz)

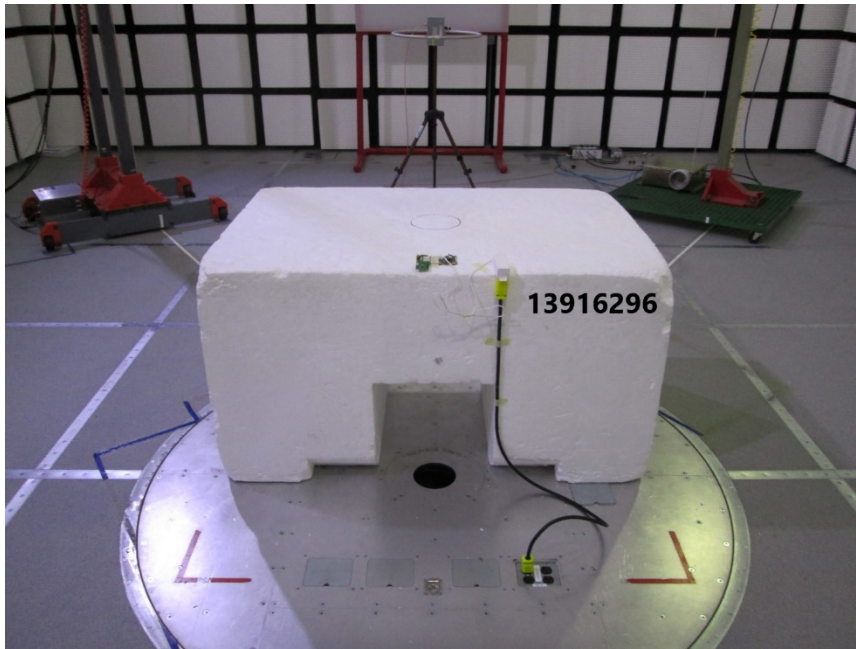

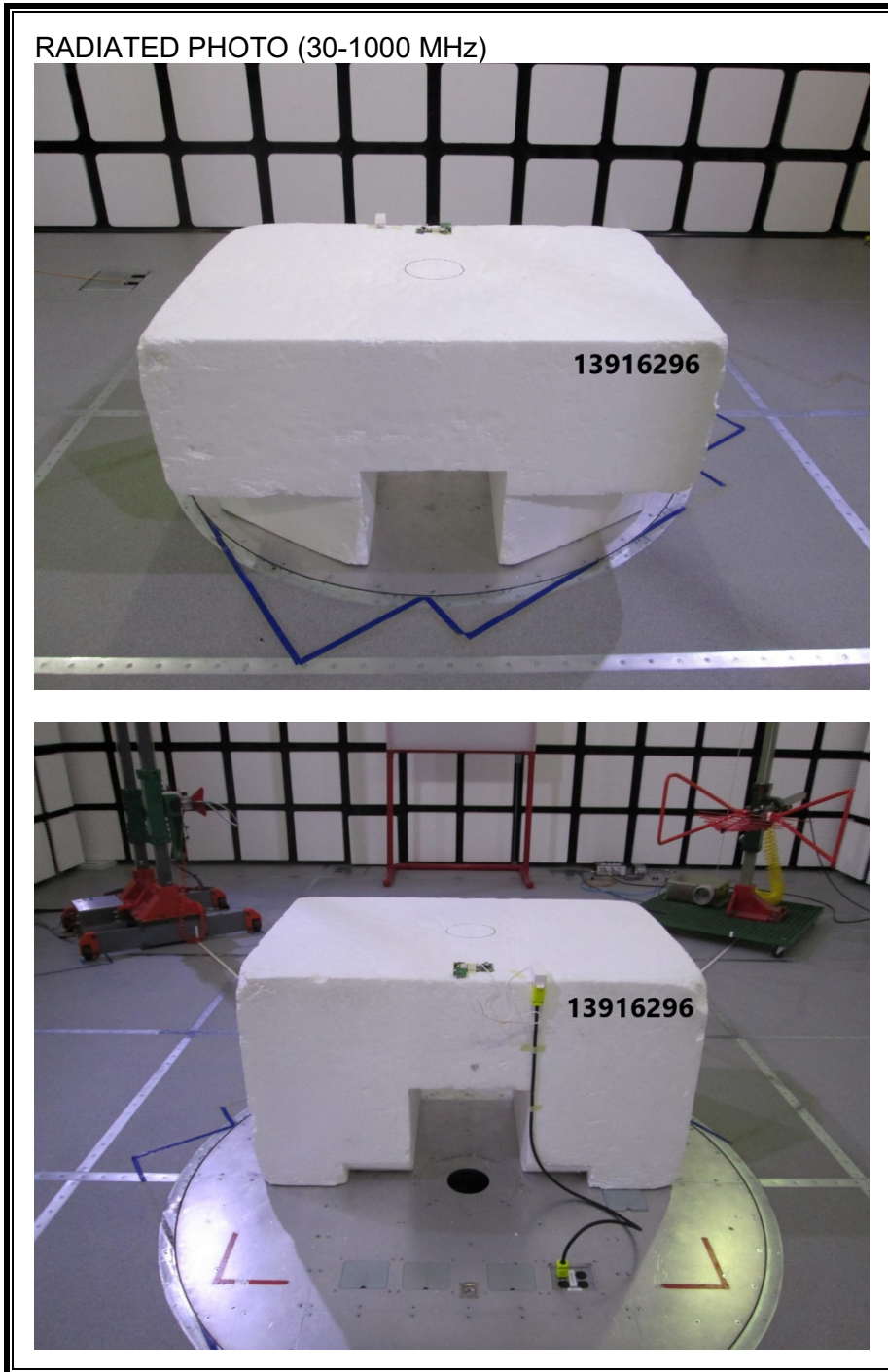

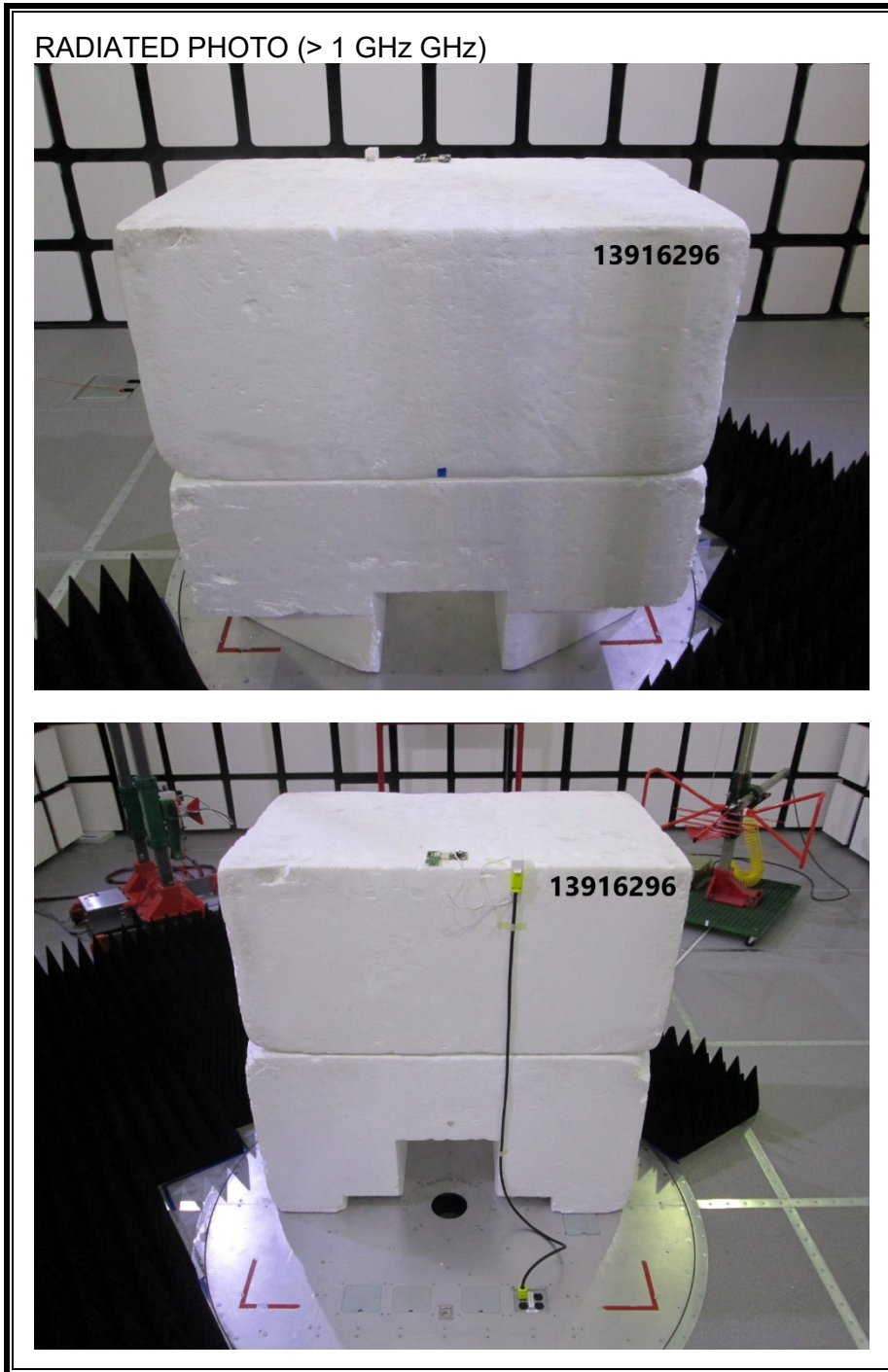

XYZ EXPLORATION (X-ORIENTATION)

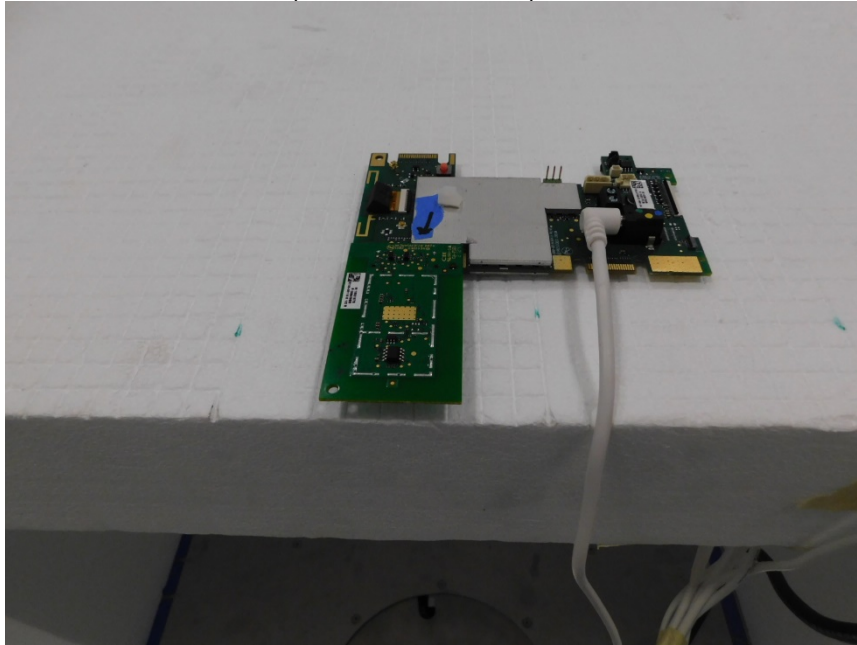

XYZ EXPLORATION (Y-ORIENTATION)

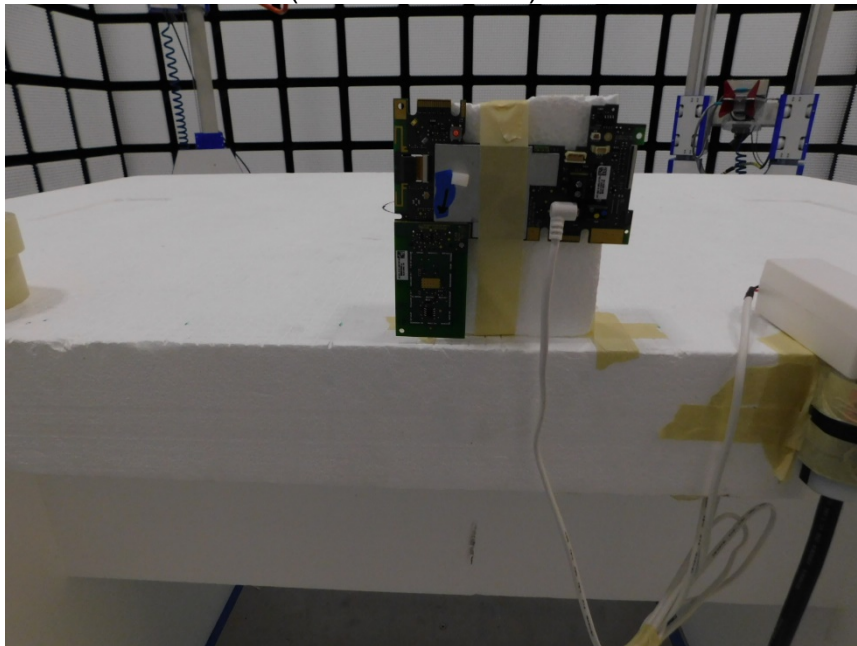

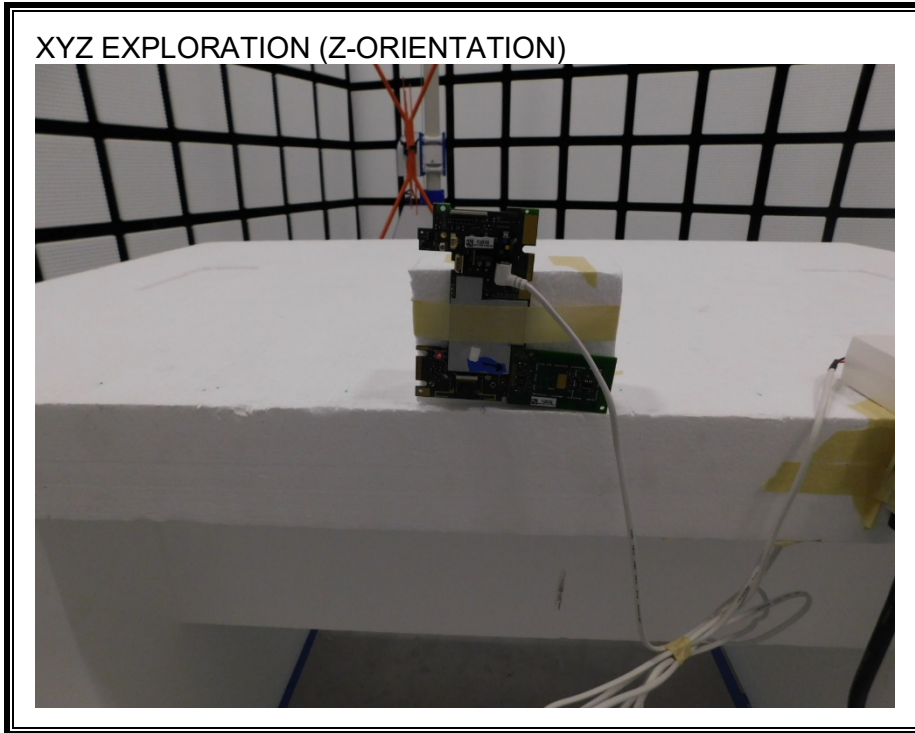

AC LINE CONDUCTED MEASUREMENT SETUP

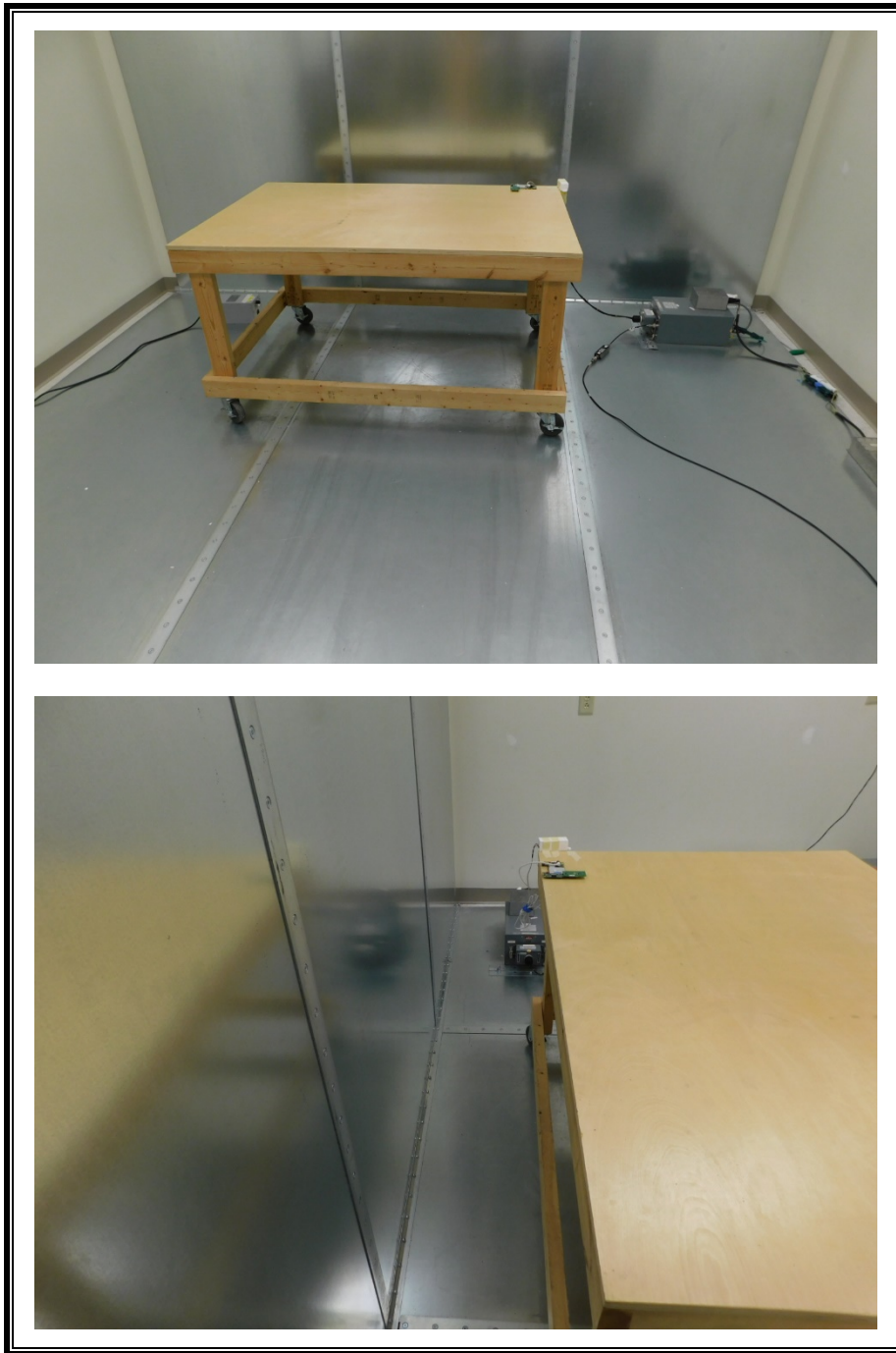

END OF PHOTOS EXHIBIT